

GÜHRING

GÜHRING

Edition 01
General Catalogue

2023

No liability can be accepted for printing errors or technical changes of any kind.
Our Conditions of Sale and Terms of Payment apply. Available on request.



> 180,000
Customers worldwide



8,000
Employees worldwide

900
Sales representatives worldwide



110,000
Articles in the standard range



Quality
Made in Germany



1.1 bn
Turnover



2,400
Tonnes of carbide/year



48
Subsidiaries

Gühring is more than just a tools supplier.

As a partner for tools and an expert in process optimisation, we support you in all matters – after all, as a manufacturer with a service guarantee, we are by your side every step of the way. Whether you are dealing with one of our hundreds of local sales representatives or a personal contact on any of our digital channels: We are always here to help.

GÜHRING

Perfection in machining



Your success is our mission.

Together, we get the most out of your manufacturing process.

FOR DECISION MAKERS

We work with you to reach your goal.

Increased output with tailor-made tools

GÜHRING Application technician | Sales representative | Product manager | Retooling department

If retailers are unable to provide you with a standard product, we produce bespoke solutions and can combine working steps for you or optimise your processes.

With tailor-made tools or specially designed solutions, we develop the ideal process for you – for increased output and a more efficient work process.

Save 20% on tool costs with tool management

GÜHRING Tool dispensing systems | Gühring Tool Management Software | Tool Manager

As a logistics partner, we take over your entire tool management process:

As a result, you not only outsource your C-parts, but also prevent any cases of over- or under-supply. Optimum planning, scheduling and ordering saves you time and money. Reduce your tooling costs from day one!

Tool refurbishment saves money

GÜHRING Regrinding | Recoating

As manufacturer, we take care of your tools, even when they have worn out.

This allows us to restore our products to their original level of performance through professional regrinding and recoating. We collect the tools directly from you.

Solving complex machining problems

GÜHRING Process specialists

Optimise your machining process through continuous analysis of process data: With our process data analysis, you can shed light on sources of wear and faults and prevent them.

GÜHRING



For more information about our services and availability in your country, please contact us.

FOR MAKERS

Get to work while others are still in the testing stages.

Tried and tested cutting data from the manufacturer

GÜHRING [Gühring Catalogue](#) | [webshop.guehring.com](#) | [webnavigator.guehring.com](#)

The machine is running, the tool is in the magazine, but you aren't sure how to use it? The cutting data for all our tools can be found at the end of each chapter in the catalogue, under your respective purchase in the Gühring online shop or in the navigator, where you can filter by specific machining operations and materials.

Find the right tool

GÜHRING [Quickfinder in the Gühring Catalogue](#) | [webnavigator.guehring.de](#)

Can't see the forest for the trees? With the Gühring Quickfinder function, an intuitive product overview, you will find the perfect solution for your specific application. And the whole thing is available in digital form as the Gühring Navigator.

Tool data & CAD drawings available at all times

GÜHRING [webshop.guehring.de](#)

Do you need drawings or want to simulate your machining operation? We provide the data you need for this as a free download: As a registered user of our online shop, you can download available file formats PNG, XML-Meta, DXF, STEP or XML_4000 with one click.

Ask one of our experts

GÜHRING [Sales representative](#) | [WhatsApp +49 172 65 85 353](#) | [personal chat on guehring.com](#)

Standing by your machine and need some speedy support? Talk to us in person or chat with our application engineers. Or send us a WhatsApp. Be it with text, photo or voice message: We also guarantee personal, competent and quick advice on our digital channels. Save our number now: +49 172 65 85 353!

GÜHRING



For more information about our services and availability in your country, please contact us.

FOR PURCHASERS

With us, you get more for your money.

Your own personal net prices, availability and contracts at a glance

GÜHRING webshop.guehring.de

In the Gühring online shop, you can see your net prices, availability and contracts at a glance and can configure your procurement process yourself and define approval workflows. You can also speak to our product experts and application technicians quickly and personally using our chat function. And if you order by 5 p.m., we will ship the goods the same day!

Interfaces to your ERP system:

GÜHRING webshop.guehring.de

No more doing the same work twice: Our convenient interfaces connect the Gühring online shop to your ERP system. This means you can order without recording data twice. And with the Gühring Tool Management Software, tools can be reordered automatically if you so wish.

Automate purchasing processes

GÜHRING Tool Management | Gühring Tool Management Software | Tool dispensing systems

With our manufacturer-independent tool management software, we are your central logistics partner for the procurement of all products in the field of machining and production. Consignment warehouse and deadline monitoring included.

Your complete tool supplier

GÜHRING Gühring Catalogue | webshop.guehring.de

Sometimes more is more: As a manufacturer, we guarantee high stock availability and fast delivery for over 110,000 standard items.

GÜHRING



For more information about our services and availability in your country, please contact us.

Sustainable performance



Solid carbide and tool refurbishment from Gühring

Get more out of your tool

Why should you have your tool reground when it has worn out?

Thanks to professional regrinding and recoating, Gühring restores the original performance level of its products, while refurbishment extends their tool life.

This means that you need to set aside a lot less of your budget for new purchases.

And if your solid carbide tools have reached the end of their life,

we enable you to convert your scrap into money. After all, as a carbide manufacturer,

Gühring is able to recycle the valuable raw materials from the carbide

and pays you for any material you give us.

- Maximise your tools' performance with regrinding
- Save up to 62% of costs per tool thanks to regrinding
- Turn scrap into money with carbide recycling

GÜHRING



For more information about our services and availability in your country, please contact us.

Save 20% on costs



Gühring Tool Management Software & dispensing systems

Leave your tool management to us

Still got room for improvement in your tool management solution, but lack the time to make changes alongside your day-to-day business? Gühring Tool Management specialises in topics such as logistics, procurement and tool planning. From our tool dispensing systems to data-based tool management with Gühring Tool Management Software (GTMS) or logistics and a comprehensive service for tool procurement – Gühring takes care of your tools so that you can concentrate on activities that generate value for you.

- Create transparency about consumption and stock levels
- Avoid machine downtime through security of supply
- More time for value-adding activities

GÜHRING



GTMS
Güding Tool Management Software



Tool Management
Powered by
GÜHRING



For more information about our services and availability in your country, please contact us.



Register now!



Gühring online shop

Tool shopping made easy

With just a few clicks, you can order tools exactly when it suits you. Check tool availability online 24/7. Creating watch lists and shopping cart templates saves you work for recurring orders. You can also assign individual user roles to your employees. Furthermore, use our subscription function in the shop to automatically reorder tools. And with the retrieval function, you can manage your contracts yourself in the shop.

- Check price and stock in real time
- Own material numbers make ordering easier
- Individual approval processes for your company
- Conveniently download CAD data when purchasing

GÜHRING



webshop.guehring.de



For more information about our services and availability in your country, please contact us.

Contents

Precision can be multi-faceted

110,000 standard items
for every application

GÜHRING

Page **Drilling tools**

- 16 QuickFinder
- 20 Content overview
- 38 Programme
- 386 Cutting data



Milling tools

- 488 QuickFinder
- 490 Content overview
- 509 Programme
- 676 Cutting data



Threading tools

- 714 QuickFinder
- 720 Compass
- 742 Programme
- 958 Cutting data



Reaming tools

- 978 QuickFinder
- 980 Content overview
- 984 Programme
- 1034 Cutting data



Countersinking tools

- 1060 Content overview
- 1064 Programme
- 1092 Cutting data



Clamping systems GM 300

- 1098 QuickFinder
- 1102 Content overview
- 1104 Programme



Grooving tools

- 1360 QuickFinder
- 1364 Content overview
- 1393 Programme
- 1544 Cutting data



Article no. index

- 1570 Article no. index



Drilling tools

The best of 125 years of experience

Historically good:
Drilling tools from Gühring

GÜHRING



Page



38	Micro drills
55	Solid carbide drills
131	Modular drills
156	Deep hole drills
218	HSS/HSCO drills
356	Centre drills
364	NC spotting drills
372	Step drills
382	Core drills

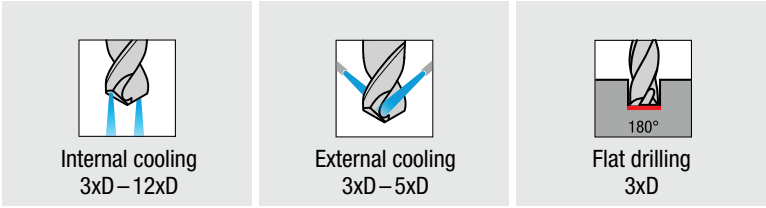







ALL-ROUNDER High degree of material flexibility







P Steel, high-alloy steel	 RT 100 U 3xD – 12xD e.g. # 2479 p. 83	 RT 100 U 3xD – 5xD e.g. # 2996 p. 64	 RT 100 FB 3xD e.g. # 6596 p. 55
-------------------------------------	---	---	---

M Stainless steel	 RT 100 U 3xD – 12xD e.g. # 2479 p. 83	 RT 100 U 3xD – 5xD e.g. # 2996 p. 64	 RT 100 FB 3xD e.g. # 6596 p. 55
-----------------------------	---	---	---

K Grey cast iron, spheroidal graphite iron and malleable cast iron	 RT 100 U 3xD – 12xD e.g. # 2479 p. 83	 RT 100 U 3xD – 5xD e.g. # 2996 p. 64	 RT 100 FB 3xD e.g. # 6596 p. 55
--	--	--	--

N Aluminium, magnesium, non-ferrous metals	 RT 100 U 3xD – 12xD e.g. # 2479 p. 83	 RT 100 U 3xD – 5xD e.g. # 2996 p. 64	 RT 100 FB 3xD e.g. # 6596 p. 55
--	---	---	---

S Special, super and titanium alloy	 RT 100 U 3xD – 12xD e.g. # 2479 p. 83	 RT 100 U 3xD – 5xD e.g. # 2996 p. 64	 RT 100 FB 3xD e.g. # 6596 p. 55
---	---	---	---

H Chilled cast iron, hardened steel	 RT 100 U 3xD – 12xD e.g. # 2479 p. 83	 RT 100 U 3xD – 5xD e.g. # 2996 p. 64
---	---	---

Didn't find what you were looking for?
Enter very specific requirements into our online Gühring Navigator and you will receive precise tool recommendations – cutting values included.



SPECIALIST
Maximum tool life, minimum cycle time

 Internal cooling 3xD – 12xD	 Internal cooling 15xD – 40xD	 High feed drilling 5xD	 External cooling 3xD – 5xD
 RT 100 XF 3xD – 12xD e.g. # 5498 p. 93	 RT 100 T 15xD – 40xD e.g. # 6509 p. 117	 FT 200 U 5xD e.g. # 6590 p. 126	 RT 100 HF 3xD e.g. # 8524 p. 62
 RT 100 VA 3xD – 5xD e.g. # 8511 p. 89	 RT 100 T 15xD – 40xD e.g. # 6509 p. 117	For this application we recommend tools with internal cooling.	
 RT 100 R 5xD – 7xD e.g. # 6501 p. 97	 RT 100 T 15xD – 40xD e.g. # 6509 p. 117	 FT 200 U 5xD e.g. # 6590 p. 126	 RT 100 U 3xD – 5xD e.g. # 2480 p. 57
 RT 100 AL 5xD e.g. # 5768 p. 95	 RT 100 T AL 15xD – 25xD e.g. # 6515 p. 114	 RT 100 AL 5xD e.g. # 5768 p. 95	 FT 200 G 5xD e.g. # 2713 p. 122
 RT 100 HF 3xD – 7xD e.g. # 8521 p. 87	 RT 100 T 15xD – 40xD e.g. # 6509 p. 117	For this application we recommend tools with internal cooling.	
 RT 100 HF 3xD – 7xD e.g. # 8521 p. 87	 RT 100 T 15xD – 40xD e.g. # 6509 p. 117	 RT 100 HF 3xD e.g. # 8524 p. 62	



ALL-ROUNDER
High degree of material flexibility

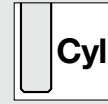

P Steel, high-alloy steel



Type N
Ø 2,000–98,000 mm
e.g. # 245
p. 330



Type GU 500 PM
Ø 1,000–20,000 mm
e.g. # 6005
p. 218

M Stainless steel



Type VA
Ø 10,000–32,000 mm
e.g. # 1262
p. 336



Type GU 500 PM
Ø 1,000–20,000 mm
e.g. # 6005
p. 218

K Grey cast iron, spheroidal graphite iron and malleable cast iron



Type N
Ø 8,000–30,000 mm
e.g. # 661
p. 333



Type GU 500 PM
Ø 1,000–20,000 mm
e.g. # 6005
p. 218

N Aluminium, magnesium, non-ferrous metals



Type GT 100
Ø 10,000–39,000 mm
e.g. # 645
p. 335



Type N
Ø 0,400–16,000 mm
e.g. # 1146
p. 281

S Special, super and titanium alloy



Type GV 120
Ø 10,500–31,000 mm
e.g. # 663
p. 329



Type AeroX
Ø 1,000–13,000 mm
e.g. # 1018
p. 280

H Chilled cast iron, hardened steel



Type GV 120
Ø 10,500–31,000 mm
e.g. # 663
p. 329













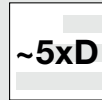
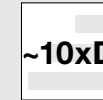
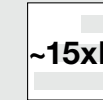









Type GV 120
Ø 1,000–13,000 mm
e.g. # 2461
p. 237

Didn't find what you were looking for?

Enter very specific requirements into our online Gühring Navigator and you will receive precise tool recommendations – cutting values included.



SPECIALIST
Maximum tool life, minimum cycle time

 <p>~3xD CYL DIN 1897</p>	 <p>~5xD CYL DIN 338</p>	 <p>~10xD CYL DIN 340</p>	 <p>~15xD CYL DIN 1869</p>
 <p>Type GT 500 DZ Ø 1,000–14,290 mm e.g. # 515 p. 242</p>	 <p>Type GT 100 Ø 1,000–15,000 mm e.g. # 2459 p. 272</p>	 <p>Type GT 100 Ø 1,000–12,000 mm e.g. # 396 p. 303</p>	 <p>Type GT 100 Ø 2,000–13,000 mm e.g. # 9670 p. 310</p>
 <p>Type VA Ø 1,000–13,000 mm e.g. # 572 p. 240</p>	 <p>Type VA Ø 1,000–13,000 mm e.g. # 629 p. 278</p>	 <p>Type Ti Ø 1,000–10,200 mm e.g. # 669 p. 305</p>	 <p>Type GT 100 Ø 2,000–13,000 mm e.g. # 9670 p. 310</p>
 <p>Type GT 500 DZ Ø 1,000–14,290 mm e.g. # 515 p. 242</p>	 <p>Type N Ø 1,000–16,000 mm e.g. # 1199 p. 281</p>	 <p>Type GT 100 Ø 1,000–12,000 mm e.g. # 396 p. 303</p>	 <p>Type GT 100 Ø 2,000–13,000 mm e.g. # 9670 p. 310</p>
 <p>Type W Ø 1,000–20,000 mm e.g. # 225 p. 230</p>	 <p>Type W Ø 0,200–20,000 mm e.g. # 207 p. 257</p>	 <p>Type W Ø 0,500–20,640 mm e.g. # 219 p. 295</p>	 <p>Type GT 50 Ø 2,000–12,700 mm e.g. # 524 p. 309</p>
 <p>Type GV 120 Ø 1,000–15,000 mm e.g. # 2461 p. 237</p>	 <p>Type Ti Ø 0,400–15,000 mm e.g. # 2458 p. 276</p>	 <p>Type Ti Ø 1,000–10,200 mm e.g. # 669 p. 305</p>	
 <p>Type H Ø 1,000–13,000 mm e.g. # 693 p. 283</p>			



Micro drills

Drilling tools

P	M	K	N	S	H	Tool illustration	Drilling depth	Shank form	Type	Standard	Tool material	Surface	d1/mm	Article no.	Page
ExclusiveLine micro-precision drills without coolant ducts															
●	●	●	○	○			4xD	Cyl	N	WN	VHM	A	0.500 - 3.000	6400	38
●	●	●	○	○			7xD	Cyl	N	WN	VHM	A	0.500 - 3.000	6401	39
ExclusiveLine micro-precision drills with coolant ducts															
●	●	●	○	○			5xD	Cyl	N	WN	VHM	A	1.000 - 3.000	6405	40
●	●	●	○	○			8xD	Cyl	N	WN	VHM	A	1.000 - 3.000	6408	41
●	●	●	○	○			15xD	Cyl	N	WN	VHM	A	1.000 - 3.000	6412	42
ExclusiveLine micro-precision drills VA without coolant ducts															
○	●	○	●				3xD	Cyl	VA	WN	VHM	X	0.500 - 3.000	6487	43
ExclusiveLine micro-precision drills VA with coolant ducts															
○	●	○	●				3xD	Cyl	VA	WN	VHM	X	1.000 - 3.000	6488	44
○	●	○	●				6xD	Cyl	VA	WN	VHM	X	1.000 - 3.000	6489	45
○	●	○	●				10xD	Cyl	VA	WN	VHM	X	1.000 - 3.000	6490	46
○	●	○	●				15xD	Cyl	VA	WN	VHM	X	1.000 - 3.000	6491	47
ExclusiveLine micro-precision drills XL with coolant ducts															
●	●	●	○	○			20xD	Cyl	N	WN	VHM	A	1.000 - 3.000	6493	48
Solid carbide micro-precision drills without coolant ducts															
○	○	○	●	○			~5xD	Cyl	N	WN	VHM	○	0.200 - 3.000	701	49
●	○	●	○	○			GL 38	Cyl	N	WN	VHM	A	0.100 - 3.000	3899	50
HSS-E-PM micro-precision drills without coolant ducts															
●	●	●	○	○			~5xD	Cyl	N	DIN 1899	HSS-E-PM	○	0.050 - 1.920	301	52
●	●	●	○	○			~5xD	Cyl	N	DIN 1899	HSS-E-PM	S	0.160 - 1.900	660	52
●	●	●	○	○			~5xD	Cyl	N	DIN 1899	HSS-E-PM	○	0.160 - 1.850	303	54



P	M	K	N	S	H	Tool illustration	Drilling depth	Shank form	Type	Standard	Tool material	Surface	d1/mm	Article no.	Page
Pilot drills with coolant ducts															
•	•	•	○	○	○		~3xD	HA	RT 100 FB	WN	VHM	F	3.000 - 20.000	6596	55
Ratio drills without coolant ducts															
•	○	•	○	○	○		3xD	HA	RT 100 U	DIN 6537 K	VHM	F	3.000 - 20.000	2480	57
•	○	•	○	○	○		3xD	HE	RT 100 U	DIN 6537 K	VHM	F	3.000 - 20.000	2472	57
•	○	•	○	○	○		3xD	HB	RT 100 U	DIN 6537 K	VHM	F	3.000 - 20.000	6026	59
•	○	•	○	○	○		3xD	Cyl	RT 100 U	DIN 6539	VHM	F	3.000 - 16.000	2473	61
•	○	•	○	○	○		3xD	HA	RT 100 HF	DIN 6537 K	VHM	Y	3.000 - 20.000	8524	62
•	○	•	○	○	○		5xD	HA	RT 100 U	DIN 6537 L	VHM	F	2.500 - 20.000	2996	64
•	○	•	○	○	○		5xD	HE	RT 100 U	DIN 6537 L	VHM	F	3.000 - 20.000	2719	64
•	○	•	○	○	○		5xD	HB	RT 100 U	DIN 6537 L	VHM	F	3.000 - 20.000	5651	66
•	○	•	○	○	○		5xD	Cyl	RT 100 U	WN	VHM	F	5.000 - 16.000	2474	68
Ratio drills with coolant ducts															
•	○	•	○	○	○		3xD	HA	RT 100 U	DIN 6537 K	VHM	F	3.000 - 20.000	2477	69
•	○	•	○	○	○		3xD	HE	RT 100 U	DIN 6537 K	VHM	F	3.000 - 20.000	2469	69
•	○	•	○	○	○		3xD	HB	RT 100 U	DIN 6537 K	VHM	F	3.000 - 20.000	6023	71
•	○	•	○	○	○		3xD	HA	RT 100 HF	DIN 6537 K	VHM	Y	3.000 - 20.000	8520	73
•	○	•	○	○	○		3xD	HE	RT 100 HF	DIN 6537 K	VHM	Y	3.000 - 20.000	8620	73
•	○	•	○	○	○		3xD	HA	RT 100 VA	DIN 6537 K	VHM	a	3.000 - 20.000	8510	75
•	○	•	○	○	○		3xD	HE	RT 100 VA	DIN 6537 K	VHM	a	3.000 - 20.000	8610	75
•	○	•	○	○	○		3xD	HB	RT 100 VA	DIN 6537 K	VHM	a	3.000 - 20.000	6024	77
•	○	•	○	○	○		3xD	HA	RT 100 XF	DIN 6537 K	VHM	F	3.000 - 20.000	6498	79
•	○	•	○	○	○		4xD	HA	RT 150 GG	WN	VHM	○	3.000 - 25.000	768	81
•	○	•	○	○	○		4xD	HA	RT 150 GG	WN	VHM	○	3.000 - 20.000	6068	82
•	○	•	○	○	○		5xD	HA	RT 100 U	DIN 6537 L	VHM	F	2.500 - 20.000	2479	83
•	○	•	○	○	○		5xD	HE	RT 100 U	DIN 6537 L	VHM	F	3.000 - 20.000	2471	83
•	○	•	○	○	○		5xD	HB	RT 100 U	DIN 6537 L	VHM	F	3.000 - 20.000	5650	85
•	○	•	○	○	○		5xD	HA	RT 100 HF	DIN 6537 L	VHM	Y	3.000 - 20.000	8521	87
•	○	•	○	○	○		5xD	HE	RT 100 HF	DIN 6537 L	VHM	Y	3.000 - 20.000	8621	87
•	○	•	○	○	○		5xD	HA	RT 100 VA	DIN 6537 L	VHM	a	3.000 - 20.000	8511	89
•	○	•	○	○	○		5xD	HE	RT 100 VA	DIN 6537 L	VHM	a	3.000 - 20.000	8611	89
•	○	•	○	○	○		5xD	HB	RT 100 VA	DIN 6537 L	VHM	a	3.000 - 20.000	6025	91

Drilling tools



P	M	K	N	S	H	Tool illustration	Drilling depth	Shank form	Type	Stand-ard	Tool material	Sur-face	d1/mm	Article no.	Page
Ratio drills with coolant ducts															
•	•	•	•	•	•		5xD	HA	RT 100 XF	DIN 6537L	VHM	F	3.000 - 20.000	5498	93
			•				5xD	HA	RT 100 AI	DIN 6537L	VHM	○	3.000 - 20.000	5768	95
			•				5xD	HA	RT 100 R	DIN 6537L	VHM	F	3.000 - 20.000	6501	97
•	•	•	•	•	•		7xD	HA	RT 100 U	WN	VHM	F	3.000 - 20.000	4044	99
•	•	•	•	•	•		7xD	HE	RT 100 U	WN	VHM	F	3.000 - 20.000	4045	99
•			•				7xD	HA	RT 100 HF	WN	VHM	Y	3.000 - 16.000	8522	101
•	•	•	•	•	•		7xD	HA	RT 100 XF	WN	VHM	F	3.000 - 20.000	5499	102
			•				7xD	HA	RT 100 R	WN	VHM	F	4.000 - 20.000	6502	104
		•	•	•	•		7xD	HA	RT 150 GG	WN	VHM	○	3.000 - 20.000	769	106
		•	•	•	•		7xD	HA	RT 150 GG	WN	VHM	○	3.000 - 20.000	6069	107
		•	•	•	•		10xD	HA	RT 150 GG	WN	VHM	○	3.000 - 20.000	770	108
		•	•	•	•		10xD	HA	RT 150 GG	WN	VHM	○	3.000 - 20.000	6070	109
		•	•	•	•		15xD	HA	RT 150 GN	WN	VHM	○	5.000 - 14.000	773	110
•	•	•	•	•	•		12xD	HA	RT 100 U	WN	VHM	F	3.000 - 20.000	5525	111
•	•	•	•	•	•		12xD	HA	RT 100 XF	WN	VHM	F	3.000 - 20.000	6499	112
			•				15xD	HA	RT 100 T AL	WN	VHM	○	3.000 - 14.000	6515	114
			•				20xD	HA	RT 100 T AL	WN	VHM	○	3.000 - 14.000	6516	115
			•				25xD	HA	RT 100 T AL	WN	VHM	○	3.000 - 14.000	6517	116
•	•	•	•	•	•		15xD	HA	RT 100 T	WN	VHM	A	3.000 - 16.000	6509	117
•	•	•	•	•	•		20xD	HA	RT 100 T	WN	VHM	A	3.000 - 16.000	6511	118
•	•	•	•	•	•		25xD	HA	RT 100 T	WN	VHM	A	3.000 - 16.000	6512	119
•	•	•	•	•	•		30xD	HA	RT 100 T	WN	VHM	A	3.000 - 14.000	6513	120
•	•	•	•	•	•		40xD	HA	RT 100 T	WN	VHM	A	3.000 - 10.000	6514	121
Ratio drills without coolant ducts, 3-fluted															
		•	•				5xD	HA	FT 200 G	DIN 6537L	VHM	○	3.000 - 20.000	2713	122
		•	•				5xD	Cyl	GS 200 G	DIN 6539	VHM	○	3.000 - 20.000	1025	123
○	○	○	○				5xD	Cyl	GS 200 U	DIN 6539	VHM	S	3.000 - 19.500	611	125
Ratio drills with coolant ducts, 3-fluted															
•	•	•	•	•	•		5xD	HA	FT 200 U	DIN 6537L	VHM	F	4.000 - 20.000	6590	126
Twist drills with reinforced straight shank															
○	○	○	•				3xD	HA	H	DIN 6537K	VHM	A	2.600 - 14.100	1946	128



P	M	K	N	S	H	Tool illustration	Drilling depth	Shank form	Type	Standard	Tool material	Surface	d1/mm	Article no.	Page
Carbide-tipped twist drills								Cyl	N	DIN 8037	HM	○	1.700 - 24.000	703	129
○	○	○	○	○											

Drilling tools



P	M	K	N	S	H	Tool illustration	Drilling depth	Shank form	Type	Standard	Tool material	Surface	d1/mm	Article no.	Page
Tool holders for interchangeable inserts HT 800															
							1xD	HE	HT 800 WP	WN	Ni		17.000 - 46.000	4105	131
							1,5xD	HE	HT 800 WP	WN	Ni		11.000 - 39.000	4106	132
							3xD	HE	HT 800 WP	WN	Ni		11.000 - 39.000	4107	134
							5xD	HE	HT 800 WP	WN	Ni		11.000 - 39.000	4108	136
							7xD	HE	HT 800 WP	WN	Ni		11.000 - 39.000	4109	138
							10xD	HE	HT 800 WP	WN	Ni		11.000 - 31.500	4110	140
Interchangeable inserts HT 800															
○	○	○	○	○	○				HT 800 WP Pilot	WN	VHM	a	11.000 - 40.000	4111	142
●									HT 800 WP	WN	VHM	F	12.000 - 40.000	4229	144
●	○								HT 800 WP	WN	VHM	F	11.000 - 40.000	4112	145
○		●							HT 800 WP	WN	VHM	Y	11.000 - 40.000	4113	147
			●						HT 800 WP	WN	VHM	○	11.000 - 40.000	4114	149
○	●			○	○				HT 800 WP	WN	VHM	a	11.000 - 40.000	4115	151
Indexable inserts															
●	○	○	○	○	○				CPGT	WN	VHM	S		7645	153
○		●							CPGW	WN	VHM	A		7632	153
			●						CPGT	WN	VHM	○		7635	153
Clamping screws															
										WN				6128	154
										WN				4071	154
Torque wrenches															
										WN				4915	155
Co-alloyed HSS steel															
										WN				4917	155
Torx screwdrivers															
										WN				1612	155















P	M	K	N	S	H	Tool illustration	Drilling depth	Stand-ard	Type	Cutting direction	Tool material	Surface	d1/mm	Article no.	Page
EB 100 M single-fluted gun drills															
•	•	•	○	○	○		25xD	WN	EB 100 M	R	VHM	a	1.000 - 16.000	5646	156
○	○	○	•	•	○		25xD	WN	EB 100 M	R	VHM	○	1.000 - 16.000	5685	156
•	•	•	○	○	○		50xD	WN	EB 100 M	R	VHM	a	1.000 - 10.000	5647	157
○	○	○	•	•	○		50xD	WN	EB 100 M	R	VHM	○	1.000 - 10.000	5686	157
•	•	•	○	○	○		75xD	WN	EB 100 M	R	VHM	a	1.000 - 7.144	5648	158
○	○	○	•	•	○		75xD	WN	EB 100 M	R	VHM	○	1.000 - 7.144	5687	158
EB 100 single-fluted gun drills															
○	○	○	•	•	○		SPL 45,00	WN	EB 100	R	VHM	○	0.900 - 3.200	5024	159
•	•	•	○	○	○		SPL 45,00	WN	EB 100	R	VHM	A	1.000 - 3.200	5632	159
○	○	○	•	•	○		SPL 80,00	WN	EB 100	R	VHM	○	1.000 - 5.000	5020	160
•	•	•	○	○	○		SPL 80,00	WN	EB 100	R	VHM	A	1.000 - 5.000	5633	160
○	○	○	•	•	○		SPL 120,00	WN	EB 100	R	VHM	○	1.500 - 5.000	5026	161
•	•	•	○	○	○		SPL 120,00	WN	EB 100	R	VHM	A	1.500 - 5.000	5637	161
○	○	○	•	•	○		SPL 160,00	WN	EB 100	R	VHM	○	1.500 - 8.000	5021	162
•	•	•	○	○	○		SPL 160,00	WN	EB 100	R	VHM	A	1.500 - 8.000	5638	162
EB 80 single-fluted gun drills															
•	○	•	○	○	○		20xD	WN	EB 80	R	HM	S	4.000 - 12.000	5018	163
•	•	○	○	•	○		20xD	WN	EB 80	R	HM	C	3.969 - 16.000	5639	163
•	○	•	○	○	○		30xD	WN	EB 80	R	HM	S	4.000 - 12.000	5460	164
•	•	○	○	•	○		30xD	WN	EB 80	R	HM	C	3.969 - 16.000	5640	164
○	○	○	•	•	○		40xD	WN	EB 80	R	HM	○	4.000 - 12.000	5689	165
•	○	•	○	○	○		40xD	WN	EB 80	R	HM	S	4.000 - 12.000	5022	165
•	•	○	○	•	○		40xD	WN	EB 80	R	HM	C	3.969 - 16.000	5641	166
•	•	○	○	•	○		60xD	WN	EB 80	R	HM	C	3.969 - 15.950	5669	166
○	○	○	•	•	○		80xD	WN	EB 80	R	HM	○	3.969 - 11.950	5690	167
•	○	•	○	○	○		80xD	WN	EB 80	R	HM	S	4.950 - 11.950	5023	167
•	•	○	○	•	○		80xD	WN	EB 80	R	HM	C	3.969 - 15.950	5642	168
EB 80 XXL single-fluted gun drills															
•	○	•	•	○	○		GL 600	WN	EB 80 XXL	R	HM	S	3.000 - 25.000	5688	169
•	○	•	•	○	○		GL 800	WN	EB 80 XXL	R	HM	S	3.000 - 25.000	5691	169
•	○	•	•	○	○		GL 1000	WN	EB 80 XXL	R	HM	S	3.000 - 25.000	5164	170

Drilling tools



P	M	K	N	S	H	Tool illustration	Drilling depth	Standard	Type	Cutting direction	Tool material	Surface	d1/mm	Article no.	Page
EB 80 XXL single-fluted gun drills															
●	○	●	●	○	○		GL 1200		EB 80 XXL		HM	S	3.000 - 25.000	5692	170
●	○	●	●	○	○		GL 1400		EB 80 XXL		HM	S	4.000 - 25.000	5681	171
●	○	●	●	○	○		GL 1600		EB 80 XXL		HM	S	4.000 - 25.000	5693	171
●	○	●	●	○	○		GL 1800		EB 80 XXL		HM	S	4.000 - 32.000	5682	172
●	○	●	●	○	○		GL 2000		EB 80 XXL		HM	S	4.000 - 32.000	5694	172
EB 800 single-fluted gun drills with interchangeable inserts															
●	○	○	●	○	○		30xD		EB 800		HM	S	12.000 - 31.900	5644	173
Outer inserts for single-fluted gun drills EB 800															
●	○	○	●	○	○				EB 800		VHM	S	12.000 - 52.000	5029	177
●	●	●	●	○	○				EB 800		VHM	Y	12.000 - 52.000	5702	180
●	○	●	○	○	○				EB 800		VHM	F	12.000 - 52.000	5704	183
○	●	○	○	●	○				EB 800		VHM	a	12.000 - 52.000	5706	186
Guide pads for single-fluted gun drills EB 800															
●	○	○	●	○	○				EB 800		VHM	S	12.000 - 52.000	5030	189
●	●	●	●	○	○				EB 800		VHM	Y	12.000 - 52.000	5703	192
●	○	●	○	○	○				EB 800		VHM	F	12.000 - 52.000	5705	195
○	●	○	○	●	○				EB 800		VHM	a	12.000 - 52.000	5707	198
Inner inserts for single-fluted gun drills EB 800															
●	○	○	●	○	○				EB 800		VHM	S		5665	201
●	●	●	●	○	○				EB 800		VHM	Y		5667	201
●	○	●	○	○	○				EB 800		VHM	F		5666	202
○	●	○	○	●	○				EB 800		VHM	a		5668	202
Drill bushes															
											VHM		0.900 - 40.000	5748	203
											HSS		0.900 - 40.000	5747	204
Steady rest bushings															
														5749	206
Moulded steady rest bushings for single-fluted gun drills															
														5750	208



P	M	K	N	S	H	Tool illustration	Drilling depth	Stand-ard	Type	Cutting direction	Tool material	Sur-face	d1/mm	Article no.	Page
Moulded steady rest bushings for single-fluted gun drills															
														5767	210
Sealing washers für single-fluted gun drills															
														5752	211
														5770	212
														5772	213
Adjustment screws															
													6.000 - 16.000	5754	214
													10.000 - 24.000	5755	214
Sealing plugs															
													8.000 - 25.000	5766	215
Torque wrenches set															
														4966	216
Torque wrenches															
														4915	216
Torx screwdrivers															
														1612	216
Co-alloyed HSS steel															
														4917	217
Clamping screws															
														4071	217

Drilling tools



P	M	K	N	S	H	Tool illustration	Drilling depth	Stand-ard	Type	Cutting direction	Tool material	Surface	d1/mm	Article no.	Page
Twist drills with standard shank															
•	•	•	•	•	•		~3xD	WN	GU500 PM	R	HSS-E-PM	F	1.000 - 20.000	6005	218
•	•	•	•	•	•		~5xD	WN	GU500 PM	R	HSS-E-PM	F	2.000 - 20.000	6006	220
Stub drills															
•	•	•	•	•	•		~3xD	DIN 1897	N	R	HSS		0.400 - 44.000	223	222
•	•	•	•	•	•		~3xD	DIN 1897	N	R	HSS	S	0.500 - 30.000	653	222
•	•	•	•	•	•		~3xD	DIN 1897	N	R	HSS		2.000 - 13.000	252	226
•	•	•	•	•	•		~3xD	DIN 1897	N	L	HSS		0.500 - 37.000	226	226
•	•	•	•	•	•		~3xD	DIN 1897	H	R	HSS		0.690 - 22.000	224	229
•	•	•	•	•	•		~3xD	DIN 1897	W	R	HSS		1.000 - 20.000	225	230
•	•	•	•	•	•		~3xD	DIN 1897	GT 80	R	HSS		1.000 - 20.000	552	231
•	•	•	•	•	•		~3xD	DIN 1897	GT 80	L	HSS		1.000 - 19.000	553	231
•	•	•	•	•	•		~3xD	DIN 1897	GV 120	R	HSCO		0.400 - 48.000	329	234
•	•	•	•	•	•		~3xD	DIN 1897	GV 120	R	HSCO	S	0.500 - 15.500	659	234
•	•	•	•	•	•		~3xD	DIN 1897	GV 120	R	HSCO	F	1.000 - 15.000	2461	237
•	•	•	•	•	•		~3xD	DIN 1897	GT 80	R	HSCO	S	1.000 - 20.000	1228	238
•	•	•	•	•	•		~3xD	DIN 1897	GT 80	R	HSS-E-PM	F	1.000 - 16.000	2498	238
•	•	•	•	•	•		~3xD	DIN 1897	VA	R	HSCO	S	1.000 - 13.000	572	240
•	•	•	•	•	•		~3xD	DIN 1897	N	R	M42		1.000 - 15.000	1259	241
•	•	•	•	•	•		~3xD	DIN 1897	GT 500 DZ	R	HSS-E-PM	F	1.000 - 14.290	515	242
•	•	•	•	•	•		3xD	DIN 6539	N	R	VHM		0.500 - 16.000	730	244
•	•	•	•	•	•		3xD	WN	N	R	VHM	F	1.000 - 16.000	2463	244
Jobber drills															
•	•	•	•	•	•		~5xD	DIN 338	N	R	HSS		0.200 - 20.000	205	246
•	•	•	•	•	•		~5xD	DIN 338	N	R	HSS	S	0.200 - 19.000	651	246
•	•	•	•	•	•		~5xD	DIN 338	N	L	HSS		0.200 - 20.000	208	251
•	•	•	•	•	•		~5xD	DIN 338	N	L	HSS	S	0.500 - 13.500	664	251
•	•	•	•	•	•		~5xD	DIN 338	H	R	HSS		0.200 - 20.000	206	254
•	•	•	•	•	•		~5xD	DIN 338	H	L	HSS		0.300 - 18.000	209	254
•	•	•	•	•	•		~5xD	DIN 338	W	R	HSS		0.200 - 20.000	207	257
•	•	•	•	•	•		~5xD	DIN 338	GT 100	R	HSS		0.600 - 16.000	549	259
•	•	•	•	•	•		~5xD	DIN 338	GT 100	R	HSS	S	1.000 - 16.000	652	259



P	M	K	N	S	H	Tool illustration	Drilling depth	Stand-ard	Type	Cutting direction	Tool material	Sur-face	d1/mm	Article no.	Page
●	●	●					~5xD	DIN 338	GT 100	L	HSS		1.000 - 15.500	550	262
●	○	●	○				~5xD	DIN 338	N	R	HSCO		0.200 - 20.000	305	264
●	○	●	○				~5xD	DIN 338	N	R	HSCO	S	1.200 - 13.000	2997	264
●	○	●	○				~5xD	DIN 338	N	L	HSCO		0.500 - 18.000	308	268
●	●	●	○	○			~5xD	DIN 338	GT 100	R	HSCO		1.000 - 16.000	622	270
●	●	●	○	○			~5xD	DIN 338	GT 100	R	HSCO	S	1.000 - 16.000	658	270
●	●	●	○	○			~5xD	DIN 338	GT 100	R	HSCO	F	1.000 - 15.000	2459	272
○	●	●	○				~5xD	DIN 338	Ti	R	HSCO	○	0.200 - 19.000	605	273
○	●	●	○				~5xD	DIN 338	Ti	R	HSCO	S	0.500 - 14.500	657	273
○	●	●	○				~5xD	DIN 338	Ti	R	HSCO	F	0.400 - 15.000	2458	276
○	●	○	○	●			~5xD	DIN 338	VA	R	HSCO	S	1.000 - 13.000	629	278
●	●	●	○				~5xD	DIN 338	GU3FS	R	HSCO	○	1.000 - 13.000	9000	279
●	●	●	○				~5xD	DIN 338	AeroX	R	M42	○	1.000 - 13.000	1018	280
●	○	○	○				~5xD	DIN 338	N	R	M42	○	0.400 - 16.000	1146	281
●	●	●	○				~5xD	DIN 338	N	R	M42	F	1.000 - 16.000	1199	281
●	○	○	○	○			3xD	WN	H	R	M42	R	1.000 - 13.000	693	283
○	○	○	○				~5xD	WN	N	R	VHM	○	1.000 - 12.700	732	284
●	○	○	○	○			~5xD	WN	N	R	VHM	F	1.000 - 12.700	2464	284
●	○	○	○				~8xD	WN	GT 100	R	VHM	○	3.170 - 12.700	2601	286
Bushing drills															
●	●	○					~10xD	DIN 339	N	R	HSS		0.800 - 20.000	211	287
●	●	●					~10xD	DIN 339	N	R	HSS	S	1.000 - 13.000	666	287
Long series twist drills															
●	●	○					~10xD	DIN 340	N	R	HSS		0.400 - 31.000	217	289
●	●	○					~10xD	DIN 340	N	R	HSS	S	0.500 - 22.220	667	289
●	●	○					~10xD	DIN 340	N	L	HSS		0.450 - 25.500	220	292
●	●	○					~10xD	DIN 340	N	R	HSS	○	2.950 - 25.250	204	293
○	○	○	○				~10xD	DIN 340	H	R	HSS	○	0.500 - 16.000	218	294
○	○	○	○				~10xD	DIN 340	W	R	HSS	○	0.500 - 20.640	219	295
●	●	●					~10xD	DIN 340	GT 100	R	HSS		1.000 - 14.000	535	297
●	●	○					~10xD	DIN 340	GT 100	R	HSS	S	1.000 - 14.000	668	297

Drilling tools



P	M	K	N	S	H	Tool illustration	Drilling depth	Stand-ard	Type	Cutting direction	Tool material	Surface	d1/mm	Article no.	Page
Long series twist drills															
○			●				~10xD	DIN 340	GT 50		HSS	○	1.000 - 14.000	501	299
●	○	●	●				~10xD	DIN 340	N		HSCO		0.500 - 22.000	317	301
●	●	●	○	○			~10xD	DIN 340	GT 100		HSCO		1.000 - 16.000	336	303
●	●	○	○	○			~10xD	DIN 340	GT 100		HSCO		1.000 - 12.000	396	303
○	●		●	○			~10xD	DIN 340	Ti		HSCO	○	1.000 - 15.870	617	305
○	●		●	○			~10xD	DIN 340	Ti		HSCO		1.000 - 10.200	669	305
Extra length twist drills, series 1															
●	●	○					~15xD	DIN 1869	N		HSS		1.600 - 13.000	235	307
●	●	●					~15xD	DIN 1869	GT 100		HSS		1.950 - 13.000	502	308
○		●					~15xD	DIN 1869	GT 50		HSS	○	2.000 - 12.700	524	309
●	●	●	○	○			~15xD	DIN 1869	GT 100		HSCO		2.700 - 10.000	618	310
●	●	●	●	○			~15xD	DIN 1869	GT 100		HSCO		2.000 - 13.000	9670	310
Extra length twist drills, series 2															
●	●	○					~20xD	DIN 1869	N		HSS	○	2.700 - 13.000	236	311
●	●	●					~20xD	DIN 1869	GT 100		HSS		2.000 - 13.000	503	312
●	●	●	○	○			~20xD	DIN 1869	GT 100		HSCO		3.000 - 10.000	619	313
●	●	●	●	○			~20xD	DIN 1869	GT 100		HSCO		2.000 - 13.000	9671	313
Extra length twist drills, series 3															
●	●	○					~25xD	DIN 1869	N		HSS	○	3.500 - 13.000	237	314
●	●	●					~25xD	DIN 1869	GT 100		HSS		2.500 - 13.000	504	315
●	●	●	○	○			~25xD	DIN 1869	GT 100		HSCO		2.500 - 13.000	571	316
●	●	●	●	○			~25xD	DIN 1869	GT 100		HSCO		2.500 - 10.000	9672	316
Extra length twist drills															
●	●	●					>25xD	WN	GT 100		HSS		6.000 - 12.000	242	317
●	●	●					>25xD	WN	GT 100		HSS	○	8.000 - 12.000	243	317
●	●	●					>25xD	WN	GT 100		HSS	○	10.000 - 12.000	244	317
Aircraft extension drills, 6 inches long															
●	●	●						NAS 907	N		HSS	○	1.500 - 8.000	577	318
●	●	●						NAS 907	N		HSS		1.500 - 8.000	579	319
Aircraft extension drills, 12 inches long															
●	●	●						NAS 907	N		HSS	○	1.500 - 8.000	578	320
●	●	●						NAS 907	N		HSS		1.500 - 8.000	580	321



P	M	K	N	S	H	Tool illustration	Drilling depth	Stand-ard	Type	Cutting direction	Tool material	Sur-face	d1/mm	Article no.	Page
Twist drills with coolant ducts															
•	○	•	•				~10xD	WN	N	R	HSS	○	3.000 - 13.000	390	322
•	•	•	•	○			~5xD	WN	GT80 IK	R	HSCO	Ⓢ	5.000 - 20.000	1132	322
Drills with shank Ø 12.7 mm															
•	•	○						WN	N	R	HSS	●	13.000 - 28.570	268	323
Drills with shank Ø 16.0 mm															
•	•	○	○	○				WN	N	R	HSCO	○	16.000 - 40.000	128	324
Twist drill sets															
•	•	○					~5xD	DIN 338	N	R	HSS	●		201	325
•	•	○					~5xD	DIN 338	N	R	HSS	Ⓢ		17	325
•	○	•	○				~5xD	DIN 338	N	R	HSCO	●		16	326
○	•		•	○			~5xD	DIN 338	Ti	R	HSCO	○		18	326
•	•	•	•	○			~5xD	DIN 338	GU3FS	R	HSCO	●		9001	327
•	•	•	•	○			~5xD	DIN 338	AeroX	R	M42	●		1083	327
•	○	•	○	•	○		3xD	WN	H	R	M42	Ⓢ		6030	328



P	M	K	N	S	H	Tool illustration	Drilling depth	Stand-ard	Type	Cutting direction	Tool material	Sur-face	d1/mm	Article no.	Page
Jobber drills															
•	•	•	○	○	○		~3xD	WN	GV 120	R	HSCO	○	8.100 - 37.000	363	329
•	•	•	○	•	○		~3xD	WN	GV 120	R	HSCO	Ⓢ	10.500 - 31.000	663	329
Twist drills															
•	•	○	○	○	○		~5xD	DIN 345	N	R	HSS	○ _{2,36}	2.000 - 98.000	245	330
•	•	○	○	○	○		~5xD	DIN 345	N	R	HSS	Ⓢ	3.000 - 31.000	654	330
•	○	•	○	○	○		~5xD	DIN 345	N	R	HSCO	○	4.000 - 50.000	345	333
•	○	•	○	○	○		~5xD	DIN 345	N	R	HSCO	Ⓢ	8.000 - 30.000	661	333
•	•	•	○	○	○		~5xD	DIN 345	GT 100	R	HSCO	○ ₁₆₀	10.000 - 39.000	645	335
○	•	○	○	○	○		~5xD	DIN 345	VA	R	HSCO	○	10.000 - 32.000	1262	336
Bushing drills															
•	•	○	○	○	○		~10xD	DIN 341	N	R	HSS	○	4.000 - 50.000	257	337
•	•	•	○	○	○		~10xD	DIN 341	GT 100	R	HSS	○ ₁₆₀	5.500 - 32.000	551	339
•	○	•	○	○	○		~10xD	DIN 341	N	R	HSCO	○	4.750 - 40.000	357	340
•	•	•	○	○	○		~10xD	DIN 341	GT 100	R	HSCO	○ ₁₆₀	10.000 - 26.000	623	341
Extra length twist drills, series 1															
•	•	○	○	○	○		~15xD	DIN 1870	N	R	HSS	○	8.000 - 50.000	266	342
•	•	•	○	○	○		~15xD	DIN 1870	GT 100	R	HSS	○ ₁₆₀	8.000 - 30.160	526	343
•	•	•	○	○	○		~15xD	DIN 1870	GT 100	R	HSCO	○ ₁₆₀	9.520 - 30.000	620	344
Extra length twist drills, series 2															
•	•	○	○	○	○		~20xD	DIN 1870	N	R	HSS	○	8.000 - 45.000	267	345
•	•	•	○	○	○		~20xD	DIN 1870	GT 100	R	HSS	○ ₁₆₀	8.000 - 30.000	527	346
•	•	•	○	○	○		~20xD	DIN 1870	GT 100	R	HSCO	○ ₁₆₀	9.520 - 23.420	621	347
Extra length twist drills															
•	•	•	○	○	○		20xD	WN	GT 100	R	HSS	○	6.000 - 10.000	564	348
•	•	•	○	○	○		20xD	WN	GT 100	R	HSS	○ ₁₆₀	6.000 - 17.000	565	348
•	•	•	○	○	○		20xD	WN	GT 100	R	HSS	○ ₁₆₀	8.000 - 40.000	566	349
•	•	•	○	○	○		20xD	WN	GT 100	R	HSS	○ ₁₆₀	14.000 - 40.000	293	349
•	•	•	○	○	○		20xD	WN	GT 100	R	HSS	○	14.000 - 18.000	298	350
•	•	•	○	○	○		20xD	WN	GT 100	R	HSS	○	14.000 - 18.000	299	350



P	M	K	N	S	H	Tool illustration	Drilling depth	Stand-ard	Type	Cutting direction	Tool material	Sur-face	d1/mm	Article no.	Page
Twist drills with internal coolant, flute length to company standard															
•	○	•	•					WN	N	R	HSS	●	8.000 - 50.000	254	351
•	○	•	•					WN	N	R	HSS	●	8.000 - 42.000	255	352
•	○	•	•					WN	N	R	HSS	●	8.000 - 42.000	253	353
Twist drills with internal coolant, flute length to DIN 341															
•	○	•	•				~10xD	WN	N	R	HSS	●	10.000 - 40.000	270	354
•	•	•	•	○	○		~10xD	WN	GT 100	R	HSCO	●	11.000 - 33.000	370	354
Twist drills with internal coolant, flute length to DIN 1870															
•	•	•	•	○	○		~15xD	WN	GT 100	R	HSCO	●	11.000 - 34.000	374	355

Drilling tools



P	M	K	N	S	H	Tool illustration	Stand- ard	Form	Cutting direction	Tool material	Sur- face	d1/mm	Article no.	Page
Centre drills without flat														
○	○	○	○	○	○		WN	A	R	VHM	○	0.500 - 6.300	736	356
●	●	●	●	○			DIN 333	A	R	HSCO	○	1.000 - 4.000	381	357
●	●	●	○	●			DIN 333	A	R	HSCO	F	0.500 - 4.000	6503	357
●	○	●	●	○			DIN 333	A	R	HSS	○	0.500 - 12.500	581	357
●	○	●	○				DIN 333	A	R	HSS	S	0.500 - 8.000	613	357
●	○	●	●	○			DIN 333	A	L	HSS	○	0.500 - 12.500	582	358
●	○	●	●	○			DIN 333	R	R	HSS	○	0.500 - 12.500	583	359
●	○	●	●	○			DIN 333	R	R	HSS	S	0.800 - 8.000	614	359
●	○	●	●	○			DIN 333	R	L	HSS	○	0.800 - 5.000	584	359
●	○	●	●	○			DIN 333	B	R	HSS	○	1.000 - 10.000	585	360
●	○	●	○	●			DIN 333	B	R	HSS	F	1.000 - 6.300	6504	360
●	○	●	●	○			ASME B94.11 M	A	R	HSS	○	1.190 - 7.940	594	361
●	○	●	●	○			ASME B94.11 M	B	R	HSS	○	1.190 - 6.350	595	361
●	○	●	●	○			BS 328	A	R	HSS	○	1.190 - 7.940	292	361
●	○	●	●	○			WN	A	R	HSS	○	0.500 - 10.000	281	362
●	○	●	●	○			WN	A	R	HSS	○	1.000 - 3.150	280	362
Centre drills with flat														
●	○	●	●	○			DIN 333	A	R	HSS	○	1.600 - 12.500	587	363
●	○	●	●	○			DIN 333	R	R	HSS	○	1.000 - 10.000	588	363
●	○	●	●	○			DIN 333	B	R	HSS	○	1.600 - 8.000	589	363



P	M	K	N	S	H	Tool illustration	Shank form	Standard	Cutting direction	Tool material	Surface	d1/mm	Article no.	Page
90° NC spotting drills														
○	○	○	●	○	○		HA	WN	R	VHM	○	4.000 - 20.000	723	364
●	●	●	○	●	○		HB	WN	R	VHM	F	4.000 - 20.000	6027	364
●	●	●	●	○			B	WN	R	HSCO	F	3.000 - 20.000	1133	365
●	○	●	○	○			A	WN	R	HSS	○	3.000 - 25.400	557	366
●	○	●	○	○			A	WN	R	HSS	S	3.000 - 25.400	568	366
●	○	●	○	○			A	WN	R	HSS	○	6.350 - 25.400	559	366
120° NC spotting drills														
○	○	○	●	○	○		HA	WN	R	VHM	○	5.000 - 20.000	724	367
●	●	●	○	●	○		HB	WN	R	VHM	F	3.000 - 20.000	6028	367
●	●	●	●	○			B	WN	R	HSCO	F	3.000 - 20.000	1135	368
●	○	●	○	○			A	WN	R	HSS	○	3.000 - 25.400	556	368
●	○	●	○	○			A	WN	R	HSS	S	3.000 - 25.400	567	368
142° NC spotting drills														
○	○	○	●	○	○		HB	WN	R	VHM	○	4.000 - 20.000	546	369
●	●	●	○	●	○		HA/HB	WN	R	VHM	F	1.000 - 20.000	6029	369
Straight shank drills double-ended														
●	○	●	○	○			Cyl	WN	R	HSS		1.500 - 10.000	554	370
Spot weld drills														
●	○	●	○	○			Cyl	WN	R	HSCO	○	6.000 - 10.000	1137	371
●	○	●	○	○			Cyl	WN	R	HSCO	○	8.000 - 8.000	6996	371



P	M	K	N	S	H	Tool illustration	Stand- ard	Form	Type	Cutting direction	Tool material	Sur- face	d1/mm	Article no.	Page
Stepped drills for centring according to DIN 332															
●	○	●	●	○			WN	D	N	R	HSS	○	8.000 - 40.000	274	372
●	○	●	●	○			WN	DR	N	R	HSS	○	8.000 - 40.000	574	372
●	○	●	●	○			WN	D	N	R	HSS	○	8.000 - 20.000	575	373
●	○	●	●	○			WN	D	N	R	HSS	○	14.000 - 40.000	576	373
Straight shank short step drills with straight shank															
●	○	●	●	○			WN		N	R	HSS	○	6.000 - 19.000	378	374
●	○	●	●	○			WN		N	R	HSS	Ⓢ	6.000 - 19.000	238	374
●	○	●	●	○			WN		N	R	HSS	○	6.600 - 21.500	1147	375
●	○	●	●	○			WN		N	R	HSS	○	6.000 - 18.000	379	376
●	○	●	●	○			WN		N	R	HSS	Ⓢ	6.000 - 18.000	249	376
●	○	●	●	○			WN		N	R	HSS	○	3.400 - 13.500	380	377
●	○	●	●	○			WN		N	R	HSS	Ⓢ	3.400 - 13.500	250	377
Straight shank subland drills															
●	○	●	○	○			DIN 8374	A	N	R	HSS	○	6.000 - 19.000	536	378
●	○	●	○	○			WN		N	R	HSS	○	6.600 - 17.200	636	378
●	○	●	○	○			DIN 8376		N	R	HSS	○	6.000 - 18.000	538	379
●	○	●	○	○			WN		N	R	HSS	○	5.900 - 17.500	514	379
●	○	●	○	○			DIN 8378		N	R	HSS	○	3.400 - 13.500	540	380
Taper shank subland drills															
●	○	●	○	○			DIN 8377		N	R	HSS	○	10.000 - 33.000	539	381
●	○	●	○	○			DIN 8379		N	R	HSS	○	9.000 - 22.000	541	381
Straight shank core drills															
●	○	●	○	○			DIN 344		N	R	HSS	○	3.800 - 20.000	533	382
Taper shank core drills															
●	○	●	○	○			DIN 343		N	R	HSS	○	7.800 - 50.000	534	383
●	○	●	○	○			DIN 1864		N	R	HSS	○	7.800 - 30.000	555	384
Taper pin drills															
●	○	●	○	○			DIN 1898		N	R	HSS	○	1.500 - 12.000	531	385
●	○	●	○	○			DIN 1898		N	R	HSS	○	5.000 - 25.000	532	385



RT 100 **XF**

TOUGH. *EXTREME.* **POWERFUL.**



Micro drills

Micro drills

ExclusiveLine micro-precision drills without coolant ducts

Article no. **6400**



Cutting data page 386



Web thinning $\geq \varnothing 0.500$ • facet point grind • main cutting edge form straight • ground cutting edge preparation

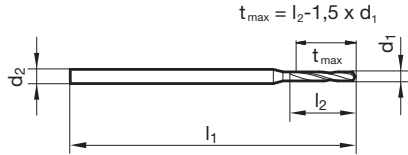

Article no. 6400				Article no. 6400					
d1 mm	d2 h6 mm	l1 mm	l2 mm	Order no.	d1 mm	d2 h6 mm	l1 mm	l2 mm	Order no.
0.500	3.0	47.0	3.0	6400 0.500	1.950	3.0	52.0	11.7	6400 1.950
0.550	3.0	47.0	3.3	6400 0.550	1.980	4.0	59.0	12.0	6400 1.980
0.600	3.0	47.0	3.6	6400 0.600	2.000	4.0	59.0	12.0	6400 2.000
0.650	3.0	47.0	3.9	6400 0.650	2.050	4.0	59.0	12.3	6400 2.050
0.700	3.0	47.0	4.2	6400 0.700	2.100	4.0	59.0	12.6	6400 2.100
0.750	3.0	47.0	4.5	6400 0.750	2.150	4.0	59.0	12.9	6400 2.150
0.800	3.0	47.0	4.8	6400 0.800	2.200	4.0	59.0	13.2	6400 2.200
0.850	3.0	47.0	5.1	6400 0.850	2.250	4.0	59.0	13.5	6400 2.250
0.900	3.0	47.0	5.4	6400 0.900	2.300	4.0	59.0	13.8	6400 2.300
0.950	3.0	47.0	5.7	6400 0.950	2.350	4.0	59.0	14.1	6400 2.350
1.000	3.0	47.0	6.0	6400 1.000	2.380	4.0	59.0	14.4	6400 2.380
1.050	3.0	47.0	6.3	6400 1.050	2.400	4.0	59.0	14.4	6400 2.400
1.100	3.0	47.0	6.6	6400 1.100	2.450	4.0	59.0	14.7	6400 2.450
1.150	3.0	47.0	6.9	6400 1.150	2.500	4.0	59.0	15.0	6400 2.500
1.200	3.0	47.0	7.2	6400 1.200	2.550	4.0	59.0	15.3	6400 2.550
1.250	3.0	47.0	7.5	6400 1.250	2.600	4.0	59.0	15.6	6400 2.600
1.300	3.0	47.0	7.8	6400 1.300	2.650	4.0	59.0	15.9	6400 2.650
1.350	3.0	47.0	8.1	6400 1.350	2.700	4.0	59.0	16.2	6400 2.700
1.400	3.0	47.0	8.4	6400 1.400	2.750	4.0	59.0	16.5	6400 2.750
1.450	3.0	47.0	8.7	6400 1.450	2.780	4.0	59.0	16.8	6400 2.780
1.500	3.0	47.0	9.0	6400 1.500	2.800	4.0	59.0	16.8	6400 2.800
1.550	3.0	47.0	9.3	6400 1.550	2.850	4.0	59.0	17.1	6400 2.850
1.590	3.0	47.0	9.6	6400 1.590	2.900	4.0	59.0	17.4	6400 2.900
1.600	3.0	47.0	9.6	6400 1.600	2.950	4.0	59.0	17.7	6400 2.950
1.650	3.0	47.0	9.9	6400 1.650	3.000	4.0	59.0	18.0	6400 3.000
1.700	3.0	47.0	10.2	6400 1.700					
1.750	3.0	47.0	10.5	6400 1.750					
1.800	3.0	52.0	10.8	6400 1.800					
1.850	3.0	52.0	11.1	6400 1.850					
1.900	3.0	52.0	11.4	6400 1.900					



ExclusiveLine micro-precision drills without coolant ducts

Article no. 6401



Cutting data page 386

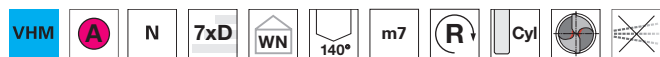

P	M	K	N	S	H
●	●	●	○	○	

Web thinning ≥ Ø 0.500 • facet point grind • main cutting edge form straight • ground cutting edge preparation

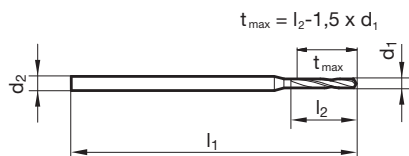

Article no. 6401				Article no. 6401					
d1 mm	d2 h6 mm	l1 mm	l2 mm	Order no.	d1 mm	d2 h6 mm	l1 mm	l2 mm	Order no.
0.500	3.0	47.0	4.0	6401 0.500	1.950	3.0	52.0	17.6	6401 1.950
0.550	3.0	47.0	4.4	6401 0.550	1.980	4.0	63.0	18.0	6401 1.980
0.600	3.0	47.0	4.8	6401 0.600	2.000	4.0	63.0	18.0	6401 2.000
0.650	3.0	47.0	5.2	6401 0.650	2.050	4.0	63.0	18.5	6401 2.050
0.700	3.0	47.0	5.6	6401 0.700	2.100	4.0	63.0	18.9	6401 2.100
0.750	3.0	47.0	6.0	6401 0.750	2.150	4.0	63.0	19.4	6401 2.150
0.800	3.0	47.0	6.4	6401 0.800	2.200	4.0	63.0	19.8	6401 2.200
0.850	3.0	47.0	6.8	6401 0.850	2.250	4.0	63.0	20.3	6401 2.250
0.900	3.0	47.0	7.2	6401 0.900	2.300	4.0	63.0	20.7	6401 2.300
0.950	3.0	47.0	7.6	6401 0.950	2.350	4.0	63.0	21.2	6401 2.350
1.000	3.0	47.0	8.0	6401 1.000	2.380	4.0	63.0	21.6	6401 2.380
1.050	3.0	47.0	8.4	6401 1.050	2.400	4.0	63.0	21.6	6401 2.400
1.100	3.0	47.0	8.8	6401 1.100	2.450	4.0	63.0	22.1	6401 2.450
1.150	3.0	47.0	9.2	6401 1.150	2.500	4.0	63.0	22.5	6401 2.500
1.200	3.0	52.0	10.8	6401 1.200	2.550	4.0	63.0	23.0	6401 2.550
1.250	3.0	52.0	11.3	6401 1.250	2.600	4.0	67.0	23.4	6401 2.600
1.300	3.0	52.0	11.7	6401 1.300	2.650	4.0	67.0	23.9	6401 2.650
1.350	3.0	52.0	12.2	6401 1.350	2.700	4.0	67.0	24.3	6401 2.700
1.400	3.0	52.0	12.6	6401 1.400	2.750	4.0	67.0	24.8	6401 2.750
1.450	3.0	52.0	13.1	6401 1.450	2.780	4.0	67.0	25.2	6401 2.780
1.500	3.0	52.0	13.5	6401 1.500	2.800	4.0	67.0	25.2	6401 2.800
1.550	3.0	52.0	14.0	6401 1.550	2.850	4.0	67.0	25.7	6401 2.850
1.590	3.0	52.0	14.4	6401 1.590	2.900	4.0	67.0	26.1	6401 2.900
1.600	3.0	52.0	14.4	6401 1.600	2.950	4.0	67.0	26.6	6401 2.950
1.650	3.0	52.0	14.9	6401 1.650	3.000	4.0	67.0	27.0	6401 3.000
1.700	3.0	52.0	15.3	6401 1.700					
1.750	3.0	52.0	15.8	6401 1.750					
1.800	3.0	52.0	16.2	6401 1.800					
1.850	3.0	52.0	16.7	6401 1.850					
1.900	3.0	52.0	17.1	6401 1.900					

Micro drills



Micro drills

Micro drills

ExclusiveLine micro-precision drills with coolant ducts

Article no. **6405**



Cutting data page 386

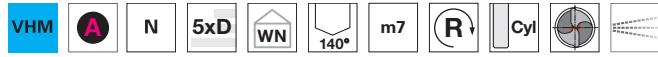

Web thinning $\geq \varnothing 1.000$ • facet point grind • main cutting edge form straight • with main cutting edge preparation

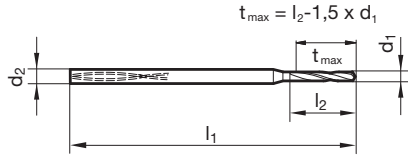

$$t_{max} = l_2 - 1,5 \times d_1$$

Article no.

6405

Article no.

6405

d1 mm	d2 h6 mm	l1 mm	l2 mm	Order no.
1.000	3.0	48.0	8.0	6405 1.000
1.020	3.0	48.0	8.5	6405 1.020
1.050	3.0	48.0	8.5	6405 1.050
1.100	3.0	48.0	9.0	6405 1.100
1.150	3.0	48.0	9.5	6405 1.150
1.180	3.0	48.0	9.5	6405 1.180
1.190	3.0	48.0	10.0	6405 1.190
1.200	3.0	48.0	10.0	6405 1.200
1.250	3.0	48.0	10.0	6405 1.250
1.280	3.0	48.0	10.5	6405 1.280
1.300	3.0	48.0	10.5	6405 1.300
1.350	3.0	48.0	11.0	6405 1.350
1.400	4.0	52.0	11.0	6405 1.400
1.450	4.0	52.0	12.0	6405 1.450
1.500	4.0	52.0	12.0	6405 1.500
1.550	4.0	52.0	12.0	6405 1.550
1.590	4.0	52.0	13.0	6405 1.590
1.600	4.0	52.0	13.0	6405 1.600
1.650	4.0	52.0	13.0	6405 1.650
1.700	4.0	56.0	14.0	6405 1.700
1.750	4.0	56.0	14.0	6405 1.750
1.800	4.0	56.0	14.0	6405 1.800
1.850	4.0	56.0	15.0	6405 1.850
1.900	4.0	56.0	15.0	6405 1.900
1.950	4.0	56.0	16.0	6405 1.950
1.980	4.0	56.0	16.0	6405 1.980
2.000	4.0	56.0	16.0	6405 2.000
2.050	4.0	56.0	16.0	6405 2.050
2.100	4.0	62.0	17.0	6405 2.100
2.150	4.0	62.0	17.0	6405 2.150

d1 mm	d2 h6 mm	l1 mm	l2 mm	Order no.
2.200	4.0	62.0	18.0	6405 2.200
2.250	4.0	62.0	18.0	6405 2.250
2.300	4.0	62.0	18.0	6405 2.300
2.320	4.0	62.0	19.0	6405 2.320
2.350	4.0	62.0	19.0	6405 2.350
2.380	4.0	62.0	19.0	6405 2.380
2.400	4.0	62.0	19.0	6405 2.400
2.450	4.0	62.0	20.0	6405 2.450
2.500	4.0	62.0	20.0	6405 2.500
2.550	4.0	62.0	20.0	6405 2.550
2.600	4.0	66.0	21.0	6405 2.600
2.650	4.0	66.0	21.0	6405 2.650
2.700	4.0	66.0	22.0	6405 2.700
2.750	4.0	66.0	22.0	6405 2.750
2.780	4.0	66.0	22.0	6405 2.780
2.800	4.0	66.0	22.0	6405 2.800
2.850	4.0	66.0	23.0	6405 2.850
2.900	4.0	66.0	23.0	6405 2.900
2.950	4.0	66.0	24.0	6405 2.950
3.000	4.0	66.0	24.0	6405 3.000



ExclusiveLine micro-precision drills with coolant ducts

Article no. 6408



Cutting data page 387

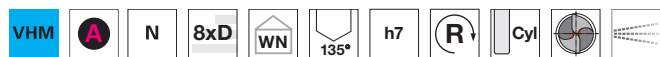

Web thinning $\geq \varnothing 1.000$ • facet point grind • main cutting edge form straight • with main cutting edge preparation

Micro drills

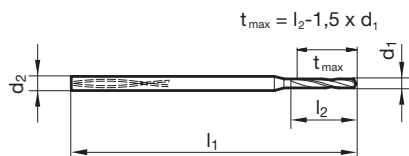

Article no.				6408	Article no.				6408
d1 mm	d2 h6 mm	l1 mm	l2 mm	Order no.	d1 mm	d2 h6 mm	l1 mm	l2 mm	Order no.
1.000	3.0	48.0	11.0	6408 1.000	2.200	4.0	62.0	24.0	6408 2.200
1.020	3.0	48.0	11.5	6408 1.020	2.250	4.0	62.0	25.0	6408 2.250
1.050	3.0	48.0	12.0	6408 1.050	2.300	4.0	62.0	25.0	6408 2.300
1.100	3.0	48.0	12.5	6408 1.100	2.320	4.0	62.0	26.0	6408 2.320
1.150	3.0	48.0	13.0	6408 1.150	2.350	4.0	62.0	26.0	6408 2.350
1.180	3.0	48.0	13.0	6408 1.180	2.380	4.0	62.0	26.0	6408 2.380
1.190	3.0	48.0	13.5	6408 1.190	2.400	4.0	62.0	26.0	6408 2.400
1.200	3.0	48.0	13.5	6408 1.200	2.450	4.0	62.0	27.0	6408 2.450
1.250	3.0	48.0	14.0	6408 1.250	2.500	4.0	62.0	28.0	6408 2.500
1.280	3.0	48.0	14.5	6408 1.280	2.550	4.0	62.0	28.0	6408 2.550
1.300	3.0	48.0	14.5	6408 1.300	2.600	4.0	66.0	29.0	6408 2.600
1.350	3.0	48.0	15.0	6408 1.350	2.650	4.0	66.0	29.0	6408 2.650
1.400	4.0	52.0	15.0	6408 1.400	2.700	4.0	66.0	30.0	6408 2.700
1.450	4.0	52.0	16.0	6408 1.450	2.750	4.0	66.0	30.0	6408 2.750
1.500	4.0	52.0	17.0	6408 1.500	2.780	4.0	66.0	31.0	6408 2.780
1.550	4.0	52.0	17.0	6408 1.550	2.800	4.0	66.0	31.0	6408 2.800
1.590	4.0	52.0	18.0	6408 1.590	2.850	4.0	66.0	31.0	6408 2.850
1.600	4.0	52.0	18.0	6408 1.600	2.900	4.0	66.0	32.0	6408 2.900
1.650	4.0	52.0	18.0	6408 1.650	2.950	4.0	66.0	32.0	6408 2.950
1.700	4.0	56.0	19.0	6408 1.700	3.000	4.0	66.0	33.0	6408 3.000
1.750	4.0	56.0	19.0	6408 1.750					
1.800	4.0	56.0	20.0	6408 1.800					
1.850	4.0	56.0	20.0	6408 1.850					
1.900	4.0	56.0	21.0	6408 1.900					
1.950	4.0	56.0	21.0	6408 1.950					
1.980	4.0	56.0	22.0	6408 1.980					
2.000	4.0	56.0	22.0	6408 2.000					
2.050	4.0	56.0	23.0	6408 2.050					
2.100	4.0	62.0	23.0	6408 2.100					
2.150	4.0	62.0	24.0	6408 2.150					



ExclusiveLine micro-precision drills with coolant ducts

Article no. **6412**



Cutting data page 387



Web thinning $\geq \varnothing 1.000$ • facet point grind • main cutting edge form straight • with main cutting edge preparation

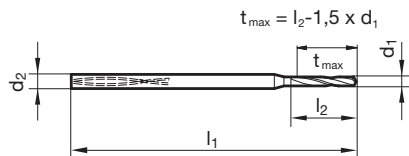

$$t_{max} = l_2 - 1,5 \times d_1$$

Article no.

6412

Article no.

6412

d1 mm	d2 h6 mm	l1 mm	l2 mm	Order no.
1.000	3.0	56.0	18.0	6412 1.000
1.020	3.0	56.0	18.5	6412 1.020
1.050	3.0	56.0	19.0	6412 1.050
1.100	3.0	56.0	20.0	6412 1.100
1.150	3.0	56.0	21.0	6412 1.150
1.180	3.0	56.0	21.5	6412 1.180
1.190	3.0	56.0	21.5	6412 1.190
1.200	3.0	56.0	22.0	6412 1.200
1.250	3.0	56.0	22.5	6412 1.250
1.280	3.0	56.0	23.5	6412 1.280
1.300	3.0	56.0	23.5	6412 1.300
1.350	3.0	56.0	24.5	6412 1.350
1.400	4.0	62.0	25.0	6412 1.400
1.450	4.0	62.0	27.0	6412 1.450
1.500	4.0	62.0	27.0	6412 1.500
1.550	4.0	62.0	29.0	6412 1.550
1.590	4.0	62.0	29.0	6412 1.590
1.600	4.0	62.0	29.0	6412 1.600
1.650	4.0	62.0	29.0	6412 1.650
1.700	4.0	70.0	31.0	6412 1.700
1.750	4.0	70.0	32.0	6412 1.750
1.800	4.0	70.0	32.0	6412 1.800
1.850	4.0	70.0	34.0	6412 1.850
1.900	4.0	70.0	34.0	6412 1.900
1.950	4.0	70.0	36.0	6412 1.950
1.980	4.0	70.0	36.0	6412 1.980
2.000	4.0	70.0	36.0	6412 2.000
2.050	4.0	70.0	36.0	6412 2.050
2.100	4.0	78.0	38.0	6412 2.100
2.150	4.0	78.0	40.0	6412 2.150

d1 mm	d2 h6 mm	l1 mm	l2 mm	Order no.
2.200	4.0	78.0	40.0	6412 2.200
2.250	4.0	78.0	42.0	6412 2.250
2.300	4.0	78.0	42.0	6412 2.300
2.320	4.0	78.0	44.0	6412 2.320
2.350	4.0	78.0	44.0	6412 2.350
2.380	4.0	78.0	44.0	6412 2.380
2.400	4.0	78.0	44.0	6412 2.400
2.450	4.0	78.0	45.0	6412 2.450
2.500	4.0	78.0	45.0	6412 2.500
2.550	4.0	78.0	45.0	6412 2.550
2.600	4.0	87.0	47.0	6412 2.600
2.650	4.0	87.0	48.0	6412 2.650
2.700	4.0	87.0	48.0	6412 2.700
2.750	4.0	87.0	50.0	6412 2.750
2.780	4.0	87.0	50.0	6412 2.780
2.800	4.0	87.0	50.0	6412 2.800
2.850	4.0	87.0	52.0	6412 2.850
2.900	4.0	87.0	52.0	6412 2.900
2.950	4.0	87.0	54.0	6412 2.950
3.000	4.0	87.0	54.0	6412 3.000



ExclusiveLine micro-precision drills VA without coolant ducts

Article no. 6487



Cutting data page 388

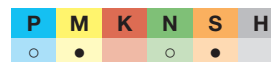
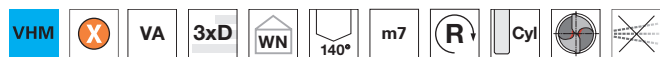

Web thinning $\geq \varnothing 0.500$ • facet point grind • main cutting edge is slightly concave • optimised cutting edge geometry

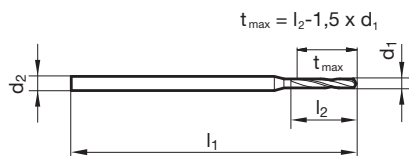

Article no. 6487				Article no. 6487					
d1 mm	d2 h6 mm	l1 mm	l2 mm	Order no.	d1 mm	d2 h6 mm	l1 mm	l2 mm	Order no.
0.500	3.0	38.0	2.8	6487 0.500	1.700	4.0	46.0	9.4	6487 1.700
0.550	3.0	38.0	3.1	6487 0.550	1.750	4.0	46.0	9.7	6487 1.750
0.600	3.0	38.0	3.3	6487 0.600	1.800	4.0	46.0	9.9	6487 1.800
0.650	3.0	38.0	3.6	6487 0.650	1.850	4.0	46.0	10.2	6487 1.850
0.660	3.0	38.0	3.7	6487 0.660	1.900	4.0	46.0	10.5	6487 1.900
0.700	3.0	38.0	3.9	6487 0.700	1.950	4.0	46.0	10.8	6487 1.950
0.740	3.0	38.0	4.1	6487 0.740	1.980	4.0	46.0	10.9	6487 1.980
0.750	3.0	38.0	4.2	6487 0.750	2.000	4.0	46.0	11.0	6487 2.000
0.790	3.0	38.0	4.4	6487 0.790	2.050	4.0	46.0	11.3	6487 2.050
0.800	3.0	38.0	4.4	6487 0.800	2.100	4.0	50.0	11.6	6487 2.100
0.820	3.0	38.0	4.6	6487 0.820	2.150	4.0	50.0	11.9	6487 2.150
0.850	3.0	38.0	4.7	6487 0.850	2.200	4.0	50.0	12.1	6487 2.200
0.900	3.0	38.0	5.0	6487 0.900	2.250	4.0	50.0	12.4	6487 2.250
0.950	3.0	38.0	5.3	6487 0.950	2.300	4.0	50.0	12.7	6487 2.300
1.000	3.0	38.0	5.5	6487 1.000	2.350	4.0	50.0	13.0	6487 2.350
1.020	3.0	38.0	5.7	6487 1.020	2.380	4.0	50.0	13.1	6487 2.380
1.050	3.0	38.0	5.8	6487 1.050	2.400	4.0	50.0	13.2	6487 2.400
1.100	3.0	38.0	6.1	6487 1.100	2.450	4.0	50.0	13.5	6487 2.450
1.150	3.0	38.0	6.4	6487 1.150	2.500	4.0	50.0	13.8	6487 2.500
1.180	3.0	38.0	6.5	6487 1.180	2.550	4.0	50.0	14.1	6487 2.550
1.190	3.0	38.0	6.6	6487 1.190	2.600	4.0	50.0	14.3	6487 2.600
1.200	3.0	38.0	6.6	6487 1.200	2.650	4.0	50.0	14.6	6487 2.650
1.250	3.0	38.0	6.9	6487 1.250	2.700	4.0	50.0	14.9	6487 2.700
1.280	3.0	38.0	7.1	6487 1.280	2.750	4.0	50.0	15.2	6487 2.750
1.300	3.0	38.0	7.2	6487 1.300	2.780	4.0	50.0	15.3	6487 2.780
1.350	3.0	38.0	7.5	6487 1.350	2.800	4.0	50.0	15.4	6487 2.800
1.400	4.0	46.0	7.7	6487 1.400	2.850	4.0	50.0	15.7	6487 2.850
1.450	4.0	46.0	8.0	6487 1.450	2.900	4.0	50.0	16.0	6487 2.900
1.460	4.0	46.0	8.1	6487 1.460	2.950	4.0	50.0	16.3	6487 2.950
1.500	4.0	46.0	8.3	6487 1.500	3.000	4.0	50.0	16.5	6487 3.000
1.550	4.0	46.0	8.6	6487 1.550					
1.560	4.0	46.0	8.6	6487 1.560					
1.590	4.0	46.0	8.8	6487 1.590					
1.600	4.0	46.0	8.8	6487 1.600					
1.650	4.0	46.0	9.1	6487 1.650					
1.660	4.0	46.0	9.2	6487 1.660					



ExclusiveLine micro-precision drills VA with coolant ducts

Article no. **6488**



Cutting data page 389

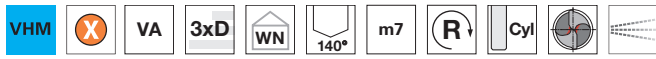

Web thinning $\geq \varnothing 1.000$ • facet point grind • main cutting edge is slightly concave • optimised cutting edge geometry

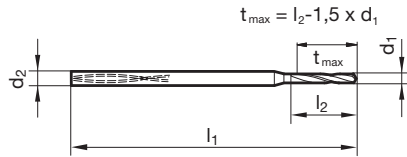

Article no.				6488				Article no.				6488			
d1 mm	d2 h6 mm	l1 mm	l2 mm	Order no.	d1 mm	d2 h6 mm	l1 mm	l2 mm	Order no.	d1 mm	d2 h6 mm	l1 mm	l2 mm	Order no.	
1.000	3.0	38.0	5.5	6488 1.000	2.050	4.0	46.0	11.3	6488 2.050						
1.020	3.0	38.0	5.7	6488 1.020	2.100	4.0	50.0	11.6	6488 2.100						
1.050	3.0	38.0	5.8	6488 1.050	2.150	4.0	50.0	11.9	6488 2.150						
1.100	3.0	38.0	6.1	6488 1.100	2.200	4.0	50.0	12.1	6488 2.200						
1.150	3.0	38.0	6.4	6488 1.150	2.250	4.0	50.0	12.4	6488 2.250						
1.180	3.0	38.0	6.5	6488 1.180	2.300	4.0	50.0	12.7	6488 2.300						
1.190	3.0	38.0	6.6	6488 1.190	2.350	4.0	50.0	13.0	6488 2.350						
1.200	3.0	38.0	6.6	6488 1.200	2.380	4.0	50.0	13.1	6488 2.380						
1.250	3.0	38.0	6.9	6488 1.250	2.400	4.0	50.0	13.2	6488 2.400						
1.280	3.0	38.0	7.1	6488 1.280	2.450	4.0	50.0	13.5	6488 2.450						
1.300	3.0	38.0	7.2	6488 1.300	2.500	4.0	50.0	13.8	6488 2.500						
1.350	3.0	38.0	7.5	6488 1.350	2.550	4.0	50.0	14.1	6488 2.550						
1.400	4.0	46.0	7.7	6488 1.400	2.600	4.0	50.0	14.3	6488 2.600						
1.450	4.0	46.0	8.0	6488 1.450	2.650	4.0	50.0	14.6	6488 2.650						
1.460	4.0	46.0	8.1	6488 1.460	2.700	4.0	50.0	14.9	6488 2.700						
1.500	4.0	46.0	8.3	6488 1.500	2.750	4.0	50.0	15.2	6488 2.750						
1.550	4.0	46.0	8.6	6488 1.550	2.780	4.0	50.0	15.3	6488 2.780						
1.560	4.0	46.0	8.6	6488 1.560	2.800	4.0	50.0	15.4	6488 2.800						
1.590	4.0	46.0	8.8	6488 1.590	2.850	4.0	50.0	15.7	6488 2.850						
1.600	4.0	46.0	8.8	6488 1.600	2.900	4.0	50.0	16.0	6488 2.900						
1.650	4.0	46.0	9.1	6488 1.650	2.950	4.0	50.0	16.3	6488 2.950						
1.660	4.0	46.0	9.2	6488 1.660	3.000	4.0	50.0	16.5	6488 3.000						
1.700	4.0	46.0	9.4	6488 1.700											
1.750	4.0	46.0	9.7	6488 1.750											
1.800	4.0	46.0	9.9	6488 1.800											
1.850	4.0	46.0	10.2	6488 1.850											
1.900	4.0	46.0	10.5	6488 1.900											
1.950	4.0	46.0	10.8	6488 1.950											
1.980	4.0	46.0	10.9	6488 1.980											
2.000	4.0	46.0	11.0	6488 2.000											



ExclusiveLine micro-precision drills VA with coolant ducts

Article no. 6489



Cutting data page 389

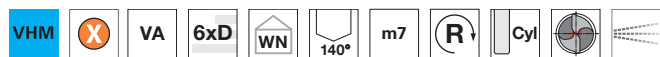

P	M	K	N	S	H
○	●	○	●	○	●

Web thinning ≥ Ø 1.000 • facet point grind • main cutting edge is slightly concave • optimised cutting edge geometry

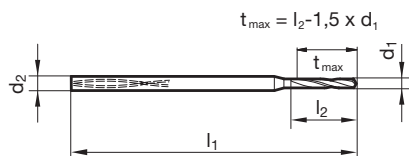

Article no. 6489				Article no. 6489					
d1 mm	d2 h6 mm	l1 mm	l2 mm	Order no.	d1 mm	d2 h6 mm	l1 mm	l2 mm	Order no.
1.000	3.0	48.0	9.0	6489 1.000	2.050	4.0	61.0	18.5	6489 2.050
1.050	3.0	48.0	9.5	6489 1.050	2.100	4.0	66.0	18.9	6489 2.100
1.100	3.0	48.0	9.9	6489 1.100	2.150	4.0	66.0	19.4	6489 2.150
1.150	3.0	48.0	10.4	6489 1.150	2.200	4.0	66.0	19.8	6489 2.200
1.190	3.0	48.0	10.8	6489 1.190	2.250	4.0	66.0	20.3	6489 2.250
1.200	3.0	51.0	10.8	6489 1.200	2.300	4.0	66.0	20.7	6489 2.300
1.250	3.0	51.0	11.3	6489 1.250	2.350	4.0	66.0	21.2	6489 2.350
1.300	3.0	51.0	11.7	6489 1.300	2.380	4.0	66.0	21.5	6489 2.380
1.350	3.0	51.0	12.2	6489 1.350	2.400	4.0	66.0	21.6	6489 2.400
1.400	4.0	56.0	12.6	6489 1.400	2.450	4.0	66.0	22.1	6489 2.450
1.450	4.0	56.0	13.1	6489 1.450	2.500	4.0	66.0	22.5	6489 2.500
1.500	4.0	56.0	13.5	6489 1.500	2.550	4.0	66.0	23.0	6489 2.550
1.550	4.0	56.0	14.0	6489 1.550	2.600	4.0	71.0	23.4	6489 2.600
1.590	4.0	56.0	14.4	6489 1.590	2.650	4.0	71.0	23.9	6489 2.650
1.600	4.0	56.0	14.4	6489 1.600	2.700	4.0	71.0	24.3	6489 2.700
1.650	4.0	56.0	14.9	6489 1.650	2.750	4.0	71.0	24.8	6489 2.750
1.700	4.0	61.0	15.3	6489 1.700	2.780	4.0	71.0	25.1	6489 2.780
1.750	4.0	61.0	15.8	6489 1.750	2.800	4.0	71.0	25.2	6489 2.800
1.800	4.0	61.0	16.2	6489 1.800	2.850	4.0	71.0	25.7	6489 2.850
1.850	4.0	61.0	16.7	6489 1.850	2.900	4.0	71.0	26.1	6489 2.900
1.900	4.0	61.0	17.1	6489 1.900	2.950	4.0	71.0	26.6	6489 2.950
1.950	4.0	61.0	17.6	6489 1.950	3.000	4.0	71.0	27.0	6489 3.000
1.980	4.0	61.0	17.9	6489 1.980					
2.000	4.0	61.0	18.0	6489 2.000					



Micro drills

Micro drills

ExclusiveLine micro-precision drills VA with coolant ducts

Article no. **6490**



Cutting data page 390

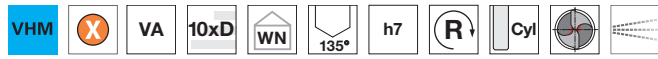

Web thinning $\geq \varnothing 1.000$ • facet point grind • main cutting edge is slightly concave • optimised cutting edge geometry

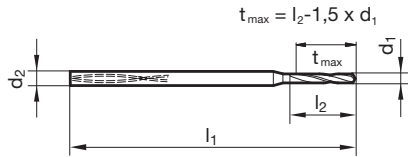

$$t_{max} = l_2 - 1,5 \times d_1$$

Article no.

6490

Article no.

6490

d1 mm	d2 h6 mm	l1 mm	l2 mm	Order no.
1.000	3.0	48.0	13.0	6490 1.000
1.050	3.0	48.0	13.7	6490 1.050
1.100	3.0	48.0	14.3	6490 1.100
1.150	3.0	48.0	15.0	6490 1.150
1.190	3.0	48.0	15.5	6490 1.190
1.200	3.0	51.0	15.6	6490 1.200
1.250	3.0	51.0	16.3	6490 1.250
1.300	3.0	51.0	16.9	6490 1.300
1.350	3.0	51.0	17.6	6490 1.350
1.400	4.0	56.0	18.2	6490 1.400
1.450	4.0	56.0	18.9	6490 1.450
1.500	4.0	56.0	19.5	6490 1.500
1.550	4.0	56.0	20.2	6490 1.550
1.590	4.0	56.0	20.7	6490 1.590
1.600	4.0	56.0	20.8	6490 1.600
1.650	4.0	56.0	21.5	6490 1.650
1.700	4.0	61.0	22.1	6490 1.700
1.750	4.0	61.0	22.8	6490 1.750
1.800	4.0	61.0	23.4	6490 1.800
1.850	4.0	61.0	24.1	6490 1.850
1.900	4.0	61.0	24.7	6490 1.900
1.950	4.0	61.0	25.4	6490 1.950
1.980	4.0	61.0	25.8	6490 1.980
2.000	4.0	61.0	26.0	6490 2.000

d1 mm	d2 h6 mm	l1 mm	l2 mm	Order no.
2.050	4.0	61.0	26.7	6490 2.050
2.100	4.0	66.0	27.3	6490 2.100
2.150	4.0	66.0	28.0	6490 2.150
2.200	4.0	66.0	28.6	6490 2.200
2.250	4.0	66.0	29.3	6490 2.250
2.300	4.0	66.0	29.9	6490 2.300
2.350	4.0	66.0	30.6	6490 2.350
2.380	4.0	66.0	31.0	6490 2.380
2.400	4.0	66.0	31.2	6490 2.400
2.450	4.0	66.0	31.9	6490 2.450
2.500	4.0	66.0	32.5	6490 2.500
2.550	4.0	66.0	33.2	6490 2.550
2.600	4.0	71.0	33.8	6490 2.600
2.650	4.0	71.0	34.5	6490 2.650
2.700	4.0	71.0	35.1	6490 2.700
2.750	4.0	71.0	35.8	6490 2.750
2.780	4.0	71.0	36.2	6490 2.780
2.800	4.0	71.0	36.4	6490 2.800
2.850	4.0	71.0	37.1	6490 2.850
2.900	4.0	71.0	37.7	6490 2.900
2.950	4.0	71.0	38.4	6490 2.950
3.000	4.0	71.0	39.0	6490 3.000



ExclusiveLine micro-precision drills VA with coolant ducts

Article no. 6491



Cutting data page 390

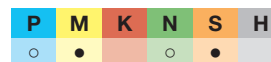
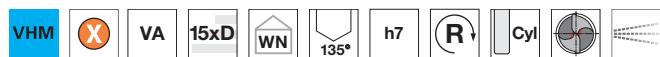

Web thinning $\geq \varnothing 1.000$ • facet point grind • main cutting edge is slightly concave • optimised cutting edge geometry

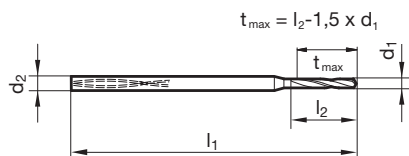

Article no. 6491				Article no. 6491					
d1 mm	d2 h6 mm	l1 mm	l2 mm	Order no.	d1 mm	d2 h6 mm	l1 mm	l2 mm	Order no.
1.000	3.0	54.0	18.0	6491 1.000	2.050	4.0	71.0	36.9	6491 2.050
1.050	3.0	54.0	18.9	6491 1.050	2.100	4.0	79.0	37.8	6491 2.100
1.100	3.0	54.0	19.8	6491 1.100	2.150	4.0	79.0	38.7	6491 2.150
1.150	3.0	54.0	20.7	6491 1.150	2.200	4.0	79.0	39.6	6491 2.200
1.190	3.0	54.0	21.5	6491 1.190	2.250	4.0	79.0	40.5	6491 2.250
1.200	3.0	58.0	21.6	6491 1.200	2.300	4.0	79.0	41.4	6491 2.300
1.250	3.0	58.0	22.5	6491 1.250	2.350	4.0	79.0	42.3	6491 2.350
1.300	3.0	58.0	23.4	6491 1.300	2.380	4.0	79.0	42.9	6491 2.380
1.350	3.0	58.0	24.3	6491 1.350	2.400	4.0	79.0	43.2	6491 2.400
1.400	4.0	64.0	25.2	6491 1.400	2.450	4.0	79.0	44.1	6491 2.450
1.450	4.0	64.0	26.1	6491 1.450	2.500	4.0	79.0	45.0	6491 2.500
1.500	4.0	64.0	27.0	6491 1.500	2.550	4.0	79.0	45.9	6491 2.550
1.550	4.0	64.0	27.9	6491 1.550	2.600	4.0	87.0	46.8	6491 2.600
1.590	4.0	64.0	28.7	6491 1.590	2.650	4.0	87.0	47.7	6491 2.650
1.600	4.0	64.0	28.8	6491 1.600	2.700	4.0	87.0	48.6	6491 2.700
1.650	4.0	64.0	29.7	6491 1.650	2.750	4.0	87.0	49.5	6491 2.750
1.700	4.0	71.0	30.6	6491 1.700	2.780	4.0	87.0	50.1	6491 2.780
1.750	4.0	71.0	31.5	6491 1.750	2.800	4.0	87.0	50.4	6491 2.800
1.800	4.0	71.0	32.4	6491 1.800	2.850	4.0	87.0	51.3	6491 2.850
1.850	4.0	71.0	33.3	6491 1.850	2.900	4.0	87.0	52.2	6491 2.900
1.900	4.0	71.0	34.2	6491 1.900	2.950	4.0	87.0	53.1	6491 2.950
1.950	4.0	71.0	35.1	6491 1.950	3.000	4.0	87.0	54.0	6491 3.000
1.980	4.0	71.0	35.7	6491 1.980					
2.000	4.0	71.0	36.0	6491 2.000					

Micro drills



ExclusiveLine micro-precision drills XL with coolant ducts

Article no. **6493**



Cutting data page 391

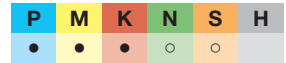

facet point grind • main cutting edge form straight • with main cutting edge preparation

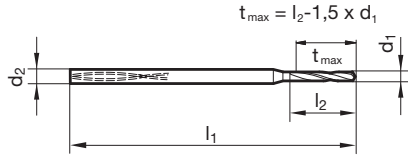

Article no. **6493**

Article no. **6493**

d1 mm	d2 h6 mm	l1 mm	l2 mm	Order no.
1.000	3.0	59.0	23.0	6493 1.000
1.050	3.0	59.0	24.2	6493 1.050
1.100	3.0	59.0	25.3	6493 1.100
1.150	3.0	63.0	26.5	6493 1.150
1.190	3.0	63.0	27.4	6493 1.190
1.200	3.0	63.0	27.6	6493 1.200
1.250	3.0	63.0	28.8	6493 1.250
1.300	3.0	68.0	29.9	6493 1.300
1.350	3.0	68.0	31.1	6493 1.350
1.400	4.0	70.0	32.2	6493 1.400
1.450	4.0	70.0	33.4	6493 1.450
1.500	4.0	70.0	34.5	6493 1.500
1.550	4.0	70.0	35.7	6493 1.550
1.590	4.0	70.0	36.6	6493 1.590
1.600	4.0	70.0	36.8	6493 1.600
1.650	4.0	70.0	38.0	6493 1.650
1.700	4.0	79.0	39.4	6493 1.700
1.750	4.0	79.0	40.3	6493 1.750
1.800	4.0	79.0	41.4	6493 1.800
1.850	4.0	79.0	42.6	6493 1.850
1.900	4.0	79.0	43.7	6493 1.900
1.950	4.0	79.0	44.9	6493 1.950
1.980	4.0	79.0	45.6	6493 1.980
2.000	4.0	79.0	46.0	6493 2.000

d1 mm	d2 h6 mm	l1 mm	l2 mm	Order no.
2.050	4.0	79.0	47.2	6493 2.050
2.100	4.0	91.0	48.3	6493 2.100
2.150	4.0	91.0	49.5	6493 2.150
2.200	4.0	91.0	50.6	6493 2.200
2.250	4.0	91.0	51.8	6493 2.250
2.300	4.0	91.0	52.9	6493 2.300
2.320	4.0	91.0	54.1	6493 2.320
2.350	4.0	91.0	54.1	6493 2.350
2.380	4.0	91.0	54.8	6493 2.380
2.400	4.0	91.0	55.2	6493 2.400
2.450	4.0	91.0	56.4	6493 2.450
2.500	4.0	91.0	57.5	6493 2.500
2.550	4.0	91.0	58.7	6493 2.550
2.600	4.0	102.0	59.8	6493 2.600
2.650	4.0	102.0	61.0	6493 2.650
2.700	4.0	102.0	62.1	6493 2.700
2.750	4.0	102.0	63.3	6493 2.750
2.780	4.0	102.0	64.0	6493 2.780
2.800	4.0	102.0	64.4	6493 2.800
2.850	4.0	102.0	65.6	6493 2.850
2.900	4.0	102.0	66.7	6493 2.900
2.950	4.0	102.0	67.9	6493 2.950
3.000	4.0	102.0	69.0	6493 3.000



Solid carbide micro-precision drills without coolant ducts

Article no. 701

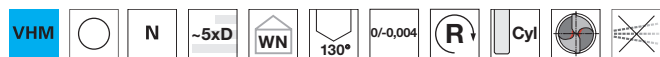

Web thinning ≥ Ø 0.800 • facet point grind • main cutting edge form straight

Cutting data page 392

P	M	K	N	S	H
○	●	○	●	○	○

Micro drills

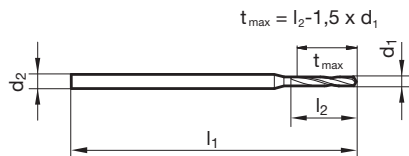

Article no. 701				Article no. 701					
d1 mm	d2 mm	l1 mm	l2 mm	Order no.	d1 mm	d2 mm	l1 mm	l2 mm	Order no.
0.200	1.0	25.0	1.5	701 0.200	1.380	1.5	25.0	9.5	701 1.380
0.210	1.0	25.0	1.5	701 0.210	1.400	1.5	25.0	9.5	701 1.400
0.220	1.0	25.0	1.5	701 0.220	1.450	1.5	25.0	9.5	701 1.450
0.240	1.0	25.0	1.5	701 0.240	1.500	3.0	38.0	9.5	701 1.500
0.250	1.0	25.0	1.9	701 0.250	1.550	3.0	38.0	10.6	701 1.550
0.260	1.0	25.0	1.9	701 0.260	1.600	3.0	38.0	10.6	701 1.600
0.280	1.0	25.0	1.9	701 0.280	1.650	3.0	38.0	10.6	701 1.650
0.300	1.0	25.0	1.9	701 0.300	1.700	3.0	38.0	10.6	701 1.700
0.330	1.0	25.0	2.4	701 0.330	1.750	3.0	38.0	11.8	701 1.750
0.350	1.0	25.0	2.4	701 0.350	1.800	3.0	38.0	11.8	701 1.800
0.380	1.0	25.0	2.4	701 0.380	1.850	3.0	38.0	11.8	701 1.850
0.400	1.0	25.0	3.0	701 0.400	1.900	3.0	38.0	11.8	701 1.900
0.440	1.0	25.0	3.0	701 0.440	1.950	3.0	38.0	13.2	701 1.950
0.450	1.0	25.0	3.0	701 0.450	2.000	3.0	38.0	13.2	701 2.000
0.460	1.0	25.0	3.0	701 0.460	2.050	3.0	38.0	13.2	701 2.050
0.500	1.0	25.0	3.4	701 0.500	2.100	3.0	38.0	13.2	701 2.100
0.550	1.0	25.0	3.9	701 0.550	2.150	3.0	38.0	14.0	701 2.150
0.600	1.0	25.0	3.9	701 0.600	2.200	3.0	38.0	14.0	701 2.200
0.650	1.0	25.0	4.2	701 0.650	2.250	3.0	38.0	14.0	701 2.250
0.680	1.0	25.0	4.8	701 0.680	2.300	3.0	38.0	14.0	701 2.300
0.700	1.0	25.0	4.8	701 0.700	2.350	3.0	38.0	14.0	701 2.350
0.750	1.0	25.0	4.8	701 0.750	2.380	3.0	38.0	15.0	701 2.380
0.800	1.5	25.0	5.3	701 0.800	2.400	3.0	38.0	15.0	701 2.400
0.810	1.5	25.0	5.3	701 0.810	2.450	3.0	38.0	15.0	701 2.450
0.830	1.5	25.0	5.3	701 0.830	2.500	3.0	38.0	15.0	701 2.500
0.850	1.5	25.0	5.3	701 0.850	2.550	3.0	38.0	15.0	701 2.550
0.900	1.5	25.0	6.0	701 0.900	2.600	3.0	38.0	15.0	701 2.600
0.950	1.5	25.0	6.0	701 0.950	2.650	3.0	38.0	15.0	701 2.650
1.000	1.5	25.0	6.8	701 1.000	2.700	3.0	38.0	15.0	701 2.700
1.050	1.5	25.0	6.8	701 1.050	2.750	3.0	38.0	15.0	701 2.750
1.100	1.5	25.0	7.6	701 1.100	2.800	3.0	38.0	15.0	701 2.800
1.150	1.5	25.0	7.6	701 1.150	2.850	3.0	38.0	15.0	701 2.850
1.200	1.5	25.0	8.5	701 1.200	2.900	3.0	38.0	15.0	701 2.900
1.250	1.5	25.0	8.5	701 1.250	2.950	3.0	38.0	15.0	701 2.950
1.300	1.5	25.0	8.5	701 1.300	3.000	4.0	40.0	15.0	701 3.000
1.350	1.5	25.0	9.5	701 1.350					



Solid carbide micro-precision drills without coolant ducts

Article no. **3899**



Web thinning $\geq \varnothing 0.800$ • facet point grind

Cutting data page 393

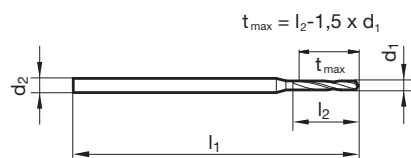

Article no.				3899				Article no.				3899			
d1 mm	d2 mm	l1 mm	l2 mm	Order no.				d1 mm	d2 mm	l1 mm	l2 mm	Order no.			
0.100	3.0	38.0	1.2	3899 0.100				0.760	3.0	38.0	8.0	3899 0.760			
0.110	3.0	38.0	1.2	3899 0.110				0.770	3.0	38.0	8.0	3899 0.770			
0.120	3.0	38.0	1.4	3899 0.120				0.780	3.0	38.0	8.0	3899 0.780			
0.130	3.0	38.0	1.4	3899 0.130				0.790	3.0	38.0	8.0	3899 0.790			
0.140	3.0	38.0	1.4	3899 0.140				0.800	3.0	38.0	10.0	3899 0.800			
0.150	3.0	38.0	2.0	3899 0.150				0.810	3.0	38.0	10.0	3899 0.810			
0.160	3.0	38.0	2.0	3899 0.160				0.820	3.0	38.0	10.0	3899 0.820			
0.170	3.0	38.0	2.0	3899 0.170				0.830	3.0	38.0	10.0	3899 0.830			
0.180	3.0	38.0	2.0	3899 0.180				0.840	3.0	38.0	10.0	3899 0.840			
0.190	3.0	38.0	2.0	3899 0.190				0.850	3.0	38.0	10.0	3899 0.850			
0.200	3.0	38.0	2.5	3899 0.200				0.860	3.0	38.0	10.0	3899 0.860			
0.210	3.0	38.0	2.5	3899 0.210				0.870	3.0	38.0	10.0	3899 0.870			
0.220	3.0	38.0	2.5	3899 0.220				0.880	3.0	38.0	10.0	3899 0.880			
0.230	3.0	38.0	2.5	3899 0.230				0.890	3.0	38.0	10.0	3899 0.890			
0.240	3.0	38.0	2.5	3899 0.240				0.900	3.0	38.0	10.0	3899 0.900			
0.250	3.0	38.0	3.0	3899 0.250				0.910	3.0	38.0	10.0	3899 0.910			
0.260	3.0	38.0	3.0	3899 0.260				0.920	3.0	38.0	10.0	3899 0.920			
0.270	3.0	38.0	3.0	3899 0.270				0.930	3.0	38.0	10.0	3899 0.930			
0.280	3.0	38.0	3.0	3899 0.280				0.940	3.0	38.0	10.0	3899 0.940			
0.290	3.0	38.0	3.0	3899 0.290				0.950	3.0	38.0	10.0	3899 0.950			
0.300	3.0	38.0	5.0	3899 0.300				0.960	3.0	38.0	10.0	3899 0.960			
0.310	3.0	38.0	5.0	3899 0.310				0.970	3.0	38.0	10.0	3899 0.970			
0.320	3.0	38.0	5.0	3899 0.320				0.980	3.0	38.0	10.0	3899 0.980			
0.330	3.0	38.0	5.0	3899 0.330				0.990	3.0	38.0	10.0	3899 0.990			
0.340	3.0	38.0	5.0	3899 0.340				1.000	3.0	38.0	10.0	3899 1.000			
0.350	3.0	38.0	6.0	3899 0.350				1.010	3.0	38.0	10.0	3899 1.010			
0.360	3.0	38.0	6.0	3899 0.360				1.020	3.0	38.0	10.0	3899 1.020			
0.370	3.0	38.0	6.0	3899 0.370				1.030	3.0	38.0	10.0	3899 1.030			
0.380	3.0	38.0	6.0	3899 0.380				1.040	3.0	38.0	10.0	3899 1.040			
0.390	3.0	38.0	6.0	3899 0.390				1.050	3.0	38.0	10.0	3899 1.050			
0.400	3.0	38.0	7.0	3899 0.400				1.060	3.0	38.0	10.0	3899 1.060			
0.410	3.0	38.0	7.0	3899 0.410				1.070	3.0	38.0	10.0	3899 1.070			
0.420	3.0	38.0	7.0	3899 0.420				1.080	3.0	38.0	10.0	3899 1.080			
0.430	3.0	38.0	7.0	3899 0.430				1.090	3.0	38.0	10.0	3899 1.090			
0.440	3.0	38.0	7.0	3899 0.440				1.100	3.0	38.0	10.0	3899 1.100			
0.450	3.0	38.0	7.0	3899 0.450				1.110	3.0	38.0	10.0	3899 1.110			
0.460	3.0	38.0	7.0	3899 0.460				1.120	3.0	38.0	10.0	3899 1.120			
0.470	3.0	38.0	7.0	3899 0.470				1.130	3.0	38.0	10.0	3899 1.130			
0.480	3.0	38.0	7.0	3899 0.480				1.140	3.0	38.0	10.0	3899 1.140			
0.490	3.0	38.0	7.0	3899 0.490				1.150	3.0	38.0	10.0	3899 1.150			
0.500	3.0	38.0	7.0	3899 0.500				1.160	3.0	38.0	10.0	3899 1.160			
0.510	3.0	38.0	7.0	3899 0.510				1.170	3.0	38.0	10.0	3899 1.170			
0.520	3.0	38.0	7.0	3899 0.520				1.180	3.0	38.0	10.0	3899 1.180			
0.530	3.0	38.0	7.0	3899 0.530				1.190	3.0	38.0	10.0	3899 1.190			
0.540	3.0	38.0	7.0	3899 0.540				1.200	3.0	38.0	10.0	3899 1.200			
0.550	3.0	38.0	7.0	3899 0.550				1.210	3.0	38.0	10.0	3899 1.210			
0.560	3.0	38.0	7.0	3899 0.560				1.220	3.0	38.0	10.0	3899 1.220			
0.570	3.0	38.0	7.0	3899 0.570				1.230	3.0	38.0	10.0	3899 1.230			
0.580	3.0	38.0	7.0	3899 0.580				1.240	3.0	38.0	10.0	3899 1.240			
0.590	3.0	38.0	7.0	3899 0.590				1.250	3.0	38.0	10.0	3899 1.250			
0.600	3.0	38.0	7.0	3899 0.600				1.260	3.0	38.0	10.0	3899 1.260			
0.610	3.0	38.0	7.0	3899 0.610				1.270	3.0	38.0	10.0	3899 1.270			
0.620	3.0	38.0	7.0	3899 0.620				1.280	3.0	38.0	10.0	3899 1.280			
0.630	3.0	38.0	7.0	3899 0.630				1.290	3.0	38.0	10.0	3899 1.290			
0.640	3.0	38.0	7.0	3899 0.640				1.300	3.0	38.0	10.0	3899 1.300			
0.650	3.0	38.0	7.0	3899 0.650				1.310	3.0	38.0	10.0	3899 1.310			
0.660	3.0	38.0	7.0	3899 0.660				1.320	3.0	38.0	10.0	3899 1.320			
0.670	3.0	38.0	7.0	3899 0.670				1.330	3.0	38.0	10.0	3899 1.330			
0.680	3.0	38.0	7.0	3899 0.680				1.340	3.0	38.0	10.0	3899 1.340			
0.690	3.0	38.0	7.0	3899 0.690				1.350	3.0	38.0	10.0	3899 1.350			
0.700	3.0	38.0	8.0	3899 0.700				1.360	3.0	38.0	10.0	3899 1.360			
0.710	3.0	38.0	8.0	3899 0.710				1.370	3.0	38.0	10.0	3899 1.370			
0.720	3.0	38.0	8.0	3899 0.720				1.380	3.0	38.0	10.0	3899 1.380			
0.730	3.0	38.0	8.0	3899 0.730				1.390	3.0	38.0	10.0	3899 1.390			
0.740	3.0	38.0	8.0	3899 0.740				1.400	3.0	38.0	10.0	3899 1.400			
0.750	3.0	38.0	8.0	3899 0.750				1.410	3.0	38.0	10.0	3899 1.410			



Micro drills

Micro drills

HSS-E-PM micro-precision drills without coolant ducts

Article no. **301**



< Ø 0.15 mm Co-alloyed high speed steel • facet point grind • with re-inforced shank

Cutting data page 394

P	M	K	N	S	H
●	●	●	●	○	

HSS-E-PM micro-precision drills without coolant ducts

Article no. **660**



facet point grind • with re-inforced shank • increased wear resistance

Cutting data page 394

P	M	K	N	S	H
●	●	●	●	○	

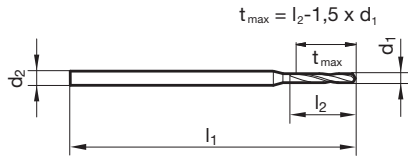

Article no.

301 **660**

Article no.

301 **660**

d1 mm	d2 mm	l1 mm	l2 mm	Order no.	d1 mm	d2 mm	l1 mm	l2 mm	Order no.	d1 mm	d2 mm	l1 mm	l2 mm	Order no.
0.050	1.0	25.0	0.4	301 0.050	0.340	1.0	25.0	2.4	301 0.340	660 0.340				
0.060	1.0	25.0	0.4	301 0.060	0.345	1.0	25.0	2.4	301 0.345					
0.070	1.0	25.0	0.5	301 0.070	0.350	1.0	25.0	2.4	301 0.350	660 0.350				
0.075	1.0	25.0	0.5	301 0.075	0.355	1.0	25.0	2.4	301 0.355					
0.080	1.0	25.0	0.5	301 0.080	0.360	1.0	25.0	2.4	301 0.360	660 0.360				
0.090	1.0	25.0	0.5	301 0.090	0.365	1.0	25.0	2.4	301 0.365					
0.100	1.0	25.0	0.5	301 0.100	0.370	1.0	25.0	2.4	301 0.370	660 0.370				
0.105	1.0	25.0	0.5	301 0.105	0.375	1.0	25.0	2.4	301 0.375					
0.110	1.0	25.0	0.5	301 0.110	0.380	1.0	25.0	2.4	301 0.380	660 0.380				
0.115	1.0	25.0	0.5	301 0.115	0.385	1.0	25.0	3.0	301 0.385					
0.120	1.0	25.0	0.5	301 0.120	0.390	1.0	25.0	3.0	301 0.390	660 0.390				
0.125	1.0	25.0	0.8	301 0.125	0.400	1.0	25.0	3.0	301 0.400	660 0.400				
0.128	1.0	25.0	0.8	301 0.128	0.405	1.0	25.0	3.0	301 0.405					
0.130	1.0	25.0	0.8	301 0.130	0.410	1.0	25.0	3.0	301 0.410	660 0.410				
0.140	1.0	25.0	0.8	301 0.140	0.415	1.0	25.0	3.0	301 0.415					
0.143	1.0	25.0	0.8	301 0.143	0.420	1.0	25.0	3.0	301 0.420	660 0.420				
0.145	1.0	25.0	0.8	301 0.145	0.425	1.0	25.0	3.0	301 0.425					
0.147	1.0	25.0	0.8	301 0.147	0.430	1.0	25.0	3.0	301 0.430	660 0.430				
0.150	1.0	25.0	0.8	301 0.150	0.432	1.0	25.0	3.0	301 0.432					
0.155	1.0	25.0	1.1	301 0.155	0.435	1.0	25.0	3.0	301 0.435					
0.160	1.0	25.0	1.1	301 0.160	0.440	1.0	25.0	3.0	301 0.440	660 0.440				
0.170	1.0	25.0	1.1	301 0.170	0.445	1.0	25.0	3.0	301 0.445					
0.175	1.0	25.0	1.1	301 0.175	0.450	1.0	25.0	3.0	301 0.450	660 0.450				
0.180	1.0	25.0	1.1	301 0.180	0.455	1.0	25.0	3.0	301 0.455					
0.190	1.0	25.0	1.1	301 0.190	0.460	1.0	25.0	3.0	301 0.460	660 0.460				
0.195	1.0	25.0	1.5	301 0.195	0.470	1.0	25.0	3.0	301 0.470	660 0.470				
0.200	1.0	25.0	1.5	301 0.200	0.475	1.0	25.0	3.0	301 0.475					
0.205	1.0	25.0	1.5	301 0.205	0.480	1.0	25.0	3.0	301 0.480	660 0.480				
0.210	1.0	25.0	1.5	301 0.210	0.485	1.0	25.0	3.4	301 0.485					
0.215	1.0	25.0	1.5	301 0.215	0.490	1.0	25.0	3.4	301 0.490	660 0.490				
0.220	1.0	25.0	1.5	301 0.220	0.495	1.0	25.0	3.4	301 0.495					
0.225	1.0	25.0	1.5	301 0.225	0.500	1.0	25.0	3.4	301 0.500	660 0.500				
0.230	1.0	25.0	1.5	301 0.230	0.505	1.0	25.0	3.4	301 0.505					
0.235	1.0	25.0	1.5	301 0.235	0.510	1.0	25.0	3.4	301 0.510	660 0.510				
0.240	1.0	25.0	1.5	301 0.240	0.515	1.0	25.0	3.4	301 0.515					
0.245	1.0	25.0	1.9	301 0.245	0.520	1.0	25.0	3.4	301 0.520	660 0.520				
0.250	1.0	25.0	1.9	301 0.250	0.525	1.0	25.0	3.4	301 0.525					
0.255	1.0	25.0	1.9	301 0.255	0.530	1.0	25.0	3.4	301 0.530	660 0.530				
0.260	1.0	25.0	1.9	301 0.260	0.535	1.0	25.0	3.9	301 0.535					
0.265	1.0	25.0	1.9	301 0.265	0.540	1.0	25.0	3.9	301 0.540	660 0.540				
0.270	1.0	25.0	1.9	301 0.270	0.545	1.0	25.0	3.9	301 0.545					
0.275	1.0	25.0	1.9	301 0.275	0.550	1.0	25.0	3.9	301 0.550	660 0.550				
0.280	1.0	25.0	1.9	301 0.280	0.560	1.0	25.0	3.9	301 0.560	660 0.560				
0.285	1.0	25.0	1.9	301 0.285	0.570	1.0	25.0	3.9	301 0.570	660 0.570				
0.290	1.0	25.0	1.9	301 0.290	0.580	1.0	25.0	3.9	301 0.580	660 0.580				
0.295	1.0	25.0	1.9	301 0.295	0.585	1.0	25.0	3.9	301 0.585					
0.300	1.0	25.0	1.9	301 0.300	0.590	1.0	25.0	3.9	301 0.590	660 0.590				
0.305	1.0	25.0	2.4	301 0.305	0.595	1.0	25.0	3.9	301 0.595					
0.310	1.0	25.0	2.4	301 0.310	0.600	1.0	25.0	3.9	301 0.600	660 0.600				
0.315	1.0	25.0	2.4	301 0.315	0.605	1.0	25.0	4.2	301 0.605					
0.320	1.0	25.0	2.4	301 0.320	0.610	1.0	25.0	4.2	301 0.610	660 0.610				
0.325	1.0	25.0	2.4	301 0.325	0.615	1.0	25.0	4.2	301 0.615					
0.330	1.0	25.0	2.4	301 0.330	0.620	1.0	25.0	4.2	301 0.620	660 0.620				
0.335	1.0	25.0	2.4	301 0.335	0.625	1.0	25.0	4.2	301 0.625					



Article no.				301	660	Article no.				301	660
d1 mm	d2 mm	l1 mm	l2 mm	Order no.		d1 mm	d2 mm	l1 mm	l2 mm	Order no.	
0.630	1.0	25.0	4.2	301 0.630	660 0.630	1.170	1.5	25.0	7.6	301 1.170	
0.632	1.0	25.0	4.2	301 0.632		1.180	1.5	25.0	7.6	301 1.180	660 1.180
0.640	1.0	25.0	4.2	301 0.640	660 0.640	1.190	1.5	25.0	8.5	301 1.190	660 1.190
0.650	1.0	25.0	4.2	301 0.650	660 0.650	1.200	1.5	25.0	8.5	301 1.200	660 1.200
0.655	1.0	25.0	4.2	301 0.655		1.210	1.5	25.0	8.5	301 1.210	
0.660	1.0	25.0	4.2	301 0.660	660 0.660	1.220	1.5	25.0	8.5	301 1.220	660 1.220
0.665	1.0	25.0	4.2	301 0.665		1.230	1.5	25.0	8.5	301 1.230	
0.670	1.0	25.0	4.2	301 0.670	660 0.670	1.240	1.5	25.0	8.5	301 1.240	
0.675	1.0	25.0	4.8	301 0.675		1.250	1.5	25.0	8.5	301 1.250	660 1.250
0.680	1.0	25.0	4.8	301 0.680	660 0.680	1.260	1.5	25.0	8.5	301 1.260	
0.690	1.0	25.0	4.8	301 0.690	660 0.690	1.265	1.5	25.0	8.5	301 1.265	
0.695	1.0	25.0	4.8	301 0.695		1.270	1.5	25.0	8.5	301 1.270	
0.700	1.0	25.0	4.8	301 0.700	660 0.700	1.280	1.5	25.0	8.5	301 1.280	
0.705	1.0	25.0	4.8	301 0.705		1.290	1.5	25.0	8.5	301 1.290	
0.710	1.0	25.0	4.8	301 0.710	660 0.710	1.300	1.5	25.0	8.5	301 1.300	660 1.300
0.720	1.0	25.0	4.8	301 0.720	660 0.720	1.310	1.5	25.0	8.5	301 1.310	
0.725	1.0	25.0	4.8	301 0.725		1.320	1.5	25.0	8.5	301 1.320	
0.730	1.0	25.0	4.8	301 0.730	660 0.730	1.330	1.5	25.0	9.5	301 1.330	
0.740	1.0	25.0	4.8	301 0.740	660 0.740	1.340	1.5	25.0	9.5	301 1.340	
0.750	1.0	25.0	4.8	301 0.750	660 0.750	1.350	1.5	25.0	9.5	301 1.350	660 1.350
0.760	1.0	25.0	5.3	301 0.760	660 0.760	1.370	1.5	25.0	9.5	301 1.370	
0.770	1.0	25.0	5.3	301 0.770	660 0.770	1.380	1.5	25.0	9.5	301 1.380	
0.780	1.0	25.0	5.3	301 0.780	660 0.780	1.390	1.5	25.0	9.5	301 1.390	660 1.390
0.790	1.0	25.0	5.3	301 0.790	660 0.790	1.400	1.5	25.0	9.5	301 1.400	660 1.400
0.795	1.5	25.0	5.3	301 0.795		1.410	1.5	25.0	9.5	301 1.410	
0.800	1.5	25.0	5.3	301 0.800	660 0.800	1.420	1.5	25.0	9.5	301 1.420	660 1.420
0.810	1.5	25.0	5.3	301 0.810	660 0.810	1.430	1.5	25.0	9.5	301 1.430	
0.820	1.5	25.0	5.3	301 0.820	660 0.820	1.440	1.5	25.0	9.5	301 1.440	
0.825	1.5	25.0	5.3	301 0.825		1.450	1.5	25.0	9.5	301 1.450	660 1.450
0.830	1.5	25.0	5.3	301 0.830	660 0.830	1.460	2.0	30.0	9.5	301 1.460	
0.840	1.5	25.0	5.3	301 0.840	660 0.840	1.470	2.0	30.0	9.5	301 1.470	
0.845	1.5	25.0	5.3	301 0.845		1.500	2.0	30.0	9.5	301 1.500	660 1.500
0.850	1.5	25.0	5.3	301 0.850	660 0.850	1.520	2.0	30.0	10.6	301 1.520	
0.860	1.5	25.0	6.0	301 0.860	660 0.860	1.530	2.0	30.0	10.6	301 1.530	
0.870	1.5	25.0	6.0	301 0.870	660 0.870	1.540	2.0	30.0	10.6	301 1.540	
0.880	1.5	25.0	6.0	301 0.880	660 0.880	1.550	2.0	30.0	10.6	301 1.550	
0.890	1.5	25.0	6.0	301 0.890		1.590	2.0	30.0	10.6	301 1.590	
0.900	1.5	25.0	6.0	301 0.900	660 0.900	1.600	2.0	30.0	10.6	301 1.600	
0.910	1.5	25.0	6.0	301 0.910	660 0.910	1.610	2.0	30.0	10.6	301 1.610	
0.920	1.5	25.0	6.0	301 0.920	660 0.920	1.630	2.0	30.0	10.6	301 1.630	
0.925	1.5	25.0	6.0	301 0.925		1.650	2.0	30.0	10.6	301 1.650	
0.930	1.5	25.0	6.0	301 0.930		1.660	2.0	30.0	10.6	301 1.660	
0.940	1.5	25.0	6.0	301 0.940	660 0.940	1.690	2.0	30.0	10.6	301 1.690	
0.950	1.5	25.0	6.0	301 0.950	660 0.950	1.700	2.0	30.0	10.6	301 1.700	
0.960	1.5	25.0	6.8	301 0.960	660 0.960	1.710	2.0	30.0	11.8	301 1.710	
0.970	1.5	25.0	6.8	301 0.970	660 0.970	1.715	2.0	30.0	11.8	301 1.715	
0.980	1.5	25.0	6.8	301 0.980	660 0.980	1.730	2.0	30.0	11.8	301 1.730	
0.990	1.5	25.0	6.8	301 0.990		1.745	2.0	30.0	11.8	301 1.745	
1.000	1.5	25.0	6.8	301 1.000	660 1.000	1.750	2.0	30.0	11.8	301 1.750	
1.010	1.5	25.0	6.8	301 1.010		1.775	2.0	30.0	11.8	301 1.775	
1.020	1.5	25.0	6.8	301 1.020	660 1.020	1.800	2.0	30.0	11.8	301 1.800	660 1.800
1.030	1.5	25.0	6.8	301 1.030		1.830	2.0	30.0	11.8	301 1.830	
1.040	1.5	25.0	6.8	301 1.040	660 1.040	1.840	2.0	30.0	11.8	301 1.840	
1.050	1.5	25.0	6.8	301 1.050	660 1.050	1.850	2.0	30.0	11.8	301 1.850	
1.055	1.5	25.0	6.8	301 1.055		1.860	2.0	30.0	11.8	301 1.860	
1.060	1.5	25.0	6.8	301 1.060		1.900	2.0	30.0	11.8	301 1.900	660 1.900
1.070	1.5	25.0	7.6	301 1.070	660 1.070	1.920	2.0	30.0	13.2	301 1.920	
1.080	1.5	25.0	7.6	301 1.080	660 1.080						
1.090	1.5	25.0	7.6	301 1.090	660 1.090						
1.100	1.5	25.0	7.6	301 1.100	660 1.100						
1.110	1.5	25.0	7.6	301 1.110							
1.120	1.5	25.0	7.6	301 1.120							
1.130	1.5	25.0	7.6	301 1.130							
1.140	1.5	25.0	7.6	301 1.140							
1.150	1.5	25.0	7.6	301 1.150	660 1.150						
1.160	1.5	25.0	7.6	301 1.160							

Micro drills



HSS-E-PM micro-precision drills without coolant ducts

Article no. **303**



facet point grind • with re-inforced shank • < Ø 0.15 mm Co-alloyed high speed steel

Cutting data page 394

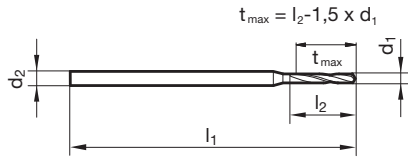

Article no.				303				Article no.				303			
d1 mm	d2 mm	l1 mm	l2 mm	Order no.	d1 mm	d2 mm	l1 mm	l2 mm	Order no.	d1 mm	d2 mm	l1 mm	l2 mm	Order no.	
0.160	1.0	25.0	1.1	303 0.160	0.760	1.0	25.0	5.3	303 0.760						
0.170	1.0	25.0	1.1	303 0.170	0.770	1.0	25.0	5.3	303 0.770						
0.180	1.0	25.0	1.1	303 0.180	0.780	1.0	25.0	5.3	303 0.780						
0.185	1.0	25.0	1.1	303 0.185	0.790	1.0	25.0	5.3	303 0.790						
0.200	1.0	25.0	1.5	303 0.200	0.800	1.5	25.0	5.3	303 0.800						
0.210	1.0	25.0	1.5	303 0.210	0.810	1.5	25.0	5.3	303 0.810						
0.215	1.0	25.0	1.5	303 0.215	0.820	1.5	25.0	5.3	303 0.820						
0.220	1.0	25.0	1.5	303 0.220	0.830	1.5	25.0	5.3	303 0.830						
0.225	1.0	25.0	1.5	303 0.225	0.840	1.5	25.0	5.3	303 0.840						
0.230	1.0	25.0	1.5	303 0.230	0.850	1.5	25.0	5.3	303 0.850						
0.240	1.0	25.0	1.5	303 0.240	0.860	1.5	25.0	6.0	303 0.860						
0.245	1.0	25.0	1.9	303 0.245	0.870	1.5	25.0	6.0	303 0.870						
0.250	1.0	25.0	1.9	303 0.250	0.880	1.5	25.0	6.0	303 0.880						
0.255	1.0	25.0	1.9	303 0.255	0.885	1.5	25.0	6.0	303 0.885						
0.260	1.0	25.0	1.9	303 0.260	0.890	1.5	25.0	6.0	303 0.890						
0.270	1.0	25.0	1.9	303 0.270	0.900	1.5	25.0	6.0	303 0.900						
0.280	1.0	25.0	1.9	303 0.280	0.910	1.5	25.0	6.0	303 0.910						
0.290	1.0	25.0	1.9	303 0.290	0.915	1.5	25.0	6.0	303 0.915						
0.300	1.0	25.0	1.9	303 0.300	0.920	1.5	25.0	6.0	303 0.920						
0.310	1.0	25.0	2.4	303 0.310	0.935	1.5	25.0	6.0	303 0.935						
0.315	1.0	25.0	2.4	303 0.315	0.940	1.5	25.0	6.0	303 0.940						
0.330	1.0	25.0	2.4	303 0.330	0.950	1.5	25.0	6.0	303 0.950						
0.340	1.0	25.0	2.4	303 0.340	0.960	1.5	25.0	6.8	303 0.960						
0.350	1.0	25.0	2.4	303 0.350	0.970	1.5	25.0	6.8	303 0.970						
0.360	1.0	25.0	2.4	303 0.360	0.975	1.5	25.0	6.8	303 0.975						
0.370	1.0	25.0	2.4	303 0.370	0.980	1.5	25.0	6.8	303 0.980						
0.380	1.0	25.0	2.4	303 0.380	0.990	1.5	25.0	6.8	303 0.990						
0.390	1.0	25.0	3.0	303 0.390	1.000	1.5	25.0	6.8	303 1.000						
0.400	1.0	25.0	3.0	303 0.400	1.005	1.5	25.0	6.8	303 1.005						
0.410	1.0	25.0	3.0	303 0.410	1.020	1.5	25.0	6.8	303 1.020						
0.420	1.0	25.0	3.0	303 0.420	1.030	1.5	25.0	6.8	303 1.030						
0.430	1.0	25.0	3.0	303 0.430	1.040	1.5	25.0	6.8	303 1.040						
0.440	1.0	25.0	3.0	303 0.440	1.050	1.5	25.0	6.8	303 1.050						
0.450	1.0	25.0	3.0	303 0.450	1.060	1.5	25.0	6.8	303 1.060						
0.460	1.0	25.0	3.0	303 0.460	1.080	1.5	25.0	7.6	303 1.080						
0.465	1.0	25.0	3.0	303 0.465	1.090	1.5	25.0	7.6	303 1.090						
0.470	1.0	25.0	3.0	303 0.470	1.100	1.5	25.0	7.6	303 1.100						
0.480	1.0	25.0	3.0	303 0.480	1.110	1.5	25.0	7.6	303 1.110						
0.490	1.0	25.0	3.4	303 0.490	1.120	1.5	25.0	7.6	303 1.120						
0.500	1.0	25.0	3.4	303 0.500	1.150	1.5	25.0	7.6	303 1.150						
0.510	1.0	25.0	3.4	303 0.510	1.160	1.5	25.0	7.6	303 1.160						
0.520	1.0	25.0	3.4	303 0.520	1.170	1.5	25.0	7.6	303 1.170						
0.525	1.0	25.0	3.4	303 0.525	1.180	1.5	25.0	7.6	303 1.180						
0.540	1.0	25.0	3.9	303 0.540	1.200	1.5	25.0	8.5	303 1.200						
0.545	1.0	25.0	3.9	303 0.545	1.250	1.5	25.0	8.5	303 1.250						
0.550	1.0	25.0	3.9	303 0.550	1.270	1.5	25.0	8.5	303 1.270						
0.565	1.0	25.0	3.9	303 0.565	1.280	1.5	25.0	8.5	303 1.280						
0.570	1.0	25.0	3.9	303 0.570	1.285	1.5	25.0	8.5	303 1.285						
0.580	1.0	25.0	3.9	303 0.580	1.290	1.5	25.0	8.5	303 1.290						
0.590	1.0	25.0	3.9	303 0.590	1.300	1.5	25.0	8.5	303 1.300						
0.600	1.0	25.0	3.9	303 0.600	1.330	1.5	25.0	9.5	303 1.330						
0.615	1.0	25.0	4.2	303 0.615	1.350	1.5	25.0	9.5	303 1.350						
0.620	1.0	25.0	4.2	303 0.620	1.360	1.5	25.0	9.5	303 1.360						
0.630	1.0	25.0	4.2	303 0.630	1.375	1.5	25.0	9.5	303 1.375						
0.640	1.0	25.0	4.2	303 0.640	1.400	1.5	25.0	9.5	303 1.400						
0.650	1.0	25.0	4.2	303 0.650	1.450	1.5	25.0	9.5	303 1.450						
0.660	1.0	25.0	4.2	303 0.660	1.460	2.0	30.0	9.5	303 1.460						
0.670	1.0	25.0	4.2	303 0.670	1.500	2.0	30.0	9.5	303 1.500						
0.675	1.0	25.0	4.8	303 0.675	1.600	2.0	30.0	10.6	303 1.600						
0.680	1.0	25.0	4.8	303 0.680	1.800	2.0	30.0	11.8	303 1.800						
0.690	1.0	25.0	4.8	303 0.690	1.850	2.0	30.0	11.8	303 1.850						
0.700	1.0	25.0	4.8	303 0.700											
0.710	1.0	25.0	4.8	303 0.710											
0.720	1.0	25.0	4.8	303 0.720											
0.740	1.0	25.0	4.8	303 0.740											
0.750	1.0	25.0	4.8	303 0.750											



Pilot drills with coolant ducts

Article no. 6596



Cutting data page 396



P	M	K	N	S	H
●	●	●	○	○	○

180° point geometry for flat bottomed holes • for piloting, drilling, finishing • low burr development • piloting in all positions and materials

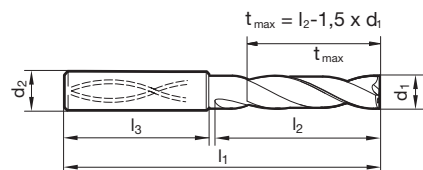

Article no. 6596

Article no. 6596

d1 mm	inch	d2 h6 mm	l1 mm	l2 mm	l3 mm	Order no.	d1 mm	inch	d2 h6 mm	l1 mm	l2 mm	l3 mm	Order no.
3.000		6.0	61.0	16.0	40.0	6596 3.000	7.550		8.0	78.0	35.0	36.0	6596 7.550
3.100		6.0	61.0	16.0	40.0	6596 3.100	7.600		8.0	78.0	35.0	36.0	6596 7.600
3.170	1/8	6.0	61.0	16.0	40.0	6596 3.170	7.650		8.0	78.0	35.0	36.0	6596 7.650
3.200		6.0	61.0	16.0	40.0	6596 3.200	7.700		8.0	78.0	35.0	36.0	6596 7.700
3.250		6.0	61.0	16.0	40.0	6596 3.250	7.800		8.0	78.0	35.0	36.0	6596 7.800
3.300		6.0	61.0	16.0	40.0	6596 3.300	7.900		8.0	78.0	35.0	36.0	6596 7.900
3.400		6.0	61.0	16.0	40.0	6596 3.400	7.940	5/16	8.0	78.0	35.0	36.0	6596 7.940
3.500		6.0	61.0	16.0	40.0	6596 3.500	8.000		8.0	78.0	35.0	36.0	6596 8.000
3.570	9/64	6.0	61.0	16.0	40.0	6596 3.570	8.100		10.0	87.0	43.0	40.0	6596 8.100
3.600		6.0	61.0	16.0	40.0	6596 3.600	8.200		10.0	87.0	43.0	40.0	6596 8.200
3.700		6.0	61.0	16.0	40.0	6596 3.700	8.300		10.0	87.0	43.0	40.0	6596 8.300
3.800		6.0	65.0	18.0	40.0	6596 3.800	8.330	21/64	10.0	87.0	43.0	40.0	6596 8.330
3.900		6.0	65.0	18.0	40.0	6596 3.900	8.400		10.0	87.0	43.0	40.0	6596 8.400
3.970	5/32	6.0	65.0	18.0	40.0	6596 3.970	8.500		10.0	87.0	43.0	40.0	6596 8.500
4.000		6.0	65.0	18.0	36.0	6596 4.000	8.600		10.0	87.0	43.0	40.0	6596 8.600
4.040		6.0	65.0	18.0	40.0	6596 4.040	8.700		10.0	87.0	43.0	40.0	6596 8.700
4.100		6.0	65.0	18.0	36.0	6596 4.100	8.730	11/32	10.0	87.0	43.0	40.0	6596 8.730
4.200		6.0	65.0	18.0	40.0	6596 4.200	8.800		10.0	87.0	43.0	40.0	6596 8.800
4.300		6.0	65.0	21.0	40.0	6596 4.300	8.900		10.0	87.0	43.0	40.0	6596 8.900
4.370	11/64	6.0	65.0	21.0	40.0	6596 4.370	9.000		10.0	87.0	43.0	40.0	6596 9.000
4.400		6.0	65.0	21.0	40.0	6596 4.400	9.100		10.0	87.0	43.0	40.0	6596 9.100
4.500		6.0	65.0	21.0	40.0	6596 4.500	9.130	23/64	10.0	87.0	43.0	40.0	6596 9.130
4.600		6.0	65.0	21.0	40.0	6596 4.600	9.200		10.0	87.0	43.0	40.0	6596 9.200
4.650		6.0	65.0	21.0	40.0	6596 4.650	9.250		10.0	87.0	43.0	40.0	6596 9.250
4.700		6.0	65.0	21.0	40.0	6596 4.700	9.300		10.0	87.0	43.0	40.0	6596 9.300
4.760	3/16	6.0	65.0	26.0	36.0	6596 4.760	9.340		10.0	87.0	43.0	40.0	6596 9.340
4.800		6.0	65.0	26.0	36.0	6596 4.800	9.400		10.0	87.0	43.0	40.0	6596 9.400
4.900		6.0	65.0	26.0	36.0	6596 4.900	9.500		10.0	87.0	43.0	40.0	6596 9.500
5.000		6.0	65.0	26.0	36.0	6596 5.000	9.520	3/8	10.0	87.0	43.0	40.0	6596 9.520
5.100		6.0	65.0	26.0	36.0	6596 5.100	9.550		10.0	87.0	43.0	40.0	6596 9.550
5.110		6.0	65.0	26.0	36.0	6596 5.110	9.600		10.0	87.0	43.0	40.0	6596 9.600
5.160	13/64	6.0	65.0	26.0	36.0	6596 5.160	9.700		10.0	87.0	43.0	40.0	6596 9.700
5.200		6.0	65.0	26.0	36.0	6596 5.200	9.800		10.0	87.0	43.0	40.0	6596 9.800
5.300		6.0	65.0	26.0	36.0	6596 5.300	9.900		10.0	87.0	43.0	40.0	6596 9.900
5.400		6.0	65.0	26.0	36.0	6596 5.400	9.920	25/64	10.0	87.0	43.0	40.0	6596 9.920
5.410		6.0	65.0	26.0	36.0	6596 5.410	10.000		10.0	87.0	43.0	40.0	6596 10.000
5.500		6.0	65.0	26.0	36.0	6596 5.500	10.100		12.0	100.0	52.0	45.0	6596 10.100
5.550		6.0	65.0	26.0	36.0	6596 5.550	10.200		12.0	100.0	52.0	45.0	6596 10.200
5.560	7/32	6.0	65.0	26.0	36.0	6596 5.560	10.300		12.0	100.0	52.0	45.0	6596 10.300
5.600		6.0	65.0	26.0	36.0	6596 5.600	10.320	13/32	12.0	100.0	52.0	45.0	6596 10.320
5.700		6.0	65.0	26.0	36.0	6596 5.700	10.400		12.0	100.0	52.0	45.0	6596 10.400
5.800		6.0	65.0	26.0	36.0	6596 5.800	10.500		12.0	100.0	52.0	45.0	6596 10.500
5.900		6.0	65.0	26.0	36.0	6596 5.900	10.600		12.0	100.0	52.0	45.0	6596 10.600
5.950	15/64	6.0	65.0	26.0	36.0	6596 5.950	10.700		12.0	100.0	52.0	45.0	6596 10.700
6.000		6.0	65.0	26.0	36.0	6596 6.000	10.720	27/64	12.0	100.0	52.0	45.0	6596 10.720
6.100		8.0	78.0	31.0	36.0	6596 6.100	10.800		12.0	100.0	52.0	45.0	6596 10.800
6.200		8.0	78.0	31.0	36.0	6596 6.200	10.900		12.0	100.0	52.0	45.0	6596 10.900
6.300		8.0	78.0	31.0	36.0	6596 6.300	11.000		12.0	100.0	52.0	45.0	6596 11.000
6.350	1/4	8.0	78.0	31.0	36.0	6596 6.350	11.100		12.0	100.0	52.0	45.0	6596 11.100
6.400		8.0	78.0	31.0	36.0	6596 6.400	11.110	7/16	12.0	100.0	52.0	45.0	6596 11.110
6.500		8.0	78.0	31.0	36.0	6596 6.500	11.200		12.0	100.0	52.0	45.0	6596 11.200
6.530		8.0	78.0	31.0	36.0	6596 6.530	11.300		12.0	100.0	52.0	45.0	6596 11.300
6.550		8.0	78.0	31.0	36.0	6596 6.550	11.400		12.0	100.0	52.0	45.0	6596 11.400
6.600		8.0	78.0	31.0	36.0	6596 6.600	11.500		12.0	100.0	52.0	45.0	6596 11.500
6.700		8.0	78.0	31.0	36.0	6596 6.700	11.510	29/64	12.0	100.0	52.0	45.0	6596 11.510
6.750	17/64	8.0	78.0	31.0	36.0	6596 6.750	11.550		12.0	100.0	52.0	45.0	6596 11.550
6.800		8.0	78.0	31.0	36.0	6596 6.800	11.600		12.0	100.0	52.0	45.0	6596 11.600
6.900		8.0	78.0	31.0	36.0	6596 6.900	11.700		12.0	100.0	52.0	45.0	6596 11.700
7.000		8.0	78.0	31.0	36.0	6596 7.000	11.800		12.0	100.0	52.0	45.0	6596 11.800
7.100		8.0	78.0	35.0	36.0	6596 7.100	11.900		12.0	100.0	52.0	45.0	6596 11.900
7.140	9/32	8.0	78.0	35.0	36.0	6596 7.140	11.910	15/32	12.0	100.0	52.0	45.0	6596 11.910
7.200		8.0	78.0	35.0	36.0	6596 7.200	12.000		12.0	100.0	52.0	45.0	6596 12.000
7.300		8.0	78.0	35.0	36.0	6596 7.300	12.100		14.0	104.0	57.0	45.0	6596 12.100
7.400		8.0	78.0	35.0	36.0	6596 7.400	12.200		14.0	104.0	57.0	45.0	6596 12.200
7.500		8.0	78.0	35.0	36.0	6596 7.500	12.300	31/64	14.0	104.0	57.0	45.0	6596 12.300
7.540	19/64	8.0	78.0	35.0	36.0	6596 7.540	12.400		14.0	104.0	57.0	45.0	6596 12.400



Solid carbide drills

Article no. 6596						Article no. 6596							
d1 mm	inch	d2 h6 mm	l1 mm	l2 mm	l3 mm	Order no.	d1 mm	inch	d2 h6 mm	l1 mm	l2 mm	l3 mm	Order no.
12.500		14.0	104.0	57.0	45.0	6596 12.500	15.900		16.0	112.0	62.0	48.0	6596 15.900
12.600		14.0	104.0	57.0	45.0	6596 12.600	16.000		16.0	112.0	62.0	48.0	6596 16.000
12.700	1/2	14.0	104.0	57.0	45.0	6596 12.700	16.270	41/64	18.0	120.0	70.0	48.0	6596 16.270
12.800		14.0	104.0	57.0	45.0	6596 12.800	16.300		18.0	120.0	70.0	48.0	6596 16.300
12.900		14.0	104.0	57.0	45.0	6596 12.900	16.500		18.0	120.0	70.0	48.0	6596 16.500
13.000		14.0	104.0	57.0	45.0	6596 13.000	16.670	21/32	18.0	120.0	70.0	48.0	6596 16.670
13.100	33/64	14.0	104.0	57.0	45.0	6596 13.100	16.700		18.0	120.0	70.0	48.0	6596 16.700
13.200		14.0	104.0	57.0	45.0	6596 13.200	16.900		18.0	120.0	70.0	48.0	6596 16.900
13.300		14.0	104.0	57.0	45.0	6596 13.300	17.000		18.0	120.0	70.0	48.0	6596 17.000
13.400		14.0	104.0	57.0	45.0	6596 13.400	17.070	43/64	18.0	120.0	70.0	48.0	6596 17.070
13.490	17/32	14.0	104.0	57.0	45.0	6596 13.490	17.460	11/16	18.0	120.0	70.0	48.0	6596 17.460
13.500		14.0	104.0	57.0	45.0	6596 13.500	17.500		18.0	120.0	70.0	48.0	6596 17.500
13.600		14.0	104.0	57.0	45.0	6596 13.600	17.550		18.0	120.0	70.0	48.0	6596 17.550
13.700		14.0	104.0	57.0	45.0	6596 13.700	17.700		18.0	120.0	70.0	48.0	6596 17.700
13.800		14.0	104.0	57.0	45.0	6596 13.800	17.860	45/64	18.0	120.0	70.0	48.0	6596 17.860
13.890	35/64	14.0	104.0	57.0	45.0	6596 13.890	18.000		18.0	120.0	70.0	48.0	6596 18.000
13.900		14.0	104.0	57.0	45.0	6596 13.900	18.260	23/32	20.0	128.0	76.0	50.0	6596 18.260
14.000		14.0	104.0	57.0	45.0	6596 14.000	18.500		20.0	128.0	76.0	50.0	6596 18.500
14.100		16.0	112.0	62.0	48.0	6596 14.100	18.700		20.0	128.0	76.0	50.0	6596 18.700
14.200		16.0	112.0	62.0	48.0	6596 14.200	18.900		20.0	128.0	76.0	50.0	6596 18.900
14.290	9/16	16.0	112.0	62.0	48.0	6596 14.290	19.000		20.0	128.0	76.0	50.0	6596 19.000
14.300		16.0	112.0	62.0	48.0	6596 14.300	19.050	3/4	20.0	128.0	76.0	50.0	6596 19.050
14.400		16.0	112.0	62.0	48.0	6596 14.400	19.250		20.0	128.0	76.0	50.0	6596 19.250
14.500		16.0	112.0	62.0	48.0	6596 14.500	19.300		20.0	128.0	76.0	50.0	6596 19.300
14.600		16.0	112.0	62.0	48.0	6596 14.600	19.450	49/64	20.0	128.0	76.0	50.0	6596 19.450
14.680	37/64	16.0	112.0	62.0	48.0	6596 14.680	19.500		20.0	128.0	76.0	50.0	6596 19.500
14.700		16.0	112.0	62.0	48.0	6596 14.700	19.550		20.0	128.0	76.0	50.0	6596 19.550
14.800		16.0	112.0	62.0	48.0	6596 14.800	19.700		20.0	128.0	76.0	50.0	6596 19.700
14.900		16.0	112.0	62.0	48.0	6596 14.900	19.800		20.0	128.0	76.0	50.0	6596 19.800
15.000		16.0	112.0	62.0	48.0	6596 15.000	19.840	25/32	20.0	128.0	76.0	50.0	6596 19.840
15.080	19/32	16.0	112.0	62.0	48.0	6596 15.080	20.000		20.0	128.0	76.0	50.0	6596 20.000
15.100		16.0	112.0	62.0	48.0	6596 15.100							
15.200		16.0	112.0	62.0	48.0	6596 15.200							
15.300		16.0	112.0	62.0	48.0	6596 15.300							
15.400		16.0	112.0	62.0	48.0	6596 15.400							
15.480	39/64	16.0	112.0	62.0	48.0	6596 15.480							
15.500		16.0	112.0	62.0	48.0	6596 15.500							
15.550		16.0	112.0	62.0	48.0	6596 15.550							
15.600		16.0	112.0	62.0	48.0	6596 15.600							
15.700		16.0	112.0	62.0	48.0	6596 15.700							
15.800		16.0	112.0	62.0	48.0	6596 15.800							
15.870	5/8	16.0	112.0	62.0	48.0	6596 15.870							



Ratio drills without coolant ducts

Article no. 2480



Web thinning $\geq \varnothing 3.000$ • facet point grind • main cutting edge form straight • optimised cutting edge geometry

Cutting data page 397

P	M	K	N	S	H
●	○	●	○	○	○

Ratio drills without coolant ducts

Article no. 2472



Web thinning $\geq \varnothing 3.000$ • facet point grind • main cutting edge form straight • optimised cutting edge geometry

Cutting data page 397

P	M	K	N	S	H
●	○	●	○	○	○

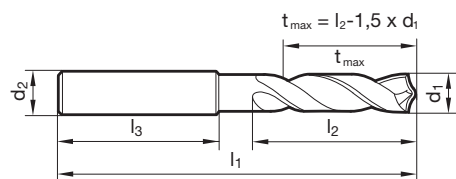

Article no.

2480

2472

Article no.

2480

2472

d1 mm	inch	d2 h6 mm	l1 mm	l2 mm	l3 mm	Order no.		d1 mm	inch	d2 h6 mm	l1 mm	l2 mm	l3 mm	Order no.	
3.000		6.0	62.0	20.0	36.0	2480 3.000	2472 3.000	7.000		8.0	79.0	34.0	36.0	2480 7.000	2472 7.000
3.100		6.0	62.0	20.0	36.0	2480 3.100	2472 3.100	7.100		8.0	79.0	41.0	36.0	2480 7.100	2472 7.100
3.170	1/8	6.0	62.0	20.0	36.0	2480 3.170	2472 3.170	7.140	9/32	8.0	79.0	41.0	36.0	2480 7.140	2472 7.140
3.200		6.0	62.0	20.0	36.0	2480 3.200	2472 3.200	7.200		8.0	79.0	41.0	36.0	2480 7.200	2472 7.200
3.250		6.0	62.0	20.0	36.0	2480 3.250	2472 3.250	7.300		8.0	79.0	41.0	36.0	2480 7.300	2472 7.300
3.300		6.0	62.0	20.0	36.0	2480 3.300	2472 3.300	7.400		8.0	79.0	41.0	36.0	2480 7.400	2472 7.400
3.400		6.0	62.0	20.0	36.0	2480 3.400	2472 3.400	7.500		8.0	79.0	41.0	36.0	2480 7.500	2472 7.500
3.500		6.0	62.0	20.0	36.0	2480 3.500	2472 3.500	7.540	19/64	8.0	79.0	41.0	36.0	2480 7.540	2472 7.540
3.570	9/64	6.0	62.0	20.0	36.0	2480 3.570	2472 3.570	7.550		8.0	79.0	41.0	36.0	2480 7.550	
3.600		6.0	62.0	20.0	36.0	2480 3.600	2472 3.600	7.600		8.0	79.0	41.0	36.0	2480 7.600	2472 7.600
3.700		6.0	62.0	20.0	36.0	2480 3.700	2472 3.700	7.700		8.0	79.0	41.0	36.0	2480 7.700	2472 7.700
3.800		6.0	66.0	24.0	36.0	2480 3.800	2472 3.800	7.800		8.0	79.0	41.0	36.0	2480 7.800	2472 7.800
3.900		6.0	66.0	24.0	36.0	2480 3.900	2472 3.900	7.900		8.0	79.0	41.0	36.0	2480 7.900	2472 7.900
3.970	5/32	6.0	66.0	24.0	36.0	2480 3.970	2472 3.970	7.940	5/16	8.0	79.0	41.0	36.0	2480 7.940	2472 7.940
4.000		6.0	66.0	24.0	36.0	2480 4.000	2472 4.000	8.000		8.0	79.0	41.0	36.0	2480 8.000	2472 8.000
4.100		6.0	66.0	24.0	36.0	2480 4.100	2472 4.100	8.100		10.0	89.0	47.0	40.0	2480 8.100	2472 8.100
4.200		6.0	66.0	24.0	36.0	2480 4.200	2472 4.200	8.200		10.0	89.0	47.0	40.0	2480 8.200	2472 8.200
4.300		6.0	66.0	24.0	36.0	2480 4.300	2472 4.300	8.300		10.0	89.0	47.0	40.0	2480 8.300	2472 8.300
4.370	11/64	6.0	66.0	24.0	36.0	2480 4.370	2472 4.370	8.330	21/64	10.0	89.0	47.0	40.0	2480 8.330	2472 8.330
4.400		6.0	66.0	24.0	36.0	2480 4.400	2472 4.400	8.400		10.0	89.0	47.0	40.0	2480 8.400	2472 8.400
4.500		6.0	66.0	24.0	36.0	2480 4.500	2472 4.500	8.500		10.0	89.0	47.0	40.0	2480 8.500	2472 8.500
4.600		6.0	66.0	24.0	36.0	2480 4.600	2472 4.600	8.600		10.0	89.0	47.0	40.0	2480 8.600	2472 8.600
4.650		6.0	66.0	24.0	36.0	2480 4.650	2472 4.650	8.700		10.0	89.0	47.0	40.0	2480 8.700	2472 8.700
4.700		6.0	66.0	24.0	36.0	2480 4.700	2472 4.700	8.730	11/32	10.0	89.0	47.0	40.0	2480 8.730	2472 8.730
4.760	3/16	6.0	66.0	28.0	36.0	2480 4.760	2472 4.760	8.800		10.0	89.0	47.0	40.0	2480 8.800	2472 8.800
4.800		6.0	66.0	28.0	36.0	2480 4.800	2472 4.800	8.900		10.0	89.0	47.0	40.0	2480 8.900	2472 8.900
4.900		6.0	66.0	28.0	36.0	2480 4.900	2472 4.900	9.000		10.0	89.0	47.0	40.0	2480 9.000	2472 9.000
5.000		6.0	66.0	28.0	36.0	2480 5.000	2472 5.000	9.100		10.0	89.0	47.0	40.0	2480 9.100	2472 9.100
5.100		6.0	66.0	28.0	36.0	2480 5.100	2472 5.100	9.130	23/64	10.0	89.0	47.0	40.0	2480 9.130	2472 9.130
5.160	13/64	6.0	66.0	28.0	36.0	2480 5.160	2472 5.160	9.200		10.0	89.0	47.0	40.0	2480 9.200	2472 9.200
5.200		6.0	66.0	28.0	36.0	2480 5.200	2472 5.200	9.250		10.0	89.0	47.0	40.0	2480 9.250	2472 9.250
5.300		6.0	66.0	28.0	36.0	2480 5.300	2472 5.300	9.300		10.0	89.0	47.0	40.0	2480 9.300	2472 9.300
5.400		6.0	66.0	28.0	36.0	2480 5.400	2472 5.400	9.400		10.0	89.0	47.0	40.0	2480 9.400	2472 9.400
5.500		6.0	66.0	28.0	36.0	2480 5.500	2472 5.500	9.500		10.0	89.0	47.0	40.0	2480 9.500	2472 9.500
5.550		6.0	66.0	28.0	36.0	2480 5.550	2472 5.550	9.520	3/8	10.0	89.0	47.0	40.0	2480 9.520	2472 9.520
5.560	7/32	6.0	66.0	28.0	36.0	2480 5.560	2472 5.560	9.550		10.0	89.0	47.0	40.0	2480 9.550	
5.600		6.0	66.0	28.0	36.0	2480 5.600	2472 5.600	9.600		10.0	89.0	47.0	40.0	2480 9.600	2472 9.600
5.650		6.0	66.0	28.0	36.0	2480 5.650		9.700		10.0	89.0	47.0	40.0	2480 9.700	2472 9.700
5.700		6.0	66.0	28.0	36.0	2480 5.700	2472 5.700	9.800		10.0	89.0	47.0	40.0	2480 9.800	2472 9.800
5.800		6.0	66.0	28.0	36.0	2480 5.800	2472 5.800	9.900		10.0	89.0	47.0	40.0	2480 9.900	2472 9.900
5.900		6.0	66.0	28.0	36.0	2480 5.900	2472 5.900	9.920	25/64	10.0	89.0	47.0	40.0	2480 9.920	2472 9.920
5.950	15/64	6.0	66.0	28.0	36.0	2480 5.950	2472 5.950	10.000		10.0	89.0	47.0	40.0	2480 10.000	2472 10.000
6.000		6.0	66.0	28.0	36.0	2480 6.000	2472 6.000	10.100		12.0	102.0	55.0	45.0	2480 10.100	2472 10.100
6.100		8.0	79.0	34.0	36.0	2480 6.100	2472 6.100	10.200		12.0	102.0	55.0	45.0	2480 10.200	2472 10.200
6.200		8.0	79.0	34.0	36.0	2480 6.200	2472 6.200	10.300		12.0	102.0	55.0	45.0	2480 10.300	2472 10.300
6.300		8.0	79.0	34.0	36.0	2480 6.300	2472 6.300	10.320	13/32	12.0	102.0	55.0	45.0	2480 10.320	2472 10.320
6.350	1/4	8.0	79.0	34.0	36.0	2480 6.350	2472 6.350	10.400		12.0	102.0	55.0	45.0	2480 10.400	2472 10.400
6.400		8.0	79.0	34.0	36.0	2480 6.400	2472 6.400	10.500		12.0	102.0	55.0	45.0	2480 10.500	2472 10.500
6.500		8.0	79.0	34.0	36.0	2480 6.500	2472 6.500	10.600		12.0	102.0	55.0	45.0	2480 10.600	2472 10.600
6.600		8.0	79.0	34.0	36.0	2480 6.600	2472 6.600	10.700		12.0	102.0	55.0	45.0	2480 10.700	2472 10.700
6.700		8.0	79.0	34.0	36.0	2480 6.700	2472 6.700	10.800		12.0	102.0	55.0	45.0	2480 10.800	2472 10.800
6.750	17/64	8.0	79.0	34.0	36.0	2480 6.750	2472 6.750	10.900		12.0	102.0	55.0	45.0	2480 10.900	2472 10.900
6.800		8.0	79.0	34.0	36.0	2480 6.800	2472 6.800	11.000		12.0	102.0	55.0	45.0	2480 11.000	2472 11.000
6.900		8.0	79.0	34.0	36.0	2480 6.900	2472 6.900	11.100		12.0	102.0	55.0	45.0	2480 11.100	2472 11.100



Solid carbide drills

Article no.						2480	2472	Article no.						2480	2472
d1 mm	inch	d2 h6 mm	l1 mm	l2 mm	l3 mm	Order no.		d1 mm	inch	d2 h6 mm	l1 mm	l2 mm	l3 mm	Order no.	
11.110	7/16	12.0	102.0	55.0	45.0	2480 11.110	2472 11.110	14.300		16.0	115.0	65.0	48.0	2480 14.300	2472 14.300
11.200		12.0	102.0	55.0	45.0	2480 11.200	2472 11.200	14.400		16.0	115.0	65.0	48.0	2480 14.400	2472 14.400
11.300		12.0	102.0	55.0	45.0	2480 11.300	2472 11.300	14.500		16.0	115.0	65.0	48.0	2480 14.500	2472 14.500
11.400		12.0	102.0	55.0	45.0	2480 11.400	2472 11.400	14.700		16.0	115.0	65.0	48.0	2480 14.700	2472 14.700
11.500		12.0	102.0	55.0	45.0	2480 11.500	2472 11.500	14.800		16.0	115.0	65.0	48.0	2480 14.800	
11.600		12.0	102.0	55.0	45.0	2480 11.600	2472 11.600	15.000		16.0	115.0	65.0	48.0	2480 15.000	2472 15.000
11.700		12.0	102.0	55.0	45.0	2480 11.700	2472 11.700	15.100		16.0	115.0	65.0	48.0	2480 15.100	
11.800		12.0	102.0	55.0	45.0	2480 11.800	2472 11.800	15.200		16.0	115.0	65.0	48.0	2480 15.200	2472 15.200
11.900		12.0	102.0	55.0	45.0	2480 11.900	2472 11.900	15.300		16.0	115.0	65.0	48.0	2480 15.300	
11.910	15/32	12.0	102.0	55.0	45.0	2480 11.910	2472 11.910	15.500		16.0	115.0	65.0	48.0	2480 15.500	2472 15.500
12.000		12.0	102.0	55.0	45.0	2480 12.000	2472 12.000	15.600		16.0	115.0	65.0	48.0	2480 15.600	2472 15.600
12.100		14.0	107.0	60.0	45.0	2480 12.100	2472 12.100	15.700		16.0	115.0	65.0	48.0	2480 15.700	2472 15.700
12.200		14.0	107.0	60.0	45.0	2480 12.200	2472 12.200	15.800		16.0	115.0	65.0	48.0	2480 15.800	2472 15.800
12.300	31/64	14.0	107.0	60.0	45.0	2480 12.300	2472 12.300	16.000		16.0	115.0	65.0	48.0	2480 16.000	2472 16.000
12.400		14.0	107.0	60.0	45.0	2480 12.400	2472 12.400	16.100		18.0	123.0	73.0	48.0		2472 16.100
12.500		14.0	107.0	60.0	45.0	2480 12.500	2472 12.500	16.200		18.0	123.0	73.0	48.0		2472 16.200
12.600		14.0	107.0	60.0	45.0	2480 12.600	2472 12.600	16.300		18.0	123.0	73.0	48.0		2472 16.300
12.700	1/2	14.0	107.0	60.0	45.0	2480 12.700	2472 12.700	16.500		18.0	123.0	73.0	48.0	2480 16.500	2472 16.500
12.800		14.0	107.0	60.0	45.0	2480 12.800		17.000		18.0	123.0	73.0	48.0	2480 17.000	2472 17.000
13.000		14.0	107.0	60.0	45.0	2480 13.000	2472 13.000	17.500		18.0	123.0	73.0	48.0	2480 17.500	2472 17.500
13.100	33/64	14.0	107.0	60.0	45.0	2480 13.100		18.000		18.0	123.0	73.0	48.0	2480 18.000	2472 18.000
13.200		14.0	107.0	60.0	45.0	2480 13.200	2472 13.200	18.300		20.0	131.0	79.0	50.0		2472 18.300
13.300		14.0	107.0	60.0	45.0	2480 13.300	2472 13.300	18.500		20.0	131.0	79.0	50.0	2480 18.500	2472 18.500
13.500		14.0	107.0	60.0	45.0	2480 13.500	2472 13.500	19.000		20.0	131.0	79.0	50.0	2480 19.000	2472 19.000
13.700		14.0	107.0	60.0	45.0	2480 13.700	2472 13.700	19.500		20.0	131.0	79.0	50.0	2480 19.500	2472 19.500
13.800		14.0	107.0	60.0	45.0	2480 13.800	2472 13.800	20.000		20.0	131.0	79.0	50.0	2480 20.000	2472 20.000
14.000		14.0	107.0	60.0	45.0	2480 14.000	2472 14.000								
14.100		16.0	115.0	65.0	48.0	2480 14.100	2472 14.100								
14.200		16.0	115.0	65.0	48.0	2480 14.200	2472 14.200								
14.290	9/16	16.0	115.0	65.0	48.0	2480 14.290	2472 14.290								



Ratio drills without coolant ducts

Article no. 6026



Cutting data page 397

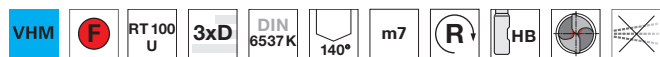

P	M	K	N	S	H
●	○	●	○	○	○

Web thinning ≥ Ø 3.000 • facet point grind • main cutting edge form straight • optimised cutting edge geometry

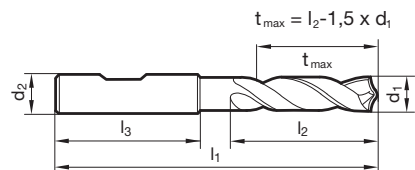

Article no. 6026

Article no. 6026

d1 mm	inch	d2 h6 mm	l1 mm	l2 mm	l3 mm	Order no.	d1 mm	inch	d2 h6 mm	l1 mm	l2 mm	l3 mm	Order no.
3.000		6.0	62.0	20.0	36.0	6026 3.000	7.600		8.0	79.0	41.0	36.0	6026 7.600
3.100		6.0	62.0	20.0	36.0	6026 3.100	7.700		8.0	79.0	41.0	36.0	6026 7.700
3.170	1/8	6.0	62.0	20.0	36.0	6026 3.170	7.800		8.0	79.0	41.0	36.0	6026 7.800
3.200		6.0	62.0	20.0	36.0	6026 3.200	7.900		8.0	79.0	41.0	36.0	6026 7.900
3.250		6.0	62.0	20.0	36.0	6026 3.250	7.940	5/16	8.0	79.0	41.0	36.0	6026 7.940
3.300		6.0	62.0	20.0	36.0	6026 3.300	8.000		8.0	79.0	41.0	36.0	6026 8.000
3.400		6.0	62.0	20.0	36.0	6026 3.400	8.100		10.0	89.0	47.0	40.0	6026 8.100
3.500		6.0	62.0	20.0	36.0	6026 3.500	8.200		10.0	89.0	47.0	40.0	6026 8.200
3.570	9/64	6.0	62.0	20.0	36.0	6026 3.570	8.300		10.0	89.0	47.0	40.0	6026 8.300
3.600		6.0	62.0	20.0	36.0	6026 3.600	8.330	21/64	10.0	89.0	47.0	40.0	6026 8.330
3.700		6.0	62.0	20.0	36.0	6026 3.700	8.400		10.0	89.0	47.0	40.0	6026 8.400
3.800		6.0	66.0	24.0	36.0	6026 3.800	8.500		10.0	89.0	47.0	40.0	6026 8.500
3.900		6.0	66.0	24.0	36.0	6026 3.900	8.600		10.0	89.0	47.0	40.0	6026 8.600
3.970	5/32	6.0	66.0	24.0	36.0	6026 3.970	8.700		10.0	89.0	47.0	40.0	6026 8.700
4.000		6.0	66.0	24.0	36.0	6026 4.000	8.730	11/32	10.0	89.0	47.0	40.0	6026 8.730
4.040		6.0	66.0	24.0	36.0	6026 4.040	8.800		10.0	89.0	47.0	40.0	6026 8.800
4.100		6.0	66.0	24.0	36.0	6026 4.100	8.900		10.0	89.0	47.0	40.0	6026 8.900
4.200		6.0	66.0	24.0	36.0	6026 4.200	9.000		10.0	89.0	47.0	40.0	6026 9.000
4.300		6.0	66.0	24.0	36.0	6026 4.300	9.100		10.0	89.0	47.0	40.0	6026 9.100
4.370	11/64	6.0	66.0	24.0	36.0	6026 4.370	9.130	23/64	10.0	89.0	47.0	40.0	6026 9.130
4.400		6.0	66.0	24.0	36.0	6026 4.400	9.200		10.0	89.0	47.0	40.0	6026 9.200
4.500		6.0	66.0	24.0	36.0	6026 4.500	9.250		10.0	89.0	47.0	40.0	6026 9.250
4.600		6.0	66.0	24.0	36.0	6026 4.600	9.300		10.0	89.0	47.0	40.0	6026 9.300
4.650		6.0	66.0	24.0	36.0	6026 4.650	9.340		10.0	89.0	47.0	40.0	6026 9.340
4.700		6.0	66.0	24.0	36.0	6026 4.700	9.400		10.0	89.0	47.0	40.0	6026 9.400
4.760	3/16	6.0	66.0	28.0	36.0	6026 4.760	9.500		10.0	89.0	47.0	40.0	6026 9.500
4.800		6.0	66.0	28.0	36.0	6026 4.800	9.520	3/8	10.0	89.0	47.0	40.0	6026 9.520
4.900		6.0	66.0	28.0	36.0	6026 4.900	9.600		10.0	89.0	47.0	40.0	6026 9.600
5.000		6.0	66.0	28.0	36.0	6026 5.000	9.700		10.0	89.0	47.0	40.0	6026 9.700
5.100		6.0	66.0	28.0	36.0	6026 5.100	9.800		10.0	89.0	47.0	40.0	6026 9.800
5.110		6.0	66.0	28.0	36.0	6026 5.110	9.900		10.0	89.0	47.0	40.0	6026 9.900
5.160	13/64	6.0	66.0	28.0	36.0	6026 5.160	9.920	25/64	10.0	89.0	47.0	40.0	6026 9.920
5.200		6.0	66.0	28.0	36.0	6026 5.200	10.000		10.0	89.0	47.0	40.0	6026 10.000
5.250		6.0	66.0	28.0	36.0	6026 5.250	10.100		12.0	102.0	55.0	45.0	6026 10.100
5.300		6.0	66.0	28.0	36.0	6026 5.300	10.200		12.0	102.0	55.0	45.0	6026 10.200
5.400		6.0	66.0	28.0	36.0	6026 5.400	10.300		12.0	102.0	55.0	45.0	6026 10.300
5.410		6.0	66.0	28.0	36.0	6026 5.410	10.320	13/32	12.0	102.0	55.0	45.0	6026 10.320
5.500		6.0	66.0	28.0	36.0	6026 5.500	10.400		12.0	102.0	55.0	45.0	6026 10.400
5.550		6.0	66.0	28.0	36.0	6026 5.550	10.500		12.0	102.0	55.0	45.0	6026 10.500
5.560	7/32	6.0	66.0	28.0	36.0	6026 5.560	10.600		12.0	102.0	55.0	45.0	6026 10.600
5.600		6.0	66.0	28.0	36.0	6026 5.600	10.700		12.0	102.0	55.0	45.0	6026 10.700
5.700		6.0	66.0	28.0	36.0	6026 5.700	10.720	27/64	12.0	102.0	55.0	45.0	6026 10.720
5.800		6.0	66.0	28.0	36.0	6026 5.800	10.800		12.0	102.0	55.0	45.0	6026 10.800
5.900		6.0	66.0	28.0	36.0	6026 5.900	10.900		12.0	102.0	55.0	45.0	6026 10.900
5.950	15/64	6.0	66.0	28.0	36.0	6026 5.950	11.000		12.0	102.0	55.0	45.0	6026 11.000
6.000		6.0	66.0	28.0	36.0	6026 6.000	11.100		12.0	102.0	55.0	45.0	6026 11.100
6.100		8.0	79.0	34.0	36.0	6026 6.100	11.110	7/16	12.0	102.0	55.0	45.0	6026 11.110
6.200		8.0	79.0	34.0	36.0	6026 6.200	11.200		12.0	102.0	55.0	45.0	6026 11.200
6.300		8.0	79.0	34.0	36.0	6026 6.300	11.300		12.0	102.0	55.0	45.0	6026 11.300
6.350	1/4	8.0	79.0	34.0	36.0	6026 6.350	11.400		12.0	102.0	55.0	45.0	6026 11.400
6.400		8.0	79.0	34.0	36.0	6026 6.400	11.500		12.0	102.0	55.0	45.0	6026 11.500
6.500		8.0	79.0	34.0	36.0	6026 6.500	11.510	29/64	12.0	102.0	55.0	45.0	6026 11.510
6.530		8.0	79.0	34.0	36.0	6026 6.530	11.600		12.0	102.0	55.0	45.0	6026 11.600
6.600		8.0	79.0	34.0	36.0	6026 6.600	11.700		12.0	102.0	55.0	45.0	6026 11.700
6.700		8.0	79.0	34.0	36.0	6026 6.700	11.800		12.0	102.0	55.0	45.0	6026 11.800
6.750	17/64	8.0	79.0	34.0	36.0	6026 6.750	11.900		12.0	102.0	55.0	45.0	6026 11.900
6.800		8.0	79.0	34.0	36.0	6026 6.800	11.910	15/32	12.0	102.0	55.0	45.0	6026 11.910
6.900		8.0	79.0	34.0	36.0	6026 6.900	12.000		12.0	102.0	55.0	45.0	6026 12.000
7.000		8.0	79.0	34.0	36.0	6026 7.000	12.100		14.0	107.0	60.0	45.0	6026 12.100
7.100		8.0	79.0	41.0	36.0	6026 7.100	12.200		14.0	107.0	60.0	45.0	6026 12.200
7.140	9/32	8.0	79.0	41.0	36.0	6026 7.140	12.300	31/64	14.0	107.0	60.0	45.0	6026 12.300
7.200		8.0	79.0	41.0	36.0	6026 7.200	12.400		14.0	107.0	60.0	45.0	6026 12.400
7.300		8.0	79.0	41.0	36.0	6026 7.300	12.500		14.0	107.0	60.0	45.0	6026 12.500
7.400		8.0	79.0	41.0	36.0	6026 7.400	12.600		14.0	107.0	60.0	45.0	6026 12.600
7.500		8.0	79.0	41.0	36.0	6026 7.500	12.700	1/2	14.0	107.0	60.0	45.0	6026 12.700
7.540	19/64	8.0	79.0	41.0	36.0	6026 7.540	12.800		14.0	107.0	60.0	45.0	6026 12.800



Solid carbide drills

Article no.						6026	Article no.						6026
d1 mm	inch	d2 h6 mm	l1 mm	l2 mm	l3 mm	Order no.	d1 mm	inch	d2 h6 mm	l1 mm	l2 mm	l3 mm	Order no.
12.900		14.0	107.0	60.0	45.0	6026 12.900	15.400		16.0	115.0	65.0	48.0	6026 15.400
13.000		14.0	107.0	60.0	45.0	6026 13.000	15.480	39/64	16.0	115.0	65.0	48.0	6026 15.480
13.100	33/64	14.0	107.0	60.0	45.0	6026 13.100	15.500		16.0	115.0	65.0	48.0	6026 15.500
13.200		14.0	107.0	60.0	45.0	6026 13.200	15.600		16.0	115.0	65.0	48.0	6026 15.600
13.300		14.0	107.0	60.0	45.0	6026 13.300	15.700		16.0	115.0	65.0	48.0	6026 15.700
13.400		14.0	107.0	60.0	45.0	6026 13.400	15.800		16.0	115.0	65.0	48.0	6026 15.800
13.490	17/32	14.0	107.0	60.0	45.0	6026 13.490	15.870	5/8	16.0	115.0	65.0	48.0	6026 15.870
13.500		14.0	107.0	60.0	45.0	6026 13.500	15.900		16.0	115.0	65.0	48.0	6026 15.900
13.600		14.0	107.0	60.0	45.0	6026 13.600	16.000		16.0	115.0	65.0	48.0	6026 16.000
13.700		14.0	107.0	60.0	45.0	6026 13.700	16.270	41/64	18.0	123.0	73.0	48.0	6026 16.270
13.800		14.0	107.0	60.0	45.0	6026 13.800	16.500		18.0	123.0	73.0	48.0	6026 16.500
13.890	35/64	14.0	107.0	60.0	45.0	6026 13.890	16.670	21/32	18.0	123.0	73.0	48.0	6026 16.670
13.900		14.0	107.0	60.0	45.0	6026 13.900	17.000		18.0	123.0	73.0	48.0	6026 17.000
14.000		14.0	107.0	60.0	45.0	6026 14.000	17.070	43/64	18.0	123.0	73.0	48.0	6026 17.070
14.100		16.0	115.0	65.0	48.0	6026 14.100	17.460	11/16	18.0	123.0	73.0	48.0	6026 17.460
14.200		16.0	115.0	65.0	48.0	6026 14.200	17.500		18.0	123.0	73.0	48.0	6026 17.500
14.290	9/16	16.0	115.0	65.0	48.0	6026 14.290	17.860	45/64	18.0	123.0	73.0	48.0	6026 17.860
14.300		16.0	115.0	65.0	48.0	6026 14.300	18.000		18.0	123.0	73.0	48.0	6026 18.000
14.400		16.0	115.0	65.0	48.0	6026 14.400	18.260	23/32	20.0	131.0	79.0	50.0	6026 18.260
14.500		16.0	115.0	65.0	48.0	6026 14.500	18.500		20.0	131.0	79.0	50.0	6026 18.500
14.600		16.0	115.0	65.0	48.0	6026 14.600	19.000		20.0	131.0	79.0	50.0	6026 19.000
14.680	37/64	16.0	115.0	65.0	48.0	6026 14.680	19.050	3/4	20.0	131.0	79.0	50.0	6026 19.050
14.700		16.0	115.0	65.0	48.0	6026 14.700	19.250		20.0	131.0	79.0	50.0	6026 19.250
14.800		16.0	115.0	65.0	48.0	6026 14.800	19.446		20.0	131.0	79.0	50.0	6026 19.446
14.900		16.0	115.0	65.0	48.0	6026 14.900	19.500		20.0	131.0	79.0	50.0	6026 19.500
15.000		16.0	115.0	65.0	48.0	6026 15.000	19.840	25/32	20.0	131.0	79.0	50.0	6026 19.840
15.080	19/32	16.0	115.0	65.0	48.0	6026 15.080	20.000		20.0	131.0	79.0	50.0	6026 20.000
15.100		16.0	115.0	65.0	48.0	6026 15.100							
15.200		16.0	115.0	65.0	48.0	6026 15.200							
15.300		16.0	115.0	65.0	48.0	6026 15.300							



Ratio drills without coolant ducts

Article no. 2473



Cutting data page 397

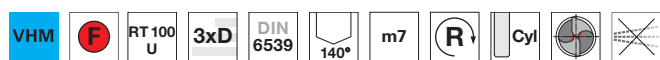

P	M	K	N	S	H
●	○	●	○	○	○

Web thinning ≥ Ø 3.000 • facet point grind • main cutting edge form straight • optimised cutting edge geometry

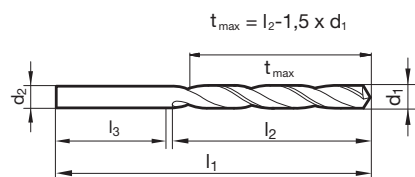

Article no. 2473

Article no. 2473

d1 mm	inch	d2 mm	l1 mm	l2 mm	l3 mm	Order no.	d1 mm	inch	d2 mm	l1 mm	l2 mm	l3 mm	Order no.
3.000		3.0	46.0	16.0	30.0	2473 3.000	7.800		7.8	79.0	37.0	42.0	2473 7.800
3.100		3.1	49.0	18.0	31.0	2473 3.100	7.900		7.9	79.0	37.0	42.0	2473 7.900
3.200		3.2	49.0	18.0	31.0	2473 3.200	8.000		8.0	79.0	37.0	42.0	2473 8.000
3.300		3.3	49.0	18.0	31.0	2473 3.300	8.100		8.1	79.0	37.0	42.0	2473 8.100
3.400		3.4	52.0	20.0	32.0	2473 3.400	8.200		8.2	79.0	37.0	42.0	2473 8.200
3.500		3.5	52.0	20.0	32.0	2473 3.500	8.300		8.3	79.0	37.0	42.0	2473 8.300
3.600		3.6	52.0	20.0	32.0	2473 3.600	8.400		8.4	79.0	37.0	42.0	2473 8.400
3.700		3.7	52.0	20.0	32.0	2473 3.700	8.500		8.5	79.0	37.0	42.0	2473 8.500
3.800		3.8	55.0	22.0	33.0	2473 3.800	8.600		8.6	84.0	40.0	44.0	2473 8.600
3.900		3.9	55.0	22.0	33.0	2473 3.900	8.700		8.7	84.0	40.0	44.0	2473 8.700
4.000		4.0	55.0	22.0	33.0	2473 4.000	8.800		8.8	84.0	40.0	44.0	2473 8.800
4.100		4.1	55.0	22.0	33.0	2473 4.100	8.900		8.9	84.0	40.0	44.0	2473 8.900
4.200		4.2	55.0	22.0	33.0	2473 4.200	9.000		9.0	84.0	40.0	44.0	2473 9.000
4.300		4.3	58.0	24.0	34.0	2473 4.300	9.100		9.1	84.0	40.0	44.0	2473 9.100
4.400		4.4	58.0	24.0	34.0	2473 4.400	9.200		9.2	84.0	40.0	44.0	2473 9.200
4.500		4.5	58.0	24.0	34.0	2473 4.500	9.300		9.3	84.0	40.0	44.0	2473 9.300
4.600		4.6	58.0	24.0	34.0	2473 4.600	9.400		9.4	84.0	40.0	44.0	2473 9.400
4.700		4.7	58.0	24.0	34.0	2473 4.700	9.500		9.5	84.0	40.0	44.0	2473 9.500
4.800		4.8	62.0	26.0	36.0	2473 4.800	9.700		9.7	89.0	43.0	46.0	2473 9.700
4.900		4.9	62.0	26.0	36.0	2473 4.900	9.800		9.8	89.0	43.0	46.0	2473 9.800
5.000		5.0	62.0	26.0	36.0	2473 5.000	9.900		9.9	89.0	43.0	46.0	2473 9.900
5.100		5.1	62.0	26.0	36.0	2473 5.100	10.000		10.0	89.0	43.0	46.0	2473 10.000
5.200		5.2	62.0	26.0	36.0	2473 5.200	10.100		10.1	89.0	43.0	46.0	2473 10.100
5.300		5.3	62.0	26.0	36.0	2473 5.300	10.200		10.2	89.0	43.0	46.0	2473 10.200
5.400		5.4	66.0	28.0	38.0	2473 5.400	10.300		10.3	89.0	43.0	46.0	2473 10.300
5.500		5.5	66.0	28.0	38.0	2473 5.500	10.400		10.4	89.0	43.0	46.0	2473 10.400
5.600		5.6	66.0	28.0	38.0	2473 5.600	10.500		10.5	89.0	43.0	46.0	2473 10.500
5.700		5.7	66.0	28.0	38.0	2473 5.700	10.600		10.6	89.0	43.0	46.0	2473 10.600
5.800		5.8	66.0	28.0	38.0	2473 5.800	10.800		10.8	95.0	47.0	48.0	2473 10.800
5.900		5.9	66.0	28.0	38.0	2473 5.900	10.900		10.9	95.0	47.0	48.0	2473 10.900
6.000		6.0	66.0	28.0	38.0	2473 6.000	11.000		11.0	95.0	47.0	48.0	2473 11.000
6.100		6.1	70.0	31.0	39.0	2473 6.100	11.100		11.1	95.0	47.0	48.0	2473 11.100
6.200		6.2	70.0	31.0	39.0	2473 6.200	11.200		11.2	95.0	47.0	48.0	2473 11.200
6.300		6.3	70.0	31.0	39.0	2473 6.300	11.500		11.5	95.0	47.0	48.0	2473 11.500
6.400		6.4	70.0	31.0	39.0	2473 6.400	11.600		11.6	95.0	47.0	48.0	2473 11.600
6.500		6.5	70.0	31.0	39.0	2473 6.500	11.800		11.8	95.0	47.0	48.0	2473 11.800
6.600		6.6	70.0	31.0	39.0	2473 6.600	12.000		12.0	102.0	51.0	51.0	2473 12.000
6.700		6.7	70.0	31.0	39.0	2473 6.700	12.500		12.5	102.0	51.0	51.0	2473 12.500
6.800		6.8	74.0	34.0	40.0	2473 6.800	12.700	1/2	12.7	102.0	51.0	51.0	2473 12.700
6.900		6.9	74.0	34.0	40.0	2473 6.900	13.000		13.0	102.0	51.0	51.0	2473 13.000
7.000		7.0	74.0	34.0	40.0	2473 7.000	13.500		13.5	107.0	54.0	53.0	2473 13.500
7.100		7.1	74.0	34.0	40.0	2473 7.100	14.000		14.0	107.0	54.0	53.0	2473 14.000
7.200		7.2	74.0	34.0	40.0	2473 7.200	14.500		14.5	111.0	56.0	55.0	2473 14.500
7.300		7.3	74.0	34.0	40.0	2473 7.300	15.000		15.0	111.0	56.0	55.0	2473 15.000
7.400		7.4	74.0	34.0	40.0	2473 7.400	15.500		15.5	115.0	58.0	57.0	2473 15.500
7.500		7.5	74.0	34.0	40.0	2473 7.500	16.000		16.0	115.0	58.0	57.0	2473 16.000
7.600		7.6	79.0	37.0	42.0	2473 7.600							
7.700		7.7	79.0	37.0	42.0	2473 7.700							



Ratio drills without coolant ducts

Article no. **8524**



Cutting data page 399

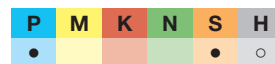
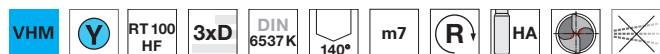

Web thinning $\geq \varnothing 3.000$ • relieved cone • main cutting edge is slightly concave • optimised cutting edge geometry • double margin

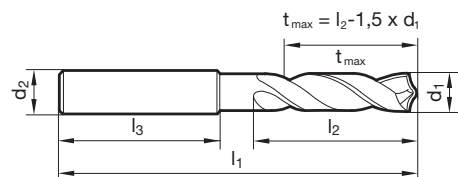

Article no. **8524**

Article no. **8524**

d1 mm	inch	d2 h6 mm	l1 mm	l2 mm	l3 mm	Order no.	d1 mm	inch	d2 h6 mm	l1 mm	l2 mm	l3 mm	Order no.
3.000		6.0	62.0	20.0	36.0	8524 3.000	8.000		8.0	79.0	41.0	36.0	8524 8.000
3.100		6.0	62.0	20.0	36.0	8524 3.100	8.100		10.0	89.0	47.0	40.0	8524 8.100
3.170	1/8	6.0	62.0	20.0	36.0	8524 3.170	8.200		10.0	89.0	47.0	40.0	8524 8.200
3.200		6.0	62.0	20.0	36.0	8524 3.200	8.300		10.0	89.0	47.0	40.0	8524 8.300
3.250		6.0	62.0	20.0	36.0	8524 3.250	8.330	21/64	10.0	89.0	47.0	40.0	8524 8.330
3.300		6.0	62.0	20.0	36.0	8524 3.300	8.400		10.0	89.0	47.0	40.0	8524 8.400
3.400		6.0	62.0	20.0	36.0	8524 3.400	8.500		10.0	89.0	47.0	40.0	8524 8.500
3.500		6.0	62.0	20.0	36.0	8524 3.500	8.600		10.0	89.0	47.0	40.0	8524 8.600
3.570	9/64	6.0	62.0	20.0	36.0	8524 3.570	8.700		10.0	89.0	47.0	40.0	8524 8.700
3.600		6.0	62.0	20.0	36.0	8524 3.600	8.730	11/32	10.0	89.0	47.0	40.0	8524 8.730
3.700		6.0	62.0	20.0	36.0	8524 3.700	8.800		10.0	89.0	47.0	40.0	8524 8.800
3.800		6.0	66.0	24.0	36.0	8524 3.800	8.900		10.0	89.0	47.0	40.0	8524 8.900
3.900		6.0	66.0	24.0	36.0	8524 3.900	9.000		10.0	89.0	47.0	40.0	8524 9.000
3.970	5/32	6.0	66.0	24.0	36.0	8524 3.970	9.100		10.0	89.0	47.0	40.0	8524 9.100
4.000		6.0	66.0	24.0	36.0	8524 4.000	9.130	23/64	10.0	89.0	47.0	40.0	8524 9.130
4.100		6.0	66.0	24.0	36.0	8524 4.100	9.200		10.0	89.0	47.0	40.0	8524 9.200
4.200		6.0	66.0	24.0	36.0	8524 4.200	9.250		10.0	89.0	47.0	40.0	8524 9.250
4.300		6.0	66.0	24.0	36.0	8524 4.300	9.300		10.0	89.0	47.0	40.0	8524 9.300
4.370	11/64	6.0	66.0	24.0	36.0	8524 4.370	9.400		10.0	89.0	47.0	40.0	8524 9.400
4.400		6.0	66.0	24.0	36.0	8524 4.400	9.500		10.0	89.0	47.0	40.0	8524 9.500
4.500		6.0	66.0	24.0	36.0	8524 4.500	9.520	3/8	10.0	89.0	47.0	40.0	8524 9.520
4.600		6.0	66.0	24.0	36.0	8524 4.600	9.600		10.0	89.0	47.0	40.0	8524 9.600
4.650		6.0	66.0	24.0	36.0	8524 4.650	9.700		10.0	89.0	47.0	40.0	8524 9.700
4.700		6.0	66.0	24.0	36.0	8524 4.700	9.800		10.0	89.0	47.0	40.0	8524 9.800
4.760	3/16	6.0	66.0	28.0	36.0	8524 4.760	9.900		10.0	89.0	47.0	40.0	8524 9.900
4.800		6.0	66.0	28.0	36.0	8524 4.800	9.920	25/64	10.0	89.0	47.0	40.0	8524 9.920
4.900		6.0	66.0	28.0	36.0	8524 4.900	10.000		10.0	89.0	47.0	40.0	8524 10.000
5.000		6.0	66.0	28.0	36.0	8524 5.000	10.100		12.0	102.0	55.0	45.0	8524 10.100
5.100		6.0	66.0	28.0	36.0	8524 5.100	10.200		12.0	102.0	55.0	45.0	8524 10.200
5.160	13/64	6.0	66.0	28.0	36.0	8524 5.160	10.300		12.0	102.0	55.0	45.0	8524 10.300
5.200		6.0	66.0	28.0	36.0	8524 5.200	10.320	13/32	12.0	102.0	55.0	45.0	8524 10.320
5.300		6.0	66.0	28.0	36.0	8524 5.300	10.400		12.0	102.0	55.0	45.0	8524 10.400
5.400		6.0	66.0	28.0	36.0	8524 5.400	10.500		12.0	102.0	55.0	45.0	8524 10.500
5.500		6.0	66.0	28.0	36.0	8524 5.500	10.600		12.0	102.0	55.0	45.0	8524 10.600
5.550		6.0	66.0	28.0	36.0	8524 5.550	10.700		12.0	102.0	55.0	45.0	8524 10.700
5.560	7/32	6.0	66.0	28.0	36.0	8524 5.560	10.720	27/64	12.0	102.0	55.0	45.0	8524 10.720
5.600		6.0	66.0	28.0	36.0	8524 5.600	10.800		12.0	102.0	55.0	45.0	8524 10.800
5.700		6.0	66.0	28.0	36.0	8524 5.700	10.900		12.0	102.0	55.0	45.0	8524 10.900
5.800		6.0	66.0	28.0	36.0	8524 5.800	11.000		12.0	102.0	55.0	45.0	8524 11.000
5.900		6.0	66.0	28.0	36.0	8524 5.900	11.100		12.0	102.0	55.0	45.0	8524 11.100
5.950	15/64	6.0	66.0	28.0	36.0	8524 5.950	11.110	7/16	12.0	102.0	55.0	45.0	8524 11.110
6.000		6.0	66.0	28.0	36.0	8524 6.000	11.200		12.0	102.0	55.0	45.0	8524 11.200
6.100		8.0	79.0	34.0	36.0	8524 6.100	11.300		12.0	102.0	55.0	45.0	8524 11.300
6.200		8.0	79.0	34.0	36.0	8524 6.200	11.400		12.0	102.0	55.0	45.0	8524 11.400
6.300		8.0	79.0	34.0	36.0	8524 6.300	11.500		12.0	102.0	55.0	45.0	8524 11.500
6.350	1/4	8.0	79.0	34.0	36.0	8524 6.350	11.510	29/64	12.0	102.0	55.0	45.0	8524 11.510
6.400		8.0	79.0	34.0	36.0	8524 6.400	11.600		12.0	102.0	55.0	45.0	8524 11.600
6.500		8.0	79.0	34.0	36.0	8524 6.500	11.700		12.0	102.0	55.0	45.0	8524 11.700
6.600		8.0	79.0	34.0	36.0	8524 6.600	11.800		12.0	102.0	55.0	45.0	8524 11.800
6.700		8.0	79.0	34.0	36.0	8524 6.700	11.900		12.0	102.0	55.0	45.0	8524 11.900
6.750	17/64	8.0	79.0	34.0	36.0	8524 6.750	11.910	15/32	12.0	102.0	55.0	45.0	8524 11.910
6.800		8.0	79.0	34.0	36.0	8524 6.800	12.000		12.0	102.0	55.0	45.0	8524 12.000
6.900		8.0	79.0	34.0	36.0	8524 6.900	12.200		14.0	107.0	60.0	45.0	8524 12.200
7.000		8.0	79.0	34.0	36.0	8524 7.000	12.300	31/64	14.0	107.0	60.0	45.0	8524 12.300
7.100		8.0	79.0	41.0	36.0	8524 7.100	12.500		14.0	107.0	60.0	45.0	8524 12.500
7.140	9/32	8.0	79.0	41.0	36.0	8524 7.140	12.700	1/2	14.0	107.0	60.0	45.0	8524 12.700
7.200		8.0	79.0	41.0	36.0	8524 7.200	12.800		14.0	107.0	60.0	45.0	8524 12.800
7.300		8.0	79.0	41.0	36.0	8524 7.300	13.000		14.0	107.0	60.0	45.0	8524 13.000
7.400		8.0	79.0	41.0	36.0	8524 7.400	13.300		14.0	107.0	60.0	45.0	8524 13.300
7.500		8.0	79.0	41.0	36.0	8524 7.500	13.490	17/32	14.0	107.0	60.0	45.0	8524 13.490
7.540	19/64	8.0	79.0	41.0	36.0	8524 7.540	13.500		14.0	107.0	60.0	45.0	8524 13.500
7.600		8.0	79.0	41.0	36.0	8524 7.600	13.700		14.0	107.0	60.0	45.0	8524 13.700
7.700		8.0	79.0	41.0	36.0	8524 7.700	14.000		14.0	107.0	60.0	45.0	8524 14.000
7.800		8.0	79.0	41.0	36.0	8524 7.800	14.200		16.0	115.0	65.0	48.0	8524 14.200
7.900		8.0	79.0	41.0	36.0	8524 7.900	14.290	9/16	16.0	115.0	65.0	48.0	8524 14.290
7.940	5/16	8.0	79.0	41.0	36.0	8524 7.940	14.300		16.0	115.0	65.0	48.0	8524 14.300



Article no.						8524	Article no.						8524
d1 mm	inch	d2 h6 mm	l1 mm	l2 mm	l3 mm	Order no.	d1 mm	inch	d2 h6 mm	l1 mm	l2 mm	l3 mm	Order no.
14.500		16.0	115.0	65.0	48.0	8524 14.500	17.000		18.0	123.0	73.0	48.0	8524 17.000
14.700		16.0	115.0	65.0	48.0	8524 14.700	17.300		18.0	123.0	73.0	48.0	8524 17.300
15.000		16.0	115.0	65.0	48.0	8524 15.000	17.500		18.0	123.0	73.0	48.0	8524 17.500
15.200		16.0	115.0	65.0	48.0	8524 15.200	18.000		18.0	123.0	73.0	48.0	8524 18.000
15.300		16.0	115.0	65.0	48.0	8524 15.300	18.500		20.0	131.0	79.0	50.0	8524 18.500
15.500		16.0	115.0	65.0	48.0	8524 15.500	18.900		20.0	131.0	79.0	50.0	8524 18.900
15.700		16.0	115.0	65.0	48.0	8524 15.700	19.000		20.0	131.0	79.0	50.0	8524 19.000
15.870	5/8	16.0	115.0	65.0	48.0	8524 15.870	19.050	3/4	20.0	131.0	79.0	50.0	8524 19.050
16.000		16.0	115.0	65.0	48.0	8524 16.000	19.300		20.0	131.0	79.0	50.0	8524 19.300
16.300		18.0	123.0	73.0	48.0	8524 16.300	19.500		20.0	131.0	79.0	50.0	8524 19.500
16.500		18.0	123.0	73.0	48.0	8524 16.500	20.000		20.0	131.0	79.0	50.0	8524 20.000
16.900		18.0	123.0	73.0	48.0	8524 16.900							



Ratio drills without coolant ducts

Article no. **2996**

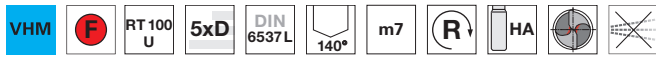

Web thinning $\geq \varnothing 2.500$ • facet point grind • main cutting edge form straight • optimised cutting edge geometry

Cutting data page 398

P	M	K	N	S	H
●	○	●	○	○	○

Ratio drills without coolant ducts

Article no. **2719**

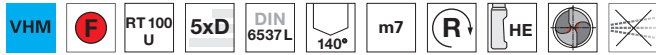

Web thinning $\geq \varnothing 3.000$ • facet point grind • main cutting edge form straight • optimised cutting edge geometry

Cutting data page 398

P	M	K	N	S	H
●	○	●	○	○	○

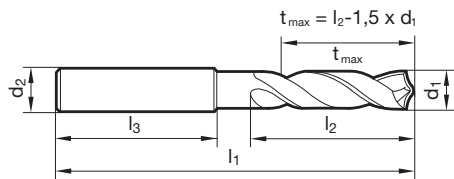

Article no.

2996

2719

Article no.

2996

2719

d1 mm	inch	d2 h6 mm	l1 mm	l2 mm	l3 mm	Order no.	
2.500		4.0	57.0	20.0	31.7	2996 2.500	
2.800		4.0	57.0	22.0	29.9	2996 2.800	
2.900		4.0	57.0	23.0	29.0	2996 2.900	
3.000		6.0	66.0	28.0	36.0	2996 3.000	2719 3.000
3.100		6.0	66.0	28.0	36.0	2996 3.100	2719 3.100
3.170	1/8	6.0	66.0	28.0	36.0	2996 3.170	2719 3.170
3.200		6.0	66.0	28.0	36.0	2996 3.200	2719 3.200
3.250		6.0	66.0	28.0	36.0	2996 3.250	2719 3.250
3.300		6.0	66.0	28.0	36.0	2996 3.300	2719 3.300
3.400		6.0	66.0	28.0	36.0	2996 3.400	2719 3.400
3.500		6.0	66.0	28.0	36.0	2996 3.500	2719 3.500
3.570	9/64	6.0	66.0	28.0	36.0	2996 3.570	2719 3.570
3.600		6.0	66.0	28.0	36.0	2996 3.600	2719 3.600
3.700		6.0	66.0	28.0	36.0	2996 3.700	2719 3.700
3.800		6.0	74.0	36.0	36.0	2996 3.800	2719 3.800
3.900		6.0	74.0	36.0	36.0	2996 3.900	2719 3.900
3.970	5/32	6.0	74.0	36.0	36.0	2996 3.970	2719 3.970
4.000		6.0	74.0	36.0	36.0	2996 4.000	2719 4.000
4.100		6.0	74.0	36.0	36.0	2996 4.100	2719 4.100
4.200		6.0	74.0	36.0	36.0	2996 4.200	2719 4.200
4.300		6.0	74.0	36.0	36.0	2996 4.300	2719 4.300
4.370	11/64	6.0	74.0	36.0	36.0	2996 4.370	2719 4.370
4.400		6.0	74.0	36.0	36.0	2996 4.400	2719 4.400
4.500		6.0	74.0	36.0	36.0	2996 4.500	2719 4.500
4.600		6.0	74.0	36.0	36.0	2996 4.600	2719 4.600
4.650		6.0	74.0	36.0	36.0	2996 4.650	2719 4.650
4.700		6.0	74.0	36.0	36.0	2996 4.700	2719 4.700
4.760	3/16	6.0	82.0	44.0	36.0	2996 4.760	2719 4.760
4.800		6.0	82.0	44.0	36.0	2996 4.800	2719 4.800
4.900		6.0	82.0	44.0	36.0	2996 4.900	2719 4.900
5.000		6.0	82.0	44.0	36.0	2996 5.000	2719 5.000
5.100		6.0	82.0	44.0	36.0	2996 5.100	2719 5.100
5.160	13/64	6.0	82.0	44.0	36.0	2996 5.160	2719 5.160
5.200		6.0	82.0	44.0	36.0	2996 5.200	2719 5.200
5.300		6.0	82.0	44.0	36.0	2996 5.300	2719 5.300
5.400		6.0	82.0	44.0	36.0	2996 5.400	2719 5.400
5.500		6.0	82.0	44.0	36.0	2996 5.500	2719 5.500
5.550		6.0	82.0	44.0	36.0	2996 5.550	2719 5.550
5.560	7/32	6.0	82.0	44.0	36.0	2996 5.560	2719 5.560
5.600		6.0	82.0	44.0	36.0	2996 5.600	2719 5.600
5.650		6.0	82.0	44.0	36.0	2996 5.650	
5.700		6.0	82.0	44.0	36.0	2996 5.700	2719 5.700
5.800		6.0	82.0	44.0	36.0	2996 5.800	2719 5.800
5.900		6.0	82.0	44.0	36.0	2996 5.900	2719 5.900
5.950	15/64	6.0	82.0	44.0	36.0	2996 5.950	2719 5.950
6.000		6.0	82.0	44.0	36.0	2996 6.000	2719 6.000
6.100		8.0	91.0	53.0	36.0	2996 6.100	2719 6.100
6.200		8.0	91.0	53.0	36.0	2996 6.200	2719 6.200
6.300		8.0	91.0	53.0	36.0	2996 6.300	2719 6.300
6.350	1/4	8.0	91.0	53.0	36.0	2996 6.350	2719 6.350
6.400		8.0	91.0	53.0	36.0	2996 6.400	2719 6.400
6.500		8.0	91.0	53.0	36.0	2996 6.500	2719 6.500
6.600		8.0	91.0	53.0	36.0	2996 6.600	2719 6.600
6.700		8.0	91.0	53.0	36.0	2996 6.700	2719 6.700

d1 mm	inch	d2 h6 mm	l1 mm	l2 mm	l3 mm	Order no.	
6.750	17/64	8.0	91.0	53.0	36.0	2996 6.750	2719 6.750
6.800		8.0	91.0	53.0	36.0	2996 6.800	2719 6.800
6.900		8.0	91.0	53.0	36.0	2996 6.900	2719 6.900
7.000		8.0	91.0	53.0	36.0	2996 7.000	2719 7.000
7.100		8.0	91.0	53.0	36.0	2996 7.100	2719 7.100
7.140	9/32	8.0	91.0	53.0	36.0	2996 7.140	2719 7.140
7.200		8.0	91.0	53.0	36.0	2996 7.200	2719 7.200
7.300		8.0	91.0	53.0	36.0	2996 7.300	2719 7.300
7.400		8.0	91.0	53.0	36.0	2996 7.400	2719 7.400
7.500		8.0	91.0	53.0	36.0	2996 7.500	2719 7.500
7.540	19/64	8.0	91.0	53.0	36.0	2996 7.540	2719 7.540
7.550		8.0	91.0	53.0	36.0	2996 7.550	
7.600		8.0	91.0	53.0	36.0	2996 7.600	2719 7.600
7.700		8.0	91.0	53.0	36.0	2996 7.700	2719 7.700
7.800		8.0	91.0	53.0	36.0	2996 7.800	2719 7.800
7.900		8.0	91.0	53.0	36.0	2996 7.900	2719 7.900
7.940	5/16	8.0	91.0	53.0	36.0	2996 7.940	2719 7.940
8.000		8.0	91.0	53.0	36.0	2996 8.000	2719 8.000
8.100		10.0	103.0	61.0	40.0	2996 8.100	2719 8.100
8.200		10.0	103.0	61.0	40.0	2996 8.200	2719 8.200
8.300		10.0	103.0	61.0	40.0	2996 8.300	2719 8.300
8.330	21/64	10.0	103.0	61.0	40.0	2996 8.330	2719 8.330
8.400		10.0	103.0	61.0	40.0	2996 8.400	2719 8.400
8.500		10.0	103.0	61.0	40.0	2996 8.500	2719 8.500
8.600		10.0	103.0	61.0	40.0	2996 8.600	2719 8.600
8.700		10.0	103.0	61.0	40.0	2996 8.700	2719 8.700
8.730	11/32	10.0	103.0	61.0	40.0	2996 8.730	2719 8.730
8.800		10.0	103.0	61.0	40.0	2996 8.800	2719 8.800
8.900		10.0	103.0	61.0	40.0	2996 8.900	2719 8.900
9.000		10.0	103.0	61.0	40.0	2996 9.000	2719 9.000
9.100		10.0	103.0	61.0	40.0	2996 9.100	2719 9.100
9.130	23/64	10.0	103.0	61.0	40.0	2996 9.130	2719 9.130
9.200		10.0	103.0	61.0	40.0	2996 9.200	2719 9.200
9.250		10.0	103.0	61.0	40.0	2996 9.250	2719 9.250
9.300		10.0	103.0	61.0	40.0	2996 9.300	2719 9.300
9.400		10.0	103.0	61.0	40.0	2996 9.400	2719 9.400
9.500		10.0	103.0	61.0	40.0	2996 9.500	2719 9.500
9.520	3/8	10.0	103.0	61.0	40.0	2996 9.520	2719 9.520
9.550		10.0	103.0	61.0	40.0	2996 9.550	
9.600		10.0	103.0	61.0	40.0	2996 9.600	2719 9.600
9.700		10.0	103.0	61.0	40.0	2996 9.700	2719 9.700
9.800		10.0	103.0	61.0	40.0	2996 9.800	2719 9.800
9.900		10.0	103.0	61.0	40.0	2996 9.900	2719 9.900
9.920	25/64	10.0	103.0	61.0	40.0	2996 9.920	2719 9.920
10.000		10.0	103.0	61.0	40.0	2996 10.000	2719 10.000
10.100		12.0	118.0	71.0	45.0	2996 10.100	2719 10.100
10.200		12.0	118.0	71.0	45.0	2996 10.200	2719 10.200
10.300		12.0	118.0	71.0	45.0	2996 10.300	2719 10.300
10.320	13/32	12.0	118.0	71.0	45.0	2996 10.320	2719 10.320
10.400		12.0	118.0	71.0	45.0	2996 10.400	2719 10.400
10.500		12.0	118.0	71.0	45.0	2996 10.500	2719 10.500
10.600		12.0	118.0	71.0	45.0	2996 10.600	2719 10.600
10.700		12.0	118.0	71.0	45.0	2996 10.700	2719 10.700
10.800		12.0	118.0	71.0	45.0	2996 10.800	2719 10.800



Article no.						2996	2719	Article no.						2996	2719
d1 mm	inch	d2 h6 mm	l1 mm	l2 mm	l3 mm	Order no.		d1 mm	inch	d2 h6 mm	l1 mm	l2 mm	l3 mm	Order no.	
10.900		12.0	118.0	71.0	45.0	2996 10.900	2719 10.900	14.100		16.0	133.0	83.0	48.0	2996 14.100	2719 14.100
11.000		12.0	118.0	71.0	45.0	2996 11.000	2719 11.000	14.200		16.0	133.0	83.0	48.0	2996 14.200	2719 14.200
11.100		12.0	118.0	71.0	45.0	2996 11.100	2719 11.100	14.290	9/16	16.0	133.0	83.0	48.0	2996 14.290	2719 14.290
11.110	7/16	12.0	118.0	71.0	45.0	2996 11.110	2719 11.110	14.300		16.0	133.0	83.0	48.0	2996 14.300	
11.200		12.0	118.0	71.0	45.0	2996 11.200	2719 11.200	14.400		16.0	133.0	83.0	48.0	2996 14.400	
11.300		12.0	118.0	71.0	45.0	2996 11.300	2719 11.300	14.500		16.0	133.0	83.0	48.0	2996 14.500	2719 14.500
11.400		12.0	118.0	71.0	45.0	2996 11.400	2719 11.400	14.700		16.0	133.0	83.0	48.0	2996 14.700	2719 14.700
11.500		12.0	118.0	71.0	45.0	2996 11.500	2719 11.500	14.800		16.0	133.0	83.0	48.0	2996 14.800	
11.600		12.0	118.0	71.0	45.0	2996 11.600	2719 11.600	15.000		16.0	133.0	83.0	48.0	2996 15.000	2719 15.000
11.700		12.0	118.0	71.0	45.0	2996 11.700	2719 11.700	15.100		16.0	133.0	83.0	48.0	2996 15.100	
11.800		12.0	118.0	71.0	45.0	2996 11.800	2719 11.800	15.200		16.0	133.0	83.0	48.0	2996 15.200	2719 15.200
11.900		12.0	118.0	71.0	45.0	2996 11.900	2719 11.900	15.300		16.0	133.0	83.0	48.0	2996 15.300	
11.910	15/32	12.0	118.0	71.0	45.0	2996 11.910	2719 11.910	15.500		16.0	133.0	83.0	48.0	2996 15.500	2719 15.500
12.000		12.0	118.0	71.0	45.0	2996 12.000	2719 12.000	15.600		16.0	133.0	83.0	48.0	2996 15.600	
12.100		14.0	124.0	77.0	45.0	2996 12.100	2719 12.100	15.700		16.0	133.0	83.0	48.0	2996 15.700	2719 15.700
12.200		14.0	124.0	77.0	45.0	2996 12.200	2719 12.200	15.800		16.0	133.0	83.0	48.0	2996 15.800	
12.300	31/64	14.0	124.0	77.0	45.0	2996 12.300		16.000		16.0	133.0	83.0	48.0	2996 16.000	2719 16.000
12.400		14.0	124.0	77.0	45.0	2996 12.400		16.500		18.0	143.0	93.0	48.0	2996 16.500	2719 16.500
12.500		14.0	124.0	77.0	45.0	2996 12.500	2719 12.500	17.000		18.0	143.0	93.0	48.0	2996 17.000	2719 17.000
12.600		14.0	124.0	77.0	45.0	2996 12.600		17.500		18.0	143.0	93.0	48.0	2996 17.500	2719 17.500
12.700	1/2	14.0	124.0	77.0	45.0	2996 12.700	2719 12.700	18.000		18.0	143.0	93.0	48.0	2996 18.000	2719 18.000
12.800		14.0	124.0	77.0	45.0	2996 12.800		18.500		20.0	153.0	101.0	50.0	2996 18.500	2719 18.500
13.000		14.0	124.0	77.0	45.0	2996 13.000	2719 13.000	19.000		20.0	153.0	101.0	50.0	2996 19.000	2719 19.000
13.100	33/64	14.0	124.0	77.0	45.0	2996 13.100		19.500		20.0	153.0	101.0	50.0	2996 19.500	2719 19.500
13.200		14.0	124.0	77.0	45.0	2996 13.200		19.500	3/4	20.0	153.0	101.0	50.0	2996 19.500	
13.300		14.0	124.0	77.0	45.0	2996 13.300		20.000		20.0	153.0	101.0	50.0	2996 20.000	2719 20.000
13.500		14.0	124.0	77.0	45.0	2996 13.500	2719 13.500								
13.700		14.0	124.0	77.0	45.0	2996 13.700	2719 13.700								
13.800		14.0	124.0	77.0	45.0	2996 13.800									
14.000		14.0	124.0	77.0	45.0	2996 14.000	2719 14.000								



Ratio drills without coolant ducts

Article no. **5651**



Cutting data page 398

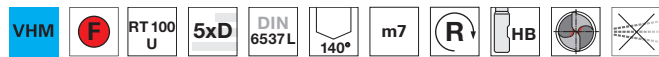

P	M	K	N	S	H
●	○	●	○	○	○

Web thinning ≥ Ø 3.000 • facet point grind • main cutting edge form straight • optimised cutting edge geometry

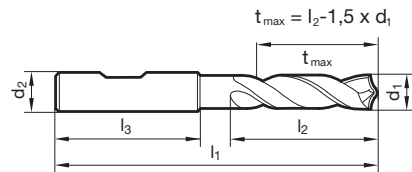

Article no. **5651**

Article no. **5651**

d1 mm	inch	d2 h6 mm	l1 mm	l2 mm	l3 mm	Order no.	d1 mm	inch	d2 h6 mm	l1 mm	l2 mm	l3 mm	Order no.
3.000		6.0	66.0	28.0	36.0	5651 3.000	8.000		8.0	91.0	53.0	36.0	5651 8.000
3.100		6.0	66.0	28.0	36.0	5651 3.100	8.100		10.0	103.0	61.0	40.0	5651 8.100
3.170	1/8	6.0	66.0	28.0	36.0	5651 3.170	8.200		10.0	103.0	61.0	40.0	5651 8.200
3.200		6.0	66.0	28.0	36.0	5651 3.200	8.300		10.0	103.0	61.0	40.0	5651 8.300
3.250		6.0	66.0	28.0	36.0	5651 3.250	8.330	21/64	10.0	103.0	61.0	40.0	5651 8.330
3.300		6.0	66.0	28.0	36.0	5651 3.300	8.400		10.0	103.0	61.0	40.0	5651 8.400
3.400		6.0	66.0	28.0	36.0	5651 3.400	8.500		10.0	103.0	61.0	40.0	5651 8.500
3.500		6.0	66.0	28.0	36.0	5651 3.500	8.600		10.0	103.0	61.0	40.0	5651 8.600
3.570	9/64	6.0	66.0	28.0	36.0	5651 3.570	8.700		10.0	103.0	61.0	40.0	5651 8.700
3.600		6.0	66.0	28.0	36.0	5651 3.600	8.730	11/32	10.0	103.0	61.0	40.0	5651 8.730
3.700		6.0	66.0	28.0	36.0	5651 3.700	8.800		10.0	103.0	61.0	40.0	5651 8.800
3.800		6.0	74.0	36.0	36.0	5651 3.800	8.900		10.0	103.0	61.0	40.0	5651 8.900
3.900		6.0	74.0	36.0	36.0	5651 3.900	9.000		10.0	103.0	61.0	40.0	5651 9.000
3.970	5/32	6.0	74.0	36.0	36.0	5651 3.970	9.100		10.0	103.0	61.0	40.0	5651 9.100
4.000		6.0	74.0	36.0	36.0	5651 4.000	9.130	23/64	10.0	103.0	61.0	40.0	5651 9.130
4.100		6.0	74.0	36.0	36.0	5651 4.100	9.200		10.0	103.0	61.0	40.0	5651 9.200
4.200		6.0	74.0	36.0	36.0	5651 4.200	9.250		10.0	103.0	61.0	40.0	5651 9.250
4.300		6.0	74.0	36.0	36.0	5651 4.300	9.300		10.0	103.0	61.0	40.0	5651 9.300
4.370	11/64	6.0	74.0	36.0	36.0	5651 4.370	9.400		10.0	103.0	61.0	40.0	5651 9.400
4.400		6.0	74.0	36.0	36.0	5651 4.400	9.500		10.0	103.0	61.0	40.0	5651 9.500
4.500		6.0	74.0	36.0	36.0	5651 4.500	9.520	3/8	10.0	103.0	61.0	40.0	5651 9.520
4.600		6.0	74.0	36.0	36.0	5651 4.600	9.600		10.0	103.0	61.0	40.0	5651 9.600
4.650		6.0	74.0	36.0	36.0	5651 4.650	9.700		10.0	103.0	61.0	40.0	5651 9.700
4.700		6.0	74.0	36.0	36.0	5651 4.700	9.800		10.0	103.0	61.0	40.0	5651 9.800
4.760	3/16	6.0	82.0	44.0	36.0	5651 4.760	9.900		10.0	103.0	61.0	40.0	5651 9.900
4.800		6.0	82.0	44.0	36.0	5651 4.800	9.920	25/64	10.0	103.0	61.0	40.0	5651 9.920
4.900		6.0	82.0	44.0	36.0	5651 4.900	10.000		10.0	103.0	61.0	40.0	5651 10.000
5.000		6.0	82.0	44.0	36.0	5651 5.000	10.100		12.0	118.0	71.0	45.0	5651 10.100
5.100		6.0	82.0	44.0	36.0	5651 5.100	10.200		12.0	118.0	71.0	45.0	5651 10.200
5.160	13/64	6.0	82.0	44.0	36.0	5651 5.160	10.300		12.0	118.0	71.0	45.0	5651 10.300
5.200		6.0	82.0	44.0	36.0	5651 5.200	10.320	13/32	12.0	118.0	71.0	45.0	5651 10.320
5.300		6.0	82.0	44.0	36.0	5651 5.300	10.400		12.0	118.0	71.0	45.0	5651 10.400
5.400		6.0	82.0	44.0	36.0	5651 5.400	10.500		12.0	118.0	71.0	45.0	5651 10.500
5.500		6.0	82.0	44.0	36.0	5651 5.500	10.600		12.0	118.0	71.0	45.0	5651 10.600
5.550		6.0	82.0	44.0	36.0	5651 5.550	10.700		12.0	118.0	71.0	45.0	5651 10.700
5.560	7/32	6.0	82.0	44.0	36.0	5651 5.560	10.800		12.0	118.0	71.0	45.0	5651 10.800
5.600		6.0	82.0	44.0	36.0	5651 5.600	10.900		12.0	118.0	71.0	45.0	5651 10.900
5.700		6.0	82.0	44.0	36.0	5651 5.700	11.000		12.0	118.0	71.0	45.0	5651 11.000
5.800		6.0	82.0	44.0	36.0	5651 5.800	11.100		12.0	118.0	71.0	45.0	5651 11.100
5.900		6.0	82.0	44.0	36.0	5651 5.900	11.110	7/16	12.0	118.0	71.0	45.0	5651 11.110
5.950	15/64	6.0	82.0	44.0	36.0	5651 5.950	11.200		12.0	118.0	71.0	45.0	5651 11.200
6.000		6.0	82.0	44.0	36.0	5651 6.000	11.300		12.0	118.0	71.0	45.0	5651 11.300
6.100		8.0	91.0	53.0	36.0	5651 6.100	11.400		12.0	118.0	71.0	45.0	5651 11.400
6.200		8.0	91.0	53.0	36.0	5651 6.200	11.500		12.0	118.0	71.0	45.0	5651 11.500
6.300		8.0	91.0	53.0	36.0	5651 6.300	11.600		12.0	118.0	71.0	45.0	5651 11.600
6.350	1/4	8.0	91.0	53.0	36.0	5651 6.350	11.700		12.0	118.0	71.0	45.0	5651 11.700
6.400		8.0	91.0	53.0	36.0	5651 6.400	11.800		12.0	118.0	71.0	45.0	5651 11.800
6.500		8.0	91.0	53.0	36.0	5651 6.500	11.900		12.0	118.0	71.0	45.0	5651 11.900
6.600		8.0	91.0	53.0	36.0	5651 6.600	11.910	15/32	12.0	118.0	71.0	45.0	5651 11.910
6.700		8.0	91.0	53.0	36.0	5651 6.700	12.000		12.0	118.0	71.0	45.0	5651 12.000
6.750	17/64	8.0	91.0	53.0	36.0	5651 6.750	12.200		14.0	124.0	77.0	45.0	5651 12.200
6.800		8.0	91.0	53.0	36.0	5651 6.800	12.500		14.0	124.0	77.0	45.0	5651 12.500
6.900		8.0	91.0	53.0	36.0	5651 6.900	12.700	1/2	14.0	124.0	77.0	45.0	5651 12.700
7.000		8.0	91.0	53.0	36.0	5651 7.000	13.000		14.0	124.0	77.0	45.0	5651 13.000
7.100		8.0	91.0	53.0	36.0	5651 7.100	13.500		14.0	124.0	77.0	45.0	5651 13.500
7.140	9/32	8.0	91.0	53.0	36.0	5651 7.140	13.700		14.0	124.0	77.0	45.0	5651 13.700
7.200		8.0	91.0	53.0	36.0	5651 7.200	14.000		14.0	124.0	77.0	45.0	5651 14.000
7.300		8.0	91.0	53.0	36.0	5651 7.300	14.200		16.0	133.0	83.0	48.0	5651 14.200
7.400		8.0	91.0	53.0	36.0	5651 7.400	14.290	9/16	16.0	133.0	83.0	48.0	5651 14.290
7.500		8.0	91.0	53.0	36.0	5651 7.500	14.500		16.0	133.0	83.0	48.0	5651 14.500
7.540	19/64	8.0	91.0	53.0	36.0	5651 7.540	14.700		16.0	133.0	83.0	48.0	5651 14.700
7.600		8.0	91.0	53.0	36.0	5651 7.600	15.000		16.0	133.0	83.0	48.0	5651 15.000
7.700		8.0	91.0	53.0	36.0	5651 7.700	15.200		16.0	133.0	83.0	48.0	5651 15.200
7.800		8.0	91.0	53.0	36.0	5651 7.800	15.500		16.0	133.0	83.0	48.0	5651 15.500
7.900		8.0	91.0	53.0	36.0	5651 7.900	15.700		16.0	133.0	83.0	48.0	5651 15.700
7.940	5/16	8.0	91.0	53.0	36.0	5651 7.940	16.000		16.0	133.0	83.0	48.0	5651 16.000



Article no.						5651
d1 mm	inch	d2 h6 mm	l1 mm	l2 mm	l3 mm	Order no.
16.500		18.0	143.0	93.0	48.0	5651 16.500
17.000		18.0	143.0	93.0	48.0	5651 17.000
17.500		18.0	143.0	93.0	48.0	5651 17.500
18.000		18.0	143.0	93.0	48.0	5651 18.000
18.500		20.0	153.0	101.0	50.0	5651 18.500
19.000		20.0	153.0	101.0	50.0	5651 19.000

Article no.						5651
d1 mm	inch	d2 h6 mm	l1 mm	l2 mm	l3 mm	Order no.
19.500		20.0	153.0	101.0	50.0	5651 19.500
20.000		20.0	153.0	101.0	50.0	5651 20.000



Ratio drills without coolant ducts

Article no. **2474**



Cutting data page 398

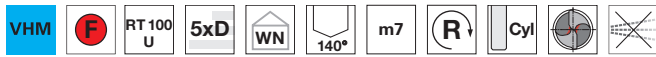

Web thinning $\geq \varnothing 5.000$ • facet point grind • main cutting edge form straight • optimised cutting edge geometry

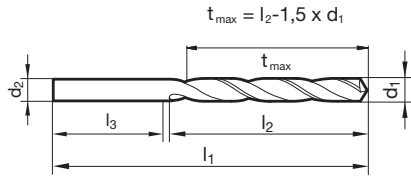

Article no. **2474**

Article no. **2474**

d1 mm	inch	d2 mm	l1 mm	l2 mm	l3 mm	Order no.	d1 mm	inch	d2 mm	l1 mm	l2 mm	l3 mm	Order no.
5.000		5.0	73.0	34.0	39.0	2474 5.000	9.300		9.3	102.0	58.0	44.0	2474 9.300
5.100		5.1	76.0	38.0	38.0	2474 5.100	9.500		9.5	102.0	58.0	44.0	2474 9.500
5.200		5.2	76.0	38.0	38.0	2474 5.200	9.600		9.6	105.0	60.0	45.0	2474 9.600
5.300		5.3	76.0	38.0	38.0	2474 5.300	9.700		9.7	105.0	60.0	45.0	2474 9.700
5.400		5.4	76.0	38.0	38.0	2474 5.400	9.800		9.8	105.0	60.0	45.0	2474 9.800
5.500		5.5	76.0	38.0	38.0	2474 5.500	10.000		10.0	105.0	60.0	45.0	2474 10.000
5.600		5.6	81.0	41.0	40.0	2474 5.600	10.200		10.2	112.0	66.0	46.0	2474 10.200
5.700		5.7	81.0	41.0	40.0	2474 5.700	10.300		10.3	112.0	66.0	46.0	2474 10.300
5.800		5.8	81.0	41.0	40.0	2474 5.800	10.400		10.4	112.0	66.0	46.0	2474 10.400
5.900		5.9	81.0	41.0	40.0	2474 5.900	10.500		10.5	112.0	66.0	46.0	2474 10.500
6.000		6.0	81.0	41.0	40.0	2474 6.000	10.600		10.6	114.0	68.0	46.0	2474 10.600
6.100		6.1	81.0	41.0	40.0	2474 6.100	10.700		10.7	114.0	68.0	46.0	2474 10.700
6.200		6.2	81.0	41.0	40.0	2474 6.200	10.800		10.8	114.0	68.0	46.0	2474 10.800
6.300		6.3	81.0	41.0	40.0	2474 6.300	10.900		10.9	114.0	68.0	46.0	2474 10.900
6.400		6.4	81.0	41.0	40.0	2474 6.400	11.000		11.0	114.0	68.0	46.0	2474 11.000
6.500		6.5	81.0	41.0	40.0	2474 6.500	11.100		11.1	118.0	71.0	47.0	2474 11.100
6.600		6.6	83.0	43.0	40.0	2474 6.600	11.200		11.2	118.0	71.0	47.0	2474 11.200
6.700		6.7	83.0	43.0	40.0	2474 6.700	11.400		11.4	118.0	71.0	47.0	2474 11.400
6.800		6.8	83.0	43.0	40.0	2474 6.800	11.500		11.5	118.0	71.0	47.0	2474 11.500
6.900		6.9	83.0	43.0	40.0	2474 6.900	11.600		11.6	121.0	73.0	48.0	2474 11.600
7.000		7.0	83.0	43.0	40.0	2474 7.000	11.700		11.7	121.0	73.0	48.0	2474 11.700
7.100		7.1	87.0	45.0	42.0	2474 7.100	11.800		11.8	121.0	73.0	48.0	2474 11.800
7.200		7.2	87.0	45.0	42.0	2474 7.200	11.900		11.9	121.0	73.0	48.0	2474 11.900
7.300		7.3	87.0	45.0	42.0	2474 7.300	12.000		12.0	121.0	73.0	48.0	2474 12.000
7.400		7.4	87.0	45.0	42.0	2474 7.400	12.500		12.5	135.0	76.0	59.0	2474 12.500
7.500		7.5	87.0	45.0	42.0	2474 7.500	12.700	1/2	12.7	137.0	78.0	59.0	2474 12.700
7.600		7.6	90.0	48.0	42.0	2474 7.600	13.000		13.0	137.0	78.0	59.0	2474 13.000
7.700		7.7	90.0	48.0	42.0	2474 7.700	13.500		13.5	144.0	84.0	60.0	2474 13.500
7.800		7.8	90.0	48.0	42.0	2474 7.800	14.000		14.0	147.0	86.0	61.0	2474 14.000
7.900		7.9	90.0	48.0	42.0	2474 7.900	14.500		14.5	151.0	89.0	62.0	2474 14.500
8.000		8.0	90.0	48.0	42.0	2474 8.000	15.000		15.0	153.0	91.0	62.0	2474 15.000
8.100		8.1	96.0	53.0	43.0	2474 8.100	15.500		15.5	157.0	94.0	63.0	2474 15.500
8.200		8.2	96.0	53.0	43.0	2474 8.200	16.000		16.0	160.0	96.0	64.0	2474 16.000
8.300		8.3	96.0	53.0	43.0	2474 8.300							
8.400		8.4	96.0	53.0	43.0	2474 8.400							
8.500		8.5	96.0	53.0	43.0	2474 8.500							
8.600		8.6	98.0	55.0	43.0	2474 8.600							
8.700		8.7	98.0	55.0	43.0	2474 8.700							
8.800		8.8	98.0	55.0	43.0	2474 8.800							
9.000		9.0	98.0	55.0	43.0	2474 9.000							
9.100		9.1	102.0	58.0	44.0	2474 9.100							
9.200		9.2	102.0	58.0	44.0	2474 9.200							



Ratio drills with coolant ducts

Article no. 2477



Cutting data page 400

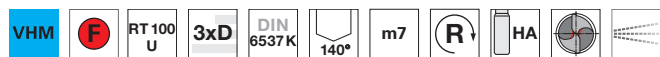

Web thinning $\geq \varnothing 3.000$ • facet point grind • main cutting edge form straight • optimised cutting edge geometry

P	M	K	N	S	H
●	○	●	○	○	○

Ratio drills with coolant ducts

Article no. 2469



Cutting data page 400

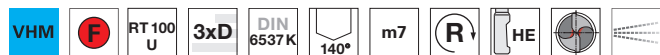

Web thinning $\geq \varnothing 3.000$ • facet point grind • main cutting edge form straight • optimised cutting edge geometry

P	M	K	N	S	H
●	○	●	○	○	○

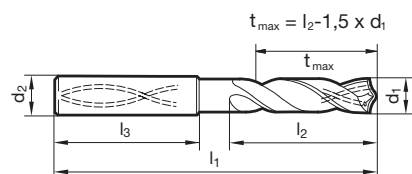

Article no.

2477

2469

Article no.

2477

2469

d1 mm	inch	d2 h6 mm	l1 mm	l2 mm	l3 mm	Order no.		d1 mm	inch	d2 h6 mm	l1 mm	l2 mm	l3 mm	Order no.	
3.000		6.0	62.0	20.0	36.0	2477 3.000	2469 3.000	6.530		8.0	79.0	34.0	36.0	2477 6.530	
3.100		6.0	62.0	20.0	36.0	2477 3.100	2469 3.100	6.600		8.0	79.0	34.0	36.0	2477 6.600	2469 6.600
3.170	1/8	6.0	62.0	20.0	36.0	2477 3.170	2469 3.170	6.700		8.0	79.0	34.0	36.0	2477 6.700	2469 6.700
3.200		6.0	62.0	20.0	36.0	2477 3.200	2469 3.200	6.750	17/64	8.0	79.0	34.0	36.0	2477 6.750	2469 6.750
3.250		6.0	62.0	20.0	36.0	2477 3.250	2469 3.250	6.800		8.0	79.0	34.0	36.0	2477 6.800	2469 6.800
3.300		6.0	62.0	20.0	36.0	2477 3.300	2469 3.300	6.900		8.0	79.0	34.0	36.0	2477 6.900	2469 6.900
3.400		6.0	62.0	20.0	36.0	2477 3.400	2469 3.400	7.000		8.0	79.0	34.0	36.0	2477 7.000	2469 7.000
3.500		6.0	62.0	20.0	36.0	2477 3.500	2469 3.500	7.100		8.0	79.0	41.0	36.0	2477 7.100	2469 7.100
3.570	9/64	6.0	62.0	20.0	36.0	2477 3.570	2469 3.570	7.140	9/32	8.0	79.0	41.0	36.0	2477 7.140	2469 7.140
3.600		6.0	62.0	20.0	36.0	2477 3.600	2469 3.600	7.200		8.0	79.0	41.0	36.0	2477 7.200	2469 7.200
3.700		6.0	62.0	20.0	36.0	2477 3.700	2469 3.700	7.300		8.0	79.0	41.0	36.0	2477 7.300	2469 7.300
3.800		6.0	66.0	24.0	36.0	2477 3.800	2469 3.800	7.400		8.0	79.0	41.0	36.0	2477 7.400	2469 7.400
3.900		6.0	66.0	24.0	36.0	2477 3.900	2469 3.900	7.450		8.0	79.0	41.0	36.0	2477 7.450	2469 7.450
3.970	5/32	6.0	66.0	24.0	36.0	2477 3.970	2469 3.970	7.500		8.0	79.0	41.0	36.0	2477 7.500	2469 7.500
4.000		6.0	66.0	24.0	36.0	2477 4.000	2469 4.000	7.540	19/64	8.0	79.0	41.0	36.0	2477 7.540	2469 7.540
4.040		6.0	66.0	24.0	36.0	2477 4.040		7.550		8.0	79.0	41.0	36.0	2477 7.550	
4.100		6.0	66.0	24.0	36.0	2477 4.100	2469 4.100	7.600		8.0	79.0	41.0	36.0	2477 7.600	2469 7.600
4.200		6.0	66.0	24.0	36.0	2477 4.200	2469 4.200	7.650		8.0	79.0	41.0	36.0	2477 7.650	2469 7.650
4.300		6.0	66.0	24.0	36.0	2477 4.300	2469 4.300	7.700		8.0	79.0	41.0	36.0	2477 7.700	2469 7.700
4.370	11/64	6.0	66.0	24.0	36.0	2477 4.370	2469 4.370	7.800		8.0	79.0	41.0	36.0	2477 7.800	2469 7.800
4.400		6.0	66.0	24.0	36.0	2477 4.400	2469 4.400	7.900		8.0	79.0	41.0	36.0	2477 7.900	2469 7.900
4.450		6.0	66.0	24.0	36.0	2477 4.450	2469 4.450	7.940	5/16	8.0	79.0	41.0	36.0	2477 7.940	2469 7.940
4.500		6.0	66.0	24.0	36.0	2477 4.500	2469 4.500	8.000		8.0	79.0	41.0	36.0	2477 8.000	2469 8.000
4.600		6.0	66.0	24.0	36.0	2477 4.600	2469 4.600	8.100		10.0	89.0	47.0	40.0	2477 8.100	2469 8.100
4.650		6.0	66.0	24.0	36.0	2477 4.650	2469 4.650	8.200		10.0	89.0	47.0	40.0	2477 8.200	2469 8.200
4.700		6.0	66.0	24.0	36.0	2477 4.700	2469 4.700	8.300		10.0	89.0	47.0	40.0	2477 8.300	2469 8.300
4.760	3/16	6.0	66.0	28.0	36.0	2477 4.760	2469 4.760	8.330	21/64	10.0	89.0	47.0	40.0	2477 8.330	2469 8.330
4.800		6.0	66.0	28.0	36.0	2477 4.800	2469 4.800	8.400		10.0	89.0	47.0	40.0	2477 8.400	2469 8.400
4.900		6.0	66.0	28.0	36.0	2477 4.900	2469 4.900	8.500		10.0	89.0	47.0	40.0	2477 8.500	2469 8.500
5.000		6.0	66.0	28.0	36.0	2477 5.000	2469 5.000	8.550		10.0	89.0	47.0	40.0	2477 8.550	2469 8.550
5.100		6.0	66.0	28.0	36.0	2477 5.100	2469 5.100	8.600		10.0	89.0	47.0	40.0	2477 8.600	2469 8.600
5.110		6.0	66.0	28.0	36.0	2477 5.110		8.700		10.0	89.0	47.0	40.0	2477 8.700	2469 8.700
5.160	13/64	6.0	66.0	28.0	36.0	2477 5.160	2469 5.160	8.730	11/32	10.0	89.0	47.0	40.0	2477 8.730	2469 8.730
5.200		6.0	66.0	28.0	36.0	2477 5.200	2469 5.200	8.800		10.0	89.0	47.0	40.0	2477 8.800	2469 8.800
5.300		6.0	66.0	28.0	36.0	2477 5.300	2469 5.300	8.900		10.0	89.0	47.0	40.0	2477 8.900	2469 8.900
5.400		6.0	66.0	28.0	36.0	2477 5.400	2469 5.400	9.000		10.0	89.0	47.0	40.0	2477 9.000	2469 9.000
5.410		6.0	66.0	28.0	36.0	2477 5.410		9.050		10.0	89.0	47.0	40.0	2477 9.050	2469 9.050
5.500		6.0	66.0	28.0	36.0	2477 5.500	2469 5.500	9.100		10.0	89.0	47.0	40.0	2477 9.100	2469 9.100
5.550		6.0	66.0	28.0	36.0	2477 5.550	2469 5.550	9.130	23/64	10.0	89.0	47.0	40.0	2477 9.130	2469 9.130
5.560	7/32	6.0	66.0	28.0	36.0	2477 5.560	2469 5.560	9.200		10.0	89.0	47.0	40.0	2477 9.200	2469 9.200
5.600		6.0	66.0	28.0	36.0	2477 5.600	2469 5.600	9.250		10.0	89.0	47.0	40.0	2477 9.250	2469 9.250
5.650		6.0	66.0	28.0	36.0	2477 5.650	2469 5.650	9.300		10.0	89.0	47.0	40.0	2477 9.300	2469 9.300
5.700		6.0	66.0	28.0	36.0	2477 5.700	2469 5.700	9.340		10.0	89.0	47.0	40.0	2477 9.340	
5.750		6.0	66.0	28.0	36.0	2477 5.750	2469 5.750	9.400		10.0	89.0	47.0	40.0	2477 9.400	2469 9.400
5.800		6.0	66.0	28.0	36.0	2477 5.800	2469 5.800	9.500		10.0	89.0	47.0	40.0	2477 9.500	2469 9.500
5.900		6.0	66.0	28.0	36.0	2477 5.900	2469 5.900	9.520	3/8	10.0	89.0	47.0	40.0	2477 9.520	2469 9.520
5.950	15/64	6.0	66.0	28.0	36.0	2477 5.950	2469 5.950	9.550		10.0	89.0	47.0	40.0	2477 9.550	2469 9.550
6.000		6.0	66.0	28.0	36.0	2477 6.000	2469 6.000	9.600		10.0	89.0	47.0	40.0	2477 9.600	2469 9.600
6.100		8.0	79.0	34.0	36.0	2477 6.100	2469 6.100	9.700		10.0	89.0	47.0	40.0	2477 9.700	2469 9.700
6.200		8.0	79.0	34.0	36.0	2477 6.200	2469 6.200	9.800		10.0	89.0	47.0	40.0	2477 9.800	2469 9.800
6.300		8.0	79.0	34.0	36.0	2477 6.300	2469 6.300	9.900		10.0	89.0	47.0	40.0	2477 9.900	2469 9.900
6.350	1/4	8.0	79.0	34.0	36.0	2477 6.350	2469 6.350	9.920	25/64	10.0	89.0	47.0	40.0	2477 9.920	2469 9.920
6.400		8.0	79.0	34.0	36.0	2477 6.400	2469 6.400	10.000		10.0	89.0	47.0	40.0	2477 10.000	2469 10.000
6.500		8.0	79.0	34.0	36.0	2477 6.500	2469 6.500	10.100		12.0	102.0	55.0	45.0	2477 10.100	2469 10.100



Solid carbide drills

						Article no.										Article no.											
						2477	2469							2477	2469												
d1		d2 h6	l1	l2	l3	Order no.						d1		d2 h6	l1	l2	l3	Order no.									
mm	inch	mm	mm	mm	mm							mm	inch	mm	mm	mm	mm										
10.200		12.0	102.0	55.0	45.0	2477 10.200	2469 10.200							15.080	19/32	16.0	115.0	65.0	48.0	2477 15.080							
10.300		12.0	102.0	55.0	45.0	2477 10.300	2469 10.300							15.100		16.0	115.0	65.0	48.0	2477 15.100	2469 15.100						
10.320	13/32	12.0	102.0	55.0	45.0	2477 10.320	2469 10.320							15.200		16.0	115.0	65.0	48.0	2477 15.200	2469 15.200						
10.400		12.0	102.0	55.0	45.0	2477 10.400	2469 10.400							15.300		16.0	115.0	65.0	48.0	2477 15.300	2469 15.300						
10.500		12.0	102.0	55.0	45.0	2477 10.500	2469 10.500							15.480	39/64	16.0	115.0	65.0	48.0	2477 15.480							
10.600		12.0	102.0	55.0	45.0	2477 10.600	2469 10.600							15.500		16.0	115.0	65.0	48.0	2477 15.500	2469 15.500						
10.700		12.0	102.0	55.0	45.0	2477 10.700	2469 10.700							15.550		16.0	115.0	65.0	48.0	2477 15.550	2469 15.550						
10.720	27/64	12.0	102.0	55.0	45.0	2477 10.720							15.600		16.0	115.0	65.0	48.0	2477 15.600	2469 15.600							
10.800		12.0	102.0	55.0	45.0	2477 10.800	2469 10.800							15.700		16.0	115.0	65.0	48.0	2477 15.700	2469 15.700						
10.900		12.0	102.0	55.0	45.0	2477 10.900	2469 10.900							15.800		16.0	115.0	65.0	48.0	2477 15.800							
11.000		12.0	102.0	55.0	45.0	2477 11.000	2469 11.000							15.870	5/8	16.0	115.0	65.0	48.0	2477 15.870							
11.100		12.0	102.0	55.0	45.0	2477 11.100	2469 11.100							15.900		16.0	115.0	65.0	48.0	2477 15.900	2469 15.900						
11.110	7/16	12.0	102.0	55.0	45.0	2477 11.110	2469 11.110							16.000		16.0	115.0	65.0	48.0	2477 16.000	2469 16.000						
11.200		12.0	102.0	55.0	45.0	2477 11.200	2469 11.200							16.100		18.0	123.0	73.0	48.0	2477 16.100	2469 16.100						
11.300		12.0	102.0	55.0	45.0	2477 11.300	2469 11.300							16.200		18.0	123.0	73.0	48.0	2477 16.200	2469 16.200						
11.400		12.0	102.0	55.0	45.0	2477 11.400	2469 11.400							16.270	41/64	18.0	123.0	73.0	48.0	2477 16.270							
11.500		12.0	102.0	55.0	45.0	2477 11.500	2469 11.500							16.500		18.0	123.0	73.0	48.0	2477 16.500	2469 16.500						
11.510	29/64	12.0	102.0	55.0	45.0	2477 11.510							16.670	21/32	18.0	123.0	73.0	48.0	2477 16.670								
11.550		12.0	102.0	55.0	45.0	2477 11.550	2469 11.550							16.700		18.0	123.0	73.0	48.0	2477 16.700							
11.600		12.0	102.0	55.0	45.0	2477 11.600	2469 11.600							16.900		18.0	123.0	73.0	48.0	2477 16.900	2469 16.900						
11.700		12.0	102.0	55.0	45.0	2477 11.700	2469 11.700							17.000		18.0	123.0	73.0	48.0	2477 17.000	2469 17.000						
11.800		12.0	102.0	55.0	45.0	2477 11.800	2469 11.800							17.070	43/64	18.0	123.0	73.0	48.0	2477 17.070							
11.900		12.0	102.0	55.0	45.0	2477 11.900	2469 11.900							17.200		18.0	123.0	73.0	48.0	2477 17.200							
11.910	15/32	12.0	102.0	55.0	45.0	2477 11.910	2469 11.910							17.300		18.0	123.0	73.0	48.0	2477 17.300	2469 17.300						
12.000		12.0	102.0	55.0	45.0	2477 12.000	2469 12.000							17.400		18.0	123.0	73.0	48.0	2477 17.400							
12.100		14.0	107.0	60.0	45.0	2477 12.100	2469 12.100							17.460	11/16	18.0	123.0	73.0	48.0	2477 17.460							
12.200		14.0	107.0	60.0	45.0	2477 12.200	2469 12.200							17.500		18.0	123.0	73.0	48.0	2477 17.500	2469 17.500						
12.300	31/64	14.0	107.0	60.0	45.0	2477 12.300	2469 12.300							17.550		18.0	123.0	73.0	48.0	2477 17.550	2469 17.550						
12.400		14.0	107.0	60.0	45.0	2477 12.400	2469 12.400							17.600		18.0	123.0	73.0	48.0	2477 17.600							
12.500		14.0	107.0	60.0	45.0	2477 12.500	2469 12.500							17.700		18.0	123.0	73.0	48.0	2477 17.700	2469 17.700						
12.600		14.0	107.0	60.0	45.0	2477 12.600							17.860	45/64	18.0	123.0	73.0	48.0	2477 17.860								
12.700	1/2	14.0	107.0	60.0	45.0	2477 12.700	2469 12.700							17.900		18.0	123.0	73.0	48.0	2477 17.900	2469 17.900						
12.800		14.0	107.0	60.0	45.0	2477 12.800							18.000		18.0	123.0	73.0	48.0	2477 18.000	2469 18.000							
12.900		14.0	107.0	60.0	45.0	2477 12.900							18.260	23/32	20.0	131.0	79.0	50.0	2477 18.260								
13.000		14.0	107.0	60.0	45.0	2477 13.000	2469 13.000							18.300		20.0	131.0	79.0	50.0	2477 18.300	2469 18.300						
13.100	33/64	14.0	107.0	60.0	45.0	2477 13.100	2469 13.100							18.500		20.0	131.0	79.0	50.0	2477 18.500	2469 18.500						
13.200		14.0	107.0	60.0	45.0	2477 13.200	2469 13.200							18.700		20.0	131.0	79.0	50.0	2477 18.700							
13.300		14.0	107.0	60.0	45.0	2477 13.300	2469 13.300							18.900		20.0	131.0	79.0	50.0	2477 18.900	2469 18.900						
13.400		14.0	107.0	60.0	45.0	2477 13.400	2469 13.400							19.000		20.0	131.0	79.0	50.0	2477 19.000	2469 19.000						
13.490	17/32	14.0	107.0	60.0	45.0	2477 13.490							19.050	3/4	20.0	131.0	79.0	50.0	2477 19.050								
13.500		14.0	107.0	60.0	45.0	2477 13.500	2469 13.500							19.250		20.0	131.0	79.0	50.0	2477 19.250							
13.550		14.0	107.0	60.0	45.0	2477 13.550	2469 13.550							19.300		20.0	131.0	79.0	50.0	2477 19.300	2469 19.300						
13.600		14.0	107.0	60.0	45.0	2477 13.600							19.446		20.0	131.0	79.0	50.0	2477 19.446								
13.700		14.0	107.0	60.0	45.0	2477 13.700	2469 13.700							19.500		20.0	131.0	79.0	50.0	2477 19.500	2469 19.500						
13.800		14.0	107.0	60.0	45.0	2477 13.800							19.550		20.0	131.0	79.0	50.0	2477 19.550	2469 19.550							
13.890	35/64	14.0	107.0	60.0	45.0	2477 13.890							19.700		20.0	131.0	79.0	50.0	2477 19.700								
13.900		14.0	107.0	60.0	45.0	2477 13.900							19.840	25/32	20.0	131.0	79.0	50.0	2477 19.840								
14.000		14.0	107.0	60.0	45.0	2477 14.000	2469 14.000							19.900		20.0	131.0	79.0	50.0	2477 19.900	2469 19.900						
14.100		16.0	115.0	65.0	48.0	2477 14.100	2469 14.100							20.000		20.0	131.0	79.0	50.0	2477 20.000	2469 20.000						
14.200		16.0	115.0	65.0	48.0	2477 14.200	2469 14.200																				
14.290	9/16	16.0	115.0	65.0	48.0	2477 14.290	2469 14.290																				
14.300		16.0	115.0	65.0	48.0	2477 14.300	2469 14.300																				
14.400		16.0	115.0	65.0	48.0	2477 14.400																					
14.500		16.0	115.0	65.0	48.0	2477 14.500	2469 14.500																				
14.600		16.0	115.0	65.0	48.0	2477 14.600																					
14.680	37/64	16.0	115.0	65.0	48.0	2477 14.680																					
14.700		16.0	115.0	65.0	48.0	2477 14.700	2469 14.700																				
14.800		16.0	115.0	65.0	48.0	2477 14.800	2469 14.800																				
14.900		16.0	115.0	65.0	48.0	2477 14.900	2469 14.900																				
15.000		16.0	115.0	65.0	48.0	2477 15.000	2469 15.000																				



Ratio drills with coolant ducts

Article no. 6023



Cutting data page 400

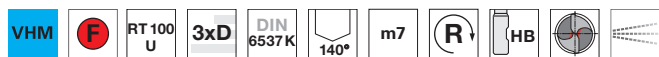

P	M	K	N	S	H
●	○	●	○	○	○

Web thinning ≥ Ø 3.000 • facet point grind • main cutting edge form straight • optimised cutting edge geometry

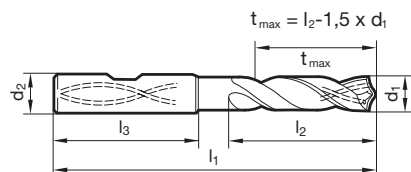

Article no. 6023

Article no. 6023

d1 mm	inch	d2 h6 mm	l1 mm	l2 mm	l3 mm	Order no.	d1 mm	inch	d2 h6 mm	l1 mm	l2 mm	l3 mm	Order no.
3.000		6.0	62.0	20.0	36.0	6023 3.000	7.450		8.0	79.0	41.0	36.0	6023 7.450
3.100		6.0	62.0	20.0	36.0	6023 3.100	7.500		8.0	79.0	41.0	36.0	6023 7.500
3.170	1/8	6.0	62.0	20.0	36.0	6023 3.170	7.540	19/64	8.0	79.0	41.0	36.0	6023 7.540
3.200		6.0	62.0	20.0	36.0	6023 3.200	7.600		8.0	79.0	41.0	36.0	6023 7.600
3.250		6.0	62.0	20.0	36.0	6023 3.250	7.700		8.0	79.0	41.0	36.0	6023 7.700
3.300		6.0	62.0	20.0	36.0	6023 3.300	7.800		8.0	79.0	41.0	36.0	6023 7.800
3.400		6.0	62.0	20.0	36.0	6023 3.400	7.900		8.0	79.0	41.0	36.0	6023 7.900
3.500		6.0	62.0	20.0	36.0	6023 3.500	7.940	5/16	8.0	79.0	41.0	36.0	6023 7.940
3.570	9/64	6.0	62.0	20.0	36.0	6023 3.570	8.000		8.0	79.0	41.0	36.0	6023 8.000
3.600		6.0	62.0	20.0	36.0	6023 3.600	8.100		10.0	89.0	47.0	40.0	6023 8.100
3.700		6.0	62.0	20.0	36.0	6023 3.700	8.200		10.0	89.0	47.0	40.0	6023 8.200
3.800		6.0	66.0	24.0	36.0	6023 3.800	8.300		10.0	89.0	47.0	40.0	6023 8.300
3.900		6.0	66.0	24.0	36.0	6023 3.900	8.330	21/64	10.0	89.0	47.0	40.0	6023 8.330
3.970	5/32	6.0	66.0	24.0	36.0	6023 3.970	8.400		10.0	89.0	47.0	40.0	6023 8.400
4.000		6.0	66.0	24.0	36.0	6023 4.000	8.500		10.0	89.0	47.0	40.0	6023 8.500
4.040		6.0	66.0	24.0	36.0	6023 4.040	8.550		10.0	89.0	47.0	40.0	6023 8.550
4.100		6.0	66.0	24.0	36.0	6023 4.100	8.600		10.0	89.0	47.0	40.0	6023 8.600
4.200		6.0	66.0	24.0	36.0	6023 4.200	8.700		10.0	89.0	47.0	40.0	6023 8.700
4.300		6.0	66.0	24.0	36.0	6023 4.300	8.730	11/32	10.0	89.0	47.0	40.0	6023 8.730
4.370	11/64	6.0	66.0	24.0	36.0	6023 4.370	8.800		10.0	89.0	47.0	40.0	6023 8.800
4.400		6.0	66.0	24.0	36.0	6023 4.400	8.900		10.0	89.0	47.0	40.0	6023 8.900
4.500		6.0	66.0	24.0	36.0	6023 4.500	9.000		10.0	89.0	47.0	40.0	6023 9.000
4.600		6.0	66.0	24.0	36.0	6023 4.600	9.100		10.0	89.0	47.0	40.0	6023 9.100
4.650		6.0	66.0	24.0	36.0	6023 4.650	9.130	23/64	10.0	89.0	47.0	40.0	6023 9.130
4.700		6.0	66.0	24.0	36.0	6023 4.700	9.200		10.0	89.0	47.0	40.0	6023 9.200
4.760	3/16	6.0	66.0	28.0	36.0	6023 4.760	9.250		10.0	89.0	47.0	40.0	6023 9.250
4.800		6.0	66.0	28.0	36.0	6023 4.800	9.300		10.0	89.0	47.0	40.0	6023 9.300
4.900		6.0	66.0	28.0	36.0	6023 4.900	9.340		10.0	89.0	47.0	40.0	6023 9.340
5.000		6.0	66.0	28.0	36.0	6023 5.000	9.400		10.0	89.0	47.0	40.0	6023 9.400
5.100		6.0	66.0	28.0	36.0	6023 5.100	9.500		10.0	89.0	47.0	40.0	6023 9.500
5.110		6.0	66.0	28.0	36.0	6023 5.110	9.520	3/8	10.0	89.0	47.0	40.0	6023 9.520
5.160	13/64	6.0	66.0	28.0	36.0	6023 5.160	9.600		10.0	89.0	47.0	40.0	6023 9.600
5.200		6.0	66.0	28.0	36.0	6023 5.200	9.700		10.0	89.0	47.0	40.0	6023 9.700
5.250		6.0	66.0	28.0	36.0	6023 5.250	9.800		10.0	89.0	47.0	40.0	6023 9.800
5.300		6.0	66.0	28.0	36.0	6023 5.300	9.900		10.0	89.0	47.0	40.0	6023 9.900
5.400		6.0	66.0	28.0	36.0	6023 5.400	9.920	25/64	10.0	89.0	47.0	40.0	6023 9.920
5.410		6.0	66.0	28.0	36.0	6023 5.410	10.000		10.0	89.0	47.0	40.0	6023 10.000
5.500		6.0	66.0	28.0	36.0	6023 5.500	10.100		12.0	102.0	55.0	45.0	6023 10.100
5.550		6.0	66.0	28.0	36.0	6023 5.550	10.200		12.0	102.0	55.0	45.0	6023 10.200
5.560	7/32	6.0	66.0	28.0	36.0	6023 5.560	10.300		12.0	102.0	55.0	45.0	6023 10.300
5.600		6.0	66.0	28.0	36.0	6023 5.600	10.320	13/32	12.0	102.0	55.0	45.0	6023 10.320
5.650		6.0	66.0	28.0	36.0	6023 5.650	10.400		12.0	102.0	55.0	45.0	6023 10.400
5.700		6.0	66.0	28.0	36.0	6023 5.700	10.500		12.0	102.0	55.0	45.0	6023 10.500
5.750		6.0	66.0	28.0	36.0	6023 5.750	10.600		12.0	102.0	55.0	45.0	6023 10.600
5.800		6.0	66.0	28.0	36.0	6023 5.800	10.700		12.0	102.0	55.0	45.0	6023 10.700
5.900		6.0	66.0	28.0	36.0	6023 5.900	10.720	27/64	12.0	102.0	55.0	45.0	6023 10.720
5.950	15/64	6.0	66.0	28.0	36.0	6023 5.950	10.800		12.0	102.0	55.0	45.0	6023 10.800
6.000		6.0	66.0	28.0	36.0	6023 6.000	10.900		12.0	102.0	55.0	45.0	6023 10.900
6.100		8.0	79.0	34.0	36.0	6023 6.100	11.000		12.0	102.0	55.0	45.0	6023 11.000
6.200		8.0	79.0	34.0	36.0	6023 6.200	11.100		12.0	102.0	55.0	45.0	6023 11.100
6.300		8.0	79.0	34.0	36.0	6023 6.300	11.110	7/16	12.0	102.0	55.0	45.0	6023 11.110
6.350	1/4	8.0	79.0	34.0	36.0	6023 6.350	11.200		12.0	102.0	55.0	45.0	6023 11.200
6.400		8.0	79.0	34.0	36.0	6023 6.400	11.300		12.0	102.0	55.0	45.0	6023 11.300
6.500		8.0	79.0	34.0	36.0	6023 6.500	11.400		12.0	102.0	55.0	45.0	6023 11.400
6.530		8.0	79.0	34.0	36.0	6023 6.530	11.500		12.0	102.0	55.0	45.0	6023 11.500
6.600		8.0	79.0	34.0	36.0	6023 6.600	11.510	29/64	12.0	102.0	55.0	45.0	6023 11.510
6.700		8.0	79.0	34.0	36.0	6023 6.700	11.600		12.0	102.0	55.0	45.0	6023 11.600
6.750	17/64	8.0	79.0	34.0	36.0	6023 6.750	11.700		12.0	102.0	55.0	45.0	6023 11.700
6.800		8.0	79.0	34.0	36.0	6023 6.800	11.800		12.0	102.0	55.0	45.0	6023 11.800
6.900		8.0	79.0	34.0	36.0	6023 6.900	11.900		12.0	102.0	55.0	45.0	6023 11.900
7.000		8.0	79.0	34.0	36.0	6023 7.000	11.910	15/32	12.0	102.0	55.0	45.0	6023 11.910
7.100		8.0	79.0	41.0	36.0	6023 7.100	12.000		12.0	102.0	55.0	45.0	6023 12.000
7.140	9/32	8.0	79.0	41.0	36.0	6023 7.140	12.100		14.0	107.0	60.0	45.0	6023 12.100
7.200		8.0	79.0	41.0	36.0	6023 7.200	12.200		14.0	107.0	60.0	45.0	6023 12.200
7.300		8.0	79.0	41.0	36.0	6023 7.300	12.300	31/64	14.0	107.0	60.0	45.0	6023 12.300
7.400		8.0	79.0	41.0	36.0	6023 7.400	12.400		14.0	107.0	60.0	45.0	6023 12.400



Solid carbide drills

Article no.						6023	Article no.						6023
d1 mm	inch	d2 h6 mm	l1 mm	l2 mm	l3 mm	Order no.	d1 mm	inch	d2 h6 mm	l1 mm	l2 mm	l3 mm	Order no.
12.500		14.0	107.0	60.0	45.0	6023 12.500	16.000		16.0	115.0	65.0	48.0	6023 16.000
12.600		14.0	107.0	60.0	45.0	6023 12.600	16.100		18.0	123.0	73.0	48.0	6023 16.100
12.700	1/2	14.0	107.0	60.0	45.0	6023 12.700	16.200		18.0	123.0	73.0	48.0	6023 16.200
12.800		14.0	107.0	60.0	45.0	6023 12.800	16.270	41/64	18.0	123.0	73.0	48.0	6023 16.270
12.900		14.0	107.0	60.0	45.0	6023 12.900	16.500		18.0	123.0	73.0	48.0	6023 16.500
13.000		14.0	107.0	60.0	45.0	6023 13.000	16.670	21/32	18.0	123.0	73.0	48.0	6023 16.670
13.100	33/64	14.0	107.0	60.0	45.0	6023 13.100	16.900		18.0	123.0	73.0	48.0	6023 16.900
13.200		14.0	107.0	60.0	45.0	6023 13.200	17.000		18.0	123.0	73.0	48.0	6023 17.000
13.300		14.0	107.0	60.0	45.0	6023 13.300	17.070	43/64	18.0	123.0	73.0	48.0	6023 17.070
13.400		14.0	107.0	60.0	45.0	6023 13.400	17.200		18.0	123.0	73.0	48.0	6023 17.200
13.490	17/32	14.0	107.0	60.0	45.0	6023 13.490	17.300		18.0	123.0	73.0	48.0	6023 17.300
13.500		14.0	107.0	60.0	45.0	6023 13.500	17.400		18.0	123.0	73.0	48.0	6023 17.400
13.600		14.0	107.0	60.0	45.0	6023 13.600	17.460	11/16	18.0	123.0	73.0	48.0	6023 17.460
13.700		14.0	107.0	60.0	45.0	6023 13.700	17.500		18.0	123.0	73.0	48.0	6023 17.500
13.800		14.0	107.0	60.0	45.0	6023 13.800	17.600		18.0	123.0	73.0	48.0	6023 17.600
13.890	35/64	14.0	107.0	60.0	45.0	6023 13.890	17.700		18.0	123.0	73.0	48.0	6023 17.700
13.900		14.0	107.0	60.0	45.0	6023 13.900	17.860	45/64	18.0	123.0	73.0	48.0	6023 17.860
14.000		14.0	107.0	60.0	45.0	6023 14.000	17.900		18.0	123.0	73.0	48.0	6023 17.900
14.100		16.0	115.0	65.0	48.0	6023 14.100	18.000		18.0	123.0	73.0	48.0	6023 18.000
14.200		16.0	115.0	65.0	48.0	6023 14.200	18.260	23/32	20.0	131.0	79.0	50.0	6023 18.260
14.290	9/16	16.0	115.0	65.0	48.0	6023 14.290	18.300		20.0	131.0	79.0	50.0	6023 18.300
14.300		16.0	115.0	65.0	48.0	6023 14.300	18.500		20.0	131.0	79.0	50.0	6023 18.500
14.400		16.0	115.0	65.0	48.0	6023 14.400	18.900		20.0	131.0	79.0	50.0	6023 18.900
14.500		16.0	115.0	65.0	48.0	6023 14.500	19.000		20.0	131.0	79.0	50.0	6023 19.000
14.600		16.0	115.0	65.0	48.0	6023 14.600	19.050	3/4	20.0	131.0	79.0	50.0	6023 19.050
14.680	37/64	16.0	115.0	65.0	48.0	6023 14.680	19.250		20.0	131.0	79.0	50.0	6023 19.250
14.700		16.0	115.0	65.0	48.0	6023 14.700	19.300		20.0	131.0	79.0	50.0	6023 19.300
14.800		16.0	115.0	65.0	48.0	6023 14.800	19.446		20.0	131.0	79.0	50.0	6023 19.446
14.900		16.0	115.0	65.0	48.0	6023 14.900	19.500		20.0	131.0	79.0	50.0	6023 19.500
15.000		16.0	115.0	65.0	48.0	6023 15.000	19.840	25/32	20.0	131.0	79.0	50.0	6023 19.840
15.080	19/32	16.0	115.0	65.0	48.0	6023 15.080	19.900		20.0	131.0	79.0	50.0	6023 19.900
15.100		16.0	115.0	65.0	48.0	6023 15.100	20.000		20.0	131.0	79.0	50.0	6023 20.000
15.200		16.0	115.0	65.0	48.0	6023 15.200							
15.300		16.0	115.0	65.0	48.0	6023 15.300							
15.400		16.0	115.0	65.0	48.0	6023 15.400							
15.480	39/64	16.0	115.0	65.0	48.0	6023 15.480							
15.500		16.0	115.0	65.0	48.0	6023 15.500							
15.600		16.0	115.0	65.0	48.0	6023 15.600							
15.700		16.0	115.0	65.0	48.0	6023 15.700							
15.800		16.0	115.0	65.0	48.0	6023 15.800							
15.870	5/8	16.0	115.0	65.0	48.0	6023 15.870							
15.900		16.0	115.0	65.0	48.0	6023 15.900							



Ratio drills with coolant ducts

Article no. 8520



Cutting data page 404

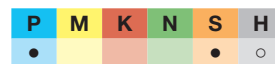
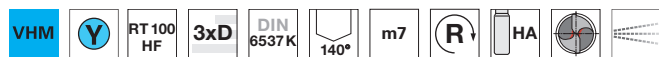

Web thinning $\geq \varnothing$ 3.000 • relieved cone • main cutting edge is slightly concave • optimised cutting edge geometry • double margin

Ratio drills with coolant ducts

Article no. 8620



Cutting data page 404

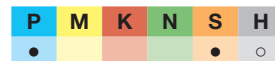
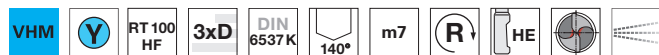

Web thinning $\geq \varnothing$ 3.000 • relieved cone • main cutting edge is slightly concave • optimised cutting edge geometry • double margin

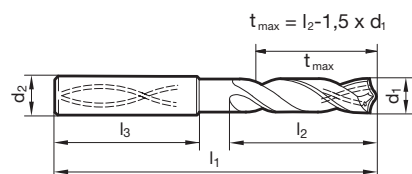

Article no.

8520 8620

Article no.

8520 8620

d1 mm	inch	d2 h6 mm	l1 mm	l2 mm	l3 mm	Order no.		d1 mm	inch	d2 h6 mm	l1 mm	l2 mm	l3 mm	Order no.	
3.000		6.0	62.0	20.0	36.0	8520 3.000	8620 3.000	7.100		8.0	79.0	41.0	36.0	8520 7.100	8620 7.100
3.100		6.0	62.0	20.0	36.0	8520 3.100	8620 3.100	7.140	9/32	8.0	79.0	41.0	36.0	8520 7.140	8620 7.140
3.170	1/8	6.0	62.0	20.0	36.0	8520 3.170	8620 3.170	7.200		8.0	79.0	41.0	36.0	8520 7.200	8620 7.200
3.200		6.0	62.0	20.0	36.0	8520 3.200	8620 3.200	7.300		8.0	79.0	41.0	36.0	8520 7.300	8620 7.300
3.250		6.0	62.0	20.0	36.0	8520 3.250	8620 3.250	7.400		8.0	79.0	41.0	36.0	8520 7.400	8620 7.400
3.300		6.0	62.0	20.0	36.0	8520 3.300	8620 3.300	7.500		8.0	79.0	41.0	36.0	8520 7.500	8620 7.500
3.400		6.0	62.0	20.0	36.0	8520 3.400	8620 3.400	7.540	19/64	8.0	79.0	41.0	36.0	8520 7.540	8620 7.540
3.500		6.0	62.0	20.0	36.0	8520 3.500	8620 3.500	7.600		8.0	79.0	41.0	36.0	8520 7.600	8620 7.600
3.570	9/64	6.0	62.0	20.0	36.0	8520 3.570	8620 3.570	7.700		8.0	79.0	41.0	36.0	8520 7.700	8620 7.700
3.600		6.0	62.0	20.0	36.0	8520 3.600	8620 3.600	7.800		8.0	79.0	41.0	36.0	8520 7.800	8620 7.800
3.700		6.0	62.0	20.0	36.0	8520 3.700	8620 3.700	7.900		8.0	79.0	41.0	36.0	8520 7.900	8620 7.900
3.800		6.0	66.0	24.0	36.0	8520 3.800	8620 3.800	7.940	5/16	8.0	79.0	41.0	36.0	8520 7.940	8620 7.940
3.900		6.0	66.0	24.0	36.0	8520 3.900	8620 3.900	8.000		8.0	79.0	41.0	36.0	8520 8.000	8620 8.000
3.970	5/32	6.0	66.0	24.0	36.0	8520 3.970	8620 3.970	8.100		10.0	89.0	47.0	40.0	8520 8.100	8620 8.100
4.000		6.0	66.0	24.0	36.0	8520 4.000	8620 4.000	8.200		10.0	89.0	47.0	40.0	8520 8.200	8620 8.200
4.100		6.0	66.0	24.0	36.0	8520 4.100	8620 4.100	8.300		10.0	89.0	47.0	40.0	8520 8.300	8620 8.300
4.200		6.0	66.0	24.0	36.0	8520 4.200	8620 4.200	8.330	21/64	10.0	89.0	47.0	40.0	8520 8.330	8620 8.330
4.300		6.0	66.0	24.0	36.0	8520 4.300	8620 4.300	8.400		10.0	89.0	47.0	40.0	8520 8.400	8620 8.400
4.370	11/64	6.0	66.0	24.0	36.0	8520 4.370	8620 4.370	8.500		10.0	89.0	47.0	40.0	8520 8.500	8620 8.500
4.400		6.0	66.0	24.0	36.0	8520 4.400	8620 4.400	8.600		10.0	89.0	47.0	40.0	8520 8.600	8620 8.600
4.500		6.0	66.0	24.0	36.0	8520 4.500	8620 4.500	8.700		10.0	89.0	47.0	40.0	8520 8.700	8620 8.700
4.600		6.0	66.0	24.0	36.0	8520 4.600	8620 4.600	8.730	11/32	10.0	89.0	47.0	40.0	8520 8.730	8620 8.730
4.650		6.0	66.0	24.0	36.0	8520 4.650	8620 4.650	8.800		10.0	89.0	47.0	40.0	8520 8.800	8620 8.800
4.700		6.0	66.0	24.0	36.0	8520 4.700	8620 4.700	8.900		10.0	89.0	47.0	40.0	8520 8.900	8620 8.900
4.760	3/16	6.0	66.0	28.0	36.0	8520 4.760	8620 4.760	9.000		10.0	89.0	47.0	40.0	8520 9.000	8620 9.000
4.800		6.0	66.0	28.0	36.0	8520 4.800	8620 4.800	9.100		10.0	89.0	47.0	40.0	8520 9.100	8620 9.100
4.900		6.0	66.0	28.0	36.0	8520 4.900	8620 4.900	9.130	23/64	10.0	89.0	47.0	40.0	8520 9.130	8620 9.130
5.000		6.0	66.0	28.0	36.0	8520 5.000	8620 5.000	9.200		10.0	89.0	47.0	40.0	8520 9.200	8620 9.200
5.100		6.0	66.0	28.0	36.0	8520 5.100	8620 5.100	9.250		10.0	89.0	47.0	40.0	8520 9.250	8620 9.250
5.160	13/64	6.0	66.0	28.0	36.0	8520 5.160	8620 5.160	9.300		10.0	89.0	47.0	40.0	8520 9.300	8620 9.300
5.200		6.0	66.0	28.0	36.0	8520 5.200	8620 5.200	9.400		10.0	89.0	47.0	40.0	8520 9.400	8620 9.400
5.300		6.0	66.0	28.0	36.0	8520 5.300	8620 5.300	9.500		10.0	89.0	47.0	40.0	8520 9.500	8620 9.500
5.400		6.0	66.0	28.0	36.0	8520 5.400	8620 5.400	9.520	3/8	10.0	89.0	47.0	40.0	8520 9.520	8620 9.520
5.500		6.0	66.0	28.0	36.0	8520 5.500	8620 5.500	9.600		10.0	89.0	47.0	40.0	8520 9.600	8620 9.600
5.550		6.0	66.0	28.0	36.0	8520 5.550	8620 5.550	9.700		10.0	89.0	47.0	40.0	8520 9.700	8620 9.700
5.560	7/32	6.0	66.0	28.0	36.0	8520 5.560	8620 5.560	9.800		10.0	89.0	47.0	40.0	8520 9.800	8620 9.800
5.600		6.0	66.0	28.0	36.0	8520 5.600	8620 5.600	9.900		10.0	89.0	47.0	40.0	8520 9.900	8620 9.900
5.700		6.0	66.0	28.0	36.0	8520 5.700	8620 5.700	9.920	25/64	10.0	89.0	47.0	40.0	8520 9.920	8620 9.920
5.800		6.0	66.0	28.0	36.0	8520 5.800	8620 5.800	10.000		10.0	89.0	47.0	40.0	8520 10.000	8620 10.000
5.900		6.0	66.0	28.0	36.0	8520 5.900	8620 5.900	10.100		12.0	102.0	55.0	45.0	8520 10.100	8620 10.100
5.950	15/64	6.0	66.0	28.0	36.0	8520 5.950	8620 5.950	10.200		12.0	102.0	55.0	45.0	8520 10.200	8620 10.200
6.000		6.0	66.0	28.0	36.0	8520 6.000	8620 6.000	10.300		12.0	102.0	55.0	45.0	8520 10.300	8620 10.300
6.100		8.0	79.0	34.0	36.0	8520 6.100	8620 6.100	10.320	13/32	12.0	102.0	55.0	45.0	8520 10.320	8620 10.320
6.200		8.0	79.0	34.0	36.0	8520 6.200	8620 6.200	10.400		12.0	102.0	55.0	45.0	8520 10.400	8620 10.400
6.300		8.0	79.0	34.0	36.0	8520 6.300	8620 6.300	10.500		12.0	102.0	55.0	45.0	8520 10.500	8620 10.500
6.350	1/4	8.0	79.0	34.0	36.0	8520 6.350	8620 6.350	10.600		12.0	102.0	55.0	45.0	8520 10.600	8620 10.600
6.400		8.0	79.0	34.0	36.0	8520 6.400	8620 6.400	10.700		12.0	102.0	55.0	45.0	8520 10.700	8620 10.700
6.500		8.0	79.0	34.0	36.0	8520 6.500	8620 6.500	10.720	27/64	12.0	102.0	55.0	45.0	8520 10.720	8620 10.720
6.600		8.0	79.0	34.0	36.0	8520 6.600	8620 6.600	10.800		12.0	102.0	55.0	45.0	8520 10.800	8620 10.800
6.700		8.0	79.0	34.0	36.0	8520 6.700	8620 6.700	10.900		12.0	102.0	55.0	45.0	8520 10.900	8620 10.900
6.750	17/64	8.0	79.0	34.0	36.0	8520 6.750	8620 6.750	11.000		12.0	102.0	55.0	45.0	8520 11.000	8620 11.000
6.800		8.0	79.0	34.0	36.0	8520 6.800	8620 6.800	11.100		12.0	102.0	55.0	45.0	8520 11.100	8620 11.100
6.900		8.0	79.0	34.0	36.0	8520 6.900	8620 6.900	11.110	7/16	12.0	102.0	55.0	45.0	8520 11.110	8620 11.110
7.000		8.0	79.0	34.0	36.0	8520 7.000	8620 7.000	11.200		12.0	102.0	55.0	45.0	8520 11.200	8620 11.200



Solid carbide drills

Article no.						8520	8620	Article no.						8520	8620
d1 mm	inch	d2 h6 mm	l1 mm	l2 mm	l3 mm	Order no.		d1 mm	inch	d2 h6 mm	l1 mm	l2 mm	l3 mm	Order no.	
11.300		12.0	102.0	55.0	45.0	8520 11.300	8620 11.300	14.500		16.0	115.0	65.0	48.0	8520 14.500	8620 14.500
11.400		12.0	102.0	55.0	45.0	8520 11.400	8620 11.400	14.700		16.0	115.0	65.0	48.0	8520 14.700	8620 14.700
11.500		12.0	102.0	55.0	45.0	8520 11.500	8620 11.500	15.000		16.0	115.0	65.0	48.0	8520 15.000	8620 15.000
11.510	29/64	12.0	102.0	55.0	45.0	8520 11.510		15.200		16.0	115.0	65.0	48.0	8520 15.200	8620 15.200
11.600		12.0	102.0	55.0	45.0	8520 11.600	8620 11.600	15.300		16.0	115.0	65.0	48.0	8520 15.300	8620 15.300
11.700		12.0	102.0	55.0	45.0	8520 11.700	8620 11.700	15.500		16.0	115.0	65.0	48.0	8520 15.500	8620 15.500
11.800		12.0	102.0	55.0	45.0	8520 11.800	8620 11.800	15.700		16.0	115.0	65.0	48.0	8520 15.700	8620 15.700
11.900		12.0	102.0	55.0	45.0	8520 11.900	8620 11.900	15.870	5/8	16.0	115.0	65.0	48.0	8520 15.870	
11.910	15/32	12.0	102.0	55.0	45.0	8520 11.910	8620 11.910	16.000		16.0	115.0	65.0	48.0	8520 16.000	8620 16.000
12.000		12.0	102.0	55.0	45.0	8520 12.000	8620 12.000	16.300		18.0	123.0	73.0	48.0	8520 16.300	8620 16.300
12.200		14.0	107.0	60.0	45.0	8520 12.200	8620 12.200	16.500		18.0	123.0	73.0	48.0	8520 16.500	8620 16.500
12.300	31/64	14.0	107.0	60.0	45.0	8520 12.300		16.900		18.0	123.0	73.0	48.0	8520 16.900	8620 16.900
12.500		14.0	107.0	60.0	45.0	8520 12.500	8620 12.500	17.000		18.0	123.0	73.0	48.0	8520 17.000	8620 17.000
12.700	1/2	14.0	107.0	60.0	45.0	8520 12.700	8620 12.700	17.300		18.0	123.0	73.0	48.0	8520 17.300	8620 17.300
12.800		14.0	107.0	60.0	45.0	8520 12.800	8620 12.800	17.500		18.0	123.0	73.0	48.0	8520 17.500	8620 17.500
13.000		14.0	107.0	60.0	45.0	8520 13.000	8620 13.000	18.000		18.0	123.0	73.0	48.0	8520 18.000	8620 18.000
13.300		14.0	107.0	60.0	45.0	8520 13.300	8620 13.300	18.500		20.0	131.0	79.0	50.0	8520 18.500	8620 18.500
13.490	17/32	14.0	107.0	60.0	45.0	8520 13.490		18.900		20.0	131.0	79.0	50.0	8520 18.900	8620 18.900
13.500		14.0	107.0	60.0	45.0	8520 13.500	8620 13.500	19.000		20.0	131.0	79.0	50.0	8520 19.000	8620 19.000
13.700		14.0	107.0	60.0	45.0	8520 13.700	8620 13.700	19.050	3/4	20.0	131.0	79.0	50.0	8520 19.050	8620 19.050
14.000		14.0	107.0	60.0	45.0	8520 14.000	8620 14.000	19.300		20.0	131.0	79.0	50.0	8520 19.300	8620 19.300
14.200		16.0	115.0	65.0	48.0	8520 14.200	8620 14.200	19.500		20.0	131.0	79.0	50.0	8520 19.500	8620 19.500
14.290	9/16	16.0	115.0	65.0	48.0	8520 14.290	8620 14.290	20.000		20.0	131.0	79.0	50.0	8520 20.000	8620 20.000
14.300		16.0	115.0	65.0	48.0	8520 14.300	8620 14.300								



Ratio drills with coolant ducts

Article no. 8510



Cutting data page 408

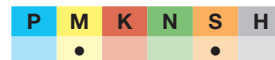

Web thinning $\geq \varnothing 3.000$ • facet point grind • main cutting edge form straight • optimised cutting edge geometry

Ratio drills with coolant ducts

Article no. 8610



Cutting data page 408

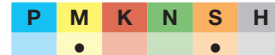
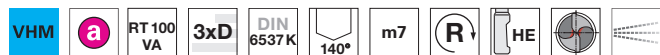

Web thinning $\geq \varnothing 3.000$ • facet point grind • main cutting edge form straight • optimised cutting edge geometry

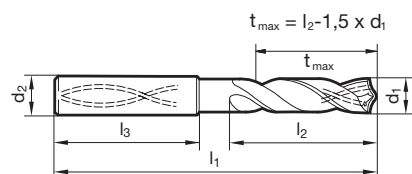

Article no.

8510 8610

Article no.

8510 8610

d1 mm	inch	d2 h6 mm	l1 mm	l2 mm	l3 mm	Order no.		d1 mm	inch	d2 h6 mm	l1 mm	l2 mm	l3 mm	Order no.	
3.000		6.0	62.0	20.0	36.0	8510 3.000	8610 3.000	7.100		8.0	79.0	41.0	36.0	8510 7.100	8610 7.100
3.100		6.0	62.0	20.0	36.0	8510 3.100	8610 3.100	7.140	9/32	8.0	79.0	41.0	36.0	8510 7.140	8610 7.140
3.170	1/8	6.0	62.0	20.0	36.0	8510 3.170	8610 3.170	7.200		8.0	79.0	41.0	36.0	8510 7.200	8610 7.200
3.200		6.0	62.0	20.0	36.0	8510 3.200	8610 3.200	7.300		8.0	79.0	41.0	36.0	8510 7.300	8610 7.300
3.250		6.0	62.0	20.0	36.0	8510 3.250	8610 3.250	7.400		8.0	79.0	41.0	36.0	8510 7.400	8610 7.400
3.300		6.0	62.0	20.0	36.0	8510 3.300	8610 3.300	7.500		8.0	79.0	41.0	36.0	8510 7.500	8610 7.500
3.400		6.0	62.0	20.0	36.0	8510 3.400	8610 3.400	7.540	19/64	8.0	79.0	41.0	36.0	8510 7.540	8610 7.540
3.500		6.0	62.0	20.0	36.0	8510 3.500	8610 3.500	7.600		8.0	79.0	41.0	36.0	8510 7.600	8610 7.600
3.570	9/64	6.0	62.0	20.0	36.0	8510 3.570	8610 3.570	7.700		8.0	79.0	41.0	36.0	8510 7.700	8610 7.700
3.600		6.0	62.0	20.0	36.0	8510 3.600	8610 3.600	7.800		8.0	79.0	41.0	36.0	8510 7.800	8610 7.800
3.700		6.0	62.0	20.0	36.0	8510 3.700	8610 3.700	7.900		8.0	79.0	41.0	36.0	8510 7.900	8610 7.900
3.800		6.0	66.0	24.0	36.0	8510 3.800	8610 3.800	7.940	5/16	8.0	79.0	41.0	36.0	8510 7.940	8610 7.940
3.900		6.0	66.0	24.0	36.0	8510 3.900	8610 3.900	8.000		8.0	79.0	41.0	36.0	8510 8.000	8610 8.000
3.970	5/32	6.0	66.0	24.0	36.0	8510 3.970	8610 3.970	8.100		10.0	89.0	47.0	40.0	8510 8.100	8610 8.100
4.000		6.0	66.0	24.0	36.0	8510 4.000	8610 4.000	8.200		10.0	89.0	47.0	40.0	8510 8.200	8610 8.200
4.100		6.0	66.0	24.0	36.0	8510 4.100	8610 4.100	8.300		10.0	89.0	47.0	40.0	8510 8.300	8610 8.300
4.200		6.0	66.0	24.0	36.0	8510 4.200	8610 4.200	8.330	21/64	10.0	89.0	47.0	40.0	8510 8.330	8610 8.330
4.300		6.0	66.0	24.0	36.0	8510 4.300	8610 4.300	8.400		10.0	89.0	47.0	40.0	8510 8.400	8610 8.400
4.370	11/64	6.0	66.0	24.0	36.0	8510 4.370	8610 4.370	8.500		10.0	89.0	47.0	40.0	8510 8.500	8610 8.500
4.400		6.0	66.0	24.0	36.0	8510 4.400	8610 4.400	8.600		10.0	89.0	47.0	40.0	8510 8.600	8610 8.600
4.500		6.0	66.0	24.0	36.0	8510 4.500	8610 4.500	8.700		10.0	89.0	47.0	40.0	8510 8.700	8610 8.700
4.600		6.0	66.0	24.0	36.0	8510 4.600	8610 4.600	8.730	11/32	10.0	89.0	47.0	40.0	8510 8.730	8610 8.730
4.650		6.0	66.0	24.0	36.0	8510 4.650	8610 4.650	8.800		10.0	89.0	47.0	40.0	8510 8.800	8610 8.800
4.700		6.0	66.0	24.0	36.0	8510 4.700	8610 4.700	8.900		10.0	89.0	47.0	40.0	8510 8.900	8610 8.900
4.760	3/16	6.0	66.0	28.0	36.0	8510 4.760	8610 4.760	9.000		10.0	89.0	47.0	40.0	8510 9.000	8610 9.000
4.800		6.0	66.0	28.0	36.0	8510 4.800	8610 4.800	9.100		10.0	89.0	47.0	40.0	8510 9.100	8610 9.100
4.900		6.0	66.0	28.0	36.0	8510 4.900	8610 4.900	9.130	23/64	10.0	89.0	47.0	40.0	8510 9.130	8610 9.130
5.000		6.0	66.0	28.0	36.0	8510 5.000	8610 5.000	9.200		10.0	89.0	47.0	40.0	8510 9.200	8610 9.200
5.100		6.0	66.0	28.0	36.0	8510 5.100	8610 5.100	9.250		10.0	89.0	47.0	40.0	8510 9.250	8610 9.250
5.160	13/64	6.0	66.0	28.0	36.0	8510 5.160	8610 5.160	9.300		10.0	89.0	47.0	40.0	8510 9.300	8610 9.300
5.200		6.0	66.0	28.0	36.0	8510 5.200	8610 5.200	9.400		10.0	89.0	47.0	40.0	8510 9.400	8610 9.400
5.300		6.0	66.0	28.0	36.0	8510 5.300	8610 5.300	9.500		10.0	89.0	47.0	40.0	8510 9.500	8610 9.500
5.400		6.0	66.0	28.0	36.0	8510 5.400	8610 5.400	9.520	3/8	10.0	89.0	47.0	40.0	8510 9.520	8610 9.520
5.500		6.0	66.0	28.0	36.0	8510 5.500	8610 5.500	9.600		10.0	89.0	47.0	40.0	8510 9.600	8610 9.600
5.550		6.0	66.0	28.0	36.0	8510 5.550	8610 5.550	9.700		10.0	89.0	47.0	40.0	8510 9.700	8610 9.700
5.560	7/32	6.0	66.0	28.0	36.0	8510 5.560	8610 5.560	9.800		10.0	89.0	47.0	40.0	8510 9.800	8610 9.800
5.600		6.0	66.0	28.0	36.0	8510 5.600	8610 5.600	9.900		10.0	89.0	47.0	40.0	8510 9.900	8610 9.900
5.700		6.0	66.0	28.0	36.0	8510 5.700	8610 5.700	9.920	25/64	10.0	89.0	47.0	40.0	8510 9.920	8610 9.920
5.800		6.0	66.0	28.0	36.0	8510 5.800	8610 5.800	10.000		10.0	89.0	47.0	40.0	8510 10.000	8610 10.000
5.900		6.0	66.0	28.0	36.0	8510 5.900	8610 5.900	10.100		12.0	102.0	55.0	45.0	8510 10.100	8610 10.100
5.950	15/64	6.0	66.0	28.0	36.0	8510 5.950	8610 5.950	10.200		12.0	102.0	55.0	45.0	8510 10.200	8610 10.200
6.000		6.0	66.0	28.0	36.0	8510 6.000	8610 6.000	10.300		12.0	102.0	55.0	45.0	8510 10.300	8610 10.300
6.100		8.0	79.0	34.0	36.0	8510 6.100	8610 6.100	10.320	13/32	12.0	102.0	55.0	45.0	8510 10.320	8610 10.320
6.200		8.0	79.0	34.0	36.0	8510 6.200	8610 6.200	10.400		12.0	102.0	55.0	45.0	8510 10.400	8610 10.400
6.300		8.0	79.0	34.0	36.0	8510 6.300	8610 6.300	10.500		12.0	102.0	55.0	45.0	8510 10.500	8610 10.500
6.350	1/4	8.0	79.0	34.0	36.0	8510 6.350	8610 6.350	10.600		12.0	102.0	55.0	45.0	8510 10.600	8610 10.600
6.400		8.0	79.0	34.0	36.0	8510 6.400	8610 6.400	10.700		12.0	102.0	55.0	45.0	8510 10.700	8610 10.700
6.500		8.0	79.0	34.0	36.0	8510 6.500	8610 6.500	10.800		12.0	102.0	55.0	45.0	8510 10.800	8610 10.800
6.600		8.0	79.0	34.0	36.0	8510 6.600	8610 6.600	10.900		12.0	102.0	55.0	45.0	8510 10.900	8610 10.900
6.700		8.0	79.0	34.0	36.0	8510 6.700	8610 6.700	11.000		12.0	102.0	55.0	45.0	8510 11.000	8610 11.000
6.750	17/64	8.0	79.0	34.0	36.0	8510 6.750	8610 6.750	11.100		12.0	102.0	55.0	45.0	8510 11.100	8610 11.100
6.800		8.0	79.0	34.0	36.0	8510 6.800	8610 6.800	11.110	7/16	12.0	102.0	55.0	45.0	8510 11.110	8610 11.110
6.900		8.0	79.0	34.0	36.0	8510 6.900	8610 6.900	11.200		12.0	102.0	55.0	45.0	8510 11.200	8610 11.200
7.000		8.0	79.0	34.0	36.0	8510 7.000	8610 7.000	11.300		12.0	102.0	55.0	45.0	8510 11.300	8610 11.300



Solid carbide drills

Article no.						8510	8610	Article no.						8510	8610
d1 mm	inch	d2 h6 mm	l1 mm	l2 mm	l3 mm	Order no.		d1 mm	inch	d2 h6 mm	l1 mm	l2 mm	l3 mm	Order no.	
11.400		12.0	102.0	55.0	45.0	8510 11.400	8610 11.400	15.300		16.0	115.0	65.0	48.0	8510 15.300	8610 15.300
11.500		12.0	102.0	55.0	45.0	8510 11.500	8610 11.500	15.500		16.0	115.0	65.0	48.0	8510 15.500	8610 15.500
11.600		12.0	102.0	55.0	45.0	8510 11.600	8610 11.600	15.700		16.0	115.0	65.0	48.0	8510 15.700	8610 15.700
11.700		12.0	102.0	55.0	45.0	8510 11.700	8610 11.700	16.000		16.0	115.0	65.0	48.0	8510 16.000	8610 16.000
11.800		12.0	102.0	55.0	45.0	8510 11.800	8610 11.800	16.300		18.0	123.0	73.0	48.0	8510 16.300	8610 16.300
11.900		12.0	102.0	55.0	45.0	8510 11.900	8610 11.900	16.500		18.0	123.0	73.0	48.0	8510 16.500	8610 16.500
11.910	15/32	12.0	102.0	55.0	45.0	8510 11.910	8610 11.910	16.900		18.0	123.0	73.0	48.0	8510 16.900	8610 16.900
12.000		12.0	102.0	55.0	45.0	8510 12.000	8610 12.000	17.000		18.0	123.0	73.0	48.0	8510 17.000	8610 17.000
12.200		14.0	107.0	60.0	45.0	8510 12.200	8610 12.200	17.300		18.0	123.0	73.0	48.0	8510 17.300	8610 17.300
12.500		14.0	107.0	60.0	45.0	8510 12.500	8610 12.500	17.500		18.0	123.0	73.0	48.0	8510 17.500	8610 17.500
12.700	1/2	14.0	107.0	60.0	45.0	8510 12.700	8610 12.700	18.000		18.0	123.0	73.0	48.0	8510 18.000	8610 18.000
12.800		14.0	107.0	60.0	45.0	8510 12.800	8610 12.800	18.500		20.0	131.0	79.0	50.0	8510 18.500	8610 18.500
13.000		14.0	107.0	60.0	45.0	8510 13.000	8610 13.000	18.900		20.0	131.0	79.0	50.0	8510 18.900	8610 18.900
13.300		14.0	107.0	60.0	45.0	8510 13.300	8610 13.300	19.000		20.0	131.0	79.0	50.0	8510 19.000	8610 19.000
13.500		14.0	107.0	60.0	45.0	8510 13.500	8610 13.500	19.050	3/4	20.0	131.0	79.0	50.0	8510 19.050	8610 19.050
13.700		14.0	107.0	60.0	45.0	8510 13.700	8610 13.700	19.300		20.0	131.0	79.0	50.0	8510 19.300	8610 19.300
14.000		14.0	107.0	60.0	45.0	8510 14.000	8610 14.000	19.500		20.0	131.0	79.0	50.0	8510 19.500	8610 19.500
14.200		16.0	115.0	65.0	48.0	8510 14.200	8610 14.200	20.000		20.0	131.0	79.0	50.0	8510 20.000	8610 20.000
14.290	9/16	16.0	115.0	65.0	48.0	8510 14.290	8610 14.290								
14.300		16.0	115.0	65.0	48.0	8510 14.300	8610 14.300								
14.500		16.0	115.0	65.0	48.0	8510 14.500	8610 14.500								
14.700		16.0	115.0	65.0	48.0	8510 14.700	8610 14.700								
15.000		16.0	115.0	65.0	48.0	8510 15.000	8610 15.000								
15.200		16.0	115.0	65.0	48.0	8510 15.200	8610 15.200								



Ratio drills with coolant ducts

Article no. 6024



Cutting data page 408

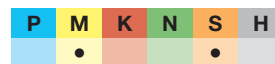
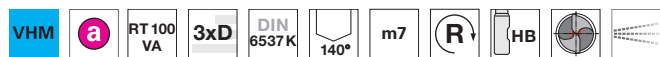

Web thinning ≥ Ø 3.000 • facet point grind • main cutting edge form straight • optimised cutting edge geometry

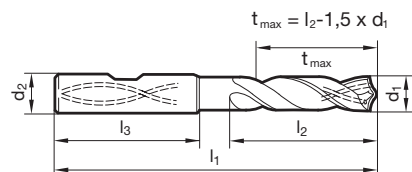

Article no. 6024						Article no. 6024							
d1 mm	inch	d2 h6 mm	l1 mm	l2 mm	l3 mm	Order no.	d1 mm	inch	d2 h6 mm	l1 mm	l2 mm	l3 mm	Order no.
3.000		6.0	62.0	20.0	36.0	6024 3.000	8.000		8.0	79.0	41.0	36.0	6024 8.000
3.100		6.0	62.0	20.0	36.0	6024 3.100	8.100		10.0	89.0	47.0	40.0	6024 8.100
3.170	1/8	6.0	62.0	20.0	36.0	6024 3.170	8.200		10.0	89.0	47.0	40.0	6024 8.200
3.200		6.0	62.0	20.0	36.0	6024 3.200	8.300		10.0	89.0	47.0	40.0	6024 8.300
3.250		6.0	62.0	20.0	36.0	6024 3.250	8.330	21/64	10.0	89.0	47.0	40.0	6024 8.330
3.300		6.0	62.0	20.0	36.0	6024 3.300	8.400		10.0	89.0	47.0	40.0	6024 8.400
3.400		6.0	62.0	20.0	36.0	6024 3.400	8.500		10.0	89.0	47.0	40.0	6024 8.500
3.500		6.0	62.0	20.0	36.0	6024 3.500	8.600		10.0	89.0	47.0	40.0	6024 8.600
3.570	9/64	6.0	62.0	20.0	36.0	6024 3.570	8.700		10.0	89.0	47.0	40.0	6024 8.700
3.600		6.0	62.0	20.0	36.0	6024 3.600	8.730	11/32	10.0	89.0	47.0	40.0	6024 8.730
3.700		6.0	62.0	20.0	36.0	6024 3.700	8.800		10.0	89.0	47.0	40.0	6024 8.800
3.800		6.0	66.0	24.0	36.0	6024 3.800	8.900		10.0	89.0	47.0	40.0	6024 8.900
3.900		6.0	66.0	24.0	36.0	6024 3.900	9.000		10.0	89.0	47.0	40.0	6024 9.000
3.970	5/32	6.0	66.0	24.0	36.0	6024 3.970	9.100		10.0	89.0	47.0	40.0	6024 9.100
4.000		6.0	66.0	24.0	36.0	6024 4.000	9.130	23/64	10.0	89.0	47.0	40.0	6024 9.130
4.100		6.0	66.0	24.0	36.0	6024 4.100	9.200		10.0	89.0	47.0	40.0	6024 9.200
4.200		6.0	66.0	24.0	36.0	6024 4.200	9.250		10.0	89.0	47.0	40.0	6024 9.250
4.300		6.0	66.0	24.0	36.0	6024 4.300	9.300		10.0	89.0	47.0	40.0	6024 9.300
4.370	11/64	6.0	66.0	24.0	36.0	6024 4.370	9.400		10.0	89.0	47.0	40.0	6024 9.400
4.400		6.0	66.0	24.0	36.0	6024 4.400	9.500		10.0	89.0	47.0	40.0	6024 9.500
4.500		6.0	66.0	24.0	36.0	6024 4.500	9.520	3/8	10.0	89.0	47.0	40.0	6024 9.520
4.600		6.0	66.0	24.0	36.0	6024 4.600	9.600		10.0	89.0	47.0	40.0	6024 9.600
4.650		6.0	66.0	24.0	36.0	6024 4.650	9.700		10.0	89.0	47.0	40.0	6024 9.700
4.700		6.0	66.0	24.0	36.0	6024 4.700	9.800		10.0	89.0	47.0	40.0	6024 9.800
4.760	3/16	6.0	66.0	28.0	36.0	6024 4.760	9.900		10.0	89.0	47.0	40.0	6024 9.900
4.800		6.0	66.0	28.0	36.0	6024 4.800	9.920	25/64	10.0	89.0	47.0	40.0	6024 9.920
4.900		6.0	66.0	28.0	36.0	6024 4.900	10.000		10.0	89.0	47.0	40.0	6024 10.000
5.000		6.0	66.0	28.0	36.0	6024 5.000	10.100		12.0	102.0	55.0	45.0	6024 10.100
5.100		6.0	66.0	28.0	36.0	6024 5.100	10.200		12.0	102.0	55.0	45.0	6024 10.200
5.160	13/64	6.0	66.0	28.0	36.0	6024 5.160	10.300		12.0	102.0	55.0	45.0	6024 10.300
5.200		6.0	66.0	28.0	36.0	6024 5.200	10.320	13/32	12.0	102.0	55.0	45.0	6024 10.320
5.300		6.0	66.0	28.0	36.0	6024 5.300	10.400		12.0	102.0	55.0	45.0	6024 10.400
5.400		6.0	66.0	28.0	36.0	6024 5.400	10.500		12.0	102.0	55.0	45.0	6024 10.500
5.500		6.0	66.0	28.0	36.0	6024 5.500	10.600		12.0	102.0	55.0	45.0	6024 10.600
5.550		6.0	66.0	28.0	36.0	6024 5.550	10.700		12.0	102.0	55.0	45.0	6024 10.700
5.560	7/32	6.0	66.0	28.0	36.0	6024 5.560	10.800		12.0	102.0	55.0	45.0	6024 10.800
5.600		6.0	66.0	28.0	36.0	6024 5.600	10.900		12.0	102.0	55.0	45.0	6024 10.900
5.700		6.0	66.0	28.0	36.0	6024 5.700	11.000		12.0	102.0	55.0	45.0	6024 11.000
5.800		6.0	66.0	28.0	36.0	6024 5.800	11.100		12.0	102.0	55.0	45.0	6024 11.100
5.900		6.0	66.0	28.0	36.0	6024 5.900	11.110	7/16	12.0	102.0	55.0	45.0	6024 11.110
5.950	15/64	6.0	66.0	28.0	36.0	6024 5.950	11.200		12.0	102.0	55.0	45.0	6024 11.200
6.000		6.0	66.0	28.0	36.0	6024 6.000	11.300		12.0	102.0	55.0	45.0	6024 11.300
6.100		8.0	79.0	34.0	36.0	6024 6.100	11.400		12.0	102.0	55.0	45.0	6024 11.400
6.200		8.0	79.0	34.0	36.0	6024 6.200	11.500		12.0	102.0	55.0	45.0	6024 11.500
6.300		8.0	79.0	34.0	36.0	6024 6.300	11.600		12.0	102.0	55.0	45.0	6024 11.600
6.350	1/4	8.0	79.0	34.0	36.0	6024 6.350	11.700		12.0	102.0	55.0	45.0	6024 11.700
6.400		8.0	79.0	34.0	36.0	6024 6.400	11.800		12.0	102.0	55.0	45.0	6024 11.800
6.500		8.0	79.0	34.0	36.0	6024 6.500	11.900		12.0	102.0	55.0	45.0	6024 11.900
6.600		8.0	79.0	34.0	36.0	6024 6.600	11.910	15/32	12.0	102.0	55.0	45.0	6024 11.910
6.700		8.0	79.0	34.0	36.0	6024 6.700	12.000		12.0	102.0	55.0	45.0	6024 12.000
6.750	17/64	8.0	79.0	34.0	36.0	6024 6.750	12.200		14.0	107.0	60.0	45.0	6024 12.200
6.800		8.0	79.0	34.0	36.0	6024 6.800	12.500		14.0	107.0	60.0	45.0	6024 12.500
6.900		8.0	79.0	34.0	36.0	6024 6.900	12.700	1/2	14.0	107.0	60.0	45.0	6024 12.700
7.000		8.0	79.0	34.0	36.0	6024 7.000	13.000		14.0	107.0	60.0	45.0	6024 13.000
7.100		8.0	79.0	41.0	36.0	6024 7.100	13.500		14.0	107.0	60.0	45.0	6024 13.500
7.140	9/32	8.0	79.0	41.0	36.0	6024 7.140	13.700		14.0	107.0	60.0	45.0	6024 13.700
7.200		8.0	79.0	41.0	36.0	6024 7.200	14.000		14.0	107.0	60.0	45.0	6024 14.000
7.300		8.0	79.0	41.0	36.0	6024 7.300	14.200		16.0	115.0	65.0	48.0	6024 14.200
7.400		8.0	79.0	41.0	36.0	6024 7.400	14.290	9/16	16.0	115.0	65.0	48.0	6024 14.290
7.500		8.0	79.0	41.0	36.0	6024 7.500	14.500		16.0	115.0	65.0	48.0	6024 14.500
7.540	19/64	8.0	79.0	41.0	36.0	6024 7.540	14.700		16.0	115.0	65.0	48.0	6024 14.700
7.600		8.0	79.0	41.0	36.0	6024 7.600	15.000		16.0	115.0	65.0	48.0	6024 15.000
7.700		8.0	79.0	41.0	36.0	6024 7.700	15.200		16.0	115.0	65.0	48.0	6024 15.200
7.800		8.0	79.0	41.0	36.0	6024 7.800	15.500		16.0	115.0	65.0	48.0	6024 15.500
7.900		8.0	79.0	41.0	36.0	6024 7.900	15.700		16.0	115.0	65.0	48.0	6024 15.700
7.940	5/16	8.0	79.0	41.0	36.0	6024 7.940	16.000		16.0	115.0	65.0	48.0	6024 16.000



Solid carbide drills

						Article no.	6024
d1 mm	inch	d2 h6 mm	l1 mm	l2 mm	l3 mm	Order no.	
16.500		18.0	123.0	73.0	48.0	6024	16.500
17.000		18.0	123.0	73.0	48.0	6024	17.000
17.500		18.0	123.0	73.0	48.0	6024	17.500
18.000		18.0	123.0	73.0	48.0	6024	18.000
18.500		20.0	131.0	79.0	50.0	6024	18.500
19.000		20.0	131.0	79.0	50.0	6024	19.000

						Article no.	6024
d1 mm	inch	d2 h6 mm	l1 mm	l2 mm	l3 mm	Order no.	
19.500		20.0	131.0	79.0	50.0	6024	19.500
20.000		20.0	131.0	79.0	50.0	6024	20.000



Ratio drills with coolant ducts

Article no. 6498



Cutting data page 406

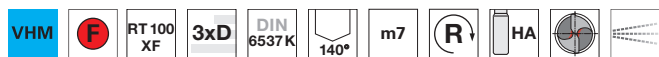

P	M	K	N	S	H
●	○	○	○	○	○

Web thinning ≥ Ø 3.000 • relieved cone • main cutting edge form concave • optimised cutting edge geometry
 • maximum performance • double margin

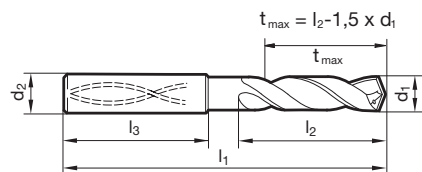

Article no. 6498

Article no. 6498

d1 mm	inch	d2 h6 mm	l1 mm	l2 mm	l3 mm	Order no.	d1 mm	inch	d2 h6 mm	l1 mm	l2 mm	l3 mm	Order no.
3.000		6.0	62.0	20.0	36.0	6498 3.000	7.550		8.0	79.0	41.0	36.0	6498 7.550
3.100		6.0	62.0	20.0	36.0	6498 3.100	7.600		8.0	79.0	41.0	36.0	6498 7.600
3.170	1/8	6.0	62.0	20.0	36.0	6498 3.170	7.650		8.0	79.0	41.0	36.0	6498 7.650
3.200		6.0	62.0	20.0	36.0	6498 3.200	7.700		8.0	79.0	41.0	36.0	6498 7.700
3.250		6.0	62.0	20.0	36.0	6498 3.250	7.800		8.0	79.0	41.0	36.0	6498 7.800
3.300		6.0	62.0	20.0	36.0	6498 3.300	7.900		8.0	79.0	41.0	36.0	6498 7.900
3.400		6.0	62.0	20.0	36.0	6498 3.400	7.940	5/16	8.0	79.0	41.0	36.0	6498 7.940
3.500		6.0	62.0	20.0	36.0	6498 3.500	8.000		8.0	79.0	41.0	36.0	6498 8.000
3.570	9/64	6.0	62.0	20.0	36.0	6498 3.570	8.100		10.0	89.0	47.0	40.0	6498 8.100
3.600		6.0	62.0	20.0	36.0	6498 3.600	8.200		10.0	89.0	47.0	40.0	6498 8.200
3.700		6.0	62.0	20.0	36.0	6498 3.700	8.300		10.0	89.0	47.0	40.0	6498 8.300
3.800		6.0	66.0	24.0	36.0	6498 3.800	8.330	21/64	10.0	89.0	47.0	40.0	6498 8.330
3.900		6.0	66.0	24.0	36.0	6498 3.900	8.400		10.0	89.0	47.0	40.0	6498 8.400
3.970	5/32	6.0	66.0	24.0	36.0	6498 3.970	8.500		10.0	89.0	47.0	40.0	6498 8.500
4.000		6.0	66.0	24.0	36.0	6498 4.000	8.600		10.0	89.0	47.0	40.0	6498 8.600
4.040		6.0	66.0	24.0	36.0	6498 4.040	8.700		10.0	89.0	47.0	40.0	6498 8.700
4.100		6.0	66.0	24.0	36.0	6498 4.100	8.730	11/32	10.0	89.0	47.0	40.0	6498 8.730
4.200		6.0	66.0	24.0	36.0	6498 4.200	8.800		10.0	89.0	47.0	40.0	6498 8.800
4.300		6.0	66.0	24.0	36.0	6498 4.300	8.900		10.0	89.0	47.0	40.0	6498 8.900
4.370	11/64	6.0	66.0	24.0	36.0	6498 4.370	9.000		10.0	89.0	47.0	40.0	6498 9.000
4.400		6.0	66.0	24.0	36.0	6498 4.400	9.100		10.0	89.0	47.0	40.0	6498 9.100
4.500		6.0	66.0	24.0	36.0	6498 4.500	9.130	23/64	10.0	89.0	47.0	40.0	6498 9.130
4.600		6.0	66.0	24.0	36.0	6498 4.600	9.200		10.0	89.0	47.0	40.0	6498 9.200
4.650		6.0	66.0	24.0	36.0	6498 4.650	9.250		10.0	89.0	47.0	40.0	6498 9.250
4.700		6.0	66.0	24.0	36.0	6498 4.700	9.300		10.0	89.0	47.0	40.0	6498 9.300
4.760	3/16	6.0	66.0	28.0	36.0	6498 4.760	9.340		10.0	89.0	47.0	40.0	6498 9.340
4.800		6.0	66.0	28.0	36.0	6498 4.800	9.400		10.0	89.0	47.0	40.0	6498 9.400
4.900		6.0	66.0	28.0	36.0	6498 4.900	9.500		10.0	89.0	47.0	40.0	6498 9.500
5.000		6.0	66.0	28.0	36.0	6498 5.000	9.520	3/8	10.0	89.0	47.0	40.0	6498 9.520
5.100		6.0	66.0	28.0	36.0	6498 5.100	9.550		10.0	89.0	47.0	40.0	6498 9.550
5.110		6.0	66.0	28.0	36.0	6498 5.110	9.600		10.0	89.0	47.0	40.0	6498 9.600
5.160	13/64	6.0	66.0	28.0	36.0	6498 5.160	9.700		10.0	89.0	47.0	40.0	6498 9.700
5.200		6.0	66.0	28.0	36.0	6498 5.200	9.800		10.0	89.0	47.0	40.0	6498 9.800
5.300		6.0	66.0	28.0	36.0	6498 5.300	9.900		10.0	89.0	47.0	40.0	6498 9.900
5.400		6.0	66.0	28.0	36.0	6498 5.400	9.920	25/64	10.0	89.0	47.0	40.0	6498 9.920
5.410		6.0	66.0	28.0	36.0	6498 5.410	10.000		10.0	89.0	47.0	40.0	6498 10.000
5.500		6.0	66.0	28.0	36.0	6498 5.500	10.100		12.0	102.0	55.0	45.0	6498 10.100
5.550		6.0	66.0	28.0	36.0	6498 5.550	10.200		12.0	102.0	55.0	45.0	6498 10.200
5.560	7/32	6.0	66.0	28.0	36.0	6498 5.560	10.300		12.0	102.0	55.0	45.0	6498 10.300
5.600		6.0	66.0	28.0	36.0	6498 5.600	10.320	13/32	12.0	102.0	55.0	45.0	6498 10.320
5.700		6.0	66.0	28.0	36.0	6498 5.700	10.400		12.0	102.0	55.0	45.0	6498 10.400
5.800		6.0	66.0	28.0	36.0	6498 5.800	10.500		12.0	102.0	55.0	45.0	6498 10.500
5.900		6.0	66.0	28.0	36.0	6498 5.900	10.600		12.0	102.0	55.0	45.0	6498 10.600
5.950	15/64	6.0	66.0	28.0	36.0	6498 5.950	10.700		12.0	102.0	55.0	45.0	6498 10.700
6.000		6.0	66.0	28.0	36.0	6498 6.000	10.720	27/64	12.0	102.0	55.0	45.0	6498 10.720
6.100		8.0	79.0	34.0	36.0	6498 6.100	10.800		12.0	102.0	55.0	45.0	6498 10.800
6.200		8.0	79.0	34.0	36.0	6498 6.200	10.900		12.0	102.0	55.0	45.0	6498 10.900
6.300		8.0	79.0	34.0	36.0	6498 6.300	11.000		12.0	102.0	55.0	45.0	6498 11.000
6.350	1/4	8.0	79.0	34.0	36.0	6498 6.350	11.100		12.0	102.0	55.0	45.0	6498 11.100
6.400		8.0	79.0	34.0	36.0	6498 6.400	11.110	7/16	12.0	102.0	55.0	45.0	6498 11.110
6.500		8.0	79.0	34.0	36.0	6498 6.500	11.200		12.0	102.0	55.0	45.0	6498 11.200
6.530		8.0	79.0	34.0	36.0	6498 6.530	11.300		12.0	102.0	55.0	45.0	6498 11.300
6.550		8.0	79.0	34.0	36.0	6498 6.550	11.400		12.0	102.0	55.0	45.0	6498 11.400
6.600		8.0	79.0	34.0	36.0	6498 6.600	11.500		12.0	102.0	55.0	45.0	6498 11.500
6.700		8.0	79.0	34.0	36.0	6498 6.700	11.510	29/64	12.0	102.0	55.0	45.0	6498 11.510
6.750	17/64	8.0	79.0	34.0	36.0	6498 6.750	11.550		12.0	102.0	55.0	45.0	6498 11.550
6.800		8.0	79.0	34.0	36.0	6498 6.800	11.600		12.0	102.0	55.0	45.0	6498 11.600
6.900		8.0	79.0	34.0	36.0	6498 6.900	11.700		12.0	102.0	55.0	45.0	6498 11.700
7.000		8.0	79.0	34.0	36.0	6498 7.000	11.800		12.0	102.0	55.0	45.0	6498 11.800
7.100		8.0	79.0	41.0	36.0	6498 7.100	11.900		12.0	102.0	55.0	45.0	6498 11.900
7.140	9/32	8.0	79.0	41.0	36.0	6498 7.140	11.910	15/32	12.0	102.0	55.0	45.0	6498 11.910
7.200		8.0	79.0	41.0	36.0	6498 7.200	12.000		12.0	102.0	55.0	45.0	6498 12.000
7.300		8.0	79.0	41.0	36.0	6498 7.300	12.100		14.0	107.0	60.0	45.0	6498 12.100
7.400		8.0	79.0	41.0	36.0	6498 7.400	12.200		14.0	107.0	60.0	45.0	6498 12.200
7.500		8.0	79.0	41.0	36.0	6498 7.500	12.300	31/64	14.0	107.0	60.0	45.0	6498 12.300
7.540	19/64	8.0	79.0	41.0	36.0	6498 7.540	12.400		14.0	107.0	60.0	45.0	6498 12.400



Solid carbide drills

Article no. 6498						Article no. 6498							
d1 mm	inch	d2 h6 mm	l1 mm	l2 mm	l3 mm	Order no.	d1 mm	inch	d2 h6 mm	l1 mm	l2 mm	l3 mm	Order no.
12.500		14.0	107.0	60.0	45.0	6498 12.500	15.900		16.0	115.0	65.0	48.0	6498 15.900
12.600		14.0	107.0	60.0	45.0	6498 12.600	16.000		16.0	115.0	65.0	48.0	6498 16.000
12.700	1/2	14.0	107.0	60.0	45.0	6498 12.700	16.270	41/64	18.0	123.0	73.0	48.0	6498 16.270
12.800		14.0	107.0	60.0	45.0	6498 12.800	16.300		18.0	123.0	73.0	48.0	6498 16.300
12.900		14.0	107.0	60.0	45.0	6498 12.900	16.500		18.0	123.0	73.0	48.0	6498 16.500
13.000		14.0	107.0	60.0	45.0	6498 13.000	16.670	21/32	18.0	123.0	73.0	48.0	6498 16.670
13.100	33/64	14.0	107.0	60.0	45.0	6498 13.100	16.700		18.0	123.0	73.0	48.0	6498 16.700
13.200		14.0	107.0	60.0	45.0	6498 13.200	16.900		18.0	123.0	73.0	48.0	6498 16.900
13.300		14.0	107.0	60.0	45.0	6498 13.300	17.000		18.0	123.0	73.0	48.0	6498 17.000
13.400		14.0	107.0	60.0	45.0	6498 13.400	17.070	43/64	18.0	123.0	73.0	48.0	6498 17.070
13.490	17/32	14.0	107.0	60.0	45.0	6498 13.490	17.460	11/16	18.0	123.0	73.0	48.0	6498 17.460
13.500		14.0	107.0	60.0	45.0	6498 13.500	17.500		18.0	123.0	73.0	48.0	6498 17.500
13.600		14.0	107.0	60.0	45.0	6498 13.600	17.550		18.0	123.0	73.0	48.0	6498 17.550
13.700		14.0	107.0	60.0	45.0	6498 13.700	17.700		18.0	123.0	73.0	48.0	6498 17.700
13.800		14.0	107.0	60.0	45.0	6498 13.800	17.860	45/64	18.0	123.0	73.0	48.0	6498 17.860
13.890	35/64	14.0	107.0	60.0	45.0	6498 13.890	18.000		18.0	123.0	73.0	48.0	6498 18.000
13.900		14.0	107.0	60.0	45.0	6498 13.900	18.260	23/32	20.0	131.0	79.0	50.0	6498 18.260
14.000		14.0	107.0	60.0	45.0	6498 14.000	18.500		20.0	131.0	79.0	50.0	6498 18.500
14.100		16.0	115.0	65.0	48.0	6498 14.100	18.700		20.0	131.0	79.0	50.0	6498 18.700
14.200		16.0	115.0	65.0	48.0	6498 14.200	18.900		20.0	131.0	79.0	50.0	6498 18.900
14.290	9/16	16.0	115.0	65.0	48.0	6498 14.290	19.000		20.0	131.0	79.0	50.0	6498 19.000
14.300		16.0	115.0	65.0	48.0	6498 14.300	19.050	3/4	20.0	131.0	79.0	50.0	6498 19.050
14.400		16.0	115.0	65.0	48.0	6498 14.400	19.250		20.0	131.0	79.0	50.0	6498 19.250
14.500		16.0	115.0	65.0	48.0	6498 14.500	19.300		20.0	131.0	79.0	50.0	6498 19.300
14.600		16.0	115.0	65.0	48.0	6498 14.600	19.450	49/64	20.0	131.0	79.0	50.0	6498 19.450
14.680	37/64	16.0	115.0	65.0	48.0	6498 14.680	19.500		20.0	131.0	79.0	50.0	6498 19.500
14.700		16.0	115.0	65.0	48.0	6498 14.700	19.550		20.0	131.0	79.0	50.0	6498 19.550
14.800		16.0	115.0	65.0	48.0	6498 14.800	19.700		20.0	131.0	79.0	50.0	6498 19.700
14.900		16.0	115.0	65.0	48.0	6498 14.900	19.800		20.0	131.0	79.0	50.0	6498 19.800
15.000		16.0	115.0	65.0	48.0	6498 15.000	19.840	25/32	20.0	131.0	79.0	50.0	6498 19.840
15.080	19/32	16.0	115.0	65.0	48.0	6498 15.080	20.000		20.0	131.0	79.0	50.0	6498 20.000
15.100		16.0	115.0	65.0	48.0	6498 15.100							
15.200		16.0	115.0	65.0	48.0	6498 15.200							
15.300		16.0	115.0	65.0	48.0	6498 15.300							
15.400		16.0	115.0	65.0	48.0	6498 15.400							
15.480	39/64	16.0	115.0	65.0	48.0	6498 15.480							
15.500		16.0	115.0	65.0	48.0	6498 15.500							
15.550		16.0	115.0	65.0	48.0	6498 15.550							
15.600		16.0	115.0	65.0	48.0	6498 15.600							
15.700		16.0	115.0	65.0	48.0	6498 15.700							
15.800		16.0	115.0	65.0	48.0	6498 15.800							
15.870	5/8	16.0	115.0	65.0	48.0	6498 15.870							



Ratio drills with coolant ducts

Article no. 768



Cutting data page 412

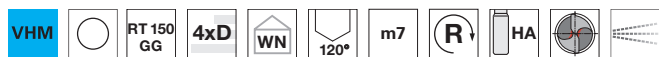

P	M	K	N	S	H
		•	•		○

Web thinning ≥ Ø 3.000 • relieved cone • close diameter tolerances • very good surface quality of hole • observe coolant pressure

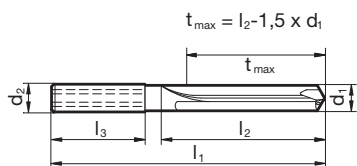

Article no. 768						Article no. 768							
d1		d2 h6	l1	l2	l3	Order no.	d1		d2 h6	l1	l2	l3	Order no.
mm	inch	mm	mm	mm	mm		mm	inch	mm	mm	mm	mm	
3.000		6.0	66.0	24.0	36.0	768 3.000	8.700		10.0	103.0	61.0	40.0	768 8.700
3.100		6.0	66.0	24.0	36.0	768 3.100	8.730	11/32	10.0	103.0	61.0	40.0	768 8.730
3.200		6.0	66.0	24.0	36.0	768 3.200	8.800		10.0	103.0	61.0	40.0	768 8.800
3.300		6.0	66.0	24.0	36.0	768 3.300	8.900		10.0	103.0	61.0	40.0	768 8.900
3.400		6.0	66.0	24.0	36.0	768 3.400	9.000		10.0	103.0	61.0	40.0	768 9.000
3.500		6.0	66.0	24.0	36.0	768 3.500	9.100		10.0	103.0	61.0	40.0	768 9.100
3.600		6.0	66.0	24.0	36.0	768 3.600	9.130	23/64	10.0	103.0	61.0	40.0	768 9.130
3.700		6.0	66.0	24.0	36.0	768 3.700	9.200		10.0	103.0	61.0	40.0	768 9.200
3.800		6.0	74.0	30.0	36.0	768 3.800	9.300		10.0	103.0	61.0	40.0	768 9.300
3.900		6.0	74.0	30.0	36.0	768 3.900	9.400		10.0	103.0	61.0	40.0	768 9.400
4.000		6.0	74.0	30.0	36.0	768 4.000	9.500		10.0	103.0	61.0	40.0	768 9.500
4.100		6.0	74.0	30.0	36.0	768 4.100	9.520	3/8	10.0	103.0	61.0	40.0	768 9.520
4.200		6.0	74.0	30.0	36.0	768 4.200	9.600		10.0	103.0	61.0	40.0	768 9.600
4.300		6.0	74.0	30.0	36.0	768 4.300	9.700		10.0	103.0	61.0	40.0	768 9.700
4.400		6.0	74.0	30.0	36.0	768 4.400	9.800		10.0	103.0	61.0	40.0	768 9.800
4.500		6.0	74.0	30.0	36.0	768 4.500	9.900		10.0	103.0	61.0	40.0	768 9.900
4.600		6.0	74.0	30.0	36.0	768 4.600	9.920	25/64	10.0	103.0	61.0	40.0	768 9.920
4.700		6.0	74.0	30.0	36.0	768 4.700	10.000		10.0	103.0	61.0	40.0	768 10.000
4.800		6.0	74.0	36.0	36.0	768 4.800	10.200		12.0	118.0	71.0	45.0	768 10.200
4.900		6.0	74.0	36.0	36.0	768 4.900	10.320	13/32	12.0	118.0	71.0	45.0	768 10.320
5.000		6.0	74.0	36.0	36.0	768 5.000	10.500		12.0	118.0	71.0	45.0	768 10.500
5.100		6.0	74.0	36.0	36.0	768 5.100	10.720	27/64	12.0	118.0	71.0	45.0	768 10.720
5.160	13/64	6.0	74.0	36.0	36.0	768 5.160	11.000		12.0	118.0	71.0	45.0	768 11.000
5.200		6.0	74.0	36.0	36.0	768 5.200	11.110	7/16	12.0	118.0	71.0	45.0	768 11.110
5.300		6.0	74.0	36.0	36.0	768 5.300	11.200		12.0	118.0	71.0	45.0	768 11.200
5.400		6.0	74.0	36.0	36.0	768 5.400	11.500		12.0	118.0	71.0	45.0	768 11.500
5.500		6.0	74.0	36.0	36.0	768 5.500	11.510	29/64	12.0	118.0	71.0	45.0	768 11.510
5.560	7/32	6.0	74.0	36.0	36.0	768 5.560	11.910	15/32	12.0	118.0	71.0	45.0	768 11.910
5.600		6.0	74.0	36.0	36.0	768 5.600	12.000		12.0	118.0	71.0	45.0	768 12.000
5.700		6.0	74.0	36.0	36.0	768 5.700	12.300	31/64	14.0	124.0	74.0	45.0	768 12.300
5.800		6.0	74.0	36.0	36.0	768 5.800	12.500		14.0	124.0	74.0	45.0	768 12.500
5.900		6.0	74.0	36.0	36.0	768 5.900	12.700	1/2	14.0	124.0	74.0	45.0	768 12.700
5.950	15/64	6.0	74.0	36.0	36.0	768 5.950	13.000		14.0	124.0	74.0	45.0	768 13.000
6.000		6.0	74.0	36.0	36.0	768 6.000	13.500		14.0	124.0	74.0	45.0	768 13.500
6.100		8.0	91.0	53.0	36.0	768 6.100	14.000		14.0	124.0	74.0	45.0	768 14.000
6.200		8.0	91.0	53.0	36.0	768 6.200	14.500		16.0	133.0	83.0	48.0	768 14.500
6.300		8.0	91.0	53.0	36.0	768 6.300	15.000		16.0	133.0	83.0	48.0	768 15.000
6.350	1/4	8.0	91.0	53.0	36.0	768 6.350	15.500		16.0	133.0	83.0	48.0	768 15.500
6.400		8.0	91.0	53.0	36.0	768 6.400	16.000		16.0	133.0	83.0	48.0	768 16.000
6.500		8.0	91.0	53.0	36.0	768 6.500	16.500		18.0	143.0	93.0	48.0	768 16.500
6.600		8.0	91.0	53.0	36.0	768 6.600	17.000		18.0	143.0	93.0	48.0	768 17.000
6.700		8.0	91.0	53.0	36.0	768 6.700	17.500		18.0	143.0	93.0	48.0	768 17.500
6.750	17/64	8.0	91.0	53.0	36.0	768 6.750	18.000		18.0	143.0	93.0	48.0	768 18.000
6.800		8.0	91.0	53.0	36.0	768 6.800	18.500		20.0	153.0	101.0	50.0	768 18.500
6.900		8.0	91.0	53.0	36.0	768 6.900	19.000		20.0	153.0	101.0	50.0	768 19.000
7.000		8.0	91.0	53.0	36.0	768 7.000	19.500		20.0	153.0	101.0	50.0	768 19.500
7.100		8.0	91.0	53.0	36.0	768 7.100	20.000		20.0	153.0	101.0	50.0	768 20.000
7.140	9/32	8.0	91.0	53.0	36.0	768 7.140	20.500		25.0	160.0	106.0	56.0	768 20.500
7.200		8.0	91.0	53.0	36.0	768 7.200	21.000		25.0	160.0	106.0	56.0	768 21.000
7.300		8.0	91.0	53.0	36.0	768 7.300	21.500		25.0	168.0	110.0	56.0	768 21.500
7.400		8.0	91.0	53.0	36.0	768 7.400	22.000		25.0	168.0	110.0	56.0	768 22.000
7.500		8.0	91.0	53.0	36.0	768 7.500	22.500		25.0	172.0	115.0	56.0	768 22.500
7.540	19/64	8.0	91.0	53.0	36.0	768 7.540	23.000		25.0	172.0	115.0	56.0	768 23.000
7.600		8.0	91.0	53.0	36.0	768 7.600	23.500		25.0	172.0	115.0	56.0	768 23.500
7.700		8.0	91.0	53.0	36.0	768 7.700	24.000		25.0	172.0	115.0	56.0	768 24.000
7.800		8.0	91.0	53.0	36.0	768 7.800	24.500		25.0	182.0	127.0	56.0	768 24.500
7.900		8.0	91.0	53.0	36.0	768 7.900	25.000	63/64	25.0	182.0	127.0	56.0	768 25.000
7.940	5/16	8.0	91.0	53.0	36.0	768 7.940							
8.000		8.0	91.0	53.0	36.0	768 8.000							
8.100		10.0	103.0	61.0	40.0	768 8.100							
8.200		10.0	103.0	61.0	40.0	768 8.200							
8.300		10.0	103.0	61.0	40.0	768 8.300							
8.330	21/64	10.0	103.0	61.0	40.0	768 8.330							
8.400		10.0	103.0	61.0	40.0	768 8.400							
8.500		10.0	103.0	61.0	40.0	768 8.500							
8.600		10.0	103.0	61.0	40.0	768 8.600							



Ratio drills with coolant ducts

Article no. **6068**



Cutting data page 415

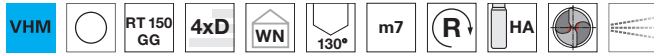

Web thinning $\geq \varnothing 3.000$ • facet point grind • close diameter tolerances • very good surface quality of hole • observe optimal coolant pressure

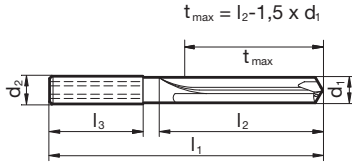

Article no. **6068**

Article no. **6068**

d1 mm	inch	d2 h6 mm	l1 mm	l2 mm	l3 mm	Order no.	d1 mm	inch	d2 h6 mm	l1 mm	l2 mm	l3 mm	Order no.
3.000		6.0	66.0	24.0	36.0	6068 3.000	8.300		10.0	103.0	61.0	40.0	6068 8.300
3.100		6.0	66.0	24.0	36.0	6068 3.100	8.400		10.0	103.0	61.0	40.0	6068 8.400
3.200		6.0	66.0	24.0	36.0	6068 3.200	8.500		10.0	103.0	61.0	40.0	6068 8.500
3.300		6.0	66.0	24.0	36.0	6068 3.300	8.600		10.0	103.0	61.0	40.0	6068 8.600
3.400		6.0	66.0	24.0	36.0	6068 3.400	8.700		10.0	103.0	61.0	40.0	6068 8.700
3.500		6.0	66.0	24.0	36.0	6068 3.500	8.730	11/32	10.0	103.0	61.0	40.0	6068 8.730
3.600		6.0	66.0	24.0	36.0	6068 3.600	9.000		10.0	103.0	61.0	40.0	6068 9.000
3.700		6.0	66.0	24.0	36.0	6068 3.700	9.130	23/64	10.0	103.0	61.0	40.0	6068 9.130
3.800		6.0	74.0	30.0	36.0	6068 3.800	9.200		10.0	103.0	61.0	40.0	6068 9.200
3.900		6.0	74.0	30.0	36.0	6068 3.900	9.300		10.0	103.0	61.0	40.0	6068 9.300
4.000		6.0	74.0	30.0	36.0	6068 4.000	9.500		10.0	103.0	61.0	40.0	6068 9.500
4.200		6.0	74.0	30.0	36.0	6068 4.200	9.520	3/8	10.0	103.0	61.0	40.0	6068 9.520
4.500		6.0	74.0	30.0	36.0	6068 4.500	9.600		10.0	103.0	61.0	40.0	6068 9.600
4.600		6.0	74.0	30.0	36.0	6068 4.600	9.700		10.0	103.0	61.0	40.0	6068 9.700
4.800		6.0	74.0	36.0	36.0	6068 4.800	9.800		10.0	103.0	61.0	40.0	6068 9.800
5.000		6.0	74.0	36.0	36.0	6068 5.000	9.920	25/64	10.0	103.0	61.0	40.0	6068 9.920
5.100		6.0	74.0	36.0	36.0	6068 5.100	10.000		10.0	103.0	61.0	40.0	6068 10.000
5.160	13/64	6.0	74.0	36.0	36.0	6068 5.160	10.200		12.0	118.0	71.0	45.0	6068 10.200
5.200		6.0	74.0	36.0	36.0	6068 5.200	10.500		12.0	118.0	71.0	45.0	6068 10.500
5.300		6.0	74.0	36.0	36.0	6068 5.300	10.720	27/64	12.0	118.0	71.0	45.0	6068 10.720
5.400		6.0	74.0	36.0	36.0	6068 5.400	11.000		12.0	118.0	71.0	45.0	6068 11.000
5.500		6.0	74.0	36.0	36.0	6068 5.500	11.110	7/16	12.0	118.0	71.0	45.0	6068 11.110
5.560	7/32	6.0	74.0	36.0	36.0	6068 5.560	11.500		12.0	118.0	71.0	45.0	6068 11.500
5.600		6.0	74.0	36.0	36.0	6068 5.600	12.000		12.0	118.0	71.0	45.0	6068 12.000
5.800		6.0	74.0	36.0	36.0	6068 5.800	12.300	31/64	14.0	124.0	74.0	45.0	6068 12.300
6.000		6.0	74.0	36.0	36.0	6068 6.000	12.500		14.0	124.0	74.0	45.0	6068 12.500
6.100		8.0	91.0	53.0	36.0	6068 6.100	12.700	1/2	14.0	124.0	74.0	45.0	6068 12.700
6.200		8.0	91.0	53.0	36.0	6068 6.200	13.000		14.0	124.0	74.0	45.0	6068 13.000
6.300		8.0	91.0	53.0	36.0	6068 6.300	13.500		14.0	124.0	74.0	45.0	6068 13.500
6.350	1/4	8.0	91.0	53.0	36.0	6068 6.350	14.000		14.0	124.0	74.0	45.0	6068 14.000
6.400		8.0	91.0	53.0	36.0	6068 6.400	14.500		16.0	133.0	83.0	48.0	6068 14.500
6.500		8.0	91.0	53.0	36.0	6068 6.500	15.000		16.0	133.0	83.0	48.0	6068 15.000
6.600		8.0	91.0	53.0	36.0	6068 6.600	15.500		16.0	133.0	83.0	48.0	6068 15.500
6.750	17/64	8.0	91.0	53.0	36.0	6068 6.750	16.000		16.0	133.0	83.0	48.0	6068 16.000
6.800		8.0	91.0	53.0	36.0	6068 6.800	16.500		18.0	143.0	93.0	48.0	6068 16.500
6.900		8.0	91.0	53.0	36.0	6068 6.900	17.000		18.0	143.0	93.0	48.0	6068 17.000
7.000		8.0	91.0	53.0	36.0	6068 7.000	17.500		18.0	143.0	93.0	48.0	6068 17.500
7.100		8.0	91.0	53.0	36.0	6068 7.100	18.000		18.0	143.0	93.0	48.0	6068 18.000
7.140	9/32	8.0	91.0	53.0	36.0	6068 7.140	18.500		20.0	153.0	101.0	50.0	6068 18.500
7.200		8.0	91.0	53.0	36.0	6068 7.200	19.000		20.0	153.0	101.0	50.0	6068 19.000
7.300		8.0	91.0	53.0	36.0	6068 7.300	19.500		20.0	153.0	101.0	50.0	6068 19.500
7.400		8.0	91.0	53.0	36.0	6068 7.400	20.000		20.0	153.0	101.0	50.0	6068 20.000
7.500		8.0	91.0	53.0	36.0	6068 7.500							
7.540	19/64	8.0	91.0	53.0	36.0	6068 7.540							
7.800		8.0	91.0	53.0	36.0	6068 7.800							
8.000		8.0	91.0	53.0	36.0	6068 8.000							
8.100		10.0	103.0	61.0	40.0	6068 8.100							
8.200		10.0	103.0	61.0	40.0	6068 8.200							



Ratio drills with coolant ducts

Article no. 2479



Cutting data page 401



Web thinning ≥ Ø 2.500 • facet point grind • main cutting edge form straight • optimised cutting edge geometry

Ratio drills with coolant ducts

Article no. 2471



Cutting data page 401



Web thinning ≥ Ø 3.000 • facet point grind • main cutting edge form straight • optimised cutting edge geometry

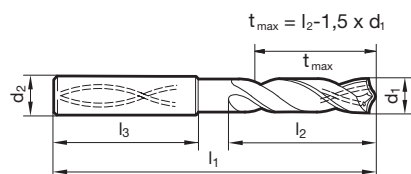

Article no.

2479 2471

Article no.

2479 2471

d1 mm	inch	d2 h6 mm	l1 mm	l2 mm	l3 mm	Order no.	d1 mm	inch	d2 h6 mm	l1 mm	l2 mm	l3 mm	Order no.
2.500		4.0	57.0	20.0	31.7	2479 2.500	6.500		8.0	91.0	53.0	36.0	2479 6.500
2.800		4.0	57.0	22.0	29.9	2479 2.800	6.530		8.0	91.0	53.0	36.0	2479 6.530
2.900		4.0	57.0	23.0	29.0	2479 2.900	6.600		8.0	91.0	53.0	36.0	2479 6.600
3.000		6.0	66.0	28.0	36.0	2479 3.000	6.700		8.0	91.0	53.0	36.0	2479 6.700
3.100		6.0	66.0	28.0	36.0	2479 3.100	6.750	17/64	8.0	91.0	53.0	36.0	2479 6.750
3.170	1/8	6.0	66.0	28.0	36.0	2479 3.170	6.800		8.0	91.0	53.0	36.0	2479 6.800
3.200		6.0	66.0	28.0	36.0	2479 3.200	6.900		8.0	91.0	53.0	36.0	2479 6.900
3.250		6.0	66.0	28.0	36.0	2479 3.250	7.000		8.0	91.0	53.0	36.0	2479 7.000
3.300		6.0	66.0	28.0	36.0	2479 3.300	7.100		8.0	91.0	53.0	36.0	2479 7.100
3.400		6.0	66.0	28.0	36.0	2479 3.400	7.140	9/32	8.0	91.0	53.0	36.0	2479 7.140
3.500		6.0	66.0	28.0	36.0	2479 3.500	7.200		8.0	91.0	53.0	36.0	2479 7.200
3.570	9/64	6.0	66.0	28.0	36.0	2479 3.570	7.300		8.0	91.0	53.0	36.0	2479 7.300
3.600		6.0	66.0	28.0	36.0	2479 3.600	7.400		8.0	91.0	53.0	36.0	2479 7.400
3.700		6.0	66.0	28.0	36.0	2479 3.700	7.500		8.0	91.0	53.0	36.0	2479 7.500
3.800		6.0	74.0	36.0	36.0	2479 3.800	7.540	19/64	8.0	91.0	53.0	36.0	2479 7.540
3.900		6.0	74.0	36.0	36.0	2479 3.900	7.550		8.0	91.0	53.0	36.0	2479 7.550
3.970	5/32	6.0	74.0	36.0	36.0	2479 3.970	7.600		8.0	91.0	53.0	36.0	2479 7.600
4.000		6.0	74.0	36.0	36.0	2479 4.000	7.650		8.0	91.0	53.0	36.0	2479 7.650
4.040		6.0	74.0	36.0	36.0	2479 4.040	7.700		8.0	91.0	53.0	36.0	2479 7.700
4.100		6.0	74.0	36.0	36.0	2479 4.100	7.800		8.0	91.0	53.0	36.0	2479 7.800
4.200		6.0	74.0	36.0	36.0	2479 4.200	7.900		8.0	91.0	53.0	36.0	2479 7.900
4.300		6.0	74.0	36.0	36.0	2479 4.300	7.940	5/16	8.0	91.0	53.0	36.0	2479 7.940
4.370	11/64	6.0	74.0	36.0	36.0	2479 4.370	8.000		8.0	91.0	53.0	36.0	2479 8.000
4.400		6.0	74.0	36.0	36.0	2479 4.400	8.100		10.0	103.0	61.0	40.0	2479 8.100
4.500		6.0	74.0	36.0	36.0	2479 4.500	8.200		10.0	103.0	61.0	40.0	2479 8.200
4.600		6.0	74.0	36.0	36.0	2479 4.600	8.300		10.0	103.0	61.0	40.0	2479 8.300
4.650		6.0	74.0	36.0	36.0	2479 4.650	8.330	21/64	10.0	103.0	61.0	40.0	2479 8.330
4.700		6.0	74.0	36.0	36.0	2479 4.700	8.400		10.0	103.0	61.0	40.0	2479 8.400
4.760	3/16	6.0	82.0	44.0	36.0	2479 4.760	8.500		10.0	103.0	61.0	40.0	2479 8.500
4.800		6.0	82.0	44.0	36.0	2479 4.800	8.600		10.0	103.0	61.0	40.0	2479 8.600
4.900		6.0	82.0	44.0	36.0	2479 4.900	8.700		10.0	103.0	61.0	40.0	2479 8.700
5.000		6.0	82.0	44.0	36.0	2479 5.000	8.730	11/32	10.0	103.0	61.0	40.0	2479 8.730
5.100		6.0	82.0	44.0	36.0	2479 5.100	8.800		10.0	103.0	61.0	40.0	2479 8.800
5.110		6.0	82.0	44.0	36.0	2479 5.110	8.900		10.0	103.0	61.0	40.0	2479 8.900
5.160	13/64	6.0	82.0	44.0	36.0	2479 5.160	9.000		10.0	103.0	61.0	40.0	2479 9.000
5.200		6.0	82.0	44.0	36.0	2479 5.200	9.100		10.0	103.0	61.0	40.0	2479 9.100
5.300		6.0	82.0	44.0	36.0	2479 5.300	9.130	23/64	10.0	103.0	61.0	40.0	2479 9.130
5.400		6.0	82.0	44.0	36.0	2479 5.400	9.200		10.0	103.0	61.0	40.0	2479 9.200
5.410		6.0	82.0	44.0	36.0	2479 5.410	9.250		10.0	103.0	61.0	40.0	2479 9.250
5.500		6.0	82.0	44.0	36.0	2479 5.500	9.300		10.0	103.0	61.0	40.0	2479 9.300
5.550		6.0	82.0	44.0	36.0	2479 5.550	9.340		10.0	103.0	61.0	40.0	2479 9.340
5.560	7/32	6.0	82.0	44.0	36.0	2479 5.560	9.400		10.0	103.0	61.0	40.0	2479 9.400
5.600		6.0	82.0	44.0	36.0	2479 5.600	9.500		10.0	103.0	61.0	40.0	2479 9.500
5.650		6.0	82.0	44.0	36.0	2479 5.650	9.520	3/8	10.0	103.0	61.0	40.0	2479 9.520
5.700		6.0	82.0	44.0	36.0	2479 5.700	9.550		10.0	103.0	61.0	40.0	2479 9.550
5.800		6.0	82.0	44.0	36.0	2479 5.800	9.600		10.0	103.0	61.0	40.0	2479 9.600
5.900		6.0	82.0	44.0	36.0	2479 5.900	9.700		10.0	103.0	61.0	40.0	2479 9.700
5.950	15/64	6.0	82.0	44.0	36.0	2479 5.950	9.800		10.0	103.0	61.0	40.0	2479 9.800
6.000		6.0	82.0	44.0	36.0	2479 6.000	9.900		10.0	103.0	61.0	40.0	2479 9.900
6.100		8.0	91.0	53.0	36.0	2479 6.100	9.920	25/64	10.0	103.0	61.0	40.0	2479 9.920
6.200		8.0	91.0	53.0	36.0	2479 6.200	10.000		10.0	103.0	61.0	40.0	2479 10.000
6.300		8.0	91.0	53.0	36.0	2479 6.300	10.100		12.0	118.0	71.0	45.0	2479 10.100
6.350	1/4	8.0	91.0	53.0	36.0	2479 6.350	10.200		12.0	118.0	71.0	45.0	2479 10.200
6.400		8.0	91.0	53.0	36.0	2479 6.400	10.300		12.0	118.0	71.0	45.0	2479 10.300



Solid carbide drills

Article no.						2479	2471	Article no.						2479	2471
d1 mm	inch	d2 h6 mm	l1 mm	l2 mm	l3 mm	Order no.		d1 mm	inch	d2 h6 mm	l1 mm	l2 mm	l3 mm	Order no.	
10.320	13/32	12.0	118.0	71.0	45.0	2479 10.320	2471 10.320	14.900		16.0	133.0	83.0	48.0	2479 14.900	
10.400		12.0	118.0	71.0	45.0	2479 10.400	2471 10.400	15.000		16.0	133.0	83.0	48.0	2479 15.000	2471 15.000
10.500		12.0	118.0	71.0	45.0	2479 10.500	2471 10.500	15.080	19/32	16.0	133.0	83.0	48.0	2479 15.080	
10.600		12.0	118.0	71.0	45.0	2479 10.600	2471 10.600	15.100		16.0	133.0	83.0	48.0	2479 15.100	
10.700		12.0	118.0	71.0	45.0	2479 10.700	2471 10.700	15.200		16.0	133.0	83.0	48.0	2479 15.200	2471 15.200
10.720	27/64	12.0	118.0	71.0	45.0	2479 10.720		15.300		16.0	133.0	83.0	48.0	2479 15.300	
10.800		12.0	118.0	71.0	45.0	2479 10.800	2471 10.800	15.400		16.0	133.0	83.0	48.0	2479 15.400	
10.900		12.0	118.0	71.0	45.0	2479 10.900	2471 10.900	15.480	39/64	16.0	133.0	83.0	48.0	2479 15.480	
11.000		12.0	118.0	71.0	45.0	2479 11.000	2471 11.000	15.500		16.0	133.0	83.0	48.0	2479 15.500	2471 15.500
11.100		12.0	118.0	71.0	45.0	2479 11.100	2471 11.100	15.550		16.0	133.0	83.0	48.0	2479 15.550	
11.110	7/16	12.0	118.0	71.0	45.0	2479 11.110	2471 11.110	15.600		16.0	133.0	83.0	48.0	2479 15.600	
11.200		12.0	118.0	71.0	45.0	2479 11.200	2471 11.200	15.700		16.0	133.0	83.0	48.0	2479 15.700	2471 15.700
11.300		12.0	118.0	71.0	45.0	2479 11.300	2471 11.300	15.800		16.0	133.0	83.0	48.0	2479 15.800	2471 15.800
11.400		12.0	118.0	71.0	45.0	2479 11.400	2471 11.400	15.870	5/8	16.0	133.0	83.0	48.0	2479 15.870	
11.500		12.0	118.0	71.0	45.0	2479 11.500	2471 11.500	15.900		16.0	133.0	83.0	48.0	2479 15.900	
11.510	29/64	12.0	118.0	71.0	45.0	2479 11.510		16.000		16.0	133.0	83.0	48.0	2479 16.000	2471 16.000
11.550		12.0	118.0	71.0	45.0	2479 11.550		16.270	41/64	18.0	143.0	93.0	48.0	2479 16.270	
11.600		12.0	118.0	71.0	45.0	2479 11.600	2471 11.600	16.500		18.0	143.0	93.0	48.0	2479 16.500	2471 16.500
11.700		12.0	118.0	71.0	45.0	2479 11.700	2471 11.700	16.670	21/32	18.0	143.0	93.0	48.0	2479 16.670	
11.800		12.0	118.0	71.0	45.0	2479 11.800	2471 11.800	16.700		18.0	143.0	93.0	48.0	2479 16.700	
11.900		12.0	118.0	71.0	45.0	2479 11.900	2471 11.900	16.900		18.0	143.0	93.0	48.0	2479 16.900	
11.910	15/32	12.0	118.0	71.0	45.0	2479 11.910	2471 11.910	17.000		18.0	143.0	93.0	48.0	2479 17.000	2471 17.000
12.000		12.0	118.0	71.0	45.0	2479 12.000	2471 12.000	17.070	43/64	18.0	143.0	93.0	48.0	2479 17.070	
12.100		14.0	124.0	77.0	45.0	2479 12.100	2471 12.100	17.300		18.0	143.0	93.0	48.0		2471 17.300
12.200		14.0	124.0	77.0	45.0	2479 12.200	2471 12.200	17.460	11/16	18.0	143.0	93.0	48.0	2479 17.460	
12.300	31/64	14.0	124.0	77.0	45.0	2479 12.300	2471 12.300	17.500		18.0	143.0	93.0	48.0	2479 17.500	2471 17.500
12.400		14.0	124.0	77.0	45.0	2479 12.400	2471 12.400	17.550		18.0	143.0	93.0	48.0	2479 17.550	
12.500		14.0	124.0	77.0	45.0	2479 12.500	2471 12.500	17.700		18.0	143.0	93.0	48.0	2479 17.700	
12.600		14.0	124.0	77.0	45.0	2479 12.600		17.860	45/64	18.0	143.0	93.0	48.0	2479 17.860	
12.700	1/2	14.0	124.0	77.0	45.0	2479 12.700	2471 12.700	18.000		18.0	143.0	93.0	48.0	2479 18.000	2471 18.000
12.800		14.0	124.0	77.0	45.0	2479 12.800		18.200		20.0	153.0	101.0	50.0		2471 18.200
12.900		14.0	124.0	77.0	45.0	2479 12.900		18.260	23/32	20.0	153.0	101.0	50.0	2479 18.260	
13.000		14.0	124.0	77.0	45.0	2479 13.000	2471 13.000	18.500		20.0	153.0	101.0	50.0	2479 18.500	2471 18.500
13.100	33/64	14.0	124.0	77.0	45.0	2479 13.100		18.600		20.0	153.0	101.0	50.0		2471 18.600
13.200		14.0	124.0	77.0	45.0	2479 13.200		18.700		20.0	153.0	101.0	50.0	2479 18.700	
13.300		14.0	124.0	77.0	45.0	2479 13.300		18.900		20.0	153.0	101.0	50.0	2479 18.900	
13.400		14.0	124.0	77.0	45.0	2479 13.400		19.000		20.0	153.0	101.0	50.0	2479 19.000	2471 19.000
13.490	17/32	14.0	124.0	77.0	45.0	2479 13.490		19.050	3/4	20.0	153.0	101.0	50.0	2479 19.050	2471 19.050
13.500		14.0	124.0	77.0	45.0	2479 13.500	2471 13.500	19.250		20.0	153.0	101.0	50.0	2479 19.250	
13.600		14.0	124.0	77.0	45.0	2479 13.600		19.300		20.0	153.0	101.0	50.0	2479 19.300	
13.700		14.0	124.0	77.0	45.0	2479 13.700	2471 13.700	19.446		20.0	153.0	101.0	50.0	2479 19.446	
13.800		14.0	124.0	77.0	45.0	2479 13.800	2471 13.800	19.500		20.0	153.0	101.0	50.0	2479 19.500	2471 19.500
13.890	35/64	14.0	124.0	77.0	45.0	2479 13.890		19.550		20.0	153.0	101.0	50.0	2479 19.550	
13.900		14.0	124.0	77.0	45.0	2479 13.900	2471 13.900	19.700		20.0	153.0	101.0	50.0	2479 19.700	
14.000		14.0	124.0	77.0	45.0	2479 14.000	2471 14.000	19.840	25/32	20.0	153.0	101.0	50.0	2479 19.840	
14.100		16.0	133.0	83.0	48.0	2479 14.100	2471 14.100	20.000		20.0	153.0	101.0	50.0	2479 20.000	2471 20.000
14.200		16.0	133.0	83.0	48.0	2479 14.200	2471 14.200								
14.290	9/16	16.0	133.0	83.0	48.0	2479 14.290	2471 14.290								
14.400		16.0	133.0	83.0	48.0	2479 14.400									
14.500		16.0	133.0	83.0	48.0	2479 14.500	2471 14.500								
14.600		16.0	133.0	83.0	48.0	2479 14.600									
14.680	37/64	16.0	133.0	83.0	48.0	2479 14.680									
14.700		16.0	133.0	83.0	48.0	2479 14.700	2471 14.700								
14.800		16.0	133.0	83.0	48.0	2479 14.800									



Ratio drills with coolant ducts

Article no. 5650



Cutting data page 401

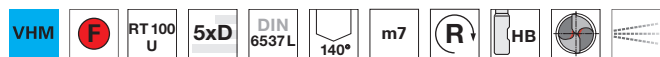

P	M	K	N	S	H
●	○	●	○	○	○

Web thinning ≥ Ø 3.000 • facet point grind • main cutting edge form straight • optimised cutting edge geometry

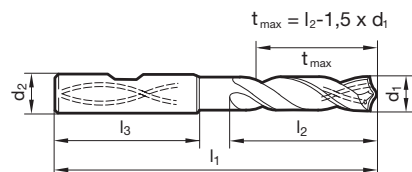

Article no. 5650

Article no. 5650

d1 mm	inch	d2 h6 mm	l1 mm	l2 mm	l3 mm	Order no.	d1 mm	inch	d2 h6 mm	l1 mm	l2 mm	l3 mm	Order no.
3.000		6.0	66.0	28.0	36.0	5650 3.000	8.000		8.0	91.0	53.0	36.0	5650 8.000
3.100		6.0	66.0	28.0	36.0	5650 3.100	8.100		10.0	103.0	61.0	40.0	5650 8.100
3.170	1/8	6.0	66.0	28.0	36.0	5650 3.170	8.200		10.0	103.0	61.0	40.0	5650 8.200
3.200		6.0	66.0	28.0	36.0	5650 3.200	8.300		10.0	103.0	61.0	40.0	5650 8.300
3.250		6.0	66.0	28.0	36.0	5650 3.250	8.330	21/64	10.0	103.0	61.0	40.0	5650 8.330
3.300		6.0	66.0	28.0	36.0	5650 3.300	8.400		10.0	103.0	61.0	40.0	5650 8.400
3.400		6.0	66.0	28.0	36.0	5650 3.400	8.500		10.0	103.0	61.0	40.0	5650 8.500
3.500		6.0	66.0	28.0	36.0	5650 3.500	8.600		10.0	103.0	61.0	40.0	5650 8.600
3.570	9/64	6.0	66.0	28.0	36.0	5650 3.570	8.700		10.0	103.0	61.0	40.0	5650 8.700
3.600		6.0	66.0	28.0	36.0	5650 3.600	8.730	11/32	10.0	103.0	61.0	40.0	5650 8.730
3.700		6.0	66.0	28.0	36.0	5650 3.700	8.800		10.0	103.0	61.0	40.0	5650 8.800
3.800		6.0	74.0	36.0	36.0	5650 3.800	8.900		10.0	103.0	61.0	40.0	5650 8.900
3.900		6.0	74.0	36.0	36.0	5650 3.900	9.000		10.0	103.0	61.0	40.0	5650 9.000
3.970	5/32	6.0	74.0	36.0	36.0	5650 3.970	9.100		10.0	103.0	61.0	40.0	5650 9.100
4.000		6.0	74.0	36.0	36.0	5650 4.000	9.130	23/64	10.0	103.0	61.0	40.0	5650 9.130
4.100		6.0	74.0	36.0	36.0	5650 4.100	9.200		10.0	103.0	61.0	40.0	5650 9.200
4.200		6.0	74.0	36.0	36.0	5650 4.200	9.250		10.0	103.0	61.0	40.0	5650 9.250
4.300		6.0	74.0	36.0	36.0	5650 4.300	9.300		10.0	103.0	61.0	40.0	5650 9.300
4.370	11/64	6.0	74.0	36.0	36.0	5650 4.370	9.400		10.0	103.0	61.0	40.0	5650 9.400
4.400		6.0	74.0	36.0	36.0	5650 4.400	9.500		10.0	103.0	61.0	40.0	5650 9.500
4.500		6.0	74.0	36.0	36.0	5650 4.500	9.520	3/8	10.0	103.0	61.0	40.0	5650 9.520
4.600		6.0	74.0	36.0	36.0	5650 4.600	9.600		10.0	103.0	61.0	40.0	5650 9.600
4.650		6.0	74.0	36.0	36.0	5650 4.650	9.700		10.0	103.0	61.0	40.0	5650 9.700
4.700		6.0	74.0	36.0	36.0	5650 4.700	9.800		10.0	103.0	61.0	40.0	5650 9.800
4.760	3/16	6.0	82.0	44.0	36.0	5650 4.760	9.900		10.0	103.0	61.0	40.0	5650 9.900
4.800		6.0	82.0	44.0	36.0	5650 4.800	9.920	25/64	10.0	103.0	61.0	40.0	5650 9.920
4.900		6.0	82.0	44.0	36.0	5650 4.900	10.000		10.0	103.0	61.0	40.0	5650 10.000
5.000		6.0	82.0	44.0	36.0	5650 5.000	10.100		12.0	118.0	71.0	45.0	5650 10.100
5.100		6.0	82.0	44.0	36.0	5650 5.100	10.200		12.0	118.0	71.0	45.0	5650 10.200
5.160	13/64	6.0	82.0	44.0	36.0	5650 5.160	10.300		12.0	118.0	71.0	45.0	5650 10.300
5.200		6.0	82.0	44.0	36.0	5650 5.200	10.320	13/32	12.0	118.0	71.0	45.0	5650 10.320
5.300		6.0	82.0	44.0	36.0	5650 5.300	10.400		12.0	118.0	71.0	45.0	5650 10.400
5.400		6.0	82.0	44.0	36.0	5650 5.400	10.500		12.0	118.0	71.0	45.0	5650 10.500
5.500		6.0	82.0	44.0	36.0	5650 5.500	10.600		12.0	118.0	71.0	45.0	5650 10.600
5.550		6.0	82.0	44.0	36.0	5650 5.550	10.700		12.0	118.0	71.0	45.0	5650 10.700
5.560	7/32	6.0	82.0	44.0	36.0	5650 5.560	10.800		12.0	118.0	71.0	45.0	5650 10.800
5.600		6.0	82.0	44.0	36.0	5650 5.600	10.900		12.0	118.0	71.0	45.0	5650 10.900
5.700		6.0	82.0	44.0	36.0	5650 5.700	11.000		12.0	118.0	71.0	45.0	5650 11.000
5.800		6.0	82.0	44.0	36.0	5650 5.800	11.100		12.0	118.0	71.0	45.0	5650 11.100
5.900		6.0	82.0	44.0	36.0	5650 5.900	11.110	7/16	12.0	118.0	71.0	45.0	5650 11.110
5.950	15/64	6.0	82.0	44.0	36.0	5650 5.950	11.200		12.0	118.0	71.0	45.0	5650 11.200
6.000		6.0	82.0	44.0	36.0	5650 6.000	11.300		12.0	118.0	71.0	45.0	5650 11.300
6.100		8.0	91.0	53.0	36.0	5650 6.100	11.400		12.0	118.0	71.0	45.0	5650 11.400
6.200		8.0	91.0	53.0	36.0	5650 6.200	11.500		12.0	118.0	71.0	45.0	5650 11.500
6.300		8.0	91.0	53.0	36.0	5650 6.300	11.600		12.0	118.0	71.0	45.0	5650 11.600
6.350	1/4	8.0	91.0	53.0	36.0	5650 6.350	11.700		12.0	118.0	71.0	45.0	5650 11.700
6.400		8.0	91.0	53.0	36.0	5650 6.400	11.800		12.0	118.0	71.0	45.0	5650 11.800
6.500		8.0	91.0	53.0	36.0	5650 6.500	11.900		12.0	118.0	71.0	45.0	5650 11.900
6.600		8.0	91.0	53.0	36.0	5650 6.600	11.910	15/32	12.0	118.0	71.0	45.0	5650 11.910
6.700		8.0	91.0	53.0	36.0	5650 6.700	12.000		12.0	118.0	71.0	45.0	5650 12.000
6.750	17/64	8.0	91.0	53.0	36.0	5650 6.750	12.200		14.0	124.0	77.0	45.0	5650 12.200
6.800		8.0	91.0	53.0	36.0	5650 6.800	12.500		14.0	124.0	77.0	45.0	5650 12.500
6.900		8.0	91.0	53.0	36.0	5650 6.900	12.700	1/2	14.0	124.0	77.0	45.0	5650 12.700
7.000		8.0	91.0	53.0	36.0	5650 7.000	13.000		14.0	124.0	77.0	45.0	5650 13.000
7.100		8.0	91.0	53.0	36.0	5650 7.100	13.500		14.0	124.0	77.0	45.0	5650 13.500
7.140	9/32	8.0	91.0	53.0	36.0	5650 7.140	13.700		14.0	124.0	77.0	45.0	5650 13.700
7.200		8.0	91.0	53.0	36.0	5650 7.200	14.000		14.0	124.0	77.0	45.0	5650 14.000
7.300		8.0	91.0	53.0	36.0	5650 7.300	14.200		16.0	133.0	83.0	48.0	5650 14.200
7.400		8.0	91.0	53.0	36.0	5650 7.400	14.290	9/16	16.0	133.0	83.0	48.0	5650 14.290
7.500		8.0	91.0	53.0	36.0	5650 7.500	14.500		16.0	133.0	83.0	48.0	5650 14.500
7.540	19/64	8.0	91.0	53.0	36.0	5650 7.540	14.700		16.0	133.0	83.0	48.0	5650 14.700
7.600		8.0	91.0	53.0	36.0	5650 7.600	15.000		16.0	133.0	83.0	48.0	5650 15.000
7.700		8.0	91.0	53.0	36.0	5650 7.700	15.200		16.0	133.0	83.0	48.0	5650 15.200
7.800		8.0	91.0	53.0	36.0	5650 7.800	15.500		16.0	133.0	83.0	48.0	5650 15.500
7.900		8.0	91.0	53.0	36.0	5650 7.900	15.700		16.0	133.0	83.0	48.0	5650 15.700
7.940	5/16	8.0	91.0	53.0	36.0	5650 7.940	16.000		16.0	133.0	83.0	48.0	5650 16.000



Solid carbide drills

						Article no.	5650
d1 mm	inch	d2 h6 mm	l1 mm	l2 mm	l3 mm	Order no.	
16.500		18.0	143.0	93.0	48.0	5650	16.500
17.000		18.0	143.0	93.0	48.0	5650	17.000
17.500		18.0	143.0	93.0	48.0	5650	17.500
18.000		18.0	143.0	93.0	48.0	5650	18.000
18.500		20.0	153.0	101.0	50.0	5650	18.500
19.000		20.0	153.0	101.0	50.0	5650	19.000

						Article no.	5650
d1 mm	inch	d2 h6 mm	l1 mm	l2 mm	l3 mm	Order no.	
19.050	3/4	20.0	153.0	101.0	50.0	5650	19.050
19.500		20.0	153.0	101.0	50.0	5650	19.500
20.000		20.0	153.0	101.0	50.0	5650	20.000



Ratio drills with coolant ducts

Article no. 8521



Cutting data page 404

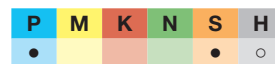
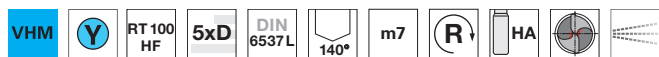

Web thinning $\geq \varnothing 3.000$ • relieved cone • main cutting edge is slightly concave • optimised cutting edge geometry • double margin

Ratio drills with coolant ducts

Article no. 8621



Cutting data page 404

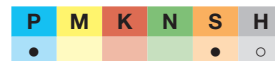

Web thinning $\geq \varnothing 3.000$ • relieved cone • main cutting edge is slightly concave • optimised cutting edge geometry • double margin

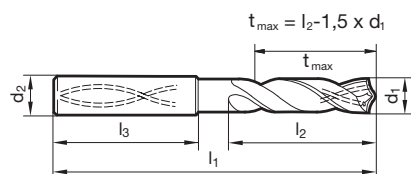

Article no.

8521 8621

Article no.

8521 8621

d1 mm	inch	d2 h6 mm	l1 mm	l2 mm	l3 mm	Order no.		d1 mm	inch	d2 h6 mm	l1 mm	l2 mm	l3 mm	Order no.	
3.000		6.0	66.0	28.0	36.0	8521 3.000	8621 3.000	7.100		8.0	91.0	53.0	36.0	8521 7.100	8621 7.100
3.100		6.0	66.0	28.0	36.0	8521 3.100	8621 3.100	7.140	9/32	8.0	91.0	53.0	36.0	8521 7.140	8621 7.140
3.170	1/8	6.0	66.0	28.0	36.0	8521 3.170	8621 3.170	7.200		8.0	91.0	53.0	36.0	8521 7.200	8621 7.200
3.200		6.0	66.0	28.0	36.0	8521 3.200	8621 3.200	7.300		8.0	91.0	53.0	36.0	8521 7.300	8621 7.300
3.250		6.0	66.0	28.0	36.0	8521 3.250	8621 3.250	7.400		8.0	91.0	53.0	36.0	8521 7.400	8621 7.400
3.300		6.0	66.0	28.0	36.0	8521 3.300	8621 3.300	7.500		8.0	91.0	53.0	36.0	8521 7.500	8621 7.500
3.400		6.0	66.0	28.0	36.0	8521 3.400	8621 3.400	7.540	19/64	8.0	91.0	53.0	36.0	8521 7.540	8621 7.540
3.500		6.0	66.0	28.0	36.0	8521 3.500	8621 3.500	7.600		8.0	91.0	53.0	36.0	8521 7.600	8621 7.600
3.570	9/64	6.0	66.0	28.0	36.0	8521 3.570	8621 3.570	7.700		8.0	91.0	53.0	36.0	8521 7.700	8621 7.700
3.600		6.0	66.0	28.0	36.0	8521 3.600	8621 3.600	7.800		8.0	91.0	53.0	36.0	8521 7.800	8621 7.800
3.700		6.0	66.0	28.0	36.0	8521 3.700	8621 3.700	7.900		8.0	91.0	53.0	36.0	8521 7.900	8621 7.900
3.800		6.0	74.0	36.0	36.0	8521 3.800	8621 3.800	7.940	5/16	8.0	91.0	53.0	36.0	8521 7.940	8621 7.940
3.900		6.0	74.0	36.0	36.0	8521 3.900	8621 3.900	8.000		8.0	91.0	53.0	36.0	8521 8.000	8621 8.000
3.970	5/32	6.0	74.0	36.0	36.0	8521 3.970	8621 3.970	8.100		10.0	103.0	61.0	40.0	8521 8.100	8621 8.100
4.000		6.0	74.0	36.0	36.0	8521 4.000	8621 4.000	8.200		10.0	103.0	61.0	40.0	8521 8.200	8621 8.200
4.100		6.0	74.0	36.0	36.0	8521 4.100	8621 4.100	8.300		10.0	103.0	61.0	40.0	8521 8.300	8621 8.300
4.200		6.0	74.0	36.0	36.0	8521 4.200	8621 4.200	8.330	21/64	10.0	103.0	61.0	40.0	8521 8.330	8621 8.330
4.300		6.0	74.0	36.0	36.0	8521 4.300	8621 4.300	8.400		10.0	103.0	61.0	40.0	8521 8.400	8621 8.400
4.370	11/64	6.0	74.0	36.0	36.0	8521 4.370	8621 4.370	8.500		10.0	103.0	61.0	40.0	8521 8.500	8621 8.500
4.400		6.0	74.0	36.0	36.0	8521 4.400	8621 4.400	8.600		10.0	103.0	61.0	40.0	8521 8.600	8621 8.600
4.500		6.0	74.0	36.0	36.0	8521 4.500	8621 4.500	8.700		10.0	103.0	61.0	40.0	8521 8.700	8621 8.700
4.600		6.0	74.0	36.0	36.0	8521 4.600	8621 4.600	8.730	11/32	10.0	103.0	61.0	40.0	8521 8.730	8621 8.730
4.650		6.0	74.0	36.0	36.0	8521 4.650	8621 4.650	8.800		10.0	103.0	61.0	40.0	8521 8.800	8621 8.800
4.700		6.0	74.0	36.0	36.0	8521 4.700	8621 4.700	8.900		10.0	103.0	61.0	40.0	8521 8.900	8621 8.900
4.760	3/16	6.0	82.0	44.0	36.0	8521 4.760	8621 4.760	9.000		10.0	103.0	61.0	40.0	8521 9.000	8621 9.000
4.800		6.0	82.0	44.0	36.0	8521 4.800	8621 4.800	9.100		10.0	103.0	61.0	40.0	8521 9.100	8621 9.100
4.900		6.0	82.0	44.0	36.0	8521 4.900	8621 4.900	9.130	23/64	10.0	103.0	61.0	40.0	8521 9.130	8621 9.130
5.000		6.0	82.0	44.0	36.0	8521 5.000	8621 5.000	9.200		10.0	103.0	61.0	40.0	8521 9.200	8621 9.200
5.100		6.0	82.0	44.0	36.0	8521 5.100	8621 5.100	9.250		10.0	103.0	61.0	40.0	8521 9.250	8621 9.250
5.160	13/64	6.0	82.0	44.0	36.0	8521 5.160	8621 5.160	9.300		10.0	103.0	61.0	40.0	8521 9.300	8621 9.300
5.200		6.0	82.0	44.0	36.0	8521 5.200	8621 5.200	9.400		10.0	103.0	61.0	40.0	8521 9.400	8621 9.400
5.300		6.0	82.0	44.0	36.0	8521 5.300	8621 5.300	9.500		10.0	103.0	61.0	40.0	8521 9.500	8621 9.500
5.400		6.0	82.0	44.0	36.0	8521 5.400	8621 5.400	9.520	3/8	10.0	103.0	61.0	40.0	8521 9.520	8621 9.520
5.500		6.0	82.0	44.0	36.0	8521 5.500	8621 5.500	9.600		10.0	103.0	61.0	40.0	8521 9.600	8621 9.600
5.550		6.0	82.0	44.0	36.0	8521 5.550	8621 5.550	9.700		10.0	103.0	61.0	40.0	8521 9.700	8621 9.700
5.560	7/32	6.0	82.0	44.0	36.0	8521 5.560	8621 5.560	9.800		10.0	103.0	61.0	40.0	8521 9.800	8621 9.800
5.600		6.0	82.0	44.0	36.0	8521 5.600	8621 5.600	9.900		10.0	103.0	61.0	40.0	8521 9.900	8621 9.900
5.700		6.0	82.0	44.0	36.0	8521 5.700	8621 5.700	9.920	25/64	10.0	103.0	61.0	40.0	8521 9.920	8621 9.920
5.800		6.0	82.0	44.0	36.0	8521 5.800	8621 5.800	10.000		10.0	103.0	61.0	40.0	8521 10.000	8621 10.000
5.900		6.0	82.0	44.0	36.0	8521 5.900	8621 5.900	10.100		12.0	118.0	71.0	45.0	8521 10.100	8621 10.100
5.950	15/64	6.0	82.0	44.0	36.0	8521 5.950	8621 5.950	10.200		12.0	118.0	71.0	45.0	8521 10.200	8621 10.200
6.000		6.0	82.0	44.0	36.0	8521 6.000	8621 6.000	10.300		12.0	118.0	71.0	45.0	8521 10.300	8621 10.300
6.100		8.0	91.0	53.0	36.0	8521 6.100	8621 6.100	10.320	13/32	12.0	118.0	71.0	45.0	8521 10.320	8621 10.320
6.200		8.0	91.0	53.0	36.0	8521 6.200	8621 6.200	10.400		12.0	118.0	71.0	45.0	8521 10.400	8621 10.400
6.300		8.0	91.0	53.0	36.0	8521 6.300	8621 6.300	10.500		12.0	118.0	71.0	45.0	8521 10.500	8621 10.500
6.350	1/4	8.0	91.0	53.0	36.0	8521 6.350	8621 6.350	10.600		12.0	118.0	71.0	45.0	8521 10.600	8621 10.600
6.400		8.0	91.0	53.0	36.0	8521 6.400	8621 6.400	10.700		12.0	118.0	71.0	45.0	8521 10.700	8621 10.700
6.500		8.0	91.0	53.0	36.0	8521 6.500	8621 6.500	10.720	27/64	12.0	118.0	71.0	45.0	8521 10.720	8621 10.720
6.600		8.0	91.0	53.0	36.0	8521 6.600	8621 6.600	10.800		12.0	118.0	71.0	45.0	8521 10.800	8621 10.800
6.700		8.0	91.0	53.0	36.0	8521 6.700	8621 6.700	10.900		12.0	118.0	71.0	45.0	8521 10.900	8621 10.900
6.750	17/64	8.0	91.0	53.0	36.0	8521 6.750	8621 6.750	11.000		12.0	118.0	71.0	45.0	8521 11.000	8621 11.000
6.800		8.0	91.0	53.0	36.0	8521 6.800	8621 6.800	11.100		12.0	118.0	71.0	45.0	8521 11.100	8621 11.100
6.900		8.0	91.0	53.0	36.0	8521 6.900	8621 6.900	11.110	7/16	12.0	118.0	71.0	45.0	8521 11.110	8621 11.110
7.000		8.0	91.0	53.0	36.0	8521 7.000	8621 7.000	11.200		12.0	118.0	71.0	45.0	8521 11.200	8621 11.200



Solid carbide drills

Article no.						8521	8621	Article no.						8521	8621
d1 mm	inch	d2 h6 mm	l1 mm	l2 mm	l3 mm	Order no.		d1 mm	inch	d2 h6 mm	l1 mm	l2 mm	l3 mm	Order no.	
11.300		12.0	118.0	71.0	45.0	8521 11.300	8621 11.300	14.500		16.0	133.0	83.0	48.0	8521 14.500	8621 14.500
11.400		12.0	118.0	71.0	45.0	8521 11.400	8621 11.400	14.700		16.0	133.0	83.0	48.0	8521 14.700	8621 14.700
11.500		12.0	118.0	71.0	45.0	8521 11.500	8621 11.500	15.000		16.0	133.0	83.0	48.0	8521 15.000	8621 15.000
11.510	29/64	12.0	118.0	71.0	45.0	8521 11.510		15.200		16.0	133.0	83.0	48.0	8521 15.200	8621 15.200
11.600		12.0	118.0	71.0	45.0	8521 11.600	8621 11.600	15.300		16.0	133.0	83.0	48.0	8521 15.300	8621 15.300
11.700		12.0	118.0	71.0	45.0	8521 11.700	8621 11.700	15.500		16.0	133.0	83.0	48.0	8521 15.500	8621 15.500
11.800		12.0	118.0	71.0	45.0	8521 11.800	8621 11.800	15.700		16.0	133.0	83.0	48.0	8521 15.700	8621 15.700
11.900		12.0	118.0	71.0	45.0	8521 11.900	8621 11.900	15.870	5/8	16.0	133.0	83.0	48.0	8521 15.870	
11.910	15/32	12.0	118.0	71.0	45.0	8521 11.910	8621 11.910	16.000		16.0	133.0	83.0	48.0	8521 16.000	8621 16.000
12.000		12.0	118.0	71.0	45.0	8521 12.000	8621 12.000	16.300		18.0	143.0	93.0	48.0	8521 16.300	8621 16.300
12.200		14.0	124.0	77.0	45.0	8521 12.200	8621 12.200	16.500		18.0	143.0	93.0	48.0	8521 16.500	8621 16.500
12.300	31/64	14.0	124.0	77.0	45.0	8521 12.300		16.900		18.0	143.0	93.0	48.0	8521 16.900	8621 16.900
12.500		14.0	124.0	77.0	45.0	8521 12.500	8621 12.500	17.000		18.0	143.0	93.0	48.0	8521 17.000	8621 17.000
12.700	1/2	14.0	124.0	77.0	45.0	8521 12.700	8621 12.700	17.300		18.0	143.0	93.0	48.0	8521 17.300	8621 17.300
12.800		14.0	124.0	77.0	45.0	8521 12.800	8621 12.800	17.500		18.0	143.0	93.0	48.0	8521 17.500	8621 17.500
13.000		14.0	124.0	77.0	45.0	8521 13.000	8621 13.000	18.000		18.0	143.0	93.0	48.0	8521 18.000	8621 18.000
13.300		14.0	124.0	77.0	45.0	8521 13.300	8621 13.300	18.500		20.0	153.0	101.0	50.0	8521 18.500	8621 18.500
13.490	17/32	14.0	124.0	77.0	45.0	8521 13.490		18.900		20.0	153.0	101.0	50.0	8521 18.900	8621 18.900
13.500		14.0	124.0	77.0	45.0	8521 13.500	8621 13.500	19.000		20.0	153.0	101.0	50.0	8521 19.000	8621 19.000
13.700		14.0	124.0	77.0	45.0	8521 13.700	8621 13.700	19.050	3/4	20.0	153.0	101.0	50.0	8521 19.050	8621 19.050
14.000		14.0	124.0	77.0	45.0	8521 14.000	8621 14.000	19.300		20.0	153.0	101.0	50.0	8521 19.300	8621 19.300
14.200		16.0	133.0	83.0	48.0	8521 14.200	8621 14.200	19.500		20.0	153.0	101.0	50.0	8521 19.500	8621 19.500
14.290	9/16	16.0	133.0	83.0	48.0	8521 14.290	8621 14.290	20.000		20.0	153.0	101.0	50.0	8521 20.000	8621 20.000
14.300		16.0	133.0	83.0	48.0	8521 14.300	8621 14.300								



Ratio drills with coolant ducts

Article no. 8511



Cutting data page 408

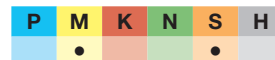
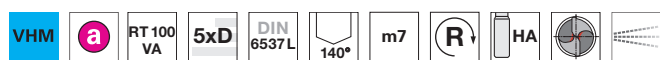

Web thinning $\geq \varnothing 3.000$ • facet point grind • main cutting edge form straight • optimised cutting edge geometry

Ratio drills with coolant ducts

Article no. 8611



Cutting data page 408

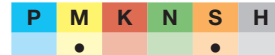
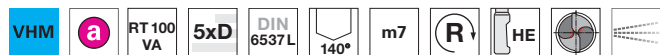

Web thinning $\geq \varnothing 3.000$ • facet point grind • main cutting edge form straight • optimised cutting edge geometry

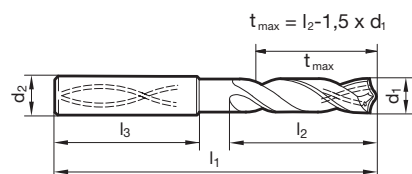

Article no.

8511 8611

Article no.

8511 8611

d1 mm	inch	d2 h6 mm	l1 mm	l2 mm	l3 mm	Order no.		d1 mm	inch	d2 h6 mm	l1 mm	l2 mm	l3 mm	Order no.	
3.000		6.0	66.0	28.0	36.0	8511 3.000	8611 3.000	7.100		8.0	91.0	53.0	36.0	8511 7.100	8611 7.100
3.100		6.0	66.0	28.0	36.0	8511 3.100	8611 3.100	7.140	9/32	8.0	91.0	53.0	36.0	8511 7.140	8611 7.140
3.170	1/8	6.0	66.0	28.0	36.0	8511 3.170	8611 3.170	7.200		8.0	91.0	53.0	36.0	8511 7.200	8611 7.200
3.200		6.0	66.0	28.0	36.0	8511 3.200	8611 3.200	7.300		8.0	91.0	53.0	36.0	8511 7.300	8611 7.300
3.250		6.0	66.0	28.0	36.0	8511 3.250	8611 3.250	7.400		8.0	91.0	53.0	36.0	8511 7.400	8611 7.400
3.300		6.0	66.0	28.0	36.0	8511 3.300	8611 3.300	7.500		8.0	91.0	53.0	36.0	8511 7.500	8611 7.500
3.400		6.0	66.0	28.0	36.0	8511 3.400	8611 3.400	7.540	19/64	8.0	91.0	53.0	36.0	8511 7.540	8611 7.540
3.500		6.0	66.0	28.0	36.0	8511 3.500	8611 3.500	7.600		8.0	91.0	53.0	36.0	8511 7.600	8611 7.600
3.570	9/64	6.0	66.0	28.0	36.0	8511 3.570	8611 3.570	7.700		8.0	91.0	53.0	36.0	8511 7.700	8611 7.700
3.600		6.0	66.0	28.0	36.0	8511 3.600	8611 3.600	7.800		8.0	91.0	53.0	36.0	8511 7.800	8611 7.800
3.700		6.0	66.0	28.0	36.0	8511 3.700	8611 3.700	7.900		8.0	91.0	53.0	36.0	8511 7.900	8611 7.900
3.800		6.0	74.0	36.0	36.0	8511 3.800	8611 3.800	7.940	5/16	8.0	91.0	53.0	36.0	8511 7.940	8611 7.940
3.900		6.0	74.0	36.0	36.0	8511 3.900	8611 3.900	8.000		8.0	91.0	53.0	36.0	8511 8.000	8611 8.000
3.970	5/32	6.0	74.0	36.0	36.0	8511 3.970	8611 3.970	8.100		10.0	103.0	61.0	40.0	8511 8.100	8611 8.100
4.000		6.0	74.0	36.0	36.0	8511 4.000	8611 4.000	8.200		10.0	103.0	61.0	40.0	8511 8.200	8611 8.200
4.100		6.0	74.0	36.0	36.0	8511 4.100	8611 4.100	8.300		10.0	103.0	61.0	40.0	8511 8.300	8611 8.300
4.200		6.0	74.0	36.0	36.0	8511 4.200	8611 4.200	8.330	21/64	10.0	103.0	61.0	40.0	8511 8.330	8611 8.330
4.300		6.0	74.0	36.0	36.0	8511 4.300	8611 4.300	8.400		10.0	103.0	61.0	40.0	8511 8.400	8611 8.400
4.370	11/64	6.0	74.0	36.0	36.0	8511 4.370	8611 4.370	8.500		10.0	103.0	61.0	40.0	8511 8.500	8611 8.500
4.400		6.0	74.0	36.0	36.0	8511 4.400	8611 4.400	8.600		10.0	103.0	61.0	40.0	8511 8.600	8611 8.600
4.500		6.0	74.0	36.0	36.0	8511 4.500	8611 4.500	8.700		10.0	103.0	61.0	40.0	8511 8.700	8611 8.700
4.600		6.0	74.0	36.0	36.0	8511 4.600	8611 4.600	8.730	11/32	10.0	103.0	61.0	40.0	8511 8.730	8611 8.730
4.650		6.0	74.0	36.0	36.0	8511 4.650	8611 4.650	8.800		10.0	103.0	61.0	40.0	8511 8.800	8611 8.800
4.700		6.0	74.0	36.0	36.0	8511 4.700	8611 4.700	8.900		10.0	103.0	61.0	40.0	8511 8.900	8611 8.900
4.760	3/16	6.0	82.0	44.0	36.0	8511 4.760	8611 4.760	9.000		10.0	103.0	61.0	40.0	8511 9.000	8611 9.000
4.800		6.0	82.0	44.0	36.0	8511 4.800	8611 4.800	9.100		10.0	103.0	61.0	40.0	8511 9.100	8611 9.100
4.900		6.0	82.0	44.0	36.0	8511 4.900	8611 4.900	9.130	23/64	10.0	103.0	61.0	40.0	8511 9.130	8611 9.130
5.000		6.0	82.0	44.0	36.0	8511 5.000	8611 5.000	9.200		10.0	103.0	61.0	40.0	8511 9.200	8611 9.200
5.100		6.0	82.0	44.0	36.0	8511 5.100	8611 5.100	9.250		10.0	103.0	61.0	40.0	8511 9.250	8611 9.250
5.160	13/64	6.0	82.0	44.0	36.0	8511 5.160	8611 5.160	9.300		10.0	103.0	61.0	40.0	8511 9.300	8611 9.300
5.200		6.0	82.0	44.0	36.0	8511 5.200	8611 5.200	9.400		10.0	103.0	61.0	40.0	8511 9.400	8611 9.400
5.300		6.0	82.0	44.0	36.0	8511 5.300	8611 5.300	9.500		10.0	103.0	61.0	40.0	8511 9.500	8611 9.500
5.400		6.0	82.0	44.0	36.0	8511 5.400	8611 5.400	9.520	3/8	10.0	103.0	61.0	40.0	8511 9.520	8611 9.520
5.500		6.0	82.0	44.0	36.0	8511 5.500	8611 5.500	9.600		10.0	103.0	61.0	40.0	8511 9.600	8611 9.600
5.550		6.0	82.0	44.0	36.0	8511 5.550	8611 5.550	9.700		10.0	103.0	61.0	40.0	8511 9.700	8611 9.700
5.560	7/32	6.0	82.0	44.0	36.0	8511 5.560	8611 5.560	9.800		10.0	103.0	61.0	40.0	8511 9.800	8611 9.800
5.600		6.0	82.0	44.0	36.0	8511 5.600	8611 5.600	9.900		10.0	103.0	61.0	40.0	8511 9.900	8611 9.900
5.700		6.0	82.0	44.0	36.0	8511 5.700	8611 5.700	9.920	25/64	10.0	103.0	61.0	40.0	8511 9.920	8611 9.920
5.800		6.0	82.0	44.0	36.0	8511 5.800	8611 5.800	10.000		10.0	103.0	61.0	40.0	8511 10.000	8611 10.000
5.900		6.0	82.0	44.0	36.0	8511 5.900	8611 5.900	10.100		12.0	118.0	71.0	45.0	8511 10.100	8611 10.100
5.950	15/64	6.0	82.0	44.0	36.0	8511 5.950	8611 5.950	10.200		12.0	118.0	71.0	45.0	8511 10.200	8611 10.200
6.000		6.0	82.0	44.0	36.0	8511 6.000	8611 6.000	10.300		12.0	118.0	71.0	45.0	8511 10.300	8611 10.300
6.100		8.0	91.0	53.0	36.0	8511 6.100	8611 6.100	10.320	13/32	12.0	118.0	71.0	45.0	8511 10.320	8611 10.320
6.200		8.0	91.0	53.0	36.0	8511 6.200	8611 6.200	10.400		12.0	118.0	71.0	45.0	8511 10.400	8611 10.400
6.300		8.0	91.0	53.0	36.0	8511 6.300	8611 6.300	10.500		12.0	118.0	71.0	45.0	8511 10.500	8611 10.500
6.350	1/4	8.0	91.0	53.0	36.0	8511 6.350	8611 6.350	10.600		12.0	118.0	71.0	45.0	8511 10.600	8611 10.600
6.400		8.0	91.0	53.0	36.0	8511 6.400	8611 6.400	10.700		12.0	118.0	71.0	45.0	8511 10.700	8611 10.700
6.500		8.0	91.0	53.0	36.0	8511 6.500	8611 6.500	10.800		12.0	118.0	71.0	45.0	8511 10.800	8611 10.800
6.600		8.0	91.0	53.0	36.0	8511 6.600	8611 6.600	10.900		12.0	118.0	71.0	45.0	8511 10.900	8611 10.900
6.700		8.0	91.0	53.0	36.0	8511 6.700	8611 6.700	11.000		12.0	118.0	71.0	45.0	8511 11.000	8611 11.000
6.750	17/64	8.0	91.0	53.0	36.0	8511 6.750	8611 6.750	11.100		12.0	118.0	71.0	45.0	8511 11.100	8611 11.100
6.800		8.0	91.0	53.0	36.0	8511 6.800	8611 6.800	11.110	7/16	12.0	118.0	71.0	45.0	8511 11.110	8611 11.110
6.900		8.0	91.0	53.0	36.0	8511 6.900	8611 6.900	11.200		12.0	118.0	71.0	45.0	8511 11.200	8611 11.200
7.000		8.0	91.0	53.0	36.0	8511 7.000	8611 7.000	11.300		12.0	118.0	71.0	45.0	8511 11.300	8611 11.300



Solid carbide drills

Article no.						8511	8611	Article no.						8511	8611
d1 mm	inch	d2 h6 mm	l1 mm	l2 mm	l3 mm	Order no.		d1 mm	inch	d2 h6 mm	l1 mm	l2 mm	l3 mm	Order no.	
11.400		12.0	118.0	71.0	45.0	8511 11.400	8611 11.400	15.300		16.0	133.0	83.0	48.0	8511 15.300	8611 15.300
11.500		12.0	118.0	71.0	45.0	8511 11.500	8611 11.500	15.500		16.0	133.0	83.0	48.0	8511 15.500	8611 15.500
11.600		12.0	118.0	71.0	45.0	8511 11.600	8611 11.600	15.700		16.0	133.0	83.0	48.0	8511 15.700	8611 15.700
11.700		12.0	118.0	71.0	45.0	8511 11.700	8611 11.700	16.000		16.0	133.0	83.0	48.0	8511 16.000	8611 16.000
11.800		12.0	118.0	71.0	45.0	8511 11.800	8611 11.800	16.300		18.0	143.0	93.0	48.0	8511 16.300	8611 16.300
11.900		12.0	118.0	71.0	45.0	8511 11.900	8611 11.900	16.500		18.0	143.0	93.0	48.0	8511 16.500	8611 16.500
11.910	15/32	12.0	118.0	71.0	45.0	8511 11.910	8611 11.910	16.900		18.0	143.0	93.0	48.0	8511 16.900	8611 16.900
12.000		12.0	118.0	71.0	45.0	8511 12.000	8611 12.000	17.000		18.0	143.0	93.0	48.0	8511 17.000	8611 17.000
12.200		14.0	124.0	77.0	45.0	8511 12.200	8611 12.200	17.300		18.0	143.0	93.0	48.0	8511 17.300	8611 17.300
12.500		14.0	124.0	77.0	45.0	8511 12.500	8611 12.500	17.500		18.0	143.0	93.0	48.0	8511 17.500	8611 17.500
12.700	1/2	14.0	124.0	77.0	45.0	8511 12.700	8611 12.700	18.000		18.0	143.0	93.0	48.0	8511 18.000	8611 18.000
12.800		14.0	124.0	77.0	45.0	8511 12.800	8611 12.800	18.500		20.0	153.0	101.0	50.0	8511 18.500	8611 18.500
13.000		14.0	124.0	77.0	45.0	8511 13.000	8611 13.000	18.900		20.0	153.0	101.0	50.0	8511 18.900	8611 18.900
13.300		14.0	124.0	77.0	45.0	8511 13.300	8611 13.300	19.000		20.0	153.0	101.0	50.0	8511 19.000	8611 19.000
13.500		14.0	124.0	77.0	45.0	8511 13.500	8611 13.500	19.050	3/4	20.0	153.0	101.0	50.0	8511 19.050	8611 19.050
13.700		14.0	124.0	77.0	45.0	8511 13.700	8611 13.700	19.300		20.0	153.0	101.0	50.0	8511 19.300	8611 19.300
14.000		14.0	124.0	77.0	45.0	8511 14.000	8611 14.000	19.500		20.0	153.0	101.0	50.0	8511 19.500	8611 19.500
14.200		16.0	133.0	83.0	48.0	8511 14.200	8611 14.200	20.000		20.0	153.0	101.0	50.0	8511 20.000	8611 20.000
14.290	9/16	16.0	133.0	83.0	48.0	8511 14.290	8611 14.290								
14.300		16.0	133.0	83.0	48.0	8511 14.300	8611 14.300								
14.500		16.0	133.0	83.0	48.0	8511 14.500	8611 14.500								
14.700		16.0	133.0	83.0	48.0	8511 14.700	8611 14.700								
15.000		16.0	133.0	83.0	48.0	8511 15.000	8611 15.000								
15.200		16.0	133.0	83.0	48.0	8511 15.200	8611 15.200								



Ratio drills with coolant ducts

Article no. 6025



Cutting data page 408

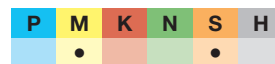
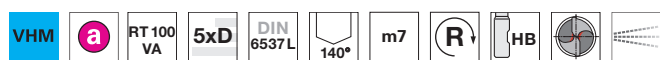

Web thinning $\geq \varnothing 3.000$ • facet point grind • main cutting edge form straight • optimised cutting edge geometry

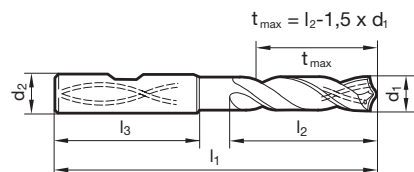

Article no.

6025

Article no.

6025

d1 mm	inch	d2 h6 mm	l1 mm	l2 mm	l3 mm	Order no.	d1 mm	inch	d2 h6 mm	l1 mm	l2 mm	l3 mm	Order no.
3.000		6.0	66.0	28.0	36.0	6025 3.000	8.000		8.0	91.0	53.0	36.0	6025 8.000
3.100		6.0	66.0	28.0	36.0	6025 3.100	8.100		10.0	103.0	61.0	40.0	6025 8.100
3.170	1/8	6.0	66.0	28.0	36.0	6025 3.170	8.200		10.0	103.0	61.0	40.0	6025 8.200
3.200		6.0	66.0	28.0	36.0	6025 3.200	8.300		10.0	103.0	61.0	40.0	6025 8.300
3.250		6.0	66.0	28.0	36.0	6025 3.250	8.330	21/64	10.0	103.0	61.0	40.0	6025 8.330
3.300		6.0	66.0	28.0	36.0	6025 3.300	8.400		10.0	103.0	61.0	40.0	6025 8.400
3.400		6.0	66.0	28.0	36.0	6025 3.400	8.500		10.0	103.0	61.0	40.0	6025 8.500
3.500		6.0	66.0	28.0	36.0	6025 3.500	8.600		10.0	103.0	61.0	40.0	6025 8.600
3.570	9/64	6.0	66.0	28.0	36.0	6025 3.570	8.700		10.0	103.0	61.0	40.0	6025 8.700
3.600		6.0	66.0	28.0	36.0	6025 3.600	8.730	11/32	10.0	103.0	61.0	40.0	6025 8.730
3.700		6.0	66.0	28.0	36.0	6025 3.700	8.800		10.0	103.0	61.0	40.0	6025 8.800
3.800		6.0	74.0	36.0	36.0	6025 3.800	8.900		10.0	103.0	61.0	40.0	6025 8.900
3.900		6.0	74.0	36.0	36.0	6025 3.900	9.000		10.0	103.0	61.0	40.0	6025 9.000
3.970	5/32	6.0	74.0	36.0	36.0	6025 3.970	9.100		10.0	103.0	61.0	40.0	6025 9.100
4.000		6.0	74.0	36.0	36.0	6025 4.000	9.130	23/64	10.0	103.0	61.0	40.0	6025 9.130
4.100		6.0	74.0	36.0	36.0	6025 4.100	9.200		10.0	103.0	61.0	40.0	6025 9.200
4.200		6.0	74.0	36.0	36.0	6025 4.200	9.250		10.0	103.0	61.0	40.0	6025 9.250
4.300		6.0	74.0	36.0	36.0	6025 4.300	9.300		10.0	103.0	61.0	40.0	6025 9.300
4.370	11/64	6.0	74.0	36.0	36.0	6025 4.370	9.400		10.0	103.0	61.0	40.0	6025 9.400
4.400		6.0	74.0	36.0	36.0	6025 4.400	9.500		10.0	103.0	61.0	40.0	6025 9.500
4.500		6.0	74.0	36.0	36.0	6025 4.500	9.520	3/8	10.0	103.0	61.0	40.0	6025 9.520
4.600		6.0	74.0	36.0	36.0	6025 4.600	9.600		10.0	103.0	61.0	40.0	6025 9.600
4.650		6.0	74.0	36.0	36.0	6025 4.650	9.700		10.0	103.0	61.0	40.0	6025 9.700
4.700		6.0	74.0	36.0	36.0	6025 4.700	9.800		10.0	103.0	61.0	40.0	6025 9.800
4.760	3/16	6.0	82.0	44.0	36.0	6025 4.760	9.900		10.0	103.0	61.0	40.0	6025 9.900
4.800		6.0	82.0	44.0	36.0	6025 4.800	9.920	25/64	10.0	103.0	61.0	40.0	6025 9.920
4.900		6.0	82.0	44.0	36.0	6025 4.900	10.000		10.0	103.0	61.0	40.0	6025 10.000
5.000		6.0	82.0	44.0	36.0	6025 5.000	10.100		12.0	118.0	71.0	45.0	6025 10.100
5.100		6.0	82.0	44.0	36.0	6025 5.100	10.200		12.0	118.0	71.0	45.0	6025 10.200
5.160	13/64	6.0	82.0	44.0	36.0	6025 5.160	10.300		12.0	118.0	71.0	45.0	6025 10.300
5.200		6.0	82.0	44.0	36.0	6025 5.200	10.320	13/32	12.0	118.0	71.0	45.0	6025 10.320
5.300		6.0	82.0	44.0	36.0	6025 5.300	10.400		12.0	118.0	71.0	45.0	6025 10.400
5.400		6.0	82.0	44.0	36.0	6025 5.400	10.500		12.0	118.0	71.0	45.0	6025 10.500
5.500		6.0	82.0	44.0	36.0	6025 5.500	10.600		12.0	118.0	71.0	45.0	6025 10.600
5.550		6.0	82.0	44.0	36.0	6025 5.550	10.700		12.0	118.0	71.0	45.0	6025 10.700
5.560	7/32	6.0	82.0	44.0	36.0	6025 5.560	10.800		12.0	118.0	71.0	45.0	6025 10.800
5.600		6.0	82.0	44.0	36.0	6025 5.600	10.900		12.0	118.0	71.0	45.0	6025 10.900
5.700		6.0	82.0	44.0	36.0	6025 5.700	11.000		12.0	118.0	71.0	45.0	6025 11.000
5.800		6.0	82.0	44.0	36.0	6025 5.800	11.100		12.0	118.0	71.0	45.0	6025 11.100
5.900		6.0	82.0	44.0	36.0	6025 5.900	11.110	7/16	12.0	118.0	71.0	45.0	6025 11.110
5.950	15/64	6.0	82.0	44.0	36.0	6025 5.950	11.200		12.0	118.0	71.0	45.0	6025 11.200
6.000		6.0	82.0	44.0	36.0	6025 6.000	11.300		12.0	118.0	71.0	45.0	6025 11.300
6.100		8.0	91.0	53.0	36.0	6025 6.100	11.400		12.0	118.0	71.0	45.0	6025 11.400
6.200		8.0	91.0	53.0	36.0	6025 6.200	11.500		12.0	118.0	71.0	45.0	6025 11.500
6.300		8.0	91.0	53.0	36.0	6025 6.300	11.600		12.0	118.0	71.0	45.0	6025 11.600
6.350	1/4	8.0	91.0	53.0	36.0	6025 6.350	11.700		12.0	118.0	71.0	45.0	6025 11.700
6.400		8.0	91.0	53.0	36.0	6025 6.400	11.800		12.0	118.0	71.0	45.0	6025 11.800
6.500		8.0	91.0	53.0	36.0	6025 6.500	11.900		12.0	118.0	71.0	45.0	6025 11.900
6.600		8.0	91.0	53.0	36.0	6025 6.600	11.910	15/32	12.0	118.0	71.0	45.0	6025 11.910
6.700		8.0	91.0	53.0	36.0	6025 6.700	12.000		12.0	118.0	71.0	45.0	6025 12.000
6.750	17/64	8.0	91.0	53.0	36.0	6025 6.750	12.200		14.0	124.0	77.0	45.0	6025 12.200
6.800		8.0	91.0	53.0	36.0	6025 6.800	12.500		14.0	124.0	77.0	45.0	6025 12.500
6.900		8.0	91.0	53.0	36.0	6025 6.900	12.700	1/2	14.0	124.0	77.0	45.0	6025 12.700
7.000		8.0	91.0	53.0	36.0	6025 7.000	13.000		14.0	124.0	77.0	45.0	6025 13.000
7.100		8.0	91.0	53.0	36.0	6025 7.100	13.500		14.0	124.0	77.0	45.0	6025 13.500
7.140	9/32	8.0	91.0	53.0	36.0	6025 7.140	13.700		14.0	124.0	77.0	45.0	6025 13.700
7.200		8.0	91.0	53.0	36.0	6025 7.200	14.000		14.0	124.0	77.0	45.0	6025 14.000
7.300		8.0	91.0	53.0	36.0	6025 7.300	14.200		16.0	133.0	83.0	48.0	6025 14.200
7.400		8.0	91.0	53.0	36.0	6025 7.400	14.290	9/16	16.0	133.0	83.0	48.0	6025 14.290
7.500		8.0	91.0	53.0	36.0	6025 7.500	14.500		16.0	133.0	83.0	48.0	6025 14.500
7.540	19/64	8.0	91.0	53.0	36.0	6025 7.540	14.700		16.0	133.0	83.0	48.0	6025 14.700
7.600		8.0	91.0	53.0	36.0	6025 7.600	15.000		16.0	133.0	83.0	48.0	6025 15.000
7.700		8.0	91.0	53.0	36.0	6025 7.700	15.200		16.0	133.0	83.0	48.0	6025 15.200
7.800		8.0	91.0	53.0	36.0	6025 7.800	15.500		16.0	133.0	83.0	48.0	6025 15.500
7.900		8.0	91.0	53.0	36.0	6025 7.900	15.700		16.0	133.0	83.0	48.0	6025 15.700
7.940	5/16	8.0	91.0	53.0	36.0	6025 7.940	16.000		16.0	133.0	83.0	48.0	6025 16.000



Solid carbide drills

						Article no.	6025
d1 mm	inch	d2 h6 mm	l1 mm	l2 mm	l3 mm	Order no.	
16.500		18.0	143.0	93.0	48.0	6025	16.500
17.000		18.0	143.0	93.0	48.0	6025	17.000
17.500		18.0	143.0	93.0	48.0	6025	17.500
18.000		18.0	143.0	93.0	48.0	6025	18.000
18.500		20.0	153.0	101.0	50.0	6025	18.500
19.000		20.0	153.0	101.0	50.0	6025	19.000

						Article no.	6025
d1 mm	inch	d2 h6 mm	l1 mm	l2 mm	l3 mm	Order no.	
19.500		20.0	153.0	101.0	50.0	6025	19.500
20.000		20.0	153.0	101.0	50.0	6025	20.000



Ratio drills with coolant ducts

Article no. 5498



Cutting data page 406

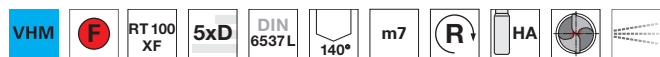

P	M	K	N	S	H
●	○	○	○	○	○

Web thinning ≥ Ø 3.000 • relieved cone • main cutting edge form concave • optimised cutting edge geometry
 • maximum performance • double margin

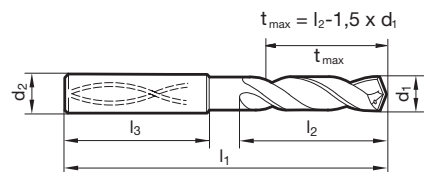

Article no. 5498

Article no. 5498

d1 mm	inch	d2 h6 mm	l1 mm	l2 mm	l3 mm	Order no.	d1 mm	inch	d2 h6 mm	l1 mm	l2 mm	l3 mm	Order no.
3.000		6.0	66.0	28.0	36.0	5498 3.000	7.550		8.0	91.0	53.0	36.0	5498 7.550
3.100		6.0	66.0	28.0	36.0	5498 3.100	7.600		8.0	91.0	53.0	36.0	5498 7.600
3.170	1/8	6.0	66.0	28.0	36.0	5498 3.170	7.650		8.0	91.0	53.0	36.0	5498 7.650
3.200		6.0	66.0	28.0	36.0	5498 3.200	7.700		8.0	91.0	53.0	36.0	5498 7.700
3.250		6.0	66.0	28.0	36.0	5498 3.250	7.800		8.0	91.0	53.0	36.0	5498 7.800
3.300		6.0	66.0	28.0	36.0	5498 3.300	7.900		8.0	91.0	53.0	36.0	5498 7.900
3.400		6.0	66.0	28.0	36.0	5498 3.400	7.940	5/16	8.0	91.0	53.0	36.0	5498 7.940
3.500		6.0	66.0	28.0	36.0	5498 3.500	8.000		8.0	91.0	53.0	36.0	5498 8.000
3.570	9/64	6.0	66.0	28.0	36.0	5498 3.570	8.100		10.0	103.0	61.0	40.0	5498 8.100
3.600		6.0	66.0	28.0	36.0	5498 3.600	8.200		10.0	103.0	61.0	40.0	5498 8.200
3.700		6.0	66.0	28.0	36.0	5498 3.700	8.300		10.0	103.0	61.0	40.0	5498 8.300
3.800		6.0	74.0	36.0	36.0	5498 3.800	8.330	21/64	10.0	103.0	61.0	40.0	5498 8.330
3.900		6.0	74.0	36.0	36.0	5498 3.900	8.400		10.0	103.0	61.0	40.0	5498 8.400
3.970	5/32	6.0	74.0	36.0	36.0	5498 3.970	8.500		10.0	103.0	61.0	40.0	5498 8.500
4.000		6.0	74.0	36.0	36.0	5498 4.000	8.600		10.0	103.0	61.0	40.0	5498 8.600
4.040		6.0	74.0	36.0	36.0	5498 4.040	8.700		10.0	103.0	61.0	40.0	5498 8.700
4.100		6.0	74.0	36.0	36.0	5498 4.100	8.730	11/32	10.0	103.0	61.0	40.0	5498 8.730
4.200		6.0	74.0	36.0	36.0	5498 4.200	8.800		10.0	103.0	61.0	40.0	5498 8.800
4.300		6.0	74.0	36.0	36.0	5498 4.300	8.900		10.0	103.0	61.0	40.0	5498 8.900
4.370	11/64	6.0	74.0	36.0	36.0	5498 4.370	9.000		10.0	103.0	61.0	40.0	5498 9.000
4.400		6.0	74.0	36.0	36.0	5498 4.400	9.100		10.0	103.0	61.0	40.0	5498 9.100
4.500		6.0	74.0	36.0	36.0	5498 4.500	9.130	23/64	10.0	103.0	61.0	40.0	5498 9.130
4.600		6.0	74.0	36.0	36.0	5498 4.600	9.200		10.0	103.0	61.0	40.0	5498 9.200
4.650		6.0	74.0	36.0	36.0	5498 4.650	9.250		10.0	103.0	61.0	40.0	5498 9.250
4.700		6.0	74.0	36.0	36.0	5498 4.700	9.300		10.0	103.0	61.0	40.0	5498 9.300
4.760	3/16	6.0	82.0	44.0	36.0	5498 4.760	9.340		10.0	103.0	61.0	40.0	5498 9.340
4.800		6.0	82.0	44.0	36.0	5498 4.800	9.400		10.0	103.0	61.0	40.0	5498 9.400
4.900		6.0	82.0	44.0	36.0	5498 4.900	9.500		10.0	103.0	61.0	40.0	5498 9.500
5.000		6.0	82.0	44.0	36.0	5498 5.000	9.520	3/8	10.0	103.0	61.0	40.0	5498 9.520
5.100		6.0	82.0	44.0	36.0	5498 5.100	9.550		10.0	103.0	61.0	40.0	5498 9.550
5.110		6.0	82.0	44.0	36.0	5498 5.110	9.600		10.0	103.0	61.0	40.0	5498 9.600
5.160	13/64	6.0	82.0	44.0	36.0	5498 5.160	9.700		10.0	103.0	61.0	40.0	5498 9.700
5.200		6.0	82.0	44.0	36.0	5498 5.200	9.800		10.0	103.0	61.0	40.0	5498 9.800
5.300		6.0	82.0	44.0	36.0	5498 5.300	9.900		10.0	103.0	61.0	40.0	5498 9.900
5.400		6.0	82.0	44.0	36.0	5498 5.400	9.920	25/64	10.0	103.0	61.0	40.0	5498 9.920
5.410		6.0	82.0	44.0	36.0	5498 5.410	10.000		10.0	103.0	61.0	40.0	5498 10.000
5.500		6.0	82.0	44.0	36.0	5498 5.500	10.100		12.0	118.0	71.0	45.0	5498 10.100
5.550		6.0	82.0	44.0	36.0	5498 5.550	10.200		12.0	118.0	71.0	45.0	5498 10.200
5.560	7/32	6.0	82.0	44.0	36.0	5498 5.560	10.300		12.0	118.0	71.0	45.0	5498 10.300
5.600		6.0	82.0	44.0	36.0	5498 5.600	10.320	13/32	12.0	118.0	71.0	45.0	5498 10.320
5.700		6.0	82.0	44.0	36.0	5498 5.700	10.400		12.0	118.0	71.0	45.0	5498 10.400
5.800		6.0	82.0	44.0	36.0	5498 5.800	10.500		12.0	118.0	71.0	45.0	5498 10.500
5.900		6.0	82.0	44.0	36.0	5498 5.900	10.600		12.0	118.0	71.0	45.0	5498 10.600
5.950	15/64	6.0	82.0	44.0	36.0	5498 5.950	10.700		12.0	118.0	71.0	45.0	5498 10.700
6.000		6.0	82.0	44.0	36.0	5498 6.000	10.720	27/64	12.0	118.0	71.0	45.0	5498 10.720
6.100		8.0	91.0	53.0	36.0	5498 6.100	10.800		12.0	118.0	71.0	45.0	5498 10.800
6.200		8.0	91.0	53.0	36.0	5498 6.200	10.900		12.0	118.0	71.0	45.0	5498 10.900
6.300		8.0	91.0	53.0	36.0	5498 6.300	11.000		12.0	118.0	71.0	45.0	5498 11.000
6.350	1/4	8.0	91.0	53.0	36.0	5498 6.350	11.100		12.0	118.0	71.0	45.0	5498 11.100
6.400		8.0	91.0	53.0	36.0	5498 6.400	11.110	7/16	12.0	118.0	71.0	45.0	5498 11.110
6.500		8.0	91.0	53.0	36.0	5498 6.500	11.200		12.0	118.0	71.0	45.0	5498 11.200
6.530		8.0	91.0	53.0	36.0	5498 6.530	11.300		12.0	118.0	71.0	45.0	5498 11.300
6.550		8.0	91.0	53.0	36.0	5498 6.550	11.400		12.0	118.0	71.0	45.0	5498 11.400
6.600		8.0	91.0	53.0	36.0	5498 6.600	11.500		12.0	118.0	71.0	45.0	5498 11.500
6.700		8.0	91.0	53.0	36.0	5498 6.700	11.510	29/64	12.0	118.0	71.0	45.0	5498 11.510
6.750	17/64	8.0	91.0	53.0	36.0	5498 6.750	11.550		12.0	118.0	71.0	45.0	5498 11.550
6.800		8.0	91.0	53.0	36.0	5498 6.800	11.600		12.0	118.0	71.0	45.0	5498 11.600
6.900		8.0	91.0	53.0	36.0	5498 6.900	11.700		12.0	118.0	71.0	45.0	5498 11.700
7.000		8.0	91.0	53.0	36.0	5498 7.000	11.800		12.0	118.0	71.0	45.0	5498 11.800
7.100		8.0	91.0	53.0	36.0	5498 7.100	11.900		12.0	118.0	71.0	45.0	5498 11.900
7.140	9/32	8.0	91.0	53.0	36.0	5498 7.140	11.910	15/32	12.0	118.0	71.0	45.0	5498 11.910
7.200		8.0	91.0	53.0	36.0	5498 7.200	12.000		12.0	118.0	71.0	45.0	5498 12.000
7.300		8.0	91.0	53.0	36.0	5498 7.300	12.100		14.0	124.0	77.0	45.0	5498 12.100
7.400		8.0	91.0	53.0	36.0	5498 7.400	12.200		14.0	124.0	77.0	45.0	5498 12.200
7.500		8.0	91.0	53.0	36.0	5498 7.500	12.300	31/64	14.0	124.0	77.0	45.0	5498 12.300
7.540	19/64	8.0	91.0	53.0	36.0	5498 7.540	12.400		14.0	124.0	77.0	45.0	5498 12.400



Solid carbide drills

Article no. 5498						Article no. 5498							
d1 mm	inch	d2 h6 mm	l1 mm	l2 mm	l3 mm	Order no.	d1 mm	inch	d2 h6 mm	l1 mm	l2 mm	l3 mm	Order no.
12.500		14.0	124.0	77.0	45.0	5498 12.500	15.900		16.0	133.0	83.0	48.0	5498 15.900
12.600		14.0	124.0	77.0	45.0	5498 12.600	16.000		16.0	133.0	83.0	48.0	5498 16.000
12.700	1/2	14.0	124.0	77.0	45.0	5498 12.700	16.270	41/64	18.0	143.0	93.0	48.0	5498 16.270
12.800		14.0	124.0	77.0	45.0	5498 12.800	16.300		18.0	143.0	93.0	48.0	5498 16.300
12.900		14.0	124.0	77.0	45.0	5498 12.900	16.500		18.0	143.0	93.0	48.0	5498 16.500
13.000		14.0	124.0	77.0	45.0	5498 13.000	16.670	21/32	18.0	143.0	93.0	48.0	5498 16.670
13.100	33/64	14.0	124.0	77.0	45.0	5498 13.100	16.700		18.0	143.0	93.0	48.0	5498 16.700
13.200		14.0	124.0	77.0	45.0	5498 13.200	16.900		18.0	143.0	93.0	48.0	5498 16.900
13.300		14.0	124.0	77.0	45.0	5498 13.300	17.000		18.0	143.0	93.0	48.0	5498 17.000
13.400		14.0	124.0	77.0	45.0	5498 13.400	17.070	43/64	18.0	143.0	93.0	48.0	5498 17.070
13.490	17/32	14.0	124.0	77.0	45.0	5498 13.490	17.460	11/16	18.0	143.0	93.0	48.0	5498 17.460
13.500		14.0	124.0	77.0	45.0	5498 13.500	17.500		18.0	143.0	93.0	48.0	5498 17.500
13.600		14.0	124.0	77.0	45.0	5498 13.600	17.550		18.0	143.0	93.0	48.0	5498 17.550
13.700		14.0	124.0	77.0	45.0	5498 13.700	17.700		18.0	143.0	93.0	48.0	5498 17.700
13.800		14.0	124.0	77.0	45.0	5498 13.800	17.860	45/64	18.0	143.0	93.0	48.0	5498 17.860
13.890	35/64	14.0	124.0	77.0	45.0	5498 13.890	18.000		18.0	143.0	93.0	48.0	5498 18.000
13.900		14.0	124.0	77.0	45.0	5498 13.900	18.260	23/32	20.0	153.0	101.0	50.0	5498 18.260
14.000		14.0	124.0	77.0	45.0	5498 14.000	18.500		20.0	153.0	101.0	50.0	5498 18.500
14.100		16.0	133.0	83.0	48.0	5498 14.100	18.700		20.0	153.0	101.0	50.0	5498 18.700
14.200		16.0	133.0	83.0	48.0	5498 14.200	18.900		20.0	153.0	101.0	50.0	5498 18.900
14.290	9/16	16.0	133.0	83.0	48.0	5498 14.290	19.000		20.0	153.0	101.0	50.0	5498 19.000
14.300		16.0	133.0	83.0	48.0	5498 14.300	19.050	3/4	20.0	153.0	101.0	50.0	5498 19.050
14.400		16.0	133.0	83.0	48.0	5498 14.400	19.250		20.0	153.0	101.0	50.0	5498 19.250
14.500		16.0	133.0	83.0	48.0	5498 14.500	19.300		20.0	153.0	101.0	50.0	5498 19.300
14.600		16.0	133.0	83.0	48.0	5498 14.600	19.450	49/64	20.0	153.0	101.0	50.0	5498 19.450
14.680	37/64	16.0	133.0	83.0	48.0	5498 14.680	19.500		20.0	153.0	101.0	50.0	5498 19.500
14.700		16.0	133.0	83.0	48.0	5498 14.700	19.550		20.0	153.0	101.0	50.0	5498 19.550
14.800		16.0	133.0	83.0	48.0	5498 14.800	19.700		20.0	153.0	101.0	50.0	5498 19.700
14.900		16.0	133.0	83.0	48.0	5498 14.900	19.800		20.0	153.0	101.0	50.0	5498 19.800
15.000		16.0	133.0	83.0	48.0	5498 15.000	19.840	25/32	20.0	153.0	101.0	50.0	5498 19.840
15.080	19/32	16.0	133.0	83.0	48.0	5498 15.080	20.000		20.0	153.0	101.0	50.0	5498 20.000
15.100		16.0	133.0	83.0	48.0	5498 15.100							
15.200		16.0	133.0	83.0	48.0	5498 15.200							
15.300		16.0	133.0	83.0	48.0	5498 15.300							
15.400		16.0	133.0	83.0	48.0	5498 15.400							
15.480	39/64	16.0	133.0	83.0	48.0	5498 15.480							
15.500		16.0	133.0	83.0	48.0	5498 15.500							
15.550		16.0	133.0	83.0	48.0	5498 15.550							
15.600		16.0	133.0	83.0	48.0	5498 15.600							
15.700		16.0	133.0	83.0	48.0	5498 15.700							
15.800		16.0	133.0	83.0	48.0	5498 15.800							
15.870	5/8	16.0	133.0	83.0	48.0	5498 15.870							



Ratio drills with coolant ducts

Article no. 5768



Cutting data page 409

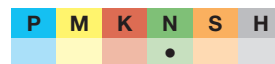
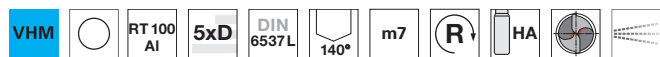

Web thinning $\geq \varnothing 3.000$ • relieved cone • main cutting edge is slightly concave • optimised cutting edge geometry • sharp cutting characteristics

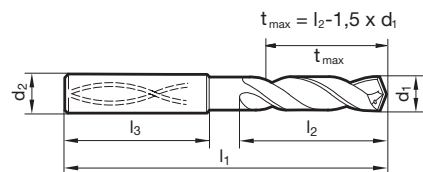

Article no. 5768

Article no. 5768

d1 mm	inch	d2 h6 mm	l1 mm	l2 mm	l3 mm	Order no.	d1 mm	inch	d2 h6 mm	l1 mm	l2 mm	l3 mm	Order no.
3.000		6.0	66.0	28.0	36.0	5768 3.000	8.000		8.0	91.0	53.0	36.0	5768 8.000
3.100		6.0	66.0	28.0	36.0	5768 3.100	8.100		10.0	103.0	61.0	40.0	5768 8.100
3.170	1/8	6.0	66.0	28.0	36.0	5768 3.170	8.200		10.0	103.0	61.0	40.0	5768 8.200
3.200		6.0	66.0	28.0	36.0	5768 3.200	8.300		10.0	103.0	61.0	40.0	5768 8.300
3.250		6.0	66.0	28.0	36.0	5768 3.250	8.330	21/64	10.0	103.0	61.0	40.0	5768 8.330
3.300		6.0	66.0	28.0	36.0	5768 3.300	8.400		10.0	103.0	61.0	40.0	5768 8.400
3.400		6.0	66.0	28.0	36.0	5768 3.400	8.500		10.0	103.0	61.0	40.0	5768 8.500
3.500		6.0	66.0	28.0	36.0	5768 3.500	8.600		10.0	103.0	61.0	40.0	5768 8.600
3.570	9/64	6.0	66.0	28.0	36.0	5768 3.570	8.700		10.0	103.0	61.0	40.0	5768 8.700
3.600		6.0	66.0	28.0	36.0	5768 3.600	8.730	11/32	10.0	103.0	61.0	40.0	5768 8.730
3.700		6.0	66.0	28.0	36.0	5768 3.700	8.800		10.0	103.0	61.0	40.0	5768 8.800
3.800		6.0	74.0	36.0	36.0	5768 3.800	8.900		10.0	103.0	61.0	40.0	5768 8.900
3.900		6.0	74.0	36.0	36.0	5768 3.900	9.000		10.0	103.0	61.0	40.0	5768 9.000
3.970	5/32	6.0	74.0	36.0	36.0	5768 3.970	9.100		10.0	103.0	61.0	40.0	5768 9.100
4.000		6.0	74.0	36.0	36.0	5768 4.000	9.130	23/64	10.0	103.0	61.0	40.0	5768 9.130
4.100		6.0	74.0	36.0	36.0	5768 4.100	9.200		10.0	103.0	61.0	40.0	5768 9.200
4.200		6.0	74.0	36.0	36.0	5768 4.200	9.250		10.0	103.0	61.0	40.0	5768 9.250
4.300		6.0	74.0	36.0	36.0	5768 4.300	9.300		10.0	103.0	61.0	40.0	5768 9.300
4.370	11/64	6.0	74.0	36.0	36.0	5768 4.370	9.340		10.0	103.0	61.0	40.0	5768 9.340
4.400		6.0	74.0	36.0	36.0	5768 4.400	9.400		10.0	103.0	61.0	40.0	5768 9.400
4.500		6.0	74.0	36.0	36.0	5768 4.500	9.500		10.0	103.0	61.0	40.0	5768 9.500
4.600		6.0	74.0	36.0	36.0	5768 4.600	9.520	3/8	10.0	103.0	61.0	40.0	5768 9.520
4.650		6.0	74.0	36.0	36.0	5768 4.650	9.600		10.0	103.0	61.0	40.0	5768 9.600
4.700		6.0	74.0	36.0	36.0	5768 4.700	9.700		10.0	103.0	61.0	40.0	5768 9.700
4.760	3/16	6.0	82.0	44.0	36.0	5768 4.760	9.800		10.0	103.0	61.0	40.0	5768 9.800
4.800		6.0	82.0	44.0	36.0	5768 4.800	9.900		10.0	103.0	61.0	40.0	5768 9.900
4.900		6.0	82.0	44.0	36.0	5768 4.900	9.920	25/64	10.0	103.0	61.0	40.0	5768 9.920
5.000		6.0	82.0	44.0	36.0	5768 5.000	10.000		10.0	103.0	61.0	40.0	5768 10.000
5.100		6.0	82.0	44.0	36.0	5768 5.100	10.100		12.0	118.0	71.0	45.0	5768 10.100
5.160	13/64	6.0	82.0	44.0	36.0	5768 5.160	10.200		12.0	118.0	71.0	45.0	5768 10.200
5.200		6.0	82.0	44.0	36.0	5768 5.200	10.300		12.0	118.0	71.0	45.0	5768 10.300
5.300		6.0	82.0	44.0	36.0	5768 5.300	10.320	13/32	12.0	118.0	71.0	45.0	5768 10.320
5.400		6.0	82.0	44.0	36.0	5768 5.400	10.400		12.0	118.0	71.0	45.0	5768 10.400
5.500		6.0	82.0	44.0	36.0	5768 5.500	10.500		12.0	118.0	71.0	45.0	5768 10.500
5.550		6.0	82.0	44.0	36.0	5768 5.550	10.600		12.0	118.0	71.0	45.0	5768 10.600
5.560	7/32	6.0	82.0	44.0	36.0	5768 5.560	10.700		12.0	118.0	71.0	45.0	5768 10.700
5.600		6.0	82.0	44.0	36.0	5768 5.600	10.800		12.0	118.0	71.0	45.0	5768 10.800
5.700		6.0	82.0	44.0	36.0	5768 5.700	10.900		12.0	118.0	71.0	45.0	5768 10.900
5.800		6.0	82.0	44.0	36.0	5768 5.800	11.000		12.0	118.0	71.0	45.0	5768 11.000
5.900		6.0	82.0	44.0	36.0	5768 5.900	11.100		12.0	118.0	71.0	45.0	5768 11.100
5.950	15/64	6.0	82.0	44.0	36.0	5768 5.950	11.110	7/16	12.0	118.0	71.0	45.0	5768 11.110
6.000		6.0	82.0	44.0	36.0	5768 6.000	11.200		12.0	118.0	71.0	45.0	5768 11.200
6.100		8.0	91.0	53.0	36.0	5768 6.100	11.300		12.0	118.0	71.0	45.0	5768 11.300
6.200		8.0	91.0	53.0	36.0	5768 6.200	11.400		12.0	118.0	71.0	45.0	5768 11.400
6.300		8.0	91.0	53.0	36.0	5768 6.300	11.500		12.0	118.0	71.0	45.0	5768 11.500
6.350	1/4	8.0	91.0	53.0	36.0	5768 6.350	11.600		12.0	118.0	71.0	45.0	5768 11.600
6.400		8.0	91.0	53.0	36.0	5768 6.400	11.700		12.0	118.0	71.0	45.0	5768 11.700
6.500		8.0	91.0	53.0	36.0	5768 6.500	11.800		12.0	118.0	71.0	45.0	5768 11.800
6.600		8.0	91.0	53.0	36.0	5768 6.600	11.900		12.0	118.0	71.0	45.0	5768 11.900
6.700		8.0	91.0	53.0	36.0	5768 6.700	11.910	15/32	12.0	118.0	71.0	45.0	5768 11.910
6.750	17/64	8.0	91.0	53.0	36.0	5768 6.750	12.000		12.0	118.0	71.0	45.0	5768 12.000
6.800		8.0	91.0	53.0	36.0	5768 6.800	12.100		14.0	124.0	77.0	45.0	5768 12.100
6.900		8.0	91.0	53.0	36.0	5768 6.900	12.200		14.0	124.0	77.0	45.0	5768 12.200
7.000		8.0	91.0	53.0	36.0	5768 7.000	12.500		14.0	124.0	77.0	45.0	5768 12.500
7.100		8.0	91.0	53.0	36.0	5768 7.100	12.600		14.0	124.0	77.0	45.0	5768 12.600
7.140	9/32	8.0	91.0	53.0	36.0	5768 7.140	12.700	1/2	14.0	124.0	77.0	45.0	5768 12.700
7.200		8.0	91.0	53.0	36.0	5768 7.200	12.800		14.0	124.0	77.0	45.0	5768 12.800
7.300		8.0	91.0	53.0	36.0	5768 7.300	12.900		14.0	124.0	77.0	45.0	5768 12.900
7.400		8.0	91.0	53.0	36.0	5768 7.400	13.000		14.0	124.0	77.0	45.0	5768 13.000
7.500		8.0	91.0	53.0	36.0	5768 7.500	13.100	33/64	14.0	124.0	77.0	45.0	5768 13.100
7.540	19/64	8.0	91.0	53.0	36.0	5768 7.540	13.300		14.0	124.0	77.0	45.0	5768 13.300
7.600		8.0	91.0	53.0	36.0	5768 7.600	13.400		14.0	124.0	77.0	45.0	5768 13.400
7.700		8.0	91.0	53.0	36.0	5768 7.700	13.500		14.0	124.0	77.0	45.0	5768 13.500
7.800		8.0	91.0	53.0	36.0	5768 7.800	13.700		14.0	124.0	77.0	45.0	5768 13.700
7.900		8.0	91.0	53.0	36.0	5768 7.900	13.800		14.0	124.0	77.0	45.0	5768 13.800
7.940	5/16	8.0	91.0	53.0	36.0	5768 7.940	14.000		14.0	124.0	77.0	45.0	5768 14.000



						Article no.	5768
d1 mm	inch	d2 h6 mm	l1 mm	l2 mm	l3 mm	Order no.	
14.100		16.0	133.0	83.0	48.0	5768	14.100
14.200		16.0	133.0	83.0	48.0	5768	14.200
14.290	9/16	16.0	133.0	83.0	48.0	5768	14.290
14.300		16.0	133.0	83.0	48.0	5768	14.300
14.400		16.0	133.0	83.0	48.0	5768	14.400
14.500		16.0	133.0	83.0	48.0	5768	14.500
14.700		16.0	133.0	83.0	48.0	5768	14.700
14.800		16.0	133.0	83.0	48.0	5768	14.800
15.000		16.0	133.0	83.0	48.0	5768	15.000
15.100		16.0	133.0	83.0	48.0	5768	15.100
15.200		16.0	133.0	83.0	48.0	5768	15.200
15.300		16.0	133.0	83.0	48.0	5768	15.300
15.500		16.0	133.0	83.0	48.0	5768	15.500
15.700		16.0	133.0	83.0	48.0	5768	15.700
15.800		16.0	133.0	83.0	48.0	5768	15.800
16.000		16.0	133.0	83.0	48.0	5768	16.000
16.500		18.0	143.0	93.0	48.0	5768	16.500
16.700		18.0	143.0	93.0	48.0	5768	16.700

						Article no.	5768
d1 mm	inch	d2 h6 mm	l1 mm	l2 mm	l3 mm	Order no.	
16.900		18.0	143.0	93.0	48.0	5768	16.900
17.000		18.0	143.0	93.0	48.0	5768	17.000
17.500		18.0	143.0	93.0	48.0	5768	17.500
17.700		18.0	143.0	93.0	48.0	5768	17.700
18.000		18.0	143.0	93.0	48.0	5768	18.000
18.500		20.0	153.0	101.0	50.0	5768	18.500
18.900		20.0	153.0	101.0	50.0	5768	18.900
19.000		20.0	153.0	101.0	50.0	5768	19.000
19.050	3/4	20.0	153.0	101.0	50.0	5768	19.050
19.300		20.0	153.0	101.0	50.0	5768	19.300
19.500		20.0	153.0	101.0	50.0	5768	19.500
20.000		20.0	153.0	101.0	50.0	5768	20.000



Ratio drills with coolant ducts

Article no. 6501



Cutting data page 410

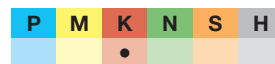

Web thinning ≥ Ø 3.000 • patented radius point grind • main cutting edge form straight (after correction)

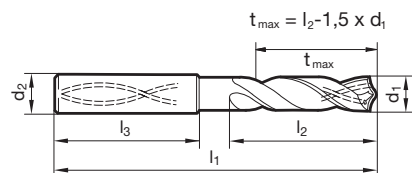

Article no. 6501

Article no. 6501

d1 mm	inch	d2 h6 mm	l1 mm	l2 mm	l3 mm	Order no.	d1 mm	inch	d2 h6 mm	l1 mm	l2 mm	l3 mm	Order no.
3.000		6.0	66.0	28.0	36.0	6501 3.000	8.000		8.0	91.0	53.0	36.0	6501 8.000
3.100		6.0	66.0	28.0	36.0	6501 3.100	8.100		10.0	103.0	61.0	40.0	6501 8.100
3.170	1/8	6.0	66.0	28.0	36.0	6501 3.170	8.200		10.0	103.0	61.0	40.0	6501 8.200
3.200		6.0	66.0	28.0	36.0	6501 3.200	8.300		10.0	103.0	61.0	40.0	6501 8.300
3.250		6.0	66.0	28.0	36.0	6501 3.250	8.330	21/64	10.0	103.0	61.0	40.0	6501 8.330
3.300		6.0	66.0	28.0	36.0	6501 3.300	8.400		10.0	103.0	61.0	40.0	6501 8.400
3.400		6.0	66.0	28.0	36.0	6501 3.400	8.500		10.0	103.0	61.0	40.0	6501 8.500
3.500		6.0	66.0	28.0	36.0	6501 3.500	8.600		10.0	103.0	61.0	40.0	6501 8.600
3.570	9/64	6.0	66.0	28.0	36.0	6501 3.570	8.700		10.0	103.0	61.0	40.0	6501 8.700
3.600		6.0	66.0	28.0	36.0	6501 3.600	8.730	11/32	10.0	103.0	61.0	40.0	6501 8.730
3.700		6.0	66.0	28.0	36.0	6501 3.700	8.800		10.0	103.0	61.0	40.0	6501 8.800
3.800		6.0	74.0	36.0	36.0	6501 3.800	8.900		10.0	103.0	61.0	40.0	6501 8.900
3.900		6.0	74.0	36.0	36.0	6501 3.900	9.000		10.0	103.0	61.0	40.0	6501 9.000
3.970	5/32	6.0	74.0	36.0	36.0	6501 3.970	9.100		10.0	103.0	61.0	40.0	6501 9.100
4.000		6.0	74.0	36.0	36.0	6501 4.000	9.130	23/64	10.0	103.0	61.0	40.0	6501 9.130
4.100		6.0	74.0	36.0	36.0	6501 4.100	9.200		10.0	103.0	61.0	40.0	6501 9.200
4.200		6.0	74.0	36.0	36.0	6501 4.200	9.250		10.0	103.0	61.0	40.0	6501 9.250
4.300		6.0	74.0	36.0	36.0	6501 4.300	9.300		10.0	103.0	61.0	40.0	6501 9.300
4.370	11/64	6.0	74.0	36.0	36.0	6501 4.370	9.400		10.0	103.0	61.0	40.0	6501 9.400
4.400		6.0	74.0	36.0	36.0	6501 4.400	9.500		10.0	103.0	61.0	40.0	6501 9.500
4.500		6.0	74.0	36.0	36.0	6501 4.500	9.520	3/8	10.0	103.0	61.0	40.0	6501 9.520
4.600		6.0	74.0	36.0	36.0	6501 4.600	9.600		10.0	103.0	61.0	40.0	6501 9.600
4.650		6.0	74.0	36.0	36.0	6501 4.650	9.700		10.0	103.0	61.0	40.0	6501 9.700
4.700		6.0	74.0	36.0	36.0	6501 4.700	9.800		10.0	103.0	61.0	40.0	6501 9.800
4.760	3/16	6.0	82.0	44.0	36.0	6501 4.760	9.900		10.0	103.0	61.0	40.0	6501 9.900
4.800		6.0	82.0	44.0	36.0	6501 4.800	9.920	25/64	10.0	103.0	61.0	40.0	6501 9.920
4.900		6.0	82.0	44.0	36.0	6501 4.900	10.000		10.0	103.0	61.0	40.0	6501 10.000
5.000		6.0	82.0	44.0	36.0	6501 5.000	10.100		12.0	118.0	71.0	45.0	6501 10.100
5.100		6.0	82.0	44.0	36.0	6501 5.100	10.200		12.0	118.0	71.0	45.0	6501 10.200
5.160	13/64	6.0	82.0	44.0	36.0	6501 5.160	10.300		12.0	118.0	71.0	45.0	6501 10.300
5.200		6.0	82.0	44.0	36.0	6501 5.200	10.320	13/32	12.0	118.0	71.0	45.0	6501 10.320
5.300		6.0	82.0	44.0	36.0	6501 5.300	10.400		12.0	118.0	71.0	45.0	6501 10.400
5.400		6.0	82.0	44.0	36.0	6501 5.400	10.500		12.0	118.0	71.0	45.0	6501 10.500
5.500		6.0	82.0	44.0	36.0	6501 5.500	10.600		12.0	118.0	71.0	45.0	6501 10.600
5.550		6.0	82.0	44.0	36.0	6501 5.550	10.700		12.0	118.0	71.0	45.0	6501 10.700
5.560	7/32	6.0	82.0	44.0	36.0	6501 5.560	10.720	27/64	12.0	118.0	71.0	45.0	6501 10.720
5.600		6.0	82.0	44.0	36.0	6501 5.600	10.800		12.0	118.0	71.0	45.0	6501 10.800
5.700		6.0	82.0	44.0	36.0	6501 5.700	10.900		12.0	118.0	71.0	45.0	6501 10.900
5.800		6.0	82.0	44.0	36.0	6501 5.800	11.000		12.0	118.0	71.0	45.0	6501 11.000
5.900		6.0	82.0	44.0	36.0	6501 5.900	11.100		12.0	118.0	71.0	45.0	6501 11.100
5.950	15/64	6.0	82.0	44.0	36.0	6501 5.950	11.110	7/16	12.0	118.0	71.0	45.0	6501 11.110
6.000		6.0	82.0	44.0	36.0	6501 6.000	11.200		12.0	118.0	71.0	45.0	6501 11.200
6.100		8.0	91.0	53.0	36.0	6501 6.100	11.300		12.0	118.0	71.0	45.0	6501 11.300
6.200		8.0	91.0	53.0	36.0	6501 6.200	11.400		12.0	118.0	71.0	45.0	6501 11.400
6.300		8.0	91.0	53.0	36.0	6501 6.300	11.450		12.0	118.0	71.0	45.0	6501 11.450
6.350	1/4	8.0	91.0	53.0	36.0	6501 6.350	11.500		12.0	118.0	71.0	45.0	6501 11.500
6.400		8.0	91.0	53.0	36.0	6501 6.400	11.600		12.0	118.0	71.0	45.0	6501 11.600
6.500		8.0	91.0	53.0	36.0	6501 6.500	11.700		12.0	118.0	71.0	45.0	6501 11.700
6.600		8.0	91.0	53.0	36.0	6501 6.600	11.800		12.0	118.0	71.0	45.0	6501 11.800
6.700		8.0	91.0	53.0	36.0	6501 6.700	11.900		12.0	118.0	71.0	45.0	6501 11.900
6.750	17/64	8.0	91.0	53.0	36.0	6501 6.750	11.910	15/32	12.0	118.0	71.0	45.0	6501 11.910
6.800		8.0	91.0	53.0	36.0	6501 6.800	12.000		12.0	118.0	71.0	45.0	6501 12.000
6.900		8.0	91.0	53.0	36.0	6501 6.900	12.100		14.0	124.0	77.0	45.0	6501 12.100
7.000		8.0	91.0	53.0	36.0	6501 7.000	12.200		14.0	124.0	77.0	45.0	6501 12.200
7.100		8.0	91.0	53.0	36.0	6501 7.100	12.300	31/64	14.0	124.0	77.0	45.0	6501 12.300
7.140	9/32	8.0	91.0	53.0	36.0	6501 7.140	12.400		14.0	124.0	77.0	45.0	6501 12.400
7.200		8.0	91.0	53.0	36.0	6501 7.200	12.500		14.0	124.0	77.0	45.0	6501 12.500
7.300		8.0	91.0	53.0	36.0	6501 7.300	12.600		14.0	124.0	77.0	45.0	6501 12.600
7.400		8.0	91.0	53.0	36.0	6501 7.400	12.700	1/2	14.0	124.0	77.0	45.0	6501 12.700
7.500		8.0	91.0	53.0	36.0	6501 7.500	12.800		14.0	124.0	77.0	45.0	6501 12.800
7.540	19/64	8.0	91.0	53.0	36.0	6501 7.540	12.900		14.0	124.0	77.0	45.0	6501 12.900
7.600		8.0	91.0	53.0	36.0	6501 7.600	13.000		14.0	124.0	77.0	45.0	6501 13.000
7.700		8.0	91.0	53.0	36.0	6501 7.700	13.100	33/64	14.0	124.0	77.0	45.0	6501 13.100
7.800		8.0	91.0	53.0	36.0	6501 7.800	13.300		14.0	124.0	77.0	45.0	6501 13.300
7.900		8.0	91.0	53.0	36.0	6501 7.900	13.400		14.0	124.0	77.0	45.0	6501 13.400
7.940	5/16	8.0	91.0	53.0	36.0	6501 7.940	13.500		14.0	124.0	77.0	45.0	6501 13.500



Solid carbide drills

Article no.						6501	Article no.						6501
d1 mm	inch	d2 h6 mm	l1 mm	l2 mm	l3 mm	Order no.	d1 mm	inch	d2 h6 mm	l1 mm	l2 mm	l3 mm	Order no.
13.700		14.0	124.0	77.0	45.0	6501 13.700	15.500		16.0	133.0	83.0	48.0	6501 15.500
13.800		14.0	124.0	77.0	45.0	6501 13.800	15.600		16.0	133.0	83.0	48.0	6501 15.600
13.900		14.0	124.0	77.0	45.0	6501 13.900	15.700		16.0	133.0	83.0	48.0	6501 15.700
14.000		14.0	124.0	77.0	45.0	6501 14.000	15.800		16.0	133.0	83.0	48.0	6501 15.800
14.100		16.0	133.0	83.0	48.0	6501 14.100	15.870	5/8	16.0	133.0	83.0	48.0	6501 15.870
14.200		16.0	133.0	83.0	48.0	6501 14.200	15.900		16.0	133.0	83.0	48.0	6501 15.900
14.290	9/16	16.0	133.0	83.0	48.0	6501 14.290	16.000		16.0	133.0	83.0	48.0	6501 16.000
14.300		16.0	133.0	83.0	48.0	6501 14.300	16.500		18.0	143.0	93.0	48.0	6501 16.500
14.400		16.0	133.0	83.0	48.0	6501 14.400	16.670	21/32	18.0	143.0	93.0	48.0	6501 16.670
14.500		16.0	133.0	83.0	48.0	6501 14.500	17.000		18.0	143.0	93.0	48.0	6501 17.000
14.600		16.0	133.0	83.0	48.0	6501 14.600	17.500		18.0	143.0	93.0	48.0	6501 17.500
14.700		16.0	133.0	83.0	48.0	6501 14.700	18.000		18.0	143.0	93.0	48.0	6501 18.000
14.900		16.0	133.0	83.0	48.0	6501 14.900	18.500		20.0	153.0	101.0	50.0	6501 18.500
15.000		16.0	133.0	83.0	48.0	6501 15.000	19.000		20.0	153.0	101.0	50.0	6501 19.000
15.100		16.0	133.0	83.0	48.0	6501 15.100	19.500		20.0	153.0	101.0	50.0	6501 19.500
15.200		16.0	133.0	83.0	48.0	6501 15.200	20.000		20.0	153.0	101.0	50.0	6501 20.000
15.300		16.0	133.0	83.0	48.0	6501 15.300							
15.400		16.0	133.0	83.0	48.0	6501 15.400							



Ratio drills with coolant ducts

Article no. 4044

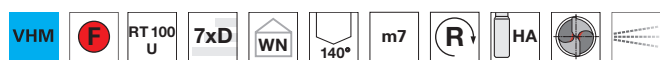

Web thinning $\geq \varnothing 3.000$ • facet point grind • main cutting edge form straight • optimised cutting edge geometry

Cutting data page 402

P	M	K	N	S	H
●	○	●	○	○	○

Ratio drills with coolant ducts

Article no. 4045

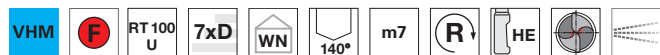

Web thinning $\geq \varnothing 3.000$ • facet point grind • main cutting edge form straight • optimised cutting edge geometry

Cutting data page 402

P	M	K	N	S	H
●	○	●	○	○	○

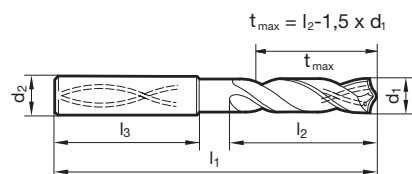

Article no.

4044 4045

Article no.

4044 4045

d1 mm	inch	d2 h6 mm	l1 mm	l2 mm	l3 mm	Order no.		d1 mm	inch	d2 h6 mm	l1 mm	l2 mm	l3 mm	Order no.	
3.000		6.0	70.0	30.0	36.0	4044 3.000	4045 3.000	6.750	17/64	8.0	106.0	66.0	36.0	4044 6.750	
3.100		6.0	70.0	30.0	36.0	4044 3.100	4045 3.100	6.800		8.0	106.0	66.0	36.0	4044 6.800	4045 6.800
3.170	1/8	6.0	70.0	30.0	36.0	4044 3.170	4045 3.170	6.900		8.0	116.0	76.0	36.0	4044 6.900	4045 6.900
3.200		6.0	70.0	30.0	36.0	4044 3.200	4045 3.200	7.000		8.0	116.0	76.0	36.0	4044 7.000	4045 7.000
3.250		6.0	70.0	30.0	36.0	4044 3.250	4045 3.250	7.100		8.0	116.0	76.0	36.0	4044 7.100	4045 7.100
3.300		6.0	70.0	30.0	36.0	4044 3.300	4045 3.300	7.140	9/32	8.0	116.0	76.0	36.0	4044 7.140	
3.400		6.0	75.0	35.5	36.0	4044 3.400	4045 3.400	7.200		8.0	116.0	76.0	36.0	4044 7.200	4045 7.200
3.500		6.0	75.0	35.5	36.0	4044 3.500	4045 3.500	7.300		8.0	116.0	76.0	36.0	4044 7.300	
3.570	9/64	6.0	75.0	35.5	36.0	4044 3.570	4045 3.570	7.400		8.0	116.0	76.0	36.0	4044 7.400	4045 7.400
3.600		6.0	75.0	35.5	36.0	4044 3.600	4045 3.600	7.500		8.0	116.0	76.0	36.0	4044 7.500	4045 7.500
3.700		6.0	75.0	35.5	36.0	4044 3.700	4045 3.700	7.540	19/64	8.0	116.0	76.0	36.0	4044 7.540	
3.800		6.0	75.0	37.5	36.0	4044 3.800	4045 3.800	7.600		8.0	116.0	76.0	36.0	4044 7.600	4045 7.600
3.900		6.0	75.0	37.5	36.0	4044 3.900	4045 3.900	7.700		8.0	116.0	76.0	36.0	4044 7.700	4045 7.700
3.970	5/32	6.0	75.0	37.5	36.0	4044 3.970	4045 3.970	7.800		8.0	116.0	76.0	36.0	4044 7.800	4045 7.800
4.000		6.0	75.0	37.5	36.0	4044 4.000	4045 4.000	7.900		8.0	116.0	76.0	36.0	4044 7.900	
4.040		6.0	75.0	37.5	36.0	4044 4.040		7.940	5/16	8.0	116.0	76.0	36.0	4044 7.940	
4.100		6.0	75.0	37.5	36.0	4044 4.100	4045 4.100	8.000		8.0	116.0	76.0	36.0	4044 8.000	4045 8.000
4.200		6.0	75.0	37.5	36.0	4044 4.200	4045 4.200	8.100		10.0	131.0	87.0	40.0	4044 8.100	4045 8.100
4.300		6.0	85.0	45.0	36.0	4044 4.300	4045 4.300	8.200		10.0	131.0	87.0	40.0	4044 8.200	4045 8.200
4.370	11/64	6.0	85.0	45.0	36.0	4044 4.370	4045 4.370	8.300		10.0	131.0	87.0	40.0	4044 8.300	
4.400		6.0	85.0	45.0	36.0	4044 4.400	4045 4.400	8.330	21/64	10.0	131.0	87.0	40.0	4044 8.330	
4.500		6.0	85.0	45.0	36.0	4044 4.500	4045 4.500	8.400		10.0	131.0	87.0	40.0	4044 8.400	4045 8.400
4.600		6.0	85.0	45.0	36.0	4044 4.600	4045 4.600	8.500		10.0	131.0	87.0	40.0	4044 8.500	4045 8.500
4.650		6.0	85.0	45.0	36.0	4044 4.650	4045 4.650	8.600		10.0	131.0	87.0	40.0	4044 8.600	4045 8.600
4.700		6.0	85.0	45.0	36.0	4044 4.700	4045 4.700	8.700		10.0	131.0	87.0	40.0	4044 8.700	4045 8.700
4.760	3/16	6.0	90.0	50.0	36.0	4044 4.760	4045 4.760	8.730	11/32	10.0	131.0	87.0	40.0	4044 8.730	
4.800		6.0	90.0	50.0	36.0	4044 4.800	4045 4.800	8.800		10.0	131.0	87.0	40.0	4044 8.800	4045 8.800
4.900		6.0	90.0	50.0	36.0	4044 4.900	4045 4.900	8.900		10.0	131.0	87.0	40.0	4044 8.900	
5.000		6.0	90.0	50.0	36.0	4044 5.000	4045 5.000	9.000		10.0	131.0	87.0	40.0	4044 9.000	4045 9.000
5.100		6.0	90.0	50.0	36.0	4044 5.100	4045 5.100	9.100		10.0	139.0	95.0	40.0	4044 9.100	4045 9.100
5.110		6.0	90.0	50.0	36.0	4044 5.110		9.130	23/64	10.0	139.0	95.0	40.0	4044 9.130	
5.160	13/64	6.0	90.0	50.0	36.0	4044 5.160	4045 5.160	9.200		10.0	139.0	95.0	40.0	4044 9.200	4045 9.200
5.200		6.0	90.0	50.0	36.0	4044 5.200	4045 5.200	9.250		10.0	139.0	95.0	40.0	4044 9.250	
5.300		6.0	90.0	50.0	36.0	4044 5.300	4045 5.300	9.300		10.0	139.0	95.0	40.0	4044 9.300	4045 9.300
5.400		6.0	97.0	57.0	36.0	4044 5.400	4045 5.400	9.340		10.0	139.0	95.0	40.0	4044 9.340	
5.410		6.0	97.0	57.0	36.0	4044 5.410		9.400		10.0	139.0	95.0	40.0	4044 9.400	4045 9.400
5.500		6.0	97.0	57.0	36.0	4044 5.500	4045 5.500	9.500		10.0	139.0	95.0	40.0	4044 9.500	4045 9.500
5.550		6.0	97.0	57.0	36.0	4044 5.550		9.520	3/8	10.0	139.0	95.0	40.0	4044 9.520	4045 9.520
5.560	7/32	6.0	97.0	57.0	36.0	4044 5.560	4045 5.560	9.600		10.0	139.0	95.0	40.0	4044 9.600	
5.600		6.0	97.0	57.0	36.0	4044 5.600		9.700		10.0	139.0	95.0	40.0	4044 9.700	4045 9.700
5.700		6.0	97.0	57.0	36.0	4044 5.700	4045 5.700	9.800		10.0	139.0	95.0	40.0	4044 9.800	4045 9.800
5.800		6.0	97.0	57.0	36.0	4044 5.800	4045 5.800	9.900		10.0	139.0	95.0	40.0	4044 9.900	4045 9.900
5.900		6.0	97.0	57.0	36.0	4044 5.900	4045 5.900	9.920	25/64	10.0	139.0	95.0	40.0	4044 9.920	
5.950	15/64	6.0	97.0	57.0	36.0	4044 5.950		10.000		10.0	139.0	95.0	40.0	4044 10.000	4045 10.000
6.000		6.0	97.0	57.0	36.0	4044 6.000	4045 6.000	10.100		12.0	155.0	106.0	45.0	4044 10.100	
6.100		8.0	106.0	66.0	36.0	4044 6.100		10.200		12.0	155.0	106.0	45.0	4044 10.200	4045 10.200
6.200		8.0	106.0	66.0	36.0	4044 6.200	4045 6.200	10.300		12.0	155.0	106.0	45.0	4044 10.300	4045 10.300
6.300		8.0	106.0	66.0	36.0	4044 6.300	4045 6.300	10.320	13/32	12.0	155.0	106.0	45.0	4044 10.320	
6.350	1/4	8.0	106.0	66.0	36.0	4044 6.350	4045 6.350	10.400		12.0	155.0	106.0	45.0	4044 10.400	
6.400		8.0	106.0	66.0	36.0	4044 6.400		10.500		12.0	155.0	106.0	45.0	4044 10.500	4045 10.500
6.500		8.0	106.0	66.0	36.0	4044 6.500	4045 6.500	10.600		12.0	155.0	106.0	45.0	4044 10.600	
6.530		8.0	106.0	66.0	36.0	4044 6.530		10.700		12.0	155.0	106.0	45.0	4044 10.700	
6.600		8.0	106.0	66.0	36.0	4044 6.600	4045 6.600	10.720	27/64	12.0	155.0	106.0	45.0	4044 10.720	
6.700		8.0	106.0	66.0	36.0	4044 6.700	4045 6.700	10.800		12.0	155.0	106.0	45.0	4044 10.800	4045 10.800



Solid carbide drills

Article no.						4044	4045	Article no.						4044	4045
d1 mm	inch	d2 h6 mm	l1 mm	l2 mm	l3 mm	Order no.		d1 mm	inch	d2 h6 mm	l1 mm	l2 mm	l3 mm	Order no.	
10.900		12.0	155.0	106.0	45.0	4044 10.900		13.890	35/64	14.0	182.0	133.0	45.0	4044 13.890	
11.000		12.0	155.0	106.0	45.0	4044 11.000	4045 11.000	14.000		14.0	182.0	133.0	45.0	4044 14.000	4045 14.000
11.100		12.0	163.0	114.0	45.0	4044 11.100		14.100		16.0	204.0	152.0	48.0	4044 14.100	4045 14.100
11.110	7/16	12.0	163.0	114.0	45.0	4044 11.110		14.200		16.0	204.0	152.0	48.0	4044 14.200	4045 14.200
11.200		12.0	163.0	114.0	45.0	4044 11.200	4045 11.200	14.290	9/16	16.0	204.0	152.0	48.0	4044 14.290	
11.300		12.0	163.0	114.0	45.0	4044 11.300		14.500		16.0	204.0	152.0	48.0	4044 14.500	4045 14.500
11.400		12.0	163.0	114.0	45.0	4044 11.400		15.000		16.0	204.0	152.0	48.0	4044 15.000	4045 15.000
11.500		12.0	163.0	114.0	45.0	4044 11.500	4045 11.500	15.100		16.0	204.0	152.0	48.0	4044 15.100	
11.510	29/64	12.0	163.0	114.0	45.0	4044 11.510		15.480	39/64	16.0	204.0	152.0	48.0	4044 15.480	
11.600		12.0	163.0	114.0	45.0	4044 11.600		15.500		16.0	204.0	152.0	48.0	4044 15.500	4045 15.500
11.700		12.0	163.0	114.0	45.0	4044 11.700		15.870	5/8	16.0	204.0	152.0	48.0	4044 15.870	
11.800		12.0	163.0	114.0	45.0	4044 11.800	4045 11.800	16.000		16.0	204.0	152.0	48.0	4044 16.000	4045 16.000
11.900		12.0	163.0	114.0	45.0	4044 11.900		16.500		18.0	223.0	171.0	48.0	4044 16.500	4045 16.500
11.910	15/32	12.0	163.0	114.0	45.0	4044 11.910		16.900		18.0	223.0	171.0	48.0	4044 16.900	
12.000		12.0	163.0	114.0	45.0	4044 12.000	4045 12.000	17.000		18.0	223.0	171.0	48.0	4044 17.000	4045 17.000
12.100		14.0	182.0	133.0	45.0	4044 12.100	4045 12.100	17.500		18.0	223.0	171.0	48.0	4044 17.500	4045 17.500
12.200		14.0	182.0	133.0	45.0	4044 12.200	4045 12.200	18.000		18.0	223.0	171.0	48.0	4044 18.000	4045 18.000
12.300	31/64	14.0	182.0	133.0	45.0	4044 12.300		18.500		20.0	244.0	190.0	50.0	4044 18.500	4045 18.500
12.500		14.0	182.0	133.0	45.0	4044 12.500	4045 12.500	18.900		20.0	244.0	190.0	50.0	4044 18.900	
12.700	1/2	14.0	182.0	133.0	45.0	4044 12.700	4045 12.700	19.000		20.0	244.0	190.0	50.0	4044 19.000	4045 19.000
13.000		14.0	182.0	133.0	45.0	4044 13.000	4045 13.000	19.050	3/4	20.0	244.0	190.0	50.0	4044 19.050	4045 19.050
13.100	33/64	14.0	182.0	133.0	45.0	4044 13.100		19.500		20.0	244.0	190.0	50.0	4044 19.500	4045 19.500
13.490	17/32	14.0	182.0	133.0	45.0	4044 13.490		20.000		20.0	244.0	190.0	50.0	4044 20.000	4045 20.000
13.500		14.0	182.0	133.0	45.0	4044 13.500	4045 13.500								



Ratio drills with coolant ducts

Article no. 8522



Cutting data page 405

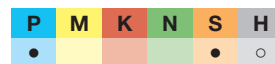
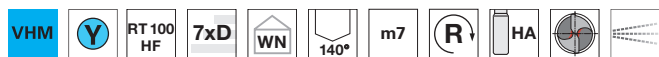

Web thinning $\geq \varnothing$ 3.000 • relieved cone • main cutting edge is slightly concave • optimised cutting edge geometry • double margin

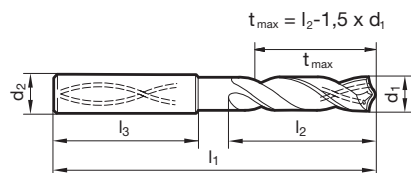

Article no. 8522

Article no. 8522

d1 mm	inch	d2 h6 mm	l1 mm	l2 mm	l3 mm	Order no.
3.000		6.0	70.0	30.0	36.0	8522 3.000
3.170	1/8	6.0	70.0	30.0	36.0	8522 3.170
3.250		6.0	70.0	30.0	36.0	8522 3.250
3.300		6.0	70.0	30.0	36.0	8522 3.300
3.400		6.0	75.0	35.5	36.0	8522 3.400
3.500		6.0	75.0	35.5	36.0	8522 3.500
3.570	9/64	6.0	75.0	35.5	36.0	8522 3.570
3.700		6.0	75.0	35.5	36.0	8522 3.700
3.970	5/32	6.0	75.0	37.5	36.0	8522 3.970
4.000		6.0	75.0	37.5	36.0	8522 4.000
4.200		6.0	75.0	37.5	36.0	8522 4.200
4.300		6.0	85.0	45.0	36.0	8522 4.300
4.370	11/64	6.0	85.0	45.0	36.0	8522 4.370
4.500		6.0	85.0	45.0	36.0	8522 4.500
4.650		6.0	85.0	45.0	36.0	8522 4.650
4.760	3/16	6.0	90.0	50.0	36.0	8522 4.760
5.000		6.0	90.0	50.0	36.0	8522 5.000
5.100		6.0	90.0	50.0	36.0	8522 5.100
5.160	13/64	6.0	90.0	50.0	36.0	8522 5.160
5.200		6.0	90.0	50.0	36.0	8522 5.200
5.500		6.0	97.0	57.0	36.0	8522 5.500
5.550		6.0	97.0	57.0	36.0	8522 5.550
5.560	7/32	6.0	97.0	57.0	36.0	8522 5.560
5.950	15/64	6.0	97.0	57.0	36.0	8522 5.950
6.000		6.0	97.0	57.0	36.0	8522 6.000
6.350	1/4	8.0	106.0	66.0	36.0	8522 6.350
6.500		8.0	106.0	66.0	36.0	8522 6.500
6.530		8.0	106.0	66.0	36.0	8522 6.530
6.750	17/64	8.0	106.0	66.0	36.0	8522 6.750
6.800		8.0	106.0	66.0	36.0	8522 6.800
6.900		8.0	116.0	76.0	36.0	8522 6.900
7.000		8.0	116.0	76.0	36.0	8522 7.000
7.140	9/32	8.0	116.0	76.0	36.0	8522 7.140
7.400		8.0	116.0	76.0	36.0	8522 7.400
7.500		8.0	116.0	76.0	36.0	8522 7.500
7.540	19/64	8.0	116.0	76.0	36.0	8522 7.540
7.800		8.0	116.0	76.0	36.0	8522 7.800
7.940	5/16	8.0	116.0	76.0	36.0	8522 7.940
8.000		8.0	116.0	76.0	36.0	8522 8.000
8.330	21/64	10.0	131.0	87.0	40.0	8522 8.330
8.500		10.0	131.0	87.0	40.0	8522 8.500
8.600		10.0	131.0	87.0	40.0	8522 8.600

d1 mm	inch	d2 h6 mm	l1 mm	l2 mm	l3 mm	Order no.
8.730	11/32	10.0	131.0	87.0	40.0	8522 8.730
8.800		10.0	131.0	87.0	40.0	8522 8.800
9.000		10.0	131.0	87.0	40.0	8522 9.000
9.130	23/64	10.0	139.0	95.0	40.0	8522 9.130
9.250		10.0	139.0	95.0	40.0	8522 9.250
9.340		10.0	139.0	95.0	40.0	8522 9.340
9.400		10.0	139.0	95.0	40.0	8522 9.400
9.500		10.0	139.0	95.0	40.0	8522 9.500
9.520	3/8	10.0	139.0	95.0	40.0	8522 9.520
9.920	25/64	10.0	139.0	95.0	40.0	8522 9.920
10.000		10.0	139.0	95.0	40.0	8522 10.000
10.200		12.0	155.0	106.0	45.0	8522 10.200
10.320	13/32	12.0	155.0	106.0	45.0	8522 10.320
10.400		12.0	155.0	106.0	45.0	8522 10.400
10.500		12.0	155.0	106.0	45.0	8522 10.500
10.720	27/64	12.0	155.0	106.0	45.0	8522 10.720
10.800		12.0	155.0	106.0	45.0	8522 10.800
11.000		12.0	155.0	106.0	45.0	8522 11.000
11.110	7/16	12.0	163.0	114.0	45.0	8522 11.110
11.300		12.0	163.0	114.0	45.0	8522 11.300
11.400		12.0	163.0	114.0	45.0	8522 11.400
11.500		12.0	163.0	114.0	45.0	8522 11.500
11.510	29/64	12.0	163.0	114.0	45.0	8522 11.510
11.910	15/32	12.0	163.0	114.0	45.0	8522 11.910
12.000		12.0	163.0	114.0	45.0	8522 12.000
12.300	31/64	14.0	182.0	133.0	45.0	8522 12.300
12.500		14.0	182.0	133.0	45.0	8522 12.500
12.700	1/2	14.0	182.0	133.0	45.0	8522 12.700
13.000		14.0	182.0	133.0	45.0	8522 13.000
13.100	33/64	14.0	182.0	133.0	45.0	8522 13.100
13.490	17/32	14.0	182.0	133.0	45.0	8522 13.490
13.500		14.0	182.0	133.0	45.0	8522 13.500
14.000		14.0	182.0	133.0	45.0	8522 14.000
14.290	9/16	16.0	204.0	152.0	48.0	8522 14.290
14.500		16.0	204.0	152.0	48.0	8522 14.500
15.000		16.0	204.0	152.0	48.0	8522 15.000
15.100		16.0	204.0	152.0	48.0	8522 15.100
15.500		16.0	204.0	152.0	48.0	8522 15.500
15.870	5/8	16.0	204.0	152.0	48.0	8522 15.870
16.000		16.0	204.0	152.0	48.0	8522 16.000



Ratio drills with coolant ducts

Article no. **5499**



Cutting data page 407

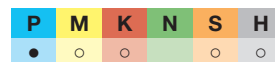
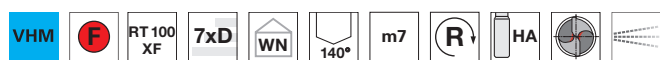

Web thinning $\geq \varnothing 3.000$ • relieved cone • main cutting edge form concave • optimised cutting edge geometry
• maximum performance • double margin

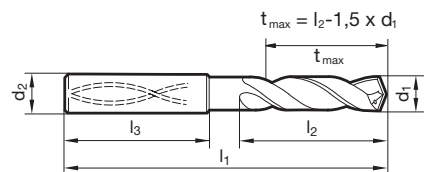

Article no. **5499**

Article no. **5499**

d1 mm	inch	d2 h6 mm	l1 mm	l2 mm	l3 mm	Order no.	d1 mm	inch	d2 h6 mm	l1 mm	l2 mm	l3 mm	Order no.
3.000		6.0	70.0	30.0	36.0	5499 3.000	7.600		8.0	116.0	76.0	36.0	5499 7.600
3.100		6.0	70.0	30.0	36.0	5499 3.100	7.700		8.0	116.0	76.0	36.0	5499 7.700
3.170	1/8	6.0	70.0	30.0	36.0	5499 3.170	7.800		8.0	116.0	76.0	36.0	5499 7.800
3.200		6.0	70.0	30.0	36.0	5499 3.200	7.900		8.0	116.0	76.0	36.0	5499 7.900
3.250		6.0	70.0	30.0	36.0	5499 3.250	7.940	5/16	8.0	116.0	76.0	36.0	5499 7.940
3.300		6.0	70.0	30.0	36.0	5499 3.300	8.000		8.0	116.0	76.0	36.0	5499 8.000
3.400		6.0	75.0	35.5	36.0	5499 3.400	8.100		10.0	131.0	87.0	40.0	5499 8.100
3.500		6.0	75.0	35.5	36.0	5499 3.500	8.200		10.0	131.0	87.0	40.0	5499 8.200
3.570	9/64	6.0	75.0	35.5	36.0	5499 3.570	8.300		10.0	131.0	87.0	40.0	5499 8.300
3.600		6.0	75.0	35.5	36.0	5499 3.600	8.330	21/64	10.0	131.0	87.0	40.0	5499 8.330
3.700		6.0	75.0	35.5	36.0	5499 3.700	8.400		10.0	131.0	87.0	40.0	5499 8.400
3.800		6.0	75.0	37.5	36.0	5499 3.800	8.500		10.0	131.0	87.0	40.0	5499 8.500
3.900		6.0	75.0	37.5	36.0	5499 3.900	8.600		10.0	131.0	87.0	40.0	5499 8.600
3.970	5/32	6.0	75.0	37.5	36.0	5499 3.970	8.700		10.0	131.0	87.0	40.0	5499 8.700
4.000		6.0	75.0	37.5	36.0	5499 4.000	8.730	11/32	10.0	131.0	87.0	40.0	5499 8.730
4.040		6.0	75.0	37.5	36.0	5499 4.040	8.800		10.0	131.0	87.0	40.0	5499 8.800
4.100		6.0	75.0	37.5	36.0	5499 4.100	8.900		10.0	131.0	87.0	40.0	5499 8.900
4.200		6.0	75.0	37.5	36.0	5499 4.200	9.000		10.0	131.0	87.0	40.0	5499 9.000
4.300		6.0	85.0	45.0	36.0	5499 4.300	9.100		10.0	139.0	95.0	40.0	5499 9.100
4.370	11/64	6.0	85.0	45.0	36.0	5499 4.370	9.130	23/64	10.0	139.0	95.0	40.0	5499 9.130
4.400		6.0	85.0	45.0	36.0	5499 4.400	9.200		10.0	139.0	95.0	40.0	5499 9.200
4.500		6.0	85.0	45.0	36.0	5499 4.500	9.250		10.0	139.0	95.0	40.0	5499 9.250
4.600		6.0	85.0	45.0	36.0	5499 4.600	9.300		10.0	139.0	95.0	40.0	5499 9.300
4.650		6.0	85.0	45.0	36.0	5499 4.650	9.340		10.0	139.0	95.0	40.0	5499 9.340
4.700		6.0	85.0	45.0	36.0	5499 4.700	9.400		10.0	139.0	95.0	40.0	5499 9.400
4.760	3/16	6.0	90.0	50.0	36.0	5499 4.760	9.500		10.0	139.0	95.0	40.0	5499 9.500
4.800		6.0	90.0	50.0	36.0	5499 4.800	9.520	3/8	10.0	139.0	95.0	40.0	5499 9.520
4.900		6.0	90.0	50.0	36.0	5499 4.900	9.600		10.0	139.0	95.0	40.0	5499 9.600
5.000		6.0	90.0	50.0	36.0	5499 5.000	9.700		10.0	139.0	95.0	40.0	5499 9.700
5.100		6.0	90.0	50.0	36.0	5499 5.100	9.800		10.0	139.0	95.0	40.0	5499 9.800
5.110		6.0	90.0	50.0	36.0	5499 5.110	9.900		10.0	139.0	95.0	40.0	5499 9.900
5.160	13/64	6.0	90.0	50.0	36.0	5499 5.160	9.920	25/64	10.0	139.0	95.0	40.0	5499 9.920
5.200		6.0	90.0	50.0	36.0	5499 5.200	10.000		10.0	139.0	95.0	40.0	5499 10.000
5.300		6.0	90.0	50.0	36.0	5499 5.300	10.100		12.0	155.0	106.0	45.0	5499 10.100
5.400		6.0	97.0	57.0	36.0	5499 5.400	10.200		12.0	155.0	106.0	45.0	5499 10.200
5.410		6.0	97.0	57.0	36.0	5499 5.410	10.300		12.0	155.0	106.0	45.0	5499 10.300
5.500		6.0	97.0	57.0	36.0	5499 5.500	10.320	13/32	12.0	155.0	106.0	45.0	5499 10.320
5.550		6.0	97.0	57.0	36.0	5499 5.550	10.400		12.0	155.0	106.0	45.0	5499 10.400
5.560	7/32	6.0	97.0	57.0	36.0	5499 5.560	10.500		12.0	155.0	106.0	45.0	5499 10.500
5.600		6.0	97.0	57.0	36.0	5499 5.600	10.600		12.0	155.0	106.0	45.0	5499 10.600
5.700		6.0	97.0	57.0	36.0	5499 5.700	10.700		12.0	155.0	106.0	45.0	5499 10.700
5.800		6.0	97.0	57.0	36.0	5499 5.800	10.720	27/64	12.0	155.0	106.0	45.0	5499 10.720
5.900		6.0	97.0	57.0	36.0	5499 5.900	10.800		12.0	155.0	106.0	45.0	5499 10.800
5.950	15/64	6.0	97.0	57.0	36.0	5499 5.950	10.900		12.0	155.0	106.0	45.0	5499 10.900
6.000		6.0	97.0	57.0	36.0	5499 6.000	11.000		12.0	155.0	106.0	45.0	5499 11.000
6.100		8.0	106.0	66.0	36.0	5499 6.100	11.100		12.0	163.0	114.0	45.0	5499 11.100
6.200		8.0	106.0	66.0	36.0	5499 6.200	11.110	7/16	12.0	163.0	114.0	45.0	5499 11.110
6.300		8.0	106.0	66.0	36.0	5499 6.300	11.200		12.0	163.0	114.0	45.0	5499 11.200
6.350	1/4	8.0	106.0	66.0	36.0	5499 6.350	11.300		12.0	163.0	114.0	45.0	5499 11.300
6.400		8.0	106.0	66.0	36.0	5499 6.400	11.400		12.0	163.0	114.0	45.0	5499 11.400
6.500		8.0	106.0	66.0	36.0	5499 6.500	11.500		12.0	163.0	114.0	45.0	5499 11.500
6.530		8.0	106.0	66.0	36.0	5499 6.530	11.510	29/64	12.0	163.0	114.0	45.0	5499 11.510
6.550		8.0	106.0	66.0	36.0	5499 6.550	11.600		12.0	163.0	114.0	45.0	5499 11.600
6.600		8.0	106.0	66.0	36.0	5499 6.600	11.700		12.0	163.0	114.0	45.0	5499 11.700
6.700		8.0	106.0	66.0	36.0	5499 6.700	11.800		12.0	163.0	114.0	45.0	5499 11.800
6.750	17/64	8.0	106.0	66.0	36.0	5499 6.750	11.900		12.0	163.0	114.0	45.0	5499 11.900
6.800		8.0	106.0	66.0	36.0	5499 6.800	11.910	15/32	12.0	163.0	114.0	45.0	5499 11.910
6.900		8.0	116.0	76.0	36.0	5499 6.900	12.000		12.0	163.0	114.0	45.0	5499 12.000
7.000		8.0	116.0	76.0	36.0	5499 7.000	12.100		14.0	182.0	133.0	45.0	5499 12.100
7.100		8.0	116.0	76.0	36.0	5499 7.100	12.200		14.0	182.0	133.0	45.0	5499 12.200
7.140	9/32	8.0	116.0	76.0	36.0	5499 7.140	12.300	31/64	14.0	182.0	133.0	45.0	5499 12.300
7.200		8.0	116.0	76.0	36.0	5499 7.200	12.400		14.0	182.0	133.0	45.0	5499 12.400
7.300		8.0	116.0	76.0	36.0	5499 7.300	12.500		14.0	182.0	133.0	45.0	5499 12.500
7.400		8.0	116.0	76.0	36.0	5499 7.400	12.600		14.0	182.0	133.0	45.0	5499 12.600
7.500		8.0	116.0	76.0	36.0	5499 7.500	12.700	1/2	14.0	182.0	133.0	45.0	5499 12.700
7.540	19/64	8.0	116.0	76.0	36.0	5499 7.540	12.800		14.0	182.0	133.0	45.0	5499 12.800



Article no. 5499						Article no. 5499							
d1 mm	inch	d2 h6 mm	l1 mm	l2 mm	l3 mm	Order no.	d1 mm	inch	d2 h6 mm	l1 mm	l2 mm	l3 mm	Order no.
12.900		14.0	182.0	133.0	45.0	5499 12.900	16.300		18.0	223.0	171.0	48.0	5499 16.300
13.000		14.0	182.0	133.0	45.0	5499 13.000	16.500		18.0	223.0	171.0	48.0	5499 16.500
13.100	33/64	14.0	182.0	133.0	45.0	5499 13.100	16.700		18.0	223.0	171.0	48.0	5499 16.700
13.490	17/32	14.0	182.0	133.0	45.0	5499 13.490	16.900		18.0	223.0	171.0	48.0	5499 16.900
13.500		14.0	182.0	133.0	45.0	5499 13.500	17.000		18.0	223.0	171.0	48.0	5499 17.000
13.700		14.0	182.0	133.0	45.0	5499 13.700	17.500		18.0	223.0	171.0	48.0	5499 17.500
13.890	35/64	14.0	182.0	133.0	45.0	5499 13.890	17.700		18.0	223.0	171.0	48.0	5499 17.700
14.000		14.0	182.0	133.0	45.0	5499 14.000	18.000		18.0	223.0	171.0	48.0	5499 18.000
14.100		16.0	204.0	152.0	48.0	5499 14.100	18.500		20.0	244.0	190.0	50.0	5499 18.500
14.200		16.0	204.0	152.0	48.0	5499 14.200	18.900		20.0	244.0	190.0	50.0	5499 18.900
14.290	9/16	16.0	204.0	152.0	48.0	5499 14.290	19.000		20.0	244.0	190.0	50.0	5499 19.000
14.300		16.0	204.0	152.0	48.0	5499 14.300	19.050	3/4	20.0	244.0	190.0	50.0	5499 19.050
14.500		16.0	204.0	152.0	48.0	5499 14.500	19.500		20.0	244.0	190.0	50.0	5499 19.500
14.700		16.0	204.0	152.0	48.0	5499 14.700	19.800		20.0	244.0	190.0	50.0	5499 19.800
14.800		16.0	204.0	152.0	48.0	5499 14.800	20.000		20.0	244.0	190.0	50.0	5499 20.000
15.000		16.0	204.0	152.0	48.0	5499 15.000							
15.100		16.0	204.0	152.0	48.0	5499 15.100							
15.300		16.0	204.0	152.0	48.0	5499 15.300							
15.480	39/64	16.0	204.0	152.0	48.0	5499 15.480							
15.500		16.0	204.0	152.0	48.0	5499 15.500							
15.700		16.0	204.0	152.0	48.0	5499 15.700							
15.800		16.0	204.0	152.0	48.0	5499 15.800							
15.870	5/8	16.0	204.0	152.0	48.0	5499 15.870							
16.000		16.0	204.0	152.0	48.0	5499 16.000							



Ratio drills with coolant ducts

Article no. **6502**



Cutting data page 411



Web thinning $\geq \varnothing 4.000$ • patented radius point grind • main cutting edge form straight (after correction)

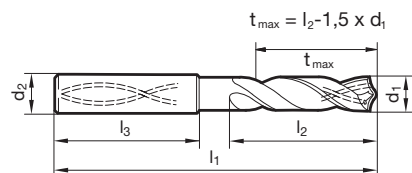

Article no. **6502**

Article no. **6502**

d1 mm	inch	d2 h6 mm	l1 mm	l2 mm	l3 mm	Order no.	d1 mm	inch	d2 h6 mm	l1 mm	l2 mm	l3 mm	Order no.
4.000		6.0	75.0	37.5	36.0	6502 4.000	9.130	23/64	10.0	139.0	95.0	40.0	6502 9.130
4.100		6.0	75.0	37.5	36.0	6502 4.100	9.200		10.0	139.0	95.0	40.0	6502 9.200
4.200		6.0	75.0	37.5	36.0	6502 4.200	9.250		10.0	139.0	95.0	40.0	6502 9.250
4.300		6.0	85.0	45.0	36.0	6502 4.300	9.300		10.0	139.0	95.0	40.0	6502 9.300
4.370	11/64	6.0	85.0	45.0	36.0	6502 4.370	9.400		10.0	139.0	95.0	40.0	6502 9.400
4.400		6.0	85.0	45.0	36.0	6502 4.400	9.500		10.0	139.0	95.0	40.0	6502 9.500
4.500		6.0	85.0	45.0	36.0	6502 4.500	9.520	3/8	10.0	139.0	95.0	40.0	6502 9.520
4.600		6.0	85.0	45.0	36.0	6502 4.600	9.600		10.0	139.0	95.0	40.0	6502 9.600
4.650		6.0	85.0	45.0	36.0	6502 4.650	9.700		10.0	139.0	95.0	40.0	6502 9.700
4.700		6.0	85.0	45.0	36.0	6502 4.700	9.800		10.0	139.0	95.0	40.0	6502 9.800
4.760	3/16	6.0	90.0	50.0	36.0	6502 4.760	9.900		10.0	139.0	95.0	40.0	6502 9.900
4.800		6.0	90.0	50.0	36.0	6502 4.800	9.920	25/64	10.0	139.0	95.0	40.0	6502 9.920
4.900		6.0	90.0	50.0	36.0	6502 4.900	10.000		10.0	139.0	95.0	40.0	6502 10.000
5.000		6.0	90.0	50.0	36.0	6502 5.000	10.100		12.0	155.0	106.0	45.0	6502 10.100
5.100		6.0	90.0	50.0	36.0	6502 5.100	10.200		12.0	155.0	106.0	45.0	6502 10.200
5.160	13/64	6.0	90.0	50.0	36.0	6502 5.160	10.300		12.0	155.0	106.0	45.0	6502 10.300
5.200		6.0	90.0	50.0	36.0	6502 5.200	10.320	13/32	12.0	155.0	106.0	45.0	6502 10.320
5.300		6.0	90.0	50.0	36.0	6502 5.300	10.400		12.0	155.0	106.0	45.0	6502 10.400
5.400		6.0	97.0	57.0	36.0	6502 5.400	10.500		12.0	155.0	106.0	45.0	6502 10.500
5.500		6.0	97.0	57.0	36.0	6502 5.500	10.600		12.0	155.0	106.0	45.0	6502 10.600
5.550		6.0	97.0	57.0	36.0	6502 5.550	10.700		12.0	155.0	106.0	45.0	6502 10.700
5.560	7/32	6.0	97.0	57.0	36.0	6502 5.560	10.720	27/64	12.0	155.0	106.0	45.0	6502 10.720
5.600		6.0	97.0	57.0	36.0	6502 5.600	10.800		12.0	155.0	106.0	45.0	6502 10.800
5.700		6.0	97.0	57.0	36.0	6502 5.700	10.900		12.0	155.0	106.0	45.0	6502 10.900
5.800		6.0	97.0	57.0	36.0	6502 5.800	11.000		12.0	155.0	106.0	45.0	6502 11.000
5.900		6.0	97.0	57.0	36.0	6502 5.900	11.100		12.0	163.0	114.0	45.0	6502 11.100
5.950	15/64	6.0	97.0	57.0	36.0	6502 5.950	11.110	7/16	12.0	163.0	114.0	45.0	6502 11.110
6.000		6.0	97.0	57.0	36.0	6502 6.000	11.200		12.0	163.0	114.0	45.0	6502 11.200
6.100		8.0	106.0	66.0	36.0	6502 6.100	11.300		12.0	163.0	114.0	45.0	6502 11.300
6.200		8.0	106.0	66.0	36.0	6502 6.200	11.400		12.0	163.0	114.0	45.0	6502 11.400
6.300		8.0	106.0	66.0	36.0	6502 6.300	11.500		12.0	163.0	114.0	45.0	6502 11.500
6.350	1/4	8.0	106.0	66.0	36.0	6502 6.350	11.600		12.0	163.0	114.0	45.0	6502 11.600
6.400		8.0	106.0	66.0	36.0	6502 6.400	11.700		12.0	163.0	114.0	45.0	6502 11.700
6.500		8.0	106.0	66.0	36.0	6502 6.500	11.800		12.0	163.0	114.0	45.0	6502 11.800
6.600		8.0	106.0	66.0	36.0	6502 6.600	11.900		12.0	163.0	114.0	45.0	6502 11.900
6.700		8.0	106.0	66.0	36.0	6502 6.700	11.910	15/32	12.0	163.0	114.0	45.0	6502 11.910
6.750	17/64	8.0	106.0	66.0	36.0	6502 6.750	12.000		12.0	163.0	114.0	45.0	6502 12.000
6.800		8.0	106.0	66.0	36.0	6502 6.800	12.100		14.0	182.0	133.0	45.0	6502 12.100
6.900		8.0	116.0	76.0	36.0	6502 6.900	12.200		14.0	182.0	133.0	45.0	6502 12.200
7.000		8.0	116.0	76.0	36.0	6502 7.000	12.300	31/64	14.0	182.0	133.0	45.0	6502 12.300
7.100		8.0	116.0	76.0	36.0	6502 7.100	12.400		14.0	182.0	133.0	45.0	6502 12.400
7.140	9/32	8.0	116.0	76.0	36.0	6502 7.140	12.500		14.0	182.0	133.0	45.0	6502 12.500
7.200		8.0	116.0	76.0	36.0	6502 7.200	12.600		14.0	182.0	133.0	45.0	6502 12.600
7.300		8.0	116.0	76.0	36.0	6502 7.300	12.700	1/2	14.0	182.0	133.0	45.0	6502 12.700
7.400		8.0	116.0	76.0	36.0	6502 7.400	12.800		14.0	182.0	133.0	45.0	6502 12.800
7.500		8.0	116.0	76.0	36.0	6502 7.500	12.900		14.0	182.0	133.0	45.0	6502 12.900
7.540	19/64	8.0	116.0	76.0	36.0	6502 7.540	13.000		14.0	182.0	133.0	45.0	6502 13.000
7.600		8.0	116.0	76.0	36.0	6502 7.600	13.100	33/64	14.0	182.0	133.0	45.0	6502 13.100
7.700		8.0	116.0	76.0	36.0	6502 7.700	13.300		14.0	182.0	133.0	45.0	6502 13.300
7.800		8.0	116.0	76.0	36.0	6502 7.800	13.400		14.0	182.0	133.0	45.0	6502 13.400
7.900		8.0	116.0	76.0	36.0	6502 7.900	13.500		14.0	182.0	133.0	45.0	6502 13.500
7.940	5/16	8.0	116.0	76.0	36.0	6502 7.940	13.700		14.0	182.0	133.0	45.0	6502 13.700
8.000		8.0	116.0	76.0	36.0	6502 8.000	13.800		14.0	182.0	133.0	45.0	6502 13.800
8.100		10.0	131.0	87.0	40.0	6502 8.100	13.900		14.0	182.0	133.0	45.0	6502 13.900
8.200		10.0	131.0	87.0	40.0	6502 8.200	14.000		14.0	182.0	133.0	45.0	6502 14.000
8.300		10.0	131.0	87.0	40.0	6502 8.300	14.100		16.0	204.0	152.0	48.0	6502 14.100
8.330	21/64	10.0	131.0	87.0	40.0	6502 8.330	14.200		16.0	204.0	152.0	48.0	6502 14.200
8.400		10.0	131.0	87.0	40.0	6502 8.400	14.290	9/16	16.0	204.0	152.0	48.0	6502 14.290
8.500		10.0	131.0	87.0	40.0	6502 8.500	14.300		16.0	204.0	152.0	48.0	6502 14.300
8.600		10.0	131.0	87.0	40.0	6502 8.600	14.400		16.0	204.0	152.0	48.0	6502 14.400
8.700		10.0	131.0	87.0	40.0	6502 8.700	14.500		16.0	204.0	152.0	48.0	6502 14.500
8.730	11/32	10.0	131.0	87.0	40.0	6502 8.730	14.600		16.0	204.0	152.0	48.0	6502 14.600
8.800		10.0	131.0	87.0	40.0	6502 8.800	14.700		16.0	204.0	152.0	48.0	6502 14.700
8.900		10.0	131.0	87.0	40.0	6502 8.900	14.900		16.0	204.0	152.0	48.0	6502 14.900
9.000		10.0	131.0	87.0	40.0	6502 9.000	15.000		16.0	204.0	152.0	48.0	6502 15.000
9.100		10.0	139.0	95.0	40.0	6502 9.100	15.100		16.0	204.0	152.0	48.0	6502 15.100



Article no.						6502	Article no.						6502
d1 mm	inch	d2 h6 mm	l1 mm	l2 mm	l3 mm	Order no.	d1 mm	inch	d2 h6 mm	l1 mm	l2 mm	l3 mm	Order no.
15.200		16.0	204.0	152.0	48.0	6502 15.200	17.000		18.0	223.0	171.0	48.0	6502 17.000
15.300		16.0	204.0	152.0	48.0	6502 15.300	17.500		18.0	223.0	171.0	48.0	6502 17.500
15.400		16.0	204.0	152.0	48.0	6502 15.400	18.000		18.0	223.0	171.0	48.0	6502 18.000
15.500		16.0	204.0	152.0	48.0	6502 15.500	18.500		20.0	244.0	190.0	50.0	6502 18.500
15.600		16.0	204.0	152.0	48.0	6502 15.600	19.000		20.0	244.0	190.0	50.0	6502 19.000
15.700		16.0	204.0	152.0	48.0	6502 15.700	19.500		20.0	244.0	190.0	50.0	6502 19.500
15.800		16.0	204.0	152.0	48.0	6502 15.800	20.000		20.0	244.0	190.0	50.0	6502 20.000
15.870	5/8	16.0	204.0	152.0	48.0	6502 15.870							
15.900		16.0	204.0	152.0	48.0	6502 15.900							
16.000		16.0	204.0	152.0	48.0	6502 16.000							
16.500		18.0	223.0	171.0	48.0	6502 16.500							
16.670	21/32	18.0	223.0	171.0	48.0	6502 16.670							



Ratio drills with coolant ducts

Article no. **769**



Cutting data page 413

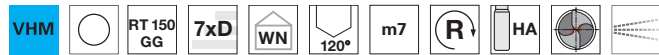

P	M	K	N	S	H
		•	•		○

Web thinning $\geq \varnothing 3.000$ • relieved cone • close diameter tolerances • very good surface quality of hole • observe coolant pressure

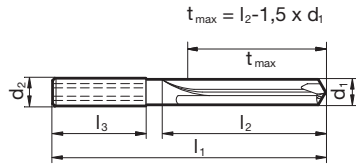

Article no. **769**

Article no. **769**

d1 mm	inch	d2 h6 mm	l1 mm	l2 mm	l3 mm	Order no.
3.000		6.0	74.0	32.0	36.0	769 3.000
3.100		6.0	74.0	32.0	36.0	769 3.100
3.200		6.0	74.0	32.0	36.0	769 3.200
3.300		6.0	74.0	32.0	36.0	769 3.300
3.400		6.0	74.0	34.0	36.0	769 3.400
3.500		6.0	74.0	34.0	36.0	769 3.500
3.600		6.0	74.0	34.0	36.0	769 3.600
3.700		6.0	74.0	34.0	36.0	769 3.700
3.800		6.0	97.0	45.0	36.0	769 3.800
3.900		6.0	97.0	45.0	36.0	769 3.900
4.000		6.0	97.0	45.0	36.0	769 4.000
4.100		6.0	97.0	45.0	36.0	769 4.100
4.200		6.0	97.0	45.0	36.0	769 4.200
4.300		6.0	97.0	45.0	36.0	769 4.300
4.400		6.0	97.0	45.0	36.0	769 4.400
4.500		6.0	97.0	45.0	36.0	769 4.500
4.700		6.0	97.0	45.0	36.0	769 4.700
4.800		6.0	97.0	57.0	36.0	769 4.800
4.900		6.0	97.0	57.0	36.0	769 4.900
5.000		6.0	97.0	57.0	36.0	769 5.000
5.160	13/64	6.0	97.0	57.0	36.0	769 5.160
5.500		6.0	97.0	57.0	36.0	769 5.500
6.000		6.0	97.0	57.0	36.0	769 6.000
6.350	1/4	8.0	116.0	76.0	36.0	769 6.350
6.500		8.0	116.0	76.0	36.0	769 6.500
6.800		8.0	116.0	76.0	36.0	769 6.800
7.000		8.0	116.0	76.0	36.0	769 7.000
7.140	9/32	8.0	116.0	76.0	36.0	769 7.140
7.500		8.0	116.0	76.0	36.0	769 7.500
7.800		8.0	116.0	76.0	36.0	769 7.800
7.940	5/16	8.0	116.0	76.0	36.0	769 7.940
8.000		8.0	116.0	76.0	36.0	769 8.000
8.330	21/64	10.0	139.0	95.0	40.0	769 8.330
8.500		10.0	139.0	95.0	40.0	769 8.500
8.730	11/32	10.0	139.0	95.0	40.0	769 8.730
9.000		10.0	139.0	95.0	40.0	769 9.000

d1 mm	inch	d2 h6 mm	l1 mm	l2 mm	l3 mm	Order no.
9.130	23/64	10.0	139.0	95.0	40.0	769 9.130
9.500		10.0	139.0	95.0	40.0	769 9.500
9.520	3/8	10.0	139.0	95.0	40.0	769 9.520
10.000		10.0	139.0	95.0	40.0	769 10.000
10.200		12.0	163.0	114.0	45.0	769 10.200
10.320	13/32	12.0	163.0	114.0	45.0	769 10.320
10.500		12.0	163.0	114.0	45.0	769 10.500
10.720	27/64	12.0	163.0	114.0	45.0	769 10.720
11.000		12.0	163.0	114.0	45.0	769 11.000
11.110	7/16	12.0	163.0	114.0	45.0	769 11.110
11.500		12.0	163.0	114.0	45.0	769 11.500
11.510	29/64	12.0	163.0	114.0	45.0	769 11.510
12.000		12.0	163.0	114.0	45.0	769 12.000
12.300	31/64	14.0	182.0	133.0	45.0	769 12.300
12.500		14.0	182.0	133.0	45.0	769 12.500
12.700	1/2	14.0	182.0	133.0	45.0	769 12.700
13.000		14.0	182.0	133.0	45.0	769 13.000
13.500		14.0	182.0	133.0	45.0	769 13.500
14.000		14.0	182.0	133.0	45.0	769 14.000
14.500		16.0	204.0	152.0	48.0	769 14.500
15.000		16.0	204.0	152.0	48.0	769 15.000
15.500		16.0	204.0	152.0	48.0	769 15.500
16.000		16.0	204.0	152.0	48.0	769 16.000
16.500		18.0	223.0	171.0	48.0	769 16.500
17.000		18.0	223.0	171.0	48.0	769 17.000
17.500		18.0	223.0	171.0	48.0	769 17.500
18.000		18.0	223.0	171.0	48.0	769 18.000
18.500		20.0	244.0	190.0	50.0	769 18.500
19.000		20.0	244.0	190.0	50.0	769 19.000
19.500		20.0	244.0	190.0	50.0	769 19.500
20.000		20.0	244.0	190.0	50.0	769 20.000



Ratio drills with coolant ducts

Article no. 6069



Cutting data page 416

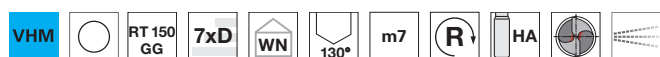

P	M	K	N	S	H
		•	•		○

Web thinning ≥ Ø 3.000 • facet point grind • close diameter tolerances • very good surface quality of hole • observe optimal coolant pressure

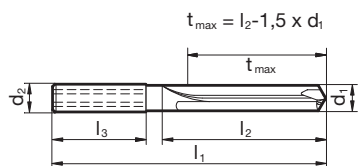

Article no. 6069

Article no. 6069

d1 mm	inch	d2 h6 mm	l1 mm	l2 mm	l3 mm	Order no.	d1 mm	inch	d2 h6 mm	l1 mm	l2 mm	l3 mm	Order no.
3.000		6.0	74.0	32.0	36.0	6069 3.000	9.130	23/64	10.0	139.0	95.0	40.0	6069 9.130
3.100		6.0	74.0	32.0	36.0	6069 3.100	9.500		10.0	139.0	95.0	40.0	6069 9.500
3.200		6.0	74.0	32.0	36.0	6069 3.200	9.520	3/8	10.0	139.0	95.0	40.0	6069 9.520
3.300		6.0	74.0	32.0	36.0	6069 3.300	10.000		10.0	139.0	95.0	40.0	6069 10.000
3.400		6.0	74.0	34.0	36.0	6069 3.400	10.200		12.0	163.0	114.0	45.0	6069 10.200
3.500		6.0	74.0	34.0	36.0	6069 3.500	10.320	13/32	12.0	163.0	114.0	45.0	6069 10.320
3.600		6.0	74.0	34.0	36.0	6069 3.600	10.500		12.0	163.0	114.0	45.0	6069 10.500
3.700		6.0	74.0	34.0	36.0	6069 3.700	10.720	27/64	12.0	163.0	114.0	45.0	6069 10.720
3.800		6.0	97.0	45.0	36.0	6069 3.800	11.000		12.0	163.0	114.0	45.0	6069 11.000
3.900		6.0	97.0	45.0	36.0	6069 3.900	11.110	7/16	12.0	163.0	114.0	45.0	6069 11.110
4.000		6.0	97.0	45.0	36.0	6069 4.000	11.500		12.0	163.0	114.0	45.0	6069 11.500
4.100		6.0	97.0	45.0	36.0	6069 4.100	11.510	29/64	12.0	163.0	114.0	45.0	6069 11.510
4.200		6.0	97.0	45.0	36.0	6069 4.200	12.000		12.0	163.0	114.0	45.0	6069 12.000
4.300		6.0	97.0	45.0	36.0	6069 4.300	12.300	31/64	14.0	182.0	133.0	45.0	6069 12.300
4.400		6.0	97.0	45.0	36.0	6069 4.400	12.500		14.0	182.0	133.0	45.0	6069 12.500
4.500		6.0	97.0	45.0	36.0	6069 4.500	12.700	1/2	14.0	182.0	133.0	45.0	6069 12.700
4.700		6.0	97.0	45.0	36.0	6069 4.700	13.000		14.0	182.0	133.0	45.0	6069 13.000
4.800		6.0	97.0	57.0	36.0	6069 4.800	13.500		14.0	182.0	133.0	45.0	6069 13.500
4.900		6.0	97.0	57.0	36.0	6069 4.900	14.000		14.0	182.0	133.0	45.0	6069 14.000
5.000		6.0	97.0	57.0	36.0	6069 5.000	14.500		16.0	204.0	152.0	48.0	6069 14.500
5.160	13/64	6.0	97.0	57.0	36.0	6069 5.160	15.000		16.0	204.0	152.0	48.0	6069 15.000
5.500		6.0	97.0	57.0	36.0	6069 5.500	15.500		16.0	204.0	152.0	48.0	6069 15.500
6.000		6.0	97.0	57.0	36.0	6069 6.000	16.000		16.0	204.0	152.0	48.0	6069 16.000
6.350	1/4	8.0	116.0	76.0	36.0	6069 6.350	16.500		18.0	223.0	171.0	48.0	6069 16.500
6.500		8.0	116.0	76.0	36.0	6069 6.500	17.000		18.0	223.0	171.0	48.0	6069 17.000
6.800		8.0	116.0	76.0	36.0	6069 6.800	17.500		18.0	223.0	171.0	48.0	6069 17.500
7.000		8.0	116.0	76.0	36.0	6069 7.000	18.000		18.0	223.0	171.0	48.0	6069 18.000
7.140	9/32	8.0	116.0	76.0	36.0	6069 7.140	18.500		20.0	244.0	190.0	50.0	6069 18.500
7.500		8.0	116.0	76.0	36.0	6069 7.500	19.000		20.0	244.0	190.0	50.0	6069 19.000
7.800		8.0	116.0	76.0	36.0	6069 7.800	19.500		20.0	244.0	190.0	50.0	6069 19.500
7.940	5/16	8.0	116.0	76.0	36.0	6069 7.940	20.000		20.0	244.0	190.0	50.0	6069 20.000
8.000		8.0	116.0	76.0	36.0	6069 8.000							
8.330	21/64	10.0	139.0	95.0	40.0	6069 8.330							
8.500		10.0	139.0	95.0	40.0	6069 8.500							
8.730	11/32	10.0	139.0	95.0	40.0	6069 8.730							
9.000		10.0	139.0	95.0	40.0	6069 9.000							



Ratio drills with coolant ducts

Article no. **770**



Cutting data page 414

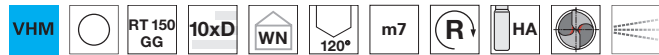

Web thinning $\geq \varnothing 3.000$ • relieved cone • close diameter tolerances • very good surface quality of hole • observe coolant pressure

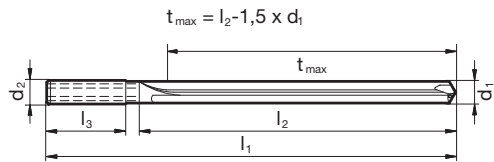

Article no.

770

Article no.

770

d1 mm	inch	d2 h6 mm	l1 mm	l2 mm	l3 mm	Order no.
3.000		6.0	91.0	42.0	36.0	770 3.000
3.100		6.0	91.0	42.0	36.0	770 3.100
3.200		6.0	91.0	42.0	36.0	770 3.200
3.300		6.0	91.0	42.0	36.0	770 3.300
3.400		6.0	91.0	48.0	36.0	770 3.400
3.500		6.0	91.0	48.0	36.0	770 3.500
3.600		6.0	91.0	48.0	36.0	770 3.600
3.700		6.0	91.0	48.0	36.0	770 3.700
3.800		6.0	121.0	77.0	36.0	770 3.800
3.900		6.0	121.0	77.0	36.0	770 3.900
4.000		6.0	121.0	77.0	36.0	770 4.000
4.100		6.0	121.0	77.0	36.0	770 4.100
4.200		6.0	121.0	77.0	36.0	770 4.200
4.300		6.0	121.0	77.0	36.0	770 4.300
4.400		6.0	121.0	77.0	36.0	770 4.400
4.500		6.0	121.0	77.0	36.0	770 4.500
4.600		6.0	121.0	77.0	36.0	770 4.600
4.700		6.0	121.0	77.0	36.0	770 4.700
4.800		6.0	121.0	82.0	36.0	770 4.800
4.900		6.0	121.0	82.0	36.0	770 4.900
5.000		6.0	121.0	82.0	36.0	770 5.000
5.160	13/64	6.0	121.0	82.0	36.0	770 5.160
5.500		6.0	121.0	82.0	36.0	770 5.500
5.560	7/32	6.0	121.0	82.0	36.0	770 5.560
5.950	15/64	6.0	121.0	82.0	36.0	770 5.950
6.000		6.0	121.0	82.0	36.0	770 6.000
6.350	1/4	8.0	146.0	106.0	36.0	770 6.350
6.500		8.0	146.0	106.0	36.0	770 6.500
6.750	17/64	8.0	146.0	106.0	36.0	770 6.750
6.800		8.0	146.0	106.0	36.0	770 6.800
7.000		8.0	146.0	106.0	36.0	770 7.000
7.140	9/32	8.0	146.0	106.0	36.0	770 7.140
7.500		8.0	146.0	106.0	36.0	770 7.500
7.540	19/64	8.0	146.0	106.0	36.0	770 7.540
7.800		8.0	146.0	106.0	36.0	770 7.800
7.940	5/16	8.0	146.0	106.0	36.0	770 7.940
8.000		8.0	146.0	106.0	36.0	770 8.000
8.330	21/64	10.0	175.0	130.0	40.0	770 8.330
8.500		10.0	175.0	130.0	40.0	770 8.500
8.730	11/32	10.0	175.0	130.0	40.0	770 8.730
9.000		10.0	175.0	130.0	40.0	770 9.000
9.130	23/64	10.0	175.0	130.0	40.0	770 9.130

d1 mm	inch	d2 h6 mm	l1 mm	l2 mm	l3 mm	Order no.
9.500		10.0	175.0	130.0	40.0	770 9.500
9.520	3/8	10.0	175.0	130.0	40.0	770 9.520
9.920	25/64	10.0	175.0	130.0	40.0	770 9.920
10.000		10.0	175.0	130.0	40.0	770 10.000
10.200		12.0	209.0	159.0	45.0	770 10.200
10.320	13/32	12.0	209.0	159.0	45.0	770 10.320
10.500		12.0	209.0	159.0	45.0	770 10.500
10.720	27/64	12.0	209.0	159.0	45.0	770 10.720
11.000		12.0	209.0	159.0	45.0	770 11.000
11.110	7/16	12.0	209.0	159.0	45.0	770 11.110
11.500		12.0	209.0	159.0	45.0	770 11.500
11.510	29/64	12.0	209.0	159.0	45.0	770 11.510
11.910	15/32	12.0	209.0	159.0	45.0	770 11.910
12.000		12.0	209.0	159.0	45.0	770 12.000
12.300	31/64	14.0	233.0	183.0	45.0	770 12.300
12.500		14.0	233.0	183.0	45.0	770 12.500
12.700	1/2	14.0	233.0	183.0	45.0	770 12.700
13.000		14.0	233.0	183.0	45.0	770 13.000
13.500		14.0	233.0	183.0	45.0	770 13.500
14.000		14.0	233.0	183.0	45.0	770 14.000
14.500		16.0	260.0	207.0	48.0	770 14.500
15.000		16.0	260.0	207.0	48.0	770 15.000
15.500		16.0	260.0	207.0	48.0	770 15.500
16.000		16.0	260.0	207.0	48.0	770 16.000
16.500		18.0	284.0	231.0	48.0	770 16.500
17.000		18.0	284.0	231.0	48.0	770 17.000
17.500		18.0	284.0	231.0	48.0	770 17.500
18.000		18.0	284.0	231.0	48.0	770 18.000
18.500		20.0	308.0	255.0	50.0	770 18.500
19.000		20.0	308.0	255.0	50.0	770 19.000
19.500		20.0	308.0	255.0	50.0	770 19.500
20.000		20.0	308.0	255.0	50.0	770 20.000



Ratio drills with coolant ducts

Article no. 6070



Cutting data page 417

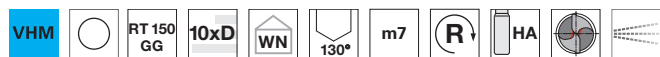

P	M	K	N	S	H
		•	•		○

Web thinning $\geq \varnothing 3.000$ • facet point grind • close diameter tolerances • very good surface quality of hole • observe optimal coolant pressure

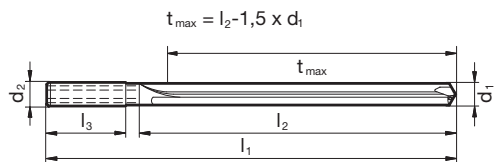

Article no.

6070

Article no.

6070

d1 mm	inch	d2 h6 mm	l1 mm	l2 mm	l3 mm	Order no.	d1 mm	inch	d2 h6 mm	l1 mm	l2 mm	l3 mm	Order no.
3.000		6.0	91.0	42.0	36.0	6070 3.000	9.130	23/64	10.0	175.0	130.0	40.0	6070 9.130
3.100		6.0	91.0	42.0	36.0	6070 3.100	9.500		10.0	175.0	130.0	40.0	6070 9.500
3.200		6.0	91.0	42.0	36.0	6070 3.200	9.520	3/8	10.0	175.0	130.0	40.0	6070 9.520
3.300		6.0	91.0	42.0	36.0	6070 3.300	10.000		10.0	175.0	130.0	40.0	6070 10.000
3.400		6.0	91.0	48.0	36.0	6070 3.400	10.200		12.0	209.0	159.0	45.0	6070 10.200
3.500		6.0	91.0	48.0	36.0	6070 3.500	10.320	13/32	12.0	209.0	159.0	45.0	6070 10.320
3.600		6.0	91.0	48.0	36.0	6070 3.600	10.500		12.0	209.0	159.0	45.0	6070 10.500
3.700		6.0	91.0	48.0	36.0	6070 3.700	10.720	27/64	12.0	209.0	159.0	45.0	6070 10.720
3.800		6.0	121.0	77.0	36.0	6070 3.800	11.000		12.0	209.0	159.0	45.0	6070 11.000
3.900		6.0	121.0	77.0	36.0	6070 3.900	11.110	7/16	12.0	209.0	159.0	45.0	6070 11.110
4.000		6.0	121.0	77.0	36.0	6070 4.000	11.500		12.0	209.0	159.0	45.0	6070 11.500
4.100		6.0	121.0	77.0	36.0	6070 4.100	11.510	29/64	12.0	209.0	159.0	45.0	6070 11.510
4.200		6.0	121.0	77.0	36.0	6070 4.200	12.000		12.0	209.0	159.0	45.0	6070 12.000
4.300		6.0	121.0	77.0	36.0	6070 4.300	12.300	31/64	14.0	233.0	183.0	45.0	6070 12.300
4.400		6.0	121.0	77.0	36.0	6070 4.400	12.500		14.0	233.0	183.0	45.0	6070 12.500
4.500		6.0	121.0	77.0	36.0	6070 4.500	12.700	1/2	14.0	233.0	183.0	45.0	6070 12.700
4.700		6.0	121.0	77.0	36.0	6070 4.700	13.000		14.0	233.0	183.0	45.0	6070 13.000
4.800		6.0	121.0	82.0	36.0	6070 4.800	13.500		14.0	233.0	183.0	45.0	6070 13.500
4.900		6.0	121.0	82.0	36.0	6070 4.900	14.000		14.0	233.0	183.0	45.0	6070 14.000
5.000		6.0	121.0	82.0	36.0	6070 5.000	14.500		16.0	260.0	207.0	48.0	6070 14.500
5.160	13/64	6.0	121.0	82.0	36.0	6070 5.160	15.000		16.0	260.0	207.0	48.0	6070 15.000
5.500		6.0	121.0	82.0	36.0	6070 5.500	15.500		16.0	260.0	207.0	48.0	6070 15.500
6.000		6.0	121.0	82.0	36.0	6070 6.000	16.000		16.0	260.0	207.0	48.0	6070 16.000
6.350	1/4	8.0	146.0	106.0	36.0	6070 6.350	16.500		18.0	284.0	231.0	48.0	6070 16.500
6.500		8.0	146.0	106.0	36.0	6070 6.500	17.000		18.0	284.0	231.0	48.0	6070 17.000
6.800		8.0	146.0	106.0	36.0	6070 6.800	17.500		18.0	284.0	231.0	48.0	6070 17.500
7.000		8.0	146.0	106.0	36.0	6070 7.000	18.000		18.0	284.0	231.0	48.0	6070 18.000
7.140	9/32	8.0	146.0	106.0	36.0	6070 7.140	18.500		20.0	308.0	255.0	50.0	6070 18.500
7.500		8.0	146.0	106.0	36.0	6070 7.500	19.000		20.0	308.0	255.0	50.0	6070 19.000
7.800		8.0	146.0	106.0	36.0	6070 7.800	19.500		20.0	308.0	255.0	50.0	6070 19.500
7.940	5/16	8.0	146.0	106.0	36.0	6070 7.940	20.000		20.0	308.0	255.0	50.0	6070 20.000
8.000		8.0	146.0	106.0	36.0	6070 8.000							
8.330	21/64	10.0	175.0	130.0	40.0	6070 8.330							
8.500		10.0	175.0	130.0	40.0	6070 8.500							
8.730	11/32	10.0	175.0	130.0	40.0	6070 8.730							
9.000		10.0	175.0	130.0	40.0	6070 9.000							



Solid carbide drills

Ratio drills with coolant ducts

Article no. **773**



Cutting data page 418

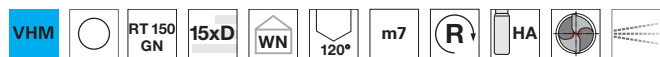

Web thinning $\geq \varnothing 5.000$ • relieved cone • negative helix • for holes with high alignment accuracy • very good surface quality of hole • observe coolant pressure

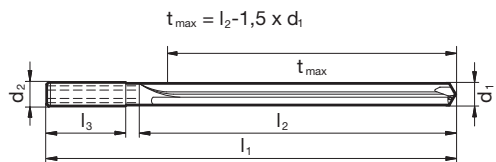

Article no. **773**

d1 mm	inch	d2 h6 mm	l1 mm	l2 mm	l3 mm	Order no.
5.000		6.0	145.0	105.0	36.0	773 5.000
6.000		6.0	145.0	105.0	36.0	773 6.000
8.000		8.0	180.0	137.0	36.0	773 8.000
9.000		10.0	217.0	170.0	40.0	773 9.000
10.000		10.0	217.0	170.0	40.0	773 10.000
11.000		12.0	258.0	205.0	45.0	773 11.000

Article no. **773**

d1 mm	inch	d2 h6 mm	l1 mm	l2 mm	l3 mm	Order no.
12.000		12.0	258.0	205.0	45.0	773 12.000
14.000		14.0	290.0	236.0	45.0	773 14.000



Ratio drills with coolant ducts

Article no. 5525



Cutting data page 403

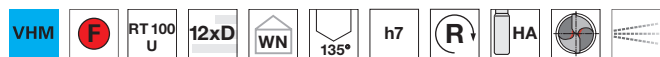

Web thinning ≥ Ø 3.000 • facet point grind • main cutting edge form straight • optimised cutting edge geometry

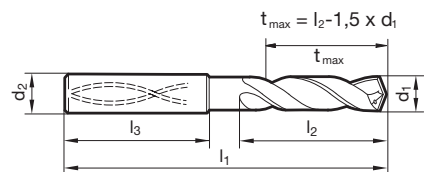

Article no. 5525

Article no. 5525

d1 mm	inch	d2 h6 mm	l1 mm	l2 mm	l3 mm	Order no.	d1 mm	inch	d2 h6 mm	l1 mm	l2 mm	l3 mm	Order no.
3.000		6.0	90.0	50.0	36.0	5525 3.000	8.100		10.0	162.0	120.0	40.0	5525 8.100
3.100		6.0	90.0	50.0	36.0	5525 3.100	8.200		10.0	162.0	120.0	40.0	5525 8.200
3.170	1/8	6.0	90.0	50.0	36.0	5525 3.170	8.300		10.0	162.0	120.0	40.0	5525 8.300
3.200		6.0	90.0	50.0	36.0	5525 3.200	8.330	21/64	10.0	162.0	120.0	40.0	5525 8.330
3.250		6.0	90.0	50.0	36.0	5525 3.250	8.400		10.0	162.0	120.0	40.0	5525 8.400
3.300		6.0	90.0	50.0	36.0	5525 3.300	8.500		10.0	162.0	120.0	40.0	5525 8.500
3.400		6.0	90.0	50.0	36.0	5525 3.400	8.600		10.0	162.0	120.0	40.0	5525 8.600
3.500		6.0	90.0	50.0	36.0	5525 3.500	8.700		10.0	162.0	120.0	40.0	5525 8.700
3.570	9/64	6.0	90.0	50.0	36.0	5525 3.570	8.730	11/32	10.0	162.0	120.0	40.0	5525 8.730
3.600		6.0	90.0	50.0	36.0	5525 3.600	8.800		10.0	162.0	120.0	40.0	5525 8.800
3.700		6.0	90.0	50.0	36.0	5525 3.700	8.900		10.0	162.0	120.0	40.0	5525 8.900
3.800		6.0	102.0	64.0	36.0	5525 3.800	9.000		10.0	162.0	120.0	40.0	5525 9.000
3.900		6.0	102.0	64.0	36.0	5525 3.900	9.100		10.0	162.0	120.0	40.0	5525 9.100
3.970	5/32	6.0	102.0	64.0	36.0	5525 3.970	9.130	23/64	10.0	162.0	120.0	40.0	5525 9.130
4.000		6.0	102.0	64.0	36.0	5525 4.000	9.200		10.0	162.0	120.0	40.0	5525 9.200
4.100		6.0	102.0	64.0	36.0	5525 4.100	9.250		10.0	162.0	120.0	40.0	5525 9.250
4.200		6.0	102.0	64.0	36.0	5525 4.200	9.300		10.0	162.0	120.0	40.0	5525 9.300
4.300		6.0	102.0	64.0	36.0	5525 4.300	9.400		10.0	162.0	120.0	40.0	5525 9.400
4.370	11/64	6.0	102.0	64.0	36.0	5525 4.370	9.500		10.0	162.0	120.0	40.0	5525 9.500
4.400		6.0	102.0	64.0	36.0	5525 4.400	9.520	3/8	10.0	162.0	120.0	40.0	5525 9.520
4.500		6.0	102.0	64.0	36.0	5525 4.500	9.600		10.0	162.0	120.0	40.0	5525 9.600
4.600		6.0	102.0	64.0	36.0	5525 4.600	9.700		10.0	162.0	120.0	40.0	5525 9.700
4.650		6.0	102.0	64.0	36.0	5525 4.650	9.800		10.0	162.0	120.0	40.0	5525 9.800
4.700		6.0	102.0	64.0	36.0	5525 4.700	9.900		10.0	162.0	120.0	40.0	5525 9.900
4.760	3/16	6.0	116.0	78.0	36.0	5525 4.760	9.920	25/64	10.0	162.0	120.0	40.0	5525 9.920
4.800		6.0	116.0	78.0	36.0	5525 4.800	10.000		10.0	162.0	120.0	40.0	5525 10.000
4.900		6.0	116.0	78.0	36.0	5525 4.900	10.100		12.0	204.0	156.0	45.0	5525 10.100
5.000		6.0	116.0	78.0	36.0	5525 5.000	10.200		12.0	204.0	156.0	45.0	5525 10.200
5.100		6.0	116.0	78.0	36.0	5525 5.100	10.300		12.0	204.0	156.0	45.0	5525 10.300
5.160	13/64	6.0	116.0	78.0	36.0	5525 5.160	10.320	13/32	12.0	204.0	156.0	45.0	5525 10.320
5.200		6.0	116.0	78.0	36.0	5525 5.200	10.500		12.0	204.0	156.0	45.0	5525 10.500
5.300		6.0	116.0	78.0	36.0	5525 5.300	10.600		12.0	204.0	156.0	45.0	5525 10.600
5.400		6.0	116.0	78.0	36.0	5525 5.400	10.700		12.0	204.0	156.0	45.0	5525 10.700
5.500		6.0	116.0	78.0	36.0	5525 5.500	10.720	27/64	12.0	204.0	156.0	45.0	5525 10.720
5.560	7/32	6.0	116.0	78.0	36.0	5525 5.560	10.800		12.0	204.0	156.0	45.0	5525 10.800
5.600		6.0	116.0	78.0	36.0	5525 5.600	10.900		12.0	204.0	156.0	45.0	5525 10.900
5.700		6.0	116.0	78.0	36.0	5525 5.700	11.000		12.0	204.0	156.0	45.0	5525 11.000
5.800		6.0	116.0	78.0	36.0	5525 5.800	11.110	7/16	12.0	204.0	156.0	45.0	5525 11.110
5.900		6.0	116.0	78.0	36.0	5525 5.900	11.500		12.0	204.0	156.0	45.0	5525 11.500
5.950	15/64	6.0	116.0	78.0	36.0	5525 5.950	11.510	29/64	12.0	204.0	156.0	45.0	5525 11.510
6.000		6.0	116.0	78.0	36.0	5525 6.000	11.910	15/32	12.0	204.0	156.0	45.0	5525 11.910
6.100		8.0	146.0	108.0	36.0	5525 6.100	12.000		12.0	204.0	156.0	45.0	5525 12.000
6.200		8.0	146.0	108.0	36.0	5525 6.200	12.300	31/64	14.0	230.0	182.0	45.0	5525 12.300
6.300		8.0	146.0	108.0	36.0	5525 6.300	12.500		14.0	230.0	182.0	45.0	5525 12.500
6.350	1/4	8.0	146.0	108.0	36.0	5525 6.350	12.700	1/2	14.0	230.0	182.0	45.0	5525 12.700
6.400		8.0	146.0	108.0	36.0	5525 6.400	13.000		14.0	230.0	182.0	45.0	5525 13.000
6.500		8.0	146.0	108.0	36.0	5525 6.500	13.490	17/32	14.0	230.0	182.0	45.0	5525 13.490
6.600		8.0	146.0	108.0	36.0	5525 6.600	13.500		14.0	230.0	182.0	45.0	5525 13.500
6.700		8.0	146.0	108.0	36.0	5525 6.700	13.890	35/64	14.0	230.0	182.0	45.0	5525 13.890
6.750	17/64	8.0	146.0	108.0	36.0	5525 6.750	14.000		14.0	230.0	182.0	45.0	5525 14.000
6.800		8.0	146.0	108.0	36.0	5525 6.800	14.500		16.0	260.0	208.0	48.0	5525 14.500
6.900		8.0	146.0	108.0	36.0	5525 6.900	15.000		16.0	260.0	208.0	48.0	5525 15.000
7.000		8.0	146.0	108.0	36.0	5525 7.000	15.480	39/64	16.0	260.0	208.0	48.0	5525 15.480
7.100		8.0	146.0	108.0	36.0	5525 7.100	15.500		16.0	260.0	208.0	48.0	5525 15.500
7.140	9/32	8.0	146.0	108.0	36.0	5525 7.140	16.000		16.0	260.0	208.0	48.0	5525 16.000
7.200		8.0	146.0	108.0	36.0	5525 7.200	16.500		18.0	285.0	234.0	48.0	5525 16.500
7.300		8.0	146.0	108.0	36.0	5525 7.300	17.000		18.0	285.0	234.0	48.0	5525 17.000
7.400		8.0	146.0	108.0	36.0	5525 7.400	17.500		18.0	285.0	234.0	48.0	5525 17.500
7.500		8.0	146.0	108.0	36.0	5525 7.500	18.000		18.0	285.0	234.0	48.0	5525 18.000
7.540	19/64	8.0	146.0	108.0	36.0	5525 7.540	18.500		20.0	310.0	258.0	50.0	5525 18.500
7.600		8.0	146.0	108.0	36.0	5525 7.600	19.000		20.0	310.0	258.0	50.0	5525 19.000
7.700		8.0	146.0	108.0	36.0	5525 7.700	19.050	3/4	20.0	310.0	258.0	50.0	5525 19.050
7.800		8.0	146.0	108.0	36.0	5525 7.800	19.500		20.0	310.0	258.0	50.0	5525 19.500
7.900		8.0	146.0	108.0	36.0	5525 7.900	20.000		20.0	310.0	258.0	50.0	5525 20.000
7.940	5/16	8.0	146.0	108.0	36.0	5525 7.940							
8.000		8.0	146.0	108.0	36.0	5525 8.000							



Ratio drills with coolant ducts

Article no. **6499**



Cutting data page 407

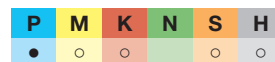
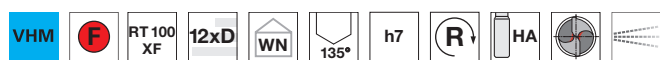

Web thinning $\geq \varnothing 3.000$ • relieved cone • main cutting edge form concave • optimised cutting edge geometry
• maximum performance • double margin

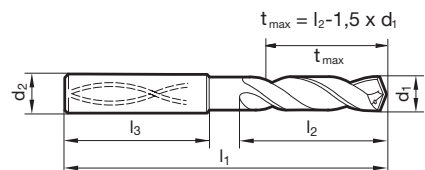

Article no. **6499**

Article no. **6499**

d1 mm	inch	d2 h6 mm	l1 mm	l2 mm	l3 mm	Order no.	d1 mm	inch	d2 h6 mm	l1 mm	l2 mm	l3 mm	Order no.
3.000		6.0	95.0	55.0	36.0	6499 3.000	7.550		8.0	158.0	118.0	36.0	6499 7.550
3.100		6.0	95.0	55.0	36.0	6499 3.100	7.600		8.0	158.0	118.0	36.0	6499 7.600
3.170	1/8	6.0	95.0	55.0	36.0	6499 3.170	7.650		8.0	158.0	118.0	36.0	6499 7.650
3.200		6.0	95.0	55.0	36.0	6499 3.200	7.700		8.0	158.0	118.0	36.0	6499 7.700
3.250		6.0	95.0	55.0	36.0	6499 3.250	7.800		8.0	158.0	118.0	36.0	6499 7.800
3.300		6.0	95.0	55.0	36.0	6499 3.300	7.900		8.0	158.0	118.0	36.0	6499 7.900
3.400		6.0	95.0	55.0	36.0	6499 3.400	7.940	5/16	8.0	158.0	118.0	36.0	6499 7.940
3.500		6.0	102.0	62.0	36.0	6499 3.500	8.000		8.0	158.0	118.0	36.0	6499 8.000
3.570	9/64	6.0	102.0	62.0	36.0	6499 3.570	8.100		10.0	190.0	146.0	40.0	6499 8.100
3.600		6.0	102.0	62.0	36.0	6499 3.600	8.200		10.0	190.0	146.0	40.0	6499 8.200
3.700		6.0	102.0	62.0	36.0	6499 3.700	8.300		10.0	190.0	146.0	40.0	6499 8.300
3.800		6.0	102.0	62.0	36.0	6499 3.800	8.330	21/64	10.0	190.0	146.0	40.0	6499 8.330
3.900		6.0	102.0	62.0	36.0	6499 3.900	8.400		10.0	190.0	146.0	40.0	6499 8.400
3.970	5/32	6.0	102.0	62.0	36.0	6499 3.970	8.500		10.0	190.0	146.0	40.0	6499 8.500
4.000		6.0	102.0	62.0	36.0	6499 4.000	8.600		10.0	190.0	146.0	40.0	6499 8.600
4.040		6.0	109.0	69.0	36.0	6499 4.040	8.700		10.0	190.0	146.0	40.0	6499 8.700
4.100		6.0	109.0	69.0	36.0	6499 4.100	8.730	11/32	10.0	190.0	146.0	40.0	6499 8.730
4.200		6.0	109.0	69.0	36.0	6499 4.200	8.800		10.0	190.0	146.0	40.0	6499 8.800
4.300		6.0	109.0	69.0	36.0	6499 4.300	8.900		10.0	190.0	146.0	40.0	6499 8.900
4.370	11/64	6.0	109.0	69.0	36.0	6499 4.370	9.000		10.0	190.0	146.0	40.0	6499 9.000
4.400		6.0	109.0	69.0	36.0	6499 4.400	9.100		10.0	190.0	146.0	40.0	6499 9.100
4.500		6.0	116.0	76.0	36.0	6499 4.500	9.130	23/64	10.0	190.0	146.0	40.0	6499 9.130
4.600		6.0	116.0	76.0	36.0	6499 4.600	9.200		10.0	190.0	146.0	40.0	6499 9.200
4.650		6.0	116.0	76.0	36.0	6499 4.650	9.250		10.0	190.0	146.0	40.0	6499 9.250
4.700		6.0	116.0	76.0	36.0	6499 4.700	9.300		10.0	190.0	146.0	40.0	6499 9.300
4.760	3/16	6.0	116.0	76.0	36.0	6499 4.760	9.340		10.0	190.0	146.0	40.0	6499 9.340
4.800		6.0	116.0	76.0	36.0	6499 4.800	9.400		10.0	190.0	146.0	40.0	6499 9.400
4.900		6.0	116.0	76.0	36.0	6499 4.900	9.500		10.0	190.0	146.0	40.0	6499 9.500
5.000		6.0	116.0	76.0	36.0	6499 5.000	9.520	3/8	10.0	190.0	146.0	40.0	6499 9.520
5.100		6.0	123.0	83.0	36.0	6499 5.100	9.550		10.0	190.0	146.0	40.0	6499 9.550
5.110		6.0	123.0	83.0	36.0	6499 5.110	9.600		10.0	190.0	146.0	40.0	6499 9.600
5.160	13/64	6.0	123.0	83.0	36.0	6499 5.160	9.700		10.0	190.0	146.0	40.0	6499 9.700
5.200		6.0	123.0	83.0	36.0	6499 5.200	9.800		10.0	190.0	146.0	40.0	6499 9.800
5.300		6.0	123.0	83.0	36.0	6499 5.300	9.900		10.0	190.0	146.0	40.0	6499 9.900
5.400		6.0	123.0	83.0	36.0	6499 5.400	9.920	25/64	10.0	190.0	146.0	40.0	6499 9.920
5.410		6.0	123.0	83.0	36.0	6499 5.410	10.000		10.0	190.0	146.0	40.0	6499 10.000
5.500		6.0	130.0	90.0	36.0	6499 5.500	10.100		12.0	223.0	174.0	45.0	6499 10.100
5.550		6.0	130.0	90.0	36.0	6499 5.550	10.200		12.0	223.0	174.0	45.0	6499 10.200
5.560	7/32	6.0	130.0	90.0	36.0	6499 5.560	10.300		12.0	223.0	174.0	45.0	6499 10.300
5.600		6.0	130.0	90.0	36.0	6499 5.600	10.320	13/32	12.0	223.0	174.0	45.0	6499 10.320
5.700		6.0	130.0	90.0	36.0	6499 5.700	10.400		12.0	223.0	174.0	45.0	6499 10.400
5.800		6.0	130.0	90.0	36.0	6499 5.800	10.500		12.0	223.0	174.0	45.0	6499 10.500
5.900		6.0	130.0	90.0	36.0	6499 5.900	10.600		12.0	223.0	174.0	45.0	6499 10.600
5.950	15/64	6.0	130.0	90.0	36.0	6499 5.950	10.700		12.0	223.0	174.0	45.0	6499 10.700
6.000		6.0	130.0	90.0	36.0	6499 6.000	10.720	27/64	12.0	223.0	174.0	45.0	6499 10.720
6.100		8.0	158.0	118.0	36.0	6499 6.100	10.800		12.0	223.0	174.0	45.0	6499 10.800
6.200		8.0	158.0	118.0	36.0	6499 6.200	10.900		12.0	223.0	174.0	45.0	6499 10.900
6.300		8.0	158.0	118.0	36.0	6499 6.300	11.000		12.0	223.0	174.0	45.0	6499 11.000
6.350	1/4	8.0	158.0	118.0	36.0	6499 6.350	11.100		12.0	223.0	174.0	45.0	6499 11.100
6.400		8.0	158.0	118.0	36.0	6499 6.400	11.110	7/16	12.0	223.0	174.0	45.0	6499 11.110
6.500		8.0	158.0	118.0	36.0	6499 6.500	11.200		12.0	223.0	174.0	45.0	6499 11.200
6.530		8.0	158.0	118.0	36.0	6499 6.530	11.300		12.0	223.0	174.0	45.0	6499 11.300
6.550		8.0	158.0	118.0	36.0	6499 6.550	11.400		12.0	223.0	174.0	45.0	6499 11.400
6.600		8.0	158.0	118.0	36.0	6499 6.600	11.500		12.0	223.0	174.0	45.0	6499 11.500
6.700		8.0	158.0	118.0	36.0	6499 6.700	11.510	29/64	12.0	223.0	174.0	45.0	6499 11.510
6.750	17/64	8.0	158.0	118.0	36.0	6499 6.750	11.550		12.0	223.0	174.0	45.0	6499 11.550
6.800		8.0	158.0	118.0	36.0	6499 6.800	11.600		12.0	223.0	174.0	45.0	6499 11.600
6.900		8.0	158.0	118.0	36.0	6499 6.900	11.700		12.0	223.0	174.0	45.0	6499 11.700
7.000		8.0	158.0	118.0	36.0	6499 7.000	11.800		12.0	223.0	174.0	45.0	6499 11.800
7.100		8.0	158.0	118.0	36.0	6499 7.100	11.900		12.0	223.0	174.0	45.0	6499 11.900
7.140	9/32	8.0	158.0	118.0	36.0	6499 7.140	11.910	15/32	12.0	223.0	174.0	45.0	6499 11.910
7.200		8.0	158.0	118.0	36.0	6499 7.200	12.000		12.0	223.0	174.0	45.0	6499 12.000
7.300		8.0	158.0	118.0	36.0	6499 7.300	12.100		14.0	251.0	202.0	45.0	6499 12.100
7.400		8.0	158.0	118.0	36.0	6499 7.400	12.200		14.0	251.0	202.0	45.0	6499 12.200
7.500		8.0	158.0	118.0	36.0	6499 7.500	12.300	31/64	14.0	251.0	202.0	45.0	6499 12.300
7.540	19/64	8.0	158.0	118.0	36.0	6499 7.540	12.400		14.0	251.0	202.0	45.0	6499 12.400



Article no. 6499						Article no. 6499							
d1 mm	inch	d2 h6 mm	l1 mm	l2 mm	l3 mm	Order no.	d1 mm	inch	d2 h6 mm	l1 mm	l2 mm	l3 mm	Order no.
12.500		14.0	251.0	202.0	45.0	6499 12.500	15.900		16.0	282.0	230.0	48.0	6499 15.900
12.600		14.0	251.0	202.0	45.0	6499 12.600	16.000		16.0	282.0	230.0	48.0	6499 16.000
12.700	1/2	14.0	251.0	202.0	45.0	6499 12.700	16.270	41/64	18.0	310.0	258.0	48.0	6499 16.270
12.800		14.0	251.0	202.0	45.0	6499 12.800	16.300		18.0	310.0	258.0	48.0	6499 16.300
12.900		14.0	251.0	202.0	45.0	6499 12.900	16.500		18.0	310.0	258.0	48.0	6499 16.500
13.000		14.0	251.0	202.0	45.0	6499 13.000	16.670	21/32	18.0	310.0	258.0	48.0	6499 16.670
13.100	33/64	14.0	251.0	202.0	45.0	6499 13.100	16.700		18.0	310.0	258.0	48.0	6499 16.700
13.200		14.0	251.0	202.0	45.0	6499 13.200	16.900		18.0	310.0	258.0	48.0	6499 16.900
13.300		14.0	251.0	202.0	45.0	6499 13.300	17.000		18.0	310.0	258.0	48.0	6499 17.000
13.400		14.0	251.0	202.0	45.0	6499 13.400	17.070	43/64	18.0	310.0	258.0	48.0	6499 17.070
13.490	17/32	14.0	251.0	202.0	45.0	6499 13.490	17.460	11/16	18.0	310.0	258.0	48.0	6499 17.460
13.500		14.0	251.0	202.0	45.0	6499 13.500	17.500		18.0	310.0	258.0	48.0	6499 17.500
13.600		14.0	251.0	202.0	45.0	6499 13.600	17.550		18.0	310.0	258.0	48.0	6499 17.550
13.700		14.0	251.0	202.0	45.0	6499 13.700	17.700		18.0	310.0	258.0	48.0	6499 17.700
13.800		14.0	251.0	202.0	45.0	6499 13.800	17.860	45/64	18.0	310.0	258.0	48.0	6499 17.860
13.890	35/64	14.0	251.0	202.0	45.0	6499 13.890	18.000		18.0	310.0	258.0	48.0	6499 18.000
13.900		14.0	251.0	202.0	45.0	6499 13.900	18.260	23/32	20.0	340.0	286.0	50.0	6499 18.260
14.000		14.0	251.0	202.0	45.0	6499 14.000	18.500		20.0	340.0	286.0	50.0	6499 18.500
14.100		16.0	282.0	230.0	48.0	6499 14.100	18.700		20.0	340.0	286.0	50.0	6499 18.700
14.200		16.0	282.0	230.0	48.0	6499 14.200	18.900		20.0	340.0	286.0	50.0	6499 18.900
14.290	9/16	16.0	282.0	230.0	48.0	6499 14.290	19.000		20.0	340.0	286.0	50.0	6499 19.000
14.300		16.0	282.0	230.0	48.0	6499 14.300	19.050	3/4	20.0	340.0	286.0	50.0	6499 19.050
14.400		16.0	282.0	230.0	48.0	6499 14.400	19.250		20.0	340.0	286.0	50.0	6499 19.250
14.500		16.0	282.0	230.0	48.0	6499 14.500	19.300		20.0	340.0	286.0	50.0	6499 19.300
14.600		16.0	282.0	230.0	48.0	6499 14.600	19.450	49/64	20.0	340.0	286.0	50.0	6499 19.450
14.680	37/64	16.0	282.0	230.0	48.0	6499 14.680	19.500		20.0	340.0	286.0	50.0	6499 19.500
14.700		16.0	282.0	230.0	48.0	6499 14.700	19.550		20.0	340.0	286.0	50.0	6499 19.550
14.800		16.0	282.0	230.0	48.0	6499 14.800	19.700		20.0	340.0	286.0	50.0	6499 19.700
14.900		16.0	282.0	230.0	48.0	6499 14.900	19.800		20.0	340.0	286.0	50.0	6499 19.800
15.000		16.0	282.0	230.0	48.0	6499 15.000	19.840	25/32	20.0	340.0	286.0	50.0	6499 19.840
15.080	19/32	16.0	282.0	230.0	48.0	6499 15.080	20.000		20.0	340.0	286.0	50.0	6499 20.000
15.100		16.0	282.0	230.0	48.0	6499 15.100							
15.200		16.0	282.0	230.0	48.0	6499 15.200							
15.300		16.0	282.0	230.0	48.0	6499 15.300							
15.400		16.0	282.0	230.0	48.0	6499 15.400							
15.480	39/64	16.0	282.0	230.0	48.0	6499 15.480							
15.500		16.0	282.0	230.0	48.0	6499 15.500							
15.550		16.0	282.0	230.0	48.0	6499 15.550							
15.600		16.0	282.0	230.0	48.0	6499 15.600							
15.700		16.0	282.0	230.0	48.0	6499 15.700							
15.800		16.0	282.0	230.0	48.0	6499 15.800							
15.870	5/8	16.0	282.0	230.0	48.0	6499 15.870							



Ratio drills with coolant ducts

Article no. **6515**



Cutting data page 419

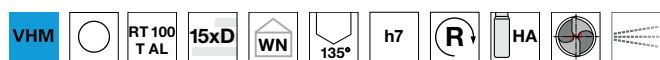

Web thinning $\geq \varnothing 3.000$ • facet point grind • main cutting edge form concave • optimised flute cross-section • maximum diameter of coolant ducts • observe coolant pressure • for piloting we recommend RT100 AI, art. no. 5768, or RT100 FB, art. no. 6596

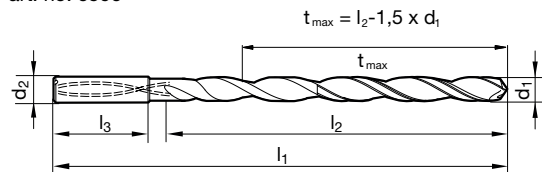

Article no. 6515						Article no. 6515							
d1	inch	d2 h6	l1	l2	l3	Order no.	d1	inch	d2 h6	l1	l2	l3	Order no.
mm		mm	mm	mm	mm		mm		mm	mm	mm	mm	
3.000		6.0	95.0	55.0	36.0	6515 3.000	8.000		8.0	183.0	143.0	36.0	6515 8.000
3.100		6.0	106.0	66.0	36.0	6515 3.100	8.100		10.0	204.0	160.0	40.0	6515 8.100
3.170	1/8	6.0	106.0	66.0	36.0	6515 3.170	8.200		10.0	204.0	160.0	40.0	6515 8.200
3.200		6.0	106.0	66.0	36.0	6515 3.200	8.300		10.0	204.0	160.0	40.0	6515 8.300
3.250		6.0	106.0	66.0	36.0	6515 3.250	8.330	21/64	10.0	204.0	160.0	40.0	6515 8.330
3.300		6.0	106.0	66.0	36.0	6515 3.300	8.400		10.0	204.0	160.0	40.0	6515 8.400
3.400		6.0	106.0	66.0	36.0	6515 3.400	8.500		10.0	204.0	160.0	40.0	6515 8.500
3.500		6.0	116.0	76.0	36.0	6515 3.500	8.600		10.0	204.0	160.0	40.0	6515 8.600
3.570	9/64	6.0	116.0	76.0	36.0	6515 3.570	8.700		10.0	204.0	160.0	40.0	6515 8.700
3.600		6.0	116.0	76.0	36.0	6515 3.600	8.730	11/32	10.0	204.0	160.0	40.0	6515 8.730
3.700		6.0	116.0	76.0	36.0	6515 3.700	8.800		10.0	204.0	160.0	40.0	6515 8.800
3.800		6.0	116.0	76.0	36.0	6515 3.800	8.900		10.0	204.0	160.0	40.0	6515 8.900
3.900		6.0	116.0	76.0	36.0	6515 3.900	9.000		10.0	204.0	160.0	40.0	6515 9.000
3.970	5/32	6.0	116.0	76.0	36.0	6515 3.970	9.100		10.0	221.0	177.0	40.0	6515 9.100
4.000		6.0	116.0	76.0	36.0	6515 4.000	9.130	23/64	10.0	221.0	177.0	40.0	6515 9.130
4.100		6.0	133.0	93.0	36.0	6515 4.100	9.200		10.0	221.0	177.0	40.0	6515 9.200
4.200		6.0	133.0	93.0	36.0	6515 4.200	9.250		10.0	221.0	177.0	40.0	6515 9.250
4.300		6.0	133.0	93.0	36.0	6515 4.300	9.300		10.0	221.0	177.0	40.0	6515 9.300
4.370	11/64	6.0	133.0	93.0	36.0	6515 4.370	9.340		10.0	221.0	177.0	40.0	6515 9.340
4.400		6.0	133.0	93.0	36.0	6515 4.400	9.400		10.0	221.0	177.0	40.0	6515 9.400
4.500		6.0	133.0	93.0	36.0	6515 4.500	9.500		10.0	221.0	177.0	40.0	6515 9.500
4.600		6.0	133.0	93.0	36.0	6515 4.600	9.520	3/8	10.0	221.0	177.0	40.0	6515 9.520
4.650		6.0	133.0	93.0	36.0	6515 4.650	9.600		10.0	221.0	177.0	40.0	6515 9.600
4.700		6.0	133.0	93.0	36.0	6515 4.700	9.700		10.0	221.0	177.0	40.0	6515 9.700
4.760	3/16	6.0	133.0	93.0	36.0	6515 4.760	9.800		10.0	221.0	177.0	40.0	6515 9.800
4.800		6.0	133.0	93.0	36.0	6515 4.800	9.900		10.0	221.0	177.0	40.0	6515 9.900
4.900		6.0	133.0	93.0	36.0	6515 4.900	9.920	25/64	10.0	221.0	177.0	40.0	6515 9.920
5.000		6.0	133.0	93.0	36.0	6515 5.000	10.000		10.0	221.0	177.0	40.0	6515 10.000
5.100		6.0	150.0	110.0	36.0	6515 5.100	10.100		12.0	247.0	198.0	45.0	6515 10.100
5.160	13/64	6.0	150.0	110.0	36.0	6515 5.160	10.200		12.0	247.0	198.0	45.0	6515 10.200
5.200		6.0	150.0	110.0	36.0	6515 5.200	10.300		12.0	247.0	198.0	45.0	6515 10.300
5.300		6.0	150.0	110.0	36.0	6515 5.300	10.320	13/32	12.0	247.0	198.0	45.0	6515 10.320
5.400		6.0	150.0	110.0	36.0	6515 5.400	10.400		12.0	247.0	198.0	45.0	6515 10.400
5.500		6.0	150.0	110.0	36.0	6515 5.500	10.500		12.0	247.0	198.0	45.0	6515 10.500
5.550		6.0	150.0	110.0	36.0	6515 5.550	10.600		12.0	247.0	198.0	45.0	6515 10.600
5.560	7/32	6.0	150.0	110.0	36.0	6515 5.560	10.700		12.0	247.0	198.0	45.0	6515 10.700
5.600		6.0	150.0	110.0	36.0	6515 5.600	10.800		12.0	247.0	198.0	45.0	6515 10.800
5.700		6.0	150.0	110.0	36.0	6515 5.700	10.900		12.0	247.0	198.0	45.0	6515 10.900
5.800		6.0	150.0	110.0	36.0	6515 5.800	11.000		12.0	247.0	198.0	45.0	6515 11.000
5.900		6.0	150.0	110.0	36.0	6515 5.900	11.100		12.0	263.0	214.0	45.0	6515 11.100
5.950	15/64	6.0	150.0	110.0	36.0	6515 5.950	11.110	7/16	12.0	263.0	214.0	45.0	6515 11.110
6.000		6.0	150.0	110.0	36.0	6515 6.000	11.200		12.0	263.0	214.0	45.0	6515 11.200
6.100		8.0	167.0	127.0	36.0	6515 6.100	11.300		12.0	263.0	214.0	45.0	6515 11.300
6.200		8.0	167.0	127.0	36.0	6515 6.200	11.400		12.0	263.0	214.0	45.0	6515 11.400
6.300		8.0	167.0	127.0	36.0	6515 6.300	11.500		12.0	263.0	214.0	45.0	6515 11.500
6.350	1/4	8.0	167.0	127.0	36.0	6515 6.350	11.600		12.0	263.0	214.0	45.0	6515 11.600
6.400		8.0	167.0	127.0	36.0	6515 6.400	11.700		12.0	263.0	214.0	45.0	6515 11.700
6.500		8.0	167.0	127.0	36.0	6515 6.500	11.800		12.0	263.0	214.0	45.0	6515 11.800
6.600		8.0	167.0	127.0	36.0	6515 6.600	11.900		12.0	263.0	214.0	45.0	6515 11.900
6.700		8.0	167.0	127.0	36.0	6515 6.700	11.910	15/32	12.0	263.0	214.0	45.0	6515 11.910
6.750	17/64	8.0	167.0	127.0	36.0	6515 6.750	12.000		12.0	263.0	214.0	45.0	6515 12.000
6.800		8.0	167.0	127.0	36.0	6515 6.800	12.100		14.0	297.0	248.0	45.0	6515 12.100
6.900		8.0	167.0	127.0	36.0	6515 6.900	12.200		14.0	297.0	248.0	45.0	6515 12.200
7.000		8.0	167.0	127.0	36.0	6515 7.000	12.500		14.0	297.0	248.0	45.0	6515 12.500
7.100		8.0	183.0	143.0	36.0	6515 7.100	12.600		14.0	297.0	248.0	45.0	6515 12.600
7.140	9/32	8.0	183.0	143.0	36.0	6515 7.140	12.700	1/2	14.0	297.0	248.0	45.0	6515 12.700
7.200		8.0	183.0	143.0	36.0	6515 7.200	12.800		14.0	297.0	248.0	45.0	6515 12.800
7.300		8.0	183.0	143.0	36.0	6515 7.300	12.900		14.0	297.0	248.0	45.0	6515 12.900
7.400		8.0	183.0	143.0	36.0	6515 7.400	13.000		14.0	297.0	248.0	45.0	6515 13.000
7.500		8.0	183.0	143.0	36.0	6515 7.500	13.100	33/64	14.0	297.0	248.0	45.0	6515 13.100
7.540	19/64	8.0	183.0	143.0	36.0	6515 7.540	13.300		14.0	297.0	248.0	45.0	6515 13.300
7.600		8.0	183.0	143.0	36.0	6515 7.600	13.400		14.0	297.0	248.0	45.0	6515 13.400
7.700		8.0	183.0	143.0	36.0	6515 7.700	13.500		14.0	297.0	248.0	45.0	6515 13.500
7.800		8.0	183.0	143.0	36.0	6515 7.800	13.700		14.0	297.0	248.0	45.0	6515 13.700
7.900		8.0	183.0	143.0	36.0	6515 7.900	13.800		14.0	297.0	248.0	45.0	6515 13.800
7.940	5/16	8.0	183.0	143.0	36.0	6515 7.940	14.000		14.0	297.0	248.0	45.0	6515 14.000



Ratio drills with coolant ducts

Article no. 6516



Cutting data page 419

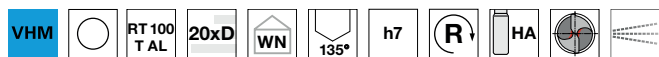

Web thinning $\geq \varnothing 3.000$ • facet point grind • main cutting edge form concave • optimised flute cross-section • maximum diameter of coolant ducts • observe coolant pressure • for piloting we recommend RT100 AI, art. no. 5768, or RT100 FB, art. no. 6596

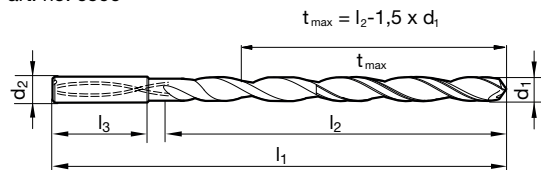

Article no. 6516						Article no. 6516							
d1 mm	inch	d2 h6 mm	l1 mm	l2 mm	l3 mm	Order no.	d1 mm	inch	d2 h6 mm	l1 mm	l2 mm	l3 mm	Order no.
3.000		6.0	110.0	70.0	36.0	6516 3.000	8.000		8.0	223.0	183.0	36.0	6516 8.000
3.100		6.0	123.0	83.0	36.0	6516 3.100	8.100		10.0	249.0	205.0	40.0	6516 8.100
3.170	1/8	6.0	123.0	83.0	36.0	6516 3.170	8.200		10.0	249.0	205.0	40.0	6516 8.200
3.200		6.0	123.0	83.0	36.0	6516 3.200	8.300		10.0	249.0	205.0	40.0	6516 8.300
3.250		6.0	123.0	83.0	36.0	6516 3.250	8.330	21/64	10.0	249.0	205.0	40.0	6516 8.330
3.300		6.0	123.0	83.0	36.0	6516 3.300	8.400		10.0	249.0	205.0	40.0	6516 8.400
3.400		6.0	123.0	83.0	36.0	6516 3.400	8.500		10.0	249.0	205.0	40.0	6516 8.500
3.500		6.0	136.0	96.0	36.0	6516 3.500	8.600		10.0	249.0	205.0	40.0	6516 8.600
3.570	9/64	6.0	136.0	96.0	36.0	6516 3.570	8.700		10.0	249.0	205.0	40.0	6516 8.700
3.600		6.0	136.0	96.0	36.0	6516 3.600	8.730	11/32	10.0	249.0	205.0	40.0	6516 8.730
3.700		6.0	136.0	96.0	36.0	6516 3.700	8.800		10.0	249.0	205.0	40.0	6516 8.800
3.800		6.0	136.0	96.0	36.0	6516 3.800	8.900		10.0	249.0	205.0	40.0	6516 8.900
3.900		6.0	136.0	96.0	36.0	6516 3.900	9.000		10.0	249.0	205.0	40.0	6516 9.000
3.970	5/32	6.0	136.0	96.0	36.0	6516 3.970	9.100		10.0	271.0	227.0	40.0	6516 9.100
4.000		6.0	136.0	96.0	36.0	6516 4.000	9.130	23/64	10.0	271.0	227.0	40.0	6516 9.130
4.100		6.0	158.0	118.0	36.0	6516 4.100	9.200		10.0	271.0	227.0	40.0	6516 9.200
4.200		6.0	158.0	118.0	36.0	6516 4.200	9.250		10.0	271.0	227.0	40.0	6516 9.250
4.300		6.0	158.0	118.0	36.0	6516 4.300	9.300		10.0	271.0	227.0	40.0	6516 9.300
4.370	11/64	6.0	158.0	118.0	36.0	6516 4.370	9.340		10.0	271.0	227.0	40.0	6516 9.340
4.400		6.0	158.0	118.0	36.0	6516 4.400	9.400		10.0	271.0	227.0	40.0	6516 9.400
4.500		6.0	158.0	118.0	36.0	6516 4.500	9.500		10.0	271.0	227.0	40.0	6516 9.500
4.600		6.0	158.0	118.0	36.0	6516 4.600	9.520	3/8	10.0	271.0	227.0	40.0	6516 9.520
4.650		6.0	158.0	118.0	36.0	6516 4.650	9.600		10.0	271.0	227.0	40.0	6516 9.600
4.700		6.0	158.0	118.0	36.0	6516 4.700	9.700		10.0	271.0	227.0	40.0	6516 9.700
4.760	3/16	6.0	158.0	118.0	36.0	6516 4.760	9.800		10.0	271.0	227.0	40.0	6516 9.800
4.800		6.0	158.0	118.0	36.0	6516 4.800	9.900		10.0	271.0	227.0	40.0	6516 9.900
4.900		6.0	158.0	118.0	36.0	6516 4.900	9.920	25/64	10.0	271.0	227.0	40.0	6516 9.920
5.000		6.0	158.0	118.0	36.0	6516 5.000	10.000		10.0	271.0	227.0	40.0	6516 10.000
5.100		6.0	180.0	140.0	36.0	6516 5.100	10.100		12.0	302.0	253.0	45.0	6516 10.100
5.160	13/64	6.0	180.0	140.0	36.0	6516 5.160	10.200		12.0	302.0	253.0	45.0	6516 10.200
5.200		6.0	180.0	140.0	36.0	6516 5.200	10.300		12.0	302.0	253.0	45.0	6516 10.300
5.300		6.0	180.0	140.0	36.0	6516 5.300	10.320	13/32	12.0	302.0	253.0	45.0	6516 10.320
5.400		6.0	180.0	140.0	36.0	6516 5.400	10.400		12.0	302.0	253.0	45.0	6516 10.400
5.500		6.0	180.0	140.0	36.0	6516 5.500	10.500		12.0	302.0	253.0	45.0	6516 10.500
5.550		6.0	180.0	140.0	36.0	6516 5.550	10.600		12.0	302.0	253.0	45.0	6516 10.600
5.560	7/32	6.0	180.0	140.0	36.0	6516 5.560	10.700		12.0	302.0	253.0	45.0	6516 10.700
5.600		6.0	180.0	140.0	36.0	6516 5.600	10.800		12.0	302.0	253.0	45.0	6516 10.800
5.700		6.0	180.0	140.0	36.0	6516 5.700	10.900		12.0	302.0	253.0	45.0	6516 10.900
5.800		6.0	180.0	140.0	36.0	6516 5.800	11.000		12.0	302.0	253.0	45.0	6516 11.000
5.900		6.0	180.0	140.0	36.0	6516 5.900	11.100		12.0	323.0	274.0	45.0	6516 11.100
5.950	15/64	6.0	180.0	140.0	36.0	6516 5.950	11.110	7/16	12.0	323.0	274.0	45.0	6516 11.110
6.000		6.0	180.0	140.0	36.0	6516 6.000	11.200		12.0	323.0	274.0	45.0	6516 11.200
6.100		8.0	202.0	162.0	36.0	6516 6.100	11.300		12.0	323.0	274.0	45.0	6516 11.300
6.200		8.0	202.0	162.0	36.0	6516 6.200	11.400		12.0	323.0	274.0	45.0	6516 11.400
6.300		8.0	202.0	162.0	36.0	6516 6.300	11.500		12.0	323.0	274.0	45.0	6516 11.500
6.350	1/4	8.0	202.0	162.0	36.0	6516 6.350	11.600		12.0	323.0	274.0	45.0	6516 11.600
6.400		8.0	202.0	162.0	36.0	6516 6.400	11.700		12.0	323.0	274.0	45.0	6516 11.700
6.500		8.0	202.0	162.0	36.0	6516 6.500	11.800		12.0	323.0	274.0	45.0	6516 11.800
6.600		8.0	202.0	162.0	36.0	6516 6.600	11.900		12.0	323.0	274.0	45.0	6516 11.900
6.700		8.0	202.0	162.0	36.0	6516 6.700	11.910	15/32	12.0	323.0	274.0	45.0	6516 11.910
6.750	17/64	8.0	202.0	162.0	36.0	6516 6.750	12.000		12.0	323.0	274.0	45.0	6516 12.000
6.800		8.0	202.0	162.0	36.0	6516 6.800	12.100		14.0	367.0	318.0	45.0	6516 12.100
6.900		8.0	202.0	162.0	36.0	6516 6.900	12.200		14.0	367.0	318.0	45.0	6516 12.200
7.000		8.0	202.0	162.0	36.0	6516 7.000	12.500		14.0	367.0	318.0	45.0	6516 12.500
7.100		8.0	223.0	183.0	36.0	6516 7.100	12.600		14.0	367.0	318.0	45.0	6516 12.600
7.140	9/32	8.0	223.0	183.0	36.0	6516 7.140	12.700	1/2	14.0	367.0	318.0	45.0	6516 12.700
7.200		8.0	223.0	183.0	36.0	6516 7.200	12.800		14.0	367.0	318.0	45.0	6516 12.800
7.300		8.0	223.0	183.0	36.0	6516 7.300	12.900		14.0	367.0	318.0	45.0	6516 12.900
7.400		8.0	223.0	183.0	36.0	6516 7.400	13.000		14.0	367.0	318.0	45.0	6516 13.000
7.500		8.0	223.0	183.0	36.0	6516 7.500	13.100	33/64	14.0	367.0	318.0	45.0	6516 13.100
7.540	19/64	8.0	223.0	183.0	36.0	6516 7.540	13.300		14.0	367.0	318.0	45.0	6516 13.300
7.600		8.0	223.0	183.0	36.0	6516 7.600	13.400		14.0	367.0	318.0	45.0	6516 13.400
7.700		8.0	223.0	183.0	36.0	6516 7.700	13.500		14.0	367.0	318.0	45.0	6516 13.500
7.800		8.0	223.0	183.0	36.0	6516 7.800	13.700		14.0	367.0	318.0	45.0	6516 13.700
7.900		8.0	223.0	183.0	36.0	6516 7.900	13.800		14.0	367.0	318.0	45.0	6516 13.800
7.940	5/16	8.0	223.0	183.0	36.0	6516 7.940	14.000		14.0	367.0	318.0	45.0	6516 14.000



Cutting data page 419

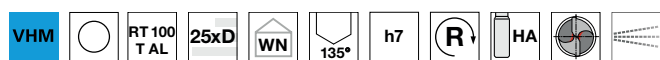

Web thinning $\geq \varnothing 3.000$ • facet point grind • main cutting edge form concave • optimised flute cross-section • maximum diameter of coolant ducts • observe coolant pressure • for piloting we recommend RT100 Al, art. no. 5768, or RT100 FB, art. no. 6596

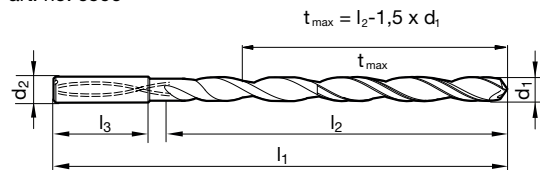

Article no. **6517**

Article no. **6517**

d1 mm	inch	d2 h6 mm	l1 mm	l2 mm	l3 mm	Order no.	d1 mm	inch	d2 h6 mm	l1 mm	l2 mm	l3 mm	Order no.
3.000		6.0	125.0	85.0	36.0	6517 3.000	8.000		8.0	263.0	223.0	36.0	6517 8.000
3.100		6.0	141.0	101.0	36.0	6517 3.100	8.100		10.0	294.0	250.0	40.0	6517 8.100
3.170	1/8	6.0	141.0	101.0	36.0	6517 3.170	8.200		10.0	294.0	250.0	40.0	6517 8.200
3.200		6.0	141.0	101.0	36.0	6517 3.200	8.300		10.0	294.0	250.0	40.0	6517 8.300
3.250		6.0	141.0	101.0	36.0	6517 3.250	8.330	21/64	10.0	294.0	250.0	40.0	6517 8.330
3.300		6.0	141.0	101.0	36.0	6517 3.300	8.400		10.0	294.0	250.0	40.0	6517 8.400
3.400		6.0	141.0	101.0	36.0	6517 3.400	8.500		10.0	294.0	250.0	40.0	6517 8.500
3.500		6.0	156.0	116.0	36.0	6517 3.500	8.600		10.0	294.0	250.0	40.0	6517 8.600
3.570	9/64	6.0	156.0	116.0	36.0	6517 3.570	8.700		10.0	294.0	250.0	40.0	6517 8.700
3.600		6.0	156.0	116.0	36.0	6517 3.600	8.730	11/32	10.0	294.0	250.0	40.0	6517 8.730
3.700		6.0	156.0	116.0	36.0	6517 3.700	8.800		10.0	294.0	250.0	40.0	6517 8.800
3.800		6.0	156.0	116.0	36.0	6517 3.800	8.900		10.0	294.0	250.0	40.0	6517 8.900
3.900		6.0	156.0	116.0	36.0	6517 3.900	9.000		10.0	294.0	250.0	40.0	6517 9.000
3.970	5/32	6.0	156.0	116.0	36.0	6517 3.970	9.100		10.0	321.0	277.0	40.0	6517 9.100
4.000		6.0	156.0	116.0	36.0	6517 4.000	9.130	23/64	10.0	321.0	277.0	40.0	6517 9.130
4.100		6.0	183.0	143.0	36.0	6517 4.100	9.200		10.0	321.0	277.0	40.0	6517 9.200
4.200		6.0	183.0	143.0	36.0	6517 4.200	9.250		10.0	321.0	277.0	40.0	6517 9.250
4.300		6.0	183.0	143.0	36.0	6517 4.300	9.300		10.0	321.0	277.0	40.0	6517 9.300
4.370	11/64	6.0	183.0	143.0	36.0	6517 4.370	9.340		10.0	321.0	277.0	40.0	6517 9.340
4.400		6.0	183.0	143.0	36.0	6517 4.400	9.400		10.0	321.0	277.0	40.0	6517 9.400
4.500		6.0	183.0	143.0	36.0	6517 4.500	9.500		10.0	321.0	277.0	40.0	6517 9.500
4.600		6.0	183.0	143.0	36.0	6517 4.600	9.520	3/8	10.0	321.0	277.0	40.0	6517 9.520
4.650		6.0	183.0	143.0	36.0	6517 4.650	9.600		10.0	321.0	277.0	40.0	6517 9.600
4.700		6.0	183.0	143.0	36.0	6517 4.700	9.700		10.0	321.0	277.0	40.0	6517 9.700
4.760	3/16	6.0	183.0	143.0	36.0	6517 4.760	9.800		10.0	321.0	277.0	40.0	6517 9.800
4.800		6.0	183.0	143.0	36.0	6517 4.800	9.900		10.0	321.0	277.0	40.0	6517 9.900
4.900		6.0	183.0	143.0	36.0	6517 4.900	9.920	25/64	10.0	321.0	277.0	40.0	6517 9.920
5.000		6.0	183.0	143.0	36.0	6517 5.000	10.000		10.0	321.0	277.0	40.0	6517 10.000
5.100		6.0	210.0	170.0	36.0	6517 5.100	10.100		12.0	359.0	310.0	45.0	6517 10.100
5.160	13/64	6.0	210.0	170.0	36.0	6517 5.160	10.200		12.0	359.0	310.0	45.0	6517 10.200
5.200		6.0	210.0	170.0	36.0	6517 5.200	10.300		12.0	359.0	310.0	45.0	6517 10.300
5.300		6.0	210.0	170.0	36.0	6517 5.300	10.320	13/32	12.0	359.0	310.0	45.0	6517 10.320
5.400		6.0	210.0	170.0	36.0	6517 5.400	10.400		12.0	359.0	310.0	45.0	6517 10.400
5.500		6.0	210.0	170.0	36.0	6517 5.500	10.500		12.0	359.0	310.0	45.0	6517 10.500
5.550		6.0	210.0	170.0	36.0	6517 5.550	10.600		12.0	359.0	310.0	45.0	6517 10.600
5.560	7/32	6.0	210.0	170.0	36.0	6517 5.560	10.700		12.0	359.0	310.0	45.0	6517 10.700
5.600		6.0	210.0	170.0	36.0	6517 5.600	10.800		12.0	359.0	310.0	45.0	6517 10.800
5.700		6.0	210.0	170.0	36.0	6517 5.700	10.900		12.0	359.0	310.0	45.0	6517 10.900
5.800		6.0	210.0	170.0	36.0	6517 5.800	11.000		12.0	359.0	310.0	45.0	6517 11.000
5.900		6.0	210.0	170.0	36.0	6517 5.900	11.100		12.0	386.0	337.0	45.0	6517 11.100
5.950	15/64	6.0	210.0	170.0	36.0	6517 5.950	11.110	7/16	12.0	386.0	337.0	45.0	6517 11.110
6.000		6.0	210.0	170.0	36.0	6517 6.000	11.200		12.0	386.0	337.0	45.0	6517 11.200
6.100		8.0	237.0	197.0	36.0	6517 6.100	11.300		12.0	386.0	337.0	45.0	6517 11.300
6.200		8.0	237.0	197.0	36.0	6517 6.200	11.400		12.0	386.0	337.0	45.0	6517 11.400
6.300		8.0	237.0	197.0	36.0	6517 6.300	11.500		12.0	386.0	337.0	45.0	6517 11.500
6.350	1/4	8.0	237.0	197.0	36.0	6517 6.350	11.600		12.0	386.0	337.0	45.0	6517 11.600
6.400		8.0	237.0	197.0	36.0	6517 6.400	11.700		12.0	386.0	337.0	45.0	6517 11.700
6.500		8.0	237.0	197.0	36.0	6517 6.500	11.800		12.0	386.0	337.0	45.0	6517 11.800
6.600		8.0	237.0	197.0	36.0	6517 6.600	11.900		12.0	386.0	337.0	45.0	6517 11.900
6.700		8.0	237.0	197.0	36.0	6517 6.700	11.910	15/32	12.0	386.0	337.0	45.0	6517 11.910
6.750	17/64	8.0	237.0	197.0	36.0	6517 6.750	12.000		12.0	386.0	337.0	45.0	6517 12.000
6.800		8.0	237.0	197.0	36.0	6517 6.800	12.100		14.0	437.0	388.0	45.0	6517 12.100
6.900		8.0	237.0	197.0	36.0	6517 6.900	12.200		14.0	437.0	388.0	45.0	6517 12.200
7.000		8.0	237.0	197.0	36.0	6517 7.000	12.500		14.0	437.0	388.0	45.0	6517 12.500
7.100		8.0	263.0	223.0	36.0	6517 7.100	12.600		14.0	437.0	388.0	45.0	6517 12.600
7.140	9/32	8.0	263.0	223.0	36.0	6517 7.140	12.700	1/2	14.0	437.0	388.0	45.0	6517 12.700
7.200		8.0	263.0	223.0	36.0	6517 7.200	12.800		14.0	437.0	388.0	45.0	6517 12.800
7.300		8.0	263.0	223.0	36.0	6517 7.300	12.900		14.0	437.0	388.0	45.0	6517 12.900
7.400		8.0	263.0	223.0	36.0	6517 7.400	13.000		14.0	437.0	388.0	45.0	6517 13.000
7.500		8.0	263.0	223.0	36.0	6517 7.500	13.100	33/64	14.0	437.0	388.0	45.0	6517 13.100
7.540	19/64	8.0	263.0	223.0	36.0	6517 7.540	13.300		14.0	437.0	388.0	45.0	6517 13.300
7.600		8.0	263.0	223.0	36.0	6517 7.600	13.400		14.0	437.0	388.0	45.0	6517 13.400
7.700		8.0	263.0	223.0	36.0	6517 7.700	13.500		14.0	437.0	388.0	45.0	6517 13.500
7.800		8.0	263.0	223.0	36.0	6517 7.800	13.700		14.0	437.0	388.0	45.0	6517 13.700
7.900		8.0	263.0	223.0	36.0	6517 7.900	13.800		14.0	437.0	388.0	45.0	6517 13.800
7.940	5/16	8.0	263.0	223.0	36.0	6517 7.940	14.000		14.0	437.0	388.0	45.0	6517 14.000



Ratio drills with coolant ducts

Article no. 6509



Cutting data page 420

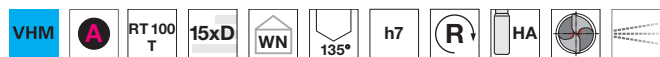

Web thinning $\geq \varnothing 3.000$ • main cutting edge form concave • optimised flute cross-section • maximum diameter of coolant ducts • observe coolant pressure

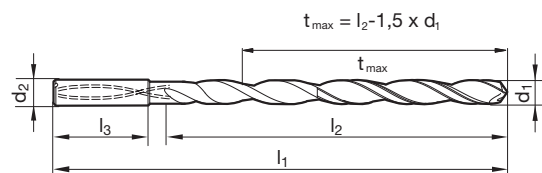

Article no. 6509

Article no. 6509

d1 mm	inch	d2 h6 mm	l1 mm	l2 mm	l3 mm	Order no.	d1 mm	inch	d2 h6 mm	l1 mm	l2 mm	l3 mm	Order no.
3.000		6.0	95.0	55.0	36.0	6509 3.000	8.730	11/32	10.0	204.0	160.0	40.0	6509 8.730
3.100		6.0	106.0	66.0	36.0	6509 3.100	8.800		10.0	204.0	160.0	40.0	6509 8.800
3.170	1/8	6.0	106.0	66.0	36.0	6509 3.170	9.000		10.0	204.0	160.0	40.0	6509 9.000
3.200		6.0	106.0	66.0	36.0	6509 3.200	9.130	23/64	10.0	221.0	177.0	40.0	6509 9.130
3.300		6.0	106.0	66.0	36.0	6509 3.300	9.500		10.0	221.0	177.0	40.0	6509 9.500
3.500		6.0	116.0	76.0	36.0	6509 3.500	9.520	3/8	10.0	221.0	177.0	40.0	6509 9.520
3.570	9/64	6.0	116.0	76.0	36.0	6509 3.570	9.800		10.0	221.0	177.0	40.0	6509 9.800
3.700		6.0	116.0	76.0	36.0	6509 3.700	9.920	25/64	10.0	221.0	177.0	40.0	6509 9.920
3.800		6.0	116.0	76.0	36.0	6509 3.800	10.000		10.0	221.0	177.0	40.0	6509 10.000
3.970	5/32	6.0	116.0	76.0	36.0	6509 3.970	10.200		12.0	247.0	198.0	45.0	6509 10.200
4.000		6.0	116.0	76.0	36.0	6509 4.000	10.320	13/32	12.0	247.0	198.0	45.0	6509 10.320
4.200		6.0	133.0	93.0	36.0	6509 4.200	10.500		12.0	247.0	198.0	45.0	6509 10.500
4.300		6.0	133.0	93.0	36.0	6509 4.300	10.720	27/64	12.0	247.0	198.0	45.0	6509 10.720
4.370	11/64	6.0	133.0	93.0	36.0	6509 4.370	11.000		12.0	247.0	198.0	45.0	6509 11.000
4.500		6.0	133.0	93.0	36.0	6509 4.500	11.110	7/16	12.0	263.0	214.0	45.0	6509 11.110
4.600		6.0	133.0	93.0	36.0	6509 4.600	11.510	29/64	12.0	263.0	214.0	45.0	6509 11.510
4.760	3/16	6.0	133.0	93.0	36.0	6509 4.760	11.800		12.0	263.0	214.0	45.0	6509 11.800
4.800		6.0	133.0	93.0	36.0	6509 4.800	11.910	15/32	12.0	263.0	214.0	45.0	6509 11.910
5.000		6.0	133.0	93.0	36.0	6509 5.000	12.000		12.0	263.0	214.0	45.0	6509 12.000
5.100		6.0	150.0	110.0	36.0	6509 5.100	12.300	31/64	14.0	297.0	248.0	45.0	6509 12.300
5.160	13/64	6.0	150.0	110.0	36.0	6509 5.160	12.500		14.0	297.0	248.0	45.0	6509 12.500
5.410		6.0	150.0	110.0	36.0	6509 5.410	12.700	1/2	14.0	297.0	248.0	45.0	6509 12.700
5.500		6.0	150.0	110.0	36.0	6509 5.500	13.000		14.0	297.0	248.0	45.0	6509 13.000
5.560	7/32	6.0	150.0	110.0	36.0	6509 5.560	13.100	33/64	14.0	297.0	248.0	45.0	6509 13.100
5.600		6.0	150.0	110.0	36.0	6509 5.600	13.490	17/32	14.0	297.0	248.0	45.0	6509 13.490
5.800		6.0	150.0	110.0	36.0	6509 5.800	13.890	35/64	14.0	297.0	248.0	45.0	6509 13.890
5.950	15/64	6.0	150.0	110.0	36.0	6509 5.950	14.000		14.0	297.0	248.0	45.0	6509 14.000
6.000		6.0	150.0	110.0	36.0	6509 6.000	14.290	9/16	16.0	333.0	281.0	48.0	6509 14.290
6.300		8.0	167.0	127.0	36.0	6509 6.300	15.000		16.0	333.0	281.0	48.0	6509 15.000
6.350	1/4	8.0	167.0	127.0	36.0	6509 6.350	15.870	5/8	16.0	333.0	281.0	48.0	6509 15.870
6.500		8.0	167.0	127.0	36.0	6509 6.500	16.000		16.0	333.0	281.0	48.0	6509 16.000
6.750	17/64	8.0	167.0	127.0	36.0	6509 6.750							
6.800		8.0	167.0	127.0	36.0	6509 6.800							
7.000		8.0	167.0	127.0	36.0	6509 7.000							
7.140	9/32	8.0	183.0	143.0	36.0	6509 7.140							
7.500		8.0	183.0	143.0	36.0	6509 7.500							
7.540	19/64	8.0	183.0	143.0	36.0	6509 7.540							
7.800		8.0	183.0	143.0	36.0	6509 7.800							
7.940	5/16	8.0	183.0	143.0	36.0	6509 7.940							
8.000		8.0	183.0	143.0	36.0	6509 8.000							
8.330	21/64	10.0	204.0	160.0	40.0	6509 8.330							
8.500		10.0	204.0	160.0	40.0	6509 8.500							



Ratio drills with coolant ducts

Article no. **6511**



Cutting data page 421

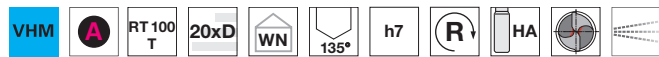

Web thinning $\geq \varnothing 3.000$ • main cutting edge form concave • optimised flute cross-section • maximum diameter of coolant ducts • observe coolant pressure

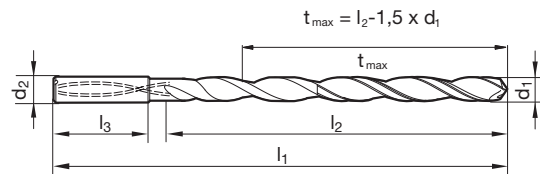

Article no. **6511**

Article no. **6511**

d1 mm	inch	d2 h6 mm	l1 mm	l2 mm	l3 mm	Order no.
3.000		6.0	110.0	70.0	36.0	6511 3.000
3.100		6.0	123.0	83.0	36.0	6511 3.100
3.170	1/8	6.0	123.0	83.0	36.0	6511 3.170
3.200		6.0	123.0	83.0	36.0	6511 3.200
3.300		6.0	123.0	83.0	36.0	6511 3.300
3.500		6.0	136.0	96.0	36.0	6511 3.500
3.570	9/64	6.0	136.0	96.0	36.0	6511 3.570
3.700		6.0	136.0	96.0	36.0	6511 3.700
3.800		6.0	136.0	96.0	36.0	6511 3.800
3.970	5/32	6.0	136.0	96.0	36.0	6511 3.970
4.000		6.0	136.0	96.0	36.0	6511 4.000
4.200		6.0	158.0	118.0	36.0	6511 4.200
4.300		6.0	158.0	118.0	36.0	6511 4.300
4.370	11/64	6.0	158.0	118.0	36.0	6511 4.370
4.500		6.0	158.0	118.0	36.0	6511 4.500
4.600		6.0	158.0	118.0	36.0	6511 4.600
4.760	3/16	6.0	158.0	118.0	36.0	6511 4.760
4.800		6.0	158.0	118.0	36.0	6511 4.800
5.000		6.0	158.0	118.0	36.0	6511 5.000
5.100		6.0	180.0	140.0	36.0	6511 5.100
5.160	13/64	6.0	180.0	140.0	36.0	6511 5.160
5.410		6.0	180.0	140.0	36.0	6511 5.410
5.500		6.0	180.0	140.0	36.0	6511 5.500
5.560	7/32	6.0	180.0	140.0	36.0	6511 5.560
5.800		6.0	180.0	140.0	36.0	6511 5.800
5.950	15/64	6.0	180.0	140.0	36.0	6511 5.950
6.000		6.0	180.0	140.0	36.0	6511 6.000
6.300		8.0	202.0	162.0	36.0	6511 6.300
6.350	1/4	8.0	202.0	162.0	36.0	6511 6.350
6.500		8.0	202.0	162.0	36.0	6511 6.500
6.750	17/64	8.0	202.0	162.0	36.0	6511 6.750
6.800		8.0	202.0	162.0	36.0	6511 6.800
7.000		8.0	202.0	162.0	36.0	6511 7.000
7.140	9/32	8.0	223.0	183.0	36.0	6511 7.140
7.500		8.0	223.0	183.0	36.0	6511 7.500
7.540	19/64	8.0	223.0	183.0	36.0	6511 7.540

d1 mm	inch	d2 h6 mm	l1 mm	l2 mm	l3 mm	Order no.
7.800		8.0	223.0	183.0	36.0	6511 7.800
7.940	5/16	8.0	223.0	183.0	36.0	6511 7.940
8.000		8.0	223.0	183.0	36.0	6511 8.000
8.330	21/64	10.0	249.0	205.0	40.0	6511 8.330
8.500		10.0	249.0	205.0	40.0	6511 8.500
8.730	11/32	10.0	249.0	205.0	40.0	6511 8.730
8.800		10.0	249.0	205.0	40.0	6511 8.800
9.000		10.0	249.0	205.0	40.0	6511 9.000
9.130	23/64	10.0	271.0	227.0	40.0	6511 9.130
9.520	3/8	10.0	271.0	227.0	40.0	6511 9.520
9.920	25/64	10.0	271.0	227.0	40.0	6511 9.920
10.000		10.0	271.0	227.0	40.0	6511 10.000
10.200		12.0	302.0	253.0	45.0	6511 10.200
10.320	13/32	12.0	302.0	253.0	45.0	6511 10.320
10.500		12.0	302.0	253.0	45.0	6511 10.500
10.720	27/64	12.0	302.0	253.0	45.0	6511 10.720
11.000		12.0	302.0	253.0	45.0	6511 11.000
11.110	7/16	12.0	323.0	274.0	45.0	6511 11.110
11.510	29/64	12.0	323.0	274.0	45.0	6511 11.510
11.800		12.0	323.0	274.0	45.0	6511 11.800
11.910	15/32	12.0	323.0	274.0	45.0	6511 11.910
12.000		12.0	323.0	274.0	45.0	6511 12.000
12.300	31/64	14.0	367.0	318.0	45.0	6511 12.300
12.500		14.0	367.0	318.0	45.0	6511 12.500
12.700	1/2	14.0	367.0	318.0	45.0	6511 12.700
13.000		14.0	367.0	318.0	45.0	6511 13.000
13.100	33/64	14.0	367.0	318.0	45.0	6511 13.100
13.490	17/32	14.0	367.0	318.0	45.0	6511 13.490
13.890	35/64	14.0	367.0	318.0	45.0	6511 13.890
14.000		14.0	367.0	318.0	45.0	6511 14.000
14.290	9/16	16.0	413.0	361.0	48.0	6511 14.290
15.000		16.0	413.0	361.0	48.0	6511 15.000
15.870	5/8	16.0	413.0	361.0	48.0	6511 15.870
16.000		16.0	413.0	361.0	48.0	6511 16.000



Ratio drills with coolant ducts

Article no. 6512



Cutting data page 422

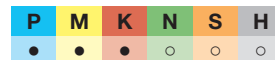
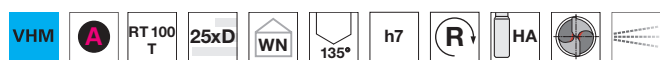

Web thinning $\geq \varnothing 3.000$ • main cutting edge form concave • optimised flute cross-section • maximum diameter of coolant ducts • observe coolant pressure

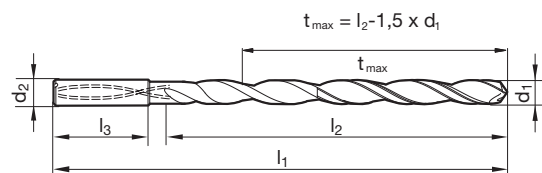

Article no. 6512

Article no. 6512

d1 mm	inch	d2 h6 mm	l1 mm	l2 mm	l3 mm	Order no.	d1 mm	inch	d2 h6 mm	l1 mm	l2 mm	l3 mm	Order no.
3.000		6.0	125.0	85.0	36.0	6512 3.000	7.940	5/16	8.0	263.0	223.0	36.0	6512 7.940
3.100		6.0	141.0	101.0	36.0	6512 3.100	8.000		8.0	263.0	223.0	36.0	6512 8.000
3.170	1/8	6.0	141.0	101.0	36.0	6512 3.170	8.330	21/64	10.0	294.0	250.0	40.0	6512 8.330
3.200		6.0	141.0	101.0	36.0	6512 3.200	8.500		10.0	294.0	250.0	40.0	6512 8.500
3.300		6.0	141.0	101.0	36.0	6512 3.300	8.730	11/32	10.0	294.0	250.0	40.0	6512 8.730
3.500		6.0	156.0	116.0	36.0	6512 3.500	8.800		10.0	294.0	250.0	40.0	6512 8.800
3.570	9/64	6.0	156.0	116.0	36.0	6512 3.570	9.000		10.0	294.0	250.0	40.0	6512 9.000
3.700		6.0	156.0	116.0	36.0	6512 3.700	9.130	23/64	10.0	321.0	277.0	40.0	6512 9.130
3.800		6.0	156.0	116.0	36.0	6512 3.800	9.520	3/8	10.0	321.0	277.0	40.0	6512 9.520
3.970	5/32	6.0	156.0	116.0	36.0	6512 3.970	9.920	25/64	10.0	321.0	277.0	40.0	6512 9.920
4.000		6.0	156.0	116.0	36.0	6512 4.000	10.000		10.0	321.0	277.0	40.0	6512 10.000
4.200		6.0	183.0	143.0	36.0	6512 4.200	10.320	13/32	12.0	359.0	310.0	45.0	6512 10.320
4.300		6.0	183.0	143.0	36.0	6512 4.300	10.720	27/64	12.0	359.0	310.0	45.0	6512 10.720
4.370	11/64	6.0	183.0	143.0	36.0	6512 4.370	11.000		12.0	359.0	310.0	45.0	6512 11.000
4.500		6.0	183.0	143.0	36.0	6512 4.500	11.110	7/16	12.0	386.0	337.0	45.0	6512 11.110
4.600		6.0	183.0	143.0	36.0	6512 4.600	11.510	29/64	12.0	386.0	337.0	45.0	6512 11.510
4.760	3/16	6.0	183.0	143.0	36.0	6512 4.760	11.910	15/32	12.0	386.0	337.0	45.0	6512 11.910
4.800		6.0	183.0	143.0	36.0	6512 4.800	12.000		12.0	386.0	337.0	45.0	6512 12.000
5.000		6.0	183.0	143.0	36.0	6512 5.000	12.300	31/64	14.0	437.0	388.0	45.0	6512 12.300
5.100		6.0	210.0	170.0	36.0	6512 5.100	12.700	1/2	14.0	437.0	388.0	45.0	6512 12.700
5.160	13/64	6.0	210.0	170.0	36.0	6512 5.160	13.000		14.0	437.0	388.0	45.0	6512 13.000
5.410		6.0	210.0	170.0	36.0	6512 5.410	13.100	33/64	14.0	437.0	388.0	45.0	6512 13.100
5.500		6.0	210.0	170.0	36.0	6512 5.500	13.490	17/32	14.0	437.0	388.0	45.0	6512 13.490
5.560	7/32	6.0	210.0	170.0	36.0	6512 5.560	13.890	35/64	14.0	437.0	388.0	45.0	6512 13.890
5.800		6.0	210.0	170.0	36.0	6512 5.800	14.000		14.0	437.0	388.0	45.0	6512 14.000
5.950	15/64	6.0	210.0	170.0	36.0	6512 5.950	14.290	9/16	16.0	493.0	441.0	48.0	6512 14.290
6.000		6.0	210.0	170.0	36.0	6512 6.000	15.000		16.0	493.0	441.0	48.0	6512 15.000
6.300		8.0	237.0	197.0	36.0	6512 6.300	15.870	5/8	16.0	493.0	441.0	48.0	6512 15.870
6.350	1/4	8.0	237.0	197.0	36.0	6512 6.350	16.000		16.0	493.0	441.0	48.0	6512 16.000
6.500		8.0	237.0	197.0	36.0	6512 6.500							
6.750	17/64	8.0	237.0	197.0	36.0	6512 6.750							
6.800		8.0	237.0	197.0	36.0	6512 6.800							
7.000		8.0	237.0	197.0	36.0	6512 7.000							
7.140	9/32	8.0	263.0	223.0	36.0	6512 7.140							
7.500		8.0	263.0	223.0	36.0	6512 7.500							
7.540	19/64	8.0	263.0	223.0	36.0	6512 7.540							



Ratio drills with coolant ducts

Article no. **6513**



Cutting data page 423

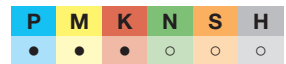
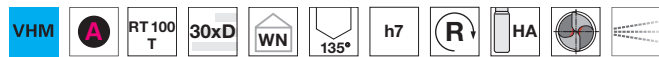

Web thinning $\geq \varnothing 3.000$ • main cutting edge form concave • optimised flute cross-section • maximum diameter of coolant ducts • observe coolant pressure

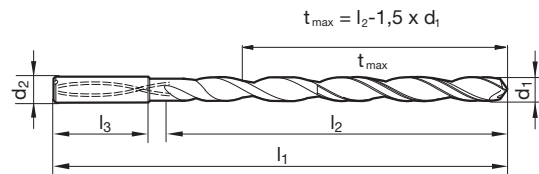

Article no. **6513**

Article no. **6513**

d1 mm	inch	d2 h6 mm	l1 mm	l2 mm	l3 mm	Order no.	d1 mm	inch	d2 h6 mm	l1 mm	l2 mm	l3 mm	Order no.
3.000		6.0	140.0	100.0	36.0	6513 3.000	7.500		8.0	303.0	263.0	36.0	6513 7.500
3.100		6.0	158.0	118.0	36.0	6513 3.100	7.540	19/64	8.0	303.0	263.0	36.0	6513 7.540
3.170	1/8	6.0	158.0	118.0	36.0	6513 3.170	7.940	5/16	8.0	303.0	263.0	36.0	6513 7.940
3.200		6.0	158.0	118.0	36.0	6513 3.200	8.000		8.0	303.0	263.0	36.0	6513 8.000
3.300		6.0	158.0	118.0	36.0	6513 3.300	8.330	21/64	10.0	339.0	295.0	40.0	6513 8.330
3.500		6.0	176.0	136.0	36.0	6513 3.500	8.500		10.0	339.0	295.0	40.0	6513 8.500
3.570	9/64	6.0	176.0	136.0	36.0	6513 3.570	8.730	11/32	10.0	339.0	295.0	40.0	6513 8.730
3.700		6.0	176.0	136.0	36.0	6513 3.700	8.800		10.0	339.0	295.0	40.0	6513 8.800
3.800		6.0	176.0	136.0	36.0	6513 3.800	9.000		10.0	339.0	295.0	40.0	6513 9.000
3.970	5/32	6.0	176.0	136.0	36.0	6513 3.970	9.130	23/64	10.0	371.0	327.0	40.0	6513 9.130
4.000		6.0	176.0	136.0	36.0	6513 4.000	9.520	3/8	10.0	371.0	327.0	40.0	6513 9.520
4.200		6.0	208.0	168.0	36.0	6513 4.200	9.920	25/64	10.0	371.0	327.0	40.0	6513 9.920
4.370	11/64	6.0	208.0	168.0	36.0	6513 4.370	10.000		10.0	371.0	327.0	40.0	6513 10.000
4.500		6.0	208.0	168.0	36.0	6513 4.500	10.320	13/32	12.0	412.0	363.0	45.0	6513 10.320
4.760	3/16	6.0	208.0	168.0	36.0	6513 4.760	10.720	27/64	12.0	412.0	363.0	45.0	6513 10.720
5.000		6.0	208.0	168.0	36.0	6513 5.000	11.000		12.0	412.0	363.0	45.0	6513 11.000
5.100		6.0	240.0	200.0	36.0	6513 5.100	11.110	7/16	12.0	443.0	394.0	45.0	6513 11.110
5.160	13/64	6.0	240.0	200.0	36.0	6513 5.160	11.510	29/64	12.0	443.0	394.0	45.0	6513 11.510
5.410		6.0	240.0	200.0	36.0	6513 5.410	11.910	15/32	12.0	443.0	394.0	45.0	6513 11.910
5.500		6.0	240.0	200.0	36.0	6513 5.500	12.000		12.0	443.0	394.0	45.0	6513 12.000
5.560	7/32	6.0	240.0	200.0	36.0	6513 5.560	12.300	31/64	14.0	507.0	458.0	45.0	6513 12.300
5.950	15/64	6.0	240.0	200.0	36.0	6513 5.950	12.700	1/2	14.0	507.0	458.0	45.0	6513 12.700
6.000		6.0	240.0	200.0	36.0	6513 6.000	13.000		14.0	507.0	458.0	45.0	6513 13.000
6.300		8.0	272.0	232.0	36.0	6513 6.300	13.100	33/64	14.0	507.0	458.0	45.0	6513 13.100
6.350	1/4	8.0	272.0	232.0	36.0	6513 6.350	13.490	17/32	14.0	507.0	458.0	45.0	6513 13.490
6.500		8.0	272.0	232.0	36.0	6513 6.500	13.890	35/64	14.0	507.0	458.0	45.0	6513 13.890
6.750	17/64	8.0	272.0	232.0	36.0	6513 6.750	14.000		14.0	507.0	458.0	45.0	6513 14.000
6.800		8.0	272.0	232.0	36.0	6513 6.800							
7.000		8.0	272.0	232.0	36.0	6513 7.000							
7.140	9/32	8.0	303.0	263.0	36.0	6513 7.140							



Ratio drills with coolant ducts

Article no. 6514



Cutting data page 424

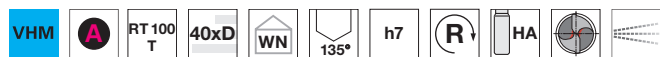

Web thinning $\geq \varnothing 3.000$ • main cutting edge form concave • optimised flute cross-section • maximum diameter of coolant ducts • observe coolant pressure

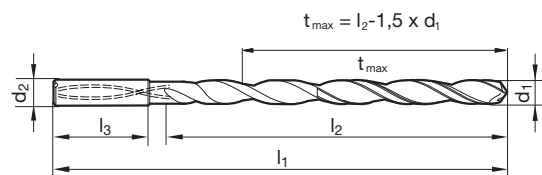

Article no. 6514

Article no. 6514

d1 mm	inch	d2 h6 mm	l1 mm	l2 mm	l3 mm	Order no.
3.000		6.0	170.0	130.0	36.0	6514 3.000
3.100		6.0	193.0	153.0	36.0	6514 3.100
3.170	1/8	6.0	193.0	153.0	36.0	6514 3.170
3.200		6.0	193.0	153.0	36.0	6514 3.200
3.300		6.0	193.0	153.0	36.0	6514 3.300
3.500		6.0	193.0	153.0	36.0	6514 3.500
3.570	9/64	6.0	216.0	176.0	36.0	6514 3.570
3.800		6.0	216.0	176.0	36.0	6514 3.800
3.970	5/32	6.0	216.0	176.0	36.0	6514 3.970
4.000		6.0	216.0	176.0	36.0	6514 4.000
4.200		6.0	238.0	198.0	36.0	6514 4.200
4.370	11/64	6.0	238.0	198.0	36.0	6514 4.370
4.500		6.0	238.0	198.0	36.0	6514 4.500
4.760	3/16	6.0	258.0	218.0	36.0	6514 4.760
5.000		6.0	258.0	218.0	36.0	6514 5.000
5.100		6.0	280.0	240.0	36.0	6514 5.100
5.160	13/64	6.0	280.0	240.0	36.0	6514 5.160
5.410		6.0	280.0	240.0	36.0	6514 5.410

d1 mm	inch	d2 h6 mm	l1 mm	l2 mm	l3 mm	Order no.
5.500		6.0	280.0	240.0	36.0	6514 5.500
5.560	7/32	6.0	300.0	260.0	36.0	6514 5.560
5.950	15/64	6.0	300.0	260.0	36.0	6514 5.950
6.000		6.0	300.0	260.0	36.0	6514 6.000
6.300		8.0	322.0	282.0	36.0	6514 6.300
6.350	1/4	8.0	322.0	282.0	36.0	6514 6.350
6.500		8.0	322.0	282.0	36.0	6514 6.500
6.750	17/64	8.0	342.0	302.0	36.0	6514 6.750
6.800		8.0	342.0	302.0	36.0	6514 6.800
7.000		8.0	342.0	302.0	36.0	6514 7.000
7.140	9/32	8.0	363.0	323.0	36.0	6514 7.140
7.500		8.0	363.0	323.0	36.0	6514 7.500
7.540	19/64	8.0	383.0	343.0	36.0	6514 7.540
7.940	5/16	8.0	383.0	343.0	36.0	6514 7.940
8.000		8.0	383.0	343.0	36.0	6514 8.000
8.500		10.0	409.0	365.0	40.0	6514 8.500
9.000		10.0	429.0	386.0	40.0	6514 9.000
10.000		10.0	471.0	427.0	40.0	6514 10.000



Ratio drills without coolant ducts, 3-fluted

Article no. **2713**



Cutting data page 425

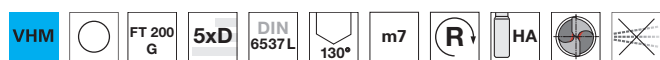

Web thinning $\geq \varnothing 3.000$ • spiropoint grind • wide flutes • optimal centering • suitable for interrupted cutting

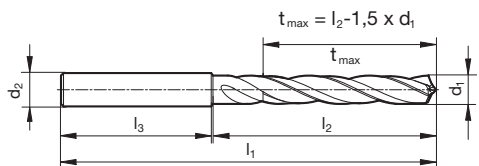

Article no. 2713				Article no. 2713					
d1	inch	l1	l2	Order no.	d1	inch	l1	l2	Order no.
3.000		66.0	28.0	2713 3.000	8.500		103.0	61.0	2713 8.500
3.100		66.0	28.0	2713 3.100	8.600		103.0	61.0	2713 8.600
3.200		66.0	28.0	2713 3.200	8.700		103.0	61.0	2713 8.700
3.300		66.0	28.0	2713 3.300	8.800		103.0	61.0	2713 8.800
3.500		66.0	28.0	2713 3.500	9.000		103.0	61.0	2713 9.000
3.700		66.0	28.0	2713 3.700	9.100		103.0	61.0	2713 9.100
3.800		74.0	36.0	2713 3.800	9.500		103.0	61.0	2713 9.500
4.000		74.0	36.0	2713 4.000	9.800		103.0	61.0	2713 9.800
4.100		74.0	36.0	2713 4.100	10.000		103.0	61.0	2713 10.000
4.200		74.0	36.0	2713 4.200	10.100		118.0	71.0	2713 10.100
4.500		74.0	36.0	2713 4.500	10.200		118.0	71.0	2713 10.200
4.800		82.0	44.0	2713 4.800	10.300		118.0	71.0	2713 10.300
5.000		82.0	44.0	2713 5.000	10.500		118.0	71.0	2713 10.500
5.100		82.0	44.0	2713 5.100	11.000		118.0	71.0	2713 11.000
5.200		82.0	44.0	2713 5.200	11.200		118.0	71.0	2713 11.200
5.300		82.0	44.0	2713 5.300	11.500		118.0	71.0	2713 11.500
5.500		82.0	44.0	2713 5.500	11.800		118.0	71.0	2713 11.800
5.800		82.0	44.0	2713 5.800	12.000		118.0	71.0	2713 12.000
6.000		82.0	44.0	2713 6.000	12.100		124.0	77.0	2713 12.100
6.100		91.0	53.0	2713 6.100	12.500		124.0	77.0	2713 12.500
6.200		91.0	53.0	2713 6.200	13.000		124.0	77.0	2713 13.000
6.400		91.0	53.0	2713 6.400	13.500		124.0	77.0	2713 13.500
6.500		91.0	53.0	2713 6.500	14.000		124.0	77.0	2713 14.000
6.700		91.0	53.0	2713 6.700	14.100		133.0	83.0	2713 14.100
6.800		91.0	53.0	2713 6.800	14.500		133.0	83.0	2713 14.500
6.900		91.0	53.0	2713 6.900	15.000		133.0	83.0	2713 15.000
7.000		91.0	53.0	2713 7.000	15.500		133.0	83.0	2713 15.500
7.100		91.0	53.0	2713 7.100	16.000		133.0	83.0	2713 16.000
7.200		91.0	53.0	2713 7.200	16.500		143.0	93.0	2713 16.500
7.400		91.0	53.0	2713 7.400	17.000		143.0	93.0	2713 17.000
7.500		91.0	53.0	2713 7.500	17.500		143.0	93.0	2713 17.500
7.800		91.0	53.0	2713 7.800	18.000		143.0	93.0	2713 18.000
8.000		91.0	53.0	2713 8.000	18.500		153.0	101.0	2713 18.500
8.100		103.0	61.0	2713 8.100	19.000		153.0	101.0	2713 19.000
8.200		103.0	61.0	2713 8.200	19.500	3/4	153.0	101.0	2713 19.500
8.400		103.0	61.0	2713 8.400	20.000		153.0	101.0	2713 20.000



Ratio drills without coolant ducts, 3-fluted

Article no. 1025



Cutting data page 425

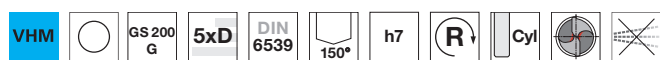

Web thinning $\geq \varnothing 3.000$ • facet point grind • for holes with high alignment accuracy • very good surface quality of hole
 • suitable for interrupted cutting

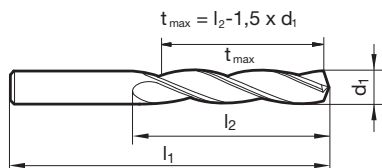

Article no. 1025				Article no. 1025					
d1 mm	inch	l1 mm	l2 mm	Order no.	d1 mm	inch	l1 mm	l2 mm	Order no.
3.000		46.0	22.0	1025 3.000	8.500		79.0	48.0	1025 8.500
3.100		49.0	24.0	1025 3.100	8.600		84.0	52.0	1025 8.600
3.170	1/8	49.0	24.0	1025 3.170	8.700		84.0	52.0	1025 8.700
3.200		49.0	24.0	1025 3.200	8.730	11/32	84.0	52.0	1025 8.730
3.300		49.0	24.0	1025 3.300	8.800		84.0	52.0	1025 8.800
3.400		52.0	27.0	1025 3.400	8.900		84.0	52.0	1025 8.900
3.500		52.0	27.0	1025 3.500	9.000		84.0	52.0	1025 9.000
3.570	9/64	52.0	27.0	1025 3.570	9.100		84.0	52.0	1025 9.100
3.600		52.0	27.0	1025 3.600	9.130	23/64	84.0	52.0	1025 9.130
3.700		52.0	27.0	1025 3.700	9.200		84.0	52.0	1025 9.200
3.800		55.0	30.0	1025 3.800	9.300		84.0	52.0	1025 9.300
3.900		55.0	30.0	1025 3.900	9.500		84.0	52.0	1025 9.500
3.970	5/32	55.0	30.0	1025 3.970	9.520	3/8	89.0	55.0	1025 9.520
4.000		55.0	30.0	1025 4.000	9.600		89.0	55.0	1025 9.600
4.100		55.0	30.0	1025 4.100	9.700		89.0	55.0	1025 9.700
4.200		55.0	30.0	1025 4.200	9.800		89.0	55.0	1025 9.800
4.300		58.0	32.0	1025 4.300	9.920	25/64	89.0	55.0	1025 9.920
4.370	11/64	58.0	32.0	1025 4.370	10.000		89.0	55.0	1025 10.000
4.400		58.0	32.0	1025 4.400	10.100		89.0	55.0	1025 10.100
4.500		58.0	32.0	1025 4.500	10.200		89.0	55.0	1025 10.200
4.600		58.0	32.0	1025 4.600	10.300		89.0	55.0	1025 10.300
4.700		58.0	32.0	1025 4.700	10.320	13/32	89.0	55.0	1025 10.320
4.760	3/16	62.0	35.0	1025 4.760	10.400		89.0	55.0	1025 10.400
4.800		62.0	35.0	1025 4.800	10.500		89.0	55.0	1025 10.500
4.900		62.0	35.0	1025 4.900	10.700		95.0	60.0	1025 10.700
5.000		62.0	35.0	1025 5.000	10.720	27/64	95.0	60.0	1025 10.720
5.100		62.0	35.0	1025 5.100	10.900		95.0	60.0	1025 10.900
5.160	13/64	62.0	35.0	1025 5.160	11.000		95.0	60.0	1025 11.000
5.200		62.0	35.0	1025 5.200	11.110	7/16	95.0	60.0	1025 11.110
5.300		62.0	35.0	1025 5.300	11.200		95.0	60.0	1025 11.200
5.400		66.0	39.0	1025 5.400	11.300		95.0	60.0	1025 11.300
5.500		66.0	39.0	1025 5.500	11.400		95.0	60.0	1025 11.400
5.600		66.0	39.0	1025 5.600	11.500		95.0	60.0	1025 11.500
5.700		66.0	39.0	1025 5.700	11.510	29/64	95.0	60.0	1025 11.510
5.800		66.0	39.0	1025 5.800	11.700		95.0	60.0	1025 11.700
5.900		66.0	39.0	1025 5.900	11.800		95.0	60.0	1025 11.800
6.000		66.0	39.0	1025 6.000	11.910	15/32	102.0	65.0	1025 11.910
6.100		70.0	42.0	1025 6.100	12.000		102.0	65.0	1025 12.000
6.200		70.0	42.0	1025 6.200	12.100		102.0	65.0	1025 12.100
6.300		70.0	42.0	1025 6.300	12.200		102.0	65.0	1025 12.200
6.350	1/4	70.0	42.0	1025 6.350	12.300	31/64	102.0	65.0	1025 12.300
6.400		70.0	42.0	1025 6.400	12.400		102.0	65.0	1025 12.400
6.500		70.0	42.0	1025 6.500	12.500		102.0	65.0	1025 12.500
6.600		70.0	42.0	1025 6.600	12.700	1/2	102.0	65.0	1025 12.700
6.700		70.0	42.0	1025 6.700	12.800		102.0	65.0	1025 12.800
6.750	17/64	74.0	45.0	1025 6.750	13.000		102.0	65.0	1025 13.000
6.800		74.0	45.0	1025 6.800	13.200		102.0	65.0	1025 13.200
6.900		74.0	45.0	1025 6.900	13.300		107.0	66.0	1025 13.300
7.000		74.0	45.0	1025 7.000	13.400		107.0	66.0	1025 13.400
7.100		74.0	45.0	1025 7.100	13.500		107.0	66.0	1025 13.500
7.140	9/32	74.0	45.0	1025 7.140	13.600		107.0	66.0	1025 13.600
7.200		74.0	45.0	1025 7.200	13.700		107.0	66.0	1025 13.700
7.300		74.0	45.0	1025 7.300	13.800		107.0	66.0	1025 13.800
7.400		74.0	45.0	1025 7.400	13.900		107.0	66.0	1025 13.900
7.500		74.0	45.0	1025 7.500	14.000		107.0	66.0	1025 14.000
7.540	19/64	79.0	48.0	1025 7.540	14.100		111.0	70.0	1025 14.100
7.600		79.0	48.0	1025 7.600	14.290	9/16	111.0	70.0	1025 14.290
7.700		79.0	48.0	1025 7.700	14.300		111.0	70.0	1025 14.300
7.800		79.0	48.0	1025 7.800	14.400		111.0	70.0	1025 14.400
7.900		79.0	48.0	1025 7.900	14.500		111.0	70.0	1025 14.500
7.940	5/16	79.0	48.0	1025 7.940	14.600		111.0	70.0	1025 14.600
8.000		79.0	48.0	1025 8.000	14.700		111.0	70.0	1025 14.700
8.100		79.0	48.0	1025 8.100	14.900		111.0	70.0	1025 14.900
8.200		79.0	48.0	1025 8.200	15.000		111.0	70.0	1025 15.000
8.300		79.0	48.0	1025 8.300	15.300		115.0	73.0	1025 15.300
8.400		79.0	48.0	1025 8.400	15.400		115.0	73.0	1025 15.400



Solid carbide drills

Article no.				1025	Article no.				1025
d1 mm	inch	l1 mm	l2 mm	Order no.	d1 mm	inch	l1 mm	l2 mm	Order no.
15.500		115.0	73.0	1025 15.500	19.050	3/4	131.0	79.0	1025 19.050
15.700		115.0	73.0	1025 15.700	19.500		131.0	79.0	1025 19.500
15.870	5/8	115.0	73.0	1025 15.870	20.000		131.0	79.0	1025 20.000
15.900		115.0	73.0	1025 15.900					
16.000		115.0	73.0	1025 16.000					
16.500		119.0	73.0	1025 16.500					
17.000		119.0	73.0	1025 17.000					
17.460	11/16	123.0	76.0	1025 17.460					
17.500		123.0	76.0	1025 17.500					
18.000		123.0	76.0	1025 18.000					
18.500		127.0	76.0	1025 18.500					
19.000		127.0	76.0	1025 19.000					



Ratio drills without coolant ducts, 3-fluted

Article no. 611



Cutting data page 426

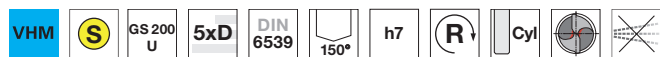

Web thinning $\geq \varnothing 3.000$ • facet point grind • for holes with high alignment accuracy • very good surface quality of hole
 • suitable for interrupted cutting

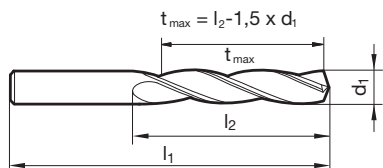

Article no. 611				Article no. 611					
d1 mm	inch	l1 mm	l2 mm	Order no.	d1 mm	inch	l1 mm	l2 mm	Order no.
3.000		46.0	22.0	611 3.000	9.100		84.0	52.0	611 9.100
3.100		49.0	24.0	611 3.100	9.520		89.0	55.0	611 9.520
3.200		49.0	24.0	611 3.200	9.600		89.0	55.0	611 9.600
3.300		49.0	24.0	611 3.300	9.700		89.0	55.0	611 9.700
3.600		52.0	27.0	611 3.600	9.900		89.0	55.0	611 9.900
3.700		52.0	27.0	611 3.700	10.000		89.0	55.0	611 10.000
3.800		55.0	30.0	611 3.800	10.200		89.0	55.0	611 10.200
3.900		55.0	30.0	611 3.900	10.300		89.0	55.0	611 10.300
4.000		55.0	30.0	611 4.000	10.400		89.0	55.0	611 10.400
4.100		55.0	30.0	611 4.100	10.500		89.0	55.0	611 10.500
4.200		55.0	30.0	611 4.200	10.700		95.0	60.0	611 10.700
4.300		58.0	32.0	611 4.300	10.800		95.0	60.0	611 10.800
4.370		58.0	32.0	611 4.370	11.000		95.0	60.0	611 11.000
4.400		58.0	32.0	611 4.400	11.500		95.0	60.0	611 11.500
4.500		58.0	32.0	611 4.500	11.700		95.0	60.0	611 11.700
4.700		58.0	32.0	611 4.700	11.800		95.0	60.0	611 11.800
4.760		62.0	35.0	611 4.760	11.900		102.0	65.0	611 11.900
4.800		62.0	35.0	611 4.800	12.000		102.0	65.0	611 12.000
4.900		62.0	35.0	611 4.900	12.200		102.0	65.0	611 12.200
5.000		62.0	35.0	611 5.000	12.300	31/64	102.0	65.0	611 12.300
5.160	13/64	62.0	35.0	611 5.160	12.400		102.0	65.0	611 12.400
5.300		62.0	35.0	611 5.300	12.700	1/2	102.0	65.0	611 12.700
5.500		66.0	39.0	611 5.500	13.000		102.0	65.0	611 13.000
5.560	7/32	66.0	39.0	611 5.560	13.100		102.0	65.0	611 13.100
5.800		66.0	39.0	611 5.800	13.200		102.0	65.0	611 13.200
5.900		66.0	39.0	611 5.900	13.300		107.0	66.0	611 13.300
6.000		66.0	39.0	611 6.000	13.400		107.0	66.0	611 13.400
6.100		70.0	42.0	611 6.100	13.500		107.0	66.0	611 13.500
6.200		70.0	42.0	611 6.200	13.700		107.0	66.0	611 13.700
6.300		70.0	42.0	611 6.300	14.000		107.0	66.0	611 14.000
6.350	1/4	70.0	42.0	611 6.350	14.200		111.0	70.0	611 14.200
6.400		70.0	42.0	611 6.400	14.300		111.0	70.0	611 14.300
6.500		70.0	42.0	611 6.500	14.400		111.0	70.0	611 14.400
6.600		70.0	42.0	611 6.600	14.500		111.0	70.0	611 14.500
6.800		74.0	45.0	611 6.800	14.800		111.0	70.0	611 14.800
7.000		74.0	45.0	611 7.000	14.900		111.0	70.0	611 14.900
7.100		74.0	45.0	611 7.100	15.000		111.0	70.0	611 15.000
7.200		74.0	45.0	611 7.200	15.200		115.0	73.0	611 15.200
7.300		74.0	45.0	611 7.300	15.500		115.0	73.0	611 15.500
7.400		74.0	45.0	611 7.400	15.900		115.0	73.0	611 15.900
7.500		74.0	45.0	611 7.500	16.500		119.0	73.0	611 16.500
7.900		79.0	48.0	611 7.900	17.000		119.0	73.0	611 17.000
8.000		79.0	48.0	611 8.000	18.000		123.0	76.0	611 18.000
8.100		79.0	48.0	611 8.100	18.500		127.0	76.0	611 18.500
8.200		79.0	48.0	611 8.200	19.000		127.0	76.0	611 19.000
8.500		79.0	48.0	611 8.500	19.500		131.0	79.0	611 19.500
8.800		84.0	52.0	611 8.800					
9.000		84.0	52.0	611 9.000					



Ratio drills with coolant ducts, 3-fluted

Article no. **6590**



Cutting data page 427

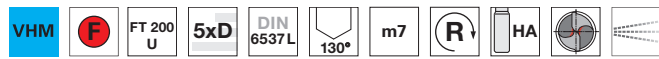

Web thinning $\geq \varnothing 4.000$ • spiropoint grind • optimal centering • suitable for interrupted cutting • maximum performance

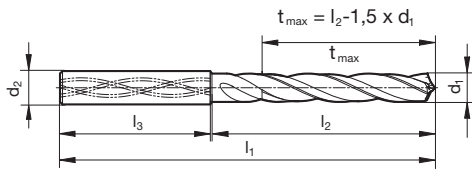

Article no. 6590				Article no. 6590					
d1 mm	inch	l1 mm	l2 mm	Order no.	d1 mm	inch	l1 mm	l2 mm	Order no.
4.000		74.0	36.0	6590 4.000	8.600		103.0	61.0	6590 8.600
4.040		74.0	36.0	6590 4.040	8.700		103.0	61.0	6590 8.700
4.100		74.0	36.0	6590 4.100	8.730	11/32	103.0	61.0	6590 8.730
4.200		74.0	36.0	6590 4.200	8.800		103.0	61.0	6590 8.800
4.300		74.0	36.0	6590 4.300	8.900		103.0	61.0	6590 8.900
4.370	11/64	74.0	36.0	6590 4.370	9.000		103.0	61.0	6590 9.000
4.400		74.0	36.0	6590 4.400	9.100		103.0	61.0	6590 9.100
4.500		74.0	36.0	6590 4.500	9.130	23/64	103.0	61.0	6590 9.130
4.600		74.0	36.0	6590 4.600	9.200		103.0	61.0	6590 9.200
4.650		74.0	36.0	6590 4.650	9.250		103.0	61.0	6590 9.250
4.700		74.0	36.0	6590 4.700	9.300		103.0	61.0	6590 9.300
4.760	3/16	82.0	44.0	6590 4.760	9.340		103.0	61.0	6590 9.340
4.800		82.0	44.0	6590 4.800	9.400		103.0	61.0	6590 9.400
4.900		82.0	44.0	6590 4.900	9.500		103.0	61.0	6590 9.500
5.000		82.0	44.0	6590 5.000	9.520	3/8	103.0	61.0	6590 9.520
5.100		82.0	44.0	6590 5.100	9.550		103.0	61.0	6590 9.550
5.110		82.0	44.0	6590 5.110	9.600		103.0	61.0	6590 9.600
5.160	13/64	82.0	44.0	6590 5.160	9.700		103.0	61.0	6590 9.700
5.200		82.0	44.0	6590 5.200	9.800		103.0	61.0	6590 9.800
5.300		82.0	44.0	6590 5.300	9.900		103.0	61.0	6590 9.900
5.400		82.0	44.0	6590 5.400	9.920	25/64	103.0	61.0	6590 9.920
5.410		82.0	44.0	6590 5.410	10.000		103.0	61.0	6590 10.000
5.500		82.0	44.0	6590 5.500	10.100		118.0	71.0	6590 10.100
5.550		82.0	44.0	6590 5.550	10.200		118.0	71.0	6590 10.200
5.560	7/32	82.0	44.0	6590 5.560	10.300		118.0	71.0	6590 10.300
5.600		82.0	44.0	6590 5.600	10.320	13/32	118.0	71.0	6590 10.320
5.700		82.0	44.0	6590 5.700	10.400		118.0	71.0	6590 10.400
5.800		82.0	44.0	6590 5.800	10.500		118.0	71.0	6590 10.500
5.900		82.0	44.0	6590 5.900	10.600		118.0	71.0	6590 10.600
5.950	15/64	82.0	44.0	6590 5.950	10.700		118.0	71.0	6590 10.700
6.000		82.0	44.0	6590 6.000	10.720	27/64	118.0	71.0	6590 10.720
6.100		91.0	53.0	6590 6.100	10.800		118.0	71.0	6590 10.800
6.200		91.0	53.0	6590 6.200	10.900		118.0	71.0	6590 10.900
6.300		91.0	53.0	6590 6.300	11.000		118.0	71.0	6590 11.000
6.350	1/4	91.0	53.0	6590 6.350	11.100		118.0	71.0	6590 11.100
6.400		91.0	53.0	6590 6.400	11.110	7/16	118.0	71.0	6590 11.110
6.500		91.0	53.0	6590 6.500	11.200		118.0	71.0	6590 11.200
6.530		91.0	53.0	6590 6.530	11.300		118.0	71.0	6590 11.300
6.550		91.0	53.0	6590 6.550	11.400		118.0	71.0	6590 11.400
6.600		91.0	53.0	6590 6.600	11.500		118.0	71.0	6590 11.500
6.700		91.0	53.0	6590 6.700	11.510	29/64	118.0	71.0	6590 11.510
6.750	17/64	91.0	53.0	6590 6.750	11.550		118.0	71.0	6590 11.550
6.800		91.0	53.0	6590 6.800	11.600		118.0	71.0	6590 11.600
6.900		91.0	53.0	6590 6.900	11.700		118.0	71.0	6590 11.700
7.000		91.0	53.0	6590 7.000	11.800		118.0	71.0	6590 11.800
7.100		91.0	53.0	6590 7.100	11.900		118.0	71.0	6590 11.900
7.140	9/32	91.0	53.0	6590 7.140	11.910	15/32	118.0	71.0	6590 11.910
7.200		91.0	53.0	6590 7.200	12.000		118.0	71.0	6590 12.000
7.300		91.0	53.0	6590 7.300	12.100		124.0	77.0	6590 12.100
7.400		91.0	53.0	6590 7.400	12.200		124.0	77.0	6590 12.200
7.500		91.0	53.0	6590 7.500	12.300	31/64	124.0	77.0	6590 12.300
7.540	19/64	91.0	53.0	6590 7.540	12.400		124.0	77.0	6590 12.400
7.550		91.0	53.0	6590 7.550	12.500		124.0	77.0	6590 12.500
7.600		91.0	53.0	6590 7.600	12.600		124.0	77.0	6590 12.600
7.650		91.0	53.0	6590 7.650	12.700	1/2	124.0	77.0	6590 12.700
7.700		91.0	53.0	6590 7.700	12.800		124.0	77.0	6590 12.800
7.800		91.0	53.0	6590 7.800	12.900		124.0	77.0	6590 12.900
7.900		91.0	53.0	6590 7.900	13.000		124.0	77.0	6590 13.000
7.940	5/16	91.0	53.0	6590 7.940	13.100	33/64	124.0	77.0	6590 13.100
8.000		91.0	53.0	6590 8.000	13.200		124.0	77.0	6590 13.200
8.100		103.0	61.0	6590 8.100	13.300		124.0	77.0	6590 13.300
8.200		103.0	61.0	6590 8.200	13.400		124.0	77.0	6590 13.400
8.300		103.0	61.0	6590 8.300	13.490	17/32	124.0	77.0	6590 13.490
8.330	21/64	103.0	61.0	6590 8.330	13.500		124.0	77.0	6590 13.500
8.400		103.0	61.0	6590 8.400	13.600		124.0	77.0	6590 13.600
8.500		103.0	61.0	6590 8.500	13.700		124.0	77.0	6590 13.700



Article no.				6590	Article no.				6590
d1 mm	inch	l1 mm	l2 mm	Order no.	d1 mm	inch	l1 mm	l2 mm	Order no.
13.800		124.0	77.0	6590 13.800	16.270	41/64	143.0	93.0	6590 16.270
13.890	35/64	124.0	77.0	6590 13.890	16.300		143.0	93.0	6590 16.300
13.900		124.0	77.0	6590 13.900	16.500		143.0	93.0	6590 16.500
14.000		124.0	77.0	6590 14.000	16.670	21/32	143.0	93.0	6590 16.670
14.100		133.0	83.0	6590 14.100	16.700		143.0	93.0	6590 16.700
14.200		133.0	83.0	6590 14.200	16.900		143.0	93.0	6590 16.900
14.290	9/16	133.0	83.0	6590 14.290	17.000		143.0	93.0	6590 17.000
14.300		133.0	83.0	6590 14.300	17.070	43/64	143.0	93.0	6590 17.070
14.400		133.0	83.0	6590 14.400	17.460	11/16	143.0	93.0	6590 17.460
14.500		133.0	83.0	6590 14.500	17.500		143.0	93.0	6590 17.500
14.600		133.0	83.0	6590 14.600	17.550		143.0	93.0	6590 17.550
14.680	37/64	133.0	83.0	6590 14.680	17.700		143.0	93.0	6590 17.700
14.700		133.0	83.0	6590 14.700	17.860	45/64	143.0	93.0	6590 17.860
14.800		133.0	83.0	6590 14.800	18.000		143.0	93.0	6590 18.000
14.900		133.0	83.0	6590 14.900	18.260	23/32	153.0	101.0	6590 18.260
15.000		133.0	83.0	6590 15.000	18.500		153.0	101.0	6590 18.500
15.080	19/32	133.0	83.0	6590 15.080	18.700		153.0	101.0	6590 18.700
15.100		133.0	83.0	6590 15.100	18.900		153.0	101.0	6590 18.900
15.200		133.0	83.0	6590 15.200	19.000		153.0	101.0	6590 19.000
15.300		133.0	83.0	6590 15.300	19.050	3/4	153.0	101.0	6590 19.050
15.400		133.0	83.0	6590 15.400	19.250		153.0	101.0	6590 19.250
15.480	39/64	133.0	83.0	6590 15.480	19.300		153.0	101.0	6590 19.300
15.500		133.0	83.0	6590 15.500	19.450	49/64	153.0	101.0	6590 19.450
15.550		133.0	83.0	6590 15.550	19.500		153.0	101.0	6590 19.500
15.600		133.0	83.0	6590 15.600	19.550		153.0	101.0	6590 19.550
15.700		133.0	83.0	6590 15.700	19.700		153.0	101.0	6590 19.700
15.800		133.0	83.0	6590 15.800	19.800		153.0	101.0	6590 19.800
15.870	5/8	133.0	83.0	6590 15.870	19.840	25/32	153.0	101.0	6590 19.840
15.900		133.0	83.0	6590 15.900	20.000		153.0	101.0	6590 20.000
16.000		133.0	83.0	6590 16.000					



Solid carbide drills

Twist drills with reinforced straight shank

Article no. **1946**



Cutting data page 428

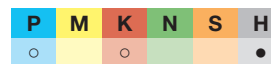
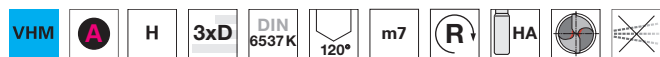

Web thinning $\geq \varnothing 2.600$ • facet point grind • main cutting edge form straight (after correction)

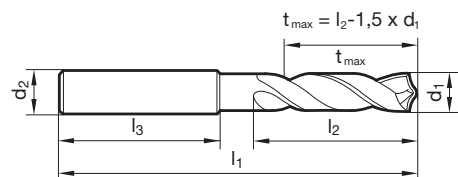

Article no. **1946**

d1 mm	d2 h6 mm	l1 mm	l2 mm	l3 mm	Order no.
2.600	6.0	62.0	20.0	36.0	1946 2.600
3.000	6.0	62.0	20.0	36.0	1946 3.000
3.400	6.0	62.0	20.0	36.0	1946 3.400
4.000	6.0	66.0	24.0	36.0	1946 4.000
4.300	6.0	66.0	24.0	36.0	1946 4.300
5.000	6.0	66.0	28.0	36.0	1946 5.000
5.100	6.0	66.0	28.0	36.0	1946 5.100
5.600	6.0	66.0	28.0	36.0	1946 5.600
6.000	6.0	66.0	28.0	36.0	1946 6.000
6.900	8.0	79.0	34.0	36.0	1946 6.900
7.100	8.0	79.0	41.0	36.0	1946 7.100
8.000	8.0	79.0	41.0	36.0	1946 8.000

Article no. **1946**

d1 mm	d2 h6 mm	l1 mm	l2 mm	l3 mm	Order no.
8.600	10.0	89.0	47.0	40.0	1946 8.600
9.100	10.0	89.0	47.0	40.0	1946 9.100
10.000	10.0	89.0	47.0	40.0	1946 10.000
10.400	12.0	102.0	55.0	45.0	1946 10.400
10.600	12.0	102.0	55.0	45.0	1946 10.600
11.100	12.0	102.0	55.0	45.0	1946 11.100
12.000	12.0	102.0	55.0	45.0	1946 12.000
14.100	16.0	115.0	65.0	48.0	1946 14.100



Carbide-tipped twist drills

Article no. 703



Cutting data page 429

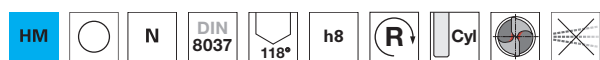

Web thinning $\geq \varnothing 1.700$ • facet point grind • carbide-tipped

P	M	K	N	S	H
○	○	○	○	○	○

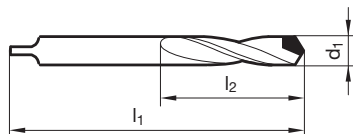

Article no.			703	Article no.			703
d1 mm	l1 mm	l2 mm	Order no.	d1 mm	l1 mm	l2 mm	Order no.
1.700	45.0	18.0	703 1.700	8.000	80.0	40.0	703 8.000
1.900	45.0	18.0	703 1.900	8.100	90.0	50.0	703 8.100
2.200	45.0	18.0	703 2.200	8.150	90.0	50.0	703 8.150
2.300	45.0	18.0	703 2.300	8.200	90.0	50.0	703 8.200
2.600	50.0	20.0	703 2.600	8.300	90.0	50.0	703 8.300
2.700	50.0	20.0	703 2.700	8.400	90.0	50.0	703 8.400
2.800	50.0	20.0	703 2.800	8.500	90.0	50.0	703 8.500
2.900	50.0	20.0	703 2.900	8.600	90.0	50.0	703 8.600
3.000	50.0	20.0	703 3.000	8.700	90.0	50.0	703 8.700
3.100	56.0	25.0	703 3.100	8.750	90.0	50.0	703 8.750
3.200	56.0	25.0	703 3.200	8.800	90.0	50.0	703 8.800
3.250	56.0	25.0	703 3.250	8.900	90.0	50.0	703 8.900
3.300	56.0	25.0	703 3.300	9.000	90.0	50.0	703 9.000
3.400	56.0	25.0	703 3.400	9.100	90.0	50.0	703 9.100
3.500	56.0	25.0	703 3.500	9.200	90.0	50.0	703 9.200
3.550	56.0	25.0	703 3.550	9.300	90.0	50.0	703 9.300
3.600	56.0	25.0	703 3.600	9.400	90.0	50.0	703 9.400
3.700	56.0	25.0	703 3.700	9.500	90.0	50.0	703 9.500
3.800	56.0	25.0	703 3.800	9.600	100.0	56.0	703 9.600
3.900	56.0	25.0	703 3.900	9.700	100.0	56.0	703 9.700
4.000	56.0	25.0	703 4.000	9.800	100.0	56.0	703 9.800
4.100	63.0	28.0	703 4.100	9.900	100.0	56.0	703 9.900
4.200	63.0	28.0	703 4.200	10.000	100.0	56.0	703 10.000
4.250	63.0	28.0	703 4.250	10.100	100.0	56.0	703 10.100
4.300	63.0	28.0	703 4.300	10.200	100.0	56.0	703 10.200
4.400	63.0	28.0	703 4.400	10.300	100.0	56.0	703 10.300
4.500	63.0	28.0	703 4.500	10.400	100.0	56.0	703 10.400
4.600	63.0	28.0	703 4.600	10.500	100.0	56.0	703 10.500
4.700	63.0	28.0	703 4.700	10.600	100.0	56.0	703 10.600
4.750	63.0	28.0	703 4.750	10.700	100.0	56.0	703 10.700
4.800	63.0	28.0	703 4.800	10.800	100.0	56.0	703 10.800
4.900	63.0	28.0	703 4.900	11.000	100.0	56.0	703 11.000
5.000	63.0	28.0	703 5.000	11.200	112.0	63.0	703 11.200
5.100	71.0	32.0	703 5.100	11.250	112.0	63.0	703 11.250
5.200	71.0	32.0	703 5.200	11.300	112.0	63.0	703 11.300
5.300	71.0	32.0	703 5.300	11.500	112.0	63.0	703 11.500
5.400	71.0	32.0	703 5.400	11.600	112.0	63.0	703 11.600
5.500	71.0	32.0	703 5.500	11.800	112.0	63.0	703 11.800
5.600	71.0	32.0	703 5.600	11.900	112.0	63.0	703 11.900
5.650	71.0	32.0	703 5.650	12.000	112.0	63.0	703 12.000
5.700	71.0	32.0	703 5.700	12.200	112.0	63.0	703 12.200
5.800	71.0	32.0	703 5.800	12.300	112.0	63.0	703 12.300
5.900	71.0	32.0	703 5.900	12.400	112.0	63.0	703 12.400
6.000	71.0	32.0	703 6.000	12.500	112.0	63.0	703 12.500
6.100	71.0	32.0	703 6.100	12.700	112.0	63.0	703 12.700
6.200	71.0	32.0	703 6.200	12.800	112.0	63.0	703 12.800
6.300	71.0	32.0	703 6.300	13.000	112.0	63.0	703 13.000
6.350	71.0	32.0	703 6.350	13.100	125.0	71.0	703 13.100
6.400	71.0	32.0	703 6.400	13.200	125.0	71.0	703 13.200
6.500	71.0	32.0	703 6.500	13.300	125.0	71.0	703 13.300
6.600	80.0	40.0	703 6.600	13.500	125.0	71.0	703 13.500
6.700	80.0	40.0	703 6.700	13.800	125.0	71.0	703 13.800
6.750	80.0	40.0	703 6.750	14.000	125.0	71.0	703 14.000
6.800	80.0	40.0	703 6.800	14.100	125.0	71.0	703 14.100
6.900	80.0	40.0	703 6.900	14.250	125.0	71.0	703 14.250
7.000	80.0	40.0	703 7.000	14.500	125.0	71.0	703 14.500
7.100	80.0	40.0	703 7.100	14.750	125.0	71.0	703 14.750
7.200	80.0	40.0	703 7.200	15.000	125.0	71.0	703 15.000
7.300	80.0	40.0	703 7.300	15.250	140.0	80.0	703 15.250
7.400	80.0	40.0	703 7.400	15.500	140.0	80.0	703 15.500
7.500	80.0	40.0	703 7.500	16.000	140.0	80.0	703 16.000
7.600	80.0	40.0	703 7.600	16.500	140.0	80.0	703 16.500
7.700	80.0	40.0	703 7.700	17.000	140.0	80.0	703 17.000
7.800	80.0	40.0	703 7.800	17.500	160.0	90.0	703 17.500
7.900	80.0	40.0	703 7.900	18.000	160.0	90.0	703 18.000
7.940	80.0	40.0	703 7.940	18.260	160.0	90.0	703 18.260



Brazed solid carbide drills

Article no.			703	Article no.			703
d1 mm	l1 mm	l2 mm	Order no.	d1 mm	l1 mm	l2 mm	Order no.
18.500	160.0	90.0	703 18.500	21.500	160.0	90.0	703 21.500
19.000	160.0	90.0	703 19.000	22.000	160.0	90.0	703 22.000
19.500	160.0	90.0	703 19.500	22.500	170.0	100.0	703 22.500
20.000	160.0	90.0	703 20.000	23.000	170.0	100.0	703 23.000
20.500	160.0	90.0	703 20.500	23.500	170.0	100.0	703 23.500
21.000	160.0	90.0	703 21.000	24.000	170.0	100.0	703 24.000



Tool holders for interchangeable inserts HT 800

Article no. 4105



nickel-plated • especially high wear resistance • optimised flute cross-section • optimised coolant duct exit • clamping screws art. no. 4071 and 6128 included • order screwdriver art. no. 1612 separately

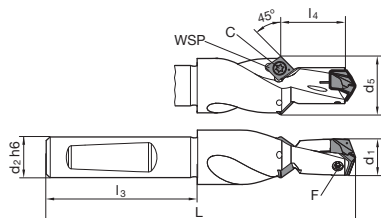

Article no. 4105

Holder size	d1	d2 h6 mm	d5 mm	L mm	l3 mm	l4 mm	WSP	C	F	Order no.
110	11.00-11.99	12.0	17.000	81.0	45.0	12.0	CP..0502..	6128 2.000	4071 2.200	4105 11.000
110	11.00-11.99	12.7	17.000	81.0	45.0	12.0	CP..0502..	6128 2.000	4071 2.200	4105 11.005
120	12.00-12.99	12.0	18.000	84.0	45.0	13.0	CP..0502..	6128 2.000	4071 2.201	4105 12.000
120	12.00-12.99	12.7	18.000	84.0	45.0	13.0	CP..0502..	6128 2.000	4071 2.201	4105 12.005
130	13.00-13.99	14.0	18.000	86.0	45.0	14.0	CP..0502..	6128 2.000	4071 2.500	4105 13.000
130	13.00-13.99	15.8	18.000	86.0	45.0	14.0	CP..0502..	6128 2.000	4071 2.500	4105 13.005
140	14.00-15.99	16.0	18.000	93.0	48.0	16.0	CP..0502..	6128 2.000	4071 3.000	4105 14.000
140	14.00-15.99	15.8	18.000	93.0	48.0	16.0	CP..0502..	6128 2.000	4071 3.000	4105 14.005
160	16.00-17.99	18.0	20.000	99.0	48.0	18.0	CP..0602..	6128 2.500	4071 3.500	4105 16.000
160	16.00-17.99	19.0	20.000	99.0	48.0	18.0	CP..0602..	6128 2.500	4071 3.500	4105 16.005
180	18.00-19.99	20.0	22.000	106.0	50.0	20.0	CP..0602..	6128 2.500	4071 4.000	4105 18.000
180	18.00-19.99	19.0	22.000	106.0	50.0	20.0	CP..0602..	6128 2.500	4071 4.000	4105 18.005
200	20.00-21.99	25.0	25.000	117.0	56.0	22.0	CP..0602..	6128 2.500	4071 4.500	4105 20.000
200	20.00-21.99	25.4	25.400	117.0	56.0	22.0	CP..0602..	6128 2.500	4071 4.500	4105 20.005
220	22.00-23.99	25.0	26.000	122.0	56.0	24.0	CP..0602..	6128 2.500	4071 5.000	4105 22.000
220	22.00-23.99	25.4	26.000	122.0	56.0	24.0	CP..0602..	6128 2.500	4071 5.000	4105 22.005
240	24.00-25.99	25.0	28.000	128.0	56.0	26.0	CP..0602..	6128 2.500	4071 5.001	4105 24.000
240	24.00-25.99	25.4	28.000	128.0	56.0	26.0	CP..0602..	6128 2.500	4071 5.001	4105 24.005
260	26.00-27.99	32.0	32.000	142.0	60.0	28.0	CP..0602..	6128 2.500	4071 5.003	4105 26.000
260	26.00-27.99	31.7	32.000	142.0	60.0	28.0	CP..0602..	6128 2.500	4071 5.003	4105 26.005
280	28.00-29.99	32.0	34.000	147.0	60.0	30.0	CP..0602..	6128 2.500	4071 5.003	4105 28.000
280	28.00-29.99	31.7	34.000	147.0	60.0	30.0	CP..0602..	6128 2.500	4071 5.003	4105 28.005
300	30.00-31.99	32.0	38.000	152.0	60.0	32.0	CP..09T3..	6128 4.006	4071 6.000	4105 30.000
300	30.00-31.99	31.7	38.000	152.0	60.0	32.0	CP..09T3..	6128 4.006	4071 6.000	4105 30.005
320	32.00-35.99	32.0	42.000	163.0	60.0	36.0	CP..09T3..	6128 4.006	4071 6.001	4105 32.000
320	32.00-35.99	31.7	42.000	163.0	60.0	36.0	CP..09T3..	6128 4.006	4071 6.001	4105 32.005
360	36.00-40.00	32.0	46.000	173.0	60.0	40.0	CP..09T3..	6128 4.006	4071 6.002	4105 36.000
360	36.00-40.00	31.7	46.000	173.0	60.0	40.0	CP..09T3..	6128 4.006	4071 6.002	4105 36.005



Modular drills with cutting insert

Modular drills

Tool holders for interchangeable inserts HT 800

Article no. **4106**



nickel-plated • especially high wear resistance • optimised coolant duct exit • optimised flute cross-section • clamping screws art. no. 4071 included • order screwdriver art. no. 1612 separately

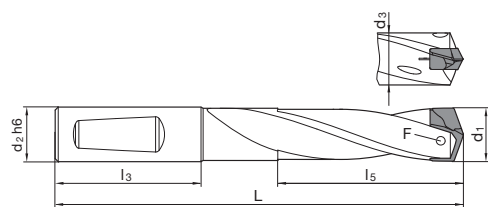

Article no.

4106

Holder size	d1	d2 h6 mm	d3 mm	L mm	l3 mm	l5 mm	F	Order no.
110	11.00-11.49	12.000	10.7	84.0	45.0	19.3	4071 2.200	4106 11.000
110	11.00-11.49	12.700	10.7	84.0	45.0	19.3	4071 2.200	4106 11.005
115	11.50-11.99	12.000	11.2	85.0	45.0	20.1	4071 2.200	4106 11.500
115	11.50-11.99	12.700	11.2	85.0	45.0	20.1	4071 2.200	4106 11.505
120	12.00-12.49	12.000	11.7	87.0	45.0	21.0	4071 2.201	4106 12.000
120	12.00-12.49	12.700	11.7	87.0	45.0	21.0	4071 2.201	4106 12.005
125	12.50-12.99	14.000	12.2	89.0	45.0	21.9	4071 2.201	4106 12.500
125	12.50-12.99	15.875	12.2	89.0	45.0	21.9	4071 2.201	4106 12.505
130	13.00-13.49	14.000	12.7	90.0	45.0	22.6	4071 2.500	4106 13.000
130	13.00-13.49	15.875	12.7	90.0	45.0	22.6	4071 2.500	4106 13.005
135	13.50-13.99	14.000	13.2	92.0	45.0	23.6	4071 2.500	4106 13.500
135	13.50-13.99	15.875	13.2	92.0	45.0	23.6	4071 2.500	4106 13.505
140	14.00-14.49	14.000	13.7	93.0	45.0	24.5	4071 3.000	4106 14.000
140	14.00-14.49	15.875	13.7	93.0	45.0	24.5	4071 3.000	4106 14.005
145	14.50-14.99	16.000	14.2	98.0	48.0	25.3	4071 3.000	4106 14.500
145	14.50-14.99	15.875	14.2	98.0	48.0	25.3	4071 3.000	4106 14.505
150	15.00-15.49	16.000	14.7	100.0	48.0	26.1	4071 3.001	4106 15.000
150	15.00-15.49	15.875	14.7	100.0	48.0	26.1	4071 3.001	4106 15.005
155	15.50-15.99	16.000	15.2	101.0	48.0	27.0	4071 3.001	4106 15.500
155	15.50-15.99	15.875	15.2	101.0	48.0	27.0	4071 3.001	4106 15.505
160	16.00-16.49	16.000	15.7	102.0	48.0	27.8	4071 3.500	4106 16.000
160	16.00-16.49	15.875	15.7	102.0	48.0	27.8	4071 3.500	4106 16.005
165	16.50-16.99	18.000	16.2	105.0	48.0	28.7	4071 3.500	4106 16.500
165	16.50-16.99	19.050	16.2	105.0	48.0	28.7	4071 3.500	4106 16.505
170	17.00-17.49	18.000	16.7	106.0	48.0	29.6	4071 3.500	4106 17.000
170	17.00-17.49	19.050	16.7	106.0	48.0	29.6	4071 3.500	4106 17.005
175	17.50-17.99	18.000	17.2	107.0	48.0	30.4	4071 3.500	4106 17.500
175	17.50-17.99	19.050	17.2	107.0	48.0	30.4	4071 3.500	4106 17.505
180	18.00-18.49	18.000	17.7	109.0	48.0	31.2	4071 4.000	4106 18.000
180	18.00-18.49	19.050	17.7	109.0	48.0	31.2	4071 4.000	4106 18.005
185	18.50-18.99	20.000	18.2	113.0	50.0	32.1	4071 4.000	4106 18.500
185	18.50-18.99	19.050	18.2	113.0	50.0	32.1	4071 4.000	4106 18.505
190	19.00-19.49	20.000	18.7	114.0	50.0	32.9	4071 4.000	4106 19.000
190	19.00-19.49	19.050	18.7	114.0	50.0	32.9	4071 4.000	4106 19.005
195	19.50-19.99	20.000	19.2	116.0	50.0	33.7	4071 4.000	4106 19.500
195	19.50-19.99	19.050	19.2	116.0	50.0	33.7	4071 4.000	4106 19.505
200	20.00-20.49	20.000	19.7	117.0	50.0	34.6	4071 4.500	4106 20.000
200	20.00-20.49	19.050	19.7	117.0	50.0	34.6	4071 4.500	4106 20.005
205	20.50-20.99	25.000	20.2	128.0	56.0	35.5	4071 4.500	4106 20.500
205	20.50-20.99	25.400	20.2	128.0	56.0	35.5	4071 4.500	4106 20.505
210	21.00-21.49	25.000	20.7	129.0	56.0	36.4	4071 4.500	4106 21.000
210	21.00-21.49	25.400	20.7	129.0	56.0	36.4	4071 4.500	4106 21.005
215	21.50-21.99	25.000	21.2	130.0	56.0	37.2	4071 4.500	4106 21.500
215	21.50-21.99	25.400	21.2	130.0	56.0	37.2	4071 4.500	4106 21.505
220	22.00-22.49	25.000	21.7	131.0	56.0	38.0	4071 5.000	4106 22.000
220	22.00-22.49	25.400	21.7	131.0	56.0	38.0	4071 5.000	4106 22.005
225	22.50-22.99	25.000	22.2	134.0	56.0	38.9	4071 5.000	4106 22.500
225	22.50-22.99	25.400	22.2	134.0	56.0	38.9	4071 5.000	4106 22.505
230	23.00-23.49	25.000	22.7	135.0	56.0	39.8	4071 5.000	4106 23.000
230	23.00-23.49	25.400	22.7	135.0	56.0	39.8	4071 5.000	4106 23.005
235	23.50-23.99	25.000	23.2	137.0	56.0	40.6	4071 5.000	4106 23.500
235	23.50-23.99	25.400	23.2	137.0	56.0	40.6	4071 5.000	4106 23.505
240	24.00-24.49	25.000	23.7	138.0	56.0	41.5	4071 5.001	4106 24.000
240	24.00-24.49	25.400	23.7	138.0	56.0	41.5	4071 5.001	4106 24.005
245	24.50-24.99	25.000	24.2	140.0	56.0	42.3	4071 5.001	4106 24.500
245	24.50-24.99	25.400	24.2	140.0	56.0	42.3	4071 5.001	4106 24.505
250	25.00-25.49	25.000	24.7	142.0	56.0	43.2	4071 5.001	4106 25.000
250	25.00-25.49	25.400	24.7	142.0	56.0	43.2	4071 5.001	4106 25.005
255	25.50-25.99	32.000	25.2	148.0	60.0	44.0	4071 5.001	4106 25.500
255	25.50-25.99	31.750	25.2	148.0	60.0	44.0	4071 5.001	4106 25.505



Article no.								4106
Holder size	d1	d2 h6 mm	d3 mm	L mm	l3 mm	l5 mm	F	Order no.
260	26.00-26.49	32.000	25.7	151.0	60.0	44.3	4071 5.003	4106 26.000
260	26.00-26.49	31.750	25.7	151.0	60.0	44.3	4071 5.003	4106 26.005
265	26.50-26.99	32.000	26.2	153.0	60.0	45.1	4071 5.003	4106 26.500
265	26.50-26.99	31.750	26.2	153.0	60.0	45.1	4071 5.003	4106 26.505
270	27.00-27.49	32.000	26.7	155.0	60.0	46.0	4071 5.003	4106 27.000
270	27.00-27.49	31.750	26.7	155.0	60.0	46.0	4071 5.003	4106 27.005
275	27.50-27.99	32.000	27.2	156.0	60.0	46.8	4071 5.003	4106 27.500
275	27.50-27.99	31.750	27.2	156.0	60.0	46.8	4071 5.003	4106 27.505
280	28.00-28.49	32.000	27.7	157.0	60.0	47.7	4071 5.003	4106 28.000
280	28.00-28.49	31.750	27.7	157.0	60.0	47.7	4071 5.003	4106 28.005
285	28.50-28.99	32.000	28.2	159.0	60.0	48.5	4071 5.003	4106 28.500
285	28.50-28.99	31.750	28.2	159.0	60.0	48.5	4071 5.003	4106 28.505
290	29.00-29.49	32.000	28.7	161.0	60.0	49.4	4071 5.003	4106 29.000
290	29.00-29.49	31.750	28.7	161.0	60.0	49.4	4071 5.003	4106 29.005
295	29.50-29.99	32.000	29.2	162.0	60.0	50.2	4071 5.003	4106 29.500
295	29.50-29.99	31.750	29.2	162.0	60.0	50.2	4071 5.003	4106 29.505
300	30.00-30.49	32.000	29.7	164.0	60.0	50.9	4071 6.000	4106 30.000
300	30.00-30.49	31.750	29.7	164.0	60.0	50.9	4071 6.000	4106 30.005
305	30.50-30.99	32.000	30.2	166.0	60.0	51.7	4071 6.000	4106 30.500
305	30.50-30.99	31.750	30.2	166.0	60.0	51.7	4071 6.000	4106 30.505
310	31.00-31.49	32.000	30.7	167.0	60.0	52.6	4071 6.000	4106 31.000
310	31.00-31.49	31.750	30.7	167.0	60.0	52.6	4071 6.000	4106 31.005
315	31.50-31.99	32.000	31.2	168.0	60.0	53.4	4071 6.000	4106 31.500
315	31.50-31.99	31.750	31.2	168.0	60.0	53.4	4071 6.000	4106 31.505
320	32.00-32.99	32.000	31.7	172.0	60.0	55.1	4071 6.001	4106 32.000
320	32.00-32.99	31.750	31.7	172.0	60.0	55.1	4071 6.001	4106 32.005
330	33.00-33.99	32.000	32.7	175.0	60.0	56.8	4071 6.001	4106 33.000
330	33.00-33.99	31.750	32.7	175.0	60.0	56.8	4071 6.001	4106 33.005
340	34.00-34.99	32.000	33.7	178.0	60.0	58.5	4071 6.001	4106 34.000
340	34.00-34.99	31.750	33.7	178.0	60.0	58.5	4071 6.001	4106 34.005
350	35.00-35.99	32.000	34.7	181.0	60.0	60.2	4071 6.001	4106 35.000
350	35.00-35.99	31.750	34.7	181.0	60.0	60.2	4071 6.001	4106 35.005
360	36.00-36.99	32.000	35.7	184.0	60.0	61.8	4071 6.002	4106 36.000
360	36.00-36.99	31.750	35.7	184.0	60.0	61.8	4071 6.002	4106 36.005
370	37.00-37.99	32.000	36.7	188.0	60.0	63.5	4071 6.002	4106 37.000
370	37.00-37.99	31.750	36.7	188.0	60.0	63.5	4071 6.002	4106 37.005
380	38.00-38.99	32.000	37.7	191.0	60.0	65.2	4071 6.002	4106 38.000
380	38.00-38.99	31.750	37.7	191.0	60.0	65.2	4071 6.002	4106 38.005
390	39.00-40.00	32.000	38.7	194.0	60.0	66.9	4071 6.002	4106 39.000
390	39.00-40.00	31.750	38.7	194.0	60.0	66.9	4071 6.002	4106 39.005

Modular drills



Modular drills with cutting insert

Modular drills

Tool holders for interchangeable inserts HT 800

Article no. **4107**



nickel-plated • especially high wear resistance • optimised coolant duct exit • optimised flute cross-section • clamping screws art. no. 4071 included • order screwdriver art. no. 1612 separately

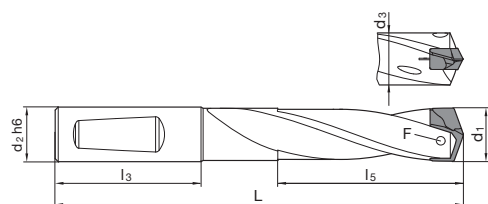

Article no.

4107

Holder size	d1	d2 h6 mm	d3 mm	L mm	l3 mm	l5 mm	F	Order no.
110	11.00-11.49	12.000	10.7	101.0	45.0	36.6	4071 2.200	4107 11.000
110	11.00-11.49	12.700	10.7	101.0	45.0	36.6	4071 2.200	4107 11.005
115	11.50-11.99	12.000	11.2	103.0	45.0	38.1	4071 2.200	4107 11.500
115	11.50-11.99	12.700	11.2	103.0	45.0	38.1	4071 2.200	4107 11.505
120	12.00-12.49	12.000	11.7	106.0	45.0	39.7	4071 2.201	4107 12.000
120	12.00-12.49	12.700	11.7	106.0	45.0	39.7	4071 2.201	4107 12.005
125	12.50-12.99	14.000	12.2	108.0	45.0	41.3	4071 2.201	4107 12.500
125	12.50-12.99	15.875	12.2	108.0	45.0	41.3	4071 2.201	4107 12.505
130	13.00-13.49	14.000	12.7	110.0	45.0	42.9	4071 2.500	4107 13.000
130	13.00-13.49	15.875	12.7	110.0	45.0	42.9	4071 2.500	4107 13.005
135	13.50-13.99	14.000	13.2	113.0	45.0	44.6	4071 2.500	4107 13.500
135	13.50-13.99	15.875	13.2	113.0	45.0	44.6	4071 2.500	4107 13.505
140	14.00-14.49	14.000	13.7	115.0	45.0	46.2	4071 3.000	4107 14.000
140	14.00-14.49	15.875	13.7	115.0	45.0	46.2	4071 3.000	4107 14.005
145	14.50-14.99	16.000	14.2	120.0	48.0	47.8	4071 3.000	4107 14.500
145	14.50-14.99	15.875	14.2	120.0	48.0	47.8	4071 3.000	4107 14.505
150	15.00-15.49	16.000	14.7	123.0	48.0	49.3	4071 3.001	4107 15.000
150	15.00-15.49	15.875	14.7	123.0	48.0	49.3	4071 3.001	4107 15.005
155	15.50-15.99	16.000	15.2	125.0	48.0	50.9	4071 3.001	4107 15.500
155	15.50-15.99	15.875	15.2	125.0	48.0	50.9	4071 3.001	4107 15.505
160	16.00-16.49	16.000	15.7	127.0	48.0	52.9	4071 3.500	4107 16.000
160	16.00-16.49	15.875	15.7	127.0	48.0	52.9	4071 3.500	4107 16.005
165	16.50-16.99	18.000	16.2	130.0	48.0	54.1	4071 3.500	4107 16.500
165	16.50-16.99	19.050	16.2	130.0	48.0	54.1	4071 3.500	4107 16.505
170	17.00-17.49	18.000	16.7	132.0	48.0	55.8	4071 3.500	4107 17.000
170	17.00-17.49	19.050	16.7	132.0	48.0	55.8	4071 3.500	4107 17.005
175	17.50-17.99	18.000	17.2	134.0	48.0	57.4	4071 3.500	4107 17.500
175	17.50-17.99	19.050	17.2	134.0	48.0	57.4	4071 3.500	4107 17.505
180	18.00-18.49	18.000	17.7	137.0	48.0	58.9	4071 4.000	4107 18.000
180	18.00-18.49	19.050	17.7	137.0	48.0	58.9	4071 4.000	4107 18.005
185	18.50-18.99	20.000	18.2	141.0	50.0	60.5	4071 4.000	4107 18.500
185	18.50-18.99	19.050	18.2	141.0	50.0	60.5	4071 4.000	4107 18.505
190	19.00-19.49	20.000	18.7	143.0	50.0	62.1	4071 4.000	4107 19.000
190	19.00-19.49	19.050	18.7	143.0	50.0	62.1	4071 4.000	4107 19.005
195	19.50-19.99	20.000	19.2	146.0	50.0	63.7	4071 4.000	4107 19.500
195	19.50-19.99	19.050	19.2	146.0	50.0	63.7	4071 4.000	4107 19.505
200	20.00-20.49	20.000	19.7	148.0	50.0	65.3	4071 4.500	4107 20.000
200	20.00-20.49	19.050	19.7	148.0	50.0	65.3	4071 4.500	4107 20.005
205	20.50-20.99	25.000	20.2	159.0	56.0	67.0	4071 4.500	4107 20.500
205	20.50-20.99	25.400	20.2	159.0	56.0	67.0	4071 4.500	4107 20.505
210	21.00-21.49	25.000	20.7	161.0	56.0	68.6	4071 4.500	4107 21.000
210	21.00-21.49	25.400	20.7	161.0	56.0	68.6	4071 4.500	4107 21.005
215	21.50-21.99	25.000	21.2	163.0	56.0	70.1	4071 4.500	4107 21.500
215	21.50-21.99	25.400	21.2	163.0	56.0	70.1	4071 4.500	4107 21.505
220	22.00-22.49	25.000	21.7	165.0	56.0	71.7	4071 5.000	4107 22.000
220	22.00-22.49	25.400	21.7	165.0	56.0	71.7	4071 5.000	4107 22.005
225	22.50-22.99	25.000	22.2	168.0	56.0	73.3	4071 5.000	4107 22.500
225	22.50-22.99	25.400	22.2	168.0	56.0	73.3	4071 5.000	4107 22.505
230	23.00-23.49	25.000	22.7	170.0	56.0	74.9	4071 5.000	4107 23.000
230	23.00-23.49	25.400	22.7	170.0	56.0	74.9	4071 5.000	4107 23.005
235	23.50-23.99	25.000	23.2	173.0	56.0	76.5	4071 5.000	4107 23.500
235	23.50-23.99	25.400	23.2	173.0	56.0	76.5	4071 5.000	4107 23.505
240	24.00-24.49	25.000	23.7	175.0	56.0	78.1	4071 5.001	4107 24.000
240	24.00-24.49	25.400	23.7	175.0	56.0	78.1	4071 5.001	4107 24.005
245	24.50-24.99	25.000	24.2	177.0	56.0	79.7	4071 5.001	4107 24.500
245	24.50-24.99	25.400	24.2	177.0	56.0	79.7	4071 5.001	4107 24.505
250	25.00-25.49	25.000	24.7	180.0	56.0	81.3	4071 5.001	4107 25.000
250	25.00-25.49	25.400	24.7	180.0	56.0	81.3	4071 5.001	4107 25.005
255	25.50-25.99	32.000	25.2	187.0	60.0	82.9	4071 5.001	4107 25.500
255	25.50-25.99	31.750	25.2	187.0	60.0	82.9	4071 5.001	4107 25.505



Article no.								4107
Holder size	d1	d2 h6 mm	d3 mm	L mm	l3 mm	l5 mm	F	Order no.
260	26.00-26.49	32.000	25.7	191.0	60.0	84.0	4071 5.003	4107 26.000
260	26.00-26.49	31.750	25.7	191.0	60.0	84.0	4071 5.003	4107 26.005
265	26.50-26.99	32.000	26.2	193.0	60.0	86.1	4071 5.003	4107 26.500
265	26.50-26.99	31.750	26.2	193.0	60.0	86.1	4071 5.003	4107 26.505
270	27.00-27.49	32.000	26.7	196.0	60.0	87.2	4071 5.003	4107 27.000
270	27.00-27.49	31.750	26.7	196.0	60.0	87.2	4071 5.003	4107 27.005
275	27.50-27.99	32.000	27.2	198.0	60.0	88.9	4071 5.003	4107 27.500
275	27.50-27.99	31.750	27.2	198.0	60.0	88.9	4071 5.003	4107 27.505
280	28.00-28.49	32.000	27.7	200.0	60.0	90.4	4071 5.003	4107 28.000
280	28.00-28.49	31.750	27.7	200.0	60.0	90.4	4071 5.003	4107 28.005
285	28.50-28.99	32.000	28.2	202.0	60.0	92.5	4071 5.003	4107 28.500
285	28.50-28.99	31.750	28.2	202.0	60.0	92.5	4071 5.003	4107 28.505
290	29.00-29.49	32.000	28.7	205.0	60.0	94.6	4071 5.003	4107 29.000
290	29.00-29.49	31.750	28.7	205.0	60.0	94.6	4071 5.003	4107 29.005
295	29.50-29.99	32.000	29.2	207.0	60.0	95.1	4071 5.003	4107 29.500
295	29.50-29.99	31.750	29.2	207.0	60.0	95.1	4071 5.003	4107 29.505
300	30.00-30.49	32.000	29.7	210.0	60.0	96.7	4071 6.000	4107 30.000
300	30.00-30.49	31.750	29.7	210.0	60.0	96.7	4071 6.000	4107 30.005
305	30.50-30.99	32.000	30.2	212.0	60.0	98.3	4071 6.000	4107 30.500
305	30.50-30.99	31.750	30.2	212.0	60.0	98.3	4071 6.000	4107 30.505
310	31.00-31.49	32.000	30.7	214.0	60.0	99.8	4071 6.000	4107 31.000
310	31.00-31.49	31.750	30.7	214.0	60.0	99.8	4071 6.000	4107 31.005
315	31.50-31.99	32.000	31.2	216.0	60.0	101.4	4071 6.000	4107 31.500
315	31.50-31.99	31.750	31.2	216.0	60.0	101.4	4071 6.000	4107 31.505
320	32.00-32.99	32.000	31.7	221.0	60.0	104.6	4071 6.001	4107 32.000
320	32.00-32.99	31.750	31.7	221.0	60.0	104.6	4071 6.001	4107 32.005
330	33.00-33.99	32.000	32.7	226.0	60.0	107.8	4071 6.001	4107 33.000
330	33.00-33.99	31.750	32.7	226.0	60.0	107.8	4071 6.001	4107 33.005
340	34.00-34.99	32.000	33.7	230.0	60.0	111.0	4071 6.001	4107 34.000
340	34.00-34.99	31.750	33.7	230.0	60.0	111.0	4071 6.001	4107 34.005
350	35.00-35.99	32.000	34.7	235.0	60.0	114.2	4071 6.001	4107 35.000
350	35.00-35.99	31.750	34.7	235.0	60.0	114.2	4071 6.001	4107 35.005
360	36.00-36.99	32.000	35.7	240.0	60.0	117.3	4071 6.002	4107 36.000
360	36.00-36.99	31.750	35.7	240.0	60.0	117.3	4071 6.002	4107 36.005
370	37.00-37.99	32.000	36.7	245.0	60.0	120.5	4071 6.002	4107 37.000
370	37.00-37.99	31.750	36.7	245.0	60.0	120.5	4071 6.002	4107 37.005
380	38.00-38.99	32.000	37.7	249.0	60.0	123.7	4071 6.002	4107 38.000
380	38.00-38.99	31.750	37.7	249.0	60.0	123.7	4071 6.002	4107 38.005
390	39.00-40.00	32.000	38.7	254.0	60.0	126.9	4071 6.002	4107 39.000
390	39.00-40.00	31.750	38.7	254.0	60.0	126.9	4071 6.002	4107 39.005

Modular drills



Modular drills with cutting insert

Modular drills

Tool holders for interchangeable inserts HT 800

Article no. **4108**



nickel-plated • especially high wear resistance • optimised coolant duct exit • optimised flute cross-section • clamping screws art. no. 4071 included • order screwdriver art. no. 1612 separately

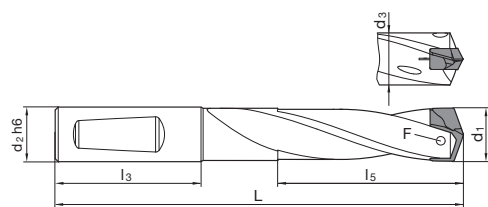

Article no.

4108

Holder size	d1	d2 h6 mm	d3 mm	L mm	l3 mm	l5 mm	F	Order no.
110	11.00-11.49	12.000	10.7	124.0	45.0	59.6	4071 2.200	4108 11.000
110	11.00-11.49	12.700	10.7	124.0	45.0	59.6	4071 2.200	4108 11.005
115	11.50-11.99	12.000	11.2	127.0	45.0	62.1	4071 2.200	4108 11.500
115	11.50-11.99	12.700	11.2	127.0	45.0	62.1	4071 2.200	4108 11.505
120	12.00-12.49	12.000	11.7	131.0	45.0	64.7	4071 2.201	4108 12.000
120	12.00-12.49	12.700	11.7	131.0	45.0	64.7	4071 2.201	4108 12.005
125	12.50-12.99	14.000	12.2	134.0	45.0	67.3	4071 2.201	4108 12.500
125	12.50-12.99	15.875	12.2	134.0	45.0	67.3	4071 2.201	4108 12.505
130	13.00-13.49	14.000	12.7	137.0	45.0	69.9	4071 2.500	4108 13.000
130	13.00-13.49	15.875	12.7	137.0	45.0	69.9	4071 2.500	4108 13.005
135	13.50-13.99	14.000	13.2	141.0	45.0	72.6	4071 2.500	4108 13.500
135	13.50-13.99	15.875	13.2	141.0	45.0	72.6	4071 2.500	4108 13.505
140	14.00-14.49	14.000	13.7	144.0	45.0	75.2	4071 3.000	4108 14.000
140	14.00-14.49	15.875	13.7	144.0	45.0	75.2	4071 3.000	4108 14.005
145	14.50-14.99	16.000	14.2	150.0	48.0	77.8	4071 3.000	4108 14.500
145	14.50-14.99	15.875	14.2	150.0	48.0	77.8	4071 3.000	4108 14.505
150	15.00-15.49	16.000	14.7	154.0	48.0	80.3	4071 3.001	4108 15.000
150	15.00-15.49	15.875	14.7	154.0	48.0	80.3	4071 3.001	4108 15.005
155	15.50-15.99	16.000	15.2	157.0	48.0	82.9	4071 3.001	4108 15.500
155	15.50-15.99	15.875	15.2	157.0	48.0	82.9	4071 3.001	4108 15.505
160	16.00-16.49	16.000	15.7	160.0	48.0	85.9	4071 3.500	4108 16.000
160	16.00-16.49	15.875	15.7	160.0	48.0	85.9	4071 3.500	4108 16.005
165	16.50-16.99	18.000	16.2	164.0	48.0	88.1	4071 3.500	4108 16.500
165	16.50-16.99	19.050	16.2	164.0	48.0	88.1	4071 3.500	4108 16.505
170	17.00-17.49	18.000	16.7	167.0	48.0	90.8	4071 3.500	4108 17.000
170	17.00-17.49	19.050	16.7	167.0	48.0	90.8	4071 3.500	4108 17.005
175	17.50-17.99	18.000	17.2	170.0	48.0	93.4	4071 3.500	4108 17.500
175	17.50-17.99	19.050	17.2	170.0	48.0	93.4	4071 3.500	4108 17.505
180	18.00-18.49	18.000	17.7	174.0	48.0	95.9	4071 4.000	4108 18.000
180	18.00-18.49	19.050	17.7	174.0	48.0	95.9	4071 4.000	4108 18.005
185	18.50-18.99	20.000	18.2	179.0	50.0	98.5	4071 4.000	4108 18.500
185	18.50-18.99	19.050	18.2	179.0	50.0	98.5	4071 4.000	4108 18.505
190	19.00-19.49	20.000	18.7	182.0	50.0	101.1	4071 4.000	4108 19.000
190	19.00-19.49	19.050	18.7	182.0	50.0	101.1	4071 4.000	4108 19.005
195	19.50-19.99	20.000	19.2	186.0	50.0	103.7	4071 4.000	4108 19.500
195	19.50-19.99	19.050	19.2	186.0	50.0	103.7	4071 4.000	4108 19.505
200	20.00-20.49	20.000	19.7	189.0	50.0	106.3	4071 4.500	4108 20.000
200	20.00-20.49	19.050	19.7	189.0	50.0	106.3	4071 4.500	4108 20.005
205	20.50-20.99	25.000	20.2	201.0	56.0	109.0	4071 4.500	4108 20.500
205	20.50-20.99	25.400	20.2	201.0	56.0	109.0	4071 4.500	4108 20.505
210	21.00-21.49	25.000	20.7	204.0	56.0	111.6	4071 4.500	4108 21.000
210	21.00-21.49	25.400	20.7	204.0	56.0	111.6	4071 4.500	4108 21.005
215	21.50-21.99	25.000	21.2	207.0	56.0	114.1	4071 4.500	4108 21.500
215	21.50-21.99	25.400	21.2	207.0	56.0	114.1	4071 4.500	4108 21.505
220	22.00-22.49	25.000	21.7	210.0	56.0	116.7	4071 5.000	4108 22.000
220	22.00-22.49	25.400	21.7	210.0	56.0	116.7	4071 5.000	4108 22.005
225	22.50-22.99	25.000	22.2	214.0	56.0	119.3	4071 5.000	4108 22.500
225	22.50-22.99	25.400	22.2	214.0	56.0	119.3	4071 5.000	4108 22.505
230	23.00-23.49	25.000	22.7	217.0	56.0	121.9	4071 5.000	4108 23.000
230	23.00-23.49	25.400	22.7	217.0	56.0	121.9	4071 5.000	4108 23.005
235	23.50-23.99	25.000	23.2	221.0	56.0	124.5	4071 5.000	4108 23.500
235	23.50-23.99	25.400	23.2	221.0	56.0	124.5	4071 5.000	4108 23.505
240	24.00-24.49	25.000	23.7	224.0	56.0	127.1	4071 5.001	4108 24.000
240	24.00-24.49	25.400	23.7	224.0	56.0	127.1	4071 5.001	4108 24.005
245	24.50-24.99	25.000	24.2	227.0	56.0	129.7	4071 5.001	4108 24.500
245	24.50-24.99	25.400	24.2	227.0	56.0	129.7	4071 5.001	4108 24.505
250	25.00-25.49	25.000	24.7	231.0	56.0	132.3	4071 5.001	4108 25.000
250	25.00-25.49	25.400	24.7	231.0	56.0	132.3	4071 5.001	4108 25.005
255	25.50-25.99	32.000	25.2	239.0	60.0	134.9	4071 5.001	4108 25.500
255	25.50-25.99	31.750	25.2	239.0	60.0	134.9	4071 5.001	4108 25.505



Article no.								4108
Holder size	d1	d2 h6 mm	d3 mm	L mm	l3 mm	l5 mm	F	Order no.
260	26.00-26.49	32.000	25.7	244.0	60.0	137.0	4071 5.003	4108 26.000
260	26.00-26.49	31.750	25.7	244.0	60.0	137.0	4071 5.003	4108 26.005
265	26.50-26.99	32.000	26.2	247.0	60.0	140.0	4071 5.003	4108 26.500
265	26.50-26.99	31.750	26.2	247.0	60.0	140.0	4071 5.003	4108 26.505
270	27.00-27.49	32.000	26.7	251.0	60.0	142.2	4071 5.003	4108 27.000
270	27.00-27.49	31.750	26.7	251.0	60.0	142.2	4071 5.003	4108 27.005
275	27.50-27.99	32.000	27.2	254.0	60.0	144.8	4071 5.003	4108 27.500
275	27.50-27.99	31.750	27.2	254.0	60.0	144.8	4071 5.003	4108 27.505
280	28.00-28.49	32.000	27.7	257.0	60.0	147.4	4071 5.003	4108 28.000
280	28.00-28.49	31.750	27.7	257.0	60.0	147.4	4071 5.003	4108 28.005
285	28.50-28.99	32.000	28.2	260.0	60.0	150.4	4071 5.003	4108 28.500
285	28.50-28.99	31.750	28.2	260.0	60.0	150.4	4071 5.003	4108 28.505
290	29.00-29.49	32.000	28.7	264.0	60.0	153.5	4071 5.003	4108 29.000
290	29.00-29.49	31.750	28.7	264.0	60.0	153.5	4071 5.003	4108 29.005
295	29.50-29.99	32.000	29.2	267.0	60.0	155.1	4071 5.003	4108 29.500
295	29.50-29.99	31.750	29.2	267.0	60.0	155.1	4071 5.003	4108 29.505
300	30.00-30.49	32.000	29.7	271.0	60.0	157.6	4071 6.000	4108 30.000
300	30.00-30.49	31.750	29.7	271.0	60.0	157.6	4071 6.000	4108 30.005
305	30.50-30.99	32.000	30.2	274.0	60.0	160.2	4071 6.000	4108 30.500
305	30.50-30.99	31.750	30.2	274.0	60.0	160.2	4071 6.000	4108 30.505
310	31.00-31.49	32.000	30.7	277.0	60.0	162.8	4071 6.000	4108 31.000
310	31.00-31.49	31.750	30.7	277.0	60.0	162.8	4071 6.000	4108 31.005
315	31.50-31.99	32.000	31.2	280.0	60.0	165.4	4071 6.000	4108 31.500
315	31.50-31.99	31.750	31.2	280.0	60.0	165.4	4071 6.000	4108 31.505
320	32.00-32.99	32.000	31.7	287.0	60.0	170.6	4071 6.001	4108 32.000
320	32.00-32.99	31.750	31.7	287.0	60.0	170.6	4071 6.001	4108 32.005
330	33.00-33.99	32.000	32.7	294.0	60.0	175.8	4071 6.001	4108 33.000
330	33.00-33.99	31.750	32.7	294.0	60.0	175.8	4071 6.001	4108 33.005
340	34.00-34.99	32.000	33.7	300.0	60.0	181.0	4071 6.001	4108 34.000
340	34.00-34.99	31.750	33.7	300.0	60.0	181.0	4071 6.001	4108 34.005
350	35.00-35.99	32.000	34.7	307.0	60.0	186.2	4071 6.001	4108 35.000
350	35.00-35.99	31.750	34.7	307.0	60.0	186.2	4071 6.001	4108 35.005
360	36.00-36.99	32.000	35.7	314.0	60.0	191.3	4071 6.002	4108 36.000
360	36.00-36.99	31.750	35.7	314.0	60.0	191.3	4071 6.002	4108 36.005
370	37.00-37.99	32.000	36.7	321.0	60.0	196.5	4071 6.002	4108 37.000
370	37.00-37.99	31.750	36.7	321.0	60.0	196.5	4071 6.002	4108 37.005
380	38.00-38.99	32.000	37.7	327.0	60.0	201.7	4071 6.002	4108 38.000
380	38.00-38.99	31.750	37.7	327.0	60.0	201.7	4071 6.002	4108 38.005
390	39.00-40.00	32.000	38.7	334.0	60.0	206.9	4071 6.002	4108 39.000
390	39.00-40.00	31.750	38.7	334.0	60.0	206.9	4071 6.002	4108 39.005



nickel-plated • especially high wear resistance • optimised coolant duct exit • optimised flute cross-section • clamping screws art. no. 4071 included • order screwdriver art. no. 1612 separately

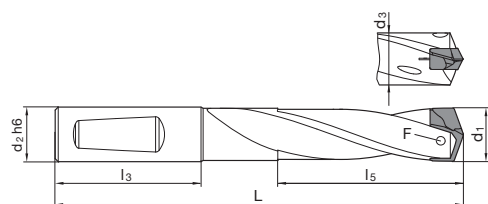

Article no.

4109

Holder size	d1	d2 h6 mm	d3 mm	L mm	l3 mm	l5 mm	F	Order no.
110	11.00-11.49	12.000	10.7	147.0	45.0	82.6	4071 2.200	4109 11.000
110	11.00-11.49	12.700	10.7	147.0	45.0	82.6	4071 2.200	4109 11.005
115	11.50-11.99	12.000	11.2	151.0	45.0	86.1	4071 2.200	4109 11.500
115	11.50-11.99	12.700	11.2	151.0	45.0	86.1	4071 2.200	4109 11.505
120	12.00-12.49	12.000	11.7	156.0	45.0	89.7	4071 2.201	4109 12.000
120	12.00-12.49	12.700	11.7	156.0	45.0	89.7	4071 2.201	4109 12.005
125	12.50-12.99	14.000	12.2	160.0	45.0	93.3	4071 2.201	4109 12.500
125	12.50-12.99	15.875	12.2	160.0	45.0	93.3	4071 2.201	4109 12.505
130	13.00-13.49	14.000	12.7	164.0	45.0	96.9	4071 2.500	4109 13.000
130	13.00-13.49	15.875	12.7	164.0	45.0	96.9	4071 2.500	4109 13.005
135	13.50-13.99	14.000	13.2	169.0	45.0	100.6	4071 2.500	4109 13.500
135	13.50-13.99	15.875	13.2	169.0	45.0	100.6	4071 2.500	4109 13.505
140	14.00-14.49	14.000	13.7	173.0	45.0	104.2	4071 3.000	4109 14.000
140	14.00-14.49	15.875	13.7	173.0	45.0	104.2	4071 3.000	4109 14.005
145	14.50-14.99	16.000	14.2	180.0	48.0	107.8	4071 3.000	4109 14.500
145	14.50-14.99	15.875	14.2	180.0	48.0	107.8	4071 3.000	4109 14.505
150	15.00-15.49	16.000	14.7	185.0	48.0	111.3	4071 3.001	4109 15.000
150	15.00-15.49	15.875	14.7	185.0	48.0	111.3	4071 3.001	4109 15.005
155	15.50-15.99	16.000	15.2	189.0	48.0	114.9	4071 3.001	4109 15.500
155	15.50-15.99	15.875	15.2	189.0	48.0	114.9	4071 3.001	4109 15.505
160	16.00-16.49	16.000	15.7	193.0	48.0	118.9	4071 3.500	4109 16.000
160	16.00-16.49	15.875	15.7	193.0	48.0	118.9	4071 3.500	4109 16.005
165	16.50-16.99	18.000	16.2	198.0	48.0	122.1	4071 3.500	4109 16.500
165	16.50-16.99	19.050	16.2	198.0	48.0	122.1	4071 3.500	4109 16.505
170	17.00-17.49	18.000	16.7	202.0	48.0	125.8	4071 3.500	4109 17.000
170	17.00-17.49	19.050	16.7	202.0	48.0	125.8	4071 3.500	4109 17.005
175	17.50-17.99	18.000	17.2	206.0	48.0	129.4	4071 3.500	4109 17.500
175	17.50-17.99	19.050	17.2	206.0	48.0	129.4	4071 3.500	4109 17.505
180	18.00-18.49	18.000	17.7	211.0	48.0	132.9	4071 4.000	4109 18.000
180	18.00-18.49	19.050	17.7	211.0	48.0	132.9	4071 4.000	4109 18.005
185	18.50-18.99	20.000	18.2	217.0	50.0	136.5	4071 4.000	4109 18.500
185	18.50-18.99	19.050	18.2	217.0	50.0	136.5	4071 4.000	4109 18.505
190	19.00-19.49	20.000	18.7	221.0	50.0	140.1	4071 4.000	4109 19.000
190	19.00-19.49	19.050	18.7	221.0	50.0	140.1	4071 4.000	4109 19.005
195	19.50-19.99	20.000	19.2	226.0	50.0	143.7	4071 4.000	4109 19.500
195	19.50-19.99	19.050	19.2	226.0	50.0	143.7	4071 4.000	4109 19.505
200	20.00-20.49	20.000	19.7	230.0	50.0	147.3	4071 4.500	4109 20.000
200	20.00-20.49	19.050	19.7	230.0	50.0	147.3	4071 4.500	4109 20.005
205	20.50-20.99	25.000	20.2	243.0	56.0	151.0	4071 4.500	4109 20.500
205	20.50-20.99	25.400	20.2	243.0	56.0	151.0	4071 4.500	4109 20.505
210	21.00-21.49	25.000	20.7	247.0	56.0	154.6	4071 4.500	4109 21.000
210	21.00-21.49	25.400	20.7	247.0	56.0	154.6	4071 4.500	4109 21.005
215	21.50-21.99	25.000	21.2	251.0	56.0	158.1	4071 4.500	4109 21.500
215	21.50-21.99	25.400	21.2	251.0	56.0	158.1	4071 4.500	4109 21.505
220	22.00-22.49	25.000	21.7	255.0	56.0	161.7	4071 5.000	4109 22.000
220	22.00-22.49	25.400	21.7	255.0	56.0	161.7	4071 5.000	4109 22.005
225	22.50-22.99	25.000	22.2	260.0	56.0	165.3	4071 5.000	4109 22.500
225	22.50-22.99	25.400	22.2	260.0	56.0	165.3	4071 5.000	4109 22.505
230	23.00-23.49	25.000	22.7	264.0	56.0	168.9	4071 5.000	4109 23.000
230	23.00-23.49	25.400	22.7	264.0	56.0	168.9	4071 5.000	4109 23.005
235	23.50-23.99	25.000	23.2	269.0	56.0	172.5	4071 5.000	4109 23.500
235	23.50-23.99	25.400	23.2	269.0	56.0	172.5	4071 5.000	4109 23.505
240	24.00-24.49	25.000	23.7	273.0	56.0	176.1	4071 5.001	4109 24.000
240	24.00-24.49	25.400	23.7	273.0	56.0	176.1	4071 5.001	4109 24.005
245	24.50-24.99	25.000	24.2	277.0	56.0	179.7	4071 5.001	4109 24.500
245	24.50-24.99	25.400	24.2	277.0	56.0	179.7	4071 5.001	4109 24.505
250	25.00-25.49	25.000	24.7	282.0	56.0	183.3	4071 5.001	4109 25.000
250	25.00-25.49	25.400	24.7	282.0	56.0	183.3	4071 5.001	4109 25.005
255	25.50-25.99	32.000	25.2	291.0	60.0	186.9	4071 5.001	4109 25.500
255	25.50-25.99	31.750	25.2	291.0	60.0	186.9	4071 5.001	4109 25.505



Article no.								4109
Holder size	d1	d2 h6 mm	d3 mm	L mm	l3 mm	l5 mm	F	Order no.
260	26.00-26.49	32.000	25.7	297.0	60.0	190.0	4071 5.003	4109 26.000
260	26.00-26.49	31.750	25.7	297.0	60.0	190.0	4071 5.003	4109 26.005
265	26.50-26.99	32.000	26.2	301.0	60.0	194.0	4071 5.003	4109 26.500
265	26.50-26.99	31.750	26.2	301.0	60.0	194.0	4071 5.003	4109 26.505
270	27.00-27.49	32.000	26.7	306.0	60.0	197.2	4071 5.003	4109 27.000
270	27.00-27.49	31.750	26.7	306.0	60.0	197.2	4071 5.003	4109 27.005
275	27.50-27.99	32.000	27.2	310.0	60.0	200.8	4071 5.003	4109 27.500
275	27.50-27.99	31.750	27.2	310.0	60.0	200.8	4071 5.003	4109 27.505
280	28.00-28.49	32.000	27.7	314.0	60.0	204.4	4071 5.003	4109 28.000
280	28.00-28.49	31.750	27.7	314.0	60.0	204.4	4071 5.003	4109 28.005
285	28.50-28.99	32.000	28.2	318.0	60.0	208.4	4071 5.003	4109 28.500
285	28.50-28.99	31.750	28.2	318.0	60.0	208.4	4071 5.003	4109 28.505
290	29.00-29.49	32.000	28.7	323.0	60.0	212.5	4071 5.003	4109 29.000
290	29.00-29.49	31.750	28.7	323.0	60.0	212.5	4071 5.003	4109 29.005
295	29.50-29.99	32.000	29.2	327.0	60.0	215.1	4071 5.003	4109 29.500
295	29.50-29.99	31.750	29.2	327.0	60.0	215.1	4071 5.003	4109 29.505
300	30.00-30.49	32.000	29.7	332.0	60.0	218.6	4071 6.000	4109 30.000
300	30.00-30.49	31.750	29.7	332.0	60.0	218.6	4071 6.000	4109 30.005
305	30.50-30.99	32.000	30.2	336.0	60.0	222.2	4071 6.000	4109 30.500
305	30.50-30.99	31.750	30.2	336.0	60.0	222.2	4071 6.000	4109 30.505
310	31.00-31.49	32.000	30.7	340.0	60.0	225.8	4071 6.000	4109 31.000
310	31.00-31.49	31.750	30.7	340.0	60.0	225.8	4071 6.000	4109 31.005
315	31.50-31.99	32.000	31.2	344.0	60.0	229.4	4071 6.000	4109 31.500
315	31.50-31.99	31.750	31.2	344.0	60.0	229.4	4071 6.000	4109 31.505
330	33.00-33.99	32.000	32.7	362.0	60.0	244.6	4071 6.001	4109 33.000
360	36.00-36.99	32.000	35.7	387.0	60.0	265.8	4071 6.002	4109 36.000
390	39.00-40.00	32.000	38.7	413.0	60.0	287.4	4071 6.002	4109 39.000

Modular drills



Modular drills with cutting insert

Modular drills

Tool holders for interchangeable inserts HT 800

Article no. **4110**



nickel-plated • especially high wear resistance • optimised coolant duct exit • optimised flute cross-section • clamping screws art. no. 4071 included • order screwdriver art. no. 1612 separately

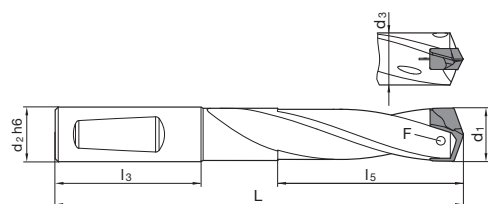

Article no.

4110

Holder size	d1	d2 h6 mm	d3 mm	L mm	l3 mm	l5 mm	F	Order no.
110	11.00-11.49	12.000	10.7	182.0	45.0	117.1	4071 2.200	4110 11.000
110	11.00-11.49	12.700	10.7	182.0	45.0	117.1	4071 2.200	4110 11.005
115	11.50-11.99	12.000	11.2	187.0	45.0	122.1	4071 2.200	4110 11.500
115	11.50-11.99	12.700	11.2	187.0	45.0	122.1	4071 2.200	4110 11.505
120	12.00-12.49	12.000	11.7	194.0	45.0	127.2	4071 2.201	4110 12.000
120	12.00-12.49	12.700	11.7	194.0	45.0	127.2	4071 2.201	4110 12.005
125	12.50-12.99	14.000	12.2	199.0	45.0	132.3	4071 2.201	4110 12.500
125	12.50-12.99	15.875	12.2	199.0	45.0	132.3	4071 2.201	4110 12.505
130	13.00-13.49	14.000	12.7	205.0	45.0	137.5	4071 2.500	4110 13.000
130	13.00-13.49	15.875	12.7	205.0	45.0	137.5	4071 2.500	4110 13.005
135	13.50-13.99	14.000	13.2	211.0	45.0	142.5	4071 2.500	4110 13.500
135	13.50-13.99	15.875	13.2	211.0	45.0	142.5	4071 2.500	4110 13.505
140	14.00-14.49	14.000	13.7	217.0	45.0	147.7	4071 3.000	4110 14.000
140	14.00-14.49	15.875	13.7	217.0	45.0	147.7	4071 3.000	4110 14.005
145	14.50-14.99	16.000	14.2	225.0	48.0	152.8	4071 3.000	4110 14.500
145	14.50-14.99	15.875	14.2	225.0	48.0	152.8	4071 3.000	4110 14.505
150	15.00-15.49	16.000	14.7	232.0	48.0	157.8	4071 3.001	4110 15.000
150	15.00-15.49	15.875	14.7	232.0	48.0	157.8	4071 3.001	4110 15.005
155	15.50-15.99	16.000	15.2	237.0	48.0	162.9	4071 3.001	4110 15.500
155	15.50-15.99	15.875	15.2	237.0	48.0	162.9	4071 3.001	4110 15.505
160	16.00-16.49	16.000	15.7	243.0	48.0	168.0	4071 3.500	4110 16.000
160	16.00-16.49	15.875	15.7	243.0	48.0	168.0	4071 3.500	4110 16.005
165	16.50-16.99	18.000	16.2	249.0	48.0	170.0	4071 3.500	4110 16.500
165	16.50-16.99	19.050	16.2	249.0	48.0	170.0	4071 3.500	4110 16.505
170	17.00-17.49	18.000	16.7	255.0	48.0	178.3	4071 3.500	4110 17.000
170	17.00-17.49	19.050	16.7	255.0	48.0	178.3	4071 3.500	4110 17.005
175	17.50-17.99	18.000	17.2	260.0	48.0	183.5	4071 3.500	4110 17.500
175	17.50-17.99	19.050	17.2	260.0	48.0	183.5	4071 3.500	4110 17.505
180	18.00-18.49	18.000	17.7	267.0	48.0	188.4	4071 4.000	4110 18.000
180	18.00-18.49	19.050	17.7	267.0	48.0	188.4	4071 4.000	4110 18.005
185	18.50-18.99	20.000	18.2	274.0	50.0	193.5	4071 4.000	4110 18.500
185	18.50-18.99	19.050	18.2	274.0	50.0	193.5	4071 4.000	4110 18.505
190	19.00-19.49	20.000	18.7	280.0	50.0	198.7	4071 4.000	4110 19.000
190	19.00-19.49	19.050	18.7	280.0	50.0	198.7	4071 4.000	4110 19.005
195	19.50-19.99	20.000	19.2	286.0	50.0	203.7	4071 4.000	4110 19.500
195	19.50-19.99	19.050	19.2	286.0	50.0	203.7	4071 4.000	4110 19.505
200	20.00-20.49	20.000	19.7	292.0	50.0	208.9	4071 4.500	4110 20.000
200	20.00-20.49	19.050	19.7	292.0	50.0	208.9	4071 4.500	4110 20.005
205	20.50-20.99	25.000	20.2	306.0	56.0	214.0	4071 4.500	4110 20.500
205	20.50-20.99	25.400	20.2	306.0	56.0	214.0	4071 4.500	4110 20.505
210	21.00-21.49	25.000	20.7	312.0	56.0	219.1	4071 4.500	4110 21.000
210	21.00-21.49	25.400	20.7	312.0	56.0	219.1	4071 4.500	4110 21.005
215	21.50-21.99	25.000	21.2	317.0	56.0	224.2	4071 4.500	4110 21.500
215	21.50-21.99	25.400	21.2	317.0	56.0	224.2	4071 4.500	4110 21.505
220	22.00-22.49	25.000	21.7	323.0	56.0	229.3	4071 5.000	4110 22.000
220	22.00-22.49	25.400	21.7	323.0	56.0	229.3	4071 5.000	4110 22.005
225	22.50-22.99	25.000	22.2	329.0	56.0	234.4	4071 5.000	4110 22.500
225	22.50-22.99	25.400	22.2	329.0	56.0	234.4	4071 5.000	4110 22.505
230	23.00-23.49	25.000	22.7	335.0	56.0	239.5	4071 5.000	4110 23.000
230	23.00-23.49	25.400	22.7	335.0	56.0	239.5	4071 5.000	4110 23.005
235	23.50-23.99	25.000	23.2	341.0	56.0	244.6	4071 5.000	4110 23.500
235	23.50-23.99	25.400	23.2	341.0	56.0	244.6	4071 5.000	4110 23.505
240	24.00-24.49	25.000	23.7	347.0	56.0	249.7	4071 5.001	4110 24.000
240	24.00-24.49	25.400	23.7	347.0	56.0	249.7	4071 5.001	4110 24.005
245	24.50-24.99	25.000	24.2	352.0	56.0	254.8	4071 5.001	4110 24.500
245	24.50-24.99	25.400	24.2	352.0	56.0	254.8	4071 5.001	4110 24.505
250	25.00-25.49	25.000	24.7	359.0	56.0	259.9	4071 5.001	4110 25.000
250	25.00-25.49	25.400	24.7	359.0	56.0	259.9	4071 5.001	4110 25.005
255	25.50-25.99	32.000	25.2	369.0	60.0	265.0	4071 5.001	4110 25.500
255	25.50-25.99	31.750	25.2	369.0	60.0	265.0	4071 5.001	4110 25.505



Article no.								4110
Holder size	d1	d2 h6 mm	d3 mm	L mm	l3 mm	l5 mm	F	Order no.
260	26.00-26.49	32.000	25.7	377.0	60.0	270.0	4071 5.003	4110 26.000
260	26.00-26.49	31.750	25.7	377.0	60.0	270.0	4071 5.003	4110 26.005
265	26.50-26.99	32.000	26.2	382.0	60.0	275.0	4071 5.003	4110 26.500
265	26.50-26.99	31.750	26.2	382.0	60.0	275.0	4071 5.003	4110 26.505
270	27.00-27.49	32.000	26.7	388.0	60.0	280.1	4071 5.003	4110 27.000
270	27.00-27.49	31.750	26.7	388.0	60.0	280.1	4071 5.003	4110 27.005
275	27.50-27.99	32.000	27.2	394.0	60.0	285.2	4071 5.003	4110 27.500
275	27.50-27.99	31.750	27.2	394.0	60.0	285.2	4071 5.003	4110 27.505
280	28.00-28.49	32.000	27.7	400.0	60.0	290.3	4071 5.003	4110 28.000
280	28.00-28.49	31.750	27.7	400.0	60.0	290.3	4071 5.003	4110 28.005
285	28.50-28.99	32.000	28.2	405.0	60.0	295.4	4071 5.003	4110 28.500
285	28.50-28.99	31.750	28.2	405.0	60.0	295.4	4071 5.003	4110 28.505
290	29.00-29.49	32.000	28.7	412.0	60.0	300.5	4071 5.003	4110 29.000
290	29.00-29.49	31.750	28.7	412.0	60.0	300.5	4071 5.003	4110 29.005
295	29.50-29.99	32.000	29.2	418.0	60.0	305.6	4071 5.003	4110 29.500
295	29.50-29.99	31.750	29.2	418.0	60.0	305.6	4071 5.003	4110 29.505
300	30.00-30.49	32.000	29.7	424.0	60.0	310.6	4071 6.000	4110 30.000
300	30.00-30.49	31.750	29.7	424.0	60.0	310.6	4071 6.000	4110 30.005
305	30.50-30.99	32.000	30.2	429.0	60.0	315.7	4071 6.000	4110 30.500
305	30.50-30.99	31.750	30.2	429.0	60.0	315.7	4071 6.000	4110 30.505
310	31.00-31.49	32.000	30.7	435.0	60.0	320.8	4071 6.000	4110 31.000
310	31.00-31.49	31.750	30.7	435.0	60.0	320.8	4071 6.000	4110 31.005
315	31.50-31.99	32.000	31.2	441.0	60.0	325.9	4071 6.000	4110 31.500
315	31.50-31.99	31.750	31.2	441.0	60.0	325.9	4071 6.000	4110 31.505

Modular drills



Modular drills with cutting insert

Modular drills

Interchangeable inserts HT 800

Article no. 4111



Cutting data page 433

P	M	K	N	S	H
○	○	○	○	○	○

Web thinning ≥ Ø 11.000 • facet point grind • main cutting edge form straight (after correction) • clamping screws art. no. 4071 included • piloting in all materials

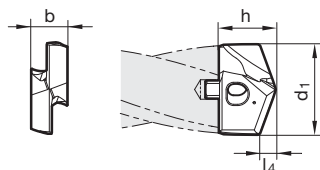

Article no. 4111						Article no. 4111							
Size	d1 mm	inch	l4 mm	b mm	h mm	Order no.	Size	d1 mm	inch	l4 mm	b mm	h mm	Order no.
110	11.000		1.8	4.5	7.2	4111 11.000	200	20.500		3.3	9.0	13.3	4111 20.500
110	11.200		1.8	4.5	7.2	4111 11.200	200	20.640	13/16	3.3	9.0	13.3	4111 20.640
110	11.500		1.9	4.5	7.2	4111 11.500	200	21.000		3.4	9.0	13.3	4111 21.000
110	11.510	29/64	1.9	4.5	7.2	4111 11.510	200	21.030	53/64	3.4	9.0	13.3	4111 21.030
110	11.700		1.9	4.5	7.2	4111 11.700	200	21.100		3.4	9.0	13.3	4111 21.100
110	11.800		1.9	4.5	7.2	4111 11.800	200	21.430	27/32	3.4	9.0	13.3	4111 21.430
110	11.910	15/32	1.9	4.5	7.2	4111 11.910	200	21.500		3.4	9.0	13.3	4111 21.500
120	12.000		1.9	5.0	7.4	4111 12.000	200	21.830	55/64	3.5	9.0	13.3	4111 21.830
120	12.100		2.0	5.0	7.4	4111 12.100	220	22.000		3.5	10.0	14.8	4111 22.000
120	12.200		2.0	5.0	7.4	4111 12.200	220	22.220	7/8	3.6	10.0	14.8	4111 22.220
120	12.300	31/64	2.0	5.0	7.4	4111 12.300	220	22.500		3.6	10.0	14.8	4111 22.500
120	12.500		2.0	5.0	7.4	4111 12.500	220	22.620	57/64	3.6	10.0	14.8	4111 22.620
120	12.600		2.0	5.0	7.4	4111 12.600	220	23.000		3.7	10.0	14.8	4111 23.000
120	12.700	1/2	2.1	5.0	7.4	4111 12.700	220	23.020	29/32	3.7	10.0	14.8	4111 23.020
120	12.800		2.1	5.0	7.4	4111 12.800	220	23.420	59/64	3.7	10.0	14.8	4111 23.420
120	12.900		2.1	5.0	7.4	4111 12.900	220	23.500		3.8	10.0	14.8	4111 23.500
130	13.000		2.1	5.5	8.2	4111 13.000	220	23.810	15/16	3.8	10.0	14.8	4111 23.810
130	13.100	33/64	2.1	5.5	8.2	4111 13.100	240	24.000		3.8	11.0	15.3	4111 24.000
130	13.490	17/32	2.2	5.5	8.2	4111 13.490	240	24.100		3.8	11.0	15.3	4111 24.100
130	13.500		2.2	5.5	8.2	4111 13.500	240	24.210	61/64	3.9	11.0	15.3	4111 24.210
130	13.600		2.2	5.5	8.2	4111 13.600	240	24.500		3.9	11.0	15.3	4111 24.500
130	13.700		2.2	5.5	8.2	4111 13.700	240	24.610	31/32	3.9	11.0	15.3	4111 24.610
130	13.800		2.2	5.5	8.2	4111 13.800	240	25.000	63/64	4.0	11.0	15.3	4111 25.000
130	13.890	35/64	2.2	5.5	8.2	4111 13.890	240	25.400	1	4.1	11.0	15.3	4111 25.400
140	14.000		2.3	6.0	9.4	4111 14.000	240	25.500		4.1	11.0	15.3	4111 25.500
140	14.100		2.3	6.0	9.4	4111 14.100	240	25.700		4.1	11.0	15.3	4111 25.700
140	14.290	9/16	2.3	6.0	9.4	4111 14.290	260	26.000		4.1	12.0	19.4	4111 26.000
140	14.400		2.3	6.0	9.4	4111 14.400	260	26.190	1 1/32	4.2	12.0	19.4	4111 26.190
140	14.500		2.3	6.0	9.4	4111 14.500	260	26.500		4.2	12.0	19.4	4111 26.500
140	14.600		2.4	6.0	9.4	4111 14.600	260	26.590	1 3/64	4.2	12.0	19.4	4111 26.590
140	14.680	37/64	2.4	6.0	9.4	4111 14.680	260	27.000		4.3	12.0	19.4	4111 27.000
140	14.700		2.4	6.0	9.4	4111 14.700	260	27.500		4.4	12.0	19.4	4111 27.500
140	14.800		2.4	6.0	9.4	4111 14.800	260	27.700		4.4	12.0	19.4	4111 27.700
140	15.000		2.4	6.0	9.4	4111 15.000	260	27.780	1 3/32	4.4	12.0	19.4	4111 27.780
140	15.080	19/32	2.4	6.0	9.4	4111 15.080	280	28.000		4.5	13.0	20.1	4111 28.000
140	15.100		2.4	6.0	9.4	4111 15.100	280	28.180	1 7/64	4.5	13.0	20.1	4111 28.180
140	15.200		2.4	6.0	9.4	4111 15.200	280	28.500		4.5	13.0	20.1	4111 28.500
140	15.300		2.5	6.0	9.4	4111 15.300	280	28.580	1 1/8	4.6	13.0	20.1	4111 28.580
140	15.480	39/64	2.5	6.0	9.4	4111 15.480	280	29.000		4.6	13.0	20.1	4111 29.000
140	15.500		2.5	6.0	9.4	4111 15.500	280	29.370	1 5/32	4.7	13.0	20.1	4111 29.370
140	15.600		2.5	6.0	9.4	4111 15.600	280	29.500		4.7	13.0	20.1	4111 29.500
140	15.700		2.5	6.0	9.4	4111 15.700	280	29.770	1 11/64	4.7	13.0	20.1	4111 29.770
140	15.800		2.5	6.0	9.4	4111 15.800	300	30.000		4.8	14.0	21.7	4111 30.000
140	15.870	5/8	2.6	6.0	9.4	4111 15.870	300	30.160	1 3/16	4.8	14.0	21.7	4111 30.160
160	16.000		2.6	7.0	10.6	4111 16.000	300	30.500		4.9	14.0	21.7	4111 30.500
160	16.270	41/64	2.6	7.0	10.6	4111 16.270	300	30.960	1 7/32	4.9	14.0	21.7	4111 30.960
160	16.500		2.7	7.0	10.6	4111 16.500	300	31.000		4.9	14.0	21.7	4111 31.000
160	16.670	21/32	2.7	7.0	10.6	4111 16.670	300	31.500		5.0	14.0	21.7	4111 31.500
160	17.000		2.7	7.0	10.6	4111 17.000	300	31.750	1 1/4	5.1	14.0	21.7	4111 31.750
160	17.070	43/64	2.7	7.0	10.6	4111 17.070	320	32.000		5.1	15.0	22.4	4111 32.000
160	17.460	11/16	2.8	7.0	10.6	4111 17.460	320	32.500		5.2	15.0	22.4	4111 32.500
160	17.500		2.8	7.0	10.6	4111 17.500	320	32.540	1 9/32	5.2	15.0	22.4	4111 32.540
160	17.600		2.8	7.0	10.6	4111 17.600	320	32.940	1 19/64	5.2	15.0	22.4	4111 32.940
160	17.860	45/64	2.9	7.0	10.6	4111 17.860	320	33.000		5.3	15.0	22.4	4111 33.000
180	18.000		2.9	8.0	12.1	4111 18.000	320	33.340	1 5/16	5.3	15.0	22.4	4111 33.340
180	18.260	23/32	2.9	8.0	12.1	4111 18.260	320	33.500		5.3	15.0	22.4	4111 33.500
180	18.500		3.0	8.0	12.1	4111 18.500	320	34.000		5.4	15.0	22.4	4111 34.000
180	18.650	47/64	3.0	8.0	12.1	4111 18.650	320	34.130	1 11/32	5.4	15.0	22.4	4111 34.130
180	19.000		3.0	8.0	12.1	4111 19.000	320	34.500		5.5	15.0	22.4	4111 34.500
180	19.050	3/4	3.1	8.0	12.1	4111 19.050	320	34.930	1 3/8	5.6	15.0	22.4	4111 34.930
180	19.450	49/64	3.1	8.0	12.1	4111 19.450	320	35.000		5.6	15.0	22.4	4111 35.000
180	19.500		3.1	8.0	12.1	4111 19.500	320	35.500		5.6	15.0	22.4	4111 35.500
180	19.600		3.1	8.0	12.1	4111 19.600	320	35.720	1 13/32	5.7	15.0	22.4	4111 35.720
180	19.840	25/32	3.2	8.0	12.1	4111 19.840	360	36.000		5.7	16.0	23.2	4111 36.000
200	20.000		3.2	9.0	13.3	4111 20.000	360	36.500		5.8	16.0	23.2	4111 36.500
200	20.240	51/64	3.2	9.0	13.3	4111 20.240	360	36.510	1 7/16	5.8	16.0	23.2	4111 36.510



Article no. 4111						
Size	d1 mm	inch	l4 mm	b mm	h mm	Order no.
360	37.000		5.9	16.0	23.2	4111 37.000
360	37.310	1 15/32	5.9	16.0	23.2	4111 37.310
360	37.500		6.0	16.0	23.2	4111 37.500
360	38.000		6.0	16.0	23.2	4111 38.000
360	38.100	1 1/2	6.1	16.0	23.2	4111 38.100
360	38.500	1 33/64	6.1	16.0	23.2	4111 38.500

Article no. 4111						
Size	d1 mm	inch	l4 mm	b mm	h mm	Order no.
360	39.000		6.2	16.0	23.2	4111 39.000
360	39.500		6.3	16.0	23.2	4111 39.500
360	40.000		6.4	16.0	23.2	4111 40.000

Modular drills



Modular drills with cutting insert

Modular drills

Interchangeable inserts HT 800

Article no. **4229**



Cutting data page 437

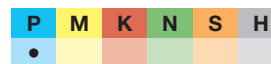

facet point grind • main cutting edge form concave • special point geometry with 160° point angle and 125° centre point
• clamping screws art. no. 4071 included

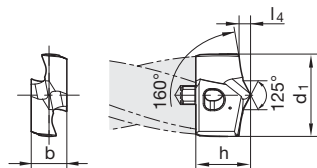

Article no. **4229**

Size	d1 mm	inch	l4 mm	b mm	h mm	Order no.
120	12.000		1.7	5.0	7.5	4229 12.000
125	12.700	1/2	2.0	5.0	7.5	4229 12.700
140	14.000		2.0	6.0	9.5	4229 14.000
140	14.290	9/16	2.3	6.0	9.5	4229 14.290
155	15.870	5/8	2.3	6.0	9.6	4229 15.870
160	16.000		2.3	7.0	10.8	4229 16.000
170	17.460	11/16	2.6	7.0	10.8	4229 17.460
180	18.000		2.6	8.0	12.3	4229 18.000
190	19.050	3/4	2.9	8.0	12.3	4229 19.050
200	20.000		2.9	9.0	13.6	4229 20.000
205	20.640	13/16	3.0	9.0	13.6	4229 20.640
210	21.000		3.0	9.0	13.6	4229 21.000
220	22.000		3.2	10.0	14.9	4229 22.000
220	22.220	7/8	3.5	10.0	14.9	4229 22.220
235	23.810	15/16	3.5	10.0	15.0	4229 23.810
240	24.000		3.5	11.0	15.5	4229 24.000
250	25.000	63/64	3.6	11.0	15.5	4229 25.000
250	25.400	1	3.8	11.0	15.5	4229 25.400

Article no. **4229**

Size	d1 mm	inch	l4 mm	b mm	h mm	Order no.
260	26.000		3.8	12.0	18.5	4229 26.000
270	27.000		3.9	12.0	18.6	4229 27.000
280	28.000		4.1	13.0	19.8	4229 28.000
285	28.580	1 1/8	4.2	13.0	19.8	4229 28.580
290	29.000		4.2	13.0	19.8	4229 29.000
300	30.000		4.4	14.0	19.9	4229 30.000
300	30.160	1 3/16	4.6	14.0	19.9	4229 30.160
315	31.750	1 1/4	4.6	14.0	20.6	4229 31.750
320	32.000		4.6	15.0	21.3	4229 32.000
330	33.000		4.8	15.0	21.7	4229 33.000
330	33.340	1 5/16	4.9	15.0	21.7	4229 33.340
340	34.000		4.9	15.0	22.2	4229 34.000
340	34.930	1 3/8	5.2	15.0	22.2	4229 34.930
360	36.000		5.2	16.0	22.5	4229 36.000
360	36.510	1 7/16	5.5	16.0	22.5	4229 36.510
380	38.000		5.5	16.0	23.0	4229 38.000
380	38.100	1 1/2	5.8	16.0	23.0	4229 38.100
400	40.000		5.8	16.0	23.1	4229 40.000



Interchangeable inserts HT 800

Article no. 4112

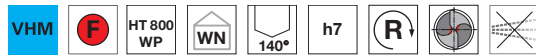

Cutting data page 434-436



Web thinning $\geq \varnothing 11.000$ • facet point grind • main cutting edge form straight (after correction) • clamping screws art. no. 4071 included

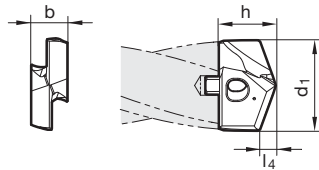

Modular drills

Article no. 4112						Article no. 4112							
Size	d1 mm	inch	l4 mm	b mm	h mm	Order no.	Size	d1 mm	inch	l4 mm	b mm	h mm	Order no.
110	11.000		2.1	4.5	7.5	4112 11.000	190	19.450	49/64	3.6	8.0	12.6	4112 19.450
110	11.200		2.1	4.5	7.5	4112 11.200	195	19.500		3.6	8.0	12.6	4112 19.500
115	11.500		2.1	4.5	7.5	4112 11.500	195	19.600		3.6	8.0	12.6	4112 19.600
115	11.510	29/64	2.1	4.5	7.5	4112 11.510	195	19.840	25/32	3.7	8.0	12.6	4112 19.840
115	11.700		2.2	4.5	7.5	4112 11.700	200	20.000		3.7	9.0	13.9	4112 20.000
115	11.800		2.2	4.5	7.5	4112 11.800	200	20.240	51/64	3.7	9.0	13.9	4112 20.240
115	11.910	15/32	2.2	4.5	7.5	4112 11.910	205	20.500		3.8	9.0	13.9	4112 20.500
120	12.000		2.2	5.0	7.7	4112 12.000	205	20.640	13/16	3.8	9.0	13.9	4112 20.640
120	12.100		2.3	5.0	7.7	4112 12.100	205	20.900		3.9	9.0	13.9	4112 20.900
120	12.200		2.3	5.0	7.7	4112 12.200	210	21.000		3.9	9.0	13.9	4112 21.000
120	12.300	31/64	2.3	5.0	7.7	4112 12.300	210	21.030	53/64	3.9	9.0	13.9	4112 21.030
125	12.500		2.3	5.0	7.7	4112 12.500	210	21.100		3.9	9.0	13.9	4112 21.100
125	12.600		2.3	5.0	7.7	4112 12.600	210	21.430	27/32	3.9	9.0	13.9	4112 21.430
125	12.700	1/2	2.4	5.0	7.7	4112 12.700	215	21.500		4.0	9.0	13.9	4112 21.500
125	12.800		2.4	5.0	7.7	4112 12.800	215	21.700		4.0	9.0	13.9	4112 21.700
125	12.900		2.4	5.0	7.7	4112 12.900	215	21.830	55/64	4.0	9.0	13.9	4112 21.830
130	13.000		2.4	5.5	8.5	4112 13.000	220	22.000		4.1	10.0	15.3	4112 22.000
130	13.100	33/64	2.4	5.5	8.5	4112 13.100	220	22.220	7/8	4.1	10.0	15.3	4112 22.220
130	13.300		2.5	5.5	8.5	4112 13.300	225	22.500		4.1	10.0	15.3	4112 22.500
130	13.490	17/32	2.5	5.5	8.5	4112 13.490	225	22.620	57/64	4.2	10.0	15.3	4112 22.620
135	13.500		2.5	5.5	8.5	4112 13.500	225	22.700		4.2	10.0	15.3	4112 22.700
135	13.600		2.5	5.5	8.5	4112 13.600	230	23.000		4.2	10.0	15.3	4112 23.000
135	13.700		2.5	5.5	8.5	4112 13.700	230	23.020	29/32	4.2	10.0	15.3	4112 23.020
135	13.800		2.6	5.5	8.5	4112 13.800	230	23.420	59/64	4.3	10.0	15.3	4112 23.420
135	13.890	35/64	2.6	5.5	8.5	4112 13.890	235	23.500		4.3	10.0	15.3	4112 23.500
140	14.000		2.6	6.0	9.6	4112 14.000	235	23.700		4.4	10.0	15.3	4112 23.700
140	14.100		2.6	6.0	9.6	4112 14.100	235	23.810	15/16	4.4	10.0	15.3	4112 23.810
140	14.290	9/16	2.7	6.0	9.6	4112 14.290	240	24.000		4.4	11.0	15.8	4112 24.000
140	14.400		2.7	6.0	9.6	4112 14.400	240	24.100		4.4	11.0	15.8	4112 24.100
145	14.500		2.7	6.0	9.6	4112 14.500	240	24.210	61/64	4.5	11.0	15.8	4112 24.210
145	14.600		2.7	6.0	9.6	4112 14.600	245	24.500		4.5	11.0	15.8	4112 24.500
145	14.680	37/64	2.7	6.0	9.6	4112 14.680	245	24.610	31/32	4.5	11.0	15.8	4112 24.610
145	14.700		2.7	6.0	9.6	4112 14.700	250	25.000	63/64	4.6	11.0	15.8	4112 25.000
145	14.800		2.7	6.0	9.6	4112 14.800	250	25.250		4.6	11.0	15.8	4112 25.250
150	15.000		2.8	6.0	9.8	4112 15.000	250	25.400	1	4.7	11.0	15.8	4112 25.400
150	15.080	19/32	2.8	6.0	9.8	4112 15.080	255	25.500		4.7	11.0	15.8	4112 25.500
150	15.100		2.8	6.0	9.8	4112 15.100	255	25.650		4.7	11.0	15.8	4112 25.650
150	15.200		2.8	6.0	9.8	4112 15.200	255	25.670		4.7	11.0	15.8	4112 25.670
150	15.300		2.8	6.0	9.8	4112 15.300	255	25.700		4.7	11.0	15.8	4112 25.700
150	15.480	39/64	2.9	6.0	9.8	4112 15.480	255	25.810		4.7	11.0	15.8	4112 25.810
155	15.500		2.9	6.0	9.8	4112 15.500	260	26.000		4.8	12.0	20.0	4112 26.000
155	15.600		2.9	6.0	9.8	4112 15.600	260	26.190	1 1/32	4.8	12.0	20.0	4112 26.190
155	15.700		2.9	6.0	9.8	4112 15.700	265	26.500		4.9	12.0	20.0	4112 26.500
155	15.800		2.9	6.0	9.8	4112 15.800	265	26.590	1 3/64	4.9	12.0	20.0	4112 26.590
155	15.870	5/8	2.9	6.0	9.8	4112 15.870	270	27.000		5.0	12.0	20.0	4112 27.000
160	16.000		3.0	7.0	11.0	4112 16.000	275	27.500		5.1	12.0	20.0	4112 27.500
160	16.270	41/64	3.0	7.0	11.0	4112 16.270	275	27.700		5.1	12.0	20.0	4112 27.700
165	16.500		3.1	7.0	11.0	4112 16.500	275	27.780	1 3/32	5.1	12.0	20.0	4112 27.780
165	16.670	21/32	3.1	7.0	11.0	4112 16.670	280	28.000		5.1	13.0	20.7	4112 28.000
170	17.000		3.1	7.0	11.0	4112 17.000	280	28.180	1 7/64	5.2	13.0	20.7	4112 28.180
170	17.070	43/64	3.2	7.0	11.0	4112 17.070	285	28.500		5.2	13.0	20.7	4112 28.500
170	17.250		3.2	7.0	11.0	4112 17.250	285	28.580		5.3	13.0	20.7	4112 28.580
170	17.300		3.2	7.0	11.0	4112 17.300	290	29.000		5.3	13.0	20.7	4112 29.000
170	17.460	11/16	3.2	7.0	11.0	4112 17.460	290	29.370	1 5/32	5.4	13.0	20.7	4112 29.370
175	17.500		3.2	7.0	11.0	4112 17.500	295	29.500		5.4	13.0	20.7	4112 29.500
175	17.600		3.3	7.0	11.0	4112 17.600	295	29.600		5.4	13.0	20.7	4112 29.600
175	17.860	45/64	3.3	7.0	11.0	4112 17.860	295	29.770	1 11/64	5.5	13.0	20.7	4112 29.770
180	18.000		3.3	8.0	12.6	4112 18.000	300	30.000		5.5	14.0	22.3	4112 30.000
180	18.260	23/32	3.4	8.0	12.6	4112 18.260	300	30.160	1 3/16	5.5	14.0	22.3	4112 30.160
185	18.500		3.4	8.0	12.6	4112 18.500	305	30.500		5.6	14.0	22.3	4112 30.500
185	18.650	47/64	3.4	8.0	12.6	4112 18.650	305	30.960	1 7/32	5.7	14.0	22.3	4112 30.960
185	18.900		3.5	8.0	12.6	4112 18.900	310	31.000		5.7	14.0	22.3	4112 31.000
190	19.000		3.5	8.0	12.6	4112 19.000	315	31.500		5.8	14.0	22.3	4112 31.500
190	19.050	3/4	3.5	8.0	12.6	4112 19.050	315	31.750	1 1/4	5.8	14.0	22.3	4112 31.750
190	19.250		3.6	8.0	12.6	4112 19.250	320	32.000		5.9	15.0	23.1	4112 32.000
190	19.300		3.6	8.0	12.6	4112 19.300	320	32.500		6.0	15.0	23.1	4112 32.500



Modular drills with cutting insert

Modular drills

						Article no.	4112							Article no.	4112
Size	d1 mm	inch	l4 mm	b mm	h mm	Order no.		Size	d1 mm	inch	l4 mm	b mm	h mm	Order no.	
320	32.540	1 9/32	6.0	15.0	23.1	4112 32.540		360	36.000		6.6	16.0	23.9	4112 36.000	
320	32.940	1 19/64	6.0	15.0	23.1	4112 32.940		360	36.500		6.7	16.0	23.9	4112 36.500	
330	33.000		6.1	15.0	23.1	4112 33.000		360	36.510	1 7/16	6.7	16.0	23.9	4112 36.510	
330	33.340	1 5/16	6.1	15.0	23.1	4112 33.340		370	37.000		6.8	16.0	23.9	4112 37.000	
330	33.500		6.1	15.0	23.1	4112 33.500		370	37.310	1 15/32	6.8	16.0	23.9	4112 37.310	
340	34.000		6.2	15.0	23.1	4112 34.000		370	37.500		6.9	16.0	23.9	4112 37.500	
340	34.130	1 11/32	6.3	15.0	23.1	4112 34.130		380	38.000		7.0	16.0	23.9	4112 38.000	
340	34.500		6.3	15.0	23.1	4112 34.500		380	38.100	1 1/2	7.0	16.0	23.9	4112 38.100	
340	34.930		6.4	15.0	23.1	4112 34.930		380	38.500	1 33/64	7.1	16.0	23.9	4112 38.500	
350	35.000		6.4	15.0	23.1	4112 35.000		390	39.000		7.1	16.0	23.9	4112 39.000	
350	35.500		6.5	15.0	23.1	4112 35.500		390	39.500		7.2	16.0	23.9	4112 39.500	
350	35.720	1 13/32	6.6	15.0	23.1	4112 35.720		400	40.000		7.3	16.0	23.9	4112 40.000	



Interchangeable inserts HT 800

Article no. **4113**

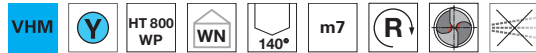

Cutting data page 434-436



Web thinning $\geq \varnothing 11.000$ • facet point grind • main cutting edge form straight (after correction) • clamping screws art. no. 4071 included

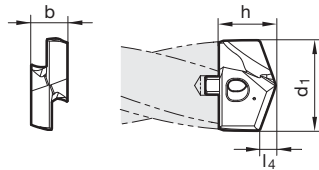

Article no. 4113						Article no. 4113							
Size	d1 mm	inch	l4 mm	b mm	h mm	Order no.	Size	d1 mm	inch	l4 mm	b mm	h mm	Order no.
110	11.000		2.6	4.5	7.5	4113 11.000	195	19.500		4.7	8.0	12.6	4113 19.500
110	11.200		2.6	4.5	7.5	4113 11.200	195	19.600		4.7	8.0	12.6	4113 19.600
115	11.500		2.7	4.5	7.5	4113 11.500	195	19.840	25/32	4.7	8.0	12.6	4113 19.840
115	11.510	29/64	2.7	4.5	7.5	4113 11.510	200	20.000		4.8	9.0	13.9	4113 20.000
115	11.700		2.7	4.5	7.5	4113 11.700	200	20.240	51/64	4.8	9.0	13.9	4113 20.240
115	11.800		2.7	4.5	7.5	4113 11.800	205	20.500		5.0	9.0	13.9	4113 20.500
115	11.910	15/32	2.7	4.5	7.5	4113 11.910	205	20.640	13/16	5.0	9.0	13.9	4113 20.640
120	12.000		2.9	5.0	7.7	4113 12.000	205	20.900		5.0	9.0	13.9	4113 20.900
120	12.100		2.9	5.0	7.7	4113 12.100	210	21.000		5.1	9.0	13.9	4113 21.000
120	12.200		2.9	5.0	7.7	4113 12.200	210	21.030	53/64	5.1	9.0	13.9	4113 21.030
120	12.300	31/64	2.9	5.0	7.7	4113 12.300	210	21.100		5.1	9.0	13.9	4113 21.100
125	12.500		3.0	5.0	7.7	4113 12.500	210	21.430	27/32	5.1	9.0	13.9	4113 21.430
125	12.600		3.0	5.0	7.7	4113 12.600	215	21.500		5.2	9.0	13.9	4113 21.500
125	12.700	1/2	3.0	5.0	7.7	4113 12.700	215	21.700		5.2	9.0	13.9	4113 21.700
125	12.800		3.0	5.0	7.7	4113 12.800	215	21.830	55/64	5.2	9.0	13.9	4113 21.830
125	12.900		3.0	5.0	7.7	4113 12.900	220	22.000		5.3	10.0	15.3	4113 22.000
130	13.000		3.1	5.5	8.5	4113 13.000	220	22.220	7/8	5.3	10.0	15.3	4113 22.220
130	13.100	33/64	3.1	5.5	8.5	4113 13.100	225	22.500		5.4	10.0	15.3	4113 22.500
130	13.300		3.1	5.5	8.5	4113 13.300	225	22.620	57/64	5.4	10.0	15.3	4113 22.620
130	13.490	17/32	3.1	5.5	8.5	4113 13.490	225	22.700		5.4	10.0	15.3	4113 22.700
135	13.500		3.3	5.5	8.5	4113 13.500	230	23.000		5.6	10.0	15.3	4113 23.000
135	13.600		3.3	5.5	8.5	4113 13.600	230	23.020	29/32	5.6	10.0	15.3	4113 23.020
135	13.700		3.3	5.5	8.5	4113 13.700	230	23.420	59/64	5.6	10.0	15.3	4113 23.420
135	13.800		3.3	5.5	8.5	4113 13.800	235	23.500		5.7	10.0	15.3	4113 23.500
135	13.890	35/64	3.3	5.5	8.5	4113 13.890	235	23.700		5.7	10.0	15.3	4113 23.700
140	14.000		3.4	6.0	9.6	4113 14.000	235	23.810	15/16	5.7	10.0	15.3	4113 23.810
140	14.100		3.4	6.0	9.6	4113 14.100	240	24.000		5.8	11.0	15.8	4113 24.000
140	14.290	9/16	3.4	6.0	9.6	4113 14.290	240	24.100		5.8	11.0	15.8	4113 24.100
140	14.400		3.4	6.0	9.6	4113 14.400	240	24.210	61/64	5.8	11.0	15.8	4113 24.210
145	14.500		3.5	6.0	9.6	4113 14.500	245	24.500		6.0	11.0	15.8	4113 24.500
145	14.600		3.5	6.0	9.6	4113 14.600	245	24.610	31/32	6.0	11.0	15.8	4113 24.610
145	14.680	37/64	3.5	6.0	9.6	4113 14.680	250	25.000	63/64	6.1	11.0	15.8	4113 25.000
145	14.700		3.5	6.0	9.6	4113 14.700	250	25.400	1	6.1	11.0	15.8	4113 25.400
145	14.800		3.5	6.0	9.6	4113 14.800	255	25.500		6.2	11.0	15.8	4113 25.500
150	15.000		3.6	6.0	9.8	4113 15.000	255	25.670		6.2	11.0	15.8	4113 25.670
150	15.080	19/32	3.6	6.0	9.8	4113 15.080	255	25.700		6.2	11.0	15.8	4113 25.700
150	15.100		3.6	6.0	9.8	4113 15.100	255	25.810		6.2	11.0	15.8	4113 25.810
150	15.200		3.6	6.0	9.8	4113 15.200	260	26.000		6.0	12.0	20.0	4113 26.000
150	15.300		3.6	6.0	9.8	4113 15.300	260	26.190	1 1/32	6.0	12.0	20.0	4113 26.190
150	15.480	39/64	3.6	6.0	9.8	4113 15.480	265	26.500		6.1	12.0	20.0	4113 26.500
155	15.500		3.8	6.0	9.8	4113 15.500	265	26.590	1 3/64	6.1	12.0	20.0	4113 26.590
155	15.600		3.8	6.0	9.8	4113 15.600	270	27.000		6.3	12.0	20.0	4113 27.000
155	15.700		3.8	6.0	9.8	4113 15.700	275	27.500		6.4	12.0	20.0	4113 27.500
155	15.800		3.8	6.0	9.8	4113 15.800	275	27.700		6.4	12.0	20.0	4113 27.700
155	15.870	5/8	3.8	6.0	9.8	4113 15.870	275	27.780	1 3/32	6.4	12.0	20.0	4113 27.780
160	16.000		3.8	7.0	11.0	4113 16.000	280	28.000		6.6	13.0	20.7	4113 28.000
160	16.270	41/64	3.8	7.0	11.0	4113 16.270	280	28.180	1 7/64	6.6	13.0	20.7	4113 28.180
165	16.500		4.0	7.0	11.0	4113 16.500	285	28.500		6.7	13.0	20.7	4113 28.500
165	16.670	21/32	4.0	7.0	11.0	4113 16.670	285	28.580		6.7	13.0	20.7	4113 28.580
170	17.000		4.1	7.0	11.0	4113 17.000	290	29.000		6.9	13.0	20.7	4113 29.000
170	17.070	43/64	4.1	7.0	11.0	4113 17.070	290	29.370	1 5/32	6.9	13.0	20.7	4113 29.370
170	17.300		4.1	7.0	11.0	4113 17.300	295	29.500		7.0	13.0	20.7	4113 29.500
170	17.460	11/16	4.1	7.0	11.0	4113 17.460	295	29.770	1 11/64	7.0	13.0	20.7	4113 29.770
175	17.500		4.2	7.0	11.0	4113 17.500	300	30.000		6.9	14.0	22.3	4113 30.000
175	17.600		4.2	7.0	11.0	4113 17.600	300	30.160	1 3/16	6.9	14.0	22.3	4113 30.160
175	17.860	45/64	4.2	7.0	11.0	4113 17.860	305	30.500		7.0	14.0	22.3	4113 30.500
180	18.000		4.3	8.0	12.6	4113 18.000	305	30.960	1 7/32	7.0	14.0	22.3	4113 30.960
180	18.260	23/32	4.3	8.0	12.6	4113 18.260	310	31.000		7.2	14.0	22.3	4113 31.000
185	18.500		4.4	8.0	12.6	4113 18.500	315	31.500		7.3	14.0	22.3	4113 31.500
185	18.650	47/64	4.4	8.0	12.6	4113 18.650	315	31.750	1 1/4	7.3	14.0	22.3	4113 31.750
185	18.900		4.4	8.0	12.6	4113 18.900	320	32.000		7.5	15.0	23.1	4113 32.000
190	19.000		4.6	8.0	12.6	4113 19.000	320	32.500		7.6	15.0	23.1	4113 32.500
190	19.050	3/4	4.6	8.0	12.6	4113 19.050	320	32.540	1 9/32	7.6	15.0	23.1	4113 32.540
190	19.250		4.6	8.0	12.6	4113 19.250	320	32.940	1 19/64	7.6	15.0	23.1	4113 32.940
190	19.300		4.6	8.0	12.6	4113 19.300	330	33.000		7.8	15.0	23.1	4113 33.000
190	19.450	49/64	4.6	8.0	12.6	4113 19.450	330	33.340	1 5/16	7.8	15.0	23.1	4113 33.340



Modular drills with cutting insert

Modular drills

						Article no.	4113
Size	d1 mm	inch	l4 mm	b mm	h mm	Order no.	
330	33.500		7.9	15.0	23.1	4113	33.500
340	34.000		8.1	15.0	23.1	4113	34.000
340	34.130	1 11/32	8.1	15.0	23.1	4113	34.130
340	34.500		8.2	15.0	23.1	4113	34.500
340	34.930		8.2	15.0	23.1	4113	34.930
350	35.000		8.3	15.0	23.1	4113	35.000
350	35.500		8.4	15.0	23.1	4113	35.500
350	35.720	1 13/32	8.4	15.0	23.1	4113	35.720
360	36.000		8.5	16.0	23.9	4113	36.000
360	36.500		8.6	16.0	23.9	4113	36.500
360	36.510	1 7/16	8.6	16.0	23.9	4113	36.510
370	37.000		8.8	16.0	23.9	4113	37.000

						Article no.	4113
Size	d1 mm	inch	l4 mm	b mm	h mm	Order no.	
370	37.310	1 15/32	8.8	16.0	23.9	4113	37.310
370	37.500		8.9	16.0	23.9	4113	37.500
380	38.000		9.0	16.0	23.9	4113	38.000
380	38.100	1 1/2	9.0	16.0	23.9	4113	38.100
380	38.500	1 33/64	9.1	16.0	23.9	4113	38.500
390	39.000		9.3	16.0	23.9	4113	39.000
390	39.500		9.4	16.0	23.9	4113	39.500
400	40.000		9.4	16.0	23.9	4113	40.000



Interchangeable inserts HT 800

Article no. 4114

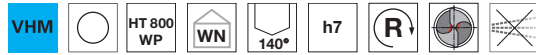

Cutting data page 434-436

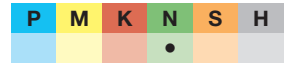

Web thinning $\geq \varnothing 11.000$ • relieved cone • main cutting edge form concave • clamping screws art. no. 4071 included

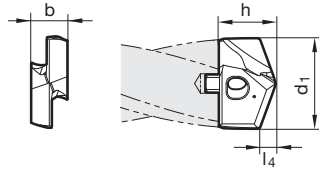

Modular drills

Article no. 4114						Article no. 4114							
Size	d1 mm	inch	l4 mm	b mm	h mm	Order no.	Size	d1 mm	inch	l4 mm	b mm	h mm	Order no.
110	11.000		2.1	4.5	7.5	4114 11.000	200	20.240	51/64	3.7	9.0	13.9	4114 20.240
110	11.200		2.1	4.5	7.5	4114 11.200	205	20.500		3.8	9.0	13.9	4114 20.500
115	11.500		2.1	4.5	7.5	4114 11.500	205	20.640	13/16	3.8	9.0	13.9	4114 20.640
115	11.510	29/64	2.1	4.5	7.5	4114 11.510	210	21.000		3.9	9.0	13.9	4114 21.000
115	11.700		2.2	4.5	7.5	4114 11.700	210	21.030	53/64	3.9	9.0	13.9	4114 21.030
115	11.800		2.2	4.5	7.5	4114 11.800	210	21.100		3.9	9.0	13.9	4114 21.100
115	11.910	15/32	2.2	4.5	7.5	4114 11.910	210	21.430	27/32	3.9	9.0	13.9	4114 21.430
120	12.000		2.2	5.0	7.7	4114 12.000	215	21.500		4.0	9.0	13.9	4114 21.500
120	12.100		2.3	5.0	7.7	4114 12.100	215	21.830	55/64	4.0	9.0	13.9	4114 21.830
120	12.200		2.3	5.0	7.7	4114 12.200	220	22.000		4.1	10.0	15.3	4114 22.000
120	12.300	31/64	2.3	5.0	7.7	4114 12.300	220	22.220	7/8	4.1	10.0	15.3	4114 22.220
125	12.500		2.3	5.0	7.7	4114 12.500	225	22.500		4.1	10.0	15.3	4114 22.500
125	12.600		2.3	5.0	7.7	4114 12.600	225	22.620	57/64	4.2	10.0	15.3	4114 22.620
125	12.700	1/2	2.4	5.0	7.7	4114 12.700	230	23.000		4.2	10.0	15.3	4114 23.000
125	12.800		2.4	5.0	7.7	4114 12.800	230	23.020	29/32	4.2	10.0	15.3	4114 23.020
125	12.900		2.4	5.0	7.7	4114 12.900	230	23.420	59/64	4.3	10.0	15.3	4114 23.420
130	13.000		2.4	5.5	8.5	4114 13.000	235	23.500		4.3	10.0	15.3	4114 23.500
130	13.100	33/64	2.4	5.5	8.5	4114 13.100	235	23.810	15/16	4.4	10.0	15.3	4114 23.810
130	13.490	17/32	2.5	5.5	8.5	4114 13.490	240	24.000		4.4	11.0	15.8	4114 24.000
135	13.500		2.5	5.5	8.5	4114 13.500	240	24.100		4.4	11.0	15.8	4114 24.100
135	13.600		2.5	5.5	8.5	4114 13.600	240	24.210	61/64	4.5	11.0	15.8	4114 24.210
135	13.700		2.5	5.5	8.5	4114 13.700	245	24.500		4.5	11.0	15.8	4114 24.500
135	13.800		2.6	5.5	8.5	4114 13.800	245	24.610	31/32	4.5	11.0	15.8	4114 24.610
135	13.890	35/64	2.6	5.5	8.5	4114 13.890	250	25.000	63/64	4.6	11.0	15.8	4114 25.000
140	14.000		2.6	6.0	9.6	4114 14.000	250	25.400	1	4.7	11.0	15.8	4114 25.400
140	14.100		2.6	6.0	9.6	4114 14.100	255	25.500		4.7	11.0	15.8	4114 25.500
140	14.290	9/16	2.7	6.0	9.6	4114 14.290	255	25.670		4.7	11.0	15.8	4114 25.670
140	14.400		2.7	6.0	9.6	4114 14.400	255	25.700		4.7	11.0	15.8	4114 25.700
145	14.500		2.7	6.0	9.6	4114 14.500	255	25.810		4.7	11.0	15.8	4114 25.810
145	14.600		2.7	6.0	9.6	4114 14.600	260	26.000		4.8	12.0	20.0	4114 26.000
145	14.680	37/64	2.7	6.0	9.6	4114 14.680	260	26.190	1 1/32	4.8	12.0	20.0	4114 26.190
145	14.700		2.7	6.0	9.6	4114 14.700	265	26.500		4.9	12.0	20.0	4114 26.500
145	14.800		2.7	6.0	9.6	4114 14.800	265	26.590	1 3/64	4.9	12.0	20.0	4114 26.590
150	15.000		2.8	6.0	9.8	4114 15.000	270	27.000		5.0	12.0	20.0	4114 27.000
150	15.080	19/32	2.8	6.0	9.8	4114 15.080	275	27.500		5.1	12.0	20.0	4114 27.500
150	15.100		2.8	6.0	9.8	4114 15.100	275	27.700		5.1	12.0	20.0	4114 27.700
150	15.200		2.8	6.0	9.8	4114 15.200	275	27.780	1 3/32	5.1	12.0	20.0	4114 27.780
150	15.300		2.8	6.0	9.8	4114 15.300	280	28.000		5.1	13.0	20.7	4114 28.000
150	15.480	39/64	2.9	6.0	9.8	4114 15.480	280	28.180	1 7/64	5.2	13.0	20.7	4114 28.180
155	15.500		2.9	6.0	9.8	4114 15.500	285	28.500		5.2	13.0	20.7	4114 28.500
155	15.600		2.9	6.0	9.8	4114 15.600	285	28.580		5.3	13.0	20.7	4114 28.580
155	15.700		2.9	6.0	9.8	4114 15.700	290	29.000		5.3	13.0	20.7	4114 29.000
155	15.800		2.9	6.0	9.8	4114 15.800	290	29.370	1 5/32	5.4	13.0	20.7	4114 29.370
155	15.870	5/8	2.9	6.0	9.8	4114 15.870	295	29.500		5.4	13.0	20.7	4114 29.500
160	16.000		3.0	7.0	11.0	4114 16.000	295	29.770	1 11/64	5.5	13.0	20.7	4114 29.770
160	16.270	41/64	3.0	7.0	11.0	4114 16.270	300	30.000		5.5	14.0	22.3	4114 30.000
165	16.500		3.1	7.0	11.0	4114 16.500	300	30.160	1 3/16	5.5	14.0	22.3	4114 30.160
165	16.670	21/32	3.1	7.0	11.0	4114 16.670	305	30.500		5.6	14.0	22.3	4114 30.500
170	17.000		3.1	7.0	11.0	4114 17.000	305	30.960	1 7/32	5.7	14.0	22.3	4114 30.960
170	17.070	43/64	3.2	7.0	11.0	4114 17.070	310	31.000		5.7	14.0	22.3	4114 31.000
170	17.460	11/16	3.2	7.0	11.0	4114 17.460	315	31.500		5.8	14.0	22.3	4114 31.500
175	17.500		3.2	7.0	11.0	4114 17.500	315	31.750	1 1/4	5.8	14.0	22.3	4114 31.750
175	17.600		3.3	7.0	11.0	4114 17.600	320	32.000		5.9	15.0	23.1	4114 32.000
175	17.860	45/64	3.3	7.0	11.0	4114 17.860	320	32.500		6.0	15.0	23.1	4114 32.500
180	18.000		3.3	8.0	12.6	4114 18.000	320	32.540	1 9/32	6.0	15.0	23.1	4114 32.540
180	18.260	23/32	3.4	8.0	12.6	4114 18.260	320	32.940	1 19/64	6.0	15.0	23.1	4114 32.940
185	18.500		3.4	8.0	12.6	4114 18.500	330	33.000		6.1	15.0	23.1	4114 33.000
185	18.650	47/64	3.4	8.0	12.6	4114 18.650	330	33.340	1 5/16	6.1	15.0	23.1	4114 33.340
190	19.000		3.5	8.0	12.6	4114 19.000	330	33.500		6.1	15.0	23.1	4114 33.500
190	19.050	3/4	3.5	8.0	12.6	4114 19.050	340	34.000		6.2	15.0	23.1	4114 34.000
190	19.250		3.6	8.0	12.6	4114 19.250	340	34.130	1 11/32	6.3	15.0	23.1	4114 34.130
190	19.450	49/64	3.6	8.0	12.6	4114 19.450	340	34.500		6.3	15.0	23.1	4114 34.500
195	19.500		3.6	8.0	12.6	4114 19.500	340	34.930		6.4	15.0	23.1	4114 34.930
195	19.600		3.6	8.0	12.6	4114 19.600	350	35.000		6.4	15.0	23.1	4114 35.000
195	19.840	25/32	3.7	8.0	12.6	4114 19.840	350	35.500		6.5	15.0	23.1	4114 35.500
200	20.000		3.7	9.0	13.9	4114 20.000	350	35.720	1 13/32	6.6	15.0	23.1	4114 35.720



Modular drills with cutting insert

Modular drills

Article no. **4114**

Size	d1 mm	inch	l4 mm	b mm	h mm	Order no.
360	36.000		6.6	16.0	23.9	4114 36.000
360	36.500		6.7	16.0	23.9	4114 36.500
360	36.510	1 7/16	6.7	16.0	23.9	4114 36.510
370	37.000		6.8	16.0	23.9	4114 37.000
370	37.310	1 15/32	6.8	16.0	23.9	4114 37.310
370	37.500		6.9	16.0	23.9	4114 37.500

Article no. **4114**

Size	d1 mm	inch	l4 mm	b mm	h mm	Order no.
380	38.000		7.0	16.0	23.9	4114 38.000
380	38.100	1 1/2	7.0	16.0	23.9	4114 38.100
380	38.500	1 33/64	7.1	16.0	23.9	4114 38.500
390	39.000		7.1	16.0	23.9	4114 39.000
390	39.500		7.2	16.0	23.9	4114 39.500
400	40.000		7.3	16.0	23.9	4114 40.000



Interchangeable inserts HT 800

Article no. 4115

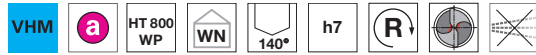

Cutting data page 434-436

P	M	K	N	S	H
○	●	○	○	○	○

Web thinning ≥ Ø 11.000 • relieved cone • main cutting edge form straight (after correction) • clamping screws art. no. 4071 included

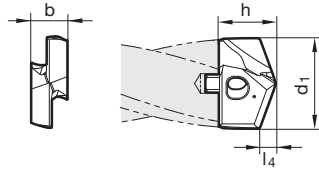

Modular drills

Article no. 4115						Article no. 4115							
Size	d1 mm	inch	l4 mm	b mm	h mm	Order no.	Size	d1 mm	inch	l4 mm	b mm	h mm	Order no.
110	11.000		2.1	4.5	7.5	4115 11.000	200	20.000		3.7	9.0	13.9	4115 20.000
110	11.200		2.1	4.5	7.5	4115 11.200	200	20.240	51/64	3.7	9.0	13.9	4115 20.240
115	11.500		2.1	4.5	7.5	4115 11.500	205	20.500		3.8	9.0	13.9	4115 20.500
115	11.510	29/64	2.1	4.5	7.5	4115 11.510	205	20.640	13/16	3.8	9.0	13.9	4115 20.640
115	11.700		2.2	4.5	7.5	4115 11.700	210	21.000		3.9	9.0	13.9	4115 21.000
115	11.800		2.2	4.5	7.5	4115 11.800	210	21.030	53/64	3.9	9.0	13.9	4115 21.030
115	11.910	15/32	2.2	4.5	7.5	4115 11.910	210	21.100		3.9	9.0	13.9	4115 21.100
120	12.000		2.2	5.0	7.7	4115 12.000	210	21.430	27/32	3.9	9.0	13.9	4115 21.430
120	12.100		2.3	5.0	7.7	4115 12.100	215	21.500		4.0	9.0	13.9	4115 21.500
120	12.200		2.3	5.0	7.7	4115 12.200	215	21.830	55/64	4.0	9.0	13.9	4115 21.830
120	12.300	31/64	2.3	5.0	7.7	4115 12.300	220	22.000		4.1	10.0	15.3	4115 22.000
125	12.500		2.3	5.0	7.7	4115 12.500	220	22.220	7/8	4.1	10.0	15.3	4115 22.220
125	12.600		2.3	5.0	7.7	4115 12.600	225	22.500		4.1	10.0	15.3	4115 22.500
125	12.700	1/2	2.4	5.0	7.7	4115 12.700	225	22.620	57/64	4.2	10.0	15.3	4115 22.620
125	12.800		2.4	5.0	7.7	4115 12.800	230	23.000		4.2	10.0	15.3	4115 23.000
125	12.900		2.4	5.0	7.7	4115 12.900	230	23.020	29/32	4.2	10.0	15.3	4115 23.020
130	13.000		2.4	5.5	8.5	4115 13.000	230	23.420	59/64	4.3	10.0	15.3	4115 23.420
130	13.100	33/64	2.4	5.5	8.5	4115 13.100	235	23.500		4.3	10.0	15.3	4115 23.500
130	13.490	17/32	2.5	5.5	8.5	4115 13.490	235	23.810	15/16	4.4	10.0	15.3	4115 23.810
135	13.500		2.5	5.5	8.5	4115 13.500	240	24.000		4.4	11.0	15.8	4115 24.000
135	13.600		2.5	5.5	8.5	4115 13.600	240	24.100		4.4	11.0	15.8	4115 24.100
135	13.700		2.5	5.5	8.5	4115 13.700	240	24.210	61/64	4.5	11.0	15.8	4115 24.210
135	13.800		2.6	5.5	8.5	4115 13.800	245	24.500		4.5	11.0	15.8	4115 24.500
135	13.890	35/64	2.6	5.5	8.5	4115 13.890	245	24.610	31/32	4.5	11.0	15.8	4115 24.610
140	14.000		2.6	6.0	9.6	4115 14.000	250	25.000	63/64	4.6	11.0	15.8	4115 25.000
140	14.100		2.6	6.0	9.6	4115 14.100	250	25.250		4.6	11.0	15.8	4115 25.250
140	14.290	9/16	2.7	6.0	9.6	4115 14.290	250	25.400	1	4.7	11.0	15.8	4115 25.400
140	14.400		2.7	6.0	9.6	4115 14.400	255	25.500		4.7	11.0	15.8	4115 25.500
145	14.500		2.7	6.0	9.6	4115 14.500	255	25.650		4.7	11.0	15.8	4115 25.650
145	14.600		2.7	6.0	9.6	4115 14.600	255	25.700		4.7	11.0	15.8	4115 25.700
145	14.680	37/64	2.7	6.0	9.6	4115 14.680	260	26.000		4.8	12.0	20.0	4115 26.000
145	14.700		2.7	6.0	9.6	4115 14.700	260	26.190	1 1/32	4.8	12.0	20.0	4115 26.190
145	14.800		2.7	6.0	9.6	4115 14.800	265	26.500		4.9	12.0	20.0	4115 26.500
150	15.000		2.8	6.0	9.8	4115 15.000	265	26.590	1 3/64	4.9	12.0	20.0	4115 26.590
150	15.080	19/32	2.8	6.0	9.8	4115 15.080	270	27.000		5.0	12.0	20.0	4115 27.000
150	15.100		2.8	6.0	9.8	4115 15.100	275	27.500		5.1	12.0	20.0	4115 27.500
150	15.200		2.8	6.0	9.8	4115 15.200	275	27.700		5.1	12.0	20.0	4115 27.700
150	15.300		2.8	6.0	9.8	4115 15.300	275	27.780	1 3/32	5.1	12.0	20.0	4115 27.780
150	15.480	39/64	2.9	6.0	9.8	4115 15.480	280	28.000		5.1	13.0	20.7	4115 28.000
155	15.500		2.9	6.0	9.8	4115 15.500	280	28.180	1 7/64	5.2	13.0	20.7	4115 28.180
155	15.600		2.9	6.0	9.8	4115 15.600	285	28.500		5.2	13.0	20.7	4115 28.500
155	15.700		2.9	6.0	9.8	4115 15.700	285	28.580		5.3	13.0	20.7	4115 28.580
155	15.800		2.9	6.0	9.8	4115 15.800	290	29.000		5.3	13.0	20.7	4115 29.000
155	15.870	5/8	2.9	6.0	9.8	4115 15.870	290	29.370	1 5/32	5.4	13.0	20.7	4115 29.370
160	16.000		3.0	7.0	11.0	4115 16.000	295	29.500		5.4	13.0	20.7	4115 29.500
160	16.270	41/64	3.0	7.0	11.0	4115 16.270	295	29.600		5.4	13.0	20.7	4115 29.600
165	16.500		3.1	7.0	11.0	4115 16.500	295	29.770	1 11/64	5.5	13.0	20.7	4115 29.770
165	16.670	21/32	3.1	7.0	11.0	4115 16.670	300	30.000		5.5	14.0	22.3	4115 30.000
170	17.000		3.1	7.0	11.0	4115 17.000	300	30.160	1 3/16	5.5	14.0	22.3	4115 30.160
170	17.070	43/64	3.2	7.0	11.0	4115 17.070	305	30.500		5.6	14.0	22.3	4115 30.500
170	17.250		3.2	7.0	11.0	4115 17.250	305	30.960	1 7/32	5.7	14.0	22.3	4115 30.960
170	17.460	11/16	3.2	7.0	11.0	4115 17.460	310	31.000		5.7	14.0	22.3	4115 31.000
175	17.500		3.2	7.0	11.0	4115 17.500	315	31.500		5.8	14.0	22.3	4115 31.500
175	17.600		3.3	7.0	11.0	4115 17.600	315	31.750	1 1/4	5.8	14.0	22.3	4115 31.750
175	17.860	45/64	3.3	7.0	11.0	4115 17.860	320	32.000		5.9	15.0	23.1	4115 32.000
180	18.000		3.3	8.0	12.6	4115 18.000	320	32.500		6.0	15.0	23.1	4115 32.500
180	18.260	23/32	3.4	8.0	12.6	4115 18.260	320	32.540	1 9/32	6.0	15.0	23.1	4115 32.540
185	18.500		3.4	8.0	12.6	4115 18.500	320	32.940	1 19/64	6.0	15.0	23.1	4115 32.940
185	18.650	47/64	3.4	8.0	12.6	4115 18.650	330	33.000		6.1	15.0	23.1	4115 33.000
190	19.000		3.5	8.0	12.6	4115 19.000	330	33.340	1 5/16	6.1	15.0	23.1	4115 33.340
190	19.050	3/4	3.5	8.0	12.6	4115 19.050	330	33.500		6.1	15.0	23.1	4115 33.500
190	19.250		3.6	8.0	12.6	4115 19.250	340	34.000		6.2	15.0	23.1	4115 34.000
190	19.450	49/64	3.6	8.0	12.6	4115 19.450	340	34.130	1 11/32	6.3	15.0	23.1	4115 34.130
195	19.500		3.6	8.0	12.6	4115 19.500	340	34.500		6.3	15.0	23.1	4115 34.500
195	19.600		3.6	8.0	12.6	4115 19.600	340	34.930		6.4	15.0	23.1	4115 34.930
195	19.840	25/32	3.7	8.0	12.6	4115 19.840	350	35.000		6.4	15.0	23.1	4115 35.000



Modular drills with cutting insert

Modular drills

						Article no.	4115
Size	d1 mm	inch	l4 mm	b mm	h mm	Order no.	
350	35.500		6.5	15.0	23.1	4115	35.500
350	35.720	1 13/32	6.6	15.0	23.1	4115	35.720
360	36.000		6.6	16.0	23.9	4115	36.000
360	36.500		6.7	16.0	23.9	4115	36.500
360	36.510	1 7/16	6.7	16.0	23.9	4115	36.510
370	37.000		6.8	16.0	23.9	4115	37.000
370	37.310	1 15/32	6.8	16.0	23.9	4115	37.310
370	37.500		6.9	16.0	23.9	4115	37.500
380	38.000		7.0	16.0	23.9	4115	38.000
380	38.100	1 1/2	7.0	16.0	23.9	4115	38.100
380	38.500	1 33/64	7.1	16.0	23.9	4115	38.500
390	39.000		7.1	16.0	23.9	4115	39.000

						Article no.	4115
Size	d1 mm	inch	l4 mm	b mm	h mm	Order no.	
390	39.500		7.2	16.0	23.9	4115	39.500
400	40.000		7.3	16.0	23.9	4115	40.000



Indexable inserts

Article no. **7645**



clamping screws art. no. 6128 not included

P	M	K	N	S	H
•	○	○	○	○	○

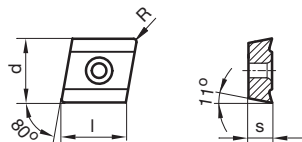

Article no. **7645**

ISO		d mm	s mm	R mm	l mm	Order no.
CPGT050202F	R-	5.560	2.38	0.2	5.64	7645 52.020
CPGT050204F	R-	5.560	2.38	0.4	5.64	7645 52.040
CPGT060202F	R-	6.350	2.38	0.2	6.45	7645 62.020
CPGT060204F	R-	6.350	2.38	0.4	6.45	7645 62.040
CPGT09T308F	R-	9.525	3.97	0.8	9.67	7645 93.080

Indexable inserts

Article no. **7632**



clamping screws art. no. 6128 not included

P	M	K	N	S	H
○		•			

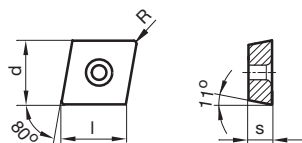

Article no. **7632**

ISO		d mm	s mm	R mm	l mm	Order no.
CPGW050202F	N-K	5.560	2.38	0.2	5.64	7632 52.020
CPGW050204F	N-K	5.560	2.38	0.4	5.64	7632 52.040
CPGW060202F	N-K	6.350	2.38	0.2	6.45	7632 62.020
CPGW060204F	N-K	6.350	2.38	0.4	6.45	7632 62.040
CPGW09T308F	N-K	9.525	3.97	0.8	9.67	7632 93.080

Indexable inserts

Article no. **7635**



clamping screws art. no. 6128 not included

P	M	K	N	S	H
			•		

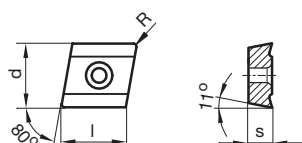

Article no. **7635**

ISO		d mm	s mm	R mm	l mm	Order no.
CPGT050202F	R-AL	5.560	2.38	0.2	5.64	7635 52.020
CPGT050204F	R-AL	5.560	2.38	0.4	5.64	7635 52.040
CPGT060202F	R-AL	6.350	2.38	0.2	6.45	7635 62.020
CPGT060204F	R-AL	6.350	2.38	0.4	6.45	7635 62.040
CPGT09T308F	R-AL	9.525	3.97	0.8	9.67	7635 93.080



Clamping screws

Article no. **6128**

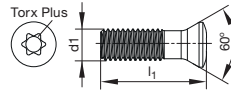

Article no. 6128			Article no. 6128				
G	l1 mm	Torx	Order no.	G	l1 mm	Torx	Order no.
M2	5.50	T6	6128 2.000	M4 x 0,5	11.00	T15	6128 4.003
M2,2	5.00	T6	6128 2.200	M4	9.50	T20	6128 4.004
M2,5	5.30	T7	6128 2.500	M4 x 0,5	9.00	T15	6128 4.005
M2,5	6.50	T7	6128 2.501	M4	9.50	T15	6128 4.006
M2,5	5.70	T7	6128 2.502	M4,5	11.00	T15	6128 4.500
M3,5	10.00	T15	6128 3.500	M4,5	7.50	T15	6128 4.501
M3,5	12.00	T15	6128 3.501	M4,5	11.00	T20	6128 4.502
M3,5	8.50	T15	6128 3.502	M5	17.00	T20	6128 5.000
M3,5	8.00	T15	6128 3.503	M5	11.00	T20	6128 5.001
M4	13.50	T15	6128 4.000				
M4	8.40	T15	6128 4.001				
M4	10.80	T15	6128 4.002				

Clamping screws

Article no. **4071**

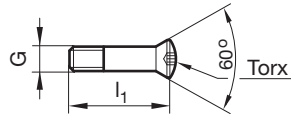

Article no. 4071			Article no. 4071				
G	l1 mm	Torx	Order no.	G	l1 mm	Torx	Order no.
M1,6	3.80	T5	4071 1.600	M4,5	11.80	T15	4071 4.501
M1,6	4.40	T5	4071 1.601	M5	19.75	T20	4071 5.000
M2,2	9.50	T7	4071 2.200	M5	21.75	T20	4071 5.001
M2,2	10.50	T7	4071 2.201	M5	14.20	T20	4071 5.002
M2,2	5.60	T7	4071 2.202	M5	23.40	T20	4071 5.003
M2,2	4.60	T7	4071 2.203	M6	27.00	T25	4071 6.000
M2,5	11.40	T8	4071 2.500	M6	28.50	T25	4071 6.001
M2,5	6.40	T8	4071 2.501	M6	32.50	T25	4071 6.002
M2,5	5.20	T8	4071 2.502				
M3	12.10	T9	4071 3.000				
M3	13.10	T9	4071 3.001				
M3	6.40	T9	4071 3.002				
M3	8.00	T9	4071 3.003				
M3,5	14.25	T10	4071 3.500				
M4	16.00	T15	4071 4.000				
M4	7.70	T15	4071 4.001				
M4	10.60	T15	4071 4.002				
M4,5	18.00	T15	4071 4.500				



Torque wrenches

Article no. **4915**



Article no. **4915**

Torx	Key size	Torque Nm	Type	Order no.
1/4	hexagonal	0,4-1	A	4915 1.001
1/4	hexagonal	0,5-2	A	4915 2.000
1/4	hexagonal	0,8-5	A	4915 5.001
1/4	hexagonal	2-8	A	4915 8.000
1/4	hexagonal	5-14	D	4915 14.000
3/8	square	10-50	B	4915 50.000
1/2	square	20-200	C	4915 200.000

Co-alloyed HSS steel

Article no. **4917**

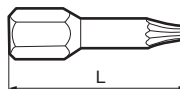

Article no. **4917**

Drive	Key size	Torx	L mm	Order no.
1/4	hexagonal	T5	25	4917 5.000
1/4	hexagonal	T6	25	4917 6.000
1/4	hexagonal	T7	25	4917 7.000
1/4	hexagonal	T8	25	4917 8.000
1/4	hexagonal	T9	25	4917 9.000
1/4	hexagonal	T10	25	4917 10.000
1/4	hexagonal	T15	25	4917 15.000
1/4	hexagonal	T20	25	4917 20.000
1/2	square	T25	25	4917 25.000

Torx screwdrivers

Article no. **1612**

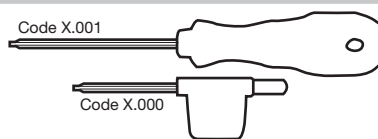

Article no. **1612**

Size	Order no.
T5	1612 5.001
T6	1612 6.000
T6	1612 6.001
T7	1612 7.000
T7	1612 7.001
T8	1612 8.000
T8	1612 8.001
T9	1612 9.001
T10	1612 10.001
T15	1612 15.000
T15	1612 15.001
T20	1612 20.001
T25	1612 25.001
T30	1612 30.001



Solid carbide single-fluted gun drills

Deep hole drills

EB 100 M single-fluted gun drills

Article no. **5646**



Cutting data page 438



solid carbide shank with MQL shank end • head form G

P	M	K	N	S	H
•	•	•	○	○	○

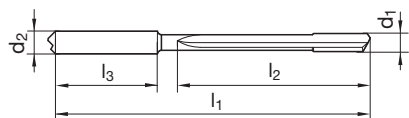

Article no. **5646**

d1	inch	d2 h6	l1	l2	l3	Order no.
1.000		3.0	65.0	32.0	28.0	5646 1.000
1.191	3/64	3.0	70.0	39.0	28.0	5646 1.190
1.500		4.0	80.0	49.0	28.0	5646 1.500
1.588	1/16	4.0	85.0	51.0	28.0	5646 1.590
1.984	5/64	4.0	95.0	64.0	28.0	5646 1.980
2.000		4.0	95.0	65.0	28.0	5646 2.000
2.381	3/32	4.0	100.0	70.0	28.0	5646 2.380
2.500		4.0	115.0	85.0	28.0	5646 2.500
2.778	7/64	4.0	115.0	85.0	28.0	5646 2.780
3.000		6.0	145.0	105.0	36.0	5646 3.000
3.175	1/8	6.0	145.0	105.0	36.0	5646 3.170
3.500		6.0	145.0	105.0	36.0	5646 3.500
3.572	9/64	6.0	160.0	120.0	36.0	5646 3.570
3.969	5/32	6.0	160.0	120.0	36.0	5646 3.970
4.000		6.0	160.0	120.0	36.0	5646 4.000
4.366	11/64	6.0	220.0	180.0	36.0	5646 4.370
4.763	3/16	6.0	220.0	180.0	36.0	5646 4.760
5.000		6.0	220.0	180.0	36.0	5646 5.000
5.159	13/64	6.0	220.0	180.0	36.0	5646 5.160
5.556	7/32	6.0	220.0	180.0	36.0	5646 5.560

Article no. **5646**

d1	inch	d2 h6	l1	l2	l3	Order no.
5.953	15/64	6.0	220.0	180.0	36.0	5646 5.950
6.000		6.0	220.0	180.0	36.0	5646 6.000
6.350	1/4	8.0	260.0	210.0	36.0	5646 6.350
6.500		8.0	260.0	210.0	36.0	5646 6.500
6.747	17/64	8.0	260.0	210.0	36.0	5646 6.750
7.000		8.0	260.0	210.0	36.0	5646 7.000
7.144	9/32	8.0	285.0	240.0	36.0	5646 7.140
7.541	19/64	8.0	285.0	240.0	36.0	5646 7.540
7.938	5/16	8.0	285.0	240.0	36.0	5646 7.940
8.000		8.0	285.0	240.0	36.0	5646 8.000
9.000		10.0	350.0	300.0	40.0	5646 9.000
10.000		10.0	350.0	300.0	40.0	5646 10.000
11.000		12.0	420.0	360.0	45.0	5646 11.000
11.113	7/16	12.0	420.0	360.0	45.0	5646 11.113
12.000		12.0	420.0	360.0	45.0	5646 12.000
12.700	1/2	14.0	455.0	396.0	45.0	5646 12.700
14.000		14.0	500.0	437.0	45.0	5646 14.000
15.000		16.0	535.0	468.0	48.0	5646 15.000
15.875	5/8	16.0	560.0	495.0	48.0	5646 15.875
16.000		16.0	565.0	499.0	48.0	5646 16.000

EB 100 M single-fluted gun drills

Article no. **5685**



Cutting data page 438



solid carbide shank with MQL shank end • head form G

P	M	K	N	S	H
○	○	○	•	•	○

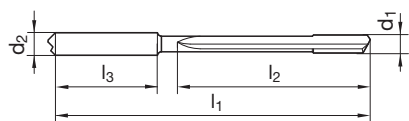

Article no. **5685**

d1	inch	d2 h6	l1	l2	l3	Order no.
1.000		3.0	65.0	32.0	28.0	5685 1.000
1.191	3/64	3.0	70.0	39.0	28.0	5685 1.190
1.500		4.0	80.0	49.0	28.0	5685 1.500
1.588	1/16	4.0	85.0	51.0	28.0	5685 1.590
1.984	5/64	4.0	95.0	64.0	28.0	5685 1.980
2.000		4.0	95.0	65.0	28.0	5685 2.000
2.381	3/32	4.0	100.0	70.0	28.0	5685 2.380
2.500		4.0	115.0	85.0	28.0	5685 2.500
2.778	7/64	4.0	115.0	85.0	28.0	5685 2.780
3.000		6.0	145.0	105.0	36.0	5685 3.000
3.175	1/8	6.0	145.0	105.0	36.0	5685 3.170
3.500		6.0	145.0	105.0	36.0	5685 3.500
3.572	9/64	6.0	160.0	120.0	36.0	5685 3.570
3.969	5/32	6.0	160.0	120.0	36.0	5685 3.970
4.000		6.0	160.0	120.0	36.0	5685 4.000
4.366	11/64	6.0	220.0	180.0	36.0	5685 4.370
4.763	3/16	6.0	220.0	180.0	36.0	5685 4.760
5.000		6.0	220.0	180.0	36.0	5685 5.000
5.159	13/64	6.0	220.0	180.0	36.0	5685 5.160
5.556	7/32	6.0	220.0	180.0	36.0	5685 5.560

Article no. **5685**

d1	inch	d2 h6	l1	l2	l3	Order no.
5.953	15/64	6.0	220.0	180.0	36.0	5685 5.950
6.000		6.0	220.0	180.0	36.0	5685 6.000
6.350	1/4	8.0	260.0	210.0	36.0	5685 6.350
6.500		8.0	260.0	210.0	36.0	5685 6.500
6.747	17/64	8.0	260.0	210.0	36.0	5685 6.750
7.000		8.0	260.0	210.0	36.0	5685 7.000
7.144	9/32	8.0	285.0	240.0	36.0	5685 7.140
7.541	19/64	8.0	285.0	240.0	36.0	5685 7.540
7.938	5/16	8.0	285.0	240.0	36.0	5685 7.940
8.000		8.0	285.0	240.0	36.0	5685 8.000
9.000		10.0	350.0	300.0	40.0	5685 9.000
10.000		10.0	350.0	300.0	40.0	5685 10.000
11.000		12.0	420.0	360.0	45.0	5685 11.000
11.113	7/16	12.0	420.0	360.0	45.0	5685 11.113
12.000		12.0	420.0	360.0	45.0	5685 12.000
12.700	1/2	14.0	455.0	396.0	45.0	5685 12.700
14.000		14.0	500.0	437.0	45.0	5685 14.000
15.000		16.0	535.0	468.0	48.0	5685 15.000
15.875	5/8	16.0	560.0	495.0	48.0	5685 15.875
16.000		16.0	565.0	499.0	48.0	5685 16.000



EB 100 M single-fluted gun drills

Article no. 5647



Cutting data page 438



solid carbide shank with MQL shank end • head form G

P	M	K	N	S	H
•	•	•	○	○	○

Deep hole drills

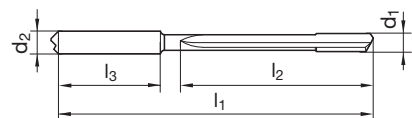

Article no. 5647

d1 mm	inch	d2 h6 mm	l1 mm	l2 mm	l3 mm	Order no.
1.000		3.0	90.0	57.0	28.0	5647 1.000
1.191	3/64	3.0	100.0	68.0	28.0	5647 1.190
1.500		4.0	120.0	86.0	28.0	5647 1.500
1.588	1/16	4.0	125.0	91.0	28.0	5647 1.590
1.984	5/64	4.0	145.0	114.0	28.0	5647 1.980
2.000		4.0	145.0	115.0	28.0	5647 2.000
2.381	3/32	4.0	160.0	130.0	28.0	5647 2.380
2.500		4.0	185.0	155.0	28.0	5647 2.500
2.778	7/64	4.0	185.0	155.0	28.0	5647 2.780
3.000		6.0	230.0	190.0	36.0	5647 3.000
3.175	1/8	6.0	230.0	190.0	36.0	5647 3.170
3.500		6.0	230.0	190.0	36.0	5647 3.500
3.572	9/64	6.0	260.0	220.0	36.0	5647 3.570
3.969	5/32	6.0	260.0	220.0	36.0	5647 3.970
4.000		6.0	260.0	220.0	36.0	5647 4.000
4.366	11/64	6.0	290.0	245.0	36.0	5647 4.370
4.763	3/16	6.0	310.0	268.0	36.0	5647 4.760
5.000		6.0	370.0	330.0	36.0	5647 5.000

Article no. 5647

d1 mm	inch	d2 h6 mm	l1 mm	l2 mm	l3 mm	Order no.
5.159	13/64	6.0	370.0	330.0	36.0	5647 5.160
5.556	7/32	6.0	370.0	330.0	36.0	5647 5.560
5.953	15/64	6.0	370.0	330.0	36.0	5647 5.950
6.000		6.0	370.0	330.0	36.0	5647 6.000
6.350	1/4	8.0	430.0	385.0	36.0	5647 6.350
6.500		8.0	430.0	385.0	36.0	5647 6.500
6.747	17/64	8.0	430.0	385.0	36.0	5647 6.750
7.000		8.0	430.0	385.0	36.0	5647 7.000
7.144	9/32	8.0	485.0	440.0	36.0	5647 7.140
7.541	19/64	8.0	485.0	440.0	36.0	5647 7.540
7.938	5/16	8.0	485.0	440.0	36.0	5647 7.940
8.000		8.0	485.0	440.0	36.0	5647 8.000
9.000		10.0	555.0	506.0	40.0	5647 9.000
10.000		10.0	615.0	562.0	40.0	5647 10.000

EB 100 M single-fluted gun drills

Article no. 5686



Cutting data page 438



solid carbide shank with MQL shank end • head form G

P	M	K	N	S	H
○	○	○	•	•	○

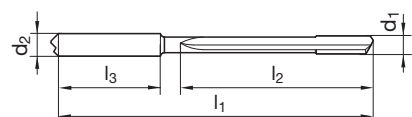

Article no. 5686

d1 mm	inch	d2 h6 mm	l1 mm	l2 mm	l3 mm	Order no.
1.000		3.0	90.0	57.0	28.0	5686 1.000
1.191	3/64	3.0	100.0	68.0	28.0	5686 1.190
1.500		4.0	120.0	86.0	28.0	5686 1.500
1.588	1/16	4.0	125.0	91.0	28.0	5686 1.590
1.984	5/64	4.0	145.0	114.0	28.0	5686 1.980
2.000		4.0	145.0	115.0	28.0	5686 2.000
2.381	3/32	4.0	160.0	130.0	28.0	5686 2.380
2.500		4.0	185.0	155.0	28.0	5686 2.500
2.778	7/64	4.0	185.0	155.0	28.0	5686 2.780
3.000		6.0	230.0	190.0	36.0	5686 3.000
3.175	1/8	6.0	230.0	190.0	36.0	5686 3.170
3.500		6.0	230.0	190.0	36.0	5686 3.500
3.572	9/64	6.0	260.0	220.0	36.0	5686 3.570
3.969	5/32	6.0	260.0	220.0	36.0	5686 3.970
4.000		6.0	260.0	220.0	36.0	5686 4.000
4.366	11/64	6.0	290.0	245.0	36.0	5686 4.370
4.763	3/16	6.0	310.0	268.0	36.0	5686 4.760
5.000		6.0	370.0	330.0	36.0	5686 5.000

Article no. 5686

d1 mm	inch	d2 h6 mm	l1 mm	l2 mm	l3 mm	Order no.
5.159	13/64	6.0	370.0	330.0	36.0	5686 5.160
5.556	7/32	6.0	370.0	330.0	36.0	5686 5.560
5.953	15/64	6.0	370.0	330.0	36.0	5686 5.950
6.000		6.0	370.0	330.0	36.0	5686 6.000
6.350	1/4	8.0	430.0	385.0	36.0	5686 6.350
6.500		8.0	430.0	385.0	36.0	5686 6.500
6.747	17/64	8.0	430.0	385.0	36.0	5686 6.750
7.000		8.0	430.0	385.0	36.0	5686 7.000
7.144	9/32	8.0	485.0	440.0	36.0	5686 7.140
7.541	19/64	8.0	485.0	440.0	36.0	5686 7.540
7.938	5/16	8.0	485.0	440.0	36.0	5686 7.940
8.000		8.0	485.0	440.0	36.0	5686 8.000
9.000		10.0	555.0	506.0	40.0	5686 9.000
10.000		10.0	615.0	562.0	40.0	5686 10.000



Solid carbide single-fluted gun drills

Deep hole drills

EB 100 M single-fluted gun drills

Article no. **5648**



Cutting data page 438



solid carbide shank with MQL shank end • head form G

P	M	K	N	S	H
•	•	•	○	○	○

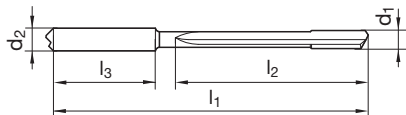

Article no. **5648**

d1	inch	d2 h6	l1	l2	l3	Order no.
1.000		3.0	115.0	82.0	28.0	5648 1.000
1.191	3/64	3.0	130.0	98.0	28.0	5648 1.190
1.500		4.0	155.0	124.0	28.0	5648 1.500
1.588	1/16	4.0	165.0	131.0	28.0	5648 1.590
1.984	5/64	4.0	195.0	163.0	28.0	5648 1.980
2.000		4.0	195.0	165.0	28.0	5648 2.000
2.381	3/32	4.0	220.0	190.0	28.0	5648 2.380
2.500		4.0	255.0	220.0	28.0	5648 2.500
2.778	7/64	4.0	255.0	220.0	28.0	5648 2.780
3.000		6.0	290.0	247.0	36.0	5648 3.000
3.175	1/8	6.0	320.0	280.0	36.0	5648 3.170
3.500		6.0	320.0	280.0	36.0	5648 3.500
3.572	9/64	6.0	360.0	320.0	36.0	5648 3.570
3.969	5/32	6.0	360.0	320.0	36.0	5648 3.970
4.000		6.0	360.0	320.0	36.0	5648 4.000
4.366	11/64	6.0	395.0	355.0	36.0	5648 4.370
4.763	3/16	6.0	430.0	387.0	36.0	5648 4.760
5.000		6.0	450.0	406.0	36.0	5648 5.000

Article no. **5648**

d1	inch	d2 h6	l1	l2	l3	Order no.
5.159	13/64	6.0	465.0	419.0	36.0	5648 5.160
5.556	7/32	6.0	525.0	485.0	36.0	5648 5.560
5.953	15/64	6.0	525.0	485.0	36.0	5648 5.950
6.000		6.0	525.0	485.0	36.0	5648 6.000
6.350	1/4	8.0	560.0	516.0	36.0	5648 6.350
6.500		8.0	575.0	528.0	36.0	5648 6.500
6.747	17/64	8.0	595.0	548.0	36.0	5648 6.750
7.000		8.0	615.0	568.0	36.0	5648 7.000
7.144	9/32	8.0	625.0	580.0	36.0	5648 7.140

EB 100 M single-fluted gun drills

Article no. **5687**



Cutting data page 438



solid carbide shank with MQL shank end • head form G

P	M	K	N	S	H
○	○	○	•	•	○

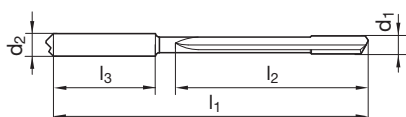

Article no. **5687**

d1	inch	d2 h6	l1	l2	l3	Order no.
1.000		3.0	115.0	82.0	28.0	5687 1.000
1.191	3/64	3.0	130.0	98.0	28.0	5687 1.190
1.500		4.0	155.0	124.0	28.0	5687 1.500
1.588	1/16	4.0	165.0	131.0	28.0	5687 1.590
1.984	5/64	4.0	195.0	163.0	28.0	5687 1.980
2.000		4.0	195.0	165.0	28.0	5687 2.000
2.381	3/32	4.0	220.0	190.0	28.0	5687 2.380
2.500		4.0	255.0	220.0	28.0	5687 2.500
2.778	7/64	4.0	255.0	220.0	28.0	5687 2.780
3.000		6.0	290.0	247.0	36.0	5687 3.000
3.175	1/8	6.0	320.0	280.0	36.0	5687 3.170
3.500		6.0	320.0	280.0	36.0	5687 3.500
3.572	9/64	6.0	360.0	320.0	36.0	5687 3.570
3.969	5/32	6.0	360.0	320.0	36.0	5687 3.970
4.000		6.0	360.0	320.0	36.0	5687 4.000
4.366	11/64	6.0	395.0	355.0	36.0	5687 4.370
4.763	3/16	6.0	430.0	387.0	36.0	5687 4.760
5.000		6.0	450.0	406.0	36.0	5687 5.000

Article no. **5687**

d1	inch	d2 h6	l1	l2	l3	Order no.
5.159	13/64	6.0	465.0	419.0	36.0	5687 5.160
5.556	7/32	6.0	525.0	485.0	36.0	5687 5.560
5.953	15/64	6.0	525.0	485.0	36.0	5687 5.950
6.000		6.0	525.0	485.0	36.0	5687 6.000
6.350	1/4	8.0	560.0	516.0	36.0	5687 6.350
6.500		8.0	575.0	528.0	36.0	5687 6.500
6.747	17/64	8.0	595.0	548.0	36.0	5687 6.750
7.000		8.0	615.0	568.0	36.0	5687 7.000
7.144	9/32	8.0	625.0	580.0	36.0	5687 7.140



EB 100 single-fluted gun drills

Article no. 5024



Cutting data page 438



flute length 45 mm • head form G

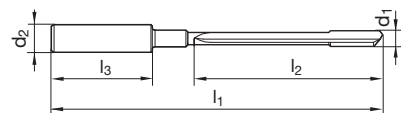

Article no. 5024

d1 mm	inch	d2 h6 mm	l1 mm	l2 mm	l3 mm	Order no.
0.900		4.0	90.0	45.0	28.0	5024 0.900
1.000		4.0	90.0	45.0	28.0	5024 1.000
1.100		4.0	90.0	45.0	28.0	5024 1.100
1.191	3/64	4.0	90.0	45.0	28.0	5024 1.190
1.200		4.0	90.0	45.0	28.0	5024 1.200
1.300		4.0	90.0	45.0	28.0	5024 1.300
1.400		4.0	90.0	45.0	28.0	5024 1.400
1.500		4.0	90.0	45.0	28.0	5024 1.500
1.588	1/16	4.0	90.0	45.0	28.0	5024 1.590
1.600		4.0	90.0	45.0	28.0	5024 1.600
1.900		4.0	90.0	45.0	28.0	5024 1.900
1.984	5/64	4.0	90.0	45.0	28.0	5024 1.980

Article no. 5024

d1 mm	inch	d2 h6 mm	l1 mm	l2 mm	l3 mm	Order no.
2.000		4.0	90.0	45.0	28.0	5024 2.000
2.500		10.0	100.0	45.0	40.0	5024 2.500
2.700		10.0	100.0	45.0	40.0	5024 2.700
3.000		10.0	100.0	45.0	40.0	5024 3.000
3.200		10.0	100.0	45.0	40.0	5024 3.200

EB 100 single-fluted gun drills

Article no. 5632



Cutting data page 438



flute length 45 mm • head form G

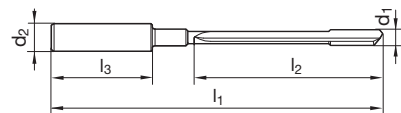

Article no. 5632

d1 mm	inch	d2 h6 mm	l1 mm	l2 mm	l3 mm	Order no.
1.000		4.0	90.0	45.0	28.0	5632 1.000
1.100		4.0	90.0	45.0	28.0	5632 1.100
1.191	3/64	4.0	90.0	45.0	28.0	5632 1.190
1.200		4.0	90.0	45.0	28.0	5632 1.200
1.300		4.0	90.0	45.0	28.0	5632 1.300
1.400		4.0	90.0	45.0	28.0	5632 1.400
1.500		4.0	90.0	45.0	28.0	5632 1.500
1.588	1/16	4.0	90.0	45.0	28.0	5632 1.590
1.600		4.0	90.0	45.0	28.0	5632 1.600
1.900		4.0	90.0	45.0	28.0	5632 1.900
1.984	5/64	4.0	90.0	45.0	28.0	5632 1.980
2.000		4.0	90.0	45.0	28.0	5632 2.000

Article no. 5632

d1 mm	inch	d2 h6 mm	l1 mm	l2 mm	l3 mm	Order no.
2.500		10.0	100.0	45.0	40.0	5632 2.500
2.700		10.0	100.0	45.0	40.0	5632 2.700
3.000		10.0	100.0	45.0	40.0	5632 3.000
3.200		10.0	100.0	45.0	40.0	5632 3.200



Solid carbide single-fluted gun drills

Deep hole drills

EB 100 single-fluted gun drills

Article no. **5020**



Cutting data page 438



flute length 80 mm • head form G

P	M	K	N	S	H
○	○	○	●	●	○

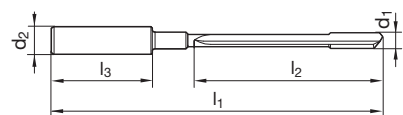

Article no. **5020**

d1 mm	inch	d2 h6 mm	l1 mm	l2 mm	l3 mm	Order no.
1.000		4.0	125.0	80.0	28.0	5020 1.000
1.100		4.0	125.0	80.0	28.0	5020 1.100
1.191	3/64	4.0	125.0	80.0	28.0	5020 1.190
1.200		4.0	125.0	80.0	28.0	5020 1.200
1.300		4.0	125.0	80.0	28.0	5020 1.300
1.400		4.0	125.0	80.0	28.0	5020 1.400
1.500		4.0	125.0	80.0	28.0	5020 1.500
1.588	1/16	4.0	125.0	80.0	28.0	5020 1.590
1.600		4.0	125.0	80.0	28.0	5020 1.600
1.900		4.0	125.0	80.0	28.0	5020 1.900
1.984	5/64	4.0	125.0	80.0	28.0	5020 1.980
2.000		4.0	125.0	80.0	28.0	5020 2.000

Article no. **5020**

d1 mm	inch	d2 h6 mm	l1 mm	l2 mm	l3 mm	Order no.
2.500		10.0	135.0	80.0	40.0	5020 2.500
2.700		10.0	135.0	80.0	40.0	5020 2.700
3.000		10.0	135.0	80.0	40.0	5020 3.000
3.200		10.0	135.0	80.0	40.0	5020 3.200
3.500		10.0	135.0	80.0	40.0	5020 3.500
4.000		10.0	135.0	80.0	40.0	5020 4.000
4.200		10.0	135.0	80.0	40.0	5020 4.200
4.500		10.0	135.0	80.0	40.0	5020 4.500
5.000		10.0	135.0	80.0	40.0	5020 5.000

EB 100 single-fluted gun drills

Article no. **5633**



Cutting data page 438



flute length 80 mm • head form G

P	M	K	N	S	H
●	●	●	○	○	○

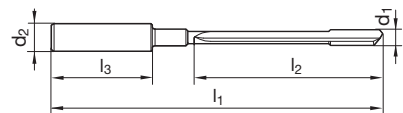

Article no. **5633**

d1 mm	inch	d2 h6 mm	l1 mm	l2 mm	l3 mm	Order no.
1.000		4.0	125.0	80.0	28.0	5633 1.000
1.100		4.0	125.0	80.0	28.0	5633 1.100
1.191	3/64	4.0	125.0	80.0	28.0	5633 1.190
1.200		4.0	125.0	80.0	28.0	5633 1.200
1.300		4.0	125.0	80.0	28.0	5633 1.300
1.400		4.0	125.0	80.0	28.0	5633 1.400
1.500		4.0	125.0	80.0	28.0	5633 1.500
1.588	1/16	4.0	125.0	80.0	28.0	5633 1.590
1.600		4.0	125.0	80.0	28.0	5633 1.600
1.900		4.0	125.0	80.0	28.0	5633 1.900
1.984	5/64	4.0	125.0	80.0	28.0	5633 1.980
2.000		4.0	125.0	80.0	28.0	5633 2.000

Article no. **5633**

d1 mm	inch	d2 h6 mm	l1 mm	l2 mm	l3 mm	Order no.
2.500		10.0	135.0	80.0	40.0	5633 2.500
2.700		10.0	135.0	80.0	40.0	5633 2.700
3.000		10.0	135.0	80.0	40.0	5633 3.000
3.200		10.0	135.0	80.0	40.0	5633 3.200
3.500		10.0	135.0	80.0	40.0	5633 3.500
4.000		10.0	135.0	80.0	40.0	5633 4.000
4.200		10.0	135.0	80.0	40.0	5633 4.200
4.500		10.0	135.0	80.0	40.0	5633 4.500
5.000		10.0	135.0	80.0	40.0	5633 5.000



EB 100 single-fluted gun drills

Article no. 5026



Cutting data page 438



P	M	K	N	S	H
○	○	○	●	●	○

flute length 120 mm • head form G

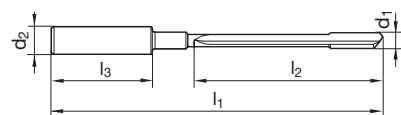

Article no. 5026

d1 mm	inch	d2 h6 mm	l1 mm	l2 mm	l3 mm	Order no.
1.500		4.0	165.0	120.0	28.0	5026 1.500
1.588	1/16	4.0	165.0	120.0	28.0	5026 1.590
1.600		4.0	165.0	120.0	28.0	5026 1.600
1.984	5/64	4.0	165.0	120.0	28.0	5026 1.980
2.000		4.0	165.0	120.0	28.0	5026 2.000
2.500		10.0	175.0	120.0	40.0	5026 2.500
2.700		10.0	175.0	120.0	40.0	5026 2.700
3.000		10.0	175.0	120.0	40.0	5026 3.000
3.200		10.0	175.0	120.0	40.0	5026 3.200
3.500		10.0	175.0	120.0	40.0	5026 3.500
4.000		10.0	175.0	120.0	40.0	5026 4.000
4.200		10.0	175.0	120.0	40.0	5026 4.200

Article no. 5026

d1 mm	inch	d2 h6 mm	l1 mm	l2 mm	l3 mm	Order no.
4.500		10.0	175.0	120.0	40.0	5026 4.500
5.000		10.0	175.0	120.0	40.0	5026 5.000

EB 100 single-fluted gun drills

Article no. 5637



Cutting data page 438



P	M	K	N	S	H
●	●	●	○	○	○

flute length 120 mm • head form G

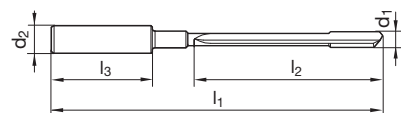

Article no. 5637

d1 mm	inch	d2 h6 mm	l1 mm	l2 mm	l3 mm	Order no.
1.500		4.0	165.0	120.0	28.0	5637 1.500
1.588	1/16	4.0	165.0	120.0	28.0	5637 1.590
1.600		4.0	165.0	120.0	28.0	5637 1.600
1.984	5/64	4.0	165.0	120.0	28.0	5637 1.980
2.000		4.0	165.0	120.0	28.0	5637 2.000
2.500		10.0	175.0	120.0	40.0	5637 2.500
2.700		10.0	175.0	120.0	40.0	5637 2.700
3.000		10.0	175.0	120.0	40.0	5637 3.000
3.200		10.0	175.0	120.0	40.0	5637 3.200
3.500		10.0	175.0	120.0	40.0	5637 3.500
4.000		10.0	175.0	120.0	40.0	5637 4.000
4.200		10.0	175.0	120.0	40.0	5637 4.200

Article no. 5637

d1 mm	inch	d2 h6 mm	l1 mm	l2 mm	l3 mm	Order no.
4.500		10.0	175.0	120.0	40.0	5637 4.500
5.000		10.0	175.0	120.0	40.0	5637 5.000



Solid carbide single-fluted gun drills

Deep hole drills

EB 100 single-fluted gun drills

Article no. **5021**



Cutting data page 438



P	M	K	N	S	H
○	○	○	●	●	○

flute length 160 mm • head form G

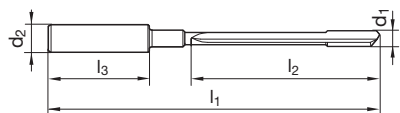

Article no. **5021**

d1	inch	d2 h6	l1	l2	l3	Order no.
1.500		4.0	205.0	160.0	28.0	5021 1.500
1.588	1/16	4.0	205.0	160.0	28.0	5021 1.590
1.600		4.0	205.0	160.0	28.0	5021 1.600
1.984	5/64	4.0	205.0	160.0	28.0	5021 1.980
2.000		4.0	205.0	160.0	28.0	5021 2.000
2.500		10.0	215.0	160.0	40.0	5021 2.500
2.700		10.0	215.0	160.0	40.0	5021 2.700
3.000		10.0	215.0	160.0	40.0	5021 3.000
3.200		10.0	215.0	160.0	40.0	5021 3.200
3.500		10.0	215.0	160.0	40.0	5021 3.500
4.000		10.0	215.0	160.0	40.0	5021 4.000
4.200		10.0	215.0	160.0	40.0	5021 4.200

Article no. **5021**

d1	inch	d2 h6	l1	l2	l3	Order no.
4.500		10.0	215.0	160.0	40.0	5021 4.500
5.000		10.0	215.0	160.0	40.0	5021 5.000
6.000		16.0	225.0	160.0	48.0	5021 6.000
8.000		16.0	225.0	160.0	48.0	5021 8.000

EB 100 single-fluted gun drills

Article no. **5638**



Cutting data page 438



P	M	K	N	S	H
●	●	●	○	○	○

flute length 160 mm • head form G

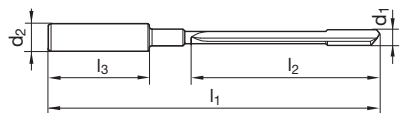

Article no. **5638**

d1	inch	d2 h6	l1	l2	l3	Order no.
1.500		4.0	205.0	160.0	28.0	5638 1.500
1.588	1/16	4.0	205.0	160.0	28.0	5638 1.590
1.600		4.0	205.0	160.0	28.0	5638 1.600
1.984	5/64	4.0	205.0	160.0	28.0	5638 1.980
2.000		4.0	205.0	160.0	28.0	5638 2.000
2.500		10.0	215.0	160.0	40.0	5638 2.500
2.700		10.0	215.0	160.0	40.0	5638 2.700
3.000		10.0	215.0	160.0	40.0	5638 3.000
3.200		10.0	215.0	160.0	40.0	5638 3.200
3.500		10.0	215.0	160.0	40.0	5638 3.500
4.000		10.0	215.0	160.0	40.0	5638 4.000
4.200		10.0	215.0	160.0	40.0	5638 4.200

Article no. **5638**

d1	inch	d2 h6	l1	l2	l3	Order no.
4.500		10.0	215.0	160.0	40.0	5638 4.500
5.000		10.0	215.0	160.0	40.0	5638 5.000
6.000		16.0	225.0	160.0	48.0	5638 6.000
8.000		16.0	225.0	160.0	48.0	5638 8.000



EB 80 single-fluted gun drills

Article no. 5018



with recessed coolant chamber • head form G • with lateral chip breaker

Cutting data page 439

P	M	K	N	S	H
●	○	●	○	○	○

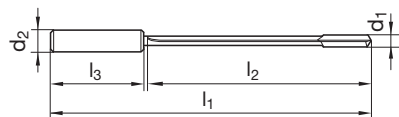

Article no. 5018

d1 mm	inch	d2 h6 mm	l1 mm	l2 mm	l3 mm	Order no.
4.000		12.0	150.0	100.0	45.0	5018 4.000
4.200		12.0	160.0	110.0	45.0	5018 4.200
4.500		12.0	170.0	120.0	45.0	5018 4.500
5.000		16.0	180.0	130.0	48.0	5018 5.000
5.500		16.0	190.0	140.0	48.0	5018 5.500
6.000		16.0	210.0	160.0	48.0	5018 6.000

Article no. 5018

d1 mm	inch	d2 h6 mm	l1 mm	l2 mm	l3 mm	Order no.
6.500		16.0	220.0	170.0	48.0	5018 6.500
7.000		16.0	235.0	185.0	48.0	5018 7.000
8.000		16.0	260.0	210.0	48.0	5018 8.000
9.000		16.0	280.0	230.0	48.0	5018 9.000
10.000		20.0	320.0	260.0	50.0	5018 10.000
12.000		20.0	370.0	310.0	50.0	5018 12.000

EB 80 single-fluted gun drills

Article no. 5639



head form G

Cutting data page 439

P	M	K	N	S	H
●	○	○	○	●	○

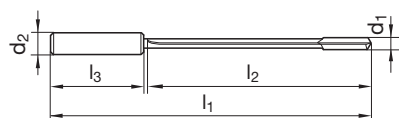

Article no. 5639

d1 mm	inch	d2 h6 mm	l1 mm	l2 mm	l3 mm	Order no.
3.969	5/32	10.0	150.0	100.0	40.0	5639 3.970
4.000		12.0	150.0	100.0	45.0	5639 4.000
4.200		12.0	160.0	110.0	45.0	5639 4.200
4.500		12.0	170.0	120.0	45.0	5639 4.500
5.000		16.0	180.0	130.0	48.0	5639 5.000
5.159	13/64	16.0	180.0	130.0	48.0	5639 5.156
5.500		16.0	190.0	140.0	48.0	5639 5.500
6.000		16.0	210.0	160.0	48.0	5639 6.000
6.350	1/4	16.0	220.0	170.0	48.0	5639 6.350
6.500		16.0	220.0	170.0	48.0	5639 6.500
7.000		16.0	235.0	185.0	48.0	5639 7.000
7.500		16.0	245.0	195.0	48.0	5639 7.500
7.938	5/16	16.0	260.0	210.0	48.0	5639 7.938
8.000		16.0	260.0	210.0	48.0	5639 8.000
8.500		16.0	275.0	220.0	48.0	5639 8.500
9.000		16.0	280.0	230.0	48.0	5639 9.000
9.500		16.0	300.0	245.0	48.0	5639 9.500
9.525	3/8	16.0	290.0	240.0	48.0	5639 9.525

Article no. 5639

d1 mm	inch	d2 h6 mm	l1 mm	l2 mm	l3 mm	Order no.
10.000		20.0	320.0	260.0	50.0	5639 10.000
10.500		20.0	330.0	275.0	50.0	5639 10.500
11.000		20.0	340.0	285.0	50.0	5639 11.000
11.113	7/16	20.0	340.0	290.0	50.0	5639 11.113
11.500		20.0	355.0	300.0	50.0	5639 11.500
12.000		20.0	370.0	310.0	50.0	5639 12.000
12.500		20.0	380.0	325.0	50.0	5639 12.500
12.700	1/2	20.0	385.0	330.0	50.0	5639 12.700
13.000		20.0	390.0	335.0	50.0	5639 13.000
13.500		20.0	395.0	340.0	50.0	5639 13.500
14.000		20.0	400.0	345.0	50.0	5639 14.000
14.500		25.0	420.0	355.0	56.0	5639 14.500
15.000		25.0	430.0	370.0	56.0	5639 15.000
15.500		25.0	445.0	380.0	56.0	5639 15.500
16.000		25.0	455.0	395.0	56.0	5639 16.000



Brazed single-fluted gun drills

Deep hole drills

EB 80 single-fluted gun drills

Article no. **5460**



with recessed coolant chamber • head form G • with lateral chip breaker

Cutting data page 439

P	M	K	N	S	H
●	○	●	○	○	○

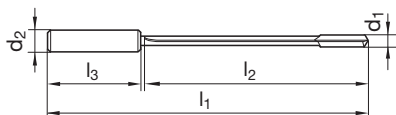

Article no. **5460**

d1 mm	inch	d2 h6 mm	l1 mm	l2 mm	l3 mm	Order no.
4.000		12.0	200.0	155.0	45.0	5460 4.000
4.200		12.0	210.0	165.0	45.0	5460 4.200
4.500		12.0	220.0	175.0	45.0	5460 4.500
5.000		16.0	230.0	182.0	48.0	5460 5.000
5.500		16.0	245.0	197.0	48.0	5460 5.500
6.000		16.0	260.0	212.0	48.0	5460 6.000

Article no. **5460**

d1 mm	inch	d2 h6 mm	l1 mm	l2 mm	l3 mm	Order no.
6.500		16.0	275.0	227.0	48.0	5460 6.500
7.000		16.0	290.0	242.0	48.0	5460 7.000
8.000		16.0	320.0	272.0	48.0	5460 8.000
9.000		16.0	350.0	302.0	48.0	5460 9.000
10.000		20.0	400.0	350.0	50.0	5460 10.000
12.000		20.0	450.0	400.0	50.0	5460 12.000

EB 80 single-fluted gun drills

Article no. **5640**



head form G

Cutting data page 439

P	M	K	N	S	H
●	○	○	○	●	○

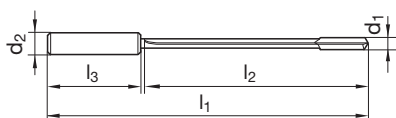

Article no. **5640**

d1 mm	inch	d2 h6 mm	l1 mm	l2 mm	l3 mm	Order no.
3.969	5/32	10.0	200.0	155.0	40.0	5640 3.970
4.000		12.0	200.0	155.0	45.0	5640 4.000
4.200		12.0	210.0	165.0	45.0	5640 4.200
4.500		12.0	220.0	175.0	45.0	5640 4.500
5.000		16.0	230.0	182.0	48.0	5640 5.000
5.159	13/64	16.0	230.0	182.0	48.0	5640 5.156
5.500		16.0	245.0	197.0	48.0	5640 5.500
6.000		16.0	260.0	212.0	48.0	5640 6.000
6.350	1/4	16.0	275.0	227.0	48.0	5640 6.350
6.500		16.0	275.0	227.0	48.0	5640 6.500
7.000		16.0	290.0	242.0	48.0	5640 7.000
7.500		16.0	320.0	270.0	48.0	5640 7.500
7.938	5/16	16.0	320.0	272.0	48.0	5640 7.938
8.000		16.0	320.0	272.0	48.0	5640 8.000
8.500		16.0	360.0	305.0	48.0	5640 8.500
9.000		16.0	350.0	302.0	48.0	5640 9.000
9.500		16.0	395.0	340.0	48.0	5640 9.500
9.525	3/8	16.0	380.0	330.0	48.0	5640 9.525

Article no. **5640**

d1 mm	inch	d2 h6 mm	l1 mm	l2 mm	l3 mm	Order no.
10.000		20.0	400.0	350.0	50.0	5640 10.000
10.500		20.0	435.0	380.0	50.0	5640 10.500
11.000		20.0	430.0	380.0	50.0	5640 11.000
11.113	7/16	20.0	430.0	380.0	50.0	5640 11.113
11.500		20.0	470.0	415.0	50.0	5640 11.500
12.000		20.0	450.0	400.0	50.0	5640 12.000
12.500		20.0	505.0	450.0	50.0	5640 12.500
12.700	1/2	20.0	500.0	450.0	50.0	5640 12.700
13.000		20.0	520.0	465.0	50.0	5640 13.000
13.500		20.0	530.0	475.0	50.0	5640 13.500
14.000		20.0	540.0	485.0	50.0	5640 14.000
14.500		25.0	565.0	500.0	56.0	5640 14.500
15.000		25.0	580.0	520.0	56.0	5640 15.000
15.500		25.0	600.0	535.0	56.0	5640 15.500
16.000		25.0	615.0	555.0	56.0	5640 16.000



EB 80 single-fluted gun drills

Article no. 5689



head form G

Cutting data page 439

P	M	K	N	S	H
○	○	○	●	○	○

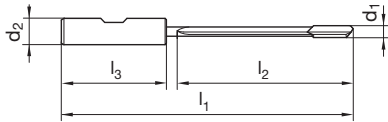

Article no. 5689

Article no. 5689

d1 mm	inch	d2 h6 mm	l1 mm	l2 mm	l3 mm	Order no.
4.000		12.0	230.0	185.0	45.0	5689 4.000
5.000		16.0	280.0	232.0	48.0	5689 5.000
6.000		16.0	320.0	272.0	48.0	5689 6.000
7.000		16.0	370.0	322.0	48.0	5689 7.000
8.000		16.0	420.0	372.0	48.0	5689 8.000
9.000		16.0	450.0	402.0	48.0	5689 9.000

d1 mm	inch	d2 h6 mm	l1 mm	l2 mm	l3 mm	Order no.
10.000		20.0	510.0	460.0	50.0	5689 10.000
12.000		20.0	600.0	550.0	50.0	5689 12.000

EB 80 single-fluted gun drills

Article no. 5022



with recessed coolant chamber • head form G • with lateral chip breaker

Cutting data page 439

P	M	K	N	S	H
●	○	●	○	○	○

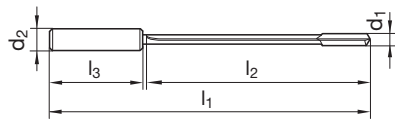

Article no. 5022

Article no. 5022

d1 mm	inch	d2 h6 mm	l1 mm	l2 mm	l3 mm	Order no.
4.000		12.0	230.0	185.0	45.0	5022 4.000
4.200		12.0	240.0	195.0	45.0	5022 4.200
4.500		12.0	250.0	205.0	45.0	5022 4.500
5.000		16.0	280.0	232.0	48.0	5022 5.000
5.500		16.0	300.0	252.0	48.0	5022 5.500
6.000		16.0	320.0	272.0	48.0	5022 6.000

d1 mm	inch	d2 h6 mm	l1 mm	l2 mm	l3 mm	Order no.
6.500		16.0	340.0	292.0	48.0	5022 6.500
7.000		16.0	370.0	322.0	48.0	5022 7.000
8.000		16.0	420.0	372.0	48.0	5022 8.000
9.000		16.0	450.0	402.0	48.0	5022 9.000
10.000		20.0	510.0	460.0	50.0	5022 10.000
12.000		20.0	600.0	550.0	50.0	5022 12.000



Brazed single-fluted gun drills

Deep hole drills

EB 80 single-fluted gun drills

Article no. **5641**



Cutting data page 439



head form G

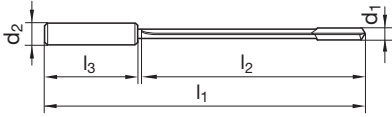

d1		d2 h6		l1	l2	l3	Order no.
mm	inch	mm	mm	mm	mm	mm	
3.969	5/32	10.0	230.0	185.0	40.0	5641 3.970	
4.000		12.0	230.0	185.0	45.0	5641 4.000	
4.200		12.0	240.0	195.0	45.0	5641 4.200	
4.500		12.0	250.0	205.0	45.0	5641 4.500	
5.000		16.0	280.0	232.0	48.0	5641 5.000	
5.159	13/64	16.0	280.0	232.0	48.0	5641 5.156	
5.500		16.0	300.0	252.0	48.0	5641 5.500	
6.000		16.0	320.0	272.0	48.0	5641 6.000	
6.350	1/4	16.0	340.0	292.0	48.0	5641 6.350	
6.500		16.0	340.0	292.0	48.0	5641 6.500	
7.000		16.0	370.0	322.0	48.0	5641 7.000	
7.500		16.0	395.0	345.0	48.0	5641 7.500	
7.938	5/16	16.0	420.0	372.0	48.0	5641 7.938	
8.000		16.0	420.0	372.0	48.0	5641 8.000	
8.500		16.0	445.0	390.0	48.0	5641 8.500	
9.000		16.0	450.0	402.0	48.0	5641 9.000	
9.500		16.0	490.0	435.0	48.0	5641 9.500	
9.525	3/8	16.0	480.0	432.0	48.0	5641 9.525	

d1		d2 h6		l1	l2	l3	Order no.
mm	inch	mm	mm	mm	mm	mm	
10.000		20.0	510.0	460.0	50.0	5641 10.000	
10.500		20.0	540.0	485.0	50.0	5641 10.500	
11.000		20.0	550.0	500.0	50.0	5641 11.000	
11.113	7/16	20.0	550.0	500.0	50.0	5641 11.113	
11.500		20.0	585.0	530.0	50.0	5641 11.500	
12.000		20.0	600.0	550.0	50.0	5641 12.000	
12.500		20.0	630.0	575.0	50.0	5641 12.500	
12.700	1/2	20.0	635.0	585.0	50.0	5641 12.700	
13.000		20.0	650.0	595.0	50.0	5641 13.000	
13.500		20.0	660.0	605.0	50.0	5641 13.500	
14.000		20.0	680.0	625.0	50.0	5641 14.000	
14.500		25.0	710.0	645.0	56.0	5641 14.500	
15.000		25.0	730.0	670.0	56.0	5641 15.000	
15.500		25.0	755.0	690.0	56.0	5641 15.500	
16.000		25.0	775.0	715.0	56.0	5641 16.000	

EB 80 single-fluted gun drills

Article no. **5669**



Cutting data page 439



head form G

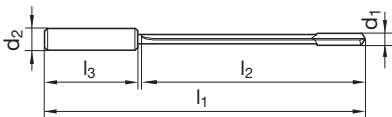

d1		d2 h6		l1	l2	l3	Order no.
mm	inch	mm	mm	mm	mm	mm	
3.969	5/32	10.0	310.0	265.0	40.0	5669 3.970	
4.150		12.0	325.0	275.0	45.0	5669 4.150	
4.450		12.0	345.0	295.0	45.0	5669 4.450	
4.950		16.0	375.0	325.0	48.0	5669 4.950	
5.109		16.0	390.0	335.0	48.0	5669 5.106	
5.450		16.0	410.0	360.0	48.0	5669 5.450	
5.953	15/64	16.0	445.0	390.0	48.0	5669 5.950	
6.300		16.0	470.0	415.0	48.0	5669 6.300	
6.450		16.0	480.0	425.0	48.0	5669 6.450	
6.950		16.0	510.0	460.0	48.0	5669 6.950	
7.450		16.0	545.0	490.0	48.0	5669 7.450	
7.888		16.0	575.0	520.0	48.0	5669 7.888	
7.950		16.0	575.0	525.0	48.0	5669 7.950	
8.450		16.0	610.0	555.0	48.0	5669 8.450	
8.950		16.0	645.0	590.0	48.0	5669 8.950	
9.450		16.0	675.0	625.0	48.0	5669 9.450	
9.475		16.0	680.0	625.0	48.0	5669 9.475	
9.950		20.0	710.0	655.0	50.0	5669 9.950	

d1		d2 h6		l1	l2	l3	Order no.
mm	inch	mm	mm	mm	mm	mm	
10.450		20.0	745.0	690.0	50.0	5669 10.450	
10.950		20.0	780.0	725.0	50.0	5669 10.950	
11.063		20.0	785.0	730.0	50.0	5669 11.063	
11.450		20.0	810.0	755.0	50.0	5669 11.450	
11.950		20.0	845.0	790.0	50.0	5669 11.950	
12.450		20.0	875.0	820.0	50.0	5669 12.450	
12.650		20.0	890.0	835.0	50.0	5669 12.650	
12.950		20.0	910.0	855.0	50.0	5669 12.950	
13.450		20.0	925.0	870.0	50.0	5669 13.450	
13.950		20.0	955.0	900.0	50.0	5669 13.950	
14.450		25.0	995.0	935.0	56.0	5669 14.450	
14.950		25.0	1025.0	965.0	56.0	5669 14.950	
15.450		25.0	1060.0	1000.0	56.0	5669 15.450	
15.950		25.0	1090.0	1030.0	56.0	5669 15.950	



EB 80 single-fluted gun drills

Article no. 5690



Cutting data page 439



head form G

P	M	K	N	S	H
○	○	○	●	○	○

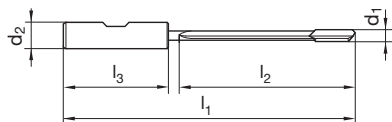

Article no. 5690

d1		d2 h6	l1	l2	l3	Order no.
mm	inch	mm	mm	mm	mm	
3.969	5/32	10.0	390.0	345.0	40.0	5690 3.970
4.950		16.0	480.0	432.0	48.0	5690 4.950
5.953	15/64	16.0	560.0	512.0	48.0	5690 5.950
6.950		16.0	650.0	602.0	48.0	5690 6.950
7.950		16.0	740.0	692.0	48.0	5690 7.950
8.950		16.0	820.0	772.0	48.0	5690 8.950

Article no. 5690

d1		d2 h6	l1	l2	l3	Order no.
mm	inch	mm	mm	mm	mm	
9.950		20.0	910.0	860.0	50.0	5690 9.950
11.950		20.0	1080.0	1030.0	50.0	5690 11.950

EB 80 single-fluted gun drills

Article no. 5023



Cutting data page 439



with recessed coolant chamber • head form G • with lateral chip breaker

P	M	K	N	S	H
●	○	●	○	○	○

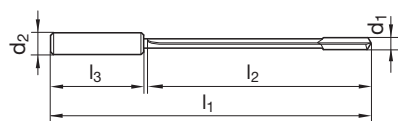

Article no. 5023

d1		d2 h6	l1	l2	l3	Order no.
mm	inch	mm	mm	mm	mm	
4.950		16.0	480.0	432.0	48.0	5023 4.950
5.953	15/64	16.0	560.0	512.0	48.0	5023 5.950
7.950		16.0	740.0	692.0	48.0	5023 7.950
9.950		20.0	910.0	860.0	50.0	5023 9.950
11.950		20.0	1080.0	1030.0	50.0	5023 11.950

Article no. 5023

d1		d2 h6	l1	l2	l3	Order no.
mm	inch	mm	mm	mm	mm	



Brazed single-fluted gun drills

Deep hole drills

EB 80 single-fluted gun drills

Article no. **5642**



Cutting data page 439



P	M	K	N	S	H
●	●	○	○	●	○

head form G

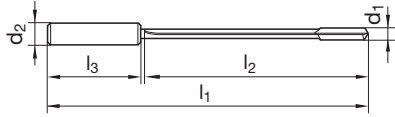

Article no. **5642**

d1	d2 h6	l1	l2	l3	Order no.
mm	mm	mm	mm	mm	
3.969	10.0	390.0	345.0	40.0	5642 3.970
4.150	12.0	405.0	355.0	45.0	5642 4.150
4.450	12.0	430.0	380.0	45.0	5642 4.450
4.950	16.0	480.0	432.0	48.0	5642 4.950
5.109	16.0	480.0	432.0	48.0	5642 5.106
5.450	16.0	520.0	470.0	48.0	5642 5.450
5.953	16.0	560.0	512.0	48.0	5642 5.950
6.300	16.0	590.0	542.0	48.0	5642 6.300
6.450	16.0	605.0	556.0	48.0	5642 6.450
6.950	16.0	650.0	602.0	48.0	5642 6.950
7.450	16.0	695.0	640.0	48.0	5642 7.450
7.888	16.0	740.0	692.0	48.0	5642 7.888
7.950	16.0	740.0	692.0	48.0	5642 7.950
8.450	16.0	780.0	725.0	48.0	5642 8.450
8.950	16.0	820.0	772.0	48.0	5642 8.950
9.450	16.0	865.0	815.0	48.0	5642 9.450
9.475	16.0	870.0	822.0	48.0	5642 9.475
9.950	20.0	910.0	860.0	50.0	5642 9.950

Article no. **5642**

d1	d2 h6	l1	l2	l3	Order no.
mm	mm	mm	mm	mm	
10.450	20.0	955.0	900.0	50.0	5642 10.450
10.950	20.0	995.0	945.0	50.0	5642 10.950
11.063	20.0	995.0	945.0	50.0	5642 11.063
11.450	20.0	1040.0	985.0	50.0	5642 11.450
11.950	20.0	1080.0	1030.0	50.0	5642 11.950
12.450	20.0	1125.0	1070.0	50.0	5642 12.450
12.650	20.0	1140.0	1090.0	50.0	5642 12.650
12.950	20.0	1170.0	1115.0	50.0	5642 12.950
13.450	20.0	1195.0	1140.0	50.0	5642 13.450
13.950	20.0	1235.0	1180.0	50.0	5642 13.950
14.450	25.0	1285.0	1225.0	56.0	5642 14.450
14.950	25.0	1325.0	1265.0	56.0	5642 14.950
15.450	25.0	1370.0	1310.0	56.0	5642 15.450
15.950	25.0	1410.0	1350.0	56.0	5642 15.950



EB 80 XXL single-fluted gun drills

Article no. 5688



Cutting data page 439



P	M	K	N	S	H
●	○	●	●	○	○

bright flute • head form G • driver for deep drilling machines

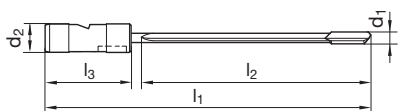

Article no. 5688

Article no. 5688

d1 mm	d2 h6 mm	l1 mm	l2 mm	l3 mm	Order no.
3.000	25.0	600.0	500.0	70.0	5688 3.000
4.000	25.0	600.0	500.0	70.0	5688 4.000
5.000	25.0	600.0	500.0	70.0	5688 5.000
6.000	25.0	600.0	500.0	70.0	5688 6.000
7.000	25.0	600.0	500.0	70.0	5688 7.000
8.000	25.0	600.0	500.0	70.0	5688 8.000
9.000	25.0	600.0	500.0	70.0	5688 9.000
10.000	25.0	600.0	500.0	70.0	5688 10.000
11.000	25.0	600.0	500.0	70.0	5688 11.000
11.500	25.0	600.0	500.0	70.0	5688 11.500
12.000	25.0	600.0	500.0	70.0	5688 12.000
13.000	25.0	600.0	500.0	70.0	5688 13.000

d1 mm	d2 h6 mm	l1 mm	l2 mm	l3 mm	Order no.
14.000	25.0	600.0	500.0	70.0	5688 14.000
15.000	25.0	600.0	500.0	70.0	5688 15.000
16.000	25.0	600.0	500.0	70.0	5688 16.000
17.000	25.0	600.0	500.0	70.0	5688 17.000
18.000	25.0	600.0	500.0	70.0	5688 18.000
19.000	25.0	600.0	500.0	70.0	5688 19.000
20.000	25.0	600.0	500.0	70.0	5688 20.000
21.000	25.0	600.0	500.0	70.0	5688 21.000
22.000	25.0	600.0	500.0	70.0	5688 22.000
23.000	25.0	600.0	500.0	70.0	5688 23.000
24.000	25.0	600.0	500.0	70.0	5688 24.000
25.000	25.0	600.0	500.0	70.0	5688 25.000

EB 80 XXL single-fluted gun drills

Article no. 5691



Cutting data page 439



P	M	K	N	S	H
●	○	●	●	○	○

bright flute • head form G • driver for deep drilling machines

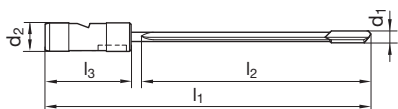

Article no. 5691

Article no. 5691

d1 mm	d2 h6 mm	l1 mm	l2 mm	l3 mm	Order no.
3.000	25.0	800.0	700.0	70.0	5691 3.000
4.000	25.0	800.0	700.0	70.0	5691 4.000
5.000	25.0	800.0	700.0	70.0	5691 5.000
6.000	25.0	800.0	700.0	70.0	5691 6.000
7.000	25.0	800.0	700.0	70.0	5691 7.000
8.000	25.0	800.0	700.0	70.0	5691 8.000
9.000	25.0	800.0	700.0	70.0	5691 9.000
10.000	25.0	800.0	700.0	70.0	5691 10.000
11.000	25.0	800.0	700.0	70.0	5691 11.000
11.500	25.0	800.0	700.0	70.0	5691 11.500
12.000	25.0	800.0	700.0	70.0	5691 12.000
13.000	25.0	800.0	700.0	70.0	5691 13.000

d1 mm	d2 h6 mm	l1 mm	l2 mm	l3 mm	Order no.
14.000	25.0	800.0	700.0	70.0	5691 14.000
15.000	25.0	800.0	700.0	70.0	5691 15.000
16.000	25.0	800.0	700.0	70.0	5691 16.000
17.000	25.0	800.0	700.0	70.0	5691 17.000
18.000	25.0	800.0	700.0	70.0	5691 18.000
19.000	25.0	800.0	700.0	70.0	5691 19.000
20.000	25.0	800.0	700.0	70.0	5691 20.000
21.000	25.0	800.0	700.0	70.0	5691 21.000
22.000	25.0	800.0	700.0	70.0	5691 22.000
23.000	25.0	800.0	700.0	70.0	5691 23.000
24.000	25.0	800.0	700.0	70.0	5691 24.000
25.000	25.0	800.0	700.0	70.0	5691 25.000



Brazed single-fluted gun drills

Deep hole drills

EB 80 XXL single-fluted gun drills

Article no. **5164**



Cutting data page 439



bright flute • head form G • driver for deep drilling machines

P	M	K	N	S	H
●	○	●	●	○	○

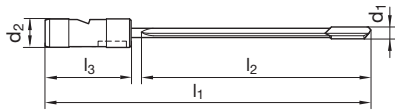

Article no. **5164**

Article no. **5164**

d1 mm	d2 h6 mm	l1 mm	l2 mm	l3 mm	Order no.
3.000	25.0	1000.0	900.0	70.0	5164 3.000
4.000	25.0	1000.0	900.0	70.0	5164 4.000
5.000	25.0	1000.0	900.0	70.0	5164 5.000
6.000	25.0	1000.0	900.0	70.0	5164 6.000
7.000	25.0	1000.0	900.0	70.0	5164 7.000
8.000	25.0	1000.0	900.0	70.0	5164 8.000
9.000	25.0	1000.0	900.0	70.0	5164 9.000
10.000	25.0	1000.0	900.0	70.0	5164 10.000
11.000	25.0	1000.0	900.0	70.0	5164 11.000
11.500	25.0	1000.0	900.0	70.0	5164 11.500
12.000	25.0	1000.0	900.0	70.0	5164 12.000
13.000	25.0	1000.0	900.0	70.0	5164 13.000

d1 mm	d2 h6 mm	l1 mm	l2 mm	l3 mm	Order no.
14.000	25.0	1000.0	900.0	70.0	5164 14.000
15.000	25.0	1000.0	900.0	70.0	5164 15.000
16.000	25.0	1000.0	900.0	70.0	5164 16.000
17.000	25.0	1000.0	900.0	70.0	5164 17.000
18.000	25.0	1000.0	900.0	70.0	5164 18.000
19.000	25.0	1000.0	900.0	70.0	5164 19.000
20.000	25.0	1000.0	900.0	70.0	5164 20.000
21.000	25.0	1000.0	900.0	70.0	5164 21.000
22.000	25.0	1000.0	900.0	70.0	5164 22.000
23.000	25.0	1000.0	900.0	70.0	5164 23.000
24.000	25.0	1000.0	900.0	70.0	5164 24.000
25.000	25.0	1000.0	900.0	70.0	5164 25.000

EB 80 XXL single-fluted gun drills

Article no. **5692**



Cutting data page 439



bright flute • head form G • driver for deep drilling machines

P	M	K	N	S	H
●	○	●	●	○	○

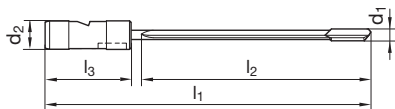

Article no. **5692**

Article no. **5692**

d1 mm	d2 h6 mm	l1 mm	l2 mm	l3 mm	Order no.
3.000	25.0	1200.0	1100.0	70.0	5692 3.000
4.000	25.0	1200.0	1100.0	70.0	5692 4.000
5.000	25.0	1200.0	1100.0	70.0	5692 5.000
6.000	25.0	1200.0	1100.0	70.0	5692 6.000
7.000	25.0	1200.0	1100.0	70.0	5692 7.000
8.000	25.0	1200.0	1100.0	70.0	5692 8.000
9.000	25.0	1200.0	1100.0	70.0	5692 9.000
10.000	25.0	1200.0	1100.0	70.0	5692 10.000
11.000	25.0	1200.0	1100.0	70.0	5692 11.000
11.500	25.0	1200.0	1100.0	70.0	5692 11.500
12.000	25.0	1200.0	1100.0	70.0	5692 12.000
13.000	25.0	1200.0	1100.0	70.0	5692 13.000

d1 mm	d2 h6 mm	l1 mm	l2 mm	l3 mm	Order no.
14.000	25.0	1200.0	1100.0	70.0	5692 14.000
15.000	25.0	1200.0	1100.0	70.0	5692 15.000
16.000	25.0	1200.0	1100.0	70.0	5692 16.000
17.000	25.0	1200.0	1100.0	70.0	5692 17.000
18.000	25.0	1200.0	1100.0	70.0	5692 18.000
19.000	25.0	1200.0	1100.0	70.0	5692 19.000
20.000	25.0	1200.0	1100.0	70.0	5692 20.000
21.000	25.0	1200.0	1100.0	70.0	5692 21.000
22.000	25.0	1200.0	1100.0	70.0	5692 22.000
23.000	25.0	1200.0	1100.0	70.0	5692 23.000
24.000	25.0	1200.0	1100.0	70.0	5692 24.000
25.000	25.0	1200.0	1100.0	70.0	5692 25.000



EB 80 XXL single-fluted gun drills

Article no. 5681



Cutting data page 439



bright flute • head form G • driver for deep drilling machines

P	M	K	N	S	H
●	○	●	●	○	○

Deep hole drills

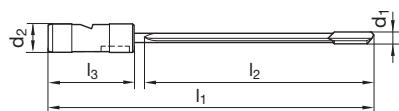

Article no. 5681

d1 mm	d2 h6 mm	l1 mm	l2 mm	l3 mm	Order no.
4.000	25.0	1400.0	1300.0	70.0	5681 4.000
5.000	25.0	1400.0	1300.0	70.0	5681 5.000
6.000	25.0	1400.0	1300.0	70.0	5681 6.000
7.000	25.0	1400.0	1300.0	70.0	5681 7.000
8.000	25.0	1400.0	1300.0	70.0	5681 8.000
9.000	25.0	1400.0	1300.0	70.0	5681 9.000
10.000	25.0	1400.0	1300.0	70.0	5681 10.000
11.000	25.0	1400.0	1300.0	70.0	5681 11.000
11.500	25.0	1400.0	1300.0	70.0	5681 11.500
12.000	25.0	1400.0	1300.0	70.0	5681 12.000
13.000	25.0	1400.0	1300.0	70.0	5681 13.000
14.000	25.0	1400.0	1300.0	70.0	5681 14.000

Article no. 5681

d1 mm	d2 h6 mm	l1 mm	l2 mm	l3 mm	Order no.
15.000	25.0	1400.0	1300.0	70.0	5681 15.000
16.000	25.0	1400.0	1300.0	70.0	5681 16.000
17.000	25.0	1400.0	1300.0	70.0	5681 17.000
18.000	25.0	1400.0	1300.0	70.0	5681 18.000
19.000	25.0	1400.0	1300.0	70.0	5681 19.000
20.000	25.0	1400.0	1300.0	70.0	5681 20.000
21.000	25.0	1400.0	1300.0	70.0	5681 21.000
22.000	25.0	1400.0	1300.0	70.0	5681 22.000
23.000	25.0	1400.0	1300.0	70.0	5681 23.000
24.000	25.0	1400.0	1300.0	70.0	5681 24.000
25.000	25.0	1400.0	1300.0	70.0	5681 25.000

EB 80 XXL single-fluted gun drills

Article no. 5693



Cutting data page 439



bright flute • head form G • driver for deep drilling machines

P	M	K	N	S	H
●	○	●	●	○	○

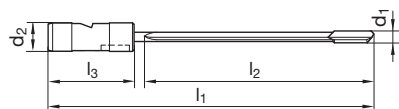

Article no. 5693

d1 mm	d2 h6 mm	l1 mm	l2 mm	l3 mm	Order no.
4.000	25.0	1600.0	1500.0	70.0	5693 4.000
5.000	25.0	1600.0	1500.0	70.0	5693 5.000
5.500	25.0	1600.0	1500.0	70.0	5693 5.500
6.000	25.0	1600.0	1500.0	70.0	5693 6.000
6.500	25.0	1600.0	1500.0	70.0	5693 6.500
7.000	25.0	1600.0	1500.0	70.0	5693 7.000
7.500	25.0	1600.0	1500.0	70.0	5693 7.500
8.000	25.0	1600.0	1500.0	70.0	5693 8.000
9.000	25.0	1600.0	1500.0	70.0	5693 9.000
9.500	25.0	1600.0	1500.0	70.0	5693 9.500
10.000	25.0	1600.0	1500.0	70.0	5693 10.000
11.000	25.0	1600.0	1500.0	70.0	5693 11.000
11.500	25.0	1600.0	1500.0	70.0	5693 11.500
12.000	25.0	1600.0	1500.0	70.0	5693 12.000
13.000	25.0	1600.0	1500.0	70.0	5693 13.000
14.000	25.0	1600.0	1500.0	70.0	5693 14.000
15.000	25.0	1600.0	1500.0	70.0	5693 15.000
16.000	25.0	1600.0	1500.0	70.0	5693 16.000

Article no. 5693

d1 mm	d2 h6 mm	l1 mm	l2 mm	l3 mm	Order no.
17.000	25.0	1600.0	1500.0	70.0	5693 17.000
18.000	25.0	1600.0	1500.0	70.0	5693 18.000
19.000	25.0	1600.0	1500.0	70.0	5693 19.000
20.000	25.0	1600.0	1500.0	70.0	5693 20.000
21.000	25.0	1600.0	1500.0	70.0	5693 21.000
22.000	25.0	1600.0	1500.0	70.0	5693 22.000
23.000	25.0	1600.0	1500.0	70.0	5693 23.000
24.000	25.0	1600.0	1500.0	70.0	5693 24.000
25.000	25.0	1600.0	1500.0	70.0	5693 25.000



Brazed single-fluted gun drills

Deep hole drills

EB 80 XXL single-fluted gun drills

Article no. **5682**



bright flute • head form G • driver for deep drilling machines

Cutting data page 439

P	M	K	N	S	H
●	○	●	●	○	○

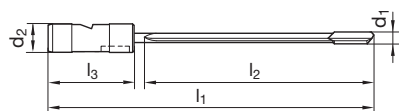

Article no. **5682**

d1 mm	d2 h6 mm	l1 mm	l2 mm	l3 mm	Order no.
4.000	25.0	1800.0	1700.0	70.0	5682 4.000
5.000	25.0	1800.0	1700.0	70.0	5682 5.000
6.000	25.0	1800.0	1700.0	70.0	5682 6.000
7.000	25.0	1800.0	1700.0	70.0	5682 7.000
8.000	25.0	1800.0	1700.0	70.0	5682 8.000
9.000	25.0	1800.0	1700.0	70.0	5682 9.000
10.000	25.0	1800.0	1700.0	70.0	5682 10.000
11.000	25.0	1800.0	1700.0	70.0	5682 11.000
11.500	25.0	1800.0	1700.0	70.0	5682 11.500
12.000	25.0	1800.0	1700.0	70.0	5682 12.000
13.000	25.0	1800.0	1700.0	70.0	5682 13.000
14.000	25.0	1800.0	1700.0	70.0	5682 14.000
15.000	25.0	1800.0	1700.0	70.0	5682 15.000
16.000	25.0	1800.0	1700.0	70.0	5682 16.000
17.000	25.0	1800.0	1700.0	70.0	5682 17.000
18.000	25.0	1800.0	1700.0	70.0	5682 18.000
19.000	25.0	1800.0	1700.0	70.0	5682 19.000
20.000	25.0	1800.0	1700.0	70.0	5682 20.000

Article no. **5682**

d1 mm	d2 h6 mm	l1 mm	l2 mm	l3 mm	Order no.
21.000	25.0	1800.0	1700.0	70.0	5682 21.000
22.000	25.0	1800.0	1700.0	70.0	5682 22.000
23.000	25.0	1800.0	1700.0	70.0	5682 23.000
24.000	25.0	1800.0	1700.0	70.0	5682 24.000
25.000	25.0	1800.0	1700.0	70.0	5682 25.000
26.000	25.0	1800.0	1695.0	75.0	5682 26.000
27.000	25.0	1800.0	1695.0	75.0	5682 27.000
28.000	25.0	1800.0	1695.0	75.0	5682 28.000
29.000	25.0	1800.0	1695.0	75.0	5682 29.000
30.000	25.0	1800.0	1695.0	75.0	5682 30.000
31.000	25.0	1800.0	1695.0	75.0	5682 31.000
32.000	25.0	1800.0	1695.0	75.0	5682 32.000

EB 80 XXL single-fluted gun drills

Article no. **5694**



bright flute • head form G • driver for deep drilling machines

Cutting data page 439

P	M	K	N	S	H
●	○	●	●	○	○

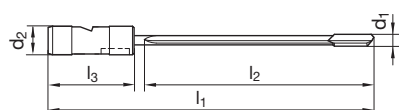

Article no. **5694**

d1 mm	d2 h6 mm	l1 mm	l2 mm	l3 mm	Order no.
4.000	25.0	2000.0	1900.0	70.0	5694 4.000
5.000	25.0	2000.0	1900.0	70.0	5694 5.000
6.000	25.0	2000.0	1900.0	70.0	5694 6.000
7.000	25.0	2000.0	1900.0	70.0	5694 7.000
8.000	25.0	2000.0	1900.0	70.0	5694 8.000
9.000	25.0	2000.0	1900.0	70.0	5694 9.000
10.000	25.0	2000.0	1900.0	70.0	5694 10.000
11.000	25.0	2000.0	1900.0	70.0	5694 11.000
11.500	25.0	2000.0	1900.0	70.0	5694 11.500
12.000	25.0	2000.0	1900.0	70.0	5694 12.000
13.000	25.0	2000.0	1900.0	70.0	5694 13.000
14.000	25.0	2000.0	1900.0	70.0	5694 14.000
15.000	25.0	2000.0	1900.0	70.0	5694 15.000
16.000	25.0	2000.0	1900.0	70.0	5694 16.000
17.000	25.0	2000.0	1900.0	70.0	5694 17.000
18.000	25.0	2000.0	1900.0	70.0	5694 18.000
19.000	25.0	2000.0	1900.0	70.0	5694 19.000
20.000	25.0	2000.0	1900.0	70.0	5694 20.000

Article no. **5694**

d1 mm	d2 h6 mm	l1 mm	l2 mm	l3 mm	Order no.
21.000	25.0	2000.0	1900.0	70.0	5694 21.000
22.000	25.0	2000.0	1900.0	70.0	5694 22.000
23.000	25.0	2000.0	1900.0	70.0	5694 23.000
24.000	25.0	2000.0	1900.0	70.0	5694 24.000
25.000	25.0	2000.0	1900.0	70.0	5694 25.000
26.000	25.0	2000.0	1895.0	75.0	5694 26.000
27.000	25.0	2000.0	1895.0	75.0	5694 27.000
28.000	25.0	2000.0	1895.0	75.0	5694 28.000
29.000	25.0	2000.0	1895.0	75.0	5694 29.000
30.000	25.0	2000.0	1895.0	75.0	5694 30.000
31.000	25.0	2000.0	1895.0	75.0	5694 31.000
32.000	25.0	2000.0	1895.0	75.0	5694 32.000



EB 800 single-fluted gun drills with interchangeable inserts

Article no. 5644



Cutting data page 440



with interchangeable inserts • with interchangeable guide pads • with screws • for universal application • order torque wrench set art. no. 4966 separately • order screwdriver art. no. 1612 separately

Deep hole drills

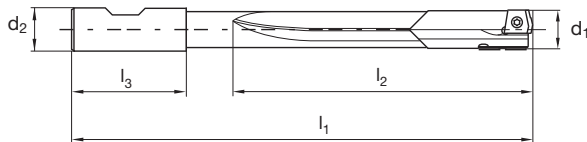

Article no. 5644





























d1 mm	inch	Ø-range	d2 mm	l1 mm	l2 mm	l3 mm	Order no.
12.000		12,000-12,499	20.0	446.0	384.0	50.0	5644 12.000
12.100		12,000-12,499	20.0	446.0	384.0	50.0	5644 12.100
12.200		12,000-12,499	20.0	446.0	384.0	50.0	5644 12.200
12.300	31/64	12,000-12,499	20.0	446.0	384.0	50.0	5644 12.300
12.400		12,000-12,499	20.0	446.0	384.0	50.0	5644 12.400
12.500		12,500-12,999	20.0	468.0	406.0	50.0	5644 12.500
12.600		12,500-12,999	20.0	468.0	406.0	50.0	5644 12.600
12.700	1/2	12,500-12,999	20.0	468.0	406.0	50.0	5644 12.700
12.800		12,500-12,999	20.0	468.0	406.0	50.0	5644 12.800
12.900		12,500-12,999	20.0	468.0	406.0	50.0	5644 12.900
14.000		14,000-14,499	20.0	510.0	448.0	50.0	5644 14.000
14.100		14,000-14,499	20.0	510.0	448.0	50.0	5644 14.100
14.200		14,000-14,499	20.0	510.0	448.0	50.0	5644 14.200
14.300		14,000-14,499	20.0	510.0	448.0	50.0	5644 14.300
14.400		14,000-14,499	20.0	510.0	448.0	50.0	5644 14.400
15.000		15,000-15,499	25.0	548.0	480.0	56.0	5644 15.000
15.100		15,000-15,499	25.0	548.0	480.0	56.0	5644 15.100
15.200		15,000-15,499	25.0	548.0	480.0	56.0	5644 15.200
15.300		15,000-15,499	25.0	548.0	480.0	56.0	5644 15.300
15.400		15,000-15,499	25.0	548.0	480.0	56.0	5644 15.400
15.500		15,500-15,999	25.0	580.0	515.0	56.0	5644 15.500
15.600		15,500-15,999	25.0	580.0	515.0	56.0	5644 15.600
15.700		15,500-15,999	25.0	580.0	515.0	56.0	5644 15.700
15.800		15,500-15,999	25.0	580.0	515.0	56.0	5644 15.800
15.900		15,500-15,999	25.0	580.0	515.0	56.0	5644 15.900
16.000		16,000-16,499	25.0	580.0	512.0	56.0	5644 16.000
16.100		16,000-16,499	25.0	580.0	512.0	56.0	5644 16.100
16.200		16,000-16,499	25.0	580.0	512.0	56.0	5644 16.200
16.300		16,000-16,499	25.0	580.0	512.0	56.0	5644 16.300
16.400		16,000-16,499	25.0	580.0	512.0	56.0	5644 16.400
18.000		18,000-18,499	25.0	644.0	576.0	56.0	5644 18.000
18.100		18,000-18,499	25.0	644.0	576.0	56.0	5644 18.100
18.200		18,000-18,499	25.0	644.0	576.0	56.0	5644 18.200
18.300		18,000-18,499	25.0	644.0	576.0	56.0	5644 18.300
18.400		18,000-18,499	25.0	644.0	576.0	56.0	5644 18.400
19.000		19,000-19,499	25.0	695.0	635.0	56.0	5644 19.000
19.050	3/4	19,000-19,499	25.0	695.0	635.0	56.0	5644 19.050
19.100		19,000-19,499	25.0	695.0	635.0	56.0	5644 19.100
19.200		19,000-19,499	25.0	695.0	635.0	56.0	5644 19.200
19.300		19,000-19,499	25.0	695.0	635.0	56.0	5644 19.300
19.400		19,000-19,499	25.0	695.0	635.0	56.0	5644 19.400
20.000		20,000-20,499	32.0	712.0	640.0	60.0	5644 20.000
20.100		20,000-20,499	32.0	712.0	640.0	60.0	5644 20.100
20.200		20,000-20,499	32.0	712.0	640.0	60.0	5644 20.200
20.300		20,000-20,499	32.0	712.0	640.0	60.0	5644 20.300
20.400		20,000-20,499	32.0	712.0	640.0	60.0	5644 20.400
24.000		24,000-24,499	32.0	840.0	768.0	60.0	5644 24.000
24.100		24,000-24,499	32.0	840.0	768.0	60.0	5644 24.100
24.200		24,000-24,499	32.0	840.0	768.0	60.0	5644 24.200
24.300		24,000-24,499	32.0	840.0	768.0	60.0	5644 24.300
24.400		24,000-24,499	32.0	840.0	768.0	60.0	5644 24.400
25.000	63/64	25,000-25,499	32.0	875.0	810.0	60.0	5644 25.000
25.100		25,000-25,499	32.0	875.0	810.0	60.0	5644 25.100
25.200		25,000-25,499	32.0	875.0	810.0	60.0	5644 25.200
25.300		25,000-25,499	32.0	875.0	810.0	60.0	5644 25.300
25.400	1	25,000-25,499	32.0	875.0	810.0	60.0	5644 25.400
31.500		31,500-31,999	40.0	1080.0	1005.0	70.0	5644 31.500
31.600		31,500-31,999	40.0	1080.0	1005.0	70.0	5644 31.600
31.700		31,500-31,999	40.0	1080.0	1005.0	70.0	5644 31.700
31.800		31,500-31,999	40.0	1080.0	1005.0	70.0	5644 31.800
31.900		31,500-31,999	40.0	1080.0	1005.0	70.0	5644 31.900











Modular single-fluted gun drills

Ø 12.000–52.000 mm, TOTAL LENGTH MAX. 3,600 mm

Deep hole drills

Holder size	Diameter range	Body/holder	Inserts				Screw	Screw driver
			Outer inserts					
								
TiN coated	Signum coated	FIRE coated	TiAlN nanoA coated					
0.	Ø12.000 - Ø12.499	Standard range art. no. 5644 from diameter 12.000 mm up to 31.900 mm in preferred sizes complete with TiN inserts and TiN guide pads Alternative: Body/holder especially to customer re-quirements. Total length up to 3,600 mm					Art. no. 4071 2.502 T8 M2.5x5.2	Art. no. 1612 8.001
	Ø12.500 - Ø12.999							
	Ø13.000 - Ø13.499							
	Ø13.500 - Ø13.999							
	Ø14.000 - Ø14.499							
1.	Ø14.500 - Ø14.999						Art. no. 4071 3.002 T9 M3x6.4	Art. no. 1612 9.001
	Ø15.000 - Ø15.499							
	Ø15.500 - Ø15.999							
	Ø16.000 - Ø16.499							
	Ø16.500 - Ø16.999							
2.	Ø17.000 - Ø17.499						Art. no. 4071 4.001 T15 M4x7.7	Art. no. 1612 15.001
	Ø17.500 - Ø17.999							
	Ø18.000 - Ø18.499							
	Ø18.500 - Ø18.999							
	Ø19.000 - Ø19.499							
3.	Ø19.500 - Ø19.999						Art. no. 4071 4.002 T15 M4x10.6	Art. no. 1612 15.001
	Ø20.000 - Ø20.499							
	Ø20.500 - Ø20.999							
	Ø21.000 - Ø21.499							
	Ø21.500 - Ø21.999							
4.	Ø22.000 - Ø22.499						Art. no. 4071 5.002 T20 M5x14.2	Art. no. 1612 20.001
	Ø22.500 - Ø22.999							
	Ø23.000 - Ø23.499							
	Ø23.500 - Ø23.999							
	Ø24.000 - Ø24.499							
5.	Ø24.500 - Ø24.999					Art. no. 4071 4.001 T15 M4x7.7	Art. no. 1612 15.001	
	Ø25.000 - Ø25.499							
	Ø25.500 - Ø25.999							
	Ø26.000 - Ø26.499							
	Ø26.500 - Ø26.999							
6.	Ø27.000 - Ø27.499					Art. no. 4071 4.002 T15 M4x10.6	Art. no. 1612 15.001	
	Ø27.500 - Ø27.999							
	Ø28.000 - Ø28.499							
	Ø28.500 - Ø28.999							
	Ø29.000 - Ø29.499							
7.	Ø29.500 - Ø29.999					Art. no. 4071 4.002 T15 M4x10.6	Art. no. 1612 15.001	
	Ø30.000 - Ø30.499							
	Ø30.500 - Ø30.999							
	Ø31.000 - Ø31.499							
	Ø31.500 - Ø31.999							
8.	Ø32.000 - Ø32.499					Art. no. 4071 4.002 T15 M4x10.6	Art. no. 1612 15.001	
	Ø32.500 - Ø32.999							
	Ø33.000 - Ø33.499							
	Ø33.500 - Ø33.999							
	Ø34.000 - Ø34.499							
9.	Ø34.500 - Ø34.999					Art. no. 4071 4.002 T15 M4x10.6	Art. no. 1612 15.001	
	Ø35.000 - Ø35.499							
	Ø35.500 - Ø35.999							
	Ø36.000 - Ø36.499							
	Ø36.500 - Ø36.999							
0.	Ø37.000 - Ø37.499					Art. no. 4071 4.002 T15 M4x10.6	Art. no. 1612 15.001	
	Ø37.500 - Ø37.999							
	Ø38.000 - Ø38.499							
	Ø38.500 - Ø38.999							
	Ø39.000 - Ø39.499							
1.	Ø39.500 - Ø40.000					Art. no. 4071 4.002 T15 M4x10.6	Art. no. 1612 15.001	
	Ø40.001 - Ø40.499							
	Ø40.500 - Ø40.999							
	Ø41.000 - Ø41.499							
	Ø41.500 - Ø41.999							
2.	Ø42.000 - Ø42.499					Art. no. 4071 4.002 T15 M4x10.6	Art. no. 1612 15.001	
	Ø42.500 - Ø42.999							
	Ø43.000 - Ø43.499							
	Ø43.500 - Ø43.999							
	Ø44.000 - Ø44.499							
3.	Ø44.500 - Ø44.999					Art. no. 4071 4.002 T15 M4x10.6	Art. no. 1612 15.001	
	Ø45.000 - Ø45.499							
	Ø45.500 - Ø45.999							
	Ø46.000 - Ø46.499							
	Ø46.500 - Ø46.999							
4.	Ø47.000 - Ø47.499					Art. no. 4071 4.002 T15 M4x10.6	Art. no. 1612 15.001	
	Ø47.500 - Ø47.999							
	Ø48.000 - Ø48.499							
	Ø48.500 - Ø48.999							
	Ø49.000 - Ø49.499							
5.	Ø49.500 - Ø49.999					Art. no. 4071 4.002 T15 M4x10.6	Art. no. 1612 15.001	
	Ø50.000 - Ø50.499							
	Ø50.500 - Ø50.999							
	Ø51.000 - Ø51.499							
	Ø51.500 - Ø52.000							



Inserts			Guide pads																																																					
Inner inserts	Screw	Screw driver	Guide pads				Screw	Screw driver																																																
																																																								
			TiN coated	Signum coated	FIRE coated	TiAlN nanoA coated																																																		
			<table border="1"> <tr><td>P</td><td>•</td></tr> <tr><td>M</td><td>○</td></tr> <tr><td>K</td><td>○</td></tr> <tr><td>N</td><td>•</td></tr> <tr><td>S</td><td>○</td></tr> <tr><td>H</td><td>○</td></tr> </table>	P	•	M	○	K	○	N	•	S	○	H	○	<table border="1"> <tr><td>P</td><td>•</td></tr> <tr><td>M</td><td>•</td></tr> <tr><td>K</td><td>•</td></tr> <tr><td>N</td><td>○</td></tr> <tr><td>S</td><td>•</td></tr> <tr><td>H</td><td>○</td></tr> </table>	P	•	M	•	K	•	N	○	S	•	H	○	<table border="1"> <tr><td>P</td><td>•</td></tr> <tr><td>M</td><td>○</td></tr> <tr><td>K</td><td>•</td></tr> <tr><td>N</td><td>○</td></tr> <tr><td>S</td><td>○</td></tr> <tr><td>H</td><td>○</td></tr> </table>	P	•	M	○	K	•	N	○	S	○	H	○	<table border="1"> <tr><td>P</td><td>○</td></tr> <tr><td>M</td><td>•</td></tr> <tr><td>K</td><td>○</td></tr> <tr><td>N</td><td>○</td></tr> <tr><td>S</td><td>•</td></tr> <tr><td>H</td><td>○</td></tr> </table>	P	○	M	•	K	○	N	○	S	•	H	○	Art. no. 4071 1.601 T5 M1.6x4.4	Art. no. 1612 5.001
P	•																																																							
M	○																																																							
K	○																																																							
N	•																																																							
S	○																																																							
H	○																																																							
P	•																																																							
M	•																																																							
K	•																																																							
N	○																																																							
S	•																																																							
H	○																																																							
P	•																																																							
M	○																																																							
K	•																																																							
N	○																																																							
S	○																																																							
H	○																																																							
P	○																																																							
M	•																																																							
K	○																																																							
N	○																																																							
S	•																																																							
H	○																																																							
							Art. no. 4071 2.203 T7 / M2.2x4.6	Art. no. 1612 7.001																																																
							Art. no. 4071 2.202 T7 / M2.2x5.6																																																	
							Art. no. 4071 2.502 T8 M2.5x5.2	Art. no. 1612 8.001																																																
							Art. no. 4071 2.501 T8 M2.5x6.4																																																	
			Art. no. 5030 + nom.-Ø = order no.	Art. no. 5703 + nom.-Ø = order no.	Art. no. 5705 + nom.-Ø = order no.	Art. no. 5707 + nom.-Ø = order no.																																																		
TiN Art. no. 5665 1.000 Signum Art. no. 5667 1.000 FIRE Art. no. 5666 1.000 TiAlN nanoA Art. no. 5668 1.000	Art. no. 4071 4.501 T15 M4.5x11.8	Art. no. 1612 15.001					Art. no. 4071 3.003 T9 M3x8	Art. no. 1612 9.001																																																



TIGHTENING TORQUE-GUIDE VALUES

Outer insert

Size	Diameter in mm	ISO metric thread in mm	Torx size	Tightening torque in Nm
0.	12.000-15.999	M2.5 x 5.2	T8	1.0
1.	16.000-19.999	M3.0 x 6.4	T9	1.4
2.	20.000-25.999	M4.0 x 7.7	T15	2.5
3.	26.000-29.999	M4.0 x 10.6	T15	2.5
4.	30.000-33.999	M4.0 x 10.6	T15	2.5
5.	34.000-37.999	M5.0 x 14.2	T20	5.0
6.	38.000-40.000	M5.0 x 14.2	T20	5.0
7.	40.001-43.999	M4.0 x 7.7	T15	2.5
8.	44.000-47.999	M4.0 x 10.6	T15	2.5
9.	48.000-52.000	M4.0 x 10.6	T15	2.5

Inner insert

Size	Diameter in mm	ISO metric thread in mm	Torx size	Tightening torque in Nm
7.-9.	40.001-52.000	M4.5 x 11.8	T15	3.0

Guide pads

Size	Diameter in mm	ISO metric thread in mm	Torx size	Tightening torque in Nm
0.	12.000-15.999	M1.6 x 4.4	T5	0.4
1.	16.000-17.999	M2.2 x 4.6	T7	0.6
1.	18.000-19.999	M2.2 x 5.6	T7	0.6
2.	20.000-22.499	M2.5 x 5.2	T8	1.0
2.	22.500-25.999	M2.5 x 6.4	T8	1.0
3.	26.000-29.999	M2.5 x 6.4	T8	1.0
4.-9.	30.000-52.000	M3.0 x 8.0	T9	1.4

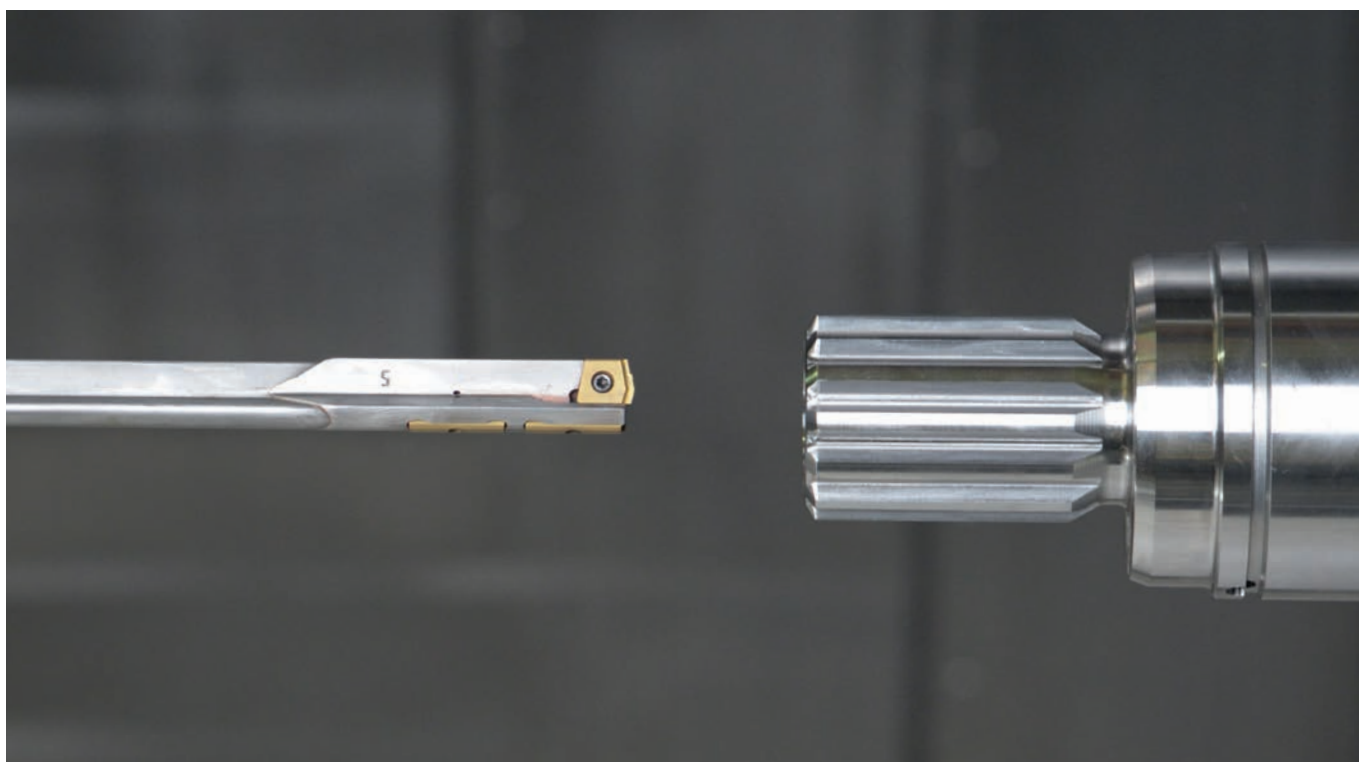



Outer inserts for single-fluted gun drills EB 800

Article no. 5029



Cutting data page 440

P	M	K	N	S	H
●	○	○	●	○	

interchangeable insert with 1 cutting edge • observe tightening torques • order torque wrench set art. no. 4966 separately

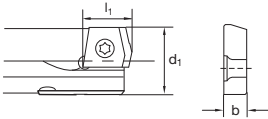

Deep hole drills

Article no. 5029				Article no. 5029			
d1 mm	b mm	l1 mm	Order no.	d1 mm	b mm	l1 mm	Order no.
12.000	2.80	10.00	5029 12.000	18.600	3.00	12.00	5029 18.600
12.100	2.80	10.00	5029 12.100	18.700	3.00	12.00	5029 18.700
12.200	2.80	10.00	5029 12.200	18.800	3.00	12.00	5029 18.800
12.300	2.80	10.00	5029 12.300	18.900	3.00	12.00	5029 18.900
12.400	2.80	10.00	5029 12.400	19.000	3.00	12.00	5029 19.000
12.500	2.80	10.00	5029 12.500	19.050	3.00	12.00	5029 19.050
12.600	2.80	10.00	5029 12.600	19.100	3.00	12.00	5029 19.100
12.700	2.80	10.00	5029 12.700	19.200	3.00	12.00	5029 19.200
12.800	2.80	10.00	5029 12.800	19.300	3.00	12.00	5029 19.300
12.900	2.80	10.00	5029 12.900	19.400	3.00	12.00	5029 19.400
13.000	2.80	10.00	5029 13.000	19.500	3.00	12.00	5029 19.500
13.100	2.80	10.00	5029 13.100	19.600	3.00	12.00	5029 19.600
13.200	2.80	10.00	5029 13.200	19.700	3.00	12.00	5029 19.700
13.300	2.80	10.00	5029 13.300	19.800	3.00	12.00	5029 19.800
13.400	2.80	10.00	5029 13.400	19.900	3.00	12.00	5029 19.900
13.500	2.80	10.00	5029 13.500	20.000	4.00	15.00	5029 20.000
13.600	2.80	10.00	5029 13.600	20.100	4.00	15.00	5029 20.100
13.700	2.80	10.00	5029 13.700	20.200	4.00	15.00	5029 20.200
13.800	2.80	10.00	5029 13.800	20.300	4.00	15.00	5029 20.300
13.900	2.80	10.00	5029 13.900	20.400	4.00	15.00	5029 20.400
14.000	2.80	10.00	5029 14.000	20.500	4.00	15.00	5029 20.500
14.100	2.80	10.00	5029 14.100	20.600	4.00	15.00	5029 20.600
14.200	2.80	10.00	5029 14.200	20.700	4.00	15.00	5029 20.700
14.300	2.80	10.00	5029 14.300	20.800	4.00	15.00	5029 20.800
14.400	2.80	10.00	5029 14.400	20.900	4.00	15.00	5029 20.900
14.500	2.80	10.00	5029 14.500	21.000	4.00	15.00	5029 21.000
14.600	2.80	10.00	5029 14.600	21.100	4.00	15.00	5029 21.100
14.700	2.80	10.00	5029 14.700	21.200	4.00	15.00	5029 21.200
14.800	2.80	10.00	5029 14.800	21.300	4.00	15.00	5029 21.300
14.900	2.80	10.00	5029 14.900	21.400	4.00	15.00	5029 21.400
15.000	2.80	10.00	5029 15.000	21.500	4.00	15.00	5029 21.500
15.100	2.80	10.00	5029 15.100	21.600	4.00	15.00	5029 21.600
15.200	2.80	10.00	5029 15.200	21.700	4.00	15.00	5029 21.700
15.300	2.80	10.00	5029 15.300	21.800	4.00	15.00	5029 21.800
15.400	2.80	10.00	5029 15.400	21.900	4.00	15.00	5029 21.900
15.500	2.80	10.00	5029 15.500	22.000	4.00	15.00	5029 22.000
15.600	2.80	10.00	5029 15.600	22.100	4.00	15.00	5029 22.100
15.700	2.80	10.00	5029 15.700	22.200	4.00	15.00	5029 22.200
15.800	2.80	10.00	5029 15.800	22.300	4.00	15.00	5029 22.300
15.900	2.80	10.00	5029 15.900	22.400	4.00	15.00	5029 22.400
16.000	3.00	12.00	5029 16.000	22.500	4.00	15.00	5029 22.500
16.100	3.00	12.00	5029 16.100	22.600	4.00	15.00	5029 22.600
16.200	3.00	12.00	5029 16.200	22.700	4.00	15.00	5029 22.700
16.300	3.00	12.00	5029 16.300	22.800	4.00	15.00	5029 22.800
16.400	3.00	12.00	5029 16.400	22.900	4.00	15.00	5029 22.900
16.500	3.00	12.00	5029 16.500	23.000	4.00	15.00	5029 23.000
16.600	3.00	12.00	5029 16.600	23.100	4.00	15.00	5029 23.100
16.700	3.00	12.00	5029 16.700	23.200	4.00	15.00	5029 23.200
16.800	3.00	12.00	5029 16.800	23.300	4.00	15.00	5029 23.300
16.900	3.00	12.00	5029 16.900	23.400	4.00	15.00	5029 23.400
17.000	3.00	12.00	5029 17.000	23.500	4.00	15.00	5029 23.500
17.100	3.00	12.00	5029 17.100	23.600	4.00	15.00	5029 23.600
17.200	3.00	12.00	5029 17.200	23.700	4.00	15.00	5029 23.700
17.300	3.00	12.00	5029 17.300	23.800	4.00	15.00	5029 23.800
17.400	3.00	12.00	5029 17.400	23.900	4.00	15.00	5029 23.900
17.500	3.00	12.00	5029 17.500	24.000	4.00	15.00	5029 24.000
17.600	3.00	12.00	5029 17.600	24.100	4.00	15.00	5029 24.100
17.700	3.00	12.00	5029 17.700	24.200	4.00	15.00	5029 24.200
17.800	3.00	12.00	5029 17.800	24.300	4.00	15.00	5029 24.300
17.900	3.00	12.00	5029 17.900	24.400	4.00	15.00	5029 24.400
18.000	3.00	12.00	5029 18.000	24.500	4.00	15.00	5029 24.500
18.100	3.00	12.00	5029 18.100	24.600	4.00	15.00	5029 24.600
18.200	3.00	12.00	5029 18.200	24.700	4.00	15.00	5029 24.700
18.300	3.00	12.00	5029 18.300	24.800	4.00	15.00	5029 24.800
18.400	3.00	12.00	5029 18.400	24.900	4.00	15.00	5029 24.900
18.500	3.00	12.00	5029 18.500	25.000	4.00	15.00	5029 25.000



Modular single-fluted gun drills

Deep hole drills

Article no.			5029	Article no.			5029
d1 mm	b mm	l1 mm	Order no.	d1 mm	b mm	l1 mm	Order no.
25.100	4.00	15.00	5029 25.100	33.500	6.00	18.00	5029 33.500
25.200	4.00	15.00	5029 25.200	33.600	6.00	18.00	5029 33.600
25.300	4.00	15.00	5029 25.300	33.700	6.00	18.00	5029 33.700
25.400	4.00	15.00	5029 25.400	33.800	6.00	18.00	5029 33.800
25.500	4.00	15.00	5029 25.500	33.900	6.00	18.00	5029 33.900
25.600	4.00	15.00	5029 25.600	34.000	6.50	19.00	5029 34.000
25.700	4.00	15.00	5029 25.700	34.100	6.50	19.00	5029 34.100
25.800	4.00	15.00	5029 25.800	34.200	6.50	19.00	5029 34.200
25.900	4.00	15.00	5029 25.900	34.300	6.50	19.00	5029 34.300
26.000	5.00	16.00	5029 26.000	34.400	6.50	19.00	5029 34.400
26.100	5.00	16.00	5029 26.100	34.500	6.50	19.00	5029 34.500
26.200	5.00	16.00	5029 26.200	34.600	6.50	19.00	5029 34.600
26.300	5.00	16.00	5029 26.300	34.700	6.50	19.00	5029 34.700
26.400	5.00	16.00	5029 26.400	34.800	6.50	19.00	5029 34.800
26.500	5.00	16.00	5029 26.500	34.900	6.50	19.00	5029 34.900
26.600	5.00	16.00	5029 26.600	35.000	6.50	19.00	5029 35.000
26.700	5.00	16.00	5029 26.700	35.100	6.50	19.00	5029 35.100
26.800	5.00	16.00	5029 26.800	35.200	6.50	19.00	5029 35.200
26.900	5.00	16.00	5029 26.900	35.300	6.50	19.00	5029 35.300
27.000	5.00	16.00	5029 27.000	35.400	6.50	19.00	5029 35.400
27.100	5.00	16.00	5029 27.100	35.500	6.50	19.00	5029 35.500
27.200	5.00	16.00	5029 27.200	35.600	6.50	19.00	5029 35.600
27.300	5.00	16.00	5029 27.300	35.700	6.50	19.00	5029 35.700
27.400	5.00	16.00	5029 27.400	35.800	6.50	19.00	5029 35.800
27.500	5.00	16.00	5029 27.500	35.900	6.50	19.00	5029 35.900
27.600	5.00	16.00	5029 27.600	36.000	6.50	19.00	5029 36.000
27.700	5.00	16.00	5029 27.700	36.100	6.50	19.00	5029 36.100
27.800	5.00	16.00	5029 27.800	36.200	6.50	19.00	5029 36.200
27.900	5.00	16.00	5029 27.900	36.300	6.50	19.00	5029 36.300
28.000	5.00	16.00	5029 28.000	36.400	6.50	19.00	5029 36.400
28.100	5.00	16.00	5029 28.100	36.500	6.50	19.00	5029 36.500
28.200	5.00	16.00	5029 28.200	36.600	6.50	19.00	5029 36.600
28.300	5.00	16.00	5029 28.300	36.700	6.50	19.00	5029 36.700
28.400	5.00	16.00	5029 28.400	36.800	6.50	19.00	5029 36.800
28.500	5.00	16.00	5029 28.500	36.900	6.50	19.00	5029 36.900
28.600	5.00	16.00	5029 28.600	37.000	6.50	19.00	5029 37.000
28.700	5.00	16.00	5029 28.700	37.100	6.50	19.00	5029 37.100
28.800	5.00	16.00	5029 28.800	37.200	6.50	19.00	5029 37.200
28.900	5.00	16.00	5029 28.900	37.300	6.50	19.00	5029 37.300
29.000	5.00	16.00	5029 29.000	37.400	6.50	19.00	5029 37.400
29.100	5.00	16.00	5029 29.100	37.500	6.50	19.00	5029 37.500
29.200	5.00	16.00	5029 29.200	37.600	6.50	19.00	5029 37.600
29.300	5.00	16.00	5029 29.300	37.700	6.50	19.00	5029 37.700
29.400	5.00	16.00	5029 29.400	37.800	6.50	19.00	5029 37.800
29.500	5.00	16.00	5029 29.500	37.900	6.50	19.00	5029 37.900
29.600	5.00	16.00	5029 29.600	38.000	7.00	20.00	5029 38.000
29.700	5.00	16.00	5029 29.700	38.100	7.00	20.00	5029 38.100
29.800	5.00	16.00	5029 29.800	38.200	7.00	20.00	5029 38.200
29.900	5.00	16.00	5029 29.900	38.300	7.00	20.00	5029 38.300
30.000	6.00	18.00	5029 30.000	38.400	7.00	20.00	5029 38.400
30.100	6.00	18.00	5029 30.100	38.500	7.00	20.00	5029 38.500
30.200	6.00	18.00	5029 30.200	38.600	7.00	20.00	5029 38.600
30.300	6.00	18.00	5029 30.300	38.700	7.00	20.00	5029 38.700
30.400	6.00	18.00	5029 30.400	38.800	7.00	20.00	5029 38.800
30.500	6.00	18.00	5029 30.500	38.900	7.00	20.00	5029 38.900
30.600	6.00	18.00	5029 30.600	39.000	7.00	20.00	5029 39.000
30.700	6.00	18.00	5029 30.700	39.100	7.00	20.00	5029 39.100
30.800	6.00	18.00	5029 30.800	39.200	7.00	20.00	5029 39.200
30.900	6.00	18.00	5029 30.900	39.300	7.00	20.00	5029 39.300
31.000	6.00	18.00	5029 31.000	39.400	7.00	20.00	5029 39.400
31.100	6.00	18.00	5029 31.100	39.500	7.00	20.00	5029 39.500
31.200	6.00	18.00	5029 31.200	39.600	7.00	20.00	5029 39.600
31.300	6.00	18.00	5029 31.300	39.700	7.00	20.00	5029 39.700
31.400	6.00	18.00	5029 31.400	39.800	7.00	20.00	5029 39.800
31.500	6.00	18.00	5029 31.500	39.900	7.00	20.00	5029 39.900
31.600	6.00	18.00	5029 31.600	40.000	7.00	20.00	5029 40.000
31.700	6.00	18.00	5029 31.700	40.100	4.00	15.00	5029 40.100
31.800	6.00	18.00	5029 31.800	40.200	4.00	15.00	5029 40.200
31.900	6.00	18.00	5029 31.900	40.300	4.00	15.00	5029 40.300
32.000	6.00	18.00	5029 32.000	40.400	4.00	15.00	5029 40.400
32.100	6.00	18.00	5029 32.100	40.500	4.00	15.00	5029 40.500
32.200	6.00	18.00	5029 32.200	40.600	4.00	15.00	5029 40.600
32.300	6.00	18.00	5029 32.300	40.700	4.00	15.00	5029 40.700
32.400	6.00	18.00	5029 32.400	40.800	4.00	15.00	5029 40.800
32.500	6.00	18.00	5029 32.500	40.900	4.00	15.00	5029 40.900
32.600	6.00	18.00	5029 32.600	41.000	4.00	15.00	5029 41.000
32.700	6.00	18.00	5029 32.700	41.100	4.00	15.00	5029 41.100
32.800	6.00	18.00	5029 32.800	41.200	4.00	15.00	5029 41.200
32.900	6.00	18.00	5029 32.900	41.300	4.00	15.00	5029 41.300
33.000	6.00	18.00	5029 33.000	41.400	4.00	15.00	5029 41.400
33.100	6.00	18.00	5029 33.100	41.500	4.00	15.00	5029 41.500
33.200	6.00	18.00	5029 33.200	41.600	4.00	15.00	5029 41.600
33.300	6.00	18.00	5029 33.300	41.700	4.00	15.00	5029 41.700
33.400	6.00	18.00	5029 33.400	41.800	4.00	15.00	5029 41.800



Article no.			5029	Article no.			5029
d1 mm	b mm	l1 mm	Order no.	d1 mm	b mm	l1 mm	Order no.
41.900	4.00	15.00	5029 41.900	47.300	5.00	16.00	5029 47.300
42.000	4.00	15.00	5029 42.000	47.400	5.00	16.00	5029 47.400
42.100	4.00	15.00	5029 42.100	47.500	5.00	16.00	5029 47.500
42.200	4.00	15.00	5029 42.200	47.600	5.00	16.00	5029 47.600
42.300	4.00	15.00	5029 42.300	47.700	5.00	16.00	5029 47.700
42.400	4.00	15.00	5029 42.400	47.800	5.00	16.00	5029 47.800
42.500	4.00	15.00	5029 42.500	47.900	5.00	16.00	5029 47.900
42.600	4.00	15.00	5029 42.600	48.000	6.00	18.00	5029 48.000
42.700	4.00	15.00	5029 42.700	48.100	6.00	18.00	5029 48.100
42.800	4.00	15.00	5029 42.800	48.200	6.00	18.00	5029 48.200
42.900	4.00	15.00	5029 42.900	48.300	6.00	18.00	5029 48.300
43.000	4.00	15.00	5029 43.000	48.400	6.00	18.00	5029 48.400
43.100	4.00	15.00	5029 43.100	48.500	6.00	18.00	5029 48.500
43.200	4.00	15.00	5029 43.200	48.600	6.00	18.00	5029 48.600
43.300	4.00	15.00	5029 43.300	48.700	6.00	18.00	5029 48.700
43.400	4.00	15.00	5029 43.400	48.800	6.00	18.00	5029 48.800
43.500	4.00	15.00	5029 43.500	48.900	6.00	18.00	5029 48.900
43.600	4.00	15.00	5029 43.600	49.000	6.00	18.00	5029 49.000
43.700	4.00	15.00	5029 43.700	49.100	6.00	18.00	5029 49.100
43.800	4.00	15.00	5029 43.800	49.200	6.00	18.00	5029 49.200
43.900	4.00	15.00	5029 43.900	49.300	6.00	18.00	5029 49.300
44.000	5.00	16.00	5029 44.000	49.400	6.00	18.00	5029 49.400
44.100	5.00	16.00	5029 44.100	49.500	6.00	18.00	5029 49.500
44.200	5.00	16.00	5029 44.200	49.600	6.00	18.00	5029 49.600
44.300	5.00	16.00	5029 44.300	49.700	6.00	18.00	5029 49.700
44.400	5.00	16.00	5029 44.400	49.800	6.00	18.00	5029 49.800
44.500	5.00	16.00	5029 44.500	49.900	6.00	18.00	5029 49.900
44.600	5.00	16.00	5029 44.600	50.000	6.00	18.00	5029 50.000
44.700	5.00	16.00	5029 44.700	50.100	6.00	18.00	5029 50.100
44.800	5.00	16.00	5029 44.800	50.200	6.00	18.00	5029 50.200
44.900	5.00	16.00	5029 44.900	50.300	6.00	18.00	5029 50.300
45.000	5.00	16.00	5029 45.000	50.400	6.00	18.00	5029 50.400
45.100	5.00	16.00	5029 45.100	50.500	6.00	18.00	5029 50.500
45.200	5.00	16.00	5029 45.200	50.600	6.00	18.00	5029 50.600
45.300	5.00	16.00	5029 45.300	50.700	6.00	18.00	5029 50.700
45.400	5.00	16.00	5029 45.400	50.800	6.00	18.00	5029 50.800
45.500	5.00	16.00	5029 45.500	50.900	6.00	18.00	5029 50.900
45.600	5.00	16.00	5029 45.600	51.000	6.00	18.00	5029 51.000
45.700	5.00	16.00	5029 45.700	51.100	6.00	18.00	5029 51.100
45.800	5.00	16.00	5029 45.800	51.200	6.00	18.00	5029 51.200
45.900	5.00	16.00	5029 45.900	51.300	6.00	18.00	5029 51.300
46.000	5.00	16.00	5029 46.000	51.400	6.00	18.00	5029 51.400
46.100	5.00	16.00	5029 46.100	51.500	6.00	18.00	5029 51.500
46.200	5.00	16.00	5029 46.200	51.600	6.00	18.00	5029 51.600
46.300	5.00	16.00	5029 46.300	51.700	6.00	18.00	5029 51.700
46.400	5.00	16.00	5029 46.400	51.800	6.00	18.00	5029 51.800
46.500	5.00	16.00	5029 46.500	51.900	6.00	18.00	5029 51.900
46.600	5.00	16.00	5029 46.600	52.000	6.00	18.00	5029 52.000
46.700	5.00	16.00	5029 46.700				
46.800	5.00	16.00	5029 46.800				
46.900	5.00	16.00	5029 46.900				
47.000	5.00	16.00	5029 47.000				
47.100	5.00	16.00	5029 47.100				
47.200	5.00	16.00	5029 47.200				



Modular single-fluted gun drills

Deep hole drills

Outer inserts for single-fluted gun drills EB 800

Article no. **5702**



Cutting data page 440

P	M	K	N	S	H
•	•	•	•	•	○

interchangeable insert with 1 cutting edge • observe tightening torques • order torque wrench set art. no. 4966 separately

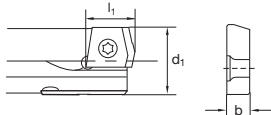

			Article no.	5702				Article no.	5702
d1	b	l1		Order no.	d1	b	l1		Order no.
mm	mm	mm			mm	mm	mm		
12.000	2.80	10.00		5702 12.000	18.600	3.00	12.00		5702 18.600
12.100	2.80	10.00		5702 12.100	18.700	3.00	12.00		5702 18.700
12.200	2.80	10.00		5702 12.200	18.800	3.00	12.00		5702 18.800
12.300	2.80	10.00		5702 12.300	18.900	3.00	12.00		5702 18.900
12.400	2.80	10.00		5702 12.400	19.000	3.00	12.00		5702 19.000
12.500	2.80	10.00		5702 12.500	19.050	3.00	12.00		5702 19.050
12.600	2.80	10.00		5702 12.600	19.100	3.00	12.00		5702 19.100
12.700	2.80	10.00		5702 12.700	19.200	3.00	12.00		5702 19.200
12.800	2.80	10.00		5702 12.800	19.300	3.00	12.00		5702 19.300
12.900	2.80	10.00		5702 12.900	19.400	3.00	12.00		5702 19.400
13.000	2.80	10.00		5702 13.000	19.500	3.00	12.00		5702 19.500
13.100	2.80	10.00		5702 13.100	19.600	3.00	12.00		5702 19.600
13.200	2.80	10.00		5702 13.200	19.700	3.00	12.00		5702 19.700
13.300	2.80	10.00		5702 13.300	19.800	3.00	12.00		5702 19.800
13.400	2.80	10.00		5702 13.400	19.900	3.00	12.00		5702 19.900
13.500	2.80	10.00		5702 13.500	20.000	4.00	15.00		5702 20.000
13.600	2.80	10.00		5702 13.600	20.100	4.00	15.00		5702 20.100
13.700	2.80	10.00		5702 13.700	20.200	4.00	15.00		5702 20.200
13.800	2.80	10.00		5702 13.800	20.300	4.00	15.00		5702 20.300
13.900	2.80	10.00		5702 13.900	20.400	4.00	15.00		5702 20.400
14.000	2.80	10.00		5702 14.000	20.500	4.00	15.00		5702 20.500
14.100	2.80	10.00		5702 14.100	20.600	4.00	15.00		5702 20.600
14.200	2.80	10.00		5702 14.200	20.700	4.00	15.00		5702 20.700
14.300	2.80	10.00		5702 14.300	20.800	4.00	15.00		5702 20.800
14.400	2.80	10.00		5702 14.400	20.900	4.00	15.00		5702 20.900
14.500	2.80	10.00		5702 14.500	21.000	4.00	15.00		5702 21.000
14.600	2.80	10.00		5702 14.600	21.100	4.00	15.00		5702 21.100
14.700	2.80	10.00		5702 14.700	21.200	4.00	15.00		5702 21.200
14.800	2.80	10.00		5702 14.800	21.300	4.00	15.00		5702 21.300
14.900	2.80	10.00		5702 14.900	21.400	4.00	15.00		5702 21.400
15.000	2.80	10.00		5702 15.000	21.500	4.00	15.00		5702 21.500
15.100	2.80	10.00		5702 15.100	21.600	4.00	15.00		5702 21.600
15.200	2.80	10.00		5702 15.200	21.700	4.00	15.00		5702 21.700
15.300	2.80	10.00		5702 15.300	21.800	4.00	15.00		5702 21.800
15.400	2.80	10.00		5702 15.400	21.900	4.00	15.00		5702 21.900
15.500	2.80	10.00		5702 15.500	22.000	4.00	15.00		5702 22.000
15.600	2.80	10.00		5702 15.600	22.100	4.00	15.00		5702 22.100
15.700	2.80	10.00		5702 15.700	22.200	4.00	15.00		5702 22.200
15.800	2.80	10.00		5702 15.800	22.300	4.00	15.00		5702 22.300
15.900	2.80	10.00		5702 15.900	22.400	4.00	15.00		5702 22.400
16.000	3.00	12.00		5702 16.000	22.500	4.00	15.00		5702 22.500
16.100	3.00	12.00		5702 16.100	22.600	4.00	15.00		5702 22.600
16.200	3.00	12.00		5702 16.200	22.700	4.00	15.00		5702 22.700
16.300	3.00	12.00		5702 16.300	22.800	4.00	15.00		5702 22.800
16.400	3.00	12.00		5702 16.400	22.900	4.00	15.00		5702 22.900
16.500	3.00	12.00		5702 16.500	23.000	4.00	15.00		5702 23.000
16.600	3.00	12.00		5702 16.600	23.100	4.00	15.00		5702 23.100
16.700	3.00	12.00		5702 16.700	23.200	4.00	15.00		5702 23.200
16.800	3.00	12.00		5702 16.800	23.300	4.00	15.00		5702 23.300
16.900	3.00	12.00		5702 16.900	23.400	4.00	15.00		5702 23.400
17.000	3.00	12.00		5702 17.000	23.500	4.00	15.00		5702 23.500
17.100	3.00	12.00		5702 17.100	23.600	4.00	15.00		5702 23.600
17.200	3.00	12.00		5702 17.200	23.700	4.00	15.00		5702 23.700
17.300	3.00	12.00		5702 17.300	23.800	4.00	15.00		5702 23.800
17.400	3.00	12.00		5702 17.400	23.900	4.00	15.00		5702 23.900
17.500	3.00	12.00		5702 17.500	24.000	4.00	15.00		5702 24.000
17.600	3.00	12.00		5702 17.600	24.100	4.00	15.00		5702 24.100
17.700	3.00	12.00		5702 17.700	24.200	4.00	15.00		5702 24.200
17.800	3.00	12.00		5702 17.800	24.300	4.00	15.00		5702 24.300
17.900	3.00	12.00		5702 17.900	24.400	4.00	15.00		5702 24.400
18.000	3.00	12.00		5702 18.000	24.500	4.00	15.00		5702 24.500
18.100	3.00	12.00		5702 18.100	24.600	4.00	15.00		5702 24.600
18.200	3.00	12.00		5702 18.200	24.700	4.00	15.00		5702 24.700
18.300	3.00	12.00		5702 18.300	24.800	4.00	15.00		5702 24.800
18.400	3.00	12.00		5702 18.400	24.900	4.00	15.00		5702 24.900
18.500	3.00	12.00		5702 18.500	25.000	4.00	15.00		5702 25.000



Article no.			5702	Article no.			5702
d1 mm	b mm	l1 mm	Order no.	d1 mm	b mm	l1 mm	Order no.
25.100	4.00	15.00	5702 25.100	33.500	6.00	18.00	5702 33.500
25.200	4.00	15.00	5702 25.200	33.600	6.00	18.00	5702 33.600
25.300	4.00	15.00	5702 25.300	33.700	6.00	18.00	5702 33.700
25.400	4.00	15.00	5702 25.400	33.800	6.00	18.00	5702 33.800
25.500	4.00	15.00	5702 25.500	33.900	6.00	18.00	5702 33.900
25.600	4.00	15.00	5702 25.600	34.000	6.50	19.00	5702 34.000
25.700	4.00	15.00	5702 25.700	34.100	6.50	19.00	5702 34.100
25.800	4.00	15.00	5702 25.800	34.200	6.50	19.00	5702 34.200
25.900	4.00	15.00	5702 25.900	34.300	6.50	19.00	5702 34.300
26.000	5.00	16.00	5702 26.000	34.400	6.50	19.00	5702 34.400
26.100	5.00	16.00	5702 26.100	34.500	6.50	19.00	5702 34.500
26.200	5.00	16.00	5702 26.200	34.600	6.50	19.00	5702 34.600
26.300	5.00	16.00	5702 26.300	34.700	6.50	19.00	5702 34.700
26.400	5.00	16.00	5702 26.400	34.800	6.50	19.00	5702 34.800
26.500	5.00	16.00	5702 26.500	34.900	6.50	19.00	5702 34.900
26.600	5.00	16.00	5702 26.600	35.000	6.50	19.00	5702 35.000
26.700	5.00	16.00	5702 26.700	35.100	6.50	19.00	5702 35.100
26.800	5.00	16.00	5702 26.800	35.200	6.50	19.00	5702 35.200
26.900	5.00	16.00	5702 26.900	35.300	6.50	19.00	5702 35.300
27.000	5.00	16.00	5702 27.000	35.400	6.50	19.00	5702 35.400
27.100	5.00	16.00	5702 27.100	35.500	6.50	19.00	5702 35.500
27.200	5.00	16.00	5702 27.200	35.600	6.50	19.00	5702 35.600
27.300	5.00	16.00	5702 27.300	35.700	6.50	19.00	5702 35.700
27.400	5.00	16.00	5702 27.400	35.800	6.50	19.00	5702 35.800
27.500	5.00	16.00	5702 27.500	35.900	6.50	19.00	5702 35.900
27.600	5.00	16.00	5702 27.600	36.000	6.50	19.00	5702 36.000
27.700	5.00	16.00	5702 27.700	36.100	6.50	19.00	5702 36.100
27.800	5.00	16.00	5702 27.800	36.200	6.50	19.00	5702 36.200
27.900	5.00	16.00	5702 27.900	36.300	6.50	19.00	5702 36.300
28.000	5.00	16.00	5702 28.000	36.400	6.50	19.00	5702 36.400
28.100	5.00	16.00	5702 28.100	36.500	6.50	19.00	5702 36.500
28.200	5.00	16.00	5702 28.200	36.600	6.50	19.00	5702 36.600
28.300	5.00	16.00	5702 28.300	36.700	6.50	19.00	5702 36.700
28.400	5.00	16.00	5702 28.400	36.800	6.50	19.00	5702 36.800
28.500	5.00	16.00	5702 28.500	36.900	6.50	19.00	5702 36.900
28.600	5.00	16.00	5702 28.600	37.000	6.50	19.00	5702 37.000
28.700	5.00	16.00	5702 28.700	37.100	6.50	19.00	5702 37.100
28.800	5.00	16.00	5702 28.800	37.200	6.50	19.00	5702 37.200
28.900	5.00	16.00	5702 28.900	37.300	6.50	19.00	5702 37.300
29.000	5.00	16.00	5702 29.000	37.400	6.50	19.00	5702 37.400
29.100	5.00	16.00	5702 29.100	37.500	6.50	19.00	5702 37.500
29.200	5.00	16.00	5702 29.200	37.600	6.50	19.00	5702 37.600
29.300	5.00	16.00	5702 29.300	37.700	6.50	19.00	5702 37.700
29.400	5.00	16.00	5702 29.400	37.800	6.50	19.00	5702 37.800
29.500	5.00	16.00	5702 29.500	37.900	6.50	19.00	5702 37.900
29.600	5.00	16.00	5702 29.600	38.000	7.00	20.00	5702 38.000
29.700	5.00	16.00	5702 29.700	38.100	7.00	20.00	5702 38.100
29.800	5.00	16.00	5702 29.800	38.200	7.00	20.00	5702 38.200
29.900	5.00	16.00	5702 29.900	38.300	7.00	20.00	5702 38.300
30.000	6.00	18.00	5702 30.000	38.400	7.00	20.00	5702 38.400
30.100	6.00	18.00	5702 30.100	38.500	7.00	20.00	5702 38.500
30.200	6.00	18.00	5702 30.200	38.600	7.00	20.00	5702 38.600
30.300	6.00	18.00	5702 30.300	38.700	7.00	20.00	5702 38.700
30.400	6.00	18.00	5702 30.400	38.800	7.00	20.00	5702 38.800
30.500	6.00	18.00	5702 30.500	38.900	7.00	20.00	5702 38.900
30.600	6.00	18.00	5702 30.600	39.000	7.00	20.00	5702 39.000
30.700	6.00	18.00	5702 30.700	39.100	7.00	20.00	5702 39.100
30.800	6.00	18.00	5702 30.800	39.200	7.00	20.00	5702 39.200
30.900	6.00	18.00	5702 30.900	39.300	7.00	20.00	5702 39.300
31.000	6.00	18.00	5702 31.000	39.400	7.00	20.00	5702 39.400
31.100	6.00	18.00	5702 31.100	39.500	7.00	20.00	5702 39.500
31.200	6.00	18.00	5702 31.200	39.600	7.00	20.00	5702 39.600
31.300	6.00	18.00	5702 31.300	39.700	7.00	20.00	5702 39.700
31.400	6.00	18.00	5702 31.400	39.800	7.00	20.00	5702 39.800
31.500	6.00	18.00	5702 31.500	39.900	7.00	20.00	5702 39.900
31.600	6.00	18.00	5702 31.600	40.000	7.00	20.00	5702 40.000
31.700	6.00	18.00	5702 31.700	40.100	4.00	15.00	5702 40.100
31.800	6.00	18.00	5702 31.800	40.200	4.00	15.00	5702 40.200
31.900	6.00	18.00	5702 31.900	40.300	4.00	15.00	5702 40.300
32.000	6.00	18.00	5702 32.000	40.400	4.00	15.00	5702 40.400
32.100	6.00	18.00	5702 32.100	40.500	4.00	15.00	5702 40.500
32.200	6.00	18.00	5702 32.200	40.600	4.00	15.00	5702 40.600
32.300	6.00	18.00	5702 32.300	40.700	4.00	15.00	5702 40.700
32.400	6.00	18.00	5702 32.400	40.800	4.00	15.00	5702 40.800
32.500	6.00	18.00	5702 32.500	40.900	4.00	15.00	5702 40.900
32.600	6.00	18.00	5702 32.600	41.000	4.00	15.00	5702 41.000
32.700	6.00	18.00	5702 32.700	41.100	4.00	15.00	5702 41.100
32.800	6.00	18.00	5702 32.800	41.200	4.00	15.00	5702 41.200
32.900	6.00	18.00	5702 32.900	41.300	4.00	15.00	5702 41.300
33.000	6.00	18.00	5702 33.000	41.400	4.00	15.00	5702 41.400
33.100	6.00	18.00	5702 33.100	41.500	4.00	15.00	5702 41.500
33.200	6.00	18.00	5702 33.200	41.600	4.00	15.00	5702 41.600
33.300	6.00	18.00	5702 33.300	41.700	4.00	15.00	5702 41.700
33.400	6.00	18.00	5702 33.400	41.800	4.00	15.00	5702 41.800

Deep hole drills



Modular single-fluted gun drills

Deep hole drills

Article no.			5702	Article no.			5702
d1 mm	b mm	l1 mm	Order no.	d1 mm	b mm	l1 mm	Order no.
41.900	4.00	15.00	5702 41.900	47.300	5.00	16.00	5702 47.300
42.000	4.00	15.00	5702 42.000	47.400	5.00	16.00	5702 47.400
42.100	4.00	15.00	5702 42.100	47.500	5.00	16.00	5702 47.500
42.200	4.00	15.00	5702 42.200	47.600	5.00	16.00	5702 47.600
42.300	4.00	15.00	5702 42.300	47.700	5.00	16.00	5702 47.700
42.400	4.00	15.00	5702 42.400	47.800	5.00	16.00	5702 47.800
42.500	4.00	15.00	5702 42.500	47.900	5.00	16.00	5702 47.900
42.600	4.00	15.00	5702 42.600	48.000	6.00	18.00	5702 48.000
42.700	4.00	15.00	5702 42.700	48.100	6.00	18.00	5702 48.100
42.800	4.00	15.00	5702 42.800	48.200	6.00	18.00	5702 48.200
42.900	4.00	15.00	5702 42.900	48.300	6.00	18.00	5702 48.300
43.000	4.00	15.00	5702 43.000	48.400	6.00	18.00	5702 48.400
43.100	4.00	15.00	5702 43.100	48.500	6.00	18.00	5702 48.500
43.200	4.00	15.00	5702 43.200	48.600	6.00	18.00	5702 48.600
43.300	4.00	15.00	5702 43.300	48.700	6.00	18.00	5702 48.700
43.400	4.00	15.00	5702 43.400	48.800	6.00	18.00	5702 48.800
43.500	4.00	15.00	5702 43.500	48.900	6.00	18.00	5702 48.900
43.600	4.00	15.00	5702 43.600	49.000	6.00	18.00	5702 49.000
43.700	4.00	15.00	5702 43.700	49.100	6.00	18.00	5702 49.100
43.800	4.00	15.00	5702 43.800	49.200	6.00	18.00	5702 49.200
43.900	4.00	15.00	5702 43.900	49.300	6.00	18.00	5702 49.300
44.000	5.00	16.00	5702 44.000	49.400	6.00	18.00	5702 49.400
44.100	5.00	16.00	5702 44.100	49.500	6.00	18.00	5702 49.500
44.200	5.00	16.00	5702 44.200	49.600	6.00	18.00	5702 49.600
44.300	5.00	16.00	5702 44.300	49.700	6.00	18.00	5702 49.700
44.400	5.00	16.00	5702 44.400	49.800	6.00	18.00	5702 49.800
44.500	5.00	16.00	5702 44.500	49.900	6.00	18.00	5702 49.900
44.600	5.00	16.00	5702 44.600	50.000	6.00	18.00	5702 50.000
44.700	5.00	16.00	5702 44.700	50.100	6.00	18.00	5702 50.100
44.800	5.00	16.00	5702 44.800	50.200	6.00	18.00	5702 50.200
44.900	5.00	16.00	5702 44.900	50.300	6.00	18.00	5702 50.300
45.000	5.00	16.00	5702 45.000	50.400	6.00	18.00	5702 50.400
45.100	5.00	16.00	5702 45.100	50.500	6.00	18.00	5702 50.500
45.200	5.00	16.00	5702 45.200	50.600	6.00	18.00	5702 50.600
45.300	5.00	16.00	5702 45.300	50.700	6.00	18.00	5702 50.700
45.400	5.00	16.00	5702 45.400	50.800	6.00	18.00	5702 50.800
45.500	5.00	16.00	5702 45.500	50.900	6.00	18.00	5702 50.900
45.600	5.00	16.00	5702 45.600	51.000	6.00	18.00	5702 51.000
45.700	5.00	16.00	5702 45.700	51.100	6.00	18.00	5702 51.100
45.800	5.00	16.00	5702 45.800	51.200	6.00	18.00	5702 51.200
45.900	5.00	16.00	5702 45.900	51.300	6.00	18.00	5702 51.300
46.000	5.00	16.00	5702 46.000	51.400	6.00	18.00	5702 51.400
46.100	5.00	16.00	5702 46.100	51.500	6.00	18.00	5702 51.500
46.200	5.00	16.00	5702 46.200	51.600	6.00	18.00	5702 51.600
46.300	5.00	16.00	5702 46.300	51.700	6.00	18.00	5702 51.700
46.400	5.00	16.00	5702 46.400	51.800	6.00	18.00	5702 51.800
46.500	5.00	16.00	5702 46.500	51.900	6.00	18.00	5702 51.900
46.600	5.00	16.00	5702 46.600	52.000	6.00	18.00	5702 52.000
46.700	5.00	16.00	5702 46.700				
46.800	5.00	16.00	5702 46.800				
46.900	5.00	16.00	5702 46.900				
47.000	5.00	16.00	5702 47.000				
47.100	5.00	16.00	5702 47.100				
47.200	5.00	16.00	5702 47.200				



Outer inserts for single-fluted gun drills EB 800

Article no. **5704**



Cutting data page 440

P	M	K	N	S	H
●	○	●	○	○	

interchangeable insert with 1 cutting edge • observe tightening torques • order torque wrench set art. no. 4966 separately

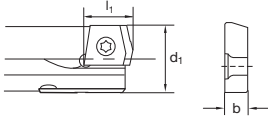

			Article no.	5704				Article no.	5704
d1	b	l1		Order no.	d1	b	l1		Order no.
mm	mm	mm			mm	mm	mm		
12.000	2.80	10.00		5704 12.000	18.600	3.00	12.00		5704 18.600
12.100	2.80	10.00		5704 12.100	18.700	3.00	12.00		5704 18.700
12.200	2.80	10.00		5704 12.200	18.800	3.00	12.00		5704 18.800
12.300	2.80	10.00		5704 12.300	18.900	3.00	12.00		5704 18.900
12.400	2.80	10.00		5704 12.400	19.000	3.00	12.00		5704 19.000
12.500	2.80	10.00		5704 12.500	19.050	3.00	12.00		5704 19.050
12.600	2.80	10.00		5704 12.600	19.100	3.00	12.00		5704 19.100
12.700	2.80	10.00		5704 12.700	19.200	3.00	12.00		5704 19.200
12.800	2.80	10.00		5704 12.800	19.300	3.00	12.00		5704 19.300
12.900	2.80	10.00		5704 12.900	19.400	3.00	12.00		5704 19.400
13.000	2.80	10.00		5704 13.000	19.500	3.00	12.00		5704 19.500
13.100	2.80	10.00		5704 13.100	19.600	3.00	12.00		5704 19.600
13.200	2.80	10.00		5704 13.200	19.700	3.00	12.00		5704 19.700
13.300	2.80	10.00		5704 13.300	19.800	3.00	12.00		5704 19.800
13.400	2.80	10.00		5704 13.400	19.900	3.00	12.00		5704 19.900
13.500	2.80	10.00		5704 13.500	20.000	4.00	15.00		5704 20.000
13.600	2.80	10.00		5704 13.600	20.100	4.00	15.00		5704 20.100
13.700	2.80	10.00		5704 13.700	20.200	4.00	15.00		5704 20.200
13.800	2.80	10.00		5704 13.800	20.300	4.00	15.00		5704 20.300
13.900	2.80	10.00		5704 13.900	20.400	4.00	15.00		5704 20.400
14.000	2.80	10.00		5704 14.000	20.500	4.00	15.00		5704 20.500
14.100	2.80	10.00		5704 14.100	20.600	4.00	15.00		5704 20.600
14.200	2.80	10.00		5704 14.200	20.700	4.00	15.00		5704 20.700
14.300	2.80	10.00		5704 14.300	20.800	4.00	15.00		5704 20.800
14.400	2.80	10.00		5704 14.400	20.900	4.00	15.00		5704 20.900
14.500	2.80	10.00		5704 14.500	21.000	4.00	15.00		5704 21.000
14.600	2.80	10.00		5704 14.600	21.100	4.00	15.00		5704 21.100
14.700	2.80	10.00		5704 14.700	21.200	4.00	15.00		5704 21.200
14.800	2.80	10.00		5704 14.800	21.300	4.00	15.00		5704 21.300
14.900	2.80	10.00		5704 14.900	21.400	4.00	15.00		5704 21.400
15.000	2.80	10.00		5704 15.000	21.500	4.00	15.00		5704 21.500
15.100	2.80	10.00		5704 15.100	21.600	4.00	15.00		5704 21.600
15.200	2.80	10.00		5704 15.200	21.700	4.00	15.00		5704 21.700
15.300	2.80	10.00		5704 15.300	21.800	4.00	15.00		5704 21.800
15.400	2.80	10.00		5704 15.400	21.900	4.00	15.00		5704 21.900
15.500	2.80	10.00		5704 15.500	22.000	4.00	15.00		5704 22.000
15.600	2.80	10.00		5704 15.600	22.100	4.00	15.00		5704 22.100
15.700	2.80	10.00		5704 15.700	22.200	4.00	15.00		5704 22.200
15.800	2.80	10.00		5704 15.800	22.300	4.00	15.00		5704 22.300
15.900	2.80	10.00		5704 15.900	22.400	4.00	15.00		5704 22.400
16.000	3.00	12.00		5704 16.000	22.500	4.00	15.00		5704 22.500
16.100	3.00	12.00		5704 16.100	22.600	4.00	15.00		5704 22.600
16.200	3.00	12.00		5704 16.200	22.700	4.00	15.00		5704 22.700
16.300	3.00	12.00		5704 16.300	22.800	4.00	15.00		5704 22.800
16.400	3.00	12.00		5704 16.400	22.900	4.00	15.00		5704 22.900
16.500	3.00	12.00		5704 16.500	23.000	4.00	15.00		5704 23.000
16.600	3.00	12.00		5704 16.600	23.100	4.00	15.00		5704 23.100
16.700	3.00	12.00		5704 16.700	23.200	4.00	15.00		5704 23.200
16.800	3.00	12.00		5704 16.800	23.300	4.00	15.00		5704 23.300
16.900	3.00	12.00		5704 16.900	23.400	4.00	15.00		5704 23.400
17.000	3.00	12.00		5704 17.000	23.500	4.00	15.00		5704 23.500
17.100	3.00	12.00		5704 17.100	23.600	4.00	15.00		5704 23.600
17.200	3.00	12.00		5704 17.200	23.700	4.00	15.00		5704 23.700
17.300	3.00	12.00		5704 17.300	23.800	4.00	15.00		5704 23.800
17.400	3.00	12.00		5704 17.400	23.900	4.00	15.00		5704 23.900
17.500	3.00	12.00		5704 17.500	24.000	4.00	15.00		5704 24.000
17.600	3.00	12.00		5704 17.600	24.100	4.00	15.00		5704 24.100
17.700	3.00	12.00		5704 17.700	24.200	4.00	15.00		5704 24.200
17.800	3.00	12.00		5704 17.800	24.300	4.00	15.00		5704 24.300
17.900	3.00	12.00		5704 17.900	24.400	4.00	15.00		5704 24.400
18.000	3.00	12.00		5704 18.000	24.500	4.00	15.00		5704 24.500
18.100	3.00	12.00		5704 18.100	24.600	4.00	15.00		5704 24.600
18.200	3.00	12.00		5704 18.200	24.700	4.00	15.00		5704 24.700
18.300	3.00	12.00		5704 18.300	24.800	4.00	15.00		5704 24.800
18.400	3.00	12.00		5704 18.400	24.900	4.00	15.00		5704 24.900
18.500	3.00	12.00		5704 18.500	25.000	4.00	15.00		5704 25.000



Modular single-fluted gun drills

Deep hole drills

Article no.			5704	Article no.			5704
d1 mm	b mm	l1 mm	Order no.	d1 mm	b mm	l1 mm	Order no.
25.100	4.00	15.00	5704 25.100	33.500	6.00	18.00	5704 33.500
25.200	4.00	15.00	5704 25.200	33.600	6.00	18.00	5704 33.600
25.300	4.00	15.00	5704 25.300	33.700	6.00	18.00	5704 33.700
25.400	4.00	15.00	5704 25.400	33.800	6.00	18.00	5704 33.800
25.500	4.00	15.00	5704 25.500	33.900	6.00	18.00	5704 33.900
25.600	4.00	15.00	5704 25.600	34.000	6.50	19.00	5704 34.000
25.700	4.00	15.00	5704 25.700	34.100	6.50	19.00	5704 34.100
25.800	4.00	15.00	5704 25.800	34.200	6.50	19.00	5704 34.200
25.900	4.00	15.00	5704 25.900	34.300	6.50	19.00	5704 34.300
26.000	5.00	16.00	5704 26.000	34.400	6.50	19.00	5704 34.400
26.100	5.00	16.00	5704 26.100	34.500	6.50	19.00	5704 34.500
26.200	5.00	16.00	5704 26.200	34.600	6.50	19.00	5704 34.600
26.300	5.00	16.00	5704 26.300	34.700	6.50	19.00	5704 34.700
26.400	5.00	16.00	5704 26.400	34.800	6.50	19.00	5704 34.800
26.500	5.00	16.00	5704 26.500	34.900	6.50	19.00	5704 34.900
26.600	5.00	16.00	5704 26.600	35.000	6.50	19.00	5704 35.000
26.700	5.00	16.00	5704 26.700	35.100	6.50	19.00	5704 35.100
26.800	5.00	16.00	5704 26.800	35.200	6.50	19.00	5704 35.200
26.900	5.00	16.00	5704 26.900	35.300	6.50	19.00	5704 35.300
27.000	5.00	16.00	5704 27.000	35.400	6.50	19.00	5704 35.400
27.100	5.00	16.00	5704 27.100	35.500	6.50	19.00	5704 35.500
27.200	5.00	16.00	5704 27.200	35.600	6.50	19.00	5704 35.600
27.300	5.00	16.00	5704 27.300	35.700	6.50	19.00	5704 35.700
27.400	5.00	16.00	5704 27.400	35.800	6.50	19.00	5704 35.800
27.500	5.00	16.00	5704 27.500	35.900	6.50	19.00	5704 35.900
27.600	5.00	16.00	5704 27.600	36.000	6.50	19.00	5704 36.000
27.700	5.00	16.00	5704 27.700	36.100	6.50	19.00	5704 36.100
27.800	5.00	16.00	5704 27.800	36.200	6.50	19.00	5704 36.200
27.900	5.00	16.00	5704 27.900	36.300	6.50	19.00	5704 36.300
28.000	5.00	16.00	5704 28.000	36.400	6.50	19.00	5704 36.400
28.100	5.00	16.00	5704 28.100	36.500	6.50	19.00	5704 36.500
28.200	5.00	16.00	5704 28.200	36.600	6.50	19.00	5704 36.600
28.300	5.00	16.00	5704 28.300	36.700	6.50	19.00	5704 36.700
28.400	5.00	16.00	5704 28.400	36.800	6.50	19.00	5704 36.800
28.500	5.00	16.00	5704 28.500	36.900	6.50	19.00	5704 36.900
28.600	5.00	16.00	5704 28.600	37.000	6.50	19.00	5704 37.000
28.700	5.00	16.00	5704 28.700	37.100	6.50	19.00	5704 37.100
28.800	5.00	16.00	5704 28.800	37.200	6.50	19.00	5704 37.200
28.900	5.00	16.00	5704 28.900	37.300	6.50	19.00	5704 37.300
29.000	5.00	16.00	5704 29.000	37.400	6.50	19.00	5704 37.400
29.100	5.00	16.00	5704 29.100	37.500	6.50	19.00	5704 37.500
29.200	5.00	16.00	5704 29.200	37.600	6.50	19.00	5704 37.600
29.300	5.00	16.00	5704 29.300	37.700	6.50	19.00	5704 37.700
29.400	5.00	16.00	5704 29.400	37.800	6.50	19.00	5704 37.800
29.500	5.00	16.00	5704 29.500	37.900	6.50	19.00	5704 37.900
29.600	5.00	16.00	5704 29.600	38.000	7.00	20.00	5704 38.000
29.700	5.00	16.00	5704 29.700	38.100	7.00	20.00	5704 38.100
29.800	5.00	16.00	5704 29.800	38.200	7.00	20.00	5704 38.200
29.900	5.00	16.00	5704 29.900	38.300	7.00	20.00	5704 38.300
30.000	6.00	18.00	5704 30.000	38.400	7.00	20.00	5704 38.400
30.100	6.00	18.00	5704 30.100	38.500	7.00	20.00	5704 38.500
30.200	6.00	18.00	5704 30.200	38.600	7.00	20.00	5704 38.600
30.300	6.00	18.00	5704 30.300	38.700	7.00	20.00	5704 38.700
30.400	6.00	18.00	5704 30.400	38.800	7.00	20.00	5704 38.800
30.500	6.00	18.00	5704 30.500	38.900	7.00	20.00	5704 38.900
30.600	6.00	18.00	5704 30.600	39.000	7.00	20.00	5704 39.000
30.700	6.00	18.00	5704 30.700	39.100	7.00	20.00	5704 39.100
30.800	6.00	18.00	5704 30.800	39.200	7.00	20.00	5704 39.200
30.900	6.00	18.00	5704 30.900	39.300	7.00	20.00	5704 39.300
31.000	6.00	18.00	5704 31.000	39.400	7.00	20.00	5704 39.400
31.100	6.00	18.00	5704 31.100	39.500	7.00	20.00	5704 39.500
31.200	6.00	18.00	5704 31.200	39.600	7.00	20.00	5704 39.600
31.300	6.00	18.00	5704 31.300	39.700	7.00	20.00	5704 39.700
31.400	6.00	18.00	5704 31.400	39.800	7.00	20.00	5704 39.800
31.500	6.00	18.00	5704 31.500	39.900	7.00	20.00	5704 39.900
31.600	6.00	18.00	5704 31.600	40.000	7.00	20.00	5704 40.000
31.700	6.00	18.00	5704 31.700	40.100	4.00	15.00	5704 40.100
31.800	6.00	18.00	5704 31.800	40.200	4.00	15.00	5704 40.200
31.900	6.00	18.00	5704 31.900	40.300	4.00	15.00	5704 40.300
32.000	6.00	18.00	5704 32.000	40.400	4.00	15.00	5704 40.400
32.100	6.00	18.00	5704 32.100	40.500	4.00	15.00	5704 40.500
32.200	6.00	18.00	5704 32.200	40.600	4.00	15.00	5704 40.600
32.300	6.00	18.00	5704 32.300	40.700	4.00	15.00	5704 40.700
32.400	6.00	18.00	5704 32.400	40.800	4.00	15.00	5704 40.800
32.500	6.00	18.00	5704 32.500	40.900	4.00	15.00	5704 40.900
32.600	6.00	18.00	5704 32.600	41.000	4.00	15.00	5704 41.000
32.700	6.00	18.00	5704 32.700	41.100	4.00	15.00	5704 41.100
32.800	6.00	18.00	5704 32.800	41.200	4.00	15.00	5704 41.200
32.900	6.00	18.00	5704 32.900	41.300	4.00	15.00	5704 41.300
33.000	6.00	18.00	5704 33.000	41.400	4.00	15.00	5704 41.400
33.100	6.00	18.00	5704 33.100	41.500	4.00	15.00	5704 41.500
33.200	6.00	18.00	5704 33.200	41.600	4.00	15.00	5704 41.600
33.300	6.00	18.00	5704 33.300	41.700	4.00	15.00	5704 41.700
33.400	6.00	18.00	5704 33.400	41.800	4.00	15.00	5704 41.800



Article no.			5704	Article no.			5704
d1 mm	b mm	l1 mm	Order no.	d1 mm	b mm	l1 mm	Order no.
41.900	4.00	15.00	5704 41.900	47.300	5.00	16.00	5704 47.300
42.000	4.00	15.00	5704 42.000	47.400	5.00	16.00	5704 47.400
42.100	4.00	15.00	5704 42.100	47.500	5.00	16.00	5704 47.500
42.200	4.00	15.00	5704 42.200	47.600	5.00	16.00	5704 47.600
42.300	4.00	15.00	5704 42.300	47.700	5.00	16.00	5704 47.700
42.400	4.00	15.00	5704 42.400	47.800	5.00	16.00	5704 47.800
42.500	4.00	15.00	5704 42.500	47.900	5.00	16.00	5704 47.900
42.600	4.00	15.00	5704 42.600	48.000	6.00	18.00	5704 48.000
42.700	4.00	15.00	5704 42.700	48.100	6.00	18.00	5704 48.100
42.800	4.00	15.00	5704 42.800	48.200	6.00	18.00	5704 48.200
42.900	4.00	15.00	5704 42.900	48.300	6.00	18.00	5704 48.300
43.000	4.00	15.00	5704 43.000	48.400	6.00	18.00	5704 48.400
43.100	4.00	15.00	5704 43.100	48.500	6.00	18.00	5704 48.500
43.200	4.00	15.00	5704 43.200	48.600	6.00	18.00	5704 48.600
43.300	4.00	15.00	5704 43.300	48.700	6.00	18.00	5704 48.700
43.400	4.00	15.00	5704 43.400	48.800	6.00	18.00	5704 48.800
43.500	4.00	15.00	5704 43.500	48.900	6.00	18.00	5704 48.900
43.600	4.00	15.00	5704 43.600	49.000	6.00	18.00	5704 49.000
43.700	4.00	15.00	5704 43.700	49.100	6.00	18.00	5704 49.100
43.800	4.00	15.00	5704 43.800	49.200	6.00	18.00	5704 49.200
43.900	4.00	15.00	5704 43.900	49.300	6.00	18.00	5704 49.300
44.000	5.00	16.00	5704 44.000	49.400	6.00	18.00	5704 49.400
44.100	5.00	16.00	5704 44.100	49.500	6.00	18.00	5704 49.500
44.200	5.00	16.00	5704 44.200	49.600	6.00	18.00	5704 49.600
44.300	5.00	16.00	5704 44.300	49.700	6.00	18.00	5704 49.700
44.400	5.00	16.00	5704 44.400	49.800	6.00	18.00	5704 49.800
44.500	5.00	16.00	5704 44.500	49.900	6.00	18.00	5704 49.900
44.600	5.00	16.00	5704 44.600	50.000	6.00	18.00	5704 50.000
44.700	5.00	16.00	5704 44.700	50.100	6.00	18.00	5704 50.100
44.800	5.00	16.00	5704 44.800	50.200	6.00	18.00	5704 50.200
44.900	5.00	16.00	5704 44.900	50.300	6.00	18.00	5704 50.300
45.000	5.00	16.00	5704 45.000	50.400	6.00	18.00	5704 50.400
45.100	5.00	16.00	5704 45.100	50.500	6.00	18.00	5704 50.500
45.200	5.00	16.00	5704 45.200	50.600	6.00	18.00	5704 50.600
45.300	5.00	16.00	5704 45.300	50.700	6.00	18.00	5704 50.700
45.400	5.00	16.00	5704 45.400	50.800	6.00	18.00	5704 50.800
45.500	5.00	16.00	5704 45.500	50.900	6.00	18.00	5704 50.900
45.600	5.00	16.00	5704 45.600	51.000	6.00	18.00	5704 51.000
45.700	5.00	16.00	5704 45.700	51.100	6.00	18.00	5704 51.100
45.800	5.00	16.00	5704 45.800	51.200	6.00	18.00	5704 51.200
45.900	5.00	16.00	5704 45.900	51.300	6.00	18.00	5704 51.300
46.000	5.00	16.00	5704 46.000	51.400	6.00	18.00	5704 51.400
46.100	5.00	16.00	5704 46.100	51.500	6.00	18.00	5704 51.500
46.200	5.00	16.00	5704 46.200	51.600	6.00	18.00	5704 51.600
46.300	5.00	16.00	5704 46.300	51.700	6.00	18.00	5704 51.700
46.400	5.00	16.00	5704 46.400	51.800	6.00	18.00	5704 51.800
46.500	5.00	16.00	5704 46.500	51.900	6.00	18.00	5704 51.900
46.600	5.00	16.00	5704 46.600	52.000	6.00	18.00	5704 52.000
46.700	5.00	16.00	5704 46.700				
46.800	5.00	16.00	5704 46.800				
46.900	5.00	16.00	5704 46.900				
47.000	5.00	16.00	5704 47.000				
47.100	5.00	16.00	5704 47.100				
47.200	5.00	16.00	5704 47.200				



Outer inserts for single-fluted gun drills EB 800

Article no. **5706**



Cutting data page 440

P	M	K	N	S	H
○	●	○	○	●	○

interchangeable insert with 1 cutting edge • observe tightening torques • order torque wrench set art. no. 4966 separately

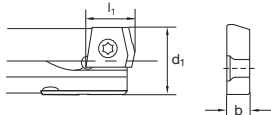

			Article no.	5706				Article no.	5706
d1	b	l1		Order no.	d1	b	l1		Order no.
mm	mm	mm			mm	mm	mm		
12.000	2.80	10.00		5706 12.000	18.600	3.00	12.00		5706 18.600
12.100	2.80	10.00		5706 12.100	18.700	3.00	12.00		5706 18.700
12.200	2.80	10.00		5706 12.200	18.800	3.00	12.00		5706 18.800
12.300	2.80	10.00		5706 12.300	18.900	3.00	12.00		5706 18.900
12.400	2.80	10.00		5706 12.400	19.000	3.00	12.00		5706 19.000
12.500	2.80	10.00		5706 12.500	19.050	3.00	12.00		5706 19.050
12.600	2.80	10.00		5706 12.600	19.100	3.00	12.00		5706 19.100
12.700	2.80	10.00		5706 12.700	19.200	3.00	12.00		5706 19.200
12.800	2.80	10.00		5706 12.800	19.300	3.00	12.00		5706 19.300
12.900	2.80	10.00		5706 12.900	19.400	3.00	12.00		5706 19.400
13.000	2.80	10.00		5706 13.000	19.500	3.00	12.00		5706 19.500
13.100	2.80	10.00		5706 13.100	19.600	3.00	12.00		5706 19.600
13.200	2.80	10.00		5706 13.200	19.700	3.00	12.00		5706 19.700
13.300	2.80	10.00		5706 13.300	19.800	3.00	12.00		5706 19.800
13.400	2.80	10.00		5706 13.400	19.900	3.00	12.00		5706 19.900
13.500	2.80	10.00		5706 13.500	20.000	4.00	15.00		5706 20.000
13.600	2.80	10.00		5706 13.600	20.100	4.00	15.00		5706 20.100
13.700	2.80	10.00		5706 13.700	20.200	4.00	15.00		5706 20.200
13.800	2.80	10.00		5706 13.800	20.300	4.00	15.00		5706 20.300
13.900	2.80	10.00		5706 13.900	20.400	4.00	15.00		5706 20.400
14.000	2.80	10.00		5706 14.000	20.500	4.00	15.00		5706 20.500
14.100	2.80	10.00		5706 14.100	20.600	4.00	15.00		5706 20.600
14.200	2.80	10.00		5706 14.200	20.700	4.00	15.00		5706 20.700
14.300	2.80	10.00		5706 14.300	20.800	4.00	15.00		5706 20.800
14.400	2.80	10.00		5706 14.400	20.900	4.00	15.00		5706 20.900
14.500	2.80	10.00		5706 14.500	21.000	4.00	15.00		5706 21.000
14.600	2.80	10.00		5706 14.600	21.100	4.00	15.00		5706 21.100
14.700	2.80	10.00		5706 14.700	21.200	4.00	15.00		5706 21.200
14.800	2.80	10.00		5706 14.800	21.300	4.00	15.00		5706 21.300
14.900	2.80	10.00		5706 14.900	21.400	4.00	15.00		5706 21.400
15.000	2.80	10.00		5706 15.000	21.500	4.00	15.00		5706 21.500
15.100	2.80	10.00		5706 15.100	21.600	4.00	15.00		5706 21.600
15.200	2.80	10.00		5706 15.200	21.700	4.00	15.00		5706 21.700
15.300	2.80	10.00		5706 15.300	21.800	4.00	15.00		5706 21.800
15.400	2.80	10.00		5706 15.400	21.900	4.00	15.00		5706 21.900
15.500	2.80	10.00		5706 15.500	22.000	4.00	15.00		5706 22.000
15.600	2.80	10.00		5706 15.600	22.100	4.00	15.00		5706 22.100
15.700	2.80	10.00		5706 15.700	22.200	4.00	15.00		5706 22.200
15.800	2.80	10.00		5706 15.800	22.300	4.00	15.00		5706 22.300
15.900	2.80	10.00		5706 15.900	22.400	4.00	15.00		5706 22.400
16.000	3.00	12.00		5706 16.000	22.500	4.00	15.00		5706 22.500
16.100	3.00	12.00		5706 16.100	22.600	4.00	15.00		5706 22.600
16.200	3.00	12.00		5706 16.200	22.700	4.00	15.00		5706 22.700
16.300	3.00	12.00		5706 16.300	22.800	4.00	15.00		5706 22.800
16.400	3.00	12.00		5706 16.400	22.900	4.00	15.00		5706 22.900
16.500	3.00	12.00		5706 16.500	23.000	4.00	15.00		5706 23.000
16.600	3.00	12.00		5706 16.600	23.100	4.00	15.00		5706 23.100
16.700	3.00	12.00		5706 16.700	23.200	4.00	15.00		5706 23.200
16.800	3.00	12.00		5706 16.800	23.300	4.00	15.00		5706 23.300
16.900	3.00	12.00		5706 16.900	23.400	4.00	15.00		5706 23.400
17.000	3.00	12.00		5706 17.000	23.500	4.00	15.00		5706 23.500
17.100	3.00	12.00		5706 17.100	23.600	4.00	15.00		5706 23.600
17.200	3.00	12.00		5706 17.200	23.700	4.00	15.00		5706 23.700
17.300	3.00	12.00		5706 17.300	23.800	4.00	15.00		5706 23.800
17.400	3.00	12.00		5706 17.400	23.900	4.00	15.00		5706 23.900
17.500	3.00	12.00		5706 17.500	24.000	4.00	15.00		5706 24.000
17.600	3.00	12.00		5706 17.600	24.100	4.00	15.00		5706 24.100
17.700	3.00	12.00		5706 17.700	24.200	4.00	15.00		5706 24.200
17.800	3.00	12.00		5706 17.800	24.300	4.00	15.00		5706 24.300
17.900	3.00	12.00		5706 17.900	24.400	4.00	15.00		5706 24.400
18.000	3.00	12.00		5706 18.000	24.500	4.00	15.00		5706 24.500
18.100	3.00	12.00		5706 18.100	24.600	4.00	15.00		5706 24.600
18.200	3.00	12.00		5706 18.200	24.700	4.00	15.00		5706 24.700
18.300	3.00	12.00		5706 18.300	24.800	4.00	15.00		5706 24.800
18.400	3.00	12.00		5706 18.400	24.900	4.00	15.00		5706 24.900
18.500	3.00	12.00		5706 18.500	25.000	4.00	15.00		5706 25.000



Article no.			5706	Article no.			5706
d1 mm	b mm	l1 mm	Order no.	d1 mm	b mm	l1 mm	Order no.
25.100	4.00	15.00	5706 25.100	33.500	6.00	18.00	5706 33.500
25.200	4.00	15.00	5706 25.200	33.600	6.00	18.00	5706 33.600
25.300	4.00	15.00	5706 25.300	33.700	6.00	18.00	5706 33.700
25.400	4.00	15.00	5706 25.400	33.800	6.00	18.00	5706 33.800
25.500	4.00	15.00	5706 25.500	33.900	6.00	18.00	5706 33.900
25.600	4.00	15.00	5706 25.600	34.000	6.50	19.00	5706 34.000
25.700	4.00	15.00	5706 25.700	34.100	6.50	19.00	5706 34.100
25.800	4.00	15.00	5706 25.800	34.200	6.50	19.00	5706 34.200
25.900	4.00	15.00	5706 25.900	34.300	6.50	19.00	5706 34.300
26.000	5.00	16.00	5706 26.000	34.400	6.50	19.00	5706 34.400
26.100	5.00	16.00	5706 26.100	34.500	6.50	19.00	5706 34.500
26.200	5.00	16.00	5706 26.200	34.600	6.50	19.00	5706 34.600
26.300	5.00	16.00	5706 26.300	34.700	6.50	19.00	5706 34.700
26.400	5.00	16.00	5706 26.400	34.800	6.50	19.00	5706 34.800
26.500	5.00	16.00	5706 26.500	34.900	6.50	19.00	5706 34.900
26.600	5.00	16.00	5706 26.600	35.000	6.50	19.00	5706 35.000
26.700	5.00	16.00	5706 26.700	35.100	6.50	19.00	5706 35.100
26.800	5.00	16.00	5706 26.800	35.200	6.50	19.00	5706 35.200
26.900	5.00	16.00	5706 26.900	35.300	6.50	19.00	5706 35.300
27.000	5.00	16.00	5706 27.000	35.400	6.50	19.00	5706 35.400
27.100	5.00	16.00	5706 27.100	35.500	6.50	19.00	5706 35.500
27.200	5.00	16.00	5706 27.200	35.600	6.50	19.00	5706 35.600
27.300	5.00	16.00	5706 27.300	35.700	6.50	19.00	5706 35.700
27.400	5.00	16.00	5706 27.400	35.800	6.50	19.00	5706 35.800
27.500	5.00	16.00	5706 27.500	35.900	6.50	19.00	5706 35.900
27.600	5.00	16.00	5706 27.600	36.000	6.50	19.00	5706 36.000
27.700	5.00	16.00	5706 27.700	36.100	6.50	19.00	5706 36.100
27.800	5.00	16.00	5706 27.800	36.200	6.50	19.00	5706 36.200
27.900	5.00	16.00	5706 27.900	36.300	6.50	19.00	5706 36.300
28.000	5.00	16.00	5706 28.000	36.400	6.50	19.00	5706 36.400
28.100	5.00	16.00	5706 28.100	36.500	6.50	19.00	5706 36.500
28.200	5.00	16.00	5706 28.200	36.600	6.50	19.00	5706 36.600
28.300	5.00	16.00	5706 28.300	36.700	6.50	19.00	5706 36.700
28.400	5.00	16.00	5706 28.400	36.800	6.50	19.00	5706 36.800
28.500	5.00	16.00	5706 28.500	36.900	6.50	19.00	5706 36.900
28.600	5.00	16.00	5706 28.600	37.000	6.50	19.00	5706 37.000
28.700	5.00	16.00	5706 28.700	37.100	6.50	19.00	5706 37.100
28.800	5.00	16.00	5706 28.800	37.200	6.50	19.00	5706 37.200
28.900	5.00	16.00	5706 28.900	37.300	6.50	19.00	5706 37.300
29.000	5.00	16.00	5706 29.000	37.400	6.50	19.00	5706 37.400
29.100	5.00	16.00	5706 29.100	37.500	6.50	19.00	5706 37.500
29.200	5.00	16.00	5706 29.200	37.600	6.50	19.00	5706 37.600
29.300	5.00	16.00	5706 29.300	37.700	6.50	19.00	5706 37.700
29.400	5.00	16.00	5706 29.400	37.800	6.50	19.00	5706 37.800
29.500	5.00	16.00	5706 29.500	37.900	6.50	19.00	5706 37.900
29.600	5.00	16.00	5706 29.600	38.000	7.00	20.00	5706 38.000
29.700	5.00	16.00	5706 29.700	38.100	7.00	20.00	5706 38.100
29.800	5.00	16.00	5706 29.800	38.200	7.00	20.00	5706 38.200
29.900	5.00	16.00	5706 29.900	38.300	7.00	20.00	5706 38.300
30.000	6.00	18.00	5706 30.000	38.400	7.00	20.00	5706 38.400
30.100	6.00	18.00	5706 30.100	38.500	7.00	20.00	5706 38.500
30.200	6.00	18.00	5706 30.200	38.600	7.00	20.00	5706 38.600
30.300	6.00	18.00	5706 30.300	38.700	7.00	20.00	5706 38.700
30.400	6.00	18.00	5706 30.400	38.800	7.00	20.00	5706 38.800
30.500	6.00	18.00	5706 30.500	38.900	7.00	20.00	5706 38.900
30.600	6.00	18.00	5706 30.600	39.000	7.00	20.00	5706 39.000
30.700	6.00	18.00	5706 30.700	39.100	7.00	20.00	5706 39.100
30.800	6.00	18.00	5706 30.800	39.200	7.00	20.00	5706 39.200
30.900	6.00	18.00	5706 30.900	39.300	7.00	20.00	5706 39.300
31.000	6.00	18.00	5706 31.000	39.400	7.00	20.00	5706 39.400
31.100	6.00	18.00	5706 31.100	39.500	7.00	20.00	5706 39.500
31.200	6.00	18.00	5706 31.200	39.600	7.00	20.00	5706 39.600
31.300	6.00	18.00	5706 31.300	39.700	7.00	20.00	5706 39.700
31.400	6.00	18.00	5706 31.400	39.800	7.00	20.00	5706 39.800
31.500	6.00	18.00	5706 31.500	39.900	7.00	20.00	5706 39.900
31.600	6.00	18.00	5706 31.600	40.000	7.00	20.00	5706 40.000
31.700	6.00	18.00	5706 31.700	40.100	4.00	15.00	5706 40.100
31.800	6.00	18.00	5706 31.800	40.200	4.00	15.00	5706 40.200
31.900	6.00	18.00	5706 31.900	40.300	4.00	15.00	5706 40.300
32.000	6.00	18.00	5706 32.000	40.400	4.00	15.00	5706 40.400
32.100	6.00	18.00	5706 32.100	40.500	4.00	15.00	5706 40.500
32.200	6.00	18.00	5706 32.200	40.600	4.00	15.00	5706 40.600
32.300	6.00	18.00	5706 32.300	40.700	4.00	15.00	5706 40.700
32.400	6.00	18.00	5706 32.400	40.800	4.00	15.00	5706 40.800
32.500	6.00	18.00	5706 32.500	40.900	4.00	15.00	5706 40.900
32.600	6.00	18.00	5706 32.600	41.000	4.00	15.00	5706 41.000
32.700	6.00	18.00	5706 32.700	41.100	4.00	15.00	5706 41.100
32.800	6.00	18.00	5706 32.800	41.200	4.00	15.00	5706 41.200
32.900	6.00	18.00	5706 32.900	41.300	4.00	15.00	5706 41.300
33.000	6.00	18.00	5706 33.000	41.400	4.00	15.00	5706 41.400
33.100	6.00	18.00	5706 33.100	41.500	4.00	15.00	5706 41.500
33.200	6.00	18.00	5706 33.200	41.600	4.00	15.00	5706 41.600
33.300	6.00	18.00	5706 33.300	41.700	4.00	15.00	5706 41.700
33.400	6.00	18.00	5706 33.400	41.800	4.00	15.00	5706 41.800



Modular single-fluted gun drills

Deep hole drills

			Article no.	5706				Article no.	5706
d1 mm	b mm	l1 mm		Order no.	d1 mm	b mm	l1 mm		Order no.
41.900	4.00	15.00		5706 41.900	47.300	5.00	16.00		5706 47.300
42.000	4.00	15.00		5706 42.000	47.400	5.00	16.00		5706 47.400
42.100	4.00	15.00		5706 42.100	47.500	5.00	16.00		5706 47.500
42.200	4.00	15.00		5706 42.200	47.600	5.00	16.00		5706 47.600
42.300	4.00	15.00		5706 42.300	47.700	5.00	16.00		5706 47.700
42.400	4.00	15.00		5706 42.400	47.800	5.00	16.00		5706 47.800
42.500	4.00	15.00		5706 42.500	47.900	5.00	16.00		5706 47.900
42.600	4.00	15.00		5706 42.600	48.000	6.00	18.00		5706 48.000
42.700	4.00	15.00		5706 42.700	48.100	6.00	18.00		5706 48.100
42.800	4.00	15.00		5706 42.800	48.200	6.00	18.00		5706 48.200
42.900	4.00	15.00		5706 42.900	48.300	6.00	18.00		5706 48.300
43.000	4.00	15.00		5706 43.000	48.400	6.00	18.00		5706 48.400
43.100	4.00	15.00		5706 43.100	48.500	6.00	18.00		5706 48.500
43.200	4.00	15.00		5706 43.200	48.600	6.00	18.00		5706 48.600
43.300	4.00	15.00		5706 43.300	48.700	6.00	18.00		5706 48.700
43.400	4.00	15.00		5706 43.400	48.800	6.00	18.00		5706 48.800
43.500	4.00	15.00		5706 43.500	48.900	6.00	18.00		5706 48.900
43.600	4.00	15.00		5706 43.600	49.000	6.00	18.00		5706 49.000
43.700	4.00	15.00		5706 43.700	49.100	6.00	18.00		5706 49.100
43.800	4.00	15.00		5706 43.800	49.200	6.00	18.00		5706 49.200
43.900	4.00	15.00		5706 43.900	49.300	6.00	18.00		5706 49.300
44.000	5.00	16.00		5706 44.000	49.400	6.00	18.00		5706 49.400
44.100	5.00	16.00		5706 44.100	49.500	6.00	18.00		5706 49.500
44.200	5.00	16.00		5706 44.200	49.600	6.00	18.00		5706 49.600
44.300	5.00	16.00		5706 44.300	49.700	6.00	18.00		5706 49.700
44.400	5.00	16.00		5706 44.400	49.800	6.00	18.00		5706 49.800
44.500	5.00	16.00		5706 44.500	49.900	6.00	18.00		5706 49.900
44.600	5.00	16.00		5706 44.600	50.000	6.00	18.00		5706 50.000
44.700	5.00	16.00		5706 44.700	50.100	6.00	18.00		5706 50.100
44.800	5.00	16.00		5706 44.800	50.200	6.00	18.00		5706 50.200
44.900	5.00	16.00		5706 44.900	50.300	6.00	18.00		5706 50.300
45.000	5.00	16.00		5706 45.000	50.400	6.00	18.00		5706 50.400
45.100	5.00	16.00		5706 45.100	50.500	6.00	18.00		5706 50.500
45.200	5.00	16.00		5706 45.200	50.600	6.00	18.00		5706 50.600
45.300	5.00	16.00		5706 45.300	50.700	6.00	18.00		5706 50.700
45.400	5.00	16.00		5706 45.400	50.800	6.00	18.00		5706 50.800
45.500	5.00	16.00		5706 45.500	50.900	6.00	18.00		5706 50.900
45.600	5.00	16.00		5706 45.600	51.000	6.00	18.00		5706 51.000
45.700	5.00	16.00		5706 45.700	51.100	6.00	18.00		5706 51.100
45.800	5.00	16.00		5706 45.800	51.200	6.00	18.00		5706 51.200
45.900	5.00	16.00		5706 45.900	51.300	6.00	18.00		5706 51.300
46.000	5.00	16.00		5706 46.000	51.400	6.00	18.00		5706 51.400
46.100	5.00	16.00		5706 46.100	51.500	6.00	18.00		5706 51.500
46.200	5.00	16.00		5706 46.200	51.600	6.00	18.00		5706 51.600
46.300	5.00	16.00		5706 46.300	51.700	6.00	18.00		5706 51.700
46.400	5.00	16.00		5706 46.400	51.800	6.00	18.00		5706 51.800
46.500	5.00	16.00		5706 46.500	51.900	6.00	18.00		5706 51.900
46.600	5.00	16.00		5706 46.600	52.000	6.00	18.00		5706 52.000
46.700	5.00	16.00		5706 46.700					
46.800	5.00	16.00		5706 46.800					
46.900	5.00	16.00		5706 46.900					
47.000	5.00	16.00		5706 47.000					
47.100	5.00	16.00		5706 47.100					
47.200	5.00	16.00		5706 47.200					



Guide pads for single-fluted gun drills EB 800

Article no. 5030



Cutting data page 440



interchangeable guide pad • observe tightening torques • order torque wrench set art. no. 4966 separately

Deep hole drills

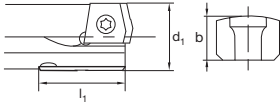

Article no. 5030			Article no. 5030				
d1 mm	b mm	l1 mm	Order no.	d1 mm	b mm	l1 mm	Order no.
12.000	2.15	19.95	5030 12.000	18.600	2.90	20.00	5030 18.600
12.100	2.20	19.95	5030 12.100	18.700	2.95	20.00	5030 18.700
12.200	2.25	19.95	5030 12.200	18.800	3.00	20.00	5030 18.800
12.300	2.30	19.95	5030 12.300	18.900	3.05	20.00	5030 18.900
12.400	2.35	19.95	5030 12.400	19.000	2.85	20.00	5030 19.000
12.500	2.15	19.95	5030 12.500	19.050	2.87	20.00	5030 19.050
12.600	2.20	19.95	5030 12.600	19.100	2.90	20.00	5030 19.100
12.700	2.25	19.95	5030 12.700	19.200	2.95	20.00	5030 19.200
12.800	2.30	19.95	5030 12.800	19.300	3.00	20.00	5030 19.300
12.900	2.35	19.95	5030 12.900	19.400	3.05	20.00	5030 19.400
13.000	2.15	19.95	5030 13.000	19.500	2.85	20.00	5030 19.500
13.100	2.20	19.95	5030 13.100	19.600	2.90	20.00	5030 19.600
13.200	2.25	19.95	5030 13.200	19.700	2.95	20.00	5030 19.700
13.300	2.30	19.95	5030 13.300	19.800	3.00	20.00	5030 19.800
13.400	2.35	19.95	5030 13.400	19.900	3.05	20.00	5030 19.900
13.500	2.15	19.95	5030 13.500	20.000	3.35	25.00	5030 20.000
13.600	2.20	19.95	5030 13.600	20.100	3.40	25.00	5030 20.100
13.700	2.25	19.95	5030 13.700	20.200	3.45	25.00	5030 20.200
13.800	2.30	19.95	5030 13.800	20.300	3.50	25.00	5030 20.300
13.900	2.35	19.95	5030 13.900	20.400	3.55	25.00	5030 20.400
14.000	2.15	19.95	5030 14.000	20.500	3.35	25.00	5030 20.500
14.100	2.20	19.95	5030 14.100	20.600	3.40	25.00	5030 20.600
14.200	2.25	19.95	5030 14.200	20.700	3.45	25.00	5030 20.700
14.300	2.30	19.95	5030 14.300	20.800	3.50	25.00	5030 20.800
14.400	2.35	19.95	5030 14.400	20.900	3.55	25.00	5030 20.900
14.500	2.15	19.95	5030 14.500	21.000	3.35	25.00	5030 21.000
14.600	2.20	19.95	5030 14.600	21.100	3.40	25.00	5030 21.100
14.700	2.25	19.95	5030 14.700	21.200	3.45	25.00	5030 21.200
14.800	2.30	19.95	5030 14.800	21.300	3.50	25.00	5030 21.300
14.900	2.35	19.95	5030 14.900	21.400	3.55	25.00	5030 21.400
15.000	2.15	19.95	5030 15.000	21.500	3.35	25.00	5030 21.500
15.100	2.20	19.95	5030 15.100	21.600	3.40	25.00	5030 21.600
15.200	2.25	19.95	5030 15.200	21.700	3.45	25.00	5030 21.700
15.300	2.30	19.95	5030 15.300	21.800	3.50	25.00	5030 21.800
15.400	2.35	19.95	5030 15.400	21.900	3.55	25.00	5030 21.900
15.500	2.15	19.95	5030 15.500	22.000	3.35	25.00	5030 22.000
15.600	2.20	19.95	5030 15.600	22.100	3.40	25.00	5030 22.100
15.700	2.25	19.95	5030 15.700	22.200	3.45	25.00	5030 22.200
15.800	2.30	19.95	5030 15.800	22.300	3.50	25.00	5030 22.300
15.900	2.35	19.95	5030 15.900	22.400	3.55	25.00	5030 22.400
16.000	2.85	20.00	5030 16.000	22.500	3.35	25.00	5030 22.500
16.100	2.90	20.00	5030 16.100	22.600	3.40	25.00	5030 22.600
16.200	2.95	20.00	5030 16.200	22.700	3.45	25.00	5030 22.700
16.300	3.00	20.00	5030 16.300	22.800	3.50	25.00	5030 22.800
16.400	3.05	20.00	5030 16.400	22.900	3.55	25.00	5030 22.900
16.500	2.85	20.00	5030 16.500	23.000	3.35	25.00	5030 23.000
16.600	2.90	20.00	5030 16.600	23.100	3.40	25.00	5030 23.100
16.700	2.95	20.00	5030 16.700	23.200	3.45	25.00	5030 23.200
16.800	3.00	20.00	5030 16.800	23.300	3.50	25.00	5030 23.300
16.900	3.05	20.00	5030 16.900	23.400	3.55	25.00	5030 23.400
17.000	2.85	20.00	5030 17.000	23.500	3.35	25.00	5030 23.500
17.100	2.90	20.00	5030 17.100	23.600	3.40	25.00	5030 23.600
17.200	2.95	20.00	5030 17.200	23.700	3.45	25.00	5030 23.700
17.300	3.00	20.00	5030 17.300	23.800	3.50	25.00	5030 23.800
17.400	3.05	20.00	5030 17.400	23.900	3.55	25.00	5030 23.900
17.500	2.85	20.00	5030 17.500	24.000	3.35	25.00	5030 24.000
17.600	2.90	20.00	5030 17.600	24.100	3.40	25.00	5030 24.100
17.700	2.95	20.00	5030 17.700	24.200	3.45	25.00	5030 24.200
17.800	3.00	20.00	5030 17.800	24.300	3.50	25.00	5030 24.300
17.900	3.05	20.00	5030 17.900	24.400	3.55	25.00	5030 24.400
18.000	2.85	20.00	5030 18.000	24.500	3.35	25.00	5030 24.500
18.100	2.90	20.00	5030 18.100	24.600	3.40	25.00	5030 24.600
18.200	2.95	20.00	5030 18.200	24.700	3.45	25.00	5030 24.700
18.300	3.00	20.00	5030 18.300	24.800	3.50	25.00	5030 24.800
18.400	3.05	20.00	5030 18.400	24.900	3.55	25.00	5030 24.900
18.500	2.85	20.00	5030 18.500	25.000	3.35	25.00	5030 25.000



Modular single-fluted gun drills

Deep hole drills

Article no.			5030	Article no.			5030
d1 mm	b mm	l1 mm	Order no.	d1 mm	b mm	l1 mm	Order no.
25.100	3.40	25.00	5030 25.100	33.500	4.35	30.00	5030 33.500
25.200	3.45	25.00	5030 25.200	33.600	4.40	30.00	5030 33.600
25.300	3.50	25.00	5030 25.300	33.700	4.45	30.00	5030 33.700
25.400	3.55	25.00	5030 25.400	33.800	4.50	30.00	5030 33.800
25.500	3.35	25.00	5030 25.500	33.900	4.55	30.00	5030 33.900
25.600	3.40	25.00	5030 25.600	34.000	4.85	30.00	5030 34.000
25.700	3.45	25.00	5030 25.700	34.100	4.90	30.00	5030 34.100
25.800	3.50	25.00	5030 25.800	34.200	4.95	30.00	5030 34.200
25.900	3.55	25.00	5030 25.900	34.300	5.00	30.00	5030 34.300
26.000	3.85	25.00	5030 26.000	34.400	5.05	30.00	5030 34.400
26.100	3.90	25.00	5030 26.100	34.500	4.85	30.00	5030 34.500
26.200	3.95	25.00	5030 26.200	34.600	4.90	30.00	5030 34.600
26.300	4.00	25.00	5030 26.300	34.700	4.95	30.00	5030 34.700
26.400	4.05	25.00	5030 26.400	34.800	5.00	30.00	5030 34.800
26.500	3.85	25.00	5030 26.500	34.900	5.05	30.00	5030 34.900
26.600	3.90	25.00	5030 26.600	35.000	4.85	30.00	5030 35.000
26.700	3.95	25.00	5030 26.700	35.100	4.90	30.00	5030 35.100
26.800	4.00	25.00	5030 26.800	35.200	4.95	30.00	5030 35.200
26.900	4.05	25.00	5030 26.900	35.300	5.00	30.00	5030 35.300
27.000	3.85	25.00	5030 27.000	35.400	5.05	30.00	5030 35.400
27.100	3.90	25.00	5030 27.100	35.500	4.85	30.00	5030 35.500
27.200	3.95	25.00	5030 27.200	35.600	4.90	30.00	5030 35.600
27.300	4.00	25.00	5030 27.300	35.700	4.95	30.00	5030 35.700
27.400	4.05	25.00	5030 27.400	35.800	5.00	30.00	5030 35.800
27.500	3.85	25.00	5030 27.500	35.900	5.05	30.00	5030 35.900
27.600	3.90	25.00	5030 27.600	36.000	4.85	30.00	5030 36.000
27.700	3.95	25.00	5030 27.700	36.100	4.90	30.00	5030 36.100
27.800	4.00	25.00	5030 27.800	36.200	4.95	30.00	5030 36.200
27.900	4.05	25.00	5030 27.900	36.300	5.00	30.00	5030 36.300
28.000	3.85	25.00	5030 28.000	36.400	5.05	30.00	5030 36.400
28.100	3.90	25.00	5030 28.100	36.500	4.85	30.00	5030 36.500
28.200	3.95	25.00	5030 28.200	36.600	4.90	30.00	5030 36.600
28.300	4.00	25.00	5030 28.300	36.700	4.95	30.00	5030 36.700
28.400	4.05	25.00	5030 28.400	36.800	5.00	30.00	5030 36.800
28.500	3.85	25.00	5030 28.500	36.900	5.05	30.00	5030 36.900
28.600	3.90	25.00	5030 28.600	37.000	4.85	30.00	5030 37.000
28.700	3.95	25.00	5030 28.700	37.100	4.90	30.00	5030 37.100
28.800	4.00	25.00	5030 28.800	37.200	4.95	30.00	5030 37.200
28.900	4.05	25.00	5030 28.900	37.300	5.00	30.00	5030 37.300
29.000	3.85	25.00	5030 29.000	37.400	5.05	30.00	5030 37.400
29.100	3.90	25.00	5030 29.100	37.500	4.85	30.00	5030 37.500
29.200	3.95	25.00	5030 29.200	37.600	4.90	30.00	5030 37.600
29.300	4.00	25.00	5030 29.300	37.700	4.95	30.00	5030 37.700
29.400	4.05	25.00	5030 29.400	37.800	5.00	30.00	5030 37.800
29.500	3.85	25.00	5030 29.500	37.900	5.05	30.00	5030 37.900
29.600	3.90	25.00	5030 29.600	38.000	5.35	30.00	5030 38.000
29.700	3.95	25.00	5030 29.700	38.100	5.40	30.00	5030 38.100
29.800	4.00	25.00	5030 29.800	38.200	5.45	30.00	5030 38.200
29.900	4.05	25.00	5030 29.900	38.300	5.50	30.00	5030 38.300
30.000	4.35	30.00	5030 30.000	38.400	5.55	30.00	5030 38.400
30.100	4.40	30.00	5030 30.100	38.500	5.35	30.00	5030 38.500
30.200	4.45	30.00	5030 30.200	38.600	5.40	30.00	5030 38.600
30.300	4.50	30.00	5030 30.300	38.700	5.45	30.00	5030 38.700
30.400	4.55	30.00	5030 30.400	38.800	5.50	30.00	5030 38.800
30.500	4.35	30.00	5030 30.500	38.900	5.55	30.00	5030 38.900
30.600	4.40	30.00	5030 30.600	39.000	5.35	30.00	5030 39.000
30.700	4.45	30.00	5030 30.700	39.100	5.40	30.00	5030 39.100
30.800	4.50	30.00	5030 30.800	39.200	5.45	30.00	5030 39.200
30.900	4.55	30.00	5030 30.900	39.300	5.50	30.00	5030 39.300
31.000	4.35	30.00	5030 31.000	39.400	5.55	30.00	5030 39.400
31.100	4.40	30.00	5030 31.100	39.500	5.35	30.00	5030 39.500
31.200	4.45	30.00	5030 31.200	39.600	5.40	30.00	5030 39.600
31.300	4.50	30.00	5030 31.300	39.700	5.45	30.00	5030 39.700
31.400	4.55	30.00	5030 31.400	39.800	5.50	30.00	5030 39.800
31.500	4.35	30.00	5030 31.500	39.900	5.55	30.00	5030 39.900
31.600	4.40	30.00	5030 31.600	40.000	5.60	30.00	5030 40.000
31.700	4.45	30.00	5030 31.700	40.100	5.40	30.00	5030 40.100
31.800	4.50	30.00	5030 31.800	40.200	5.45	30.00	5030 40.200
31.900	4.55	30.00	5030 31.900	40.300	5.50	30.00	5030 40.300
32.000	4.35	30.00	5030 32.000	40.400	5.55	30.00	5030 40.400
32.100	4.40	30.00	5030 32.100	40.500	5.35	30.00	5030 40.500
32.200	4.45	30.00	5030 32.200	40.600	5.40	30.00	5030 40.600
32.300	4.50	30.00	5030 32.300	40.700	5.45	30.00	5030 40.700
32.400	4.55	30.00	5030 32.400	40.800	5.50	30.00	5030 40.800
32.500	4.35	30.00	5030 32.500	40.900	5.55	30.00	5030 40.900
32.600	4.40	30.00	5030 32.600	41.000	5.35	30.00	5030 41.000
32.700	4.45	30.00	5030 32.700	41.100	5.40	30.00	5030 41.100
32.800	4.50	30.00	5030 32.800	41.200	5.45	30.00	5030 41.200
32.900	4.55	30.00	5030 32.900	41.300	5.50	30.00	5030 41.300
33.000	4.35	30.00	5030 33.000	41.400	5.55	30.00	5030 41.400
33.100	4.40	30.00	5030 33.100	41.500	5.35	30.00	5030 41.500
33.200	4.45	30.00	5030 33.200	41.600	5.40	30.00	5030 41.600
33.300	4.50	30.00	5030 33.300	41.700	5.45	30.00	5030 41.700
33.400	4.55	30.00	5030 33.400	41.800	5.50	30.00	5030 41.800



Article no.			5030	Article no.			5030
d1 mm	b mm	l1 mm	Order no.	d1 mm	b mm	l1 mm	Order no.
41.900	5.55	30.00	5030 41.900	47.300	5.50	30.00	5030 47.300
42.000	5.35	30.00	5030 42.000	47.400	5.55	30.00	5030 47.400
42.100	5.40	30.00	5030 42.100	47.500	5.35	30.00	5030 47.500
42.200	5.45	30.00	5030 42.200	47.600	5.40	30.00	5030 47.600
42.300	5.50	30.00	5030 42.300	47.700	5.45	30.00	5030 47.700
42.400	5.55	30.00	5030 42.400	47.800	5.50	30.00	5030 47.800
42.500	5.35	30.00	5030 42.500	47.900	5.55	30.00	5030 47.900
42.600	5.40	30.00	5030 42.600	48.000	5.35	30.00	5030 48.000
42.700	5.45	30.00	5030 42.700	48.100	5.40	30.00	5030 48.100
42.800	5.50	30.00	5030 42.800	48.200	5.45	30.00	5030 48.200
42.900	5.55	30.00	5030 42.900	48.300	5.50	30.00	5030 48.300
43.000	5.35	30.00	5030 43.000	48.400	5.55	30.00	5030 48.400
43.100	5.40	30.00	5030 43.100	48.500	5.35	30.00	5030 48.500
43.200	5.45	30.00	5030 43.200	48.600	5.40	30.00	5030 48.600
43.300	5.50	30.00	5030 43.300	48.700	5.45	30.00	5030 48.700
43.400	5.55	30.00	5030 43.400	48.800	5.50	30.00	5030 48.800
43.500	5.35	30.00	5030 43.500	48.900	5.55	30.00	5030 48.900
43.600	5.40	30.00	5030 43.600	49.000	5.35	30.00	5030 49.000
43.700	5.45	30.00	5030 43.700	49.100	5.40	30.00	5030 49.100
43.800	5.50	30.00	5030 43.800	49.200	5.45	30.00	5030 49.200
43.900	5.55	30.00	5030 43.900	49.300	5.50	30.00	5030 49.300
44.000	5.35	30.00	5030 44.000	49.400	5.55	30.00	5030 49.400
44.100	5.40	30.00	5030 44.100	49.500	5.35	30.00	5030 49.500
44.200	5.45	30.00	5030 44.200	49.600	5.40	30.00	5030 49.600
44.300	5.50	30.00	5030 44.300	49.700	5.45	30.00	5030 49.700
44.400	5.55	30.00	5030 44.400	49.800	5.50	30.00	5030 49.800
44.500	5.35	30.00	5030 44.500	49.900	5.55	30.00	5030 49.900
44.600	5.40	30.00	5030 44.600	50.000	5.35	30.00	5030 50.000
44.700	5.45	30.00	5030 44.700	50.100	5.40	30.00	5030 50.100
44.800	5.50	30.00	5030 44.800	50.200	5.45	30.00	5030 50.200
44.900	5.55	30.00	5030 44.900	50.300	5.50	30.00	5030 50.300
45.000	5.35	30.00	5030 45.000	50.400	5.55	30.00	5030 50.400
45.100	5.40	30.00	5030 45.100	50.500	5.35	30.00	5030 50.500
45.200	5.45	30.00	5030 45.200	50.600	5.40	30.00	5030 50.600
45.300	5.50	30.00	5030 45.300	50.700	5.45	30.00	5030 50.700
45.400	5.55	30.00	5030 45.400	50.800	5.50	30.00	5030 50.800
45.500	5.35	30.00	5030 45.500	50.900	5.55	30.00	5030 50.900
45.600	5.40	30.00	5030 45.600	51.000	5.35	30.00	5030 51.000
45.700	5.45	30.00	5030 45.700	51.100	5.40	30.00	5030 51.100
45.800	5.50	30.00	5030 45.800	51.200	5.45	30.00	5030 51.200
45.900	5.55	30.00	5030 45.900	51.300	5.50	30.00	5030 51.300
46.000	5.35	30.00	5030 46.000	51.400	5.55	30.00	5030 51.400
46.100	5.40	30.00	5030 46.100	51.500	5.35	30.00	5030 51.500
46.200	5.45	30.00	5030 46.200	51.600	5.40	30.00	5030 51.600
46.300	5.50	30.00	5030 46.300	51.700	5.45	30.00	5030 51.700
46.400	5.55	30.00	5030 46.400	51.800	5.50	30.00	5030 51.800
46.500	5.35	30.00	5030 46.500	51.900	5.55	30.00	5030 51.900
46.600	5.40	30.00	5030 46.600	52.000	5.60	30.00	5030 52.000
46.700	5.45	30.00	5030 46.700				
46.800	5.50	30.00	5030 46.800				
46.900	5.55	30.00	5030 46.900				
47.000	5.35	30.00	5030 47.000				
47.100	5.40	30.00	5030 47.100				
47.200	5.45	30.00	5030 47.200				

Deep hole drills



Modular single-fluted gun drills

Deep hole drills

Guide pads for single-fluted gun drills EB 800

Article no. 5703



Cutting data page 440

P	M	K	N	S	H
•	•	•	•	•	○

interchangeable guide pad • observe tightening torques • order torque wrench set art. no. 4966 separately

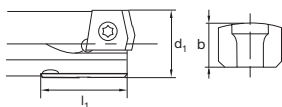

			Article no.	5703				Article no.	5703
d1	b	l1		Order no.	d1	b	l1		Order no.
mm	mm	mm			mm	mm	mm		
12.000	2.15	19.95		5703 12.000	18.600	2.90	20.00		5703 18.600
12.100	2.20	19.95		5703 12.100	18.700	2.95	20.00		5703 18.700
12.200	2.25	19.95		5703 12.200	18.800	3.00	20.00		5703 18.800
12.300	2.30	19.95		5703 12.300	18.900	3.05	20.00		5703 18.900
12.400	2.35	19.95		5703 12.400	19.000	2.85	20.00		5703 19.000
12.500	2.15	19.95		5703 12.500	19.050	2.87	20.00		5703 19.050
12.600	2.20	19.95		5703 12.600	19.100	2.90	20.00		5703 19.100
12.700	2.25	19.95		5703 12.700	19.200	2.95	20.00		5703 19.200
12.800	2.30	19.95		5703 12.800	19.300	3.00	20.00		5703 19.300
12.900	2.35	19.95		5703 12.900	19.400	3.05	20.00		5703 19.400
13.000	2.15	19.95		5703 13.000	19.500	2.85	20.00		5703 19.500
13.100	2.20	19.95		5703 13.100	19.600	2.90	20.00		5703 19.600
13.200	2.25	19.95		5703 13.200	19.700	2.95	20.00		5703 19.700
13.300	2.30	19.95		5703 13.300	19.800	3.00	20.00		5703 19.800
13.400	2.35	19.95		5703 13.400	19.900	3.05	20.00		5703 19.900
13.500	2.15	19.95		5703 13.500	20.000	3.35	25.00		5703 20.000
13.600	2.20	19.95		5703 13.600	20.100	3.40	25.00		5703 20.100
13.700	2.25	19.95		5703 13.700	20.200	3.45	25.00		5703 20.200
13.800	2.30	19.95		5703 13.800	20.300	3.50	25.00		5703 20.300
13.900	2.35	19.95		5703 13.900	20.400	3.55	25.00		5703 20.400
14.000	2.15	19.95		5703 14.000	20.500	3.35	25.00		5703 20.500
14.100	2.20	19.95		5703 14.100	20.600	3.40	25.00		5703 20.600
14.200	2.25	19.95		5703 14.200	20.700	3.45	25.00		5703 20.700
14.300	2.30	19.95		5703 14.300	20.800	3.50	25.00		5703 20.800
14.400	2.35	19.95		5703 14.400	20.900	3.55	25.00		5703 20.900
14.500	2.15	19.95		5703 14.500	21.000	3.35	25.00		5703 21.000
14.600	2.20	19.95		5703 14.600	21.100	3.40	25.00		5703 21.100
14.700	2.25	19.95		5703 14.700	21.200	3.45	25.00		5703 21.200
14.800	2.30	19.95		5703 14.800	21.300	3.50	25.00		5703 21.300
14.900	2.35	19.95		5703 14.900	21.400	3.55	25.00		5703 21.400
15.000	2.15	19.95		5703 15.000	21.500	3.35	25.00		5703 21.500
15.100	2.20	19.95		5703 15.100	21.600	3.40	25.00		5703 21.600
15.200	2.25	19.95		5703 15.200	21.700	3.45	25.00		5703 21.700
15.300	2.30	19.95		5703 15.300	21.800	3.50	25.00		5703 21.800
15.400	2.35	19.95		5703 15.400	21.900	3.55	25.00		5703 21.900
15.500	2.15	19.95		5703 15.500	22.000	3.35	25.00		5703 22.000
15.600	2.20	19.95		5703 15.600	22.100	3.40	25.00		5703 22.100
15.700	2.25	19.95		5703 15.700	22.200	3.45	25.00		5703 22.200
15.800	2.30	19.95		5703 15.800	22.300	3.50	25.00		5703 22.300
15.900	2.35	19.95		5703 15.900	22.400	3.55	25.00		5703 22.400
16.000	2.85	20.00		5703 16.000	22.500	3.35	25.00		5703 22.500
16.100	2.90	20.00		5703 16.100	22.600	3.40	25.00		5703 22.600
16.200	2.95	20.00		5703 16.200	22.700	3.45	25.00		5703 22.700
16.300	3.00	20.00		5703 16.300	22.800	3.50	25.00		5703 22.800
16.400	3.05	20.00		5703 16.400	22.900	3.55	25.00		5703 22.900
16.500	2.85	20.00		5703 16.500	23.000	3.35	25.00		5703 23.000
16.600	2.90	20.00		5703 16.600	23.100	3.40	25.00		5703 23.100
16.700	2.95	20.00		5703 16.700	23.200	3.45	25.00		5703 23.200
16.800	3.00	20.00		5703 16.800	23.300	3.50	25.00		5703 23.300
16.900	3.05	20.00		5703 16.900	23.400	3.55	25.00		5703 23.400
17.000	2.85	20.00		5703 17.000	23.500	3.35	25.00		5703 23.500
17.100	2.90	20.00		5703 17.100	23.600	3.40	25.00		5703 23.600
17.200	2.95	20.00		5703 17.200	23.700	3.45	25.00		5703 23.700
17.300	3.00	20.00		5703 17.300	23.800	3.50	25.00		5703 23.800
17.400	3.05	20.00		5703 17.400	23.900	3.55	25.00		5703 23.900
17.500	2.85	20.00		5703 17.500	24.000	3.35	25.00		5703 24.000
17.600	2.90	20.00		5703 17.600	24.100	3.40	25.00		5703 24.100
17.700	2.95	20.00		5703 17.700	24.200	3.45	25.00		5703 24.200
17.800	3.00	20.00		5703 17.800	24.300	3.50	25.00		5703 24.300
17.900	3.05	20.00		5703 17.900	24.400	3.55	25.00		5703 24.400
18.000	2.85	20.00		5703 18.000	24.500	3.35	25.00		5703 24.500
18.100	2.90	20.00		5703 18.100	24.600	3.40	25.00		5703 24.600
18.200	2.95	20.00		5703 18.200	24.700	3.45	25.00		5703 24.700
18.300	3.00	20.00		5703 18.300	24.800	3.50	25.00		5703 24.800
18.400	3.05	20.00		5703 18.400	24.900	3.55	25.00		5703 24.900
18.500	2.85	20.00		5703 18.500	25.000	3.35	25.00		5703 25.000



Article no.			5703	Article no.			5703
d1 mm	b mm	l1 mm	Order no.	d1 mm	b mm	l1 mm	Order no.
25.100	3.40	25.00	5703 25.100	33.500	4.35	30.00	5703 33.500
25.200	3.45	25.00	5703 25.200	33.600	4.40	30.00	5703 33.600
25.300	3.50	25.00	5703 25.300	33.700	4.45	30.00	5703 33.700
25.400	3.55	25.00	5703 25.400	33.800	4.50	30.00	5703 33.800
25.500	3.35	25.00	5703 25.500	33.900	4.55	30.00	5703 33.900
25.600	3.40	25.00	5703 25.600	34.000	4.85	30.00	5703 34.000
25.700	3.45	25.00	5703 25.700	34.100	4.90	30.00	5703 34.100
25.800	3.50	25.00	5703 25.800	34.200	4.95	30.00	5703 34.200
25.900	3.55	25.00	5703 25.900	34.300	5.00	30.00	5703 34.300
26.000	3.85	25.00	5703 26.000	34.400	5.05	30.00	5703 34.400
26.100	3.90	25.00	5703 26.100	34.500	4.85	30.00	5703 34.500
26.200	3.95	25.00	5703 26.200	34.600	4.90	30.00	5703 34.600
26.300	4.00	25.00	5703 26.300	34.700	4.95	30.00	5703 34.700
26.400	4.05	25.00	5703 26.400	34.800	5.00	30.00	5703 34.800
26.500	3.85	25.00	5703 26.500	34.900	5.05	30.00	5703 34.900
26.600	3.90	25.00	5703 26.600	35.000	4.85	30.00	5703 35.000
26.700	3.95	25.00	5703 26.700	35.100	4.90	30.00	5703 35.100
26.800	4.00	25.00	5703 26.800	35.200	4.95	30.00	5703 35.200
26.900	4.05	25.00	5703 26.900	35.300	5.00	30.00	5703 35.300
27.000	3.85	25.00	5703 27.000	35.400	5.05	30.00	5703 35.400
27.100	3.90	25.00	5703 27.100	35.500	4.85	30.00	5703 35.500
27.200	3.95	25.00	5703 27.200	35.600	4.90	30.00	5703 35.600
27.300	4.00	25.00	5703 27.300	35.700	4.95	30.00	5703 35.700
27.400	4.05	25.00	5703 27.400	35.800	5.00	30.00	5703 35.800
27.500	3.85	25.00	5703 27.500	35.900	5.05	30.00	5703 35.900
27.600	3.90	25.00	5703 27.600	36.000	4.85	30.00	5703 36.000
27.700	3.95	25.00	5703 27.700	36.100	4.90	30.00	5703 36.100
27.800	4.00	25.00	5703 27.800	36.200	4.95	30.00	5703 36.200
27.900	4.05	25.00	5703 27.900	36.300	5.00	30.00	5703 36.300
28.000	3.85	25.00	5703 28.000	36.400	5.05	30.00	5703 36.400
28.100	3.90	25.00	5703 28.100	36.500	4.85	30.00	5703 36.500
28.200	3.95	25.00	5703 28.200	36.600	4.90	30.00	5703 36.600
28.300	4.00	25.00	5703 28.300	36.700	4.95	30.00	5703 36.700
28.400	4.05	25.00	5703 28.400	36.800	5.00	30.00	5703 36.800
28.500	3.85	25.00	5703 28.500	36.900	5.05	30.00	5703 36.900
28.600	3.90	25.00	5703 28.600	37.000	4.85	30.00	5703 37.000
28.700	3.95	25.00	5703 28.700	37.100	4.90	30.00	5703 37.100
28.800	4.00	25.00	5703 28.800	37.200	4.95	30.00	5703 37.200
28.900	4.05	25.00	5703 28.900	37.300	5.00	30.00	5703 37.300
29.000	3.85	25.00	5703 29.000	37.400	5.05	30.00	5703 37.400
29.100	3.90	25.00	5703 29.100	37.500	4.85	30.00	5703 37.500
29.200	3.95	25.00	5703 29.200	37.600	4.90	30.00	5703 37.600
29.300	4.00	25.00	5703 29.300	37.700	4.95	30.00	5703 37.700
29.400	4.05	25.00	5703 29.400	37.800	5.00	30.00	5703 37.800
29.500	3.85	25.00	5703 29.500	37.900	5.05	30.00	5703 37.900
29.600	3.90	25.00	5703 29.600	38.000	5.35	30.00	5703 38.000
29.700	3.95	25.00	5703 29.700	38.100	5.40	30.00	5703 38.100
29.800	4.00	25.00	5703 29.800	38.200	5.45	30.00	5703 38.200
29.900	4.05	25.00	5703 29.900	38.300	5.50	30.00	5703 38.300
30.000	4.35	30.00	5703 30.000	38.400	5.55	30.00	5703 38.400
30.100	4.40	30.00	5703 30.100	38.500	5.35	30.00	5703 38.500
30.200	4.45	30.00	5703 30.200	38.600	5.40	30.00	5703 38.600
30.300	4.50	30.00	5703 30.300	38.700	5.45	30.00	5703 38.700
30.400	4.55	30.00	5703 30.400	38.800	5.50	30.00	5703 38.800
30.500	4.35	30.00	5703 30.500	38.900	5.55	30.00	5703 38.900
30.600	4.40	30.00	5703 30.600	39.000	5.35	30.00	5703 39.000
30.700	4.45	30.00	5703 30.700	39.100	5.40	30.00	5703 39.100
30.800	4.50	30.00	5703 30.800	39.200	5.45	30.00	5703 39.200
30.900	4.55	30.00	5703 30.900	39.300	5.50	30.00	5703 39.300
31.000	4.35	30.00	5703 31.000	39.400	5.55	30.00	5703 39.400
31.100	4.40	30.00	5703 31.100	39.500	5.35	30.00	5703 39.500
31.200	4.45	30.00	5703 31.200	39.600	5.40	30.00	5703 39.600
31.300	4.50	30.00	5703 31.300	39.700	5.45	30.00	5703 39.700
31.400	4.55	30.00	5703 31.400	39.800	5.50	30.00	5703 39.800
31.500	4.35	30.00	5703 31.500	39.900	5.55	30.00	5703 39.900
31.600	4.40	30.00	5703 31.600	40.000	5.60	30.00	5703 40.000
31.700	4.45	30.00	5703 31.700	40.100	5.40	30.00	5703 40.100
31.800	4.50	30.00	5703 31.800	40.200	5.45	30.00	5703 40.200
31.900	4.55	30.00	5703 31.900	40.300	5.50	30.00	5703 40.300
32.000	4.35	30.00	5703 32.000	40.400	5.55	30.00	5703 40.400
32.100	4.40	30.00	5703 32.100	40.500	5.35	30.00	5703 40.500
32.200	4.45	30.00	5703 32.200	40.600	5.40	30.00	5703 40.600
32.300	4.50	30.00	5703 32.300	40.700	5.45	30.00	5703 40.700
32.400	4.55	30.00	5703 32.400	40.800	5.50	30.00	5703 40.800
32.500	4.35	30.00	5703 32.500	40.900	5.55	30.00	5703 40.900
32.600	4.40	30.00	5703 32.600	41.000	5.35	30.00	5703 41.000
32.700	4.45	30.00	5703 32.700	41.100	5.40	30.00	5703 41.100
32.800	4.50	30.00	5703 32.800	41.200	5.45	30.00	5703 41.200
32.900	4.55	30.00	5703 32.900	41.300	5.50	30.00	5703 41.300
33.000	4.35	30.00	5703 33.000	41.400	5.55	30.00	5703 41.400
33.100	4.40	30.00	5703 33.100	41.500	5.35	30.00	5703 41.500
33.200	4.45	30.00	5703 33.200	41.600	5.40	30.00	5703 41.600
33.300	4.50	30.00	5703 33.300	41.700	5.45	30.00	5703 41.700
33.400	4.55	30.00	5703 33.400	41.800	5.50	30.00	5703 41.800



Modular single-fluted gun drills

Deep hole drills

Article no.			5703	Article no.			5703
d1 mm	b mm	l1 mm	Order no.	d1 mm	b mm	l1 mm	Order no.
41.900	5.55	30.00	5703 41.900	47.300	5.50	30.00	5703 47.300
42.000	5.35	30.00	5703 42.000	47.400	5.55	30.00	5703 47.400
42.100	5.40	30.00	5703 42.100	47.500	5.35	30.00	5703 47.500
42.200	5.45	30.00	5703 42.200	47.600	5.40	30.00	5703 47.600
42.300	5.50	30.00	5703 42.300	47.700	5.45	30.00	5703 47.700
42.400	5.55	30.00	5703 42.400	47.800	5.50	30.00	5703 47.800
42.500	5.35	30.00	5703 42.500	47.900	5.55	30.00	5703 47.900
42.600	5.40	30.00	5703 42.600	48.000	5.35	30.00	5703 48.000
42.700	5.45	30.00	5703 42.700	48.100	5.40	30.00	5703 48.100
42.800	5.50	30.00	5703 42.800	48.200	5.45	30.00	5703 48.200
42.900	5.55	30.00	5703 42.900	48.300	5.50	30.00	5703 48.300
43.000	5.35	30.00	5703 43.000	48.400	5.55	30.00	5703 48.400
43.100	5.40	30.00	5703 43.100	48.500	5.35	30.00	5703 48.500
43.200	5.45	30.00	5703 43.200	48.600	5.40	30.00	5703 48.600
43.300	5.50	30.00	5703 43.300	48.700	5.45	30.00	5703 48.700
43.400	5.55	30.00	5703 43.400	48.800	5.50	30.00	5703 48.800
43.500	5.35	30.00	5703 43.500	48.900	5.55	30.00	5703 48.900
43.600	5.40	30.00	5703 43.600	49.000	5.35	30.00	5703 49.000
43.700	5.45	30.00	5703 43.700	49.100	5.40	30.00	5703 49.100
43.800	5.50	30.00	5703 43.800	49.200	5.45	30.00	5703 49.200
43.900	5.55	30.00	5703 43.900	49.300	5.50	30.00	5703 49.300
44.000	5.35	30.00	5703 44.000	49.400	5.55	30.00	5703 49.400
44.100	5.40	30.00	5703 44.100	49.500	5.35	30.00	5703 49.500
44.200	5.45	30.00	5703 44.200	49.600	5.40	30.00	5703 49.600
44.300	5.50	30.00	5703 44.300	49.700	5.45	30.00	5703 49.700
44.400	5.55	30.00	5703 44.400	49.800	5.50	30.00	5703 49.800
44.500	5.35	30.00	5703 44.500	49.900	5.55	30.00	5703 49.900
44.600	5.40	30.00	5703 44.600	50.000	5.35	30.00	5703 50.000
44.700	5.45	30.00	5703 44.700	50.100	5.40	30.00	5703 50.100
44.800	5.50	30.00	5703 44.800	50.200	5.45	30.00	5703 50.200
44.900	5.55	30.00	5703 44.900	50.300	5.50	30.00	5703 50.300
45.000	5.35	30.00	5703 45.000	50.400	5.55	30.00	5703 50.400
45.100	5.40	30.00	5703 45.100	50.500	5.35	30.00	5703 50.500
45.200	5.45	30.00	5703 45.200	50.600	5.40	30.00	5703 50.600
45.300	5.50	30.00	5703 45.300	50.700	5.45	30.00	5703 50.700
45.400	5.55	30.00	5703 45.400	50.800	5.50	30.00	5703 50.800
45.500	5.35	30.00	5703 45.500	50.900	5.55	30.00	5703 50.900
45.600	5.40	30.00	5703 45.600	51.000	5.35	30.00	5703 51.000
45.700	5.45	30.00	5703 45.700	51.100	5.40	30.00	5703 51.100
45.800	5.50	30.00	5703 45.800	51.200	5.45	30.00	5703 51.200
45.900	5.55	30.00	5703 45.900	51.300	5.50	30.00	5703 51.300
46.000	5.35	30.00	5703 46.000	51.400	5.55	30.00	5703 51.400
46.100	5.40	30.00	5703 46.100	51.500	5.35	30.00	5703 51.500
46.200	5.45	30.00	5703 46.200	51.600	5.40	30.00	5703 51.600
46.300	5.50	30.00	5703 46.300	51.700	5.45	30.00	5703 51.700
46.400	5.55	30.00	5703 46.400	51.800	5.50	30.00	5703 51.800
46.500	5.35	30.00	5703 46.500	51.900	5.55	30.00	5703 51.900
46.600	5.40	30.00	5703 46.600	52.000	5.60	30.00	5703 52.000
46.700	5.45	30.00	5703 46.700				
46.800	5.50	30.00	5703 46.800				
46.900	5.55	30.00	5703 46.900				
47.000	5.35	30.00	5703 47.000				
47.100	5.40	30.00	5703 47.100				
47.200	5.45	30.00	5703 47.200				



Guide pads for single-fluted gun drills EB 800

Article no. 5705



Cutting data page 440

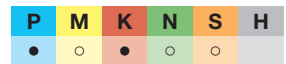

interchangeable guide pad • observe tightening torques • order torque wrench set art. no. 4966 separately

Deep hole drills

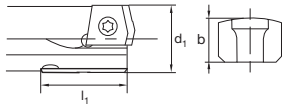

			Article no.	5705				Article no.	5705
d1	b	l1		Order no.	d1	b	l1		Order no.
mm	mm	mm			mm	mm	mm		
12.000	2.15	19.95		5705 12.000	18.600	2.90	20.00		5705 18.600
12.100	2.20	19.95		5705 12.100	18.700	2.95	20.00		5705 18.700
12.200	2.25	19.95		5705 12.200	18.800	3.00	20.00		5705 18.800
12.300	2.30	19.95		5705 12.300	18.900	3.05	20.00		5705 18.900
12.400	2.35	19.95		5705 12.400	19.000	2.85	20.00		5705 19.000
12.500	2.15	19.95		5705 12.500	19.050	2.87	20.00		5705 19.050
12.600	2.20	19.95		5705 12.600	19.100	2.90	20.00		5705 19.100
12.700	2.25	19.95		5705 12.700	19.200	2.95	20.00		5705 19.200
12.800	2.30	19.95		5705 12.800	19.300	3.00	20.00		5705 19.300
12.900	2.35	19.95		5705 12.900	19.400	3.05	20.00		5705 19.400
13.000	2.15	19.95		5705 13.000	19.500	2.85	20.00		5705 19.500
13.100	2.20	19.95		5705 13.100	19.600	2.90	20.00		5705 19.600
13.200	2.25	19.95		5705 13.200	19.700	2.95	20.00		5705 19.700
13.300	2.30	19.95		5705 13.300	19.800	3.00	20.00		5705 19.800
13.400	2.35	19.95		5705 13.400	19.900	3.05	20.00		5705 19.900
13.500	2.15	19.95		5705 13.500	20.000	3.35	25.00		5705 20.000
13.600	2.20	19.95		5705 13.600	20.100	3.40	25.00		5705 20.100
13.700	2.25	19.95		5705 13.700	20.200	3.45	25.00		5705 20.200
13.800	2.30	19.95		5705 13.800	20.300	3.50	25.00		5705 20.300
13.900	2.35	19.95		5705 13.900	20.400	3.55	25.00		5705 20.400
14.000	2.15	19.95		5705 14.000	20.500	3.35	25.00		5705 20.500
14.100	2.20	19.95		5705 14.100	20.600	3.40	25.00		5705 20.600
14.200	2.25	19.95		5705 14.200	20.700	3.45	25.00		5705 20.700
14.300	2.30	19.95		5705 14.300	20.800	3.50	25.00		5705 20.800
14.400	2.35	19.95		5705 14.400	20.900	3.55	25.00		5705 20.900
14.500	2.15	19.95		5705 14.500	21.000	3.35	25.00		5705 21.000
14.600	2.20	19.95		5705 14.600	21.100	3.40	25.00		5705 21.100
14.700	2.25	19.95		5705 14.700	21.200	3.45	25.00		5705 21.200
14.800	2.30	19.95		5705 14.800	21.300	3.50	25.00		5705 21.300
14.900	2.35	19.95		5705 14.900	21.400	3.55	25.00		5705 21.400
15.000	2.15	19.95		5705 15.000	21.500	3.35	25.00		5705 21.500
15.100	2.20	19.95		5705 15.100	21.600	3.40	25.00		5705 21.600
15.200	2.25	19.95		5705 15.200	21.700	3.45	25.00		5705 21.700
15.300	2.30	19.95		5705 15.300	21.800	3.50	25.00		5705 21.800
15.400	2.35	19.95		5705 15.400	21.900	3.55	25.00		5705 21.900
15.500	2.15	19.95		5705 15.500	22.000	3.35	25.00		5705 22.000
15.600	2.20	19.95		5705 15.600	22.100	3.40	25.00		5705 22.100
15.700	2.25	19.95		5705 15.700	22.200	3.45	25.00		5705 22.200
15.800	2.30	19.95		5705 15.800	22.300	3.50	25.00		5705 22.300
15.900	2.35	19.95		5705 15.900	22.400	3.55	25.00		5705 22.400
16.000	2.85	20.00		5705 16.000	22.500	3.35	25.00		5705 22.500
16.100	2.90	20.00		5705 16.100	22.600	3.40	25.00		5705 22.600
16.200	2.95	20.00		5705 16.200	22.700	3.45	25.00		5705 22.700
16.300	3.00	20.00		5705 16.300	22.800	3.50	25.00		5705 22.800
16.400	3.05	20.00		5705 16.400	22.900	3.55	25.00		5705 22.900
16.500	2.85	20.00		5705 16.500	23.000	3.35	25.00		5705 23.000
16.600	2.90	20.00		5705 16.600	23.100	3.40	25.00		5705 23.100
16.700	2.95	20.00		5705 16.700	23.200	3.45	25.00		5705 23.200
16.800	3.00	20.00		5705 16.800	23.300	3.50	25.00		5705 23.300
16.900	3.05	20.00		5705 16.900	23.400	3.55	25.00		5705 23.400
17.000	2.85	20.00		5705 17.000	23.500	3.35	25.00		5705 23.500
17.100	2.90	20.00		5705 17.100	23.600	3.40	25.00		5705 23.600
17.200	2.95	20.00		5705 17.200	23.700	3.45	25.00		5705 23.700
17.300	3.00	20.00		5705 17.300	23.800	3.50	25.00		5705 23.800
17.400	3.05	20.00		5705 17.400	23.900	3.55	25.00		5705 23.900
17.500	2.85	20.00		5705 17.500	24.000	3.35	25.00		5705 24.000
17.600	2.90	20.00		5705 17.600	24.100	3.40	25.00		5705 24.100
17.700	2.95	20.00		5705 17.700	24.200	3.45	25.00		5705 24.200
17.800	3.00	20.00		5705 17.800	24.300	3.50	25.00		5705 24.300
17.900	3.05	20.00		5705 17.900	24.400	3.55	25.00		5705 24.400
18.000	2.85	20.00		5705 18.000	24.500	3.35	25.00		5705 24.500
18.100	2.90	20.00		5705 18.100	24.600	3.40	25.00		5705 24.600
18.200	2.95	20.00		5705 18.200	24.700	3.45	25.00		5705 24.700
18.300	3.00	20.00		5705 18.300	24.800	3.50	25.00		5705 24.800
18.400	3.05	20.00		5705 18.400	24.900	3.55	25.00		5705 24.900
18.500	2.85	20.00		5705 18.500	25.000	3.35	25.00		5705 25.000



Modular single-fluted gun drills

Deep hole drills

Article no.			5705	Article no.			5705
d1 mm	b mm	l1 mm	Order no.	d1 mm	b mm	l1 mm	Order no.
25.100	3.40	25.00	5705 25.100	33.500	4.35	30.00	5705 33.500
25.200	3.45	25.00	5705 25.200	33.600	4.40	30.00	5705 33.600
25.300	3.50	25.00	5705 25.300	33.700	4.45	30.00	5705 33.700
25.400	3.55	25.00	5705 25.400	33.800	4.50	30.00	5705 33.800
25.500	3.35	25.00	5705 25.500	33.900	4.55	30.00	5705 33.900
25.600	3.40	25.00	5705 25.600	34.000	4.85	30.00	5705 34.000
25.700	3.45	25.00	5705 25.700	34.100	4.90	30.00	5705 34.100
25.800	3.50	25.00	5705 25.800	34.200	4.95	30.00	5705 34.200
25.900	3.55	25.00	5705 25.900	34.300	5.00	30.00	5705 34.300
26.000	3.85	25.00	5705 26.000	34.400	5.05	30.00	5705 34.400
26.100	3.90	25.00	5705 26.100	34.500	4.85	30.00	5705 34.500
26.200	3.95	25.00	5705 26.200	34.600	4.90	30.00	5705 34.600
26.300	4.00	25.00	5705 26.300	34.700	4.95	30.00	5705 34.700
26.400	4.05	25.00	5705 26.400	34.800	5.00	30.00	5705 34.800
26.500	3.85	25.00	5705 26.500	34.900	5.05	30.00	5705 34.900
26.600	3.90	25.00	5705 26.600	35.000	4.85	30.00	5705 35.000
26.700	3.95	25.00	5705 26.700	35.100	4.90	30.00	5705 35.100
26.800	4.00	25.00	5705 26.800	35.200	4.95	30.00	5705 35.200
26.900	4.05	25.00	5705 26.900	35.300	5.00	30.00	5705 35.300
27.000	3.85	25.00	5705 27.000	35.400	5.05	30.00	5705 35.400
27.100	3.90	25.00	5705 27.100	35.500	4.85	30.00	5705 35.500
27.200	3.95	25.00	5705 27.200	35.600	4.90	30.00	5705 35.600
27.300	4.00	25.00	5705 27.300	35.700	4.95	30.00	5705 35.700
27.400	4.05	25.00	5705 27.400	35.800	5.00	30.00	5705 35.800
27.500	3.85	25.00	5705 27.500	35.900	5.05	30.00	5705 35.900
27.600	3.90	25.00	5705 27.600	36.000	4.85	30.00	5705 36.000
27.700	3.95	25.00	5705 27.700	36.100	4.90	30.00	5705 36.100
27.800	4.00	25.00	5705 27.800	36.200	4.95	30.00	5705 36.200
27.900	4.05	25.00	5705 27.900	36.300	5.00	30.00	5705 36.300
28.000	3.85	25.00	5705 28.000	36.400	5.05	30.00	5705 36.400
28.100	3.90	25.00	5705 28.100	36.500	4.85	30.00	5705 36.500
28.200	3.95	25.00	5705 28.200	36.600	4.90	30.00	5705 36.600
28.300	4.00	25.00	5705 28.300	36.700	4.95	30.00	5705 36.700
28.400	4.05	25.00	5705 28.400	36.800	5.00	30.00	5705 36.800
28.500	3.85	25.00	5705 28.500	36.900	5.05	30.00	5705 36.900
28.600	3.90	25.00	5705 28.600	37.000	4.85	30.00	5705 37.000
28.700	3.95	25.00	5705 28.700	37.100	4.90	30.00	5705 37.100
28.800	4.00	25.00	5705 28.800	37.200	4.95	30.00	5705 37.200
28.900	4.05	25.00	5705 28.900	37.300	5.00	30.00	5705 37.300
29.000	3.85	25.00	5705 29.000	37.400	5.05	30.00	5705 37.400
29.100	3.90	25.00	5705 29.100	37.500	4.85	30.00	5705 37.500
29.200	3.95	25.00	5705 29.200	37.600	4.90	30.00	5705 37.600
29.300	4.00	25.00	5705 29.300	37.700	4.95	30.00	5705 37.700
29.400	4.05	25.00	5705 29.400	37.800	5.00	30.00	5705 37.800
29.500	3.85	25.00	5705 29.500	37.900	5.05	30.00	5705 37.900
29.600	3.90	25.00	5705 29.600	38.000	5.35	30.00	5705 38.000
29.700	3.95	25.00	5705 29.700	38.100	5.40	30.00	5705 38.100
29.800	4.00	25.00	5705 29.800	38.200	5.45	30.00	5705 38.200
29.900	4.05	25.00	5705 29.900	38.300	5.50	30.00	5705 38.300
30.000	4.35	30.00	5705 30.000	38.400	5.55	30.00	5705 38.400
30.100	4.40	30.00	5705 30.100	38.500	5.35	30.00	5705 38.500
30.200	4.45	30.00	5705 30.200	38.600	5.40	30.00	5705 38.600
30.300	4.50	30.00	5705 30.300	38.700	5.45	30.00	5705 38.700
30.400	4.55	30.00	5705 30.400	38.800	5.50	30.00	5705 38.800
30.500	4.35	30.00	5705 30.500	38.900	5.55	30.00	5705 38.900
30.600	4.40	30.00	5705 30.600	39.000	5.35	30.00	5705 39.000
30.700	4.45	30.00	5705 30.700	39.100	5.40	30.00	5705 39.100
30.800	4.50	30.00	5705 30.800	39.200	5.45	30.00	5705 39.200
30.900	4.55	30.00	5705 30.900	39.300	5.50	30.00	5705 39.300
31.000	4.35	30.00	5705 31.000	39.400	5.55	30.00	5705 39.400
31.100	4.40	30.00	5705 31.100	39.500	5.35	30.00	5705 39.500
31.200	4.45	30.00	5705 31.200	39.600	5.40	30.00	5705 39.600
31.300	4.50	30.00	5705 31.300	39.700	5.45	30.00	5705 39.700
31.400	4.55	30.00	5705 31.400	39.800	5.50	30.00	5705 39.800
31.500	4.35	30.00	5705 31.500	39.900	5.55	30.00	5705 39.900
31.600	4.40	30.00	5705 31.600	40.000	5.60	30.00	5705 40.000
31.700	4.45	30.00	5705 31.700	40.100	5.40	30.00	5705 40.100
31.800	4.50	30.00	5705 31.800	40.200	5.45	30.00	5705 40.200
31.900	4.55	30.00	5705 31.900	40.300	5.50	30.00	5705 40.300
32.000	4.35	30.00	5705 32.000	40.400	5.55	30.00	5705 40.400
32.100	4.40	30.00	5705 32.100	40.500	5.35	30.00	5705 40.500
32.200	4.45	30.00	5705 32.200	40.600	5.40	30.00	5705 40.600
32.300	4.50	30.00	5705 32.300	40.700	5.45	30.00	5705 40.700
32.400	4.55	30.00	5705 32.400	40.800	5.50	30.00	5705 40.800
32.500	4.35	30.00	5705 32.500	40.900	5.55	30.00	5705 40.900
32.600	4.40	30.00	5705 32.600	41.000	5.35	30.00	5705 41.000
32.700	4.45	30.00	5705 32.700	41.100	5.40	30.00	5705 41.100
32.800	4.50	30.00	5705 32.800	41.200	5.45	30.00	5705 41.200
32.900	4.55	30.00	5705 32.900	41.300	5.50	30.00	5705 41.300
33.000	4.35	30.00	5705 33.000	41.400	5.55	30.00	5705 41.400
33.100	4.40	30.00	5705 33.100	41.500	5.35	30.00	5705 41.500
33.200	4.45	30.00	5705 33.200	41.600	5.40	30.00	5705 41.600
33.300	4.50	30.00	5705 33.300	41.700	5.45	30.00	5705 41.700
33.400	4.55	30.00	5705 33.400	41.800	5.50	30.00	5705 41.800



Article no.			5705	Article no.			5705
d1 mm	b mm	l1 mm	Order no.	d1 mm	b mm	l1 mm	Order no.
41.900	5.55	30.00	5705 41.900	47.300	5.50	30.00	5705 47.300
42.000	5.35	30.00	5705 42.000	47.400	5.55	30.00	5705 47.400
42.100	5.40	30.00	5705 42.100	47.500	5.35	30.00	5705 47.500
42.200	5.45	30.00	5705 42.200	47.600	5.40	30.00	5705 47.600
42.300	5.50	30.00	5705 42.300	47.700	5.45	30.00	5705 47.700
42.400	5.55	30.00	5705 42.400	47.800	5.50	30.00	5705 47.800
42.500	5.35	30.00	5705 42.500	47.900	5.55	30.00	5705 47.900
42.600	5.40	30.00	5705 42.600	48.000	5.35	30.00	5705 48.000
42.700	5.45	30.00	5705 42.700	48.100	5.40	30.00	5705 48.100
42.800	5.50	30.00	5705 42.800	48.200	5.45	30.00	5705 48.200
42.900	5.55	30.00	5705 42.900	48.300	5.50	30.00	5705 48.300
43.000	5.35	30.00	5705 43.000	48.400	5.55	30.00	5705 48.400
43.100	5.40	30.00	5705 43.100	48.500	5.35	30.00	5705 48.500
43.200	5.45	30.00	5705 43.200	48.600	5.40	30.00	5705 48.600
43.300	5.50	30.00	5705 43.300	48.700	5.45	30.00	5705 48.700
43.400	5.55	30.00	5705 43.400	48.800	5.50	30.00	5705 48.800
43.500	5.35	30.00	5705 43.500	48.900	5.55	30.00	5705 48.900
43.600	5.40	30.00	5705 43.600	49.000	5.35	30.00	5705 49.000
43.700	5.45	30.00	5705 43.700	49.100	5.40	30.00	5705 49.100
43.800	5.50	30.00	5705 43.800	49.200	5.45	30.00	5705 49.200
43.900	5.55	30.00	5705 43.900	49.300	5.50	30.00	5705 49.300
44.000	5.35	30.00	5705 44.000	49.400	5.55	30.00	5705 49.400
44.100	5.40	30.00	5705 44.100	49.500	5.35	30.00	5705 49.500
44.200	5.45	30.00	5705 44.200	49.600	5.40	30.00	5705 49.600
44.300	5.50	30.00	5705 44.300	49.700	5.45	30.00	5705 49.700
44.400	5.55	30.00	5705 44.400	49.800	5.50	30.00	5705 49.800
44.500	5.35	30.00	5705 44.500	49.900	5.55	30.00	5705 49.900
44.600	5.40	30.00	5705 44.600	50.000	5.35	30.00	5705 50.000
44.700	5.45	30.00	5705 44.700	50.100	5.40	30.00	5705 50.100
44.800	5.50	30.00	5705 44.800	50.200	5.45	30.00	5705 50.200
44.900	5.55	30.00	5705 44.900	50.300	5.50	30.00	5705 50.300
45.000	5.35	30.00	5705 45.000	50.400	5.55	30.00	5705 50.400
45.100	5.40	30.00	5705 45.100	50.500	5.35	30.00	5705 50.500
45.200	5.45	30.00	5705 45.200	50.600	5.40	30.00	5705 50.600
45.300	5.50	30.00	5705 45.300	50.700	5.45	30.00	5705 50.700
45.400	5.55	30.00	5705 45.400	50.800	5.50	30.00	5705 50.800
45.500	5.35	30.00	5705 45.500	50.900	5.55	30.00	5705 50.900
45.600	5.40	30.00	5705 45.600	51.000	5.35	30.00	5705 51.000
45.700	5.45	30.00	5705 45.700	51.100	5.40	30.00	5705 51.100
45.800	5.50	30.00	5705 45.800	51.200	5.45	30.00	5705 51.200
45.900	5.55	30.00	5705 45.900	51.300	5.50	30.00	5705 51.300
46.000	5.35	30.00	5705 46.000	51.400	5.55	30.00	5705 51.400
46.100	5.40	30.00	5705 46.100	51.500	5.35	30.00	5705 51.500
46.200	5.45	30.00	5705 46.200	51.600	5.40	30.00	5705 51.600
46.300	5.50	30.00	5705 46.300	51.700	5.45	30.00	5705 51.700
46.400	5.55	30.00	5705 46.400	51.800	5.50	30.00	5705 51.800
46.500	5.35	30.00	5705 46.500	51.900	5.55	30.00	5705 51.900
46.600	5.40	30.00	5705 46.600	52.000	5.60	30.00	5705 52.000
46.700	5.45	30.00	5705 46.700				
46.800	5.50	30.00	5705 46.800				
46.900	5.55	30.00	5705 46.900				
47.000	5.35	30.00	5705 47.000				
47.100	5.40	30.00	5705 47.100				
47.200	5.45	30.00	5705 47.200				



Modular single-fluted gun drills

Deep hole drills

Guide pads for single-fluted gun drills EB 800

Article no. 5707



Cutting data page 440

P	M	K	N	S	H
○	●	○	○	●	○

interchangeable guide pad • observe tightening torques • order torque wrench set art. no. 4966 separately

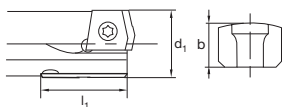

			Article no.	5707				Article no.	5707
d1	b	l1	Order no.		d1	b	l1	Order no.	
mm	mm	mm			mm	mm	mm		
12.000	2.15	19.95	5707 12.000		18.600	2.90	20.00	5707 18.600	
12.100	2.20	19.95	5707 12.100		18.700	2.95	20.00	5707 18.700	
12.200	2.25	19.95	5707 12.200		18.800	3.00	20.00	5707 18.800	
12.300	2.30	19.95	5707 12.300		18.900	3.05	20.00	5707 18.900	
12.400	2.35	19.95	5707 12.400		19.000	2.85	20.00	5707 19.000	
12.500	2.15	19.95	5707 12.500		19.050	2.87	20.00	5707 19.050	
12.600	2.20	19.95	5707 12.600		19.100	2.90	20.00	5707 19.100	
12.700	2.25	19.95	5707 12.700		19.200	2.95	20.00	5707 19.200	
12.800	2.30	19.95	5707 12.800		19.300	3.00	20.00	5707 19.300	
12.900	2.35	19.95	5707 12.900		19.400	3.05	20.00	5707 19.400	
13.000	2.15	19.95	5707 13.000		19.500	2.85	20.00	5707 19.500	
13.100	2.20	19.95	5707 13.100		19.600	2.90	20.00	5707 19.600	
13.200	2.25	19.95	5707 13.200		19.700	2.95	20.00	5707 19.700	
13.300	2.30	19.95	5707 13.300		19.800	3.00	20.00	5707 19.800	
13.400	2.35	19.95	5707 13.400		19.900	3.05	20.00	5707 19.900	
13.500	2.15	19.95	5707 13.500		20.000	3.35	25.00	5707 20.000	
13.600	2.20	19.95	5707 13.600		20.100	3.40	25.00	5707 20.100	
13.700	2.25	19.95	5707 13.700		20.200	3.45	25.00	5707 20.200	
13.800	2.30	19.95	5707 13.800		20.300	3.50	25.00	5707 20.300	
13.900	2.35	19.95	5707 13.900		20.400	3.55	25.00	5707 20.400	
14.000	2.15	19.95	5707 14.000		20.500	3.35	25.00	5707 20.500	
14.100	2.20	19.95	5707 14.100		20.600	3.40	25.00	5707 20.600	
14.200	2.25	19.95	5707 14.200		20.700	3.45	25.00	5707 20.700	
14.300	2.30	19.95	5707 14.300		20.800	3.50	25.00	5707 20.800	
14.400	2.35	19.95	5707 14.400		20.900	3.55	25.00	5707 20.900	
14.500	2.15	19.95	5707 14.500		21.000	3.35	25.00	5707 21.000	
14.600	2.20	19.95	5707 14.600		21.100	3.40	25.00	5707 21.100	
14.700	2.25	19.95	5707 14.700		21.200	3.45	25.00	5707 21.200	
14.800	2.30	19.95	5707 14.800		21.300	3.50	25.00	5707 21.300	
14.900	2.35	19.95	5707 14.900		21.400	3.55	25.00	5707 21.400	
15.000	2.15	19.95	5707 15.000		21.500	3.35	25.00	5707 21.500	
15.100	2.20	19.95	5707 15.100		21.600	3.40	25.00	5707 21.600	
15.200	2.25	19.95	5707 15.200		21.700	3.45	25.00	5707 21.700	
15.300	2.30	19.95	5707 15.300		21.800	3.50	25.00	5707 21.800	
15.400	2.35	19.95	5707 15.400		21.900	3.55	25.00	5707 21.900	
15.500	2.15	19.95	5707 15.500		22.000	3.35	25.00	5707 22.000	
15.600	2.20	19.95	5707 15.600		22.100	3.40	25.00	5707 22.100	
15.700	2.25	19.95	5707 15.700		22.200	3.45	25.00	5707 22.200	
15.800	2.30	19.95	5707 15.800		22.300	3.50	25.00	5707 22.300	
15.900	2.35	19.95	5707 15.900		22.400	3.55	25.00	5707 22.400	
16.000	2.85	20.00	5707 16.000		22.500	3.35	25.00	5707 22.500	
16.100	2.90	20.00	5707 16.100		22.600	3.40	25.00	5707 22.600	
16.200	2.95	20.00	5707 16.200		22.700	3.45	25.00	5707 22.700	
16.300	3.00	20.00	5707 16.300		22.800	3.50	25.00	5707 22.800	
16.400	3.05	20.00	5707 16.400		22.900	3.55	25.00	5707 22.900	
16.500	2.85	20.00	5707 16.500		23.000	3.35	25.00	5707 23.000	
16.600	2.90	20.00	5707 16.600		23.100	3.40	25.00	5707 23.100	
16.700	2.95	20.00	5707 16.700		23.200	3.45	25.00	5707 23.200	
16.800	3.00	20.00	5707 16.800		23.300	3.50	25.00	5707 23.300	
16.900	3.05	20.00	5707 16.900		23.400	3.55	25.00	5707 23.400	
17.000	2.85	20.00	5707 17.000		23.500	3.35	25.00	5707 23.500	
17.100	2.90	20.00	5707 17.100		23.600	3.40	25.00	5707 23.600	
17.200	2.95	20.00	5707 17.200		23.700	3.45	25.00	5707 23.700	
17.300	3.00	20.00	5707 17.300		23.800	3.50	25.00	5707 23.800	
17.400	3.05	20.00	5707 17.400		23.900	3.55	25.00	5707 23.900	
17.500	2.85	20.00	5707 17.500		24.000	3.35	25.00	5707 24.000	
17.600	2.90	20.00	5707 17.600		24.100	3.40	25.00	5707 24.100	
17.700	2.95	20.00	5707 17.700		24.200	3.45	25.00	5707 24.200	
17.800	3.00	20.00	5707 17.800		24.300	3.50	25.00	5707 24.300	
17.900	3.05	20.00	5707 17.900		24.400	3.55	25.00	5707 24.400	
18.000	2.85	20.00	5707 18.000		24.500	3.35	25.00	5707 24.500	
18.100	2.90	20.00	5707 18.100		24.600	3.40	25.00	5707 24.600	
18.200	2.95	20.00	5707 18.200		24.700	3.45	25.00	5707 24.700	
18.300	3.00	20.00	5707 18.300		24.800	3.50	25.00	5707 24.800	
18.400	3.05	20.00	5707 18.400		24.900	3.55	25.00	5707 24.900	
18.500	2.85	20.00	5707 18.500		25.000	3.35	25.00	5707 25.000	



Article no.			5707	Article no.			5707
d1 mm	b mm	l1 mm	Order no.	d1 mm	b mm	l1 mm	Order no.
25.100	3.40	25.00	5707 25.100	33.500	4.35	30.00	5707 33.500
25.200	3.45	25.00	5707 25.200	33.600	4.40	30.00	5707 33.600
25.300	3.50	25.00	5707 25.300	33.700	4.45	30.00	5707 33.700
25.400	3.55	25.00	5707 25.400	33.800	4.50	30.00	5707 33.800
25.500	3.35	25.00	5707 25.500	33.900	4.55	30.00	5707 33.900
25.600	3.40	25.00	5707 25.600	34.000	4.85	30.00	5707 34.000
25.700	3.45	25.00	5707 25.700	34.100	4.90	30.00	5707 34.100
25.800	3.50	25.00	5707 25.800	34.200	4.95	30.00	5707 34.200
25.900	3.55	25.00	5707 25.900	34.300	5.00	30.00	5707 34.300
26.000	3.85	25.00	5707 26.000	34.400	5.05	30.00	5707 34.400
26.100	3.90	25.00	5707 26.100	34.500	4.85	30.00	5707 34.500
26.200	3.95	25.00	5707 26.200	34.600	4.90	30.00	5707 34.600
26.300	4.00	25.00	5707 26.300	34.700	4.95	30.00	5707 34.700
26.400	4.05	25.00	5707 26.400	34.800	5.00	30.00	5707 34.800
26.500	3.85	25.00	5707 26.500	34.900	5.05	30.00	5707 34.900
26.600	3.90	25.00	5707 26.600	35.000	4.85	30.00	5707 35.000
26.700	3.95	25.00	5707 26.700	35.100	4.90	30.00	5707 35.100
26.800	4.00	25.00	5707 26.800	35.200	4.95	30.00	5707 35.200
26.900	4.05	25.00	5707 26.900	35.300	5.00	30.00	5707 35.300
27.000	3.85	25.00	5707 27.000	35.400	5.05	30.00	5707 35.400
27.100	3.90	25.00	5707 27.100	35.500	4.85	30.00	5707 35.500
27.200	3.95	25.00	5707 27.200	35.600	4.90	30.00	5707 35.600
27.300	4.00	25.00	5707 27.300	35.700	4.95	30.00	5707 35.700
27.400	4.05	25.00	5707 27.400	35.800	5.00	30.00	5707 35.800
27.500	3.85	25.00	5707 27.500	35.900	5.05	30.00	5707 35.900
27.600	3.90	25.00	5707 27.600	36.000	4.85	30.00	5707 36.000
27.700	3.95	25.00	5707 27.700	36.100	4.90	30.00	5707 36.100
27.800	4.00	25.00	5707 27.800	36.200	4.95	30.00	5707 36.200
27.900	4.05	25.00	5707 27.900	36.300	5.00	30.00	5707 36.300
28.000	3.85	25.00	5707 28.000	36.400	5.05	30.00	5707 36.400
28.100	3.90	25.00	5707 28.100	36.500	4.85	30.00	5707 36.500
28.200	3.95	25.00	5707 28.200	36.600	4.90	30.00	5707 36.600
28.300	4.00	25.00	5707 28.300	36.700	4.95	30.00	5707 36.700
28.400	4.05	25.00	5707 28.400	36.800	5.00	30.00	5707 36.800
28.500	3.85	25.00	5707 28.500	36.900	5.05	30.00	5707 36.900
28.600	3.90	25.00	5707 28.600	37.000	4.85	30.00	5707 37.000
28.700	3.95	25.00	5707 28.700	37.100	4.90	30.00	5707 37.100
28.800	4.00	25.00	5707 28.800	37.200	4.95	30.00	5707 37.200
28.900	4.05	25.00	5707 28.900	37.300	5.00	30.00	5707 37.300
29.000	3.85	25.00	5707 29.000	37.400	5.05	30.00	5707 37.400
29.100	3.90	25.00	5707 29.100	37.500	4.85	30.00	5707 37.500
29.200	3.95	25.00	5707 29.200	37.600	4.90	30.00	5707 37.600
29.300	4.00	25.00	5707 29.300	37.700	4.95	30.00	5707 37.700
29.400	4.05	25.00	5707 29.400	37.800	5.00	30.00	5707 37.800
29.500	3.85	25.00	5707 29.500	37.900	5.05	30.00	5707 37.900
29.600	3.90	25.00	5707 29.600	38.000	5.35	30.00	5707 38.000
29.700	3.95	25.00	5707 29.700	38.100	5.40	30.00	5707 38.100
29.800	4.00	25.00	5707 29.800	38.200	5.45	30.00	5707 38.200
29.900	4.05	25.00	5707 29.900	38.300	5.50	30.00	5707 38.300
30.000	4.35	30.00	5707 30.000	38.400	5.55	30.00	5707 38.400
30.100	4.40	30.00	5707 30.100	38.500	5.35	30.00	5707 38.500
30.200	4.45	30.00	5707 30.200	38.600	5.40	30.00	5707 38.600
30.300	4.50	30.00	5707 30.300	38.700	5.45	30.00	5707 38.700
30.400	4.55	30.00	5707 30.400	38.800	5.50	30.00	5707 38.800
30.500	4.35	30.00	5707 30.500	38.900	5.55	30.00	5707 38.900
30.600	4.40	30.00	5707 30.600	39.000	5.35	30.00	5707 39.000
30.700	4.45	30.00	5707 30.700	39.100	5.40	30.00	5707 39.100
30.800	4.50	30.00	5707 30.800	39.200	5.45	30.00	5707 39.200
30.900	4.55	30.00	5707 30.900	39.300	5.50	30.00	5707 39.300
31.000	4.35	30.00	5707 31.000	39.400	5.55	30.00	5707 39.400
31.100	4.40	30.00	5707 31.100	39.500	5.35	30.00	5707 39.500
31.200	4.45	30.00	5707 31.200	39.600	5.40	30.00	5707 39.600
31.300	4.50	30.00	5707 31.300	39.700	5.45	30.00	5707 39.700
31.400	4.55	30.00	5707 31.400	39.800	5.50	30.00	5707 39.800
31.500	4.35	30.00	5707 31.500	39.900	5.55	30.00	5707 39.900
31.600	4.40	30.00	5707 31.600	40.000	5.60	30.00	5707 40.000
31.700	4.45	30.00	5707 31.700	40.100	5.40	30.00	5707 40.100
31.800	4.50	30.00	5707 31.800	40.200	5.45	30.00	5707 40.200
31.900	4.55	30.00	5707 31.900	40.300	5.50	30.00	5707 40.300
32.000	4.35	30.00	5707 32.000	40.400	5.55	30.00	5707 40.400
32.100	4.40	30.00	5707 32.100	40.500	5.35	30.00	5707 40.500
32.200	4.45	30.00	5707 32.200	40.600	5.40	30.00	5707 40.600
32.300	4.50	30.00	5707 32.300	40.700	5.45	30.00	5707 40.700
32.400	4.55	30.00	5707 32.400	40.800	5.50	30.00	5707 40.800
32.500	4.35	30.00	5707 32.500	40.900	5.55	30.00	5707 40.900
32.600	4.40	30.00	5707 32.600	41.000	5.35	30.00	5707 41.000
32.700	4.45	30.00	5707 32.700	41.100	5.40	30.00	5707 41.100
32.800	4.50	30.00	5707 32.800	41.200	5.45	30.00	5707 41.200
32.900	4.55	30.00	5707 32.900	41.300	5.50	30.00	5707 41.300
33.000	4.35	30.00	5707 33.000	41.400	5.55	30.00	5707 41.400
33.100	4.40	30.00	5707 33.100	41.500	5.35	30.00	5707 41.500
33.200	4.45	30.00	5707 33.200	41.600	5.40	30.00	5707 41.600
33.300	4.50	30.00	5707 33.300	41.700	5.45	30.00	5707 41.700
33.400	4.55	30.00	5707 33.400	41.800	5.50	30.00	5707 41.800



Modular single-fluted gun drills

Deep hole drills

Article no.			5707	Article no.			5707
d1 mm	b mm	l1 mm	Order no.	d1 mm	b mm	l1 mm	Order no.
41.900	5.55	30.00	5707 41.900	47.300	5.50	30.00	5707 47.300
42.000	5.35	30.00	5707 42.000	47.400	5.55	30.00	5707 47.400
42.100	5.40	30.00	5707 42.100	47.500	5.35	30.00	5707 47.500
42.200	5.45	30.00	5707 42.200	47.600	5.40	30.00	5707 47.600
42.300	5.50	30.00	5707 42.300	47.700	5.45	30.00	5707 47.700
42.400	5.55	30.00	5707 42.400	47.800	5.50	30.00	5707 47.800
42.500	5.35	30.00	5707 42.500	47.900	5.55	30.00	5707 47.900
42.600	5.40	30.00	5707 42.600	48.000	5.35	30.00	5707 48.000
42.700	5.45	30.00	5707 42.700	48.100	5.40	30.00	5707 48.100
42.800	5.50	30.00	5707 42.800	48.200	5.45	30.00	5707 48.200
42.900	5.55	30.00	5707 42.900	48.300	5.50	30.00	5707 48.300
43.000	5.35	30.00	5707 43.000	48.400	5.55	30.00	5707 48.400
43.100	5.40	30.00	5707 43.100	48.500	5.35	30.00	5707 48.500
43.200	5.45	30.00	5707 43.200	48.600	5.40	30.00	5707 48.600
43.300	5.50	30.00	5707 43.300	48.700	5.45	30.00	5707 48.700
43.400	5.55	30.00	5707 43.400	48.800	5.50	30.00	5707 48.800
43.500	5.35	30.00	5707 43.500	48.900	5.55	30.00	5707 48.900
43.600	5.40	30.00	5707 43.600	49.000	5.35	30.00	5707 49.000
43.700	5.45	30.00	5707 43.700	49.100	5.40	30.00	5707 49.100
43.800	5.50	30.00	5707 43.800	49.200	5.45	30.00	5707 49.200
43.900	5.55	30.00	5707 43.900	49.300	5.50	30.00	5707 49.300
44.000	5.35	30.00	5707 44.000	49.400	5.55	30.00	5707 49.400
44.100	5.40	30.00	5707 44.100	49.500	5.35	30.00	5707 49.500
44.200	5.45	30.00	5707 44.200	49.600	5.40	30.00	5707 49.600
44.300	5.50	30.00	5707 44.300	49.700	5.45	30.00	5707 49.700
44.400	5.55	30.00	5707 44.400	49.800	5.50	30.00	5707 49.800
44.500	5.35	30.00	5707 44.500	49.900	5.55	30.00	5707 49.900
44.600	5.40	30.00	5707 44.600	50.000	5.35	30.00	5707 50.000
44.700	5.45	30.00	5707 44.700	50.100	5.40	30.00	5707 50.100
44.800	5.50	30.00	5707 44.800	50.200	5.45	30.00	5707 50.200
44.900	5.55	30.00	5707 44.900	50.300	5.50	30.00	5707 50.300
45.000	5.35	30.00	5707 45.000	50.400	5.55	30.00	5707 50.400
45.100	5.40	30.00	5707 45.100	50.500	5.35	30.00	5707 50.500
45.200	5.45	30.00	5707 45.200	50.600	5.40	30.00	5707 50.600
45.300	5.50	30.00	5707 45.300	50.700	5.45	30.00	5707 50.700
45.400	5.55	30.00	5707 45.400	50.800	5.50	30.00	5707 50.800
45.500	5.35	30.00	5707 45.500	50.900	5.55	30.00	5707 50.900
45.600	5.40	30.00	5707 45.600	51.000	5.35	30.00	5707 51.000
45.700	5.45	30.00	5707 45.700	51.100	5.40	30.00	5707 51.100
45.800	5.50	30.00	5707 45.800	51.200	5.45	30.00	5707 51.200
45.900	5.55	30.00	5707 45.900	51.300	5.50	30.00	5707 51.300
46.000	5.35	30.00	5707 46.000	51.400	5.55	30.00	5707 51.400
46.100	5.40	30.00	5707 46.100	51.500	5.35	30.00	5707 51.500
46.200	5.45	30.00	5707 46.200	51.600	5.40	30.00	5707 51.600
46.300	5.50	30.00	5707 46.300	51.700	5.45	30.00	5707 51.700
46.400	5.55	30.00	5707 46.400	51.800	5.50	30.00	5707 51.800
46.500	5.35	30.00	5707 46.500	51.900	5.55	30.00	5707 51.900
46.600	5.40	30.00	5707 46.600	52.000	5.60	30.00	5707 52.000
46.700	5.45	30.00	5707 46.700				
46.800	5.50	30.00	5707 46.800				
46.900	5.55	30.00	5707 46.900				
47.000	5.35	30.00	5707 47.000				
47.100	5.40	30.00	5707 47.100				
47.200	5.45	30.00	5707 47.200				



Inner inserts for single-fluted gun drills EB 800

Article no. 5665



Cutting data page 440



indexable insert with 2 cutting edges • observe tightening torques • order torque wrench set art. no. 4966 separately

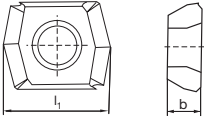

Article no. 5665

Ø-range	b mm	l1 mm	Order no.
40,001 - 52,000	4.76	15.00	5665 1.000

Inner inserts for single-fluted gun drills EB 800

Article no. 5667



Cutting data page 440

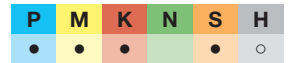

indexable insert with 2 cutting edges • observe tightening torques • order torque wrench set art. no. 4966 separately

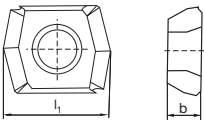

Article no. 5667

Ø-range	b mm	l1 mm	Order no.
40,001 - 52,000	4.76	15.00	5667 1.000



Inner inserts for single-fluted gun drills EB 800

Article no. **5666**



Cutting data page 440

P	M	K	N	S	H
●	○	●	○	○	○

indexable insert with 2 cutting edges • observe tightening torques • order torque wrench set art. no. 4966 separately

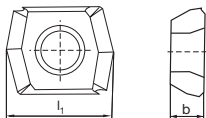

Article no. **5666**

Ø-range	b mm	l1 mm	Order no.
40,001 - 52,000	4.76	15.00	5666 1.000

Inner inserts for single-fluted gun drills EB 800

Article no. **5668**



Cutting data page 440

P	M	K	N	S	H
○	●	○	○	●	○

indexable insert with 2 cutting edges • observe tightening torques • order torque wrench set art. no. 4966 separately

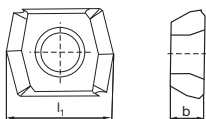

Article no. **5668**

Ø-range	b mm	l1 mm	Order no.
40,001 - 52,000	4.76	15.00	5668 1.000



Drill bushes

Article no. 5748

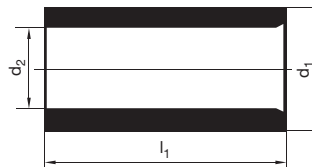

Deep hole drills

Article no.			5748	Article no.			5748
d2 F7 mm	d1 n6 mm	l1 mm	Order no.	d2 F7 mm	d1 n6 mm	l1 mm	Order no.
0.900	3	9	5748 0.900	14.020	22	28	5748 14.020
1.590	4	9	5748 1.590	14.030	22	28	5748 14.030
1.600	4	9	5748 1.600	14.400	22	28	5748 14.400
1.605	4	9	5748 1.605	15.020	22	28	5748 15.020
2.000	5	9	5748 2.000	16.000	26	28	5748 16.000
2.030	5	9	5748 2.030	16.030	26	28	5748 16.030
2.040	5	9	5748 2.040	16.200	26	28	5748 16.200
2.500	5	9	5748 2.500	18.000	26	28	5748 18.000
3.000	6	12	5748 3.000	18.030	26	28	5748 18.030
3.500	7	12	5748 3.500	18.050	26	28	5748 18.050
3.750	7	12	5748 3.750	18.100	30	36	5748 18.100
4.000	7	12	5748 4.000	20.000	30	36	5748 20.000
4.500	8	12	5748 4.500	20.030	30	36	5748 20.030
5.000	8	12	5748 5.000	22.000	30	36	5748 22.000
5.200	10	16	5748 5.200	22.030	30	36	5748 22.030
5.500	10	16	5748 5.500	22.120	35	36	5748 22.120
5.515	10	16	5748 5.515	23.500	35	36	5748 23.500
5.525	10	16	5748 5.525	24.000	35	36	5748 24.000
6.000	10	16	5748 6.000	24.030	35	36	5748 24.030
6.100	12	16	5748 6.100	25.000	35	36	5748 25.000
6.900	12	16	5748 6.900	26.000	35	36	5748 26.000
7.100	12	16	5748 7.100	28.000	42	45	5748 28.000
8.000	12	16	5748 8.000	30.000	42	45	5748 30.000
8.015	12	16	5748 8.015	34.000	48	45	5748 34.000
8.510	15	20	5748 8.510	35.000	48	45	5748 35.000
10.000	15	20	5748 10.000	40.000	55	55	5748 40.000
10.100	18	20	5748 10.100				
10.920	18	20	5748 10.920				
11.000	18	20	5748 11.000				
12.000	18	20	5748 12.000				
12.030	18	20	5748 12.030				
12.100	22	28	5748 12.100				
12.600	22	28	5748 12.600				
13.000	22	28	5748 13.000				
13.020	22	28	5748 13.020				
14.000	22	28	5748 14.000				



Drill bushes

Article no. **5747**

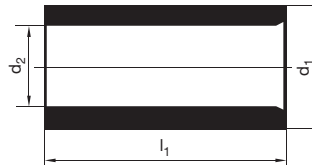

Article no.			5747	Article no.			5747
d2 F7 mm	d1 n6 mm	l1 mm	Order no.	d2 F7 mm	d1 n6 mm	l1 mm	Order no.
0.900	3	9	5747 0.900	8.530	15	20	5747 8.530
1.110	4	9	5747 1.110	8.800	15	20	5747 8.800
1.210	4	9	5747 1.210	8.950	15	20	5747 8.950
1.310	4	9	5747 1.310	9.000	15	20	5747 9.000
1.410	4	9	5747 1.410	9.100	15	20	5747 9.100
1.510	4	9	5747 1.510	9.200	15	20	5747 9.200
1.600	4	9	5747 1.600	9.300	15	20	5747 9.300
1.650	4	9	5747 1.650	9.500	15	20	5747 9.500
1.710	4	9	5747 1.710	9.525	15	20	5747 9.525
1.810	4	9	5747 1.810	9.530	15	20	5747 9.530
2.000	5	9	5747 2.000	9.570	15	20	5747 9.570
2.200	5	9	5747 2.200	9.652	15	20	5747 9.652
2.340	5	9	5747 2.340	9.800	15	20	5747 9.800
2.700	6	12	5747 2.700	10.000	15	20	5747 10.000
2.800	6	12	5747 2.800	10.100	18	20	5747 10.100
3.000	6	12	5747 3.000	10.420	18	20	5747 10.420
3.100	6	12	5747 3.100	10.600	18	20	5747 10.600
3.255	6	12	5747 3.255	10.725	18	20	5747 10.725
3.300	6	12	5747 3.300	11.000	18	20	5747 11.000
3.400	7	12	5747 3.400	11.080	18	20	5747 11.080
3.500	7	12	5747 3.500	11.100	18	20	5747 11.100
3.650	7	12	5747 3.650	11.113	18	20	5747 11.113
3.700	7	12	5747 3.700	11.500	18	20	5747 11.500
3.710	7	12	5747 3.710	11.600	18	20	5747 11.600
3.800	7	12	5747 3.800	12.000	18	20	5747 12.000
4.000	7	12	5747 4.000	12.020	18	20	5747 12.020
4.100	8	12	5747 4.100	12.100	22	28	5747 12.100
4.300	8	12	5747 4.300	12.530	22	28	5747 12.530
4.500	8	12	5747 4.500	12.600	22	28	5747 12.600
4.600	8	12	5747 4.600	12.700	22	28	5747 12.700
4.760	8	12	5747 4.760	12.800	22	28	5747 12.800
4.763	8	12	5747 4.763	12.954	22	28	5747 12.954
4.800	8	12	5747 4.800	13.000	22	28	5747 13.000
5.000	8	12	5747 5.000	13.400	22	28	5747 13.400
5.020	8	12	5747 5.020	13.500	22	28	5747 13.500
5.100	10	16	5747 5.100	13.700	22	28	5747 13.700
5.200	10	16	5747 5.200	13.800	22	28	5747 13.800
5.300	10	16	5747 5.300	14.000	22	28	5747 14.000
5.400	10	16	5747 5.400	14.310	22	28	5747 14.310
5.500	10	16	5747 5.500	14.620	22	28	5747 14.620
5.600	10	16	5747 5.600	14.770	22	28	5747 14.770
5.800	10	16	5747 5.800	15.000	22	28	5747 15.000
5.950	10	16	5747 5.950	15.875	26	28	5747 15.875
6.000	10	16	5747 6.000	16.000	26	28	5747 16.000
6.050	10	16	5747 6.050	16.330	26	28	5747 16.330
6.100	12	16	5747 6.100	17.040	26	28	5747 17.040
6.300	12	16	5747 6.300	17.080	26	28	5747 17.080
6.350	12	16	5747 6.350	18.000	26	28	5747 18.000
6.370	12	16	5747 6.370	18.100	30	36	5747 18.100
6.450	12	16	5747 6.450	18.255	30	36	5747 18.255
6.502	12	16	5747 6.502	18.450	30	36	5747 18.450
6.600	12	16	5747 6.600	19.000	30	36	5747 19.000
6.730	12	16	5747 6.730	19.050	30	36	5747 19.050
6.731	12	16	5747 6.731	19.300	30	36	5747 19.300
6.750	12	16	5747 6.750	19.500	30	36	5747 19.500
6.800	12	16	5747 6.800	19.700	30	36	5747 19.700
6.950	12	16	5747 6.950	20.000	30	36	5747 20.000
7.000	12	16	5747 7.000	21.050	30	36	5747 21.050
7.100	12	16	5747 7.100	22.000	30	36	5747 22.000
7.400	12	16	5747 7.400	22.100	35	36	5747 22.100
7.500	12	16	5747 7.500	22.120	35	36	5747 22.120
7.550	12	16	5747 7.550	22.225	35	36	5747 22.225
7.600	12	16	5747 7.600	23.500	35	36	5747 23.500
7.800	12	16	5747 7.800	24.000	35	36	5747 24.000
7.830	12	16	5747 7.830	24.500	35	36	5747 24.500
7.850	12	16	5747 7.850	25.000	35	36	5747 25.000
7.938	12	16	5747 7.938	25.250	35	36	5747 25.250
8.000	12	16	5747 8.000	25.400	35	36	5747 25.400
8.020	12	16	5747 8.020	26.000	35	36	5747 26.000
8.050	12	16	5747 8.050	28.000	42	45	5747 28.000
8.100	15	20	5747 8.100	28.169	42	45	5747 28.169
8.500	15	20	5747 8.500	30.000	42	45	5747 30.000



Article no.			5747
d2 F7 mm	d1 n6 mm	l1 mm	Order no.
30.100	48	45	5747 30.100
32.000	48	45	5747 32.000
34.000	48	45	5747 34.000
35.000	48	45	5747 35.000
38.100	55	56	5747 38.100
40.000	55	56	5747 40.000

Article no.			5747
d2 F7 mm	d1 n6 mm	l1 mm	Order no.

Deep hole drills



Steady rest bushings

Article no. **5749**

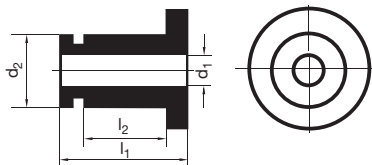

Article no. 5749				Article no. 5749					
d1	d2 n6 mm	l1 mm	l2 mm	Order no.	d1	d2 n6 mm	l1 mm	l2 mm	Order no.
1.850-1.999	20	20	12	5749 201.800	7.300-7.599	30	26	14	5749 307.000
2.000-2.099	20	20	12	5749 201.900	7.600-7.799	30	26	14	5749 307.300
2.100-2.199	20	20	12	5749 202.000	7.800-7.999	30	26	14	5749 307.500
2.200-2.299	20	20	12	5749 202.100	8.000-8.299	30	26	14	5749 307.700
2.300-2.399	20	20	12	5749 202.200	8.300-8.699	30	26	14	5749 308.000
2.400-2.499	20	20	12	5749 202.300	8.700-8.999	30	26	14	5749 308.400
2.500-2.599	20	20	12	5749 202.400	9.000-9.299	30	26	14	5749 308.700
2.600-2.699	20	20	12	5749 202.500	9.300-9.699	30	26	14	5749 309.000
2.700-2.799	20	20	12	5749 202.600	9.700-9.999	30	26	14	5749 309.400
2.800-2.899	20	20	12	5749 202.700	10.000-10.299	30	26	14	5749 309.700
2.900-3.099	20	20	12	5749 202.800	10.300-10.799	30	26	14	5749 310.000
3.100-3.359	20	20	12	5749 203.000	10.800-11.299	30	26	14	5749 310.500
3.360-3.459	20	20	12	5749 203.200	11.300-11.799	30	26	14	5749 311.000
3.460-3.559	20	20	12	5749 203.300	11.800-12.399	30	26	14	5749 311.500
3.560-3.799	20	20	12	5749 203.400	12.400-12.899	30	26	14	5749 312.000
3.800-3.959	20	20	12	5749 203.600	12.900-13.399	30	26	14	5749 312.500
3.960-4.259	20	20	12	5749 203.700	13.400-13.899	30	26	14	5749 313.000
4.260-4.499	20	20	12	5749 204.000	13.900-14.399	30	26	14	5749 313.500
4.500-4.749	20	20	12	5749 204.200	14.400-14.899	30	26	14	5749 314.000
4.750-4.999	20	20	12	5749 204.500	14.900-15.399	30	26	14	5749 314.500
5.000-5.249	20	20	12	5749 204.700	15.400-15.899	30	26	14	5749 315.000
5.250-5.499	20	20	12	5749 205.000	15.900-16.399	30	26	14	5749 315.500
5.500-5.749	20	20	12	5749 205.200	16.400-16.899	30	26	14	5749 316.000
5.750-5.999	20	20	12	5749 205.500	16.900-17.399	30	26	14	5749 316.500
6.000-6.249	20	20	12	5749 205.700	17.400-17.899	30	26	14	5749 317.000
6.250-6.449	20	20	12	5749 206.000	17.900-18.399	30	26	14	5749 317.500
6.450-6.749	20	20	12	5749 206.200	18.400-19.509	30	26	14	5749 318.000
6.750-6.999	20	20	12	5749 206.500	19.510-20.509	30	26	14	5749 319.000
7.000-7.299	20	20	12	5749 206.700	20.510-21.509	30	26	14	5749 320.000
7.300-7.599	20	20	12	5749 207.000	21.510-22.609	30	26	14	5749 321.000
7.600-7.799	20	20	12	5749 207.300	22.610-23.609	30	26	14	5749 322.000
7.800-7.999	20	20	12	5749 207.500	23.610-24.609	30	26	14	5749 323.000
8.000-8.299	20	20	12	5749 207.700	24.610-25.609	30	26	14	5749 324.000
8.300-8.699	20	20	12	5749 208.000	1.850-1.999	45	26	16	5749 401.800
8.700-8.999	20	20	12	5749 208.400	2.000-2.099	45	26	16	5749 401.900
9.000-9.299	20	20	12	5749 208.700	2.100-2.199	45	26	16	5749 402.000
9.300-9.699	20	20	12	5749 209.000	2.200-2.299	45	26	16	5749 402.100
9.700-9.999	20	20	12	5749 209.400	2.300-2.399	45	26	16	5749 402.200
10.000-10.299	20	20	12	5749 209.700	2.400-2.499	45	26	16	5749 402.300
10.300-10.799	20	20	12	5749 210.000	2.500-2.599	45	26	16	5749 402.400
10.800-11.299	20	20	12	5749 210.500	2.600-2.699	45	26	16	5749 402.500
11.300-11.799	20	20	12	5749 211.000	2.700-2.799	45	26	16	5749 402.600
11.800-12.399	20	20	12	5749 211.500	2.800-2.899	45	26	16	5749 402.700
1.850-1.999	30	26	14	5749 301.800	2.900-3.099	45	26	16	5749 402.800
2.000-2.099	30	26	14	5749 301.900	3.100-3.359	45	26	16	5749 403.000
2.100-2.199	30	26	14	5749 302.000	3.360-3.459	45	26	16	5749 403.200
2.200-2.299	30	26	14	5749 302.100	3.460-3.559	45	26	16	5749 403.300
2.300-2.399	30	26	14	5749 302.200	3.560-3.799	45	26	16	5749 403.400
2.400-2.499	30	26	14	5749 302.300	3.800-3.959	45	26	16	5749 403.600
2.500-2.599	30	26	14	5749 302.400	3.960-4.259	45	26	16	5749 403.700
2.600-2.699	30	26	14	5749 302.500	4.260-4.499	45	26	16	5749 404.000
2.700-2.799	30	26	14	5749 302.600	4.500-4.749	45	26	16	5749 404.200
2.800-2.899	30	26	14	5749 302.700	4.750-4.999	45	26	16	5749 404.500
2.900-3.099	30	26	14	5749 302.800	5.000-5.249	45	26	16	5749 404.700
3.100-3.359	30	26	14	5749 303.000	5.250-5.499	45	26	16	5749 405.000
3.360-3.459	30	26	14	5749 303.200	5.500-5.749	45	26	16	5749 405.200
3.460-3.559	30	26	14	5749 303.300	5.750-5.999	45	26	16	5749 405.500
3.560-3.799	30	26	14	5749 303.400	6.000-6.249	45	26	16	5749 405.700
3.800-3.959	30	26	14	5749 303.600	6.250-6.449	45	26	16	5749 406.000
3.960-4.259	30	26	14	5749 303.700	6.450-6.749	45	26	16	5749 406.200
4.260-4.499	30	26	14	5749 304.000	6.750-6.999	45	26	16	5749 406.500
4.500-4.749	30	26	14	5749 304.200	7.000-7.299	45	26	16	5749 406.700
4.750-4.999	30	26	14	5749 304.500	7.300-7.599	45	26	16	5749 407.000
5.000-5.249	30	26	14	5749 304.700	7.600-7.799	45	26	16	5749 407.300
5.250-5.499	30	26	14	5749 305.000	7.800-7.999	45	26	16	5749 407.500
5.500-5.749	30	26	14	5749 305.200	8.000-8.299	45	26	16	5749 407.700
5.750-5.999	30	26	14	5749 305.500	8.300-8.699	45	26	16	5749 408.000
6.000-6.249	30	26	14	5749 305.700	8.700-8.999	45	26	16	5749 408.400
6.250-6.449	30	26	14	5749 306.000	9.000-9.299	45	26	16	5749 408.700
6.450-6.749	30	26	14	5749 306.200	9.300-9.699	45	26	16	5749 409.000
6.750-6.999	30	26	14	5749 306.500	9.700-9.999	45	26	16	5749 409.400
7.000-7.299	30	26	14	5749 306.700	10.000-10.299	45	26	16	5749 409.700



Article no.				5749	Article no.				5749
d1	d2 n6 mm	l1 mm	l2 mm	Order no.	d1	d2 n6 mm	l1 mm	l2 mm	Order no.
10.300-10.799	45	26	16	5749 410.000	20.510-21.509	45	26	16	5749 420.000
10.800-11.299	45	26	16	5749 410.500	21.510-22.609	45	26	16	5749 421.000
11.300-11.799	45	26	16	5749 411.000	22.610-23.609	45	26	16	5749 422.000
11.800-12.399	45	26	16	5749 411.500	23.610-24.609	45	26	16	5749 423.000
12.400-12.899	45	26	16	5749 412.000	24.610-25.609	45	26	16	5749 424.000
12.900-13.399	45	26	16	5749 412.500	25.610-26.609	45	26	16	5749 425.000
13.400-13.899	45	26	16	5749 413.000	26.610-27.609	45	26	16	5749 426.000
13.900-14.399	45	26	16	5749 413.500	27.610-28.609	45	26	16	5749 427.000
14.400-14.899	45	26	16	5749 414.000	28.610-29.609	45	26	16	5749 428.000
14.900-15.399	45	26	16	5749 414.500	29.610-30.609	45	26	16	5749 429.000
15.400-15.899	45	26	16	5749 415.000	30.610-32.609	45	26	16	5749 430.000
15.900-16.399	45	26	16	5749 415.500	32.610-34.699	45	26	16	5749 432.000
16.400-16.899	45	26	16	5749 416.000	34.700-36.699	45	26	16	5749 434.000
16.900-17.399	45	26	16	5749 416.500	34.700-36.699	55	26	14	5749 534.000
17.400-17.899	45	26	16	5749 417.000	36.700-38.699	55	26	14	5749 536.000
17.900-18.399	45	26	16	5749 417.500	38.700-42.699	55	26	14	5749 538.000
18.400-19.509	45	26	16	5749 418.000	42.700-45.699	55	26	14	5749 542.000
19.510-20.509	45	26	16	5749 419.000	45,700-48,999	55	26	14	5749 545.000



Moulded steady rest bushings for single-fluted gun drills

Article no. **5750**

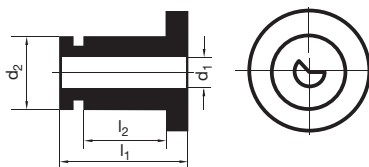

Article no.				5750	Article no.				5750
d1	d2 n6 mm	l1 mm	l2 mm	Order no.	d1	d2 n6 mm	l1 mm	l2 mm	Order no.
2.000-2.099	20	20	12	5750 201.900	12.400-12.899	30	26	14	5750 312.000
2.100-2.199	20	20	12	5750 202.000	12.900-13.399	30	26	14	5750 312.500
2.200-2.299	20	20	12	5750 202.100	13.400-13.899	30	26	14	5750 313.000
2.300-2.399	20	20	12	5750 202.200	13.900-14.399	30	26	14	5750 313.500
2.400-2.499	20	20	12	5750 202.300	14.400-14.899	30	26	14	5750 314.000
2.500-2.599	20	20	12	5750 202.400	14.900-15.399	30	26	14	5750 314.500
2.600-2.699	20	20	12	5750 202.500	15.400-15.899	30	26	14	5750 315.000
2.700-2.799	20	20	12	5750 202.600	15.900-16.399	30	26	14	5750 315.500
2.800-2.899	20	20	12	5750 202.700	16.400-16.899	30	26	14	5750 316.000
2.900-3.099	20	20	12	5750 202.800	16.900-17.399	30	26	14	5750 316.500
3.100-3.359	20	20	12	5750 203.000	17.400-17.899	30	26	14	5750 317.000
3.360-3.459	20	20	12	5750 203.200	17.900-18.399	30	26	14	5750 317.500
3.460-3.559	20	20	12	5750 203.300	18.400-19.509	30	26	14	5750 318.000
3.560-3.799	20	20	12	5750 203.400	19.510-20.509	30	26	14	5750 319.000
3.800-3.959	20	20	12	5750 203.600	20.510-21.509	30	26	14	5750 320.000
3.960-4.259	20	20	12	5750 203.700	21.510-22.609	30	26	14	5750 321.000
4.260-4.499	20	20	12	5750 204.000	22.610-23.609	30	26	14	5750 322.000
4.500-4.749	20	20	12	5750 204.200	23.610-24.609	30	26	14	5750 323.000
4.750-4.999	20	20	12	5750 204.500	24.610-25.609	30	26	14	5750 324.000
5.000-5.249	20	20	12	5750 204.700	3.100-3.359	45	26	16	5750 403.000
5.500-5.749	20	20	12	5750 205.200	3.360-3.459	45	26	16	5750 403.200
6.000-6.249	20	20	12	5750 205.700	3.460-3.559	45	26	16	5750 403.300
6.250-6.449	20	20	12	5750 206.000	3.560-3.799	45	26	16	5750 403.400
6.450-6.749	20	20	12	5750 206.200	3.800-3.959	45	26	16	5750 403.600
6.750-6.999	20	20	12	5750 206.500	3.960-4.259	45	26	16	5750 403.700
7.000-7.299	20	20	12	5750 206.700	4.260-4.499	45	26	16	5750 404.000
7.600-7.799	20	20	12	5750 207.300	4.500-4.749	45	26	16	5750 404.200
7.800-7.999	20	20	12	5750 207.500	4.750-4.999	45	26	16	5750 404.500
8.000-8.299	20	20	12	5750 207.700	5.000-5.249	45	26	16	5750 404.700
8.300-8.699	20	20	12	5750 208.000	5.250-5.499	45	26	16	5750 405.000
8.700-8.999	20	20	12	5750 208.400	5.500-5.749	45	26	16	5750 405.200
9.000-9.299	20	20	12	5750 208.700	5.750-5.999	45	26	16	5750 405.500
9.300-9.699	20	20	12	5750 209.000	6.000-6.249	45	26	16	5750 405.700
9.700-9.999	20	20	12	5750 209.400	6.250-6.449	45	26	16	5750 406.000
10.000-10.299	20	20	12	5750 209.700	6.450-6.749	45	26	16	5750 406.200
10.300-10.799	20	20	12	5750 210.000	6.750-6.999	45	26	16	5750 406.500
10.800-11.299	20	20	12	5750 210.500	7.000-7.299	45	26	16	5750 406.700
11.300-11.799	20	20	12	5750 211.000	7.300-7.599	45	26	16	5750 407.000
11.800-12.399	20	20	12	5750 211.500	7.600-7.799	45	26	16	5750 407.300
2.900-3.099	30	26	14	5750 302.800	7.800-7.999	45	26	16	5750 407.500
3.100-3.359	30	26	14	5750 303.000	8.000-8.299	45	26	16	5750 407.700
3.360-3.459	30	26	14	5750 303.200	8.300-8.699	45	26	16	5750 408.000
3.460-3.559	30	26	14	5750 303.300	8.700-8.999	45	26	16	5750 408.400
3.560-3.799	30	26	14	5750 303.400	9.000-9.299	45	26	16	5750 408.700
3.800-3.959	30	26	14	5750 303.600	9.300-9.699	45	26	16	5750 409.000
3.960-4.259	30	26	14	5750 303.700	9.700-9.999	45	26	16	5750 409.400
4.260-4.499	30	26	14	5750 304.000	10.000-10.299	45	26	16	5750 409.700
4.500-4.749	30	26	14	5750 304.200	10.300-10.799	45	26	16	5750 410.000
4.750-4.999	30	26	14	5750 304.500	10.800-11.299	45	26	16	5750 410.500
5.000-5.249	30	26	14	5750 304.700	11.300-11.799	45	26	16	5750 411.000
5.250-5.499	30	26	14	5750 305.000	11.800-12.399	45	26	16	5750 411.500
5.500-5.749	30	26	14	5750 305.200	12.400-12.899	45	26	16	5750 412.000
5.750-5.999	30	26	14	5750 305.500	12.900-13.399	45	26	16	5750 412.500
6.000-6.249	30	26	14	5750 305.700	13.400-13.899	45	26	16	5750 413.000
6.250-6.449	30	26	14	5750 306.000	13.900-14.399	45	26	16	5750 413.500
6.450-6.749	30	26	14	5750 306.200	14.400-14.899	45	26	16	5750 414.000
6.750-6.999	30	26	14	5750 306.500	14.900-15.399	45	26	16	5750 414.500
7.000-7.299	30	26	14	5750 306.700	15.400-15.899	45	26	16	5750 415.000
7.300-7.599	30	26	14	5750 307.000	15.900-16.399	45	26	16	5750 415.500
7.600-7.799	30	26	14	5750 307.300	16.400-16.899	45	26	16	5750 416.000
7.800-7.999	30	26	14	5750 307.500	16.900-17.399	45	26	16	5750 416.500
8.000-8.299	30	26	14	5750 307.700	17.400-17.899	45	26	16	5750 417.000
8.300-8.699	30	26	14	5750 308.000	17.900-18.399	45	26	16	5750 417.500
8.700-8.999	30	26	14	5750 308.400	18.400-19.509	45	26	16	5750 418.000
9.000-9.299	30	26	14	5750 308.700	19.510-20.509	45	26	16	5750 419.000
9.300-9.699	30	26	14	5750 309.000	20.510-21.509	45	26	16	5750 420.000
9.700-9.999	30	26	14	5750 309.400	21.510-22.609	45	26	16	5750 421.000
10.000-10.299	30	26	14	5750 309.700	22.610-23.609	45	26	16	5750 422.000
10.300-10.799	30	26	14	5750 310.000	23.610-24.609	45	26	16	5750 423.000
10.800-11.299	30	26	14	5750 310.500	24.610-25.609	45	26	16	5750 424.000
11.300-11.799	30	26	14	5750 311.000	25.610-26.609	45	26	16	5750 425.000
11.800-12.399	30	26	14	5750 311.500	26.610-27.609	45	26	16	5750 426.000



Article no.				5750	Article no.				5750
d1	d2 n6 mm	l1 mm	l2 mm	Order no.	d1	d2 n6 mm	l1 mm	l2 mm	Order no.
27.610-28.609	45	26	16	5750 427.000	34.700-36.699	55	26	14	5750 534.000
28.610-29.609	45	26	16	5750 428.000	36.700-38.699	55	26	14	5750 536.000
29.610-30.609	45	26	16	5750 429.000	38.700-42.699	55	26	14	5750 538.000
30.610-32.609	45	26	16	5750 430.000	42.700-45.699	55	26	14	5750 542.000
32.610-34.699	45	26	16	5750 432.000	45.700-48.999	55	26	14	5750 545.000
34.700-36.699	45	26	16	5750 434.000					

Deep hole drills



Moulded steady rest bushings for single-fluted gun drills

Article no. **5767**

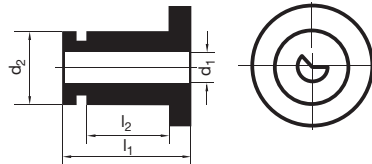

Article no. 5767				Article no. 5767					
d1	d2 n6 mm	l1 mm	l2 mm	Order no.	d1	d2 n6 mm	l1 mm	l2 mm	Order no.
2.000-2.099	20	20	12	5767 201.900	5.750-5.999	30	26	14	5767 305.500
2.100-2.199	20	20	12	5767 202.000	6.000-6.249	30	26	14	5767 305.700
2.200-2.299	20	20	12	5767 202.100	6.250-6.449	30	26	14	5767 306.000
2.300-2.399	20	20	12	5767 202.200	6.450-6.749	30	26	14	5767 306.200
2.400-2.499	20	20	12	5767 202.300	6.750-6.999	30	26	14	5767 306.500
2.500-2.599	20	20	12	5767 202.400	7.000-7.299	30	26	14	5767 306.700
2.600-2.699	20	20	12	5767 202.500	7.300-7.599	30	26	14	5767 307.000
2.700-2.799	20	20	12	5767 202.600	7.600-7.799	30	26	14	5767 307.300
2.800-2.899	20	20	12	5767 202.700	7.800-7.999	30	26	14	5767 307.500
2.900-3.099	20	20	12	5767 202.800	8.000-8.299	30	26	14	5767 307.700
3.100-3.359	20	20	12	5767 203.000	8.300-8.699	30	26	14	5767 308.000
3.360-3.459	20	20	12	5767 203.200	8.700-8.999	30	26	14	5767 308.400
3.460-3.559	20	20	12	5767 203.300	9.000-9.299	30	26	14	5767 308.700
3.560-3.799	20	20	12	5767 203.400	9.300-9.699	30	26	14	5767 309.000
3.800-3.959	20	20	12	5767 203.600	9.700-9.999	30	26	14	5767 309.400
3.960-4.259	20	20	12	5767 203.700	10.000-10.299	30	26	14	5767 309.700
4.260-4.499	20	20	12	5767 204.000	10.300-10.799	30	26	14	5767 310.000
4.500-4.749	20	20	12	5767 204.200	10.800-11.299	30	26	14	5767 310.500
4.750-4.999	20	20	12	5767 204.500	11.300-11.799	30	26	14	5767 311.000
5.000-5.249	20	20	12	5767 204.700	11.800-12.399	30	26	14	5767 311.500
5.250-5.499	20	20	12	5767 205.000	12.400-12.899	30	26	14	5767 312.000
5.500-5.749	20	20	12	5767 205.200	12.900-13.399	30	26	14	5767 312.500
5.750-5.999	20	20	12	5767 205.500	13.400-13.899	30	26	14	5767 313.000
6.000-6.249	20	20	12	5767 205.700	13.900-14.399	30	26	14	5767 313.500
6.250-6.449	20	20	12	5767 206.000	14.400-14.899	30	26	14	5767 314.000
6.450-6.749	20	20	12	5767 206.200	14.900-15.399	30	26	14	5767 314.500
6.750-6.999	20	20	12	5767 206.500	15.400-15.899	30	26	14	5767 315.000
7.000-7.299	20	20	12	5767 206.700	15.900-16.399	30	26	14	5767 315.500
7.300-7.599	20	20	12	5767 207.000	16.400-16.899	30	26	14	5767 316.000
7.600-7.799	20	20	12	5767 207.300	16.900-17.399	30	26	14	5767 316.500
7.800-7.999	20	20	12	5767 207.500	17.400-17.899	30	26	14	5767 317.000
8.000-8.299	20	20	12	5767 207.700	17.900-18.399	30	26	14	5767 317.500
8.300-8.699	20	20	12	5767 208.000	18.400-19.509	30	26	14	5767 318.000
8.700-8.999	20	20	12	5767 208.400	19.510-20.509	30	26	14	5767 319.000
9.000-9.299	20	20	12	5767 208.700	20.510-21.509	30	26	14	5767 320.000
9.300-9.699	20	20	12	5767 209.000	21.510-22.609	30	26	14	5767 321.000
9.700-9.999	20	20	12	5767 209.400	22.610-23.609	30	26	14	5767 322.000
10.000-10.299	20	20	12	5767 209.700	23.610-24.609	30	26	14	5767 323.000
10.300-10.799	20	20	12	5767 210.000	20.510-21.509	45	26	16	5767 420.000
10.800-11.299	20	20	12	5767 210.500	21.510-22.609	45	26	16	5767 421.000
11.300-11.799	20	20	12	5767 211.000	22.610-23.609	45	26	16	5767 422.000
11.800-12.399	20	20	12	5767 211.500	23.610-24.609	45	26	16	5767 423.000
3.100-3.359	30	26	14	5767 303.000	24.610-25.609	45	26	16	5767 424.000
3.360-3.459	30	26	14	5767 303.200	25.610-26.609	45	26	16	5767 425.000
3.460-3.559	30	26	14	5767 303.300	26.610-27.609	45	26	16	5767 426.000
3.560-3.799	30	26	14	5767 303.400	27.610-28.609	45	26	16	5767 427.000
3.800-3.959	30	26	14	5767 303.600	28.610-29.609	45	26	16	5767 428.000
3.960-4.259	30	26	14	5767 303.700	29.610-30.609	45	26	16	5767 429.000
4.260-4.499	30	26	14	5767 304.000	30.610-32.609	45	26	16	5767 430.000
4.500-4.749	30	26	14	5767 304.200	32.610-34.699	45	26	16	5767 432.000
4.750-4.999	30	26	14	5767 304.500	34.700-36.699	45	26	16	5767 434.000
5.000-5.249	30	26	14	5767 304.700	36.700-38.699	45	26	16	5767 436.000
5.250-5.499	30	26	14	5767 305.000					
5.500-5.749	30	26	14	5767 305.200					



Sealing washers für single-fluted gun drills

Article no. 5752

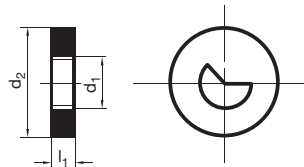

Deep hole drills

Article no. 5752			Article no. 5752				
d1	d2 n6 mm	l1 mm	Order no.	d1	d2 n6 mm	l1 mm	Order no.
1,850-1,999	20	3	5752 101.800	5,750-5,999	40	4	5752 405.500
2,000-2,099	20	3	5752 101.900	6,000-6,249	40	4	5752 405.700
2,100-2,199	20	3	5752 102.000	6,250-6,499	40	4	5752 406.000
2,200-2,299	20	3	5752 102.100	6,450-6,749	40	4	5752 406.200
2,300-2,399	20	3	5752 102.200	6,750-6,999	40	4	5752 406.500
2,400-2,499	20	3	5752 102.300	7,000-7,299	40	4	5752 406.700
2,500-2,599	20	3	5752 102.400	7,300-7,599	40	4	5752 407.000
2,600-2,699	20	3	5752 102.500	7,600-7,799	40	4	5752 407.300
2,700-2,799	20	3	5752 102.600	7,800-7,999	40	4	5752 407.500
2,800-2,899	20	3	5752 102.700	8,000-8,299	40	4	5752 407.700
2,900-3,099	20	3	5752 102.800	8,300-8,699	40	4	5752 408.000
3,100-3,359	20	3	5752 103.000	8,700-8,999	40	4	5752 408.400
3,360-3,459	20	3	5752 103.200	9,000-9,299	40	4	5752 408.700
3,460-3,559	20	3	5752 103.300	9,300-9,699	40	4	5752 409.000
3,560-3,799	20	3	5752 103.400	9,700-9,999	40	4	5752 409.400
3,800-3,959	20	3	5752 103.600	10,000-10,299	40	4	5752 409.700
3,960-4,259	20	3	5752 103.700	10,300-10,799	40	4	5752 410.000
4,260-4,499	20	3	5752 104.000	10,800-11,299	40	4	5752 410.500
4,500-4,749	20	3	5752 104.200	11,300-11,799	40	4	5752 411.000
4,750-4,999	20	3	5752 104.500	11,800-12,399	40	4	5752 411.500
5,000-5,249	20	3	5752 104.700	12,400-12,899	40	4	5752 412.000
5,250-5,499	20	3	5752 105.000	12,900-13,399	40	4	5752 412.500
5,000-5,249	32	3	5752 204.700	13,400-13,899	40	4	5752 413.000
5,250-5,499	32	3	5752 205.000	13,900-14,399	40	4	5752 413.500
5,500-5,749	32	4	5752 305.200	14,400-14,899	40	4	5752 414.000
5,750-5,999	32	4	5752 305.500	14,900-15,399	40	4	5752 414.500
6,000-6,249	32	4	5752 305.700	15,400-15,899	40	4	5752 415.000
6,250-6,449	32	4	5752 306.000	15,900-16,399	40	4	5752 415.500
6,450-6,749	32	4	5752 306.200	16,400-16,899	40	4	5752 416.000
6,750-6,999	32	4	5752 306.500	16,900-17,399	40	4	5752 416.500
7,000-7,299	32	4	5752 306.700	17,400-17,899	40	4	5752 417.000
7,300-7,599	32	4	5752 307.000	17,900-18,399	40	4	5752 417.500
7,600-7,799	32	4	5752 307.300	18,400-19,509	40	4	5752 418.000
7,800-7,999	32	4	5752 307.500	19,510-20,509	40	4	5752 419.000
8,000-8,299	32	4	5752 307.700	20,510-21,509	40	4	5752 420.000
8,300-8,699	32	4	5752 308.000	21,510-22,609	40	4	5752 421.000
8,700-8,999	32	4	5752 308.400	22,610-23,609	40	4	5752 422.000
9,000-9,299	32	4	5752 308.700	23,610-24,609	40	4	5752 423.000
9,300-9,699	32	4	5752 309.000	23,610-24,609	90	4	5752 923.000
9,700-9,999	32	4	5752 309.400	24,610-25,609	90	4	5752 924.000
10,000-10,299	32	4	5752 309.700	25,610-26,609	90	4	5752 925.000
10,300-10,799	32	4	5752 310.000	26,610-27,609	90	4	5752 926.000
10,800-11,299	32	4	5752 310.500	27,610-28,609	90	4	5752 927.000
11,300-11,799	32	4	5752 311.000	28,610-29,609	90	4	5752 928.000
11,800-12,399	32	4	5752 311.500	29,610-30,609	90	4	5752 929.000
12,400-12,899	32	4	5752 312.000	30,610-32,609	90	4	5752 930.000
12,900-13,399	32	4	5752 312.500	32,610-34,699	90	4	5752 932.000
13,400-13,899	32	4	5752 313.000	34,700-36,699	90	4	5752 934.000
13,900-14,399	32	4	5752 313.500	36,700-38,699	90	4	5752 936.000
14,400-14,899	32	4	5752 314.000	38,700-42,699	90	4	5752 938.000
14,900-15,399	32	4	5752 314.500	42,700-45,699	90	4	5752 942.000
15,400-15,899	32	4	5752 315.000	45,700-48,999	90	4	5752 945.000
15,900-16,399	32	4	5752 315.500				
16,400-16,899	32	4	5752 316.000				
16,900-17,399	32	4	5752 316.500				
17,400-17,899	32	4	5752 317.000				
17,900-18,399	32	4	5752 317.500				
18,400-19,509	32	4	5752 318.000				
19,510-20,509	32	4	5752 319.000				
5,500-5,749	40	4	5752 405.200				



Sealing washers für single-fluted gun drills

Article no. **5770**

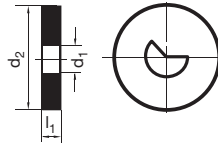

Article no. 5770			Article no. 5770		
d1	d2 n6 mm	l1 mm	d1	d2 n6 mm	l1 mm
4,000-4,259	26	4	22.610-23.609	56	4
4.260-4.499	26	4	23.610-24.609	56	4
4.500-4.749	26	4	24.610-25.609	56	4
4.750-4.999	26	4	25.610-26.609	56	4
5.000-5.249	26	4	26.610-27.609	56	4
5.250-5.499	26	4	27.610-28.609	56	4
5.500-5.749	26	4	28.610-29.609	56	4
5.750-5.999	26	4	29.610-30.609	56	4
6.000-6.249	26	4	30.610-32.609	56	4
6.250-6.449	26	4	32.610-34.699	56	4
6.450-6.749	26	4	34.700-36.699	56	4
6.750-6.999	26	4	6.000-6.249	65	4
7.000-7.299	26	4	8.000-8.299	65	4
7.300-7.599	26	4	9.000-9.299	65	4
7.600-7.799	26	4	10.000-10.299	65	4
7.800-7.999	26	4	10.800-11.299	65	4
8.000-8.299	26	4	12.400-12.899	65	4
6.000-6.249	46	4	12.900-13.399	65	4
6.450-6.749	46	4	13.900-14.399	65	4
7.000-7.299	46	4	14.400-14.899	65	4
8.000-8.299	46	4	14.900-15.399	65	4
9.000-9.299	46	4	15.900-16.399	65	4
9.300-9.699	46	4	16,400-16,899	65	4
9.700-9.999	46	4	16.900-17.399	65	4
10.000-10.299	46	4	17.900-18.399	65	4
10.300-10.799	46	4	20.510-21.509	65	4
10.800-11.299	46	4	21.510-22.609	65	4
11.300-11.799	46	4	7.000-7.299	76	4
11.800-12.399	46	4	21.510-22.609	76	4
12.400-12.899	46	4	22.610-23.609	76	4
12.900-13.399	46	4	25.610-26.609	76	4
13,400-13,899	46	4	26.610-27.609	76	4
13.900-14.399	46	4	27.610-28.609	76	4
14.400-14.899	46	4	28.610-29.609	76	4
14.900-15.399	46	4	29.610-30.609	76	4
15.400-15.899	46	4	34.700-36.699	76	4
15.900-16.399	46	4	36.700-38.699	76	4
16,400-16,899	46	4	38,700-42,699	76	4
16.900-17.399	46	4			
17.400-17.899	46	4			
17.900-18.399	46	4			
18.400-19.509	46	4			
19.510-20.509	46	4			
20.510-21.509	46	4			
21.510-22.609	46	4			
12.400-12.899	56	4			
20.510-21.509	56	4			
21.510-22.609	56	4			



Sealing washers für single-fluted gun drills

Article no. 5772

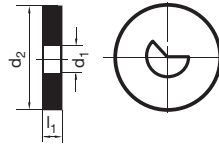

Deep hole drills

Article no. 5772			Article no. 5772		
d1	d2 n6 mm	l1 mm	d1	d2 n6 mm	l1 mm
2,900-3,599	20	7	16,400-17,999	40	12
3,600-4,399	20	7	18,000-19,799	40	12
4,400-5,249	20	7	19,800-21,799	40	12
5,250-5,999	32	11	21,800-23,799	40	12
6,000-6,799	32	11	23,800-25,999	40	12
6,800-7,699	32	11	26,000-27,999	90	12
7,700-8,699	32	11	28,000-29,999	90	12
8,700-9,999	32	11	30,000-31,999	90	12
10,000-11,399	32	11	32,000-34,999	90	12
11,400-12,949	32	11	35,000-36,999	90	12
12,950-14,449	32	11	37,000-38,999	90	12
14,450-16,399	32	11	39,000-40,999	90	12



Deep hole drills

Adjustment screws

Article no. **5754**

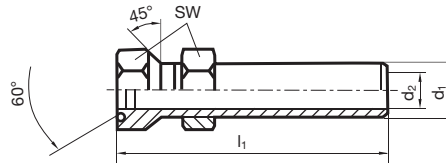

Article no. **5754**

d1	d2 mm	l1 mm	SW mm	Order no.
M6 x 0,5	3.5	26	9	5754 6.000
M6 x 0,5	3.5	45	9	5754 6.001
M10 x 1	6.0	38	13	5754 10.000
M16 x 1,5	10.0	57	22	5754 16.000

Adjustment screws

Article no. **5755**

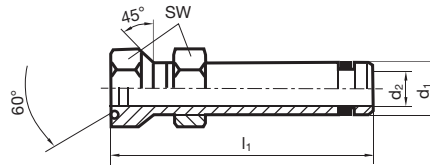

Article no. **5755**

d1	d2 mm	l1 mm	SW mm	Order no.
M10 X1	6.0	50	13	5755 10.000
M16 X1.5	10.0	65	22	5755 16.000
M24X1.5	16.0	90	30	5755 24.000



Sealing plugs

Article no. 5766

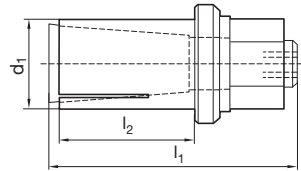

sealing plugs for sealing coolant bores • special dimensions on request

Article no.

5766

d1 mm	l1 mm	l2 mm	Order no.
8.000	28	15	5766 108.000
9.000	30	15	5766 109.000
10.000	30	15	5766 110.000
11.000	34	18	5766 111.000
12.000	34	18	5766 112.000
13.000	37	20	5766 113.000
14.000	37	20	5766 114.000
15.000	37	20	5766 115.000
16.000	37	20	5766 116.000
17.000	37	20	5766 117.000
18.000	37	20	5766 118.000
19.000	44	20	5766 119.000
20.000	44	20	5766 120.000
21.000	44	20	5766 121.000
22.000	44	20	5766 122.000
23.000	44	20	5766 123.000
24.000	44	20	5766 124.000
25.000	44	20	5766 125.000
8.000	71	58	5766 208.000
9.000	76	63	5766 209.000
10.000	89	73	5766 210.000
11.000	89	73	5766 211.000
12.000	99	83	5766 212.000
13.000	110	93	5766 213.000
14.000	110	93	5766 214.000
15.000	115	98	5766 215.000
16.000	115	98	5766 216.000
17.000	115	98	5766 217.000
18.000	120	98	5766 218.000
19.000	120	98	5766 219.000
20.000	120	98	5766 220.000
21.000	120	98	5766 221.000
22.000	120	98	5766 222.000
23.000	120	98	5766 223.000
24.000	120	98	5766 224.000
25.000	120	98	5766 225.000



Torque wrenches set

Article no. **4966**

with torque wrench • incl. torque setting tool, bit holder and bits • order screwdriver art. no. 1612 separately



Article no. **4966**

Drive	Bit sizes	Torque Nm	Order no.
1/4	T5/T7/T8	0,4-1	4966 1.000
1/4	T8/T9/T15/T20	1-5	4966 2.000

Torque wrenches

Article no. **4915**



Article no. **4915**

Torx	Key size	Torque Nm	Type	Order no.
1/4	hexagonal	0,4-1	A	4915 1.001
1/4	hexagonal	0,5-2	A	4915 2.000
1/4	hexagonal	0,8-5	A	4915 5.001
1/4	hexagonal	2-8	A	4915 8.000
1/4	hexagonal	5-14	D	4915 14.000
3/8	square	10-50	B	4915 50.000
1/2	square	20-200	C	4915 200.000

Torx screwdrivers

Article no. **1612**

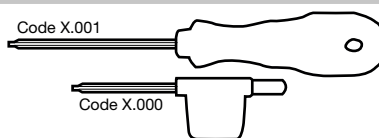

Article no. **1612**

Size	Order no.
T5	1612 5.001
T6	1612 6.000
T6	1612 6.001
T7	1612 7.000
T7	1612 7.001
T8	1612 8.000
T8	1612 8.001
T9	1612 9.001
T10	1612 10.001
T15	1612 15.000
T15	1612 15.001
T20	1612 20.001
T25	1612 25.001
T30	1612 30.001



Torx socket sets

Article no. **4917**

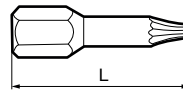

Article no. **4917**

Drive	Key size	Torx	L mm	Order no.
1/4	hexagonal	T5	25	4917 5.000
1/4	hexagonal	T6	25	4917 6.000
1/4	hexagonal	T7	25	4917 7.000
1/4	hexagonal	T8	25	4917 8.000
1/4	hexagonal	T9	25	4917 9.000
1/4	hexagonal	T10	25	4917 10.000
1/4	hexagonal	T15	25	4917 15.000
1/4	hexagonal	T20	25	4917 20.000
1/2	square	T25	25	4917 25.000

Clamping screws

Article no. **4071**

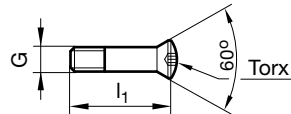

Article no. **4071**

G	l1 mm	Torx	Order no.
M1,6	3.80	T5	4071 1.600
M1,6	4.40	T5	4071 1.601
M2,2	9.50	T7	4071 2.200
M2,2	10.50	T7	4071 2.201
M2,2	5.60	T7	4071 2.202
M2,2	4.60	T7	4071 2.203
M2,5	11.40	T8	4071 2.500
M2,5	6.40	T8	4071 2.501
M2,5	5.20	T8	4071 2.502
M3	12.10	T9	4071 3.000
M3	13.10	T9	4071 3.001
M3	6.40	T9	4071 3.002
M3	8.00	T9	4071 3.003
M3,5	14.25	T10	4071 3.500
M4	16.00	T15	4071 4.000
M4	7.70	T15	4071 4.001
M4	10.60	T15	4071 4.002
M4,5	18.00	T15	4071 4.500
M4,5	11.80	T15	4071 4.501
M5	19.75	T20	4071 5.000
M5	21.75	T20	4071 5.001
M5	14.20	T20	4071 5.002
M5	23.40	T20	4071 5.003
M6	27.00	T25	4071 6.000
M6	28.50	T25	4071 6.001
M6	32.50	T25	4071 6.002



HSS/HSCO drills with straight shank

HSS/HSCO drills

Twist drills with standard shank

Article no. **6005**



Cutting data page 441

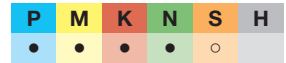
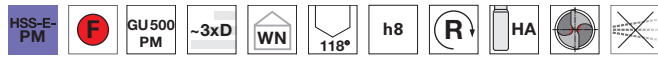

Web thinning $\geq \varnothing 1.000$ • high-performance twist drills • powder metallurgical steel • 4-facet point grind • low feed force required • low torque required • for universal application

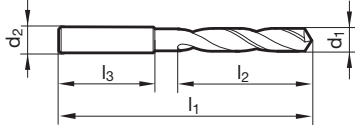

Article no.				6005				Article no.				6005			
d1 mm	inch	l1 mm	l2 mm	Order no.	d1 mm	inch	l1 mm	l2 mm	Order no.	d1 mm	inch	l1 mm	l2 mm	Order no.	
1.000		38.0	6.0	6005 1.000	4.050		66.0	22.0	6005 4.050						
1.050		38.0	6.0	6005 1.050	4.100		66.0	22.0	6005 4.100						
1.100		39.0	7.0	6005 1.100	4.150		66.0	22.0	6005 4.150						
1.150		39.0	7.0	6005 1.150	4.200		66.0	22.0	6005 4.200						
1.200		40.0	8.0	6005 1.200	4.250		66.0	22.0	6005 4.250						
1.250		40.0	8.0	6005 1.250	4.300		68.0	24.0	6005 4.300						
1.300		40.0	8.0	6005 1.300	4.350		68.0	24.0	6005 4.350						
1.350		41.0	9.0	6005 1.350	4.370	11/64	68.0	24.0	6005 4.370						
1.400		41.0	9.0	6005 1.400	4.400		68.0	24.0	6005 4.400						
1.450		41.0	9.0	6005 1.450	4.450		68.0	24.0	6005 4.450						
1.500		41.0	9.0	6005 1.500	4.500		68.0	24.0	6005 4.500						
1.550		42.0	10.0	6005 1.550	4.550		68.0	24.0	6005 4.550						
1.600		42.0	10.0	6005 1.600	4.600		68.0	24.0	6005 4.600						
1.650		42.0	10.0	6005 1.650	4.650		68.0	24.0	6005 4.650						
1.700		42.0	10.0	6005 1.700	4.700		68.0	24.0	6005 4.700						
1.750		43.0	11.0	6005 1.750	4.750		68.0	24.0	6005 4.750						
1.800		43.0	11.0	6005 1.800	4.760	3/16	70.0	26.0	6005 4.760						
1.850		43.0	11.0	6005 1.850	4.800		70.0	26.0	6005 4.800						
1.900		43.0	11.0	6005 1.900	4.850		70.0	26.0	6005 4.850						
1.950		44.0	12.0	6005 1.950	4.900		70.0	26.0	6005 4.900						
2.000		44.0	12.0	6005 2.000	4.950		70.0	26.0	6005 4.950						
2.050		44.0	12.0	6005 2.050	5.000		70.0	26.0	6005 5.000						
2.100		44.0	12.0	6005 2.100	5.050		70.0	26.0	6005 5.050						
2.150		45.0	13.0	6005 2.150	5.100		70.0	26.0	6005 5.100						
2.200		45.0	13.0	6005 2.200	5.150		70.0	26.0	6005 5.150						
2.250		45.0	13.0	6005 2.250	5.160	13/64	70.0	26.0	6005 5.160						
2.300		45.0	13.0	6005 2.300	5.200		70.0	26.0	6005 5.200						
2.350		45.0	13.0	6005 2.350	5.250		70.0	26.0	6005 5.250						
2.380	3/32	46.0	14.0	6005 2.380	5.300		70.0	26.0	6005 5.300						
2.400		46.0	14.0	6005 2.400	5.350		72.0	28.0	6005 5.350						
2.450		46.0	14.0	6005 2.450	5.400		72.0	28.0	6005 5.400						
2.500		46.0	14.0	6005 2.500	5.450		72.0	28.0	6005 5.450						
2.550		46.0	14.0	6005 2.550	5.500		72.0	28.0	6005 5.500						
2.600		46.0	14.0	6005 2.600	5.550		72.0	28.0	6005 5.550						
2.650		46.0	14.0	6005 2.650	5.560	7/32	72.0	28.0	6005 5.560						
2.700		48.0	16.0	6005 2.700	5.600		72.0	28.0	6005 5.600						
2.750		48.0	16.0	6005 2.750	5.650		72.0	28.0	6005 5.650						
2.780	7/64	48.0	16.0	6005 2.780	5.700		72.0	28.0	6005 5.700						
2.800		48.0	16.0	6005 2.800	5.750		72.0	28.0	6005 5.750						
2.850		48.0	16.0	6005 2.850	5.800		72.0	28.0	6005 5.800						
2.900		48.0	16.0	6005 2.900	5.850		72.0	28.0	6005 5.850						
2.950		48.0	16.0	6005 2.950	5.900		72.0	28.0	6005 5.900						
3.000		48.0	16.0	6005 3.000	5.950	15/64	72.0	28.0	6005 5.950						
3.050		50.0	18.0	6005 3.050	6.000		72.0	28.0	6005 6.000						
3.100		50.0	18.0	6005 3.100	6.050		75.0	31.0	6005 6.050						
3.150		50.0	18.0	6005 3.150	6.100		75.0	31.0	6005 6.100						
3.170	1/8	50.0	18.0	6005 3.170	6.150		75.0	31.0	6005 6.150						
3.200		50.0	18.0	6005 3.200	6.200		75.0	31.0	6005 6.200						
3.250		50.0	18.0	6005 3.250	6.250		75.0	31.0	6005 6.250						
3.300		50.0	18.0	6005 3.300	6.300		75.0	31.0	6005 6.300						
3.350		50.0	18.0	6005 3.350	6.350	1/4	75.0	31.0	6005 6.350						
3.400		52.0	20.0	6005 3.400	6.400		75.0	31.0	6005 6.400						
3.450		52.0	20.0	6005 3.450	6.450		75.0	31.0	6005 6.450						
3.500		52.0	20.0	6005 3.500	6.500		75.0	31.0	6005 6.500						
3.550		52.0	20.0	6005 3.550	6.550		75.0	31.0	6005 6.550						
3.570	9/64	52.0	20.0	6005 3.570	6.600		75.0	31.0	6005 6.600						
3.600		52.0	20.0	6005 3.600	6.650		75.0	31.0	6005 6.650						
3.650		52.0	20.0	6005 3.650	6.700		75.0	31.0	6005 6.700						
3.700		52.0	20.0	6005 3.700	6.750	17/64	78.0	34.0	6005 6.750						
3.750		52.0	20.0	6005 3.750	6.800		78.0	34.0	6005 6.800						
3.800		54.0	22.0	6005 3.800	6.850		78.0	34.0	6005 6.850						
3.850		54.0	22.0	6005 3.850	6.900		78.0	34.0	6005 6.900						
3.900		54.0	22.0	6005 3.900	6.950		78.0	34.0	6005 6.950						
3.950		54.0	22.0	6005 3.950	7.000		78.0	34.0	6005 7.000						
3.970	5/32	54.0	22.0	6005 3.970	7.050		78.0	34.0	6005 7.050						
4.000		54.0	22.0	6005 4.000	7.100		78.0	34.0	6005 7.100						



Article no.				6005	Article no.				6005
d1 mm	inch	l1 mm	l2 mm	Order no.	d1 mm	inch	l1 mm	l2 mm	Order no.
7.140	9/32	78.0	34.0	6005 7.140	10.500		100.0	43.0	6005 10.500
7.150		78.0	34.0	6005 7.150	10.600		100.0	43.0	6005 10.600
7.200		78.0	34.0	6005 7.200	10.700		104.0	47.0	6005 10.700
7.250		78.0	34.0	6005 7.250	10.720	27/64	104.0	47.0	6005 10.720
7.300		78.0	34.0	6005 7.300	10.800		104.0	47.0	6005 10.800
7.350		78.0	34.0	6005 7.350	10.900		104.0	47.0	6005 10.900
7.400		78.0	34.0	6005 7.400	11.000		104.0	47.0	6005 11.000
7.450		78.0	34.0	6005 7.450	11.100		104.0	47.0	6005 11.100
7.500		78.0	34.0	6005 7.500	11.110	7/16	104.0	47.0	6005 11.110
7.540	19/64	81.0	37.0	6005 7.540	11.200		104.0	47.0	6005 11.200
7.550		81.0	37.0	6005 7.550	11.300		104.0	47.0	6005 11.300
7.600		81.0	37.0	6005 7.600	11.400		104.0	47.0	6005 11.400
7.650		81.0	37.0	6005 7.650	11.500		104.0	47.0	6005 11.500
7.700		81.0	37.0	6005 7.700	11.510	29/64	104.0	47.0	6005 11.510
7.750		81.0	37.0	6005 7.750	11.600		104.0	47.0	6005 11.600
7.800		81.0	37.0	6005 7.800	11.700		104.0	47.0	6005 11.700
7.850		81.0	37.0	6005 7.850	11.800		104.0	47.0	6005 11.800
7.900		81.0	37.0	6005 7.900	11.900		108.0	51.0	6005 11.900
7.940	5/16	81.0	37.0	6005 7.940	11.910	15/32	108.0	51.0	6005 11.910
7.950		81.0	37.0	6005 7.950	12.000		108.0	51.0	6005 12.000
8.000		81.0	37.0	6005 8.000	12.100		111.0	51.0	6005 12.100
8.050		87.0	37.0	6005 8.050	12.200		111.0	51.0	6005 12.200
8.100		87.0	37.0	6005 8.100	12.300	31/64	111.0	51.0	6005 12.300
8.150		87.0	37.0	6005 8.150	12.400		111.0	51.0	6005 12.400
8.200		87.0	37.0	6005 8.200	12.500		111.0	51.0	6005 12.500
8.300		87.0	37.0	6005 8.300	12.600		111.0	51.0	6005 12.600
8.330	21/64	87.0	37.0	6005 8.330	12.700	1/2	111.0	51.0	6005 12.700
8.400		87.0	37.0	6005 8.400	12.800		111.0	51.0	6005 12.800
8.500		87.0	37.0	6005 8.500	12.900		111.0	51.0	6005 12.900
8.600		91.0	40.0	6005 8.600	13.000		111.0	51.0	6005 13.000
8.700		91.0	40.0	6005 8.700	13.100	33/64	111.0	51.0	6005 13.100
8.730	11/32	91.0	40.0	6005 8.730	13.490	17/32	114.0	54.0	6005 13.490
8.800		91.0	40.0	6005 8.800	13.500		114.0	54.0	6005 13.500
8.900		91.0	40.0	6005 8.900	13.890	35/64	114.0	54.0	6005 13.890
9.000		91.0	40.0	6005 9.000	14.000		114.0	54.0	6005 14.000
9.100		91.0	40.0	6005 9.100	14.290	9/16	116.0	56.0	6005 14.290
9.130	23/64	91.0	40.0	6005 9.130	14.500		116.0	56.0	6005 14.500
9.200		91.0	40.0	6005 9.200	15.000		116.0	56.0	6005 15.000
9.300		91.0	40.0	6005 9.300	15.500		118.0	58.0	6005 15.500
9.400		91.0	40.0	6005 9.400	15.870	5/8	118.0	58.0	6005 15.870
9.500		91.0	40.0	6005 9.500	16.000		118.0	58.0	6005 16.000
9.520	3/8	93.0	43.0	6005 9.520	16.500		126.0	60.0	6005 16.500
9.550		93.0	43.0	6005 9.550	16.670	21/32	126.0	60.0	6005 16.670
9.600		93.0	43.0	6005 9.600	17.000		126.0	60.0	6005 17.000
9.700		93.0	43.0	6005 9.700	17.500		128.0	62.0	6005 17.500
9.800		93.0	43.0	6005 9.800	18.000		128.0	62.0	6005 18.000
9.900		93.0	43.0	6005 9.900	18.500		130.0	64.0	6005 18.500
9.920	25/64	93.0	43.0	6005 9.920	19.000		130.0	64.0	6005 19.000
10.000		93.0	43.0	6005 10.000	19.500		132.0	66.0	6005 19.500
10.100		100.0	43.0	6005 10.100	20.000		132.0	66.0	6005 20.000
10.200		100.0	43.0	6005 10.200					
10.300		100.0	43.0	6005 10.300					
10.320	13/32	100.0	43.0	6005 10.320					
10.400		100.0	43.0	6005 10.400					

HSS/HSCO drills



HSS/HSCO drills with straight shank

Twist drills with standard shank

Article no. **6006**



Cutting data page 441

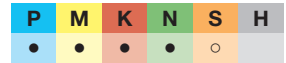

Web thinning $\geq \varnothing 1.000$ • high-performance twist drills • powder metallurgical steel • 4-facet point grind • low feed force required • low torque required • for universal application

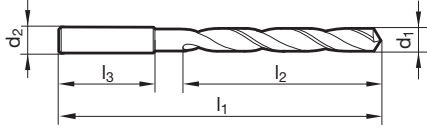

Article no. 6006				Article no. 6006					
d1 mm	inch	l1 mm	l2 mm	Order no.	d1 mm	inch	l1 mm	l2 mm	Order no.
2.000		56.0	24.0	6006 2.000	7.140	9/32	113.0	69.0	6006 7.140
2.100		56.0	24.0	6006 2.100	7.200		113.0	69.0	6006 7.200
2.200		59.0	27.0	6006 2.200	7.300		113.0	69.0	6006 7.300
2.300		59.0	27.0	6006 2.300	7.400		113.0	69.0	6006 7.400
2.380	3/32	62.0	30.0	6006 2.380	7.500		113.0	69.0	6006 7.500
2.400		62.0	30.0	6006 2.400	7.540	19/64	119.0	75.0	6006 7.540
2.500		62.0	30.0	6006 2.500	7.550		119.0	75.0	6006 7.550
2.600		62.0	30.0	6006 2.600	7.600		119.0	75.0	6006 7.600
2.700		65.0	33.0	6006 2.700	7.700		119.0	75.0	6006 7.700
2.780	7/64	65.0	33.0	6006 2.780	7.800		119.0	75.0	6006 7.800
2.800		65.0	33.0	6006 2.800	7.900		119.0	75.0	6006 7.900
2.900		65.0	33.0	6006 2.900	7.940	5/16	119.0	75.0	6006 7.940
3.000		65.0	33.0	6006 3.000	8.000		119.0	75.0	6006 8.000
3.100		68.0	36.0	6006 3.100	8.100		125.0	75.0	6006 8.100
3.170	1/8	68.0	36.0	6006 3.170	8.200		125.0	75.0	6006 8.200
3.200		68.0	36.0	6006 3.200	8.300		125.0	75.0	6006 8.300
3.300		68.0	36.0	6006 3.300	8.330	21/64	125.0	75.0	6006 8.330
3.400		71.0	39.0	6006 3.400	8.400		125.0	75.0	6006 8.400
3.500		71.0	39.0	6006 3.500	8.500		125.0	75.0	6006 8.500
3.570	9/64	71.0	39.0	6006 3.570	8.600		131.0	81.0	6006 8.600
3.600		71.0	39.0	6006 3.600	8.700		131.0	81.0	6006 8.700
3.700		71.0	39.0	6006 3.700	8.730	11/32	131.0	81.0	6006 8.730
3.800		75.0	43.0	6006 3.800	8.800		131.0	81.0	6006 8.800
3.900		75.0	43.0	6006 3.900	8.900		131.0	81.0	6006 8.900
3.970	5/32	75.0	43.0	6006 3.970	9.000		131.0	81.0	6006 9.000
4.000		75.0	43.0	6006 4.000	9.100		131.0	81.0	6006 9.100
4.100		87.0	43.0	6006 4.100	9.130	23/64	131.0	81.0	6006 9.130
4.200		87.0	43.0	6006 4.200	9.200		131.0	81.0	6006 9.200
4.300		91.0	47.0	6006 4.300	9.300		131.0	81.0	6006 9.300
4.370	11/64	91.0	47.0	6006 4.370	9.400		131.0	81.0	6006 9.400
4.400		91.0	47.0	6006 4.400	9.500		131.0	81.0	6006 9.500
4.500		91.0	47.0	6006 4.500	9.520	3/8	137.0	87.0	6006 9.520
4.600		91.0	47.0	6006 4.600	9.550		137.0	87.0	6006 9.550
4.650		91.0	47.0	6006 4.650	9.600		137.0	87.0	6006 9.600
4.700		91.0	47.0	6006 4.700	9.700		137.0	87.0	6006 9.700
4.760	3/16	96.0	52.0	6006 4.760	9.800		137.0	87.0	6006 9.800
4.800		96.0	52.0	6006 4.800	9.900		137.0	87.0	6006 9.900
4.900		96.0	52.0	6006 4.900	9.920	25/64	137.0	87.0	6006 9.920
5.000		96.0	52.0	6006 5.000	10.000		137.0	87.0	6006 10.000
5.100		96.0	52.0	6006 5.100	10.100		144.0	87.0	6006 10.100
5.160	13/64	96.0	52.0	6006 5.160	10.200		144.0	87.0	6006 10.200
5.200		96.0	52.0	6006 5.200	10.300		144.0	87.0	6006 10.300
5.300		96.0	52.0	6006 5.300	10.320	13/32	144.0	87.0	6006 10.320
5.400		101.0	57.0	6006 5.400	10.400		144.0	87.0	6006 10.400
5.500		101.0	57.0	6006 5.500	10.500		144.0	87.0	6006 10.500
5.550		101.0	57.0	6006 5.550	10.600		144.0	87.0	6006 10.600
5.560	7/32	101.0	57.0	6006 5.560	10.700		151.0	94.0	6006 10.700
5.600		101.0	57.0	6006 5.600	10.720	27/64	151.0	94.0	6006 10.720
5.700		101.0	57.0	6006 5.700	10.800		151.0	94.0	6006 10.800
5.800		101.0	57.0	6006 5.800	10.900		151.0	94.0	6006 10.900
5.900		101.0	57.0	6006 5.900	11.000		151.0	94.0	6006 11.000
5.950	15/64	101.0	57.0	6006 5.950	11.100		151.0	94.0	6006 11.100
6.000		101.0	57.0	6006 6.000	11.110	7/16	151.0	94.0	6006 11.110
6.100		107.0	63.0	6006 6.100	11.200		151.0	94.0	6006 11.200
6.200		107.0	63.0	6006 6.200	11.300		151.0	94.0	6006 11.300
6.300		107.0	63.0	6006 6.300	11.400		151.0	94.0	6006 11.400
6.350	1/4	107.0	63.0	6006 6.350	11.500		151.0	94.0	6006 11.500
6.400		107.0	63.0	6006 6.400	11.510	29/64	151.0	94.0	6006 11.510
6.500		107.0	63.0	6006 6.500	11.600		151.0	94.0	6006 11.600
6.600		107.0	63.0	6006 6.600	11.700		151.0	94.0	6006 11.700
6.700		107.0	63.0	6006 6.700	11.800		151.0	94.0	6006 11.800
6.750	17/64	113.0	69.0	6006 6.750	11.900		158.0	101.0	6006 11.900
6.800		113.0	69.0	6006 6.800	11.910	15/32	158.0	101.0	6006 11.910
6.900		113.0	69.0	6006 6.900	12.000		158.0	101.0	6006 12.000
7.000		113.0	69.0	6006 7.000	12.100		161.0	101.0	6006 12.100
7.100		113.0	69.0	6006 7.100	12.200		161.0	101.0	6006 12.200



Article no.				6006	Article no.				6006
d1 mm	inch	l1 mm	l2 mm	Order no.	d1 mm	inch	l1 mm	l2 mm	Order no.
12.300	31/64	161.0	101.0	6006 12.300	16.000		172.0	112.0	6006 16.000
12.400		161.0	101.0	6006 12.400	16.500		181.0	115.0	6006 16.500
12.500		161.0	101.0	6006 12.500	16.670	21/32	181.0	115.0	6006 16.670
12.600		161.0	101.0	6006 12.600	17.000		181.0	115.0	6006 17.000
12.700	1/2	161.0	101.0	6006 12.700	17.460	11/16	184.0	118.0	6006 17.460
12.800		161.0	101.0	6006 12.800	17.500		184.0	118.0	6006 17.500
12.900		161.0	101.0	6006 12.900	18.000		184.0	118.0	6006 18.000
13.000		161.0	101.0	6006 13.000	18.500		188.0	122.0	6006 18.500
13.100	33/64	161.0	101.0	6006 13.100	19.000		188.0	122.0	6006 19.000
13.490	17/32	166.0	106.0	6006 13.490	19.500		191.0	125.0	6006 19.500
13.500		166.0	106.0	6006 13.500	20.000		191.0	125.0	6006 20.000
13.890	35/64	166.0	106.0	6006 13.890					
14.000		166.0	106.0	6006 14.000					
14.290	9/16	169.0	109.0	6006 14.290					
14.500		169.0	109.0	6006 14.500					
15.000		169.0	109.0	6006 15.000					
15.500		172.0	112.0	6006 15.500					
15.870	5/8	172.0	112.0	6006 15.870					

HSS/HSCO drills



HSS/HSCO drills with straight shank

HSS/HSCO drills

Stub drills

Article no. **223**



Cutting data page 442



Web thinning $\geq \varnothing 1.000$ • relieved cone • for use in automatic/capstan lathes • also suitable for hand drilling machines

Stub drills

Article no. **653**



Cutting data page 442



Web thinning $\geq \varnothing 1.000$ • relieved cone • for use in automatic/capstan lathes • also suitable for hand drilling machines

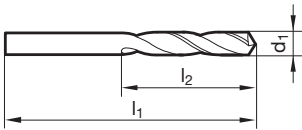

Article no. 223				653		Article no. 223				653	
d1 mm	inch	l1 mm	l2 mm	Order no.		d1 mm	inch	l1 mm	l2 mm	Order no.	
0.400	1/64	19.0	2.5	223 0.400		1.730		36.0	11.0	223 1.730	
0.480		19.0	2.5	223 0.480		1.740		36.0	11.0	223 1.740	
0.500		20.0	3.0	223 0.500	653 0.500	1.750		36.0	11.0	223 1.750	653 1.750
0.550		21.0	3.5	223 0.550		1.780		36.0	11.0	223 1.780	653 1.780
0.600		21.0	3.5	223 0.600	653 0.600	1.800		36.0	11.0	223 1.800	653 1.800
0.650		22.0	4.0	223 0.650		1.850		36.0	11.0	223 1.850	653 1.850
0.660		22.0	4.0	223 0.660		1.900		36.0	11.0	223 1.900	653 1.900
0.700		23.0	4.5	223 0.700	653 0.700	1.930		38.0	12.0	223 1.930	653 1.930
0.720		23.0	4.5	223 0.720		1.950		38.0	12.0	223 1.950	653 1.950
0.750		23.0	4.5	223 0.750	653 0.750	1.970		38.0	12.0	223 1.970	
0.790	1/32	24.0	5.0	223 0.790		1.980	5/64	38.0	12.0	223 1.980	653 1.980
0.800		24.0	5.0	223 0.800	653 0.800	1.990		38.0	12.0	223 1.990	653 1.990
0.820		24.0	5.0	223 0.820		2.000		38.0	12.0	223 2.000	653 2.000
0.825		24.0	5.0	223 0.825		2.020		38.0	12.0	223 2.020	
0.850		24.0	5.0	223 0.850		2.050		38.0	12.0	223 2.050	653 2.050
0.890		25.0	5.5	223 0.890		2.060		38.0	12.0	223 2.060	653 2.060
0.900		25.0	5.5	223 0.900	653 0.900	2.080		38.0	12.0	223 2.080	653 2.080
0.930		25.0	5.5	223 0.930		2.100		38.0	12.0	223 2.100	653 2.100
0.950		25.0	5.5	223 0.950		2.120		38.0	12.0	223 2.120	
0.980		26.0	6.0	223 0.980		2.150		40.0	13.0	223 2.150	653 2.150
1.000		26.0	6.0	223 1.000	653 1.000	2.180		40.0	13.0	223 2.180	653 2.180
1.020		26.0	6.0	223 1.020	653 1.020	2.200		40.0	13.0	223 2.200	653 2.200
1.040		26.0	6.0	223 1.040		2.220		40.0	13.0	223 2.220	
1.050		26.0	6.0	223 1.050	653 1.050	2.250		40.0	13.0	223 2.250	653 2.250
1.070		28.0	7.0	223 1.070	653 1.070	2.260		40.0	13.0	223 2.260	653 2.260
1.090		28.0	7.0	223 1.090	653 1.090	2.300		40.0	13.0	223 2.300	653 2.300
1.100		28.0	7.0	223 1.100	653 1.100	2.350		40.0	13.0	223 2.350	653 2.350
1.110		28.0	7.0		653 1.110	2.370		43.0	14.0	223 2.370	653 2.370
1.120		28.0	7.0		653 1.120	2.380	3/32	43.0	14.0	223 2.380	653 2.380
1.150		28.0	7.0	223 1.150	653 1.150	2.400		43.0	14.0	223 2.400	653 2.400
1.180		28.0	7.0	223 1.180	653 1.180	2.420		43.0	14.0	223 2.420	
1.190	3/64	30.0	8.0	223 1.190	653 1.190	2.440		43.0	14.0	223 2.440	653 2.440
1.200		30.0	8.0	223 1.200	653 1.200	2.450		43.0	14.0	223 2.450	653 2.450
1.250		30.0	8.0	223 1.250	653 1.250	2.480		43.0	14.0	223 2.480	
1.260		30.0	8.0	223 1.260		2.490		43.0	14.0	223 2.490	
1.280		30.0	8.0	223 1.280		2.500		43.0	14.0	223 2.500	653 2.500
1.300		30.0	8.0	223 1.300	653 1.300	2.520		43.0	14.0	223 2.520	
1.320		30.0	8.0	223 1.320	653 1.320	2.530		43.0	14.0	223 2.530	653 2.530
1.350		32.0	9.0	223 1.350	653 1.350	2.550		43.0	14.0	223 2.550	653 2.550
1.400		32.0	9.0	223 1.400	653 1.400	2.580		43.0	14.0	223 2.580	653 2.580
1.430		32.0	9.0	223 1.430		2.600		43.0	14.0	223 2.600	653 2.600
1.450		32.0	9.0	223 1.450	653 1.450	2.640		43.0	14.0	223 2.640	653 2.640
1.480		32.0	9.0	223 1.480		2.650		43.0	14.0	223 2.650	653 2.650
1.500		32.0	9.0	223 1.500	653 1.500	2.700		46.0	16.0	223 2.700	653 2.700
1.510		34.0	10.0	223 1.510	653 1.510	2.710		46.0	16.0	223 2.710	653 2.710
1.520		34.0	10.0	223 1.520		2.750		46.0	16.0	223 2.750	653 2.750
1.550		34.0	10.0	223 1.550	653 1.550	2.780		46.0	16.0	223 2.780	653 2.780
1.570		34.0	10.0	223 1.570	653 1.570	2.790	7/64	46.0	16.0	223 2.790	653 2.790
1.590	1/16	34.0	10.0	223 1.590	653 1.590	2.800		46.0	16.0	223 2.800	653 2.800
1.600		34.0	10.0	223 1.600	653 1.600	2.820		46.0	16.0	223 2.820	
1.610		34.0	10.0	223 1.610	653 1.610	2.850		46.0	16.0	223 2.850	653 2.850
1.650		34.0	10.0	223 1.650	653 1.650	2.870		46.0	16.0	223 2.870	653 2.870
1.700		34.0	10.0	223 1.700	653 1.700	2.900		46.0	16.0	223 2.900	653 2.900
1.720		36.0	11.0	223 1.720		2.920		46.0	16.0	223 2.920	



Article no.				223	653	Article no.				223	653
d1 mm	inch	l1 mm	l2 mm	Order no.		d1 mm	inch	l1 mm	l2 mm	Order no.	
2.950		46.0	16.0	223 2.950	653 2.950	5.500		66.0	28.0	223 5.500	653 5.500
2.970		46.0	16.0	223 2.970		5.520		66.0	28.0		653 5.520
3.000		46.0	16.0	223 3.000	653 3.000	5.550		66.0	28.0	223 5.550	
3.020		49.0	18.0	223 3.020		5.560	7/32	66.0	28.0	223 5.560	653 5.560
3.050		49.0	18.0	223 3.050	653 3.050	5.580		66.0	28.0		653 5.580
3.100		49.0	18.0	223 3.100	653 3.100	5.600		66.0	28.0	223 5.600	653 5.600
3.150		49.0	18.0	223 3.150		5.610		66.0	28.0	223 5.610	653 5.610
3.170	1/8	49.0	18.0	223 3.170	653 3.170	5.700		66.0	28.0	223 5.700	653 5.700
3.200		49.0	18.0	223 3.200	653 3.200	5.750		66.0	28.0	223 5.750	653 5.750
3.220		49.0	18.0	223 3.220		5.790		66.0	28.0	223 5.790	
3.250		49.0	18.0	223 3.250	653 3.250	5.800		66.0	28.0	223 5.800	653 5.800
3.260		49.0	18.0	223 3.260	653 3.260	5.850		66.0	28.0		653 5.850
3.300		49.0	18.0	223 3.300	653 3.300	5.900		66.0	28.0	223 5.900	653 5.900
3.350		49.0	18.0	223 3.350		5.940		66.0	28.0	223 5.940	
3.400		52.0	20.0	223 3.400	653 3.400	5.950	15/64	66.0	28.0	223 5.950	653 5.950
3.450		52.0	20.0	223 3.450	653 3.450	6.000		66.0	28.0	223 6.000	653 6.000
3.500		52.0	20.0	223 3.500	653 3.500	6.040		70.0	31.0	223 6.040	653 6.040
3.550		52.0	20.0	223 3.550	653 3.550	6.050		70.0	31.0	223 6.050	653 6.050
3.570	9/64	52.0	20.0	223 3.570	653 3.570	6.100		70.0	31.0	223 6.100	653 6.100
3.600		52.0	20.0	223 3.600	653 3.600	6.150		70.0	31.0	223 6.150	653 6.150
3.650		52.0	20.0	223 3.650	653 3.650	6.200		70.0	31.0	223 6.200	653 6.200
3.660		52.0	20.0	223 3.660	653 3.660	6.250		70.0	31.0	223 6.250	653 6.250
3.700		52.0	20.0	223 3.700	653 3.700	6.300		70.0	31.0	223 6.300	653 6.300
3.730		52.0	20.0	223 3.730	653 3.730	6.350	1/4	70.0	31.0	223 6.350	653 6.350
3.750		52.0	20.0	223 3.750	653 3.750	6.400		70.0	31.0	223 6.400	653 6.400
3.800		55.0	22.0	223 3.800	653 3.800	6.450		70.0	31.0	223 6.450	653 6.450
3.850		55.0	22.0	223 3.850		6.500		70.0	31.0	223 6.500	653 6.500
3.860		55.0	22.0	223 3.860	653 3.860	6.530		70.0	31.0	223 6.530	653 6.530
3.900		55.0	22.0	223 3.900	653 3.900	6.550		70.0	31.0	223 6.550	
3.910		55.0	22.0	223 3.910		6.600		70.0	31.0	223 6.600	653 6.600
3.950		55.0	22.0	223 3.950		6.630		70.0	31.0	223 6.630	
3.960		55.0	22.0	223 3.960		6.700		70.0	31.0	223 6.700	653 6.700
3.970	5/32	55.0	22.0	223 3.970	653 3.970	6.750	17/64	74.0	34.0	223 6.750	653 6.750
3.990		55.0	22.0	223 3.990	653 3.990	6.800		74.0	34.0	223 6.800	653 6.800
4.000		55.0	22.0	223 4.000	653 4.000	6.850		74.0	34.0	223 6.850	
4.020		55.0	22.0	223 4.020		6.900		74.0	34.0	223 6.900	653 6.900
4.040		55.0	22.0	223 4.040	653 4.040	6.950		74.0	34.0	223 6.950	
4.050		55.0	22.0	223 4.050	653 4.050	7.000		74.0	34.0	223 7.000	653 7.000
4.080		55.0	22.0	223 4.080		7.030		74.0	34.0	223 7.030	
4.090		55.0	22.0	223 4.090	653 4.090	7.050		74.0	34.0	223 7.050	
4.100		55.0	22.0	223 4.100	653 4.100	7.100		74.0	34.0	223 7.100	653 7.100
4.150		55.0	22.0	223 4.150	653 4.150	7.140	9/32	74.0	34.0	223 7.140	653 7.140
4.200		55.0	22.0	223 4.200	653 4.200	7.150		74.0	34.0	223 7.150	
4.220		55.0	22.0	223 4.220		7.200		74.0	34.0	223 7.200	653 7.200
4.250		55.0	22.0	223 4.250	653 4.250	7.250		74.0	34.0	223 7.250	653 7.250
4.300		58.0	24.0	223 4.300	653 4.300	7.300		74.0	34.0	223 7.300	653 7.300
4.370	11/64	58.0	24.0	223 4.370	653 4.370	7.370		74.0	34.0	223 7.370	653 7.370
4.380		58.0	24.0	223 4.380		7.400		74.0	34.0	223 7.400	653 7.400
4.390		58.0	24.0	223 4.390	653 4.390	7.450		74.0	34.0	223 7.450	
4.400		58.0	24.0	223 4.400	653 4.400	7.490		74.0	34.0	223 7.490	
4.450		58.0	24.0	223 4.450		7.500		74.0	34.0	223 7.500	653 7.500
4.500		58.0	24.0	223 4.500	653 4.500	7.540	19/64	79.0	37.0	223 7.540	653 7.540
4.550		58.0	24.0	223 4.550		7.550		79.0	37.0	223 7.550	
4.570		58.0	24.0	223 4.570	653 4.570	7.600		79.0	37.0	223 7.600	653 7.600
4.600		58.0	24.0	223 4.600	653 4.600	7.670		79.0	37.0	223 7.670	653 7.670
4.620		58.0	24.0	223 4.620	653 4.620	7.700		79.0	37.0	223 7.700	653 7.700
4.650		58.0	24.0	223 4.650	653 4.650	7.750		79.0	37.0	223 7.750	
4.700		58.0	24.0	223 4.700	653 4.700	7.800		79.0	37.0	223 7.800	653 7.800
4.750		58.0	24.0	223 4.750	653 4.750	7.820		79.0	37.0	223 7.820	
4.760	3/16	62.0	26.0	223 4.760	653 4.760	7.850		79.0	37.0	223 7.850	
4.800		62.0	26.0	223 4.800	653 4.800	7.900		79.0	37.0	223 7.900	653 7.900
4.850		62.0	26.0	223 4.850	653 4.850	7.940	5/16	79.0	37.0	223 7.940	653 7.940
4.900		62.0	26.0	223 4.900	653 4.900	8.000		79.0	37.0	223 8.000	653 8.000
4.920		62.0	26.0	223 4.920	653 4.920	8.030		79.0	37.0	223 8.030	653 8.030
4.950		62.0	26.0	223 4.950	653 4.950	8.050		79.0	37.0	223 8.050	
4.980		62.0	26.0	223 4.980	653 4.980	8.100		79.0	37.0	223 8.100	653 8.100
5.000		62.0	26.0	223 5.000	653 5.000	8.150		79.0	37.0	223 8.150	
5.020		62.0	26.0	223 5.020		8.200		79.0	37.0	223 8.200	653 8.200
5.050		62.0	26.0	223 5.050	653 5.050	8.250		79.0	37.0	223 8.250	653 8.250
5.060		62.0	26.0	223 5.060	653 5.060	8.300		79.0	37.0	223 8.300	653 8.300
5.100		62.0	26.0	223 5.100	653 5.100	8.330	21/64	79.0	37.0	223 8.330	653 8.330
5.110		62.0	26.0	223 5.110	653 5.110	8.400		79.0	37.0	223 8.400	653 8.400
5.150		62.0	26.0	223 5.150		8.430		79.0	37.0	223 8.430	653 8.430
5.160	13/64	62.0	26.0	223 5.160	653 5.160	8.450		79.0	37.0	223 8.450	
5.180		62.0	26.0	223 5.180	653 5.180	8.500		79.0	37.0	223 8.500	653 8.500
5.200		62.0	26.0	223 5.200	653 5.200	8.550		84.0	40.0	223 8.550	653 8.550
5.220		62.0	26.0	223 5.220		8.600		84.0	40.0	223 8.600	653 8.600
5.250		62.0	26.0	223 5.250	653 5.250	8.610		84.0	40.0	223 8.610	653 8.610
5.300		62.0	26.0	223 5.300	653 5.300	8.650		84.0	40.0	223 8.650	
5.310		66.0	28.0	223 5.310	653 5.310	8.700		84.0	40.0	223 8.700	653 8.700
5.350		66.0	28.0	223 5.350		8.730	11/32	84.0	40.0	223 8.730	653 8.730
5.400		66.0	28.0	223 5.400	653 5.400	8.750		84.0	40.0	223 8.750	653 8.750
5.410		66.0	28.0	223 5.410	653 5.410	8.800		84.0	40.0	223 8.800	653 8.800
5.450		66.0	28.0	223 5.450	653 5.450	8.840		84.0	40.0	223 8.840	

HSS/HSCO drills



HSS/HSCO drills with straight shank

HSS/HSCO drills

Article no.				223	653	Article no.				223	653
d1 mm	inch	l1 mm	l2 mm	Order no.		d1 mm	inch	l1 mm	l2 mm	Order no.	
8.900		84.0	40.0	223 8.900	653 8.900	13.750		107.0	54.0	223 13.750	
8.950		84.0	40.0	223 8.950		13.800		107.0	54.0	223 13.800	653 13.800
9.000		84.0	40.0	223 9.000	653 9.000	13.890	35/64	107.0	54.0	223 13.890	653 13.890
9.050		84.0	40.0	223 9.050		14.000		107.0	54.0	223 14.000	653 14.000
9.090		84.0	40.0	223 9.090	653 9.090	14.100		111.0	56.0	223 14.100	
9.100		84.0	40.0	223 9.100	653 9.100	14.200		111.0	56.0	223 14.200	653 14.200
9.130	23/64	84.0	40.0	223 9.130	653 9.130	14.250		111.0	56.0		653 14.250
9.150		84.0	40.0	223 9.150		14.290	9/16	111.0	56.0	223 14.290	653 14.290
9.200		84.0	40.0	223 9.200	653 9.200	14.300		111.0	56.0	223 14.300	
9.250		84.0	40.0	223 9.250	653 9.250	14.400		111.0	56.0	223 14.400	
9.270		84.0	40.0	223 9.270		14.500		111.0	56.0	223 14.500	653 14.500
9.300		84.0	40.0	223 9.300	653 9.300	14.600		111.0	56.0	223 14.600	
9.340		84.0	40.0	223 9.340		14.680	37/64	111.0	56.0	223 14.680	
9.350		84.0	40.0	223 9.350		14.700		111.0	56.0	223 14.700	
9.400		84.0	40.0	223 9.400	653 9.400	14.750		111.0	56.0	223 14.750	
9.500		84.0	40.0	223 9.500	653 9.500	14.800		111.0	56.0	223 14.800	653 14.800
9.520	3/8	89.0	43.0	223 9.520	653 9.520	14.900		111.0	56.0	223 14.900	653 14.900
9.580		89.0	43.0	223 9.580	653 9.580	15.000		111.0	56.0	223 15.000	653 15.000
9.600		89.0	43.0	223 9.600	653 9.600	15.080	19/32	115.0	58.0	223 15.080	653 15.080
9.650		89.0	43.0	223 9.650		15.100		115.0	58.0	223 15.100	
9.700		89.0	43.0	223 9.700	653 9.700	15.200		115.0	58.0	223 15.200	
9.750		89.0	43.0	223 9.750		15.250		115.0	58.0	223 15.250	653 15.250
9.800		89.0	43.0	223 9.800	653 9.800	15.300		115.0	58.0	223 15.300	653 15.300
9.850		89.0	43.0	223 9.850		15.400		115.0	58.0	223 15.400	
9.900		89.0	43.0	223 9.900	653 9.900	15.480	39/64	115.0	58.0	223 15.480	
9.920	25/64	89.0	43.0	223 9.920	653 9.920	15.500		115.0	58.0	223 15.500	653 15.500
10.000		89.0	43.0	223 10.000	653 10.000	15.600		115.0	58.0	223 15.600	
10.050		89.0	43.0	223 10.050		15.700		115.0	58.0	223 15.700	
10.080		89.0	43.0	223 10.080		15.750		115.0	58.0	223 15.750	653 15.750
10.100		89.0	43.0	223 10.100	653 10.100	15.800		115.0	58.0	223 15.800	653 15.800
10.150		89.0	43.0	223 10.150		15.870	5/8	115.0	58.0	223 15.870	653 15.870
10.200		89.0	43.0	223 10.200	653 10.200	15.900		115.0	58.0	223 15.900	
10.250		89.0	43.0	223 10.250		16.000		115.0	58.0	223 16.000	653 16.000
10.260		89.0	43.0	223 10.260		16.100		119.0	60.0	223 16.100	
10.300		89.0	43.0	223 10.300	653 10.300	16.150		119.0	60.0	223 16.150	
10.320	13/32	89.0	43.0	223 10.320	653 10.320	16.200		119.0	60.0	223 16.200	
10.400		89.0	43.0	223 10.400	653 10.400	16.250		119.0	60.0	223 16.250	653 16.250
10.490		89.0	43.0	223 10.490	653 10.490	16.270	41/64	119.0	60.0	223 16.270	653 16.270
10.500		89.0	43.0	223 10.500	653 10.500	16.300		119.0	60.0	223 16.300	
10.600		89.0	43.0	223 10.600	653 10.600	16.500		119.0	60.0	223 16.500	653 16.500
10.700		95.0	47.0	223 10.700		16.670	21/32	119.0	60.0	223 16.670	653 16.670
10.720	27/64	95.0	47.0	223 10.720	653 10.720	16.750		119.0	60.0	223 16.750	
10.750		95.0	47.0	223 10.750	653 10.750	17.000		119.0	60.0	223 17.000	653 17.000
10.800		95.0	47.0	223 10.800	653 10.800	17.070	43/64	123.0	62.0	223 17.070	
10.900		95.0	47.0	223 10.900		17.100		123.0	62.0	223 17.100	
11.000		95.0	47.0	223 11.000	653 11.000	17.200		123.0	62.0	223 17.200	
11.100		95.0	47.0	223 11.100		17.250		123.0	62.0	223 17.250	
11.110	7/16	95.0	47.0	223 11.110	653 11.110	17.460	11/16	123.0	62.0	223 17.460	653 17.460
11.200		95.0	47.0	223 11.200	653 11.200	17.500		123.0	62.0	223 17.500	653 17.500
11.250		95.0	47.0	223 11.250		17.600		123.0	62.0	223 17.600	
11.300		95.0	47.0	223 11.300	653 11.300	17.750		123.0	62.0	223 17.750	
11.400		95.0	47.0	223 11.400	653 11.400	17.860	45/64	123.0	62.0	223 17.860	653 17.860
11.500		95.0	47.0	223 11.500	653 11.500	18.000		123.0	62.0	223 18.000	653 18.000
11.510	29/64	95.0	47.0	223 11.510	653 11.510	18.100		127.0	64.0	223 18.100	
11.600		95.0	47.0	223 11.600		18.200		127.0	64.0	223 18.200	
11.700		95.0	47.0	223 11.700		18.250		127.0	64.0	223 18.250	653 18.250
11.750		95.0	47.0	223 11.750	653 11.750	18.260	23/32	127.0	64.0	223 18.260	653 18.260
11.800		95.0	47.0	223 11.800	653 11.800	18.500		127.0	64.0	223 18.500	653 18.500
11.900		102.0	51.0	223 11.900	653 11.900	18.650	47/64	127.0	64.0	223 18.650	653 18.650
11.910	15/32	102.0	51.0	223 11.910	653 11.910	18.750		127.0	64.0	223 18.750	
12.000		102.0	51.0	223 12.000	653 12.000	19.000		127.0	64.0	223 19.000	653 19.000
12.050		102.0	51.0	223 12.050		19.050	3/4	131.0	66.0	223 19.050	653 19.050
12.100		102.0	51.0	223 12.100	653 12.100	19.100		131.0	66.0	223 19.100	
12.150		102.0	51.0	223 12.150		19.250		131.0	66.0	223 19.250	
12.200		102.0	51.0	223 12.200	653 12.200	19.450		131.0	66.0	223 19.450	
12.250		102.0	51.0	223 12.250		19.500		131.0	66.0	223 19.500	653 19.500
12.300	31/64	102.0	51.0	223 12.300	653 12.300	19.750		131.0	66.0	223 19.750	
12.400		102.0	51.0	223 12.400		20.000		131.0	66.0	223 20.000	653 20.000
12.500		102.0	51.0	223 12.500	653 12.500	20.100		136.0	68.0	223 20.100	
12.600		102.0	51.0	223 12.600		20.240	51/64	136.0	68.0	223 20.240	
12.700	1/2	102.0	51.0	223 12.700	653 12.700	20.250		136.0	68.0	223 20.250	
12.750		102.0	51.0	223 12.750		20.500		136.0	68.0	223 20.500	653 20.500
12.800		102.0	51.0	223 12.800	653 12.800	20.640	13/16	136.0	68.0	223 20.640	653 20.640
12.900		102.0	51.0	223 12.900		20.750		136.0	68.0	223 20.750	
13.000		102.0	51.0	223 13.000	653 13.000	20.800		136.0	68.0	223 20.800	
13.100	33/64	102.0	51.0	223 13.100	653 13.100	21.000		136.0	68.0	223 21.000	653 21.000
13.200		102.0	51.0	223 13.200		21.030	53/64	136.0	68.0	223 21.030	
13.250		107.0	54.0	223 13.250		21.430	27/32	141.0	70.0	223 21.430	
13.300		107.0	54.0	223 13.300		21.500		141.0	70.0	223 21.500	653 21.500
13.400		107.0	54.0	223 13.400		21.830	55/64	141.0	70.0	223 21.830	
13.490	17/32	107.0	54.0	223 13.490	653 13.490	22.000		141.0	70.0	223 22.000	653 22.000
13.500		107.0	54.0	223 13.500	653 13.500	22.220	7/8	141.0	70.0	223 22.220	
13.600		107.0	54.0	223 13.600	653 13.600	22.500		146.0	72.0	223 22.500	653 22.500
13.700		107.0	54.0	223 13.700	653 13.700	22.620	57/64	146.0	72.0	223 22.620	653 22.620



Article no.				223	653	Article no.				223	653
d1 mm	inch	l1 mm	l2 mm	Order no.		d1 mm	inch	l1 mm	l2 mm	Order no.	
22.620		146.0	72.0	223 22.620		29.000		168.0	84.0	223 29.000	
23.000		146.0	72.0	223 23.000	653 23.000	29.370	1 5/32	168.0	84.0	223 29.370	
23.420	59/64	146.0	72.0	223 23.420	653 23.420	30.000		168.0	84.0	223 30.000	653 30.000
23.500		146.0	72.0	223 23.500		31.000		174.0	87.0	223 31.000	
23.810	15/16	151.0	75.0	223 23.810		32.000		180.0	90.0	223 32.000	
24.000		151.0	75.0	223 24.000	653 24.000	34.000		186.0	93.0	223 34.000	
24.210	61/64	151.0	75.0	223 24.210		40.000		200.0	100.0	223 40.000	
24.500		151.0	75.0	223 24.500	653 24.500	44.000		214.0	108.0	223 44.000	
24.610	31/32	151.0	75.0	223 24.610							
25.000	63/64	151.0	75.0	223 25.000	653 25.000						
25.400	1	156.0	78.0	223 25.400	653 25.400						
26.000		156.0	78.0	223 26.000							
26.190		156.0	78.0	223 26.190							
26.500		156.0	78.0	223 26.500							
27.000		162.0	81.0	223 27.000							
27.500		162.0	81.0	223 27.500	653 27.500						
28.000		162.0	81.0	223 28.000							
28.570	1 1/8	168.0	84.0	223 28.570							

HSS/HSCO drills



HSS/HSCO drills with straight shank

HSS/HSCO drills

Stub drills

Article no. **252**

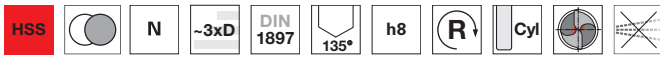

Web thinning $\geq \varnothing 2.000$ • facet point grind

Cutting data page 442

P	M	K	N	S	H
•		•	○		

Stub drills

Article no. **226**



Web thinning $\geq \varnothing 14.050$ • relieved cone • for use in automatic/capstan lathes

Cutting data page 442

P	M	K	N	S	H
•		•	○		

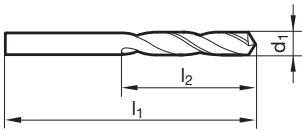

Article no. 252				Article no. 226				Article no. 252				Article no. 226			
d1 mm	inch	l1 mm	l2 mm	Order no.				d1 mm	inch	l1 mm	l2 mm	Order no.			
0.500		20.0	3.0	226 0.500				2.370		43.0	14.0	226 2.370			
0.650		22.0	4.0	226 0.650				2.380	3/32	43.0	14.0	226 2.380			
0.700		23.0	4.5	226 0.700				2.400		43.0	14.0	226 2.400			
0.750		23.0	4.5	226 0.750				2.440		43.0	14.0	226 2.440			
0.800		24.0	5.0	226 0.800				2.450		43.0	14.0	226 2.450			
0.850		24.0	5.0	226 0.850				2.490		43.0	14.0	226 2.490			
0.900		25.0	5.5	226 0.900				2.500		43.0	14.0	252 2.500	226 2.500		
0.950		25.0	5.5	226 0.950				2.520		43.0	14.0	226 2.520			
0.975		26.0	6.0	226 0.975				2.530		43.0	14.0	226 2.530			
1.000		26.0	6.0	226 1.000				2.550		43.0	14.0	226 2.550			
1.020		26.0	6.0	226 1.020				2.580		43.0	14.0	226 2.580			
1.040		26.0	6.0	226 1.040				2.600		43.0	14.0	226 2.600			
1.050		26.0	6.0	226 1.050				2.640		43.0	14.0	226 2.640			
1.090		28.0	7.0	226 1.090				2.650		43.0	14.0	226 2.650			
1.100		28.0	7.0	226 1.100				2.700		46.0	16.0	252 2.700	226 2.700		
1.150		28.0	7.0	226 1.150				2.710		46.0	16.0	226 2.710			
1.200		30.0	8.0	226 1.200				2.780	7/64	46.0	16.0	226 2.780			
1.220		30.0	8.0	226 1.220				2.800		46.0	16.0	252 2.800	226 2.800		
1.250		30.0	8.0	226 1.250				2.870		46.0	16.0	226 2.870			
1.320		30.0	8.0	226 1.320				2.900		46.0	16.0	226 2.900			
1.330		32.0	9.0	226 1.330				2.950		46.0	16.0	226 2.950			
1.350		32.0	9.0	226 1.350				3.000		46.0	16.0	252 3.000	226 3.000		
1.400		32.0	9.0	226 1.400				3.050		49.0	18.0	226 3.050			
1.450		32.0	9.0	226 1.450				3.100		49.0	18.0	226 3.100			
1.500		32.0	9.0	226 1.500				3.150		49.0	18.0	226 3.150			
1.510		34.0	10.0	226 1.510				3.170	1/8	49.0	18.0	226 3.170			
1.550		34.0	10.0	226 1.550				3.200		49.0	18.0	252 3.200	226 3.200		
1.590	1/16	34.0	10.0	226 1.590				3.230		49.0	18.0	226 3.230			
1.600		34.0	10.0	226 1.600				3.300		49.0	18.0	226 3.300			
1.650		34.0	10.0	226 1.650				3.330		49.0	18.0	226 3.330			
1.670		34.0	10.0	226 1.670				3.350		49.0	18.0	226 3.350			
1.700		34.0	10.0	226 1.700				3.400		52.0	20.0	226 3.400			
1.750		36.0	11.0	226 1.750				3.420		52.0	20.0	226 3.420			
1.780		36.0	11.0	226 1.780				3.450		52.0	20.0	226 3.450			
1.800		36.0	11.0	226 1.800				3.480		52.0	20.0	226 3.480			
1.850		36.0	11.0	226 1.850				3.500		52.0	20.0	252 3.500	226 3.500		
1.900		36.0	11.0	226 1.900				3.600		52.0	20.0	252 3.600			
1.930		38.0	12.0	226 1.930				3.700		52.0	20.0	226 3.700			
1.940		38.0	12.0	226 1.940				3.730		52.0	20.0	226 3.730			
1.950		38.0	12.0	226 1.950				3.750		52.0	20.0	226 3.750			
1.980	5/64	38.0	12.0	226 1.980				3.770		55.0	22.0	226 3.770			
1.990		38.0	12.0	226 1.990				3.800		55.0	22.0	252 3.800	226 3.800		
2.000		38.0	12.0	252 2.000	226 2.000			3.840		55.0	22.0	226 3.840			
2.050		38.0	12.0	226 2.050				3.850		55.0	22.0	226 3.850			
2.060		38.0	12.0	226 2.060				3.950		55.0	22.0	226 3.950			
2.100		38.0	12.0	226 2.100				3.970	5/32	55.0	22.0	226 3.970			
2.150		40.0	13.0	226 2.150				4.000		55.0	22.0	252 4.000	226 4.000		
2.180		40.0	13.0	226 2.180				4.100		55.0	22.0	252 4.100	226 4.100		
2.200		40.0	13.0	226 2.200				4.200		55.0	22.0	252 4.200	226 4.200		
2.250		40.0	13.0	226 2.250				4.220		55.0	22.0	226 4.220			
2.260		40.0	13.0	226 2.260				4.230		55.0	22.0	226 4.230			
2.300		40.0	13.0	226 2.300				4.250		55.0	22.0	226 4.250			
2.350		40.0	13.0	226 2.350				4.290		58.0	24.0	226 4.290			
2.360		40.0	13.0	226 2.360				4.300		58.0	24.0	252 4.300	226 4.300		



Article no.				252	226	Article no.				252	226
d1 mm	inch	l1 mm	l2 mm	Order no.		d1 mm	inch	l1 mm	l2 mm	Order no.	
4.350		58.0	24.0		226 4.350	8.700		84.0	40.0		226 8.700
4.370	11/64	58.0	24.0		226 4.370	8.730	11/32	84.0	40.0		226 8.730
4.400		58.0	24.0		226 4.400	8.800		84.0	40.0		226 8.800
4.450		58.0	24.0		226 4.450	8.840		84.0	40.0		226 8.840
4.500		58.0	24.0	252 4.500	226 4.500	8.850		84.0	40.0		226 8.850
4.560		58.0	24.0		226 4.560	8.900		84.0	40.0		226 8.900
4.600		58.0	24.0	252 4.600	226 4.600	9.000		84.0	40.0		226 9.000
4.620		58.0	24.0		226 4.620	9.090		84.0	40.0		226 9.090
4.700		58.0	24.0		226 4.700	9.100		84.0	40.0	252 9.100	
4.750		58.0	24.0		226 4.750	9.130	23/64	84.0	40.0		226 9.130
4.760	3/16	62.0	26.0		226 4.760	9.300		84.0	40.0		226 9.300
4.800		62.0	26.0	252 4.800	226 4.800	9.340		84.0	40.0		226 9.340
4.850		62.0	26.0		226 4.850	9.400		84.0	40.0		226 9.400
4.900		62.0	26.0	252 4.900	226 4.900	9.500		84.0	40.0		226 9.500
4.920		62.0	26.0		226 4.920	9.520	3/8	89.0	43.0		226 9.520
4.970		62.0	26.0		226 4.970	9.700		89.0	43.0		226 9.700
4.980		62.0	26.0		226 4.980	9.750		89.0	43.0		226 9.750
5.000		62.0	26.0	252 5.000	226 5.000	9.800		89.0	43.0		226 9.800
5.050		62.0	26.0		226 5.050	10.000		89.0	43.0		226 10.000
5.100		62.0	26.0	252 5.100	226 5.100	10.050		89.0	43.0		226 10.050
5.110		62.0	26.0		226 5.110	10.080		89.0	43.0		226 10.080
5.150		62.0	26.0		226 5.150	10.100		89.0	43.0		226 10.100
5.160	13/64	62.0	26.0		226 5.160	10.200		89.0	43.0		226 10.200
5.180		62.0	26.0		226 5.180	10.300		89.0	43.0		226 10.300
5.200		62.0	26.0	252 5.200	226 5.200	10.320	13/32	89.0	43.0		226 10.320
5.220		62.0	26.0		226 5.220	10.500		89.0	43.0		226 10.500
5.250		62.0	26.0		226 5.250	10.600		89.0	43.0		226 10.600
5.300		62.0	26.0		226 5.300	10.720		95.0	47.0		226 10.720
5.310		66.0	28.0		226 5.310	10.800		95.0	47.0		226 10.800
5.400		66.0	28.0	252 5.400	226 5.400	11.000		95.0	47.0	252 11.000	226 11.000
5.410		66.0	28.0		226 5.410	11.110	7/16	95.0	47.0		226 11.110
5.500		66.0	28.0		226 5.500	11.200		95.0	47.0		226 11.200
5.560	7/32	66.0	28.0		226 5.560	11.400		95.0	47.0		226 11.400
5.600		66.0	28.0		226 5.600	11.500		95.0	47.0		226 11.500
5.700		66.0	28.0		226 5.700	11.510	29/64	95.0	47.0		226 11.510
5.750		66.0	28.0		226 5.750	11.650		95.0	47.0		226 11.650
5.790		66.0	28.0		226 5.790	11.700		95.0	47.0		226 11.700
5.800		66.0	28.0		226 5.800	11.750		95.0	47.0		226 11.750
5.900		66.0	28.0		226 5.900	11.800		95.0	47.0		226 11.800
5.940		66.0	28.0		226 5.940	12.000		102.0	51.0	252 12.000	226 12.000
5.950	15/64	66.0	28.0		226 5.950	12.100		102.0	51.0		226 12.100
6.000		66.0	28.0	252 6.000	226 6.000	12.200		102.0	51.0		226 12.200
6.040		70.0	31.0		226 6.040	12.300	31/64	102.0	51.0		226 12.300
6.050		70.0	31.0		226 6.050	12.450		102.0	51.0		226 12.450
6.100		70.0	31.0	252 6.100	226 6.100	12.500		102.0	51.0		226 12.500
6.150		70.0	31.0		226 6.150	12.700	1/2	102.0	51.0		226 12.700
6.200		70.0	31.0	252 6.200	226 6.200	12.800		102.0	51.0		226 12.800
6.250		70.0	31.0		226 6.250	12.900		102.0	51.0		226 12.900
6.300		70.0	31.0		226 6.300	13.000		102.0	51.0	252 13.000	226 13.000
6.350	1/4	70.0	31.0		226 6.350	13.200		102.0	51.0		226 13.200
6.400		70.0	31.0		226 6.400	13.250		107.0	54.0		226 13.250
6.500		70.0	31.0	252 6.500	226 6.500	13.700		107.0	54.0		226 13.700
6.530		70.0	31.0		226 6.530	13.750		107.0	54.0		226 13.750
6.550		70.0	31.0		226 6.550	14.000		107.0	54.0		226 14.000
6.570		70.0	31.0		226 6.570	14.050		111.0	56.0		226 14.050
6.600		70.0	31.0	252 6.600	226 6.600	14.200		111.0	56.0		226 14.200
6.630		70.0	31.0		226 6.630	14.250		111.0	56.0		226 14.250
6.700		70.0	31.0	252 6.700	226 6.700	14.500		111.0	56.0		226 14.500
6.750	17/64	74.0	34.0		226 6.750	14.680		111.0	56.0		226 14.680
6.800		74.0	34.0	252 6.800	226 6.800	15.000		111.0	56.0		226 15.000
6.900		74.0	34.0		226 6.900	15.600		115.0	58.0		226 15.600
6.920		74.0	34.0		226 6.920	15.750		115.0	58.0		226 15.750
7.000		74.0	34.0		226 7.000	15.870	5/8	115.0	58.0		226 15.870
7.100		74.0	34.0	252 7.100	226 7.100	16.000		115.0	58.0		226 16.000
7.140	9/32	74.0	34.0		226 7.140	16.200		119.0	60.0		226 16.200
7.200		74.0	34.0		226 7.200	16.500		119.0	60.0		226 16.500
7.250		74.0	34.0		226 7.250	16.670	21/32	119.0	60.0		226 16.670
7.370		74.0	34.0		226 7.370	17.000		119.0	60.0		226 17.000
7.400		74.0	34.0		226 7.400	17.070	43/64	123.0	62.0		226 17.070
7.450		74.0	34.0		226 7.450	17.200		123.0	62.0		226 17.200
7.490		74.0	34.0		226 7.490	18.000		123.0	62.0		226 18.000
7.500		74.0	34.0		226 7.500	18.500		127.0	64.0		226 18.500
7.540	19/64	79.0	37.0		226 7.540	19.000		127.0	64.0		226 19.000
7.750		79.0	37.0		226 7.750	19.050	3/4	131.0	66.0		226 19.050
7.900		79.0	37.0		226 7.900	20.000		131.0	66.0		226 20.000
7.940	5/16	79.0	37.0		226 7.940	20.640	13/16	136.0	68.0		226 20.640
8.000		79.0	37.0	252 8.000	226 8.000	21.000		136.0	68.0		226 21.000
8.030		79.0	37.0		226 8.030	21.250		141.0	70.0		226 21.250
8.100		79.0	37.0		226 8.100	21.750		141.0	70.0		226 21.750
8.200		79.0	37.0	252 8.200	226 8.200	22.000		141.0	70.0		226 22.000
8.300		79.0	37.0		226 8.300	23.000		146.0	72.0		226 23.000
8.330	21/64	79.0	37.0		226 8.330	24.000		151.0	75.0		226 24.000
8.500		79.0	37.0		226 8.500	24.500		151.0	75.0		226 24.500
8.600		84.0	40.0		226 8.600	25.500		156.0	78.0		226 25.500



HSS/HSCO drills with straight shank

HSS/HSCO drills

				Article no.	
				252	226
d1 mm	inch	l1 mm	l2 mm	Order no.	
26.590	1 3/64	162.0	81.0	226 26.590	
29.000		168.0	84.0	226 29.000	
33.000		180.0	90.0	226 33.000	
36.000		193.0	96.0	226 36.000	
37.000		193.0	96.0	226 37.000	

				Article no.	
				252	226
d1 mm	inch	l1 mm	l2 mm	Order no.	



Stub drills

Article no. **224**



Cutting data page 448

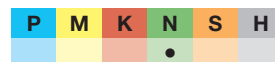
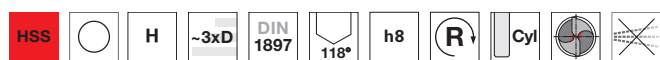

Web thinning $\geq \varnothing 14.500$ • relieved cone

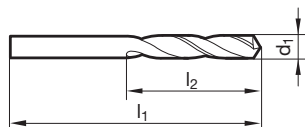

Article no. 224				Article no. 224					
d1 mm	inch	l1 mm	l2 mm	Order no.	d1 mm	inch	l1 mm	l2 mm	Order no.
0.690		23.0	4.5	224 0.690	4.700		58.0	24.0	224 4.700
0.950		25.0	5.5	224 0.950	4.760	3/16	62.0	26.0	224 4.760
1.000		26.0	6.0	224 1.000	4.800		62.0	26.0	224 4.800
1.100		28.0	7.0	224 1.100	4.900		62.0	26.0	224 4.900
1.190	3/64	30.0	8.0	224 1.190	5.000		62.0	26.0	224 5.000
1.200		30.0	8.0	224 1.200	5.100		62.0	26.0	224 5.100
1.300		30.0	8.0	224 1.300	5.160		62.0	26.0	224 5.160
1.400		32.0	9.0	224 1.400	5.200		62.0	26.0	224 5.200
1.500		32.0	9.0	224 1.500	5.300		62.0	26.0	224 5.300
1.550		34.0	10.0	224 1.550	5.400		66.0	28.0	224 5.400
1.590	1/16	34.0	10.0	224 1.590	5.500		66.0	28.0	224 5.500
1.600		34.0	10.0	224 1.600	5.560	7/32	66.0	28.0	224 5.560
1.620		34.0	10.0	224 1.620	5.600		66.0	28.0	224 5.600
1.700		34.0	10.0	224 1.700	5.700		66.0	28.0	224 5.700
1.780		36.0	11.0	224 1.780	5.800		66.0	28.0	224 5.800
1.800		36.0	11.0	224 1.800	5.900		66.0	28.0	224 5.900
1.850		36.0	11.0	224 1.850	5.950	15/64	66.0	28.0	224 5.950
1.900		36.0	11.0	224 1.900	6.000		66.0	28.0	224 6.000
1.950		38.0	12.0	224 1.950	6.100		70.0	31.0	224 6.100
2.000		38.0	12.0	224 2.000	6.200		70.0	31.0	224 6.200
2.020		38.0	12.0	224 2.020	6.300		70.0	31.0	224 6.300
2.050		38.0	12.0	224 2.050	6.350	1/4	70.0	31.0	224 6.350
2.100		38.0	12.0	224 2.100	6.400		70.0	31.0	224 6.400
2.200		40.0	13.0	224 2.200	6.500		70.0	31.0	224 6.500
2.250		40.0	13.0	224 2.250	6.600		70.0	31.0	224 6.600
2.300		40.0	13.0	224 2.300	6.750	17/64	74.0	34.0	224 6.750
2.350		40.0	13.0	224 2.350	6.800		74.0	34.0	224 6.800
2.400		43.0	14.0	224 2.400	6.900		74.0	34.0	224 6.900
2.450		43.0	14.0	224 2.450	7.000		74.0	34.0	224 7.000
2.500		43.0	14.0	224 2.500	7.140	9/32	74.0	34.0	224 7.140
2.550		43.0	14.0	224 2.550	7.200		74.0	34.0	224 7.200
2.600		43.0	14.0	224 2.600	7.500		74.0	34.0	224 7.500
2.650		43.0	14.0	224 2.650	7.750		79.0	37.0	224 7.750
2.700		46.0	16.0	224 2.700	7.940	5/16	79.0	37.0	224 7.940
2.780	7/64	46.0	16.0	224 2.780	8.000		79.0	37.0	224 8.000
2.800		46.0	16.0	224 2.800	8.030		79.0	37.0	224 8.030
2.900		46.0	16.0	224 2.900	8.100		79.0	37.0	224 8.100
2.950		46.0	16.0	224 2.950	8.200		79.0	37.0	224 8.200
3.000		46.0	16.0	224 3.000	8.330	21/64	79.0	37.0	224 8.330
3.100		49.0	18.0	224 3.100	8.400		79.0	37.0	224 8.400
3.170	1/8	49.0	18.0	224 3.170	8.500		79.0	37.0	224 8.500
3.200		49.0	18.0	224 3.200	9.000		84.0	40.0	224 9.000
3.250		49.0	18.0	224 3.250	9.200		84.0	40.0	224 9.200
3.300		49.0	18.0	224 3.300	9.500		84.0	40.0	224 9.500
3.350		49.0	18.0	224 3.350	9.920	25/64	89.0	43.0	224 9.920
3.400		52.0	20.0	224 3.400	10.000		89.0	43.0	224 10.000
3.500		52.0	20.0	224 3.500	10.320	13/32	89.0	43.0	224 10.320
3.570	9/64	52.0	20.0	224 3.570	10.500		89.0	43.0	224 10.500
3.600		52.0	20.0	224 3.600	11.000		95.0	47.0	224 11.000
3.650		52.0	20.0	224 3.650	11.110	7/16	95.0	47.0	224 11.110
3.700		52.0	20.0	224 3.700	11.500		95.0	47.0	224 11.500
3.800		55.0	22.0	224 3.800	11.910	15/32	102.0	51.0	224 11.910
3.850		55.0	22.0	224 3.850	12.000		102.0	51.0	224 12.000
3.900		55.0	22.0	224 3.900	12.500		102.0	51.0	224 12.500
3.970	5/32	55.0	22.0	224 3.970	12.700		102.0	51.0	224 12.700
4.000		55.0	22.0	224 4.000	13.000		102.0	51.0	224 13.000
4.050		55.0	22.0	224 4.050	14.000		107.0	54.0	224 14.000
4.100		55.0	22.0	224 4.100	14.500		111.0	56.0	224 14.500
4.200		55.0	22.0	224 4.200	15.000		111.0	56.0	224 15.000
4.250		55.0	22.0	224 4.250	16.000		115.0	58.0	224 16.000
4.300		58.0	24.0	224 4.300	17.000		119.0	60.0	224 17.000
4.370	11/64	58.0	24.0	224 4.370	18.000		123.0	62.0	224 18.000
4.400		58.0	24.0	224 4.400	19.000		127.0	64.0	224 19.000
4.450		58.0	24.0	224 4.450	20.000		131.0	66.0	224 20.000
4.500		58.0	24.0	224 4.500	21.000		136.0	68.0	224 21.000
4.600		58.0	24.0	224 4.600	22.000		141.0	70.0	224 22.000



HSS/HSCO drills with straight shank

HSS/HSCO drills

Stub drills

Article no. **225**

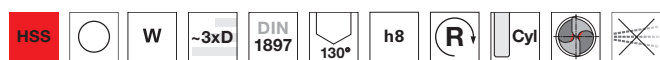

Web thinning $\geq \varnothing 2.380$ • relieved cone

Cutting data page 451

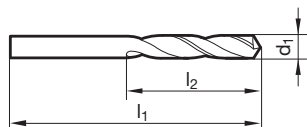
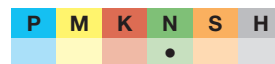

Article no. 225				Article no. 225					
d1 mm	inch	l1 mm	l2 mm	Order no.	d1 mm	inch	l1 mm	l2 mm	Order no.
1.000		26.0	6.0	225 1.000	5.300		62.0	26.0	225 5.300
1.190	3/64	30.0	8.0	225 1.190	5.560	7/32	66.0	28.0	225 5.560
1.200		30.0	8.0	225 1.200	5.700		66.0	28.0	225 5.700
1.300		30.0	8.0	225 1.300	5.800		66.0	28.0	225 5.800
1.400		32.0	9.0	225 1.400	5.900		66.0	28.0	225 5.900
1.500		32.0	9.0	225 1.500	5.950	15/64	66.0	28.0	225 5.950
1.590	1/16	34.0	10.0	225 1.590	6.000		66.0	28.0	225 6.000
1.600		34.0	10.0	225 1.600	6.300		70.0	31.0	225 6.300
1.700		34.0	10.0	225 1.700	6.350	1/4	70.0	31.0	225 6.350
1.800		36.0	11.0	225 1.800	6.400		70.0	31.0	225 6.400
1.900		36.0	11.0	225 1.900	6.500		70.0	31.0	225 6.500
1.980	5/64	38.0	12.0	225 1.980	6.530		70.0	31.0	225 6.530
2.000		38.0	12.0	225 2.000	6.600		70.0	31.0	225 6.600
2.100		38.0	12.0	225 2.100	6.800		74.0	34.0	225 6.800
2.200		40.0	13.0	225 2.200	6.900		74.0	34.0	225 6.900
2.250		40.0	13.0	225 2.250	7.000		74.0	34.0	225 7.000
2.300		40.0	13.0	225 2.300	7.140	9/32	74.0	34.0	225 7.140
2.380	3/32	43.0	14.0	225 2.380	7.300		74.0	34.0	225 7.300
2.400		43.0	14.0	225 2.400	7.500		74.0	34.0	225 7.500
2.500		43.0	14.0	225 2.500	7.600		79.0	37.0	225 7.600
2.550		43.0	14.0	225 2.550	7.800		79.0	37.0	225 7.800
2.600		43.0	14.0	225 2.600	7.940	5/16	79.0	37.0	225 7.940
2.750		46.0	16.0	225 2.750	8.000		79.0	37.0	225 8.000
2.780	7/64	46.0	16.0	225 2.780	8.200		79.0	37.0	225 8.200
2.800		46.0	16.0	225 2.800	8.330	21/64	79.0	37.0	225 8.330
2.900		46.0	16.0	225 2.900	8.400		79.0	37.0	225 8.400
3.000		46.0	16.0	225 3.000	8.430		79.0	37.0	225 8.430
3.050		49.0	18.0	225 3.050	8.500		79.0	37.0	225 8.500
3.100		49.0	18.0	225 3.100	8.600		84.0	40.0	225 8.600
3.200		49.0	18.0	225 3.200	8.900		84.0	40.0	225 8.900
3.300		49.0	18.0	225 3.300	9.000		84.0	40.0	225 9.000
3.400		52.0	20.0	225 3.400	9.200		84.0	40.0	225 9.200
3.500		52.0	20.0	225 3.500	9.520	3/8	89.0	43.0	225 9.520
3.570	9/64	52.0	20.0	225 3.570	9.800		89.0	43.0	225 9.800
3.600		52.0	20.0	225 3.600	10.000		89.0	43.0	225 10.000
3.700		52.0	20.0	225 3.700	10.500		89.0	43.0	225 10.500
3.800		55.0	22.0	225 3.800	10.720	27/64	95.0	47.0	225 10.720
3.900		55.0	22.0	225 3.900	11.000		95.0	47.0	225 11.000
3.970	5/32	55.0	22.0	225 3.970	11.110	7/16	95.0	47.0	225 11.110
4.000		55.0	22.0	225 4.000	12.000		102.0	51.0	225 12.000
4.100		55.0	22.0	225 4.100	12.500		102.0	51.0	225 12.500
4.200		55.0	22.0	225 4.200	12.700	1/2	102.0	51.0	225 12.700
4.300		58.0	24.0	225 4.300	12.800		102.0	51.0	225 12.800
4.370	11/64	58.0	24.0	225 4.370	13.000		102.0	51.0	225 13.000
4.400		58.0	24.0	225 4.400	14.500		111.0	56.0	225 14.500
4.500		58.0	24.0	225 4.500	15.000		111.0	56.0	225 15.000
4.600		58.0	24.0	225 4.600	16.000		115.0	58.0	225 16.000
4.800		62.0	26.0	225 4.800	17.000		119.0	60.0	225 17.000
4.900		62.0	26.0	225 4.900	17.500		123.0	62.0	225 17.500
5.000		62.0	26.0	225 5.000	18.000		123.0	62.0	225 18.000
5.100		62.0	26.0	225 5.100	19.750		131.0	66.0	225 19.750
5.160		62.0	26.0	225 5.160	20.000		131.0	66.0	225 20.000
5.200		62.0	26.0	225 5.200					
5.250		62.0	26.0	225 5.250					

Stub drills

 Article no. **552**

Cutting data page 444

 Web thinning $\geq \varnothing 1.000$ • relieved cone • for higher tensile steels • bright < 2.36 mm

P	M	K	N	S	H
•		○	•		

Stub drills

 Article no. **553**

Cutting data page 444

 Web thinning $\geq \varnothing 1.000$ • relieved cone • for higher tensile steels • bright < 2.36 mm

P	M	K	N	S	H
•		○	•		

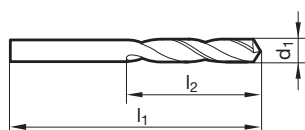

Article no. 552				Article no. 553		Article no. 552				Article no. 553	
d1 mm	inch	l1 mm	l2 mm	Order no.		d1 mm	inch	l1 mm	l2 mm	Order no.	
1.000		26.0	6.0	552 1.000	553 1.000	2.450		43.0	14.0	552 2.450	
1.020		26.0	6.0	552 1.020	553 1.020	2.490		43.0	14.0	552 2.490	553 2.490
1.040		26.0	6.0	552 1.040		2.500		43.0	14.0	552 2.500	553 2.500
1.050		26.0	6.0	552 1.050		2.530		43.0	14.0	552 2.530	553 2.530
1.070		28.0	7.0	552 1.070	553 1.070	2.550		43.0	14.0	552 2.550	553 2.550
1.090		28.0	7.0	552 1.090	553 1.090	2.580		43.0	14.0	552 2.580	553 2.580
1.100		28.0	7.0	552 1.100	553 1.100	2.600		43.0	14.0	552 2.600	553 2.600
1.150		28.0	7.0	552 1.150	553 1.150	2.640		43.0	14.0	552 2.640	553 2.640
1.180		28.0	7.0	552 1.180	553 1.180	2.650		43.0	14.0	552 2.650	
1.190	3/64	30.0	8.0	552 1.190		2.700		46.0	16.0	552 2.700	553 2.700
1.200		30.0	8.0	552 1.200	553 1.200	2.710		46.0	16.0	552 2.710	553 2.710
1.250		30.0	8.0	552 1.250	553 1.250	2.750		46.0	16.0	552 2.750	553 2.750
1.300		30.0	8.0	552 1.300	553 1.300	2.780	7/64	46.0	16.0	552 2.780	553 2.780
1.320		30.0	8.0	552 1.320	553 1.320	2.790		46.0	16.0	552 2.790	553 2.790
1.350		32.0	9.0	552 1.350	553 1.350	2.800		46.0	16.0	552 2.800	553 2.800
1.400		32.0	9.0	552 1.400	553 1.400	2.820		46.0	16.0	552 2.820	553 2.820
1.450		32.0	9.0	552 1.450	553 1.450	2.850		46.0	16.0	552 2.850	553 2.850
1.500		32.0	9.0	552 1.500	553 1.500	2.870		46.0	16.0	552 2.870	553 2.870
1.510		34.0	10.0	552 1.510		2.900		46.0	16.0	552 2.900	553 2.900
1.530		34.0	10.0	552 1.530		2.950		46.0	16.0	552 2.950	553 2.950
1.550		34.0	10.0	552 1.550	553 1.550	3.000		46.0	16.0	552 3.000	553 3.000
1.590	1/16	34.0	10.0	552 1.590	553 1.590	3.050		49.0	18.0	552 3.050	553 3.050
1.600		34.0	10.0	552 1.600	553 1.600	3.100		49.0	18.0	552 3.100	553 3.100
1.610		34.0	10.0	552 1.610	553 1.610	3.150		49.0	18.0	552 3.150	553 3.150
1.650		34.0	10.0	552 1.650	553 1.650	3.170	1/8	49.0	18.0	552 3.170	553 3.170
1.700		34.0	10.0	552 1.700	553 1.700	3.200		49.0	18.0	552 3.200	553 3.200
1.750		36.0	11.0	552 1.750	553 1.750	3.250		49.0	18.0	552 3.250	553 3.250
1.780		36.0	11.0	552 1.780	553 1.780	3.260		49.0	18.0	552 3.260	553 3.260
1.800		36.0	11.0	552 1.800	553 1.800	3.300		49.0	18.0	552 3.300	553 3.300
1.820		36.0	11.0	552 1.820		3.350		49.0	18.0	552 3.350	553 3.350
1.850		36.0	11.0	552 1.850	553 1.850	3.400		52.0	20.0	552 3.400	553 3.400
1.900		36.0	11.0	552 1.900	553 1.900	3.450		52.0	20.0	552 3.450	553 3.450
1.930		38.0	12.0	552 1.930	553 1.930	3.500		52.0	20.0	552 3.500	553 3.500
1.950		38.0	12.0	552 1.950	553 1.950	3.550		52.0	20.0	552 3.550	
1.980	5/64	38.0	12.0	552 1.980	553 1.980	3.570	9/64	52.0	20.0	552 3.570	553 3.570
1.990		38.0	12.0	552 1.990	553 1.990	3.600		52.0	20.0	552 3.600	553 3.600
2.000		38.0	12.0	552 2.000	553 2.000	3.650		52.0	20.0	552 3.650	553 3.650
2.050		38.0	12.0	552 2.050	553 2.050	3.660		52.0	20.0	552 3.660	553 3.660
2.060		38.0	12.0	552 2.060	553 2.060	3.680		52.0	20.0	552 3.680	553 3.680
2.080		38.0	12.0	552 2.080	553 2.080	3.700		52.0	20.0	552 3.700	553 3.700
2.100		38.0	12.0	552 2.100	553 2.100	3.730		52.0	20.0	552 3.730	
2.130		40.0	13.0	552 2.130		3.750		52.0	20.0	552 3.750	553 3.750
2.150		40.0	13.0	552 2.150		3.800		55.0	22.0	552 3.800	553 3.800
2.180		40.0	13.0	552 2.180	553 2.180	3.850		55.0	22.0	552 3.850	553 3.850
2.200		40.0	13.0	552 2.200	553 2.200	3.860		55.0	22.0	552 3.860	553 3.860
2.250		40.0	13.0	552 2.250	553 2.250	3.900		55.0	22.0	552 3.900	553 3.900
2.260		40.0	13.0	552 2.260	553 2.260	3.910		55.0	22.0	552 3.910	553 3.910
2.300		40.0	13.0	552 2.300	553 2.300	3.950		55.0	22.0	552 3.950	553 3.950
2.320		40.0	13.0	552 2.320		3.970	5/32	55.0	22.0	552 3.970	553 3.970
2.350		40.0	13.0	552 2.350	553 2.350	3.990		55.0	22.0	552 3.990	553 3.990
2.370		43.0	14.0	552 2.370		4.000		55.0	22.0	552 4.000	553 4.000
2.380	3/32	43.0	14.0	552 2.380	553 2.380	4.040		55.0	22.0	552 4.040	553 4.040
2.400		43.0	14.0	552 2.400	553 2.400	4.050		55.0	22.0	552 4.050	553 4.050
2.440		43.0	14.0	552 2.440	553 2.440	4.090		55.0	22.0	552 4.090	553 4.090



HSS/HSCO drills with straight shank

HSS/HSCO drills

Article no.				552	553	Article no.				552	553
d1 mm	inch	l1 mm	l2 mm	Order no.		d1 mm	inch	l1 mm	l2 mm	Order no.	
4.100		55.0	22.0	552 4.100	553 4.100	8.100		79.0	37.0	552 8.100	553 8.100
4.150		55.0	22.0	552 4.150	553 4.150	8.200		79.0	37.0	552 8.200	553 8.200
4.200		55.0	22.0	552 4.200	553 4.200	8.300		79.0	37.0	552 8.300	
4.220		55.0	22.0	552 4.220	553 4.220	8.330	21/64	79.0	37.0	552 8.330	
4.250		55.0	22.0	552 4.250		8.400		79.0	37.0	552 8.400	
4.300		58.0	24.0	552 4.300	553 4.300	8.430		79.0	37.0	552 8.430	553 8.430
4.350		58.0	24.0	552 4.350		8.500		79.0	37.0	552 8.500	553 8.500
4.370	11/64	58.0	24.0	552 4.370	553 4.370	8.600		84.0	40.0	552 8.600	553 8.600
4.390		58.0	24.0	552 4.390	553 4.390	8.610		84.0	40.0	552 8.610	553 8.610
4.400		58.0	24.0	552 4.400	553 4.400	8.700		84.0	40.0	552 8.700	553 8.700
4.450		58.0	24.0	552 4.450	553 4.450	8.730	11/32	84.0	40.0	552 8.730	
4.500		58.0	24.0	552 4.500	553 4.500	8.800		84.0	40.0	552 8.800	
4.550		58.0	24.0	552 4.550		8.840		84.0	40.0	552 8.840	553 8.840
4.570		58.0	24.0	552 4.570	553 4.570	8.900		84.0	40.0	552 8.900	
4.600		58.0	24.0	552 4.600	553 4.600	9.000		84.0	40.0	552 9.000	553 9.000
4.620		58.0	24.0	552 4.620	553 4.620	9.090		84.0	40.0	552 9.090	553 9.090
4.650		58.0	24.0	552 4.650	553 4.650	9.100		84.0	40.0	552 9.100	
4.700		58.0	24.0	552 4.700	553 4.700	9.130	23/64	84.0	40.0	552 9.130	553 9.130
4.750		58.0	24.0	552 4.750		9.200		84.0	40.0	552 9.200	
4.760	3/16	62.0	26.0	552 4.760	553 4.760	9.300		84.0	40.0	552 9.300	
4.800		62.0	26.0	552 4.800	553 4.800	9.340		84.0	40.0	552 9.340	553 9.340
4.850		62.0	26.0	552 4.850	553 4.850	9.400		84.0	40.0	552 9.400	553 9.400
4.900		62.0	26.0	552 4.900	553 4.900	9.500		84.0	40.0	552 9.500	553 9.500
4.920		62.0	26.0	552 4.920	553 4.920	9.520	3/8	89.0	43.0	552 9.520	553 9.520
4.950		62.0	26.0		553 4.950	9.580		89.0	43.0	552 9.580	
4.980		62.0	26.0	552 4.980		9.600		89.0	43.0	552 9.600	553 9.600
5.000		62.0	26.0	552 5.000	553 5.000	9.700		89.0	43.0	552 9.700	
5.060		62.0	26.0	552 5.060	553 5.060	9.800		89.0	43.0	552 9.800	553 9.800
5.100		62.0	26.0	552 5.100	553 5.100	9.900		89.0	43.0	552 9.900	553 9.900
5.110		62.0	26.0	552 5.110	553 5.110	9.920	25/64	89.0	43.0	552 9.920	553 9.920
5.160	13/64	62.0	26.0	552 5.160	553 5.160	10.000		89.0	43.0	552 10.000	553 10.000
5.180		62.0	26.0	552 5.180	553 5.180	10.080		89.0	43.0	552 10.080	
5.200		62.0	26.0	552 5.200	553 5.200	10.100		89.0	43.0		553 10.100
5.220		62.0	26.0	552 5.220	553 5.220	10.200		89.0	43.0	552 10.200	553 10.200
5.300		62.0	26.0	552 5.300	553 5.300	10.260		89.0	43.0	552 10.260	
5.310		66.0	28.0	552 5.310	553 5.310	10.300		89.0	43.0	552 10.300	
5.400		66.0	28.0	552 5.400		10.320	13/32	89.0	43.0	552 10.320	553 10.320
5.410		66.0	28.0	552 5.410		10.400		89.0	43.0		553 10.400
5.500		66.0	28.0	552 5.500	553 5.500	10.490		89.0	43.0	552 10.490	
5.560	7/32	66.0	28.0	552 5.560	553 5.560	10.500		89.0	43.0	552 10.500	553 10.500
5.600		66.0	28.0	552 5.600	553 5.600	10.600		89.0	43.0	552 10.600	
5.610		66.0	28.0	552 5.610	553 5.610	10.720	27/64	95.0	47.0	552 10.720	553 10.720
5.700		66.0	28.0	552 5.700	553 5.700	10.800		95.0	47.0	552 10.800	
5.790		66.0	28.0	552 5.790	553 5.790	10.900		95.0	47.0		553 10.900
5.800		66.0	28.0	552 5.800	553 5.800	11.000		95.0	47.0	552 11.000	553 11.000
5.900		66.0	28.0	552 5.900	553 5.900	11.100		95.0	47.0		553 11.100
5.940		66.0	28.0	552 5.940	553 5.940	11.110	7/16	95.0	47.0	552 11.110	553 11.110
5.950	15/64	66.0	28.0	552 5.950	553 5.950	11.200		95.0	47.0	552 11.200	
6.000		66.0	28.0	552 6.000	553 6.000	11.300		95.0	47.0	552 11.300	
6.040		70.0	31.0	552 6.040		11.400		95.0	47.0	552 11.400	
6.100		70.0	31.0	552 6.100	553 6.100	11.500		95.0	47.0	552 11.500	553 11.500
6.150		70.0	31.0	552 6.150	553 6.150	11.510	29/64	95.0	47.0	552 11.510	553 11.510
6.200		70.0	31.0	552 6.200	553 6.200	11.800		95.0	47.0	552 11.800	553 11.800
6.250		70.0	31.0	552 6.250	553 6.250	11.910	15/32	102.0	51.0	552 11.910	
6.300		70.0	31.0	552 6.300	553 6.300	12.000		102.0	51.0	552 12.000	553 12.000
6.350	1/4	70.0	31.0	552 6.350	553 6.350	12.300	31/64	102.0	51.0	552 12.300	553 12.300
6.400		70.0	31.0	552 6.400		12.400		102.0	51.0	552 12.400	
6.500		70.0	31.0	552 6.500	553 6.500	12.500		102.0	51.0	552 12.500	553 12.500
6.530		70.0	31.0	552 6.530	553 6.530	12.700	1/2	102.0	51.0	552 12.700	553 12.700
6.600		70.0	31.0	552 6.600	553 6.600	12.800		102.0	51.0		553 12.800
6.630		70.0	31.0	552 6.630	553 6.630	12.900		102.0	51.0	552 12.900	
6.700		70.0	31.0	552 6.700	553 6.700	13.000		102.0	51.0	552 13.000	553 13.000
6.750	17/64	74.0	34.0	552 6.750	553 6.750	13.100	33/64	102.0	51.0	552 13.100	553 13.100
6.800		74.0	34.0	552 6.800	553 6.800	13.490	17/32	107.0	54.0	552 13.490	553 13.490
6.900		74.0	34.0	552 6.900	553 6.900	13.500		107.0	54.0	552 13.500	
7.000		74.0	34.0	552 7.000	553 7.000	13.890	35/64	107.0	54.0	552 13.890	553 13.890
7.030		74.0	34.0	552 7.030	553 7.030	14.000		107.0	54.0	552 14.000	553 14.000
7.100		74.0	34.0	552 7.100		14.290	9/16	111.0	56.0	552 14.290	553 14.290
7.140	9/32	74.0	34.0	552 7.140	553 7.140	14.500		111.0	56.0	552 14.500	553 14.500
7.200		74.0	34.0	552 7.200		14.680	37/64	111.0	56.0	552 14.680	
7.300		74.0	34.0	552 7.300	553 7.300	15.000		111.0	56.0	552 15.000	553 15.000
7.370		74.0	34.0	552 7.370	553 7.370	15.080	19/32	115.0	58.0	552 15.080	553 15.080
7.400		74.0	34.0	552 7.400	553 7.400	15.480	39/64	115.0	58.0	552 15.480	553 15.480
7.490		74.0	34.0	552 7.490	553 7.490	15.500		115.0	58.0		553 15.500
7.500		74.0	34.0	552 7.500	553 7.500	15.870	5/8	115.0	58.0	552 15.870	553 15.870
7.540	19/64	79.0	37.0	552 7.540	553 7.540	16.000		115.0	58.0	552 16.000	553 16.000
7.600		79.0	37.0	552 7.600	553 7.600	16.270	41/64	119.0	60.0	552 16.270	553 16.270
7.670		79.0	37.0	552 7.670	553 7.670	16.500		119.0	60.0	552 16.500	
7.700		79.0	37.0	552 7.700	553 7.700	16.670		119.0	60.0	552 16.670	
7.800		79.0	37.0	552 7.800		17.000		119.0	60.0	552 17.000	
7.900		79.0	37.0	552 7.900		17.070	43/64	123.0	62.0	552 17.070	
7.940	5/16	79.0	37.0	552 7.940	553 7.940	17.460	11/16	123.0	62.0	552 17.460	553 17.460
8.000		79.0	37.0	552 8.000	553 8.000	17.860	45/64	123.0	62.0	552 17.860	
8.030		79.0	37.0	552 8.030		18.000		123.0	62.0	552 18.000	553 18.000



				Article no.	
				552	553
d1 mm	inch	l1 mm	l2 mm	Order no.	
18.260	23/32	127.0	64.0	552 18.260	
18.650		127.0	64.0	552 18.650	
19.000		127.0	64.0	552 19.000	553 19.000
19.050	3/4	131.0	66.0	552 19.050	
19.840	25/32	131.0	66.0	552 19.840	
20.000		131.0	66.0	552 20.000	

				Article no.	
				552	553
d1 mm	inch	l1 mm	l2 mm	Order no.	

HSS/HSCO drills



HSS/HSCO drills with straight shank

HSS/HSCO drills

Stub drills

Article no. **329**



Web thinning $\geq \varnothing 1.000$ • relieved cone • Co-alloyed high speed steel • increased wear resistance

Cutting data page 446

P	M	K	N	S	H
●	●	●	○	○	○

Stub drills

Article no. **659**

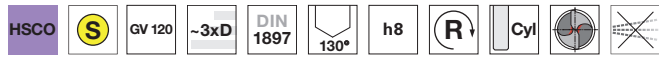

Web thinning $\geq \varnothing 1.000$ • relieved cone • Co-alloyed high speed steel • increased wear resistance

Cutting data page 446

P	M	K	N	S	H
●	●	●	○	●	○

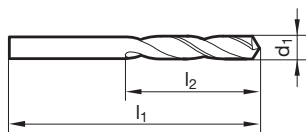

Article no. 329				659		Article no. 329				659	
d1 mm	inch	l1 mm	l2 mm	Order no.		d1 mm	inch	l1 mm	l2 mm	Order no.	
0.400	1/64	19.0	2.5	329 0.400		1.510		34.0	10.0	329 1.510	659 1.510
0.500		20.0	3.0	329 0.500	659 0.500	1.530		34.0	10.0		659 1.530
0.510		20.0	3.0	329 0.510		1.550		34.0	10.0	329 1.550	659 1.550
0.520		20.0	3.0	329 0.520		1.570		34.0	10.0	329 1.570	659 1.570
0.550		21.0	3.5	329 0.550		1.590	1/16	34.0	10.0	329 1.590	659 1.590
0.570		21.0	3.5	329 0.570		1.600		34.0	10.0	329 1.600	659 1.600
0.580		21.0	3.5	329 0.580		1.610		34.0	10.0	329 1.610	659 1.610
0.590		21.0	3.5	329 0.590		1.630		34.0	10.0	329 1.630	
0.600		21.0	3.5	329 0.600	659 0.600	1.650		34.0	10.0	329 1.650	
0.610		22.0	4.0	329 0.610		1.680		34.0	10.0	329 1.680	
0.640		22.0	4.0	329 0.640		1.700		34.0	10.0	329 1.700	659 1.700
0.650		22.0	4.0	329 0.650	659 0.650	1.730		36.0	11.0	329 1.730	
0.700		23.0	4.5	329 0.700	659 0.700	1.750		36.0	11.0	329 1.750	
0.730		23.0	4.5	329 0.730		1.780		36.0	11.0	329 1.780	659 1.780
0.740		23.0	4.5	329 0.740	659 0.740	1.800		36.0	11.0	329 1.800	659 1.800
0.750		23.0	4.5	329 0.750	659 0.750	1.820		36.0	11.0	329 1.820	
0.790	1/32	24.0	5.0	329 0.790	659 0.790	1.830		36.0	11.0	329 1.830	
0.800		24.0	5.0	329 0.800	659 0.800	1.850		36.0	11.0	329 1.850	659 1.850
0.810		24.0	5.0	329 0.810		1.900		36.0	11.0	329 1.900	659 1.900
0.820		24.0	5.0	329 0.820		1.930		38.0	12.0	329 1.930	659 1.930
0.840		24.0	5.0	329 0.840		1.950		38.0	12.0	329 1.950	
0.850		24.0	5.0	329 0.850	659 0.850	1.970		38.0	12.0	329 1.970	659 1.970
0.870		25.0	5.5	329 0.870		1.980	5/64	38.0	12.0	329 1.980	659 1.980
0.900		25.0	5.5	329 0.900	659 0.900	1.990		38.0	12.0	329 1.990	659 1.990
0.910		25.0	5.5	329 0.910		2.000		38.0	12.0	329 2.000	659 2.000
0.940		25.0	5.5	329 0.940		2.030		38.0	12.0	329 2.030	
0.950		25.0	5.5	329 0.950	659 0.950	2.050		38.0	12.0	329 2.050	659 2.050
0.960		26.0	6.0	329 0.960		2.060		38.0	12.0	329 2.060	
0.970		26.0	6.0	329 0.970		2.080		38.0	12.0	329 2.080	659 2.080
0.990		26.0	6.0	329 0.990		2.100		38.0	12.0	329 2.100	659 2.100
1.000		26.0	6.0	329 1.000	659 1.000	2.150		40.0	13.0	329 2.150	
1.020		26.0	6.0	329 1.020	659 1.020	2.180		40.0	13.0	329 2.180	659 2.180
1.030		26.0	6.0	329 1.030		2.200		40.0	13.0	329 2.200	659 2.200
1.050		26.0	6.0	329 1.050		2.250		40.0	13.0	329 2.250	659 2.250
1.070		28.0	7.0	329 1.070	659 1.070	2.260		40.0	13.0	329 2.260	659 2.260
1.090		28.0	7.0	329 1.090	659 1.090	2.300		40.0	13.0	329 2.300	659 2.300
1.100		28.0	7.0	329 1.100	659 1.100	2.320		40.0	13.0	329 2.320	
1.150		28.0	7.0	329 1.150	659 1.150	2.350		40.0	13.0	329 2.350	659 2.350
1.170		28.0	7.0	329 1.170		2.360		40.0	13.0	329 2.360	
1.180		28.0	7.0	329 1.180	659 1.180	2.370		43.0	14.0	329 2.370	659 2.370
1.190	3/64	30.0	8.0	329 1.190	659 1.190	2.380	3/32	43.0	14.0	329 2.380	659 2.380
1.200		30.0	8.0	329 1.200	659 1.200	2.400		43.0	14.0	329 2.400	659 2.400
1.230		30.0	8.0	329 1.230		2.420		43.0	14.0	329 2.420	
1.250		30.0	8.0	329 1.250	659 1.250	2.440		43.0	14.0	329 2.440	659 2.440
1.280		30.0	8.0	329 1.280		2.450		43.0	14.0	329 2.450	659 2.450
1.300		30.0	8.0	329 1.300	659 1.300	2.470		43.0	14.0	329 2.470	
1.320		30.0	8.0	329 1.320	659 1.320	2.490		43.0	14.0	329 2.490	659 2.490
1.330		32.0	9.0	329 1.330		2.500		43.0	14.0	329 2.500	659 2.500
1.350		32.0	9.0	329 1.350		2.520		43.0	14.0	329 2.520	
1.370		32.0	9.0	329 1.370		2.530		43.0	14.0	329 2.530	659 2.530
1.400		32.0	9.0	329 1.400	659 1.400	2.550		43.0	14.0	329 2.550	659 2.550
1.450		32.0	9.0	329 1.450	659 1.450	2.580		43.0	14.0	329 2.580	659 2.580
1.470		32.0	9.0	329 1.470		2.600		43.0	14.0	329 2.600	659 2.600
1.500		32.0	9.0	329 1.500	659 1.500	2.640		43.0	14.0	329 2.640	659 2.640



Article no.				329	659	Article no.				329	659
d1 mm	inch	l1 mm	l2 mm	Order no.		d1 mm	inch	l1 mm	l2 mm	Order no.	
2.650		43.0	14.0	329 2.650		5.250		62.0	26.0	329 5.250	
2.700		46.0	16.0	329 2.700	659 2.700	5.300		62.0	26.0	329 5.300	659 5.300
2.710		46.0	16.0	329 2.710	659 2.710	5.310		66.0	28.0	329 5.310	659 5.310
2.750		46.0	16.0	329 2.750		5.350		66.0	28.0	329 5.350	
2.780	7/64	46.0	16.0	329 2.780	659 2.780	5.400		66.0	28.0	329 5.400	659 5.400
2.790		46.0	16.0	329 2.790		5.410		66.0	28.0	329 5.410	
2.800		46.0	16.0	329 2.800	659 2.800	5.450		66.0	28.0	329 5.450	
2.820		46.0	16.0	329 2.820	659 2.820	5.500		66.0	28.0	329 5.500	659 5.500
2.850		46.0	16.0	329 2.850	659 2.850	5.550		66.0	28.0	329 5.550	
2.870		46.0	16.0	329 2.870		5.560	7/32	66.0	28.0	329 5.560	659 5.560
2.900		46.0	16.0	329 2.900	659 2.900	5.600		66.0	28.0	329 5.600	659 5.600
2.950		46.0	16.0	329 2.950	659 2.950	5.610		66.0	28.0	329 5.610	659 5.610
3.000		46.0	16.0	329 3.000	659 3.000	5.700		66.0	28.0	329 5.700	659 5.700
3.020		49.0	18.0	329 3.020		5.750		66.0	28.0	329 5.750	
3.030		49.0	18.0		659 3.030	5.790		66.0	28.0	329 5.790	
3.050		49.0	18.0	329 3.050	659 3.050	5.800		66.0	28.0	329 5.800	659 5.800
3.100		49.0	18.0	329 3.100	659 3.100	5.850		66.0	28.0	329 5.850	
3.150		49.0	18.0	329 3.150		5.900		66.0	28.0	329 5.900	659 5.900
3.170	1/8	49.0	18.0	329 3.170	659 3.170	5.940		66.0	28.0	329 5.940	659 5.940
3.200		49.0	18.0	329 3.200	659 3.200	5.950	15/64	66.0	28.0	329 5.950	
3.250		49.0	18.0	329 3.250	659 3.250	6.000		66.0	28.0	329 6.000	659 6.000
3.260		49.0	18.0	329 3.260	659 3.260	6.040		70.0	31.0	329 6.040	659 6.040
3.300		49.0	18.0	329 3.300	659 3.300	6.050		70.0	31.0	329 6.050	659 6.050
3.350		49.0	18.0	329 3.350	659 3.350	6.100		70.0	31.0	329 6.100	659 6.100
3.400		52.0	20.0	329 3.400	659 3.400	6.150		70.0	31.0	329 6.150	659 6.150
3.450		52.0	20.0	329 3.450	659 3.450	6.200		70.0	31.0	329 6.200	659 6.200
3.500		52.0	20.0	329 3.500	659 3.500	6.250		70.0	31.0	329 6.250	
3.520		52.0	20.0	329 3.520		6.300		70.0	31.0	329 6.300	659 6.300
3.550		52.0	20.0	329 3.550		6.320		70.0	31.0	329 6.320	
3.570	9/64	52.0	20.0	329 3.570	659 3.570	6.350	1/4	70.0	31.0	329 6.350	659 6.350
3.600		52.0	20.0	329 3.600	659 3.600	6.400		70.0	31.0	329 6.400	659 6.400
3.660		52.0	20.0	329 3.660	659 3.660	6.450		70.0	31.0	329 6.450	
3.700		52.0	20.0	329 3.700	659 3.700	6.500		70.0	31.0	329 6.500	659 6.500
3.730		52.0	20.0	329 3.730	659 3.730	6.530		70.0	31.0	329 6.530	659 6.530
3.750		52.0	20.0	329 3.750		6.550		70.0	31.0	329 6.550	
3.800		55.0	22.0	329 3.800	659 3.800	6.600		70.0	31.0	329 6.600	659 6.600
3.850		55.0	22.0	329 3.850		6.630		70.0	31.0	329 6.630	
3.860		55.0	22.0	329 3.860	659 3.860	6.700		70.0	31.0	329 6.700	659 6.700
3.900		55.0	22.0	329 3.900	659 3.900	6.750	17/64	74.0	34.0	329 6.750	659 6.750
3.910		55.0	22.0	329 3.910	659 3.910	6.800		74.0	34.0	329 6.800	659 6.800
3.950		55.0	22.0	329 3.950		6.850		74.0	34.0	329 6.850	
3.970	5/32	55.0	22.0	329 3.970	659 3.970	6.900		74.0	34.0	329 6.900	659 6.900
3.990		55.0	22.0	329 3.990	659 3.990	7.000		74.0	34.0	329 7.000	659 7.000
4.000		55.0	22.0	329 4.000	659 4.000	7.030		74.0	34.0	329 7.030	
4.040		55.0	22.0	329 4.040	659 4.040	7.050		74.0	34.0	329 7.050	
4.050		55.0	22.0	329 4.050	659 4.050	7.100		74.0	34.0	329 7.100	659 7.100
4.090		55.0	22.0	329 4.090	659 4.090	7.140	9/32	74.0	34.0	329 7.140	659 7.140
4.100		55.0	22.0	329 4.100	659 4.100	7.200		74.0	34.0	329 7.200	659 7.200
4.150		55.0	22.0	329 4.150	659 4.150	7.250		74.0	34.0	329 7.250	
4.200		55.0	22.0	329 4.200	659 4.200	7.300		74.0	34.0	329 7.300	659 7.300
4.220		55.0	22.0	329 4.220		7.350		74.0	34.0	329 7.350	
4.250		55.0	22.0	329 4.250	659 4.250	7.370		74.0	34.0	329 7.370	659 7.370
4.300		58.0	24.0	329 4.300	659 4.300	7.400		74.0	34.0	329 7.400	659 7.400
4.350		58.0	24.0	329 4.350		7.490		74.0	34.0	329 7.490	659 7.490
4.370	11/64	58.0	24.0	329 4.370	659 4.370	7.500		74.0	34.0	329 7.500	659 7.500
4.390		58.0	24.0	329 4.390	659 4.390	7.540	19/64	79.0	37.0	329 7.540	659 7.540
4.400		58.0	24.0	329 4.400	659 4.400	7.550		79.0	37.0	329 7.550	
4.450		58.0	24.0	329 4.450		7.600		79.0	37.0	329 7.600	659 7.600
4.500		58.0	24.0	329 4.500	659 4.500	7.670		79.0	37.0	329 7.670	
4.550		58.0	24.0	329 4.550		7.700		79.0	37.0	329 7.700	659 7.700
4.570		58.0	24.0	329 4.570		7.750		79.0	37.0	329 7.750	
4.600		58.0	24.0	329 4.600	659 4.600	7.800		79.0	37.0	329 7.800	659 7.800
4.620		58.0	24.0	329 4.620	659 4.620	7.900		79.0	37.0	329 7.900	659 7.900
4.650		58.0	24.0	329 4.650		7.940	5/16	79.0	37.0	329 7.940	659 7.940
4.700		58.0	24.0	329 4.700	659 4.700	8.000		79.0	37.0	329 8.000	659 8.000
4.750		58.0	24.0	329 4.750		8.030		79.0	37.0	329 8.030	
4.760	3/16	62.0	26.0	329 4.760	659 4.760	8.050		79.0	37.0	329 8.050	
4.800		62.0	26.0	329 4.800	659 4.800	8.100		79.0	37.0	329 8.100	659 8.100
4.850		62.0	26.0	329 4.850	659 4.850	8.150		79.0	37.0	329 8.150	
4.900		62.0	26.0	329 4.900	659 4.900	8.200		79.0	37.0	329 8.200	659 8.200
4.920		62.0	26.0	329 4.920	659 4.920	8.250		79.0	37.0	329 8.250	
4.950		62.0	26.0	329 4.950		8.300		79.0	37.0	329 8.300	659 8.300
4.980		62.0	26.0	329 4.980		8.330	21/64	79.0	37.0	329 8.330	
5.000		62.0	26.0	329 5.000	659 5.000	8.400		79.0	37.0	329 8.400	659 8.400
5.020		62.0	26.0	329 5.020		8.430		79.0	37.0	329 8.430	
5.050		62.0	26.0	329 5.050		8.500		79.0	37.0	329 8.500	659 8.500
5.060		62.0	26.0	329 5.060	659 5.060	8.520		84.0	40.0	329 8.520	
5.100		62.0	26.0	329 5.100	659 5.100	8.550		84.0	40.0	329 8.550	
5.110		62.0	26.0	329 5.110		8.600		84.0	40.0	329 8.600	659 8.600
5.150		62.0	26.0	329 5.150		8.610		84.0	40.0	329 8.610	
5.160	13/64	62.0	26.0	329 5.160	659 5.160	8.700		84.0	40.0	329 8.700	659 8.700
5.180		62.0	26.0	329 5.180		8.730	11/32	84.0	40.0	329 8.730	659 8.730
5.200		62.0	26.0	329 5.200	659 5.200	8.750		84.0	40.0	329 8.750	
5.220		62.0	26.0	329 5.220	659 5.220	8.800		84.0	40.0	329 8.800	659 8.800

HSS/HSCO drills



HSS/HSCO drills with straight shank

HSS/HSCO drills

Article no.				329	659	Article no.				329	659
d1 mm	inch	l1 mm	l2 mm	Order no.		d1 mm	inch	l1 mm	l2 mm	Order no.	
8.840		84.0	40.0	329 8.840	659 8.840	12.900		102.0	51.0	329 12.900	
8.900		84.0	40.0	329 8.900		13.000		102.0	51.0	329 13.000	659 13.000
9.000		84.0	40.0	329 9.000	659 9.000	13.100	33/64	102.0	51.0	329 13.100	
9.050		84.0	40.0	329 9.050		13.200		102.0	51.0	329 13.200	
9.090		84.0	40.0	329 9.090		13.300		107.0	54.0		659 13.300
9.100		84.0	40.0	329 9.100	659 9.100	13.490	17/32	107.0	54.0	329 13.490	659 13.490
9.130	23/64	84.0	40.0	329 9.130	659 9.130	13.500		107.0	54.0	329 13.500	659 13.500
9.200		84.0	40.0	329 9.200	659 9.200	13.600		107.0	54.0	329 13.600	
9.250		84.0	40.0	329 9.250		13.750		107.0	54.0	329 13.750	
9.300		84.0	40.0	329 9.300	659 9.300	13.800		107.0	54.0	329 13.800	
9.340		84.0	40.0	329 9.340		13.890	35/64	107.0	54.0	329 13.890	
9.400		84.0	40.0	329 9.400	659 9.400	14.000		107.0	54.0	329 14.000	659 14.000
9.500		84.0	40.0	329 9.500	659 9.500	14.200		111.0	56.0	329 14.200	
9.520	3/8	89.0	43.0	329 9.520	659 9.520	14.290	9/16	111.0	56.0	329 14.290	659 14.290
9.580		89.0	43.0	329 9.580		14.500		111.0	56.0	329 14.500	659 14.500
9.600		89.0	43.0	329 9.600	659 9.600	14.680	37/64	111.0	56.0	329 14.680	
9.700		89.0	43.0	329 9.700	659 9.700	14.750		111.0	56.0	329 14.750	
9.750		89.0	43.0	329 9.750		15.000		111.0	56.0	329 15.000	659 15.000
9.800		89.0	43.0	329 9.800	659 9.800	15.080	19/32	115.0	58.0	329 15.080	
9.900		89.0	43.0	329 9.900	659 9.900	15.480	39/64	115.0	58.0	329 15.480	
9.920	25/64	89.0	43.0	329 9.920	659 9.920	15.500		115.0	58.0	329 15.500	659 15.500
10.000		89.0	43.0	329 10.000	659 10.000	15.870	5/8	115.0	58.0	329 15.870	
10.050		89.0	43.0	329 10.050		16.000		115.0	58.0	329 16.000	
10.080		89.0	43.0	329 10.080		16.200		119.0	60.0	329 16.200	
10.100		89.0	43.0	329 10.100	659 10.100	16.270	41/64	119.0	60.0	329 16.270	
10.200		89.0	43.0	329 10.200	659 10.200	16.500		119.0	60.0	329 16.500	
10.250		89.0	43.0		659 10.250	16.670	21/32	119.0	60.0	329 16.670	
10.260		89.0	43.0	329 10.260		17.000		119.0	60.0	329 17.000	
10.300		89.0	43.0	329 10.300		17.070	43/64	123.0	62.0	329 17.070	
10.320	13/32	89.0	43.0	329 10.320	659 10.320	17.460	11/16	123.0	62.0	329 17.460	
10.400		89.0	43.0	329 10.400		17.500		123.0	62.0	329 17.500	
10.490		89.0	43.0	329 10.490		17.860	45/64	123.0	62.0	329 17.860	
10.500		89.0	43.0	329 10.500	659 10.500	18.000		123.0	62.0	329 18.000	
10.600		89.0	43.0	329 10.600		18.500		127.0	64.0	329 18.500	
10.650		95.0	47.0	329 10.650		18.650	47/64	127.0	64.0	329 18.650	
10.720	27/64	95.0	47.0	329 10.720	659 10.720	19.000		127.0	64.0	329 19.000	
10.800		95.0	47.0	329 10.800	659 10.800	19.050	3/4	131.0	66.0	329 19.050	
10.900		95.0	47.0	329 10.900	659 10.900	19.450	49/64	131.0	66.0	329 19.450	
11.000		95.0	47.0	329 11.000	659 11.000	19.500		131.0	66.0	329 19.500	
11.100		95.0	47.0	329 11.100		19.840	25/32	131.0	66.0	329 19.840	
11.110	7/16	95.0	47.0	329 11.110	659 11.110	20.000		131.0	66.0	329 20.000	
11.200		95.0	47.0	329 11.200		20.250		136.0	68.0	329 20.250	
11.250		95.0	47.0	329 11.250		20.500		136.0	68.0	329 20.500	
11.300		95.0	47.0	329 11.300		20.640	13/16	136.0	68.0	329 20.640	
11.400		95.0	47.0	329 11.400		21.000		136.0	68.0	329 21.000	
11.500		95.0	47.0	329 11.500	659 11.500	21.500		141.0	70.0	329 21.500	
11.510	29/64	95.0	47.0	329 11.510		22.000		141.0	70.0	329 22.000	
11.600		95.0	47.0	329 11.600		22.200		141.0	70.0	329 22.200	
11.700		95.0	47.0	329 11.700		23.000		146.0	72.0	329 23.000	
11.800		95.0	47.0	329 11.800		24.000		151.0	75.0	329 24.000	
11.910	15/32	102.0	51.0	329 11.910		24.500		151.0	75.0	329 24.500	
12.000		102.0	51.0	329 12.000	659 12.000	25.000	63/64	151.0	75.0	329 25.000	
12.100		102.0	51.0	329 12.100	659 12.100	25.400	1	156.0	78.0	329 25.400	
12.200		102.0	51.0	329 12.200	659 12.200	25.500		156.0	78.0	329 25.500	
12.300	31/64	102.0	51.0	329 12.300	659 12.300	26.000		156.0	78.0	329 26.000	
12.400		102.0	51.0	329 12.400		28.000		162.0	81.0	329 28.000	
12.500		102.0	51.0	329 12.500	659 12.500	48.000		228.0	116.0	329 48.000	
12.600		102.0	51.0	329 12.600							
12.700	1/2	102.0	51.0	329 12.700	659 12.700						
12.800		102.0	51.0	329 12.800	659 12.800						



Stub drills

Article no. **2461**



Cutting data page 447

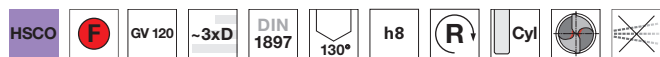

P	M	K	N	S	H
●	●	●	○	●	○

Web thinning ≥ Ø 1.000 • relieved cone • Co-alloyed high speed steel • increased wear resistance

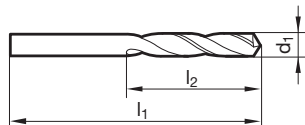

Article no. 2461				Article no. 2461					
d1 mm	inch	l1 mm	l2 mm	Order no.	d1 mm	inch	l1 mm	l2 mm	Order no.
1.000		26.0	6.0	2461 1.000	6.100		70.0	31.0	2461 6.100
1.100		28.0	7.0	2461 1.100	6.200		70.0	31.0	2461 6.200
1.200		30.0	8.0	2461 1.200	6.300		70.0	31.0	2461 6.300
1.300		30.0	8.0	2461 1.300	6.400		70.0	31.0	2461 6.400
1.400		32.0	9.0	2461 1.400	6.500		70.0	31.0	2461 6.500
1.500		32.0	9.0	2461 1.500	6.600		70.0	31.0	2461 6.600
1.600		34.0	10.0	2461 1.600	6.700		70.0	31.0	2461 6.700
1.700		34.0	10.0	2461 1.700	6.800		74.0	34.0	2461 6.800
1.800		36.0	11.0	2461 1.800	6.900		74.0	34.0	2461 6.900
1.900		36.0	11.0	2461 1.900	7.000		74.0	34.0	2461 7.000
2.000		38.0	12.0	2461 2.000	7.200		74.0	34.0	2461 7.200
2.100		38.0	12.0	2461 2.100	7.300		74.0	34.0	2461 7.300
2.200		40.0	13.0	2461 2.200	7.400		74.0	34.0	2461 7.400
2.300		40.0	13.0	2461 2.300	7.500		74.0	34.0	2461 7.500
2.400		43.0	14.0	2461 2.400	7.600		79.0	37.0	2461 7.600
2.500		43.0	14.0	2461 2.500	7.800		79.0	37.0	2461 7.800
2.600		43.0	14.0	2461 2.600	7.900		79.0	37.0	2461 7.900
2.700		46.0	16.0	2461 2.700	8.000		79.0	37.0	2461 8.000
2.800		46.0	16.0	2461 2.800	8.100		79.0	37.0	2461 8.100
2.900		46.0	16.0	2461 2.900	8.200		79.0	37.0	2461 8.200
3.000		46.0	16.0	2461 3.000	8.300		79.0	37.0	2461 8.300
3.100		49.0	18.0	2461 3.100	8.500		79.0	37.0	2461 8.500
3.200		49.0	18.0	2461 3.200	8.600		84.0	40.0	2461 8.600
3.300		49.0	18.0	2461 3.300	8.700		84.0	40.0	2461 8.700
3.400		52.0	20.0	2461 3.400	8.800		84.0	40.0	2461 8.800
3.500		52.0	20.0	2461 3.500	9.000		84.0	40.0	2461 9.000
3.600		52.0	20.0	2461 3.600	9.100		84.0	40.0	2461 9.100
3.700		52.0	20.0	2461 3.700	9.200		84.0	40.0	2461 9.200
3.800		55.0	22.0	2461 3.800	9.300		84.0	40.0	2461 9.300
3.900		55.0	22.0	2461 3.900	9.500		84.0	40.0	2461 9.500
4.000		55.0	22.0	2461 4.000	9.700		89.0	43.0	2461 9.700
4.200		55.0	22.0	2461 4.200	9.800		89.0	43.0	2461 9.800
4.300		58.0	24.0	2461 4.300	10.000		89.0	43.0	2461 10.000
4.400		58.0	24.0	2461 4.400	10.200		89.0	43.0	2461 10.200
4.500		58.0	24.0	2461 4.500	10.500		89.0	43.0	2461 10.500
4.600		58.0	24.0	2461 4.600	11.000		95.0	47.0	2461 11.000
4.700		58.0	24.0	2461 4.700	11.500		95.0	47.0	2461 11.500
4.800		62.0	26.0	2461 4.800	11.800		95.0	47.0	2461 11.800
4.900		62.0	26.0	2461 4.900	12.000		102.0	51.0	2461 12.000
5.000		62.0	26.0	2461 5.000	13.000		102.0	51.0	2461 13.000
5.100		62.0	26.0	2461 5.100	15.000		111.0	56.0	2461 15.000
5.200		62.0	26.0	2461 5.200					
5.300		62.0	26.0	2461 5.300					
5.400		66.0	28.0	2461 5.400					
5.500		66.0	28.0	2461 5.500					
5.600		66.0	28.0	2461 5.600					
5.800		66.0	28.0	2461 5.800					
6.000		66.0	28.0	2461 6.000					

HSS/HSCO drills



HSS/HSCO drills with straight shank

HSS/HSCO drills

Stub drills

Article no. **1228**



Cutting data page 444-445

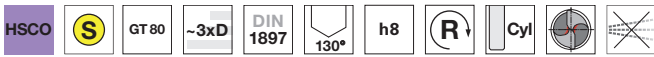

P	M	K	N	S	H
●	○	○	○	○	○

Web thinning ≥ Ø 1.000 • relieved cone • Co-alloyed high speed steel • increased wear resistance

Stub drills

Article no. **2498**



Cutting data page 444-445

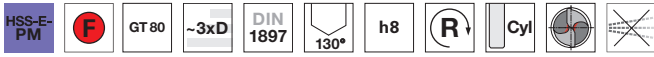

P	M	K	N	S	H
●	○	○	○	○	○

Web thinning ≥ Ø 1.000 • relieved cone • Co-alloyed high speed steel • increased wear resistance

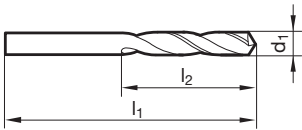

Article no. 1228				Article no. 2498		Article no. 1228				Article no. 2498	
d1 mm	inch	l1 mm	l2 mm	Order no.		d1 mm	inch	l1 mm	l2 mm	Order no.	
1.000		26.0	6.0	1228 1.000	2498 1.000	6.200		70.0	31.0	1228 6.200	2498 6.200
1.100		28.0	7.0	1228 1.100		6.350	1/4	70.0	31.0	1228 6.350	
1.190	3/64	30.0	8.0	1228 1.190		6.400		70.0	31.0	1228 6.400	
1.200		30.0	8.0	1228 1.200	2498 1.200	6.500		70.0	31.0	1228 6.500	2498 6.500
1.300		30.0	8.0		2498 1.300	6.600		70.0	31.0	1228 6.600	2498 6.600
1.500		32.0	9.0	1228 1.500		6.700		70.0	31.0	1228 6.700	
1.600		34.0	10.0	1228 1.600		6.750	17/64	74.0	34.0	1228 6.750	
1.700		34.0	10.0	1228 1.700		6.800		74.0	34.0	1228 6.800	2498 6.800
1.800		36.0	11.0	1228 1.800	2498 1.800	6.900		74.0	34.0	1228 6.900	2498 6.900
1.900		36.0	11.0	1228 1.900		7.000		74.0	34.0	1228 7.000	2498 7.000
2.000		38.0	12.0	1228 2.000	2498 2.000	7.100		74.0	34.0	1228 7.100	2498 7.100
2.100		38.0	12.0	1228 2.100		7.200		74.0	34.0	1228 7.200	
2.200		40.0	13.0	1228 2.200	2498 2.200	7.300		74.0	34.0	1228 7.300	
2.300		40.0	13.0	1228 2.300	2498 2.300	7.400		74.0	34.0	1228 7.400	
2.400		43.0	14.0	1228 2.400	2498 2.400	7.500		74.0	34.0	1228 7.500	2498 7.500
2.500		43.0	14.0	1228 2.500	2498 2.500	7.600		79.0	37.0		2498 7.600
2.600		43.0	14.0	1228 2.600	2498 2.600	7.700		79.0	37.0	1228 7.700	2498 7.700
2.800		46.0	16.0	1228 2.800	2498 2.800	7.800		79.0	37.0	1228 7.800	2498 7.800
2.900		46.0	16.0	1228 2.900	2498 2.900	7.940	5/16	79.0	37.0	1228 7.940	
3.000		46.0	16.0	1228 3.000	2498 3.000	8.000		79.0	37.0	1228 8.000	2498 8.000
3.100		49.0	18.0	1228 3.100	2498 3.100	8.100		79.0	37.0	1228 8.100	
3.200		49.0	18.0	1228 3.200	2498 3.200	8.200		79.0	37.0	1228 8.200	
3.300		49.0	18.0	1228 3.300	2498 3.300	8.300		79.0	37.0	1228 8.300	
3.400		52.0	20.0	1228 3.400	2498 3.400	8.500		79.0	37.0	1228 8.500	2498 8.500
3.500		52.0	20.0	1228 3.500	2498 3.500	8.600		84.0	40.0	1228 8.600	2498 8.600
3.570	9/64	52.0	20.0	1228 3.570		8.700		84.0	40.0	1228 8.700	
3.600		52.0	20.0	1228 3.600	2498 3.600	8.800		84.0	40.0	1228 8.800	
3.700		52.0	20.0	1228 3.700	2498 3.700	8.900		84.0	40.0	1228 8.900	
3.800		55.0	22.0	1228 3.800		9.000		84.0	40.0	1228 9.000	2498 9.000
3.900		55.0	22.0	1228 3.900		9.100		84.0	40.0	1228 9.100	
4.000		55.0	22.0	1228 4.000	2498 4.000	9.130	23/64	84.0	40.0	1228 9.130	
4.100		55.0	22.0	1228 4.100	2498 4.100	9.200		84.0	40.0	1228 9.200	
4.200		55.0	22.0	1228 4.200	2498 4.200	9.300		84.0	40.0		2498 9.300
4.300		58.0	24.0	1228 4.300		9.500		84.0	40.0		2498 9.500
4.400		58.0	24.0	1228 4.400	2498 4.400	9.600		89.0	43.0	1228 9.600	
4.500		58.0	24.0	1228 4.500	2498 4.500	9.700		89.0	43.0	1228 9.700	
4.600		58.0	24.0	1228 4.600		9.800		89.0	43.0	1228 9.800	
4.700		58.0	24.0	1228 4.700		10.000		89.0	43.0	1228 10.000	2498 10.000
4.800		62.0	26.0	1228 4.800		10.200		89.0	43.0	1228 10.200	2498 10.200
4.900		62.0	26.0	1228 4.900		10.320	13/32	89.0	43.0	1228 10.320	
5.000		62.0	26.0	1228 5.000	2498 5.000	10.500		89.0	43.0	1228 10.500	2498 10.500
5.100		62.0	26.0	1228 5.100	2498 5.100	10.800		95.0	47.0	1228 10.800	2498 10.800
5.160	13/64	62.0	26.0	1228 5.160		11.000		95.0	47.0	1228 11.000	2498 11.000
5.200		62.0	26.0	1228 5.200	2498 5.200	11.500		95.0	47.0	1228 11.500	
5.300		62.0	26.0	1228 5.300	2498 5.300	11.510	29/64	95.0	47.0	1228 11.510	
5.400		66.0	28.0		2498 5.400	11.800		95.0	47.0	1228 11.800	2498 11.800
5.500		66.0	28.0	1228 5.500	2498 5.500	12.000		102.0	51.0	1228 12.000	2498 12.000
5.560	7/32	66.0	28.0	1228 5.560		12.300	31/64	102.0	51.0	1228 12.300	
5.600		66.0	28.0	1228 5.600		12.500		102.0	51.0	1228 12.500	2498 12.500
5.700		66.0	28.0	1228 5.700		12.700	1/2	102.0	51.0	1228 12.700	
5.800		66.0	28.0	1228 5.800		12.800		102.0	51.0	1228 12.800	
5.900		66.0	28.0	1228 5.900		13.000		102.0	51.0	1228 13.000	2498 13.000
6.000		66.0	28.0	1228 6.000	2498 6.000	13.500		107.0	54.0	1228 13.500	2498 13.500
6.100		70.0	31.0	1228 6.100		14.000		107.0	54.0	1228 14.000	2498 14.000



				Article no.						Article no.	
				1228	2498					1228	2498
d1 mm	inch	l1 mm	l2 mm	Order no.		d1 mm	inch	l1 mm	l2 mm	Order no.	
14.500		111.0	56.0	1228 14.500	2498 14.500	17.500		123.0	62.0	1228 17.500	
15.000		111.0	56.0	1228 15.000	2498 15.000	18.000		123.0	62.0	1228 18.000	
15.500		115.0	58.0	1228 15.500		18.500		127.0	64.0	1228 18.500	
16.000		115.0	58.0	1228 16.000	2498 16.000	19.000		127.0	64.0	1228 19.000	
16.500		119.0	60.0	1228 16.500		19.500		131.0	66.0	1228 19.500	
17.000		119.0	60.0	1228 17.000		20.000		131.0	66.0	1228 20.000	

HSS/HSCO drills



Stub drills

Article no. **572**



Cutting data page 449

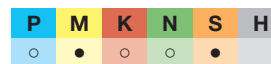
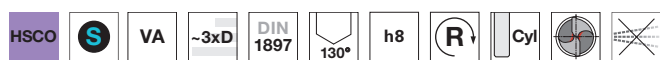

Web thinning $\geq \varnothing 2.400$ • optimised split point • Co-alloyed high speed steel • increased wear resistance

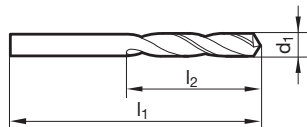

Article no. 572			Article no. 572				
d1 mm	l1 mm	l2 mm	Order no.	d1 mm	l1 mm	l2 mm	Order no.
1.000	26.0	6.0	572 1.000	6.200	70.0	31.0	572 6.200
1.100	28.0	7.0	572 1.100	6.300	70.0	31.0	572 6.300
1.200	30.0	8.0	572 1.200	6.400	70.0	31.0	572 6.400
1.300	30.0	8.0	572 1.300	6.500	70.0	31.0	572 6.500
1.400	32.0	9.0	572 1.400	6.600	70.0	31.0	572 6.600
1.500	32.0	9.0	572 1.500	6.700	70.0	31.0	572 6.700
1.600	34.0	10.0	572 1.600	6.800	74.0	34.0	572 6.800
1.700	34.0	10.0	572 1.700	6.900	74.0	34.0	572 6.900
1.800	36.0	11.0	572 1.800	7.000	74.0	34.0	572 7.000
1.900	36.0	11.0	572 1.900	7.100	74.0	34.0	572 7.100
2.000	38.0	12.0	572 2.000	7.200	74.0	34.0	572 7.200
2.100	38.0	12.0	572 2.100	7.300	74.0	34.0	572 7.300
2.200	40.0	13.0	572 2.200	7.400	74.0	34.0	572 7.400
2.300	40.0	13.0	572 2.300	7.450	74.0	34.0	572 7.450
2.400	43.0	14.0	572 2.400	7.500	74.0	34.0	572 7.500
2.500	43.0	14.0	572 2.500	7.600	79.0	37.0	572 7.600
2.600	43.0	14.0	572 2.600	7.700	79.0	37.0	572 7.700
2.700	46.0	16.0	572 2.700	7.800	79.0	37.0	572 7.800
2.800	46.0	16.0	572 2.800	7.900	79.0	37.0	572 7.900
2.900	46.0	16.0	572 2.900	8.000	79.0	37.0	572 8.000
3.000	46.0	16.0	572 3.000	8.100	79.0	37.0	572 8.100
3.100	49.0	18.0	572 3.100	8.200	79.0	37.0	572 8.200
3.200	49.0	18.0	572 3.200	8.300	79.0	37.0	572 8.300
3.300	49.0	18.0	572 3.300	8.400	79.0	37.0	572 8.400
3.400	52.0	20.0	572 3.400	8.500	79.0	37.0	572 8.500
3.500	52.0	20.0	572 3.500	8.600	84.0	40.0	572 8.600
3.600	52.0	20.0	572 3.600	8.700	84.0	40.0	572 8.700
3.700	52.0	20.0	572 3.700	8.800	84.0	40.0	572 8.800
3.800	55.0	22.0	572 3.800	8.900	84.0	40.0	572 8.900
3.900	55.0	22.0	572 3.900	9.000	84.0	40.0	572 9.000
4.000	55.0	22.0	572 4.000	9.100	84.0	40.0	572 9.100
4.100	55.0	22.0	572 4.100	9.200	84.0	40.0	572 9.200
4.200	55.0	22.0	572 4.200	9.250	84.0	40.0	572 9.250
4.300	58.0	24.0	572 4.300	9.300	84.0	40.0	572 9.300
4.400	58.0	24.0	572 4.400	9.400	84.0	40.0	572 9.400
4.500	58.0	24.0	572 4.500	9.500	84.0	40.0	572 9.500
4.600	58.0	24.0	572 4.600	9.600	89.0	43.0	572 9.600
4.650	58.0	24.0	572 4.650	9.700	89.0	43.0	572 9.700
4.700	58.0	24.0	572 4.700	9.800	89.0	43.0	572 9.800
4.800	62.0	26.0	572 4.800	9.900	89.0	43.0	572 9.900
4.900	62.0	26.0	572 4.900	10.000	89.0	43.0	572 10.000
5.000	62.0	26.0	572 5.000	10.200	89.0	43.0	572 10.200
5.100	62.0	26.0	572 5.100	10.500	89.0	43.0	572 10.500
5.200	62.0	26.0	572 5.200	11.000	95.0	47.0	572 11.000
5.300	62.0	26.0	572 5.300	11.200	95.0	47.0	572 11.200
5.400	66.0	28.0	572 5.400	11.500	95.0	47.0	572 11.500
5.500	66.0	28.0	572 5.500	11.800	95.0	47.0	572 11.800
5.550	66.0	28.0	572 5.550	12.000	102.0	51.0	572 12.000
5.600	66.0	28.0	572 5.600	12.500	102.0	51.0	572 12.500
5.700	66.0	28.0	572 5.700	13.000	102.0	51.0	572 13.000
5.800	66.0	28.0	572 5.800				
5.900	66.0	28.0	572 5.900				
6.000	66.0	28.0	572 6.000				
6.100	70.0	31.0	572 6.100				



Stub drills

Article no. **1259**



Cutting data page 442

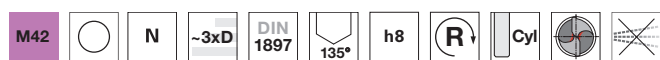

Web thinning $\geq \varnothing 1.000$ • relieved cone • high Co- and Mo-content • especially high wear resistance

HSS/HSCO drills

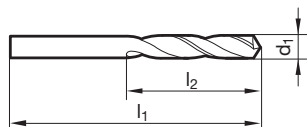

Article no. 1259				Article no. 1259					
d1 mm	inch	l1 mm	l2 mm	Order no.	d1 mm	inch	l1 mm	l2 mm	Order no.
1.000		26.0	6.0	1259 1.000	5.950	15/64	66.0	28.0	1259 5.950
1.100		28.0	7.0	1259 1.100	6.000		66.0	28.0	1259 6.000
1.200		30.0	8.0	1259 1.200	6.100		70.0	31.0	1259 6.100
1.300		30.0	8.0	1259 1.300	6.200		70.0	31.0	1259 6.200
1.400		32.0	9.0	1259 1.400	6.300		70.0	31.0	1259 6.300
1.500		32.0	9.0	1259 1.500	6.350	1/4	70.0	31.0	1259 6.350
1.600		34.0	10.0	1259 1.600	6.400		70.0	31.0	1259 6.400
1.700		34.0	10.0	1259 1.700	6.500		70.0	31.0	1259 6.500
1.800		36.0	11.0	1259 1.800	6.600		70.0	31.0	1259 6.600
1.900		36.0	11.0	1259 1.900	6.800		74.0	34.0	1259 6.800
2.000		38.0	12.0	1259 2.000	6.900		74.0	34.0	1259 6.900
2.100		38.0	12.0	1259 2.100	7.000		74.0	34.0	1259 7.000
2.200		40.0	13.0	1259 2.200	7.100		74.0	34.0	1259 7.100
2.300		40.0	13.0	1259 2.300	7.200		74.0	34.0	1259 7.200
2.380	3/32	43.0	14.0	1259 2.380	7.300		74.0	34.0	1259 7.300
2.400		43.0	14.0	1259 2.400	7.400		74.0	34.0	1259 7.400
2.500		43.0	14.0	1259 2.500	7.500		74.0	34.0	1259 7.500
2.600		43.0	14.0	1259 2.600	7.600		79.0	37.0	1259 7.600
2.700		46.0	16.0	1259 2.700	7.700		79.0	37.0	1259 7.700
2.780	7/64	46.0	16.0	1259 2.780	7.800		79.0	37.0	1259 7.800
2.800		46.0	16.0	1259 2.800	7.900		79.0	37.0	1259 7.900
2.900		46.0	16.0	1259 2.900	8.000		79.0	37.0	1259 8.000
3.000		46.0	16.0	1259 3.000	8.100		79.0	37.0	1259 8.100
3.100		49.0	18.0	1259 3.100	8.200		79.0	37.0	1259 8.200
3.170	1/8	49.0	18.0	1259 3.170	8.300		79.0	37.0	1259 8.300
3.200		49.0	18.0	1259 3.200	8.400		79.0	37.0	1259 8.400
3.300		49.0	18.0	1259 3.300	8.500		79.0	37.0	1259 8.500
3.400		52.0	20.0	1259 3.400	8.600		84.0	40.0	1259 8.600
3.500		52.0	20.0	1259 3.500	8.700		84.0	40.0	1259 8.700
3.600		52.0	20.0	1259 3.600	9.000		84.0	40.0	1259 9.000
3.700		52.0	20.0	1259 3.700	9.200		84.0	40.0	1259 9.200
3.800		55.0	22.0	1259 3.800	9.300		84.0	40.0	1259 9.300
3.900		55.0	22.0	1259 3.900	9.500		84.0	40.0	1259 9.500
3.970	5/32	55.0	22.0	1259 3.970	9.700		89.0	43.0	1259 9.700
4.000		55.0	22.0	1259 4.000	9.800		89.0	43.0	1259 9.800
4.100		55.0	22.0	1259 4.100	9.900		89.0	43.0	1259 9.900
4.200		55.0	22.0	1259 4.200	10.000		89.0	43.0	1259 10.000
4.300		58.0	24.0	1259 4.300	10.500		89.0	43.0	1259 10.500
4.400		58.0	24.0	1259 4.400	11.000		95.0	47.0	1259 11.000
4.500		58.0	24.0	1259 4.500	11.500		95.0	47.0	1259 11.500
4.600		58.0	24.0	1259 4.600	12.000		102.0	51.0	1259 12.000
4.700		58.0	24.0	1259 4.700	12.500		102.0	51.0	1259 12.500
4.760	3/16	62.0	26.0	1259 4.760	12.700	1/2	102.0	51.0	1259 12.700
4.800		62.0	26.0	1259 4.800	13.000		102.0	51.0	1259 13.000
4.900		62.0	26.0	1259 4.900	13.500		107.0	54.0	1259 13.500
5.000		62.0	26.0	1259 5.000	14.000		107.0	54.0	1259 14.000
5.100		62.0	26.0	1259 5.100	14.500		111.0	56.0	1259 14.500
5.200		62.0	26.0	1259 5.200	15.000		111.0	56.0	1259 15.000
5.300		62.0	26.0	1259 5.300					
5.400		66.0	28.0	1259 5.400					
5.500		66.0	28.0	1259 5.500					
5.560	7/32	66.0	28.0	1259 5.560					
5.600		66.0	28.0	1259 5.600					
5.800		66.0	28.0	1259 5.800					



HSS/HSCO drills with straight shank

HSS/HSCO drills

Stub drills

Article no. 515

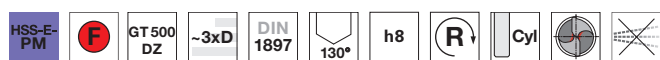

Web thinning $\geq \varnothing 1.000$ • relieved cone point geometry with special type B web thinning • PM-Co-alloyed high speed steel • especially high rigidity • especially high wear resistance

Cutting data page 450

P	M	K	N	S	H
●	○	●	○	○	○

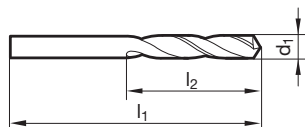

Article no. 515				Article no. 515					
d1 mm	inch	l1 mm	l2 mm	Order no.	d1 mm	inch	l1 mm	l2 mm	Order no.
1.000		26.0	6.0	515 1.000	3.730		52.0	20.0	515 3.730
1.020		26.0	6.0	515 1.020	3.800		55.0	22.0	515 3.800
1.040		26.0	6.0	515 1.040	3.860		55.0	22.0	515 3.860
1.070		28.0	7.0	515 1.070	3.900		55.0	22.0	515 3.900
1.090		28.0	7.0	515 1.090	3.910		55.0	22.0	515 3.910
1.100		28.0	7.0	515 1.100	3.970	5/32	55.0	22.0	515 3.970
1.180		28.0	7.0	515 1.180	3.990		55.0	22.0	515 3.990
1.190	3/64	30.0	8.0	515 1.190	4.000		55.0	22.0	515 4.000
1.200		30.0	8.0	515 1.200	4.040		55.0	22.0	515 4.040
1.300		30.0	8.0	515 1.300	4.090		55.0	22.0	515 4.090
1.320		30.0	8.0	515 1.320	4.100		55.0	22.0	515 4.100
1.400		32.0	9.0	515 1.400	4.200		55.0	22.0	515 4.200
1.500		32.0	9.0	515 1.500	4.220		55.0	22.0	515 4.220
1.510		34.0	10.0	515 1.510	4.300		58.0	24.0	515 4.300
1.590	1/16	34.0	10.0	515 1.590	4.370	11/64	58.0	24.0	515 4.370
1.600		34.0	10.0	515 1.600	4.390		58.0	24.0	515 4.390
1.610		34.0	10.0	515 1.610	4.400		58.0	24.0	515 4.400
1.700		34.0	10.0	515 1.700	4.500		58.0	24.0	515 4.500
1.780		36.0	11.0	515 1.780	4.570		58.0	24.0	515 4.570
1.800		36.0	11.0	515 1.800	4.600		58.0	24.0	515 4.600
1.850		36.0	11.0	515 1.850	4.620		58.0	24.0	515 4.620
1.900		36.0	11.0	515 1.900	4.650		58.0	24.0	515 4.650
1.930		38.0	12.0	515 1.930	4.700		58.0	24.0	515 4.700
1.980	5/64	38.0	12.0	515 1.980	4.760	3/16	62.0	26.0	515 4.760
1.990		38.0	12.0	515 1.990	4.800		62.0	26.0	515 4.800
2.000		38.0	12.0	515 2.000	4.850		62.0	26.0	515 4.850
2.060		38.0	12.0	515 2.060	4.900		62.0	26.0	515 4.900
2.080		38.0	12.0	515 2.080	4.920		62.0	26.0	515 4.920
2.100		38.0	12.0	515 2.100	4.980		62.0	26.0	515 4.980
2.180		40.0	13.0	515 2.180	5.000		62.0	26.0	515 5.000
2.200		40.0	13.0	515 2.200	5.060		62.0	26.0	515 5.060
2.260		40.0	13.0	515 2.260	5.100		62.0	26.0	515 5.100
2.300		40.0	13.0	515 2.300	5.110		62.0	26.0	515 5.110
2.370		43.0	14.0	515 2.370	5.160	13/64	62.0	26.0	515 5.160
2.380	3/32	43.0	14.0	515 2.380	5.180		62.0	26.0	515 5.180
2.400		43.0	14.0	515 2.400	5.200		62.0	26.0	515 5.200
2.440		43.0	14.0	515 2.440	5.220		62.0	26.0	515 5.220
2.490		43.0	14.0	515 2.490	5.300		62.0	26.0	515 5.300
2.500		43.0	14.0	515 2.500	5.310		66.0	28.0	515 5.310
2.530		43.0	14.0	515 2.530	5.400		66.0	28.0	515 5.400
2.580		43.0	14.0	515 2.580	5.410		66.0	28.0	515 5.410
2.600		43.0	14.0	515 2.600	5.500		66.0	28.0	515 5.500
2.640		43.0	14.0	515 2.640	5.560	7/32	66.0	28.0	515 5.560
2.700		46.0	16.0	515 2.700	5.600		66.0	28.0	515 5.600
2.710		46.0	16.0	515 2.710	5.610		66.0	28.0	515 5.610
2.780	7/64	46.0	16.0	515 2.780	5.700		66.0	28.0	515 5.700
2.790		46.0	16.0	515 2.790	5.790		66.0	28.0	515 5.790
2.800		46.0	16.0	515 2.800	5.800		66.0	28.0	515 5.800
2.820		46.0	16.0	515 2.820	5.900		66.0	28.0	515 5.900
2.870		46.0	16.0	515 2.870	5.940		66.0	28.0	515 5.940
2.900		46.0	16.0	515 2.900	5.950	15/64	66.0	28.0	515 5.950
2.950		46.0	16.0	515 2.950	6.000		66.0	28.0	515 6.000
3.000		46.0	16.0	515 3.000	6.040		70.0	31.0	515 6.040
3.050		49.0	18.0	515 3.050	6.100		70.0	31.0	515 6.100
3.100		49.0	18.0	515 3.100	6.150		70.0	31.0	515 6.150
3.170	1/8	49.0	18.0	515 3.170	6.200		70.0	31.0	515 6.200
3.200		49.0	18.0	515 3.200	6.250		70.0	31.0	515 6.250
3.260		49.0	18.0	515 3.260	6.300		70.0	31.0	515 6.300
3.300		49.0	18.0	515 3.300	6.350	1/4	70.0	31.0	515 6.350
3.400		52.0	20.0	515 3.400	6.400		70.0	31.0	515 6.400
3.450		52.0	20.0	515 3.450	6.500		70.0	31.0	515 6.500
3.500		52.0	20.0	515 3.500	6.530		70.0	31.0	515 6.530
3.570	9/64	52.0	20.0	515 3.570	6.600		70.0	31.0	515 6.600
3.600		52.0	20.0	515 3.600	6.630		70.0	31.0	515 6.630
3.660		52.0	20.0	515 3.660	6.700		70.0	31.0	515 6.700
3.700		52.0	20.0	515 3.700	6.750	17/64	74.0	34.0	515 6.750



Article no.				515	Article no.				515
d1 mm	inch	l1 mm	l2 mm	Order no.	d1 mm	inch	l1 mm	l2 mm	Order no.
6.800		74.0	34.0	515 6.800	9.350		84.0	40.0	515 9.350
6.900		74.0	34.0	515 6.900	9.400		84.0	40.0	515 9.400
7.000		74.0	34.0	515 7.000	9.500		84.0	40.0	515 9.500
7.030		74.0	34.0	515 7.030	9.520	3/8	89.0	43.0	515 9.520
7.100		74.0	34.0	515 7.100	9.580		89.0	43.0	515 9.580
7.140	9/32	74.0	34.0	515 7.140	9.600		89.0	43.0	515 9.600
7.200		74.0	34.0	515 7.200	9.700		89.0	43.0	515 9.700
7.300		74.0	34.0	515 7.300	9.800		89.0	43.0	515 9.800
7.370		74.0	34.0	515 7.370	9.900		89.0	43.0	515 9.900
7.400		74.0	34.0	515 7.400	9.920	25/64	89.0	43.0	515 9.920
7.490		74.0	34.0	515 7.490	10.000		89.0	43.0	515 10.000
7.500		74.0	34.0	515 7.500	10.080		89.0	43.0	515 10.080
7.540	19/64	79.0	37.0	515 7.540	10.200		89.0	43.0	515 10.200
7.600		79.0	37.0	515 7.600	10.260		89.0	43.0	515 10.260
7.670		79.0	37.0	515 7.670	10.320	13/32	89.0	43.0	515 10.320
7.700		79.0	37.0	515 7.700	10.490		89.0	43.0	515 10.490
7.800		79.0	37.0	515 7.800	10.500		89.0	43.0	515 10.500
7.900		79.0	37.0	515 7.900	10.720	27/64	95.0	47.0	515 10.720
7.940	5/16	79.0	37.0	515 7.940	11.000		95.0	47.0	515 11.000
8.000		79.0	37.0	515 8.000	11.110	7/16	95.0	47.0	515 11.110
8.030		79.0	37.0	515 8.030	11.500		95.0	47.0	515 11.500
8.100		79.0	37.0	515 8.100	11.510	29/64	95.0	47.0	515 11.510
8.200		79.0	37.0	515 8.200	11.800		95.0	47.0	515 11.800
8.300		79.0	37.0	515 8.300	11.910	15/32	102.0	51.0	515 11.910
8.330	21/64	79.0	37.0	515 8.330	12.000		102.0	51.0	515 12.000
8.400		79.0	37.0	515 8.400	12.300	31/64	102.0	51.0	515 12.300
8.430		79.0	37.0	515 8.430	12.500		102.0	51.0	515 12.500
8.500		79.0	37.0	515 8.500	12.700	1/2	102.0	51.0	515 12.700
8.600		84.0	40.0	515 8.600	13.000		102.0	51.0	515 13.000
8.610		84.0	40.0	515 8.610	13.100	33/64	102.0	51.0	515 13.100
8.700		84.0	40.0	515 8.700	13.490	17/32	107.0	54.0	515 13.490
8.730	11/32	84.0	40.0	515 8.730	13.500		107.0	54.0	515 13.500
8.800		84.0	40.0	515 8.800	14.000		107.0	54.0	515 14.000
8.840		84.0	40.0	515 8.840	14.290	9/16	111.0	56.0	515 14.290
8.900		84.0	40.0	515 8.900					
9.000		84.0	40.0	515 9.000					
9.090		84.0	40.0	515 9.090					
9.100		84.0	40.0	515 9.100					
9.130	23/64	84.0	40.0	515 9.130					
9.200		84.0	40.0	515 9.200					
9.300		84.0	40.0	515 9.300					
9.340		84.0	40.0	515 9.340					

HSS/HSCO drills



HSS/HSCO drills with straight shank

HSS/HSCO drills

Stub drills

Article no. **730**



Cutting data page 430-431

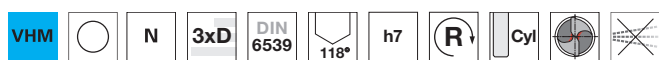

Web thinning $\geq \varnothing$ 2.060 • facet point grind • main cutting edge form straight

Stub drills

Article no. **2463**



Cutting data page 430-431



Web thinning $\geq \varnothing$ 2.060 • facet point grind • main cutting edge form straight

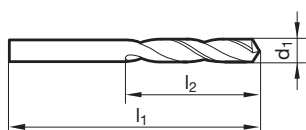

Article no. 730				Article no. 2463				Article no. 730				Article no. 2463							
d1 mm	inch	l1 mm	l2 mm	Order no.		d1 mm	inch	l1 mm	l2 mm	Order no.		d1 mm	inch	l1 mm	l2 mm	Order no.			
0.500		20.0	3.0	730	0.500	2.820		46.0	16.0	730	2.820	2463	2.820	46.0	16.0	730	2.870	2463	2.870
0.600		21.0	3.5	730	0.600	2.870		46.0	16.0	730	2.870	2463	2.870	46.0	16.0	730	2.900	2463	2.900
0.700		23.0	4.5	730	0.700	2.900		46.0	16.0	730	2.900	2463	2.900	46.0	16.0	730	2.950	2463	2.950
0.800		24.0	5.0	730	0.800	2.950		46.0	16.0	730	2.950	2463	2.950	46.0	16.0	730	3.000	2463	3.000
0.900		25.0	5.5	730	0.900	3.000		46.0	16.0	730	3.000	2463	3.000	46.0	16.0	730	3.050	2463	3.050
1.000		26.0	6.0	730	1.000	3.050		49.0	18.0	730	3.050	2463	3.050	49.0	18.0	730	3.100	2463	3.100
1.020		26.0	6.0	730	1.020	3.100		49.0	18.0	730	3.100	2463	3.100	49.0	18.0	730	3.170	2463	3.170
1.040		26.0	6.0	730	1.040	3.170	1/8	49.0	18.0	730	3.170	2463	3.170	49.0	18.0	730	3.200	2463	3.200
1.070		28.0	7.0	730	1.070	3.200		49.0	18.0	730	3.200	2463	3.200	49.0	18.0	730	3.260	2463	3.260
1.090		28.0	7.0	730	1.090	3.260		49.0	18.0	730	3.260	2463	3.260	49.0	18.0	730	3.300	2463	3.300
1.100		28.0	7.0	730	1.100	3.300		49.0	18.0	730	3.300	2463	3.300	49.0	18.0	730	3.400	2463	3.400
1.180		28.0	7.0	730	1.180	3.400		52.0	20.0	730	3.400	2463	3.400	52.0	20.0	730	3.450	2463	3.450
1.190	3/64	30.0	8.0	730	1.190	3.450		52.0	20.0	730	3.450	2463	3.450	52.0	20.0	730	3.500	2463	3.500
1.200		30.0	8.0	730	1.200	3.500		52.0	20.0	730	3.500	2463	3.500	52.0	20.0	730	3.570	2463	3.570
1.300		30.0	8.0	730	1.300	3.570	9/64	52.0	20.0	730	3.570	2463	3.570	52.0	20.0	730	3.600	2463	3.600
1.320		30.0	8.0	730	1.320	3.600		52.0	20.0	730	3.600	2463	3.600	52.0	20.0	730	3.660	2463	3.660
1.400		32.0	9.0	730	1.400	3.660		52.0	20.0	730	3.660	2463	3.660	52.0	20.0	730	3.700	2463	3.700
1.500		32.0	9.0	730	1.500	3.700		52.0	20.0	730	3.700	2463	3.700	52.0	20.0	730	3.730	2463	3.730
1.510		34.0	10.0	730	1.510	3.730		52.0	20.0	730	3.730	2463	3.730	52.0	20.0	730	3.800	2463	3.800
1.590	1/16	34.0	10.0	730	1.590	3.800		55.0	22.0	730	3.800	2463	3.800	55.0	22.0	730	3.860	2463	3.860
1.600		34.0	10.0	730	1.600	3.860		55.0	22.0	730	3.860	2463	3.860	55.0	22.0	730	3.900	2463	3.900
1.610		34.0	10.0	730	1.610	3.900		55.0	22.0	730	3.900	2463	3.900	55.0	22.0	730	3.910	2463	3.910
1.700		34.0	10.0	730	1.700	3.910		55.0	22.0	730	3.910	2463	3.910	55.0	22.0	730	3.970	2463	3.970
1.780		36.0	11.0	730	1.780	3.970	5/32	55.0	22.0	730	3.970	2463	3.970	55.0	22.0	730	4.000	2463	4.000
1.800		36.0	11.0	730	1.800	3.990		55.0	22.0	730	3.990	2463	3.990	55.0	22.0	730	4.040	2463	4.040
1.850		36.0	11.0	730	1.850	4.000		55.0	22.0	730	4.000	2463	4.000	55.0	22.0	730	4.090	2463	4.090
1.900		36.0	11.0	730	1.900	4.040		55.0	22.0	730	4.040	2463	4.040	55.0	22.0	730	4.100	2463	4.100
1.930		38.0	12.0	730	1.930	4.090		55.0	22.0	730	4.090	2463	4.090	55.0	22.0	730	4.200	2463	4.200
1.980	5/64	38.0	12.0	730	1.980	4.100		55.0	22.0	730	4.100	2463	4.100	55.0	22.0	730	4.220	2463	4.220
1.990		38.0	12.0	730	1.990	4.200		55.0	22.0	730	4.200	2463	4.200	55.0	22.0	730	4.300	2463	4.300
2.000		38.0	12.0	730	2.000	4.220		55.0	22.0	730	4.220	2463	4.220	55.0	22.0	730	4.370	2463	4.370
2.060		38.0	12.0	730	2.060	4.300		58.0	24.0	730	4.300	2463	4.300	58.0	24.0	730	4.390	2463	4.390
2.080		38.0	12.0	730	2.080	4.370	11/64	58.0	24.0	730	4.370	2463	4.370	58.0	24.0	730	4.400	2463	4.400
2.100		38.0	12.0	730	2.100	4.390		58.0	24.0	730	4.390	2463	4.390	58.0	24.0	730	4.500	2463	4.500
2.180		40.0	13.0	730	2.180	4.400		58.0	24.0	730	4.400	2463	4.400	58.0	24.0	730	4.570	2463	4.570
2.200		40.0	13.0	730	2.200	4.500		58.0	24.0	730	4.500	2463	4.500	58.0	24.0	730	4.600	2463	4.600
2.250		40.0	13.0	730	2.250	4.570		58.0	24.0	730	4.570	2463	4.570	58.0	24.0	730	4.620	2463	4.620
2.260		40.0	13.0	730	2.260	4.600		58.0	24.0	730	4.600	2463	4.600	58.0	24.0	730	4.700	2463	4.700
2.300		40.0	13.0	730	2.300	4.620		58.0	24.0	730	4.620	2463	4.620	58.0	24.0	730	4.760	2463	4.760
2.370		43.0	14.0	730	2.370	4.700		58.0	24.0	730	4.700	2463	4.700	58.0	24.0	730	4.800	2463	4.800
2.380	3/32	43.0	14.0	730	2.380	4.760	3/16	62.0	26.0	730	4.760	2463	4.760	62.0	26.0	730	4.850	2463	4.850
2.400		43.0	14.0	730	2.400	4.800		62.0	26.0	730	4.800	2463	4.800	62.0	26.0	730	4.900	2463	4.900
2.440		43.0	14.0	730	2.440	4.850		62.0	26.0	730	4.850	2463	4.850	62.0	26.0	730	4.920	2463	4.920
2.490		43.0	14.0	730	2.490	4.900		62.0	26.0	730	4.900	2463	4.900	62.0	26.0	730	4.980	2463	4.980
2.500		43.0	14.0	730	2.500	4.920		62.0	26.0	730	4.920	2463	4.920	62.0	26.0	730	5.000	2463	5.000
2.530		43.0	14.0	730	2.530	4.980		62.0	26.0	730	4.980	2463	4.980	62.0	26.0	730	5.060	2463	5.060
2.580		43.0	14.0	730	2.580	5.000		62.0	26.0	730	5.000	2463	5.000	62.0	26.0	730	5.100	2463	5.100
2.600		43.0	14.0	730	2.600	5.060		62.0	26.0	730	5.060	2463	5.060	62.0	26.0	730	5.110	2463	5.110
2.640		43.0	14.0	730	2.640	5.100		62.0	26.0	730	5.100	2463	5.100	62.0	26.0	730	5.160	2463	5.160
2.700		46.0	16.0	730	2.700	5.110		62.0	26.0	730	5.110	2463	5.110	62.0	26.0	730	5.180	2463	5.180
2.710		46.0	16.0	730	2.710	5.160	13/64	62.0	26.0	730	5.160	2463	5.160	62.0	26.0	730	5.200	2463	5.200
2.780	7/64	46.0	16.0	730	2.780	5.180		62.0	26.0	730	5.180	2463	5.180	62.0	26.0	730	5.220	2463	5.220
2.790		46.0	16.0	730	2.790	5.200		62.0	26.0	730	5.200	2463	5.200	62.0	26.0	730			
2.800		46.0	16.0	730	2.800	5.220		62.0	26.0	730	5.220	2463	5.220	62.0	26.0	730			



Article no.				730	2463	Article no.				730	2463
d1 mm	inch	l1 mm	l2 mm	Order no.		d1 mm	inch	l1 mm	l2 mm	Order no.	
5.300		62.0	26.0	730 5.300	2463 5.300	8.700		84.0	40.0	730 8.700	2463 8.700
5.310		66.0	28.0	730 5.310	2463 5.310	8.730	11/32	84.0	40.0	730 8.730	2463 8.730
5.400		66.0	28.0	730 5.400	2463 5.400	8.800		84.0	40.0	730 8.800	2463 8.800
5.410		66.0	28.0	730 5.410	2463 5.410	8.840		84.0	40.0	730 8.840	2463 8.840
5.500		66.0	28.0	730 5.500	2463 5.500	8.900		84.0	40.0	730 8.900	2463 8.900
5.560	7/32	66.0	28.0	730 5.560	2463 5.560	9.000		84.0	40.0	730 9.000	2463 9.000
5.600		66.0	28.0	730 5.600	2463 5.600	9.090		84.0	40.0	730 9.090	2463 9.090
5.610		66.0	28.0		2463 5.610	9.100		84.0	40.0	730 9.100	2463 9.100
5.620		66.0	28.0	730 5.620		9.130	23/64	84.0	40.0	730 9.130	2463 9.130
5.700		66.0	28.0	730 5.700	2463 5.700	9.200		84.0	40.0	730 9.200	2463 9.200
5.790		66.0	28.0	730 5.790	2463 5.790	9.300		84.0	40.0	730 9.300	2463 9.300
5.800		66.0	28.0	730 5.800	2463 5.800	9.340		84.0	40.0	730 9.340	2463 9.340
5.900		66.0	28.0	730 5.900	2463 5.900	9.400		84.0	40.0	730 9.400	2463 9.400
5.940		66.0	28.0	730 5.940	2463 5.940	9.500		84.0	40.0	730 9.500	2463 9.500
5.950	15/64	66.0	28.0	730 5.950	2463 5.950	9.520	3/8	89.0	43.0	730 9.520	2463 9.520
6.000		66.0	28.0	730 6.000	2463 6.000	9.580		89.0	43.0	730 9.580	2463 9.580
6.040		70.0	31.0	730 6.040	2463 6.040	9.600		89.0	43.0	730 9.600	2463 9.600
6.100		70.0	31.0	730 6.100	2463 6.100	9.700		89.0	43.0	730 9.700	2463 9.700
6.150		70.0	31.0	730 6.150	2463 6.150	9.800		89.0	43.0	730 9.800	2463 9.800
6.200		70.0	31.0	730 6.200	2463 6.200	9.900		89.0	43.0	730 9.900	2463 9.900
6.250		70.0	31.0	730 6.250	2463 6.250	9.920	25/64	89.0	43.0	730 9.920	2463 9.920
6.300		70.0	31.0	730 6.300	2463 6.300	10.000		89.0	43.0	730 10.000	2463 10.000
6.350	1/4	70.0	31.0	730 6.350	2463 6.350	10.080		89.0	43.0	730 10.080	2463 10.080
6.400		70.0	31.0	730 6.400	2463 6.400	10.200		89.0	43.0	730 10.200	2463 10.200
6.500		70.0	31.0	730 6.500	2463 6.500	10.260		89.0	43.0	730 10.260	2463 10.260
6.530		70.0	31.0	730 6.530	2463 6.530	10.300		89.0	43.0	730 10.300	2463 10.300
6.600		70.0	31.0	730 6.600	2463 6.600	10.320	13/32	89.0	43.0	730 10.320	2463 10.320
6.630		70.0	31.0	730 6.630	2463 6.630	10.490		89.0	43.0	730 10.490	2463 10.490
6.700		70.0	31.0	730 6.700	2463 6.700	10.500		89.0	43.0	730 10.500	2463 10.500
6.750	17/64	74.0	34.0	730 6.750	2463 6.750	10.720	27/64	95.0	47.0	730 10.720	2463 10.720
6.800		74.0	34.0	730 6.800	2463 6.800	11.000		95.0	47.0	730 11.000	2463 11.000
6.900		74.0	34.0	730 6.900	2463 6.900	11.110	7/16	95.0	47.0	730 11.110	2463 11.110
7.000		74.0	34.0	730 7.000	2463 7.000	11.500		95.0	47.0	730 11.500	2463 11.500
7.030		74.0	34.0	730 7.030	2463 7.030	11.510	29/64	95.0	47.0	730 11.510	2463 11.510
7.100		74.0	34.0	730 7.100	2463 7.100	11.700		95.0	47.0	730 11.700	
7.140	9/32	74.0	34.0	730 7.140	2463 7.140	11.910	15/32	102.0	51.0	730 11.910	2463 11.910
7.200		74.0	34.0	730 7.200	2463 7.200	12.000		102.0	51.0	730 12.000	2463 12.000
7.300		74.0	34.0	730 7.300	2463 7.300	12.300	31/64	102.0	51.0	730 12.300	2463 12.300
7.370		74.0	34.0	730 7.370	2463 7.370	12.500		102.0	51.0	730 12.500	
7.400		74.0	34.0	730 7.400	2463 7.400	12.700	1/2	102.0	51.0	730 12.700	2463 12.700
7.490		74.0	34.0	730 7.490		12.800		102.0	51.0	730 12.800	
7.500		74.0	34.0	730 7.500	2463 7.500	13.000		102.0	51.0	730 13.000	2463 13.000
7.540	19/64	79.0	37.0	730 7.540	2463 7.540	13.200		102.0	51.0	730 13.200	
7.600		79.0	37.0	730 7.600	2463 7.600	13.490	17/32	107.0	54.0	730 13.490	2463 13.490
7.670		79.0	37.0	730 7.670	2463 7.670	14.000		107.0	54.0	730 14.000	2463 14.000
7.700		79.0	37.0	730 7.700	2463 7.700	14.290	9/16	111.0	56.0	730 14.290	2463 14.290
7.800		79.0	37.0	730 7.800	2463 7.800	15.000		111.0	56.0	730 15.000	2463 15.000
7.900		79.0	37.0	730 7.900	2463 7.900	15.870	5/8	115.0	58.0	730 15.870	
7.940	5/16	79.0	37.0	730 7.940	2463 7.940	16.000		115.0	58.0	730 16.000	2463 16.000
8.000		79.0	37.0	730 8.000	2463 8.000						
8.030		79.0	37.0	730 8.030	2463 8.030						
8.100		79.0	37.0	730 8.100	2463 8.100						
8.200		79.0	37.0	730 8.200	2463 8.200						
8.300		79.0	37.0	730 8.300	2463 8.300						
8.330	21/64	79.0	37.0	730 8.330	2463 8.330						
8.400		79.0	37.0	730 8.400	2463 8.400						
8.430		79.0	37.0	730 8.430	2463 8.430						
8.500		79.0	37.0	730 8.500	2463 8.500						
8.600		84.0	40.0	730 8.600	2463 8.600						
8.610		84.0	40.0	730 8.610	2463 8.610						

HSS/HSCO drills



HSS/HSCO drills with straight shank

HSS/HSCO drills

Jobber drills

Article no. 205



Web thinning $\geq \varnothing 1.000$ • relieved cone

Cutting data page 442

P	M	K	N	S	H
•		•	○		

Jobber drills

Article no. 651

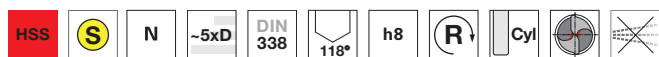

Web thinning $\geq \varnothing 1.000$ • relieved cone

Cutting data page 442

P	M	K	N	S	H
•		•	○		

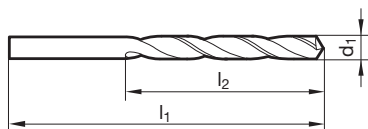

Article no.

205

651

Article no.

205

651

d1 mm	inch	l1 mm	l2 mm	Order no.		d1 mm	inch	l1 mm	l2 mm	Order no.	
0.200		19.0	2.5	205 0.200	651 0.200	0.740		28.0	9.0	205 0.740	651 0.740
0.210		19.0	2.5	205 0.210		0.750		28.0	9.0	205 0.750	651 0.750
0.220		19.0	2.5	205 0.220		0.760		30.0	10.0	205 0.760	651 0.760
0.230		19.0	2.5	205 0.230		0.770		30.0	10.0	205 0.770	651 0.770
0.240		19.0	2.5	205 0.240		0.780		30.0	10.0	205 0.780	651 0.780
0.250		19.0	3.0	205 0.250	651 0.250	0.790	1/32	30.0	10.0	205 0.790	651 0.790
0.260		19.0	3.0	205 0.260		0.800		30.0	10.0	205 0.800	651 0.800
0.270		19.0	3.0	205 0.270		0.810		30.0	10.0	205 0.810	651 0.810
0.280		19.0	3.0	205 0.280	651 0.280	0.820		30.0	10.0	205 0.820	651 0.820
0.290		19.0	3.0	205 0.290		0.830		30.0	10.0	205 0.830	651 0.830
0.300		19.0	3.0	205 0.300	651 0.300	0.840		30.0	10.0	205 0.840	651 0.840
0.310		19.0	4.0	205 0.310	651 0.310	0.850		30.0	10.0	205 0.850	651 0.850
0.320		19.0	4.0	205 0.320	651 0.320	0.860		32.0	11.0	205 0.860	651 0.860
0.330		19.0	4.0	205 0.330	651 0.330	0.870		32.0	11.0	205 0.870	651 0.870
0.340		19.0	4.0	205 0.340	651 0.340	0.880		32.0	11.0	205 0.880	651 0.880
0.350		19.0	4.0	205 0.350		0.890		32.0	11.0	205 0.890	651 0.890
0.360		19.0	4.0	205 0.360	651 0.360	0.900		32.0	11.0	205 0.900	651 0.900
0.370		19.0	4.0	205 0.370	651 0.370	0.910		32.0	11.0	205 0.910	651 0.910
0.380		19.0	4.0	205 0.380	651 0.380	0.920		32.0	11.0	205 0.920	651 0.920
0.390		20.0	5.0	205 0.390	651 0.390	0.930		32.0	11.0	205 0.930	651 0.930
0.400	1/64	20.0	5.0	205 0.400	651 0.400	0.940		32.0	11.0	205 0.940	651 0.940
0.410		20.0	5.0	205 0.410	651 0.410	0.950		32.0	11.0	205 0.950	651 0.950
0.420		20.0	5.0	205 0.420	651 0.420	0.960		34.0	12.0	205 0.960	651 0.960
0.430		20.0	5.0	205 0.430	651 0.430	0.970		34.0	12.0	205 0.970	651 0.970
0.440		20.0	5.0	205 0.440	651 0.440	0.980		34.0	12.0	205 0.980	651 0.980
0.450		20.0	5.0	205 0.450	651 0.450	0.990		34.0	12.0	205 0.990	651 0.990
0.460		20.0	5.0	205 0.460	651 0.460	1.000		34.0	12.0	205 1.000	651 1.000
0.470		20.0	5.0	205 0.470	651 0.470	1.010		34.0	12.0	205 1.010	651 1.010
0.480		20.0	5.0	205 0.480	651 0.480	1.020		34.0	12.0	205 1.020	651 1.020
0.490		22.0	6.0	205 0.490	651 0.490	1.030		34.0	12.0	205 1.030	651 1.030
0.500		22.0	6.0	205 0.500	651 0.500	1.040		34.0	12.0	205 1.040	651 1.040
0.510		22.0	6.0	205 0.510	651 0.510	1.050		34.0	12.0	205 1.050	651 1.050
0.520		22.0	6.0	205 0.520	651 0.520	1.060		34.0	12.0	205 1.060	651 1.060
0.530		22.0	6.0	205 0.530	651 0.530	1.070		36.0	14.0	205 1.070	651 1.070
0.540		24.0	7.0	205 0.540	651 0.540	1.080		36.0	14.0	205 1.080	651 1.080
0.550		24.0	7.0	205 0.550	651 0.550	1.090		36.0	14.0	205 1.090	651 1.090
0.560		24.0	7.0	205 0.560	651 0.560	1.100		36.0	14.0	205 1.100	651 1.100
0.570		24.0	7.0	205 0.570	651 0.570	1.110		36.0	14.0	205 1.110	651 1.110
0.580		24.0	7.0	205 0.580	651 0.580	1.120		36.0	14.0	205 1.120	651 1.120
0.590		24.0	7.0	205 0.590	651 0.590	1.130		36.0	14.0	205 1.130	651 1.130
0.600		24.0	7.0	205 0.600	651 0.600	1.140		36.0	14.0	205 1.140	651 1.140
0.610		26.0	8.0	205 0.610	651 0.610	1.150		36.0	14.0	205 1.150	651 1.150
0.620		26.0	8.0	205 0.620	651 0.620	1.160		36.0	14.0	205 1.160	651 1.160
0.630		26.0	8.0	205 0.630	651 0.630	1.170		36.0	14.0	205 1.170	651 1.170
0.640		26.0	8.0	205 0.640	651 0.640	1.180		36.0	14.0	205 1.180	651 1.180
0.650		26.0	8.0	205 0.650	651 0.650	1.190	3/64	38.0	16.0	205 1.190	651 1.190
0.660		26.0	8.0	205 0.660	651 0.660	1.200		38.0	16.0	205 1.200	651 1.200
0.670		26.0	8.0	205 0.670		1.210		38.0	16.0	205 1.210	651 1.210
0.680		28.0	9.0	205 0.680	651 0.680	1.220		38.0	16.0	205 1.220	651 1.220
0.690		28.0	9.0	205 0.690	651 0.690	1.230		38.0	16.0	205 1.230	651 1.230
0.700		28.0	9.0	205 0.700	651 0.700	1.240		38.0	16.0	205 1.240	651 1.240
0.710		28.0	9.0	205 0.710	651 0.710	1.250		38.0	16.0	205 1.250	651 1.250
0.720		28.0	9.0	205 0.720	651 0.720	1.260		38.0	16.0	205 1.260	651 1.260
0.730		28.0	9.0	205 0.730		1.270		38.0	16.0	205 1.270	651 1.270



Article no.				205	651	Article no.				205	651
d1 mm	inch	l1 mm	l2 mm	Order no.		d1 mm	inch	l1 mm	l2 mm	Order no.	
1.280		38.0	16.0	205 1.280	651 1.280	2.120		49.0	24.0	205 2.120	
1.290		38.0	16.0	205 1.290		2.130		53.0	27.0	205 2.130	
1.300		38.0	16.0	205 1.300	651 1.300	2.140		53.0	27.0	205 2.140	
1.310		38.0	16.0	205 1.310	651 1.310	2.150		53.0	27.0	205 2.150	651 2.150
1.320		38.0	16.0	205 1.320	651 1.320	2.170		53.0	27.0	205 2.170	
1.330		40.0	18.0	205 1.330	651 1.330	2.180		53.0	27.0	205 2.180	651 2.180
1.340		40.0	18.0	205 1.340	651 1.340	2.200		53.0	27.0	205 2.200	651 2.200
1.350		40.0	18.0	205 1.350	651 1.350	2.210		53.0	27.0	205 2.210	
1.360		40.0	18.0	205 1.360		2.220		53.0	27.0	205 2.220	
1.370		40.0	18.0	205 1.370		2.230		53.0	27.0	205 2.230	
1.380		40.0	18.0	205 1.380		2.240		53.0	27.0	205 2.240	
1.390		40.0	18.0	205 1.390		2.250		53.0	27.0	205 2.250	651 2.250
1.400		40.0	18.0	205 1.400	651 1.400	2.260		53.0	27.0	205 2.260	651 2.260
1.410		40.0	18.0	205 1.410		2.270		53.0	27.0	205 2.270	
1.420		40.0	18.0	205 1.420	651 1.420	2.280		53.0	27.0	205 2.280	651 2.280
1.430		40.0	18.0	205 1.430	651 1.430	2.290		53.0	27.0	205 2.290	
1.440		40.0	18.0	205 1.440		2.300		53.0	27.0	205 2.300	651 2.300
1.450		40.0	18.0	205 1.450	651 1.450	2.320		53.0	27.0	205 2.320	
1.460		40.0	18.0	205 1.460	651 1.460	2.330		53.0	27.0	205 2.330	
1.470		40.0	18.0	205 1.470	651 1.470	2.340		53.0	27.0	205 2.340	
1.480		40.0	18.0	205 1.480	651 1.480	2.350		53.0	27.0	205 2.350	651 2.350
1.490		40.0	18.0	205 1.490	651 1.490	2.360		53.0	27.0	205 2.360	
1.500		40.0	18.0	205 1.500	651 1.500	2.370		57.0	30.0	205 2.370	651 2.370
1.510		43.0	20.0	205 1.510	651 1.510	2.380	3/32	57.0	30.0	205 2.380	651 2.380
1.520		43.0	20.0	205 1.520	651 1.520	2.390		57.0	30.0	205 2.390	
1.530		43.0	20.0	205 1.530	651 1.530	2.400		57.0	30.0	205 2.400	651 2.400
1.540		43.0	20.0	205 1.540	651 1.540	2.420		57.0	30.0	205 2.420	
1.550		43.0	20.0	205 1.550	651 1.550	2.430		57.0	30.0	205 2.430	
1.560		43.0	20.0	205 1.560	651 1.560	2.440		57.0	30.0	205 2.440	651 2.440
1.570		43.0	20.0	205 1.570	651 1.570	2.450		57.0	30.0	205 2.450	651 2.450
1.580		43.0	20.0	205 1.580		2.460		57.0	30.0	205 2.460	
1.590	1/16	43.0	20.0	205 1.590	651 1.590	2.470		57.0	30.0	205 2.470	
1.600		43.0	20.0	205 1.600	651 1.600	2.480		57.0	30.0	205 2.480	
1.610		43.0	20.0	205 1.610	651 1.610	2.490		57.0	30.0	205 2.490	651 2.490
1.620		43.0	20.0	205 1.620	651 1.620	2.500		57.0	30.0	205 2.500	651 2.500
1.630		43.0	20.0	205 1.630		2.510		57.0	30.0	205 2.510	
1.640		43.0	20.0	205 1.640	651 1.640	2.520		57.0	30.0	205 2.520	651 2.520
1.650		43.0	20.0	205 1.650	651 1.650	2.530		57.0	30.0	205 2.530	651 2.530
1.660		43.0	20.0	205 1.660	651 1.660	2.540		57.0	30.0	205 2.540	
1.670		43.0	20.0	205 1.670		2.550		57.0	30.0	205 2.550	651 2.550
1.680		43.0	20.0	205 1.680	651 1.680	2.570		57.0	30.0	205 2.570	
1.690		43.0	20.0	205 1.690		2.580		57.0	30.0	205 2.580	651 2.580
1.700		43.0	20.0	205 1.700	651 1.700	2.600		57.0	30.0	205 2.600	651 2.600
1.710		46.0	22.0	205 1.710	651 1.710	2.610		57.0	30.0	205 2.610	
1.720		46.0	22.0	205 1.720	651 1.720	2.620		57.0	30.0	205 2.620	
1.730		46.0	22.0	205 1.730	651 1.730	2.630		57.0	30.0	205 2.630	
1.740		46.0	22.0	205 1.740		2.640		57.0	30.0	205 2.640	651 2.640
1.750		46.0	22.0	205 1.750	651 1.750	2.650		57.0	30.0	205 2.650	651 2.650
1.760		46.0	22.0	205 1.760		2.660		61.0	33.0	205 2.660	
1.770		46.0	22.0	205 1.770	651 1.770	2.670		61.0	33.0	205 2.670	
1.780		46.0	22.0	205 1.780	651 1.780	2.680		61.0	33.0	205 2.680	
1.790		46.0	22.0	205 1.790		2.700		61.0	33.0	205 2.700	651 2.700
1.800		46.0	22.0	205 1.800	651 1.800	2.710		61.0	33.0	205 2.710	651 2.710
1.810		46.0	22.0	205 1.810		2.720		61.0	33.0	205 2.720	651 2.720
1.820		46.0	22.0	205 1.820	651 1.820	2.730		61.0	33.0	205 2.730	
1.830		46.0	22.0	205 1.830	651 1.830	2.750		61.0	33.0	205 2.750	651 2.750
1.840		46.0	22.0	205 1.840	651 1.840	2.760		61.0	33.0	205 2.760	
1.850		46.0	22.0	205 1.850	651 1.850	2.780	7/64	61.0	33.0	205 2.780	651 2.780
1.860		46.0	22.0	205 1.860		2.790		61.0	33.0	205 2.790	651 2.790
1.870		46.0	22.0	205 1.870	651 1.870	2.800		61.0	33.0	205 2.800	651 2.800
1.880		46.0	22.0	205 1.880		2.820		61.0	33.0	205 2.820	651 2.820
1.890		46.0	22.0	205 1.890	651 1.890	2.830		61.0	33.0	205 2.830	
1.900		46.0	22.0	205 1.900	651 1.900	2.850		61.0	33.0	205 2.850	651 2.850
1.910		49.0	24.0	205 1.910	651 1.910	2.870		61.0	33.0	205 2.870	651 2.870
1.920		49.0	24.0	205 1.920		2.880		61.0	33.0	205 2.880	
1.930		49.0	24.0	205 1.930	651 1.930	2.900		61.0	33.0	205 2.900	651 2.900
1.940		49.0	24.0	205 1.940		2.910		61.0	33.0	205 2.910	
1.950		49.0	24.0	205 1.950	651 1.950	2.920		61.0	33.0	205 2.920	
1.960		49.0	24.0	205 1.960	651 1.960	2.930		61.0	33.0	205 2.930	
1.970		49.0	24.0	205 1.970	651 1.970	2.940		61.0	33.0	205 2.940	
1.980	5/64	49.0	24.0	205 1.980	651 1.980	2.950		61.0	33.0	205 2.950	651 2.950
1.990		49.0	24.0	205 1.990	651 1.990	2.960		61.0	33.0	205 2.960	
2.000		49.0	24.0	205 2.000	651 2.000	2.970		61.0	33.0	205 2.970	
2.010		49.0	24.0	205 2.010		2.980		61.0	33.0	205 2.980	
2.020		49.0	24.0	205 2.020	651 2.020	2.990		61.0	33.0	205 2.990	
2.030		49.0	24.0	205 2.030	651 2.030	3.000		61.0	33.0	205 3.000	651 3.000
2.040		49.0	24.0	205 2.040	651 2.040	3.010		65.0	36.0	205 3.010	
2.050		49.0	24.0	205 2.050	651 2.050	3.020		65.0	36.0	205 3.020	651 3.020
2.060		49.0	24.0	205 2.060	651 2.060	3.030		65.0	36.0	205 3.030	651 3.030
2.070		49.0	24.0	205 2.070		3.040		65.0	36.0	205 3.040	
2.080		49.0	24.0	205 2.080	651 2.080	3.050		65.0	36.0	205 3.050	651 3.050
2.090		49.0	24.0	205 2.090		3.060		65.0	36.0	205 3.060	
2.100		49.0	24.0	205 2.100	651 2.100	3.070		65.0	36.0	205 3.070	
2.110		49.0	24.0	205 2.110		3.080		65.0	36.0	205 3.080	



HSS/HSCO drills with straight shank

HSS/HSCO drills

Article no.				205	651	Article no.				205	651
d1 mm	inch	l1 mm	l2 mm	Order no.		d1 mm	inch	l1 mm	l2 mm	Order no.	
3.100		65.0	36.0	205 3.100	651 3.100	4.700		80.0	47.0	205 4.700	651 4.700
3.120		65.0	36.0	205 3.120		4.730		80.0	47.0	205 4.730	
3.130		65.0	36.0	205 3.130		4.750		80.0	47.0	205 4.750	651 4.750
3.150		65.0	36.0	205 3.150	651 3.150	4.760	3/16	86.0	52.0	205 4.760	651 4.760
3.160		65.0	36.0	205 3.160		4.770		86.0	52.0	205 4.770	
3.170	1/8	65.0	36.0	205 3.170	651 3.170	4.800		86.0	52.0	205 4.800	651 4.800
3.180		65.0	36.0	205 3.180		4.830		86.0	52.0	205 4.830	
3.200		65.0	36.0	205 3.200	651 3.200	4.850		86.0	52.0	205 4.850	651 4.850
3.220		65.0	36.0	205 3.220		4.860		86.0	52.0	205 4.860	
3.230		65.0	36.0	205 3.230		4.900		86.0	52.0	205 4.900	651 4.900
3.250		65.0	36.0	205 3.250	651 3.250	4.920		86.0	52.0	205 4.920	651 4.920
3.260		65.0	36.0	205 3.260	651 3.260	4.930		86.0	52.0	205 4.930	
3.300		65.0	36.0	205 3.300	651 3.300	4.950		86.0	52.0	205 4.950	651 4.950
3.320		65.0	36.0	205 3.320		4.970		86.0	52.0	205 4.970	
3.330		65.0	36.0	205 3.330	651 3.330	4.980		86.0	52.0	205 4.980	651 4.980
3.350		65.0	36.0	205 3.350	651 3.350	5.000		86.0	52.0	205 5.000	651 5.000
3.370		70.0	39.0	205 3.370		5.020		86.0	52.0	205 5.020	651 5.020
3.380		70.0	39.0	205 3.380		5.030		86.0	52.0	205 5.030	
3.400		70.0	39.0	205 3.400	651 3.400	5.050		86.0	52.0	205 5.050	651 5.050
3.420		70.0	39.0	205 3.420		5.060		86.0	52.0	205 5.060	651 5.060
3.450		70.0	39.0	205 3.450	651 3.450	5.080		86.0	52.0	205 5.080	
3.500		70.0	39.0	205 3.500	651 3.500	5.100		86.0	52.0	205 5.100	651 5.100
3.520		70.0	39.0	205 3.520		5.110		86.0	52.0	205 5.110	651 5.110
3.550		70.0	39.0	205 3.550	651 3.550	5.120		86.0	52.0	205 5.120	
3.570	9/64	70.0	39.0	205 3.570	651 3.570	5.150		86.0	52.0	205 5.150	651 5.150
3.600		70.0	39.0	205 3.600	651 3.600	5.160	13/64	86.0	52.0	205 5.160	651 5.160
3.610		70.0	39.0	205 3.610		5.180		86.0	52.0	205 5.180	651 5.180
3.620		70.0	39.0	205 3.620		5.200		86.0	52.0	205 5.200	651 5.200
3.650		70.0	39.0	205 3.650	651 3.650	5.220		86.0	52.0	205 5.220	651 5.220
3.660		70.0	39.0	205 3.660	651 3.660	5.250		86.0	52.0	205 5.250	651 5.250
3.680		70.0	39.0	205 3.680		5.300		86.0	52.0	205 5.300	651 5.300
3.700		70.0	39.0	205 3.700	651 3.700	5.310		93.0	57.0	205 5.310	651 5.310
3.725		70.0	39.0	205 3.725		5.350		93.0	57.0	205 5.350	651 5.350
3.730		70.0	39.0	205 3.730	651 3.730	5.400		93.0	57.0	205 5.400	651 5.400
3.750		70.0	39.0	205 3.750	651 3.750	5.410		93.0	57.0	205 5.410	651 5.410
3.800		75.0	43.0	205 3.800	651 3.800	5.420		93.0	57.0	205 5.420	
3.820		75.0	43.0	205 3.820		5.450		93.0	57.0	205 5.450	651 5.450
3.830		75.0	43.0	205 3.830		5.460		93.0	57.0	205 5.460	
3.850		75.0	43.0	205 3.850	651 3.850	5.500		93.0	57.0	205 5.500	651 5.500
3.860		75.0	43.0	205 3.860	651 3.860	5.550		93.0	57.0	205 5.550	651 5.550
3.870		75.0	43.0	205 3.870		5.560	7/32	93.0	57.0	205 5.560	651 5.560
3.900		75.0	43.0	205 3.900	651 3.900	5.600		93.0	57.0	205 5.600	651 5.600
3.910		75.0	43.0	205 3.910	651 3.910	5.610		93.0	57.0	205 5.610	651 5.610
3.920		75.0	43.0	205 3.920		5.630		93.0	57.0	205 5.630	
3.930		75.0	43.0	205 3.930		5.650		93.0	57.0	205 5.650	651 5.650
3.940		75.0	43.0	205 3.940		5.700		93.0	57.0	205 5.700	651 5.700
3.950		75.0	43.0	205 3.950	651 3.950	5.750		93.0	57.0	205 5.750	651 5.750
3.970	5/32	75.0	43.0	205 3.970	651 3.970	5.790		93.0	57.0	205 5.790	651 5.790
3.980		75.0	43.0	205 3.980		5.800		93.0	57.0	205 5.800	651 5.800
3.990		75.0	43.0	205 3.990	651 3.990	5.850		93.0	57.0	205 5.850	651 5.850
4.000		75.0	43.0	205 4.000	651 4.000	5.900		93.0	57.0	205 5.900	651 5.900
4.010		75.0	43.0	205 4.010		5.930		93.0	57.0	205 5.930	
4.020		75.0	43.0	205 4.020		5.940		93.0	57.0	205 5.940	651 5.940
4.030		75.0	43.0	205 4.030		5.950	15/64	93.0	57.0	205 5.950	651 5.950
4.040		75.0	43.0	205 4.040	651 4.040	5.960		93.0	57.0	205 5.960	
4.050		75.0	43.0	205 4.050	651 4.050	5.970		93.0	57.0	205 5.970	
4.060		75.0	43.0	205 4.060		5.980		93.0	57.0	205 5.980	
4.070		75.0	43.0	205 4.070	651 4.070	5.990		93.0	57.0	205 5.990	
4.080		75.0	43.0	205 4.080		6.000		93.0	57.0	205 6.000	651 6.000
4.090		75.0	43.0	205 4.090	651 4.090	6.030		101.0	63.0	205 6.030	
4.100		75.0	43.0	205 4.100	651 4.100	6.040		101.0	63.0	205 6.040	651 6.040
4.120		75.0	43.0	205 4.120		6.050		101.0	63.0	205 6.050	651 6.050
4.150		75.0	43.0	205 4.150	651 4.150	6.100		101.0	63.0	205 6.100	651 6.100
4.200		75.0	43.0	205 4.200	651 4.200	6.150		101.0	63.0	205 6.150	651 6.150
4.220		75.0	43.0	205 4.220	651 4.220	6.170		101.0	63.0	205 6.170	
4.250		75.0	43.0	205 4.250	651 4.250	6.200		101.0	63.0	205 6.200	651 6.200
4.270		80.0	47.0	205 4.270		6.210		101.0	63.0	205 6.210	
4.300		80.0	47.0	205 4.300	651 4.300	6.220		101.0	63.0	205 6.220	
4.320		80.0	47.0	205 4.320		6.250		101.0	63.0	205 6.250	651 6.250
4.350		80.0	47.0	205 4.350	651 4.350	6.300		101.0	63.0	205 6.300	651 6.300
4.370	11/64	80.0	47.0	205 4.370	651 4.370	6.350	1/4	101.0	63.0	205 6.350	651 6.350
4.380		80.0	47.0	205 4.380		6.380		101.0	63.0	205 6.380	
4.390		80.0	47.0	205 4.390	651 4.390	6.400		101.0	63.0	205 6.400	651 6.400
4.400		80.0	47.0	205 4.400	651 4.400	6.450		101.0	63.0	205 6.450	
4.420		80.0	47.0	205 4.420		6.500		101.0	63.0	205 6.500	651 6.500
4.450		80.0	47.0	205 4.450	651 4.450	6.530		101.0	63.0	205 6.530	651 6.530
4.500		80.0	47.0	205 4.500	651 4.500	6.550		101.0	63.0	205 6.550	651 6.550
4.520		80.0	47.0	205 4.520		6.600		101.0	63.0	205 6.600	651 6.600
4.530		80.0	47.0	205 4.530		6.630		101.0	63.0	205 6.630	651 6.630
4.550		80.0	47.0	205 4.550	651 4.550	6.650		101.0	63.0	205 6.650	651 6.650
4.570		80.0	47.0	205 4.570	651 4.570	6.700		101.0	63.0	205 6.700	651 6.700
4.600		80.0	47.0	205 4.600	651 4.600	6.750	17/64	109.0	69.0	205 6.750	651 6.750
4.620		80.0	47.0	205 4.620	651 4.620	6.760		109.0	69.0	205 6.760	
4.650		80.0	47.0	205 4.650	651 4.650	6.800		109.0	69.0	205 6.800	651 6.800



Article no.				205	651	Article no.				205	651
d1 mm	inch	l1 mm	l2 mm	Order no.		d1 mm	inch	l1 mm	l2 mm	Order no.	
6.850		109.0	69.0	205 6.850	651 6.850	9.700		133.0	87.0	205 9.700	651 9.700
6.900		109.0	69.0	205 6.900	651 6.900	9.750		133.0	87.0	205 9.750	651 9.750
6.910		109.0	69.0	205 6.910		9.800		133.0	87.0	205 9.800	651 9.800
6.950		109.0	69.0	205 6.950		9.850		133.0	87.0	205 9.850	
7.000		109.0	69.0	205 7.000	651 7.000	9.900		133.0	87.0	205 9.900	651 9.900
7.020		109.0	69.0		651 7.020	9.920	25/64	133.0	87.0	205 9.920	651 9.920
7.030		109.0	69.0	205 7.030	651 7.030	9.950		133.0	87.0	205 9.950	
7.040		109.0	69.0	205 7.040		10.000		133.0	87.0	205 10.000	651 10.000
7.050		109.0	69.0	205 7.050	651 7.050	10.040		133.0	87.0	205 10.040	
7.070		109.0	69.0	205 7.070		10.050		133.0	87.0	205 10.050	
7.100		109.0	69.0	205 7.100	651 7.100	10.060		133.0	87.0		651 10.060
7.130		109.0	69.0	205 7.130		10.080		133.0	87.0	205 10.080	651 10.080
7.140	9/32	109.0	69.0	205 7.140	651 7.140	10.100		133.0	87.0	205 10.100	651 10.100
7.150		109.0	69.0	205 7.150		10.150		133.0	87.0	205 10.150	
7.200		109.0	69.0	205 7.200	651 7.200	10.200		133.0	87.0	205 10.200	651 10.200
7.250		109.0	69.0	205 7.250	651 7.250	10.250		133.0	87.0	205 10.250	651 10.250
7.300		109.0	69.0	205 7.300	651 7.300	10.260		133.0	87.0	205 10.260	651 10.260
7.320		109.0	69.0	205 7.320		10.300		133.0	87.0	205 10.300	651 10.300
7.350		109.0	69.0	205 7.350		10.320	13/32	133.0	87.0	205 10.320	651 10.320
7.370		109.0	69.0	205 7.370	651 7.370	10.350		133.0	87.0	205 10.350	
7.400		109.0	69.0	205 7.400	651 7.400	10.400		133.0	87.0	205 10.400	651 10.400
7.450		109.0	69.0	205 7.450	651 7.450	10.450		133.0	87.0	205 10.450	
7.490		109.0	69.0	205 7.490	651 7.490	10.490		133.0	87.0	205 10.490	651 10.490
7.500		109.0	69.0	205 7.500	651 7.500	10.500		133.0	87.0	205 10.500	651 10.500
7.540	19/64	117.0	75.0	205 7.540	651 7.540	10.550		133.0	87.0	205 10.550	651 10.550
7.550		117.0	75.0	205 7.550		10.600		133.0	87.0	205 10.600	651 10.600
7.600		117.0	75.0	205 7.600	651 7.600	10.700		142.0	94.0	205 10.700	651 10.700
7.650		117.0	75.0	205 7.650		10.720	27/64	142.0	94.0	205 10.720	651 10.720
7.670		117.0	75.0	205 7.670	651 7.670	10.750		142.0	94.0	205 10.750	651 10.750
7.700		117.0	75.0	205 7.700	651 7.700	10.800		142.0	94.0	205 10.800	651 10.800
7.750		117.0	75.0	205 7.750	651 7.750	10.900		142.0	94.0	205 10.900	651 10.900
7.800		117.0	75.0	205 7.800	651 7.800	11.000		142.0	94.0	205 11.000	651 11.000
7.850		117.0	75.0	205 7.850		11.050		142.0	94.0	205 11.050	
7.900		117.0	75.0	205 7.900	651 7.900	11.100		142.0	94.0	205 11.100	651 11.100
7.940	5/16	117.0	75.0	205 7.940	651 7.940	11.110	7/16	142.0	94.0	205 11.110	651 11.110
7.950		117.0	75.0	205 7.950		11.150		142.0	94.0	205 11.150	
7.980		117.0	75.0	205 7.980		11.200		142.0	94.0	205 11.200	651 11.200
8.000		117.0	75.0	205 8.000	651 8.000	11.250		142.0	94.0	205 11.250	651 11.250
8.030		117.0	75.0	205 8.030	651 8.030	11.300		142.0	94.0	205 11.300	651 11.300
8.050		117.0	75.0	205 8.050	651 8.050	11.350		142.0	94.0	205 11.350	
8.100		117.0	75.0	205 8.100	651 8.100	11.400		142.0	94.0	205 11.400	651 11.400
8.130		117.0	75.0	205 8.130		11.500		142.0	94.0	205 11.500	651 11.500
8.150		117.0	75.0	205 8.150	651 8.150	11.510	29/64	142.0	94.0	205 11.510	651 11.510
8.200		117.0	75.0	205 8.200	651 8.200	11.600		142.0	94.0	205 11.600	651 11.600
8.250		117.0	75.0	205 8.250	651 8.250	11.650		142.0	94.0		651 11.650
8.300		117.0	75.0	205 8.300	651 8.300	11.700		142.0	94.0	205 11.700	651 11.700
8.330	21/64	117.0	75.0	205 8.330	651 8.330	11.750		142.0	94.0	205 11.750	651 11.750
8.350		117.0	75.0	205 8.350		11.800		142.0	94.0	205 11.800	651 11.800
8.400		117.0	75.0	205 8.400	651 8.400	11.900		151.0	101.0	205 11.900	651 11.900
8.430		117.0	75.0	205 8.430	651 8.430	11.910	15/32	151.0	101.0	205 11.910	651 11.910
8.450		117.0	75.0	205 8.450	651 8.450	12.000		151.0	101.0	205 12.000	651 12.000
8.500		117.0	75.0	205 8.500	651 8.500	12.050		151.0	101.0	205 12.050	
8.550		125.0	81.0	205 8.550		12.100		151.0	101.0	205 12.100	651 12.100
8.600		125.0	81.0	205 8.600	651 8.600	12.200		151.0	101.0	205 12.200	651 12.200
8.610		125.0	81.0	205 8.610	651 8.610	12.250		151.0	101.0	205 12.250	651 12.250
8.650		125.0	81.0	205 8.650		12.300	31/64	151.0	101.0	205 12.300	651 12.300
8.700		125.0	81.0	205 8.700	651 8.700	12.400		151.0	101.0	205 12.400	651 12.400
8.730	11/32	125.0	81.0	205 8.730	651 8.730	12.500		151.0	101.0	205 12.500	651 12.500
8.750		125.0	81.0	205 8.750	651 8.750	12.600		151.0	101.0	205 12.600	651 12.600
8.800		125.0	81.0	205 8.800	651 8.800	12.650		151.0	101.0	205 12.650	
8.840		125.0	81.0	205 8.840	651 8.840	12.700	1/2	151.0	101.0	205 12.700	651 12.700
8.850		125.0	81.0	205 8.850		12.750		151.0	101.0	205 12.750	651 12.750
8.900		125.0	81.0	205 8.900	651 8.900	12.800		151.0	101.0	205 12.800	651 12.800
8.950		125.0	81.0	205 8.950		12.850		151.0	101.0	205 12.850	
9.000		125.0	81.0	205 9.000	651 9.000	12.900		151.0	101.0	205 12.900	651 12.900
9.030		125.0	81.0	205 9.030		13.000		151.0	101.0	205 13.000	651 13.000
9.050		125.0	81.0	205 9.050	651 9.050	13.100	33/64	151.0	101.0	205 13.100	651 13.100
9.090		125.0	81.0	205 9.090	651 9.090	13.200		151.0	101.0	205 13.200	651 13.200
9.100		125.0	81.0	205 9.100	651 9.100	13.250		160.0	108.0	205 13.250	651 13.250
9.130	23/64	125.0	81.0	205 9.130	651 9.130	13.300		160.0	108.0	205 13.300	651 13.300
9.150		125.0	81.0	205 9.150		13.400		160.0	108.0	205 13.400	
9.200		125.0	81.0	205 9.200	651 9.200	13.490	17/32	160.0	108.0	205 13.490	651 13.490
9.250		125.0	81.0	205 9.250	651 9.250	13.500		160.0	108.0	205 13.500	651 13.500
9.300		125.0	81.0	205 9.300	651 9.300	13.530		160.0	108.0	205 13.530	
9.340		125.0	81.0	205 9.340	651 9.340	13.600		160.0	108.0	205 13.600	
9.350		125.0	81.0	205 9.350	651 9.350	13.700		160.0	108.0	205 13.700	651 13.700
9.400		125.0	81.0	205 9.400	651 9.400	13.750		160.0	108.0	205 13.750	
9.450		125.0	81.0	205 9.450		13.800		160.0	108.0	205 13.800	651 13.800
9.500		125.0	81.0	205 9.500	651 9.500	13.890	35/64	160.0	108.0	205 13.890	651 13.890
9.520	3/8	133.0	87.0	205 9.520	651 9.520	13.900		160.0	108.0	205 13.900	651 13.900
9.550		133.0	87.0	205 9.550	651 9.550	14.000		160.0	108.0	205 14.000	651 14.000
9.580		133.0	87.0	205 9.580	651 9.580	14.100		169.0	114.0	205 14.100	651 14.100
9.600		133.0	87.0	205 9.600	651 9.600	14.200		169.0	114.0	205 14.200	651 14.200
9.650		133.0	87.0	205 9.650		14.250		169.0	114.0	205 14.250	651 14.250

HSS/HSCO drills



HSS/HSCO drills with straight shank

HSS/HSCO drills

Article no.				205	651	Article no.				205	651
d1 mm	inch	l1 mm	l2 mm	Order no.		d1 mm	inch	l1 mm	l2 mm	Order no.	
14.290	9/16	169.0	114.0	205 14.290	651 14.290	17.200		191.0	130.0	205 17.200	
14.300		169.0	114.0	205 14.300	651 14.300	17.250		191.0	130.0	205 17.250	651 17.250
14.400		169.0	114.0	205 14.400		17.300		191.0	130.0	205 17.300	
14.500		169.0	114.0	205 14.500	651 14.500	17.400		191.0	130.0	205 17.400	
14.600		169.0	114.0	205 14.600	651 14.600	17.460	11/16	191.0	130.0	205 17.460	
14.680	37/64	169.0	114.0	205 14.680	651 14.680	17.500		191.0	130.0	205 17.500	651 17.500
14.700		169.0	114.0	205 14.700		17.600		191.0	130.0	205 17.600	
14.750		169.0	114.0	205 14.750		17.700		191.0	130.0	205 17.700	
14.800		169.0	114.0	205 14.800	651 14.800	17.750		191.0	130.0	205 17.750	
14.850		169.0	114.0	205 14.850		17.800		191.0	130.0	205 17.800	
14.900		169.0	114.0	205 14.900		17.860	45/64	191.0	130.0	205 17.860	
15.000		169.0	114.0	205 15.000	651 15.000	17.900		191.0	130.0	205 17.900	
15.080	19/32	178.0	120.0	205 15.080	651 15.080	18.000		191.0	130.0	205 18.000	651 18.000
15.100		178.0	120.0	205 15.100		18.100		198.0	135.0	205 18.100	
15.200		178.0	120.0	205 15.200		18.200		198.0	135.0	205 18.200	
15.250		178.0	120.0	205 15.250	651 15.250	18.250		198.0	135.0	205 18.250	
15.300		178.0	120.0	205 15.300		18.260	23/32	198.0	135.0	205 18.260	
15.400		178.0	120.0	205 15.400	651 15.400	18.300		198.0	135.0	205 18.300	
15.480	39/64	178.0	120.0	205 15.480	651 15.480	18.400		198.0	135.0	205 18.400	
15.500		178.0	120.0	205 15.500	651 15.500	18.500		198.0	135.0	205 18.500	651 18.500
15.600		178.0	120.0	205 15.600		18.600		198.0	135.0	205 18.600	
15.700		178.0	120.0	205 15.700		18.650	47/64	198.0	135.0	205 18.650	
15.750		178.0	120.0	205 15.750		18.750		198.0	135.0	205 18.750	
15.800		178.0	120.0	205 15.800	651 15.800	18.800		198.0	135.0	205 18.800	651 18.800
15.870	5/8	178.0	120.0	205 15.870	651 15.870	19.000		198.0	135.0	205 19.000	651 19.000
15.900		178.0	120.0	205 15.900		19.050	3/4	205.0	140.0	205 19.050	
16.000		178.0	120.0	205 16.000	651 16.000	19.100		205.0	140.0	205 19.100	
16.100		184.0	125.0	205 16.100		19.200		205.0	140.0	205 19.200	
16.200		184.0	125.0	205 16.200		19.250		205.0	140.0	205 19.250	
16.250		184.0	125.0	205 16.250		19.500		205.0	140.0	205 19.500	
16.270	41/64	184.0	125.0	205 16.270		19.600		205.0	140.0	205 19.600	
16.300		184.0	125.0	205 16.300		19.750		205.0	140.0	205 19.750	
16.400		184.0	125.0	205 16.400		19.840	25/32	205.0	140.0	205 19.840	
16.500		184.0	125.0	205 16.500	651 16.500	20.000		205.0	140.0	205 20.000	
16.600		184.0	125.0	205 16.600							
16.670	21/32	184.0	125.0	205 16.670							
16.700		184.0	125.0	205 16.700							
16.750		184.0	125.0	205 16.750	651 16.750						
16.800		184.0	125.0	205 16.800							
16.900		184.0	125.0	205 16.900							
17.000		184.0	125.0	205 17.000	651 17.000						
17.070	43/64	191.0	130.0	205 17.070							

Jobber drills

 Article no. **208**

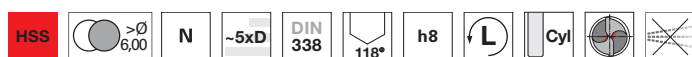

Cutting data page 442

 Web thinning $\geq \varnothing 14.700$ • relieved cone

Jobber drills

 Article no. **664**

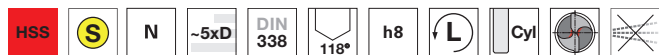
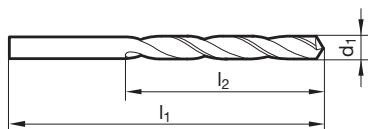
Cutting data page 442

 Web thinning $\geq \varnothing 2.380$ • relieved cone

Article no. 208				Article no. 664				Article no. 208				Article no. 664			
d1 mm	inch	l1 mm	l2 mm	Order no.				d1 mm	inch	l1 mm	l2 mm	Order no.			
0.200		19.0	2.5	208 0.200				1.050		34.0	12.0	208 1.050			
0.300		19.0	3.0	208 0.300				1.070		36.0	14.0	208 1.070			
0.340		19.0	4.0	208 0.340				1.080		36.0	14.0	208 1.080			
0.350		19.0	4.0	208 0.350				1.090		36.0	14.0	208 1.090		664 1.090	
0.370		19.0	4.0	208 0.370				1.100		36.0	14.0	208 1.100		664 1.100	
0.390		20.0	5.0	208 0.390				1.120		36.0	14.0	208 1.120			
0.400	1/64	20.0	5.0	208 0.400				1.130		36.0	14.0	208 1.130			
0.410		20.0	5.0	208 0.410				1.150		36.0	14.0	208 1.150		664 1.150	
0.450		20.0	5.0	208 0.450				1.170		36.0	14.0	208 1.170			
0.460		20.0	5.0	208 0.460				1.180		36.0	14.0	208 1.180		664 1.180	
0.470		20.0	5.0	208 0.470				1.190	3/64	38.0	16.0	208 1.190		664 1.190	
0.500		22.0	6.0	208 0.500		664 0.500		1.200		38.0	16.0	208 1.200			
0.510		22.0	6.0	208 0.510				1.210		38.0	16.0	208 1.210			
0.530		22.0	6.0	208 0.530				1.220		38.0	16.0	208 1.220			
0.540		24.0	7.0	208 0.540				1.250		38.0	16.0	208 1.250		664 1.250	
0.550		24.0	7.0	208 0.550				1.270		38.0	16.0	208 1.270			
0.570		24.0	7.0	208 0.570				1.300		38.0	16.0	208 1.300		664 1.300	
0.600		24.0	7.0	208 0.600		664 0.600		1.310		38.0	16.0	208 1.310			
0.610		26.0	8.0	208 0.610				1.320		38.0	16.0	208 1.320			
0.620		26.0	8.0	208 0.620				1.350		40.0	18.0	208 1.350			
0.630		26.0	8.0	208 0.630				1.380		40.0	18.0	208 1.380			
0.640		26.0	8.0	208 0.640				1.400		40.0	18.0	208 1.400		664 1.400	
0.650		26.0	8.0	208 0.650				1.420		40.0	18.0	208 1.420		664 1.420	
0.660		26.0	8.0	208 0.660				1.450		40.0	18.0	208 1.450		664 1.450	
0.670		26.0	8.0	208 0.670				1.470		40.0	18.0	208 1.470			
0.680		28.0	9.0	208 0.680				1.500		40.0	18.0	208 1.500		664 1.500	
0.690		28.0	9.0	208 0.690				1.510		43.0	20.0	208 1.510			
0.700		28.0	9.0	208 0.700				1.550		43.0	20.0	208 1.550		664 1.550	
0.710		28.0	9.0	208 0.710				1.580		43.0	20.0	208 1.580		664 1.580	
0.720		28.0	9.0	208 0.720				1.590	1/16	43.0	20.0	208 1.590		664 1.590	
0.730		28.0	9.0	208 0.730				1.600		43.0	20.0	208 1.600		664 1.600	
0.740		28.0	9.0	208 0.740				1.610		43.0	20.0	208 1.610			
0.750		28.0	9.0	208 0.750		664 0.750		1.630		43.0	20.0	208 1.630			
0.770		30.0	10.0	208 0.770				1.650		43.0	20.0	208 1.650		664 1.650	
0.780		30.0	10.0	208 0.780				1.700		43.0	20.0	208 1.700		664 1.700	
0.790	1/32	30.0	10.0	208 0.790				1.720		46.0	22.0	208 1.720			
0.800		30.0	10.0	208 0.800		664 0.800		1.760		46.0	22.0	208 1.760			
0.810		30.0	10.0	208 0.810				1.780		46.0	22.0	208 1.780			
0.820		30.0	10.0	208 0.820				1.800		46.0	22.0	208 1.800		664 1.800	
0.830		30.0	10.0	208 0.830				1.830		46.0	22.0	208 1.830			
0.840		30.0	10.0	208 0.840				1.850		46.0	22.0	208 1.850		664 1.850	
0.850		30.0	10.0	208 0.850				1.880		46.0	22.0	208 1.880			
0.870		32.0	11.0	208 0.870				1.900		46.0	22.0	208 1.900		664 1.900	
0.890		32.0	11.0	208 0.890				1.930		49.0	24.0	208 1.930			
0.900		32.0	11.0	208 0.900		664 0.900		1.950		49.0	24.0	208 1.950			
0.910		32.0	11.0	208 0.910				1.970		49.0	24.0	208 1.970			
0.930		32.0	11.0	208 0.930				1.980	5/64	49.0	24.0	208 1.980		664 1.980	
0.950		32.0	11.0	208 0.950		664 0.950		2.000		49.0	24.0	208 2.000		664 2.000	
0.960		34.0	12.0	208 0.960				2.010		49.0	24.0	208 2.010			
0.970		34.0	12.0	208 0.970		664 0.970		2.040		49.0	24.0	208 2.040			
0.980		34.0	12.0	208 0.980				2.050		49.0	24.0	208 2.050		664 2.050	
0.990		34.0	12.0	208 0.990				2.070		49.0	24.0	208 2.070			
1.000		34.0	12.0	208 1.000		664 1.000		2.080		49.0	24.0	208 2.080			
1.020		34.0	12.0	208 1.020				2.100		49.0	24.0	208 2.100		664 2.100	



HSS/HSCO drills with straight shank

HSS/HSCO drills

Article no.				208	664	Article no.				208	664
d1 mm	inch	l1 mm	l2 mm	Order no.		d1 mm	inch	l1 mm	l2 mm	Order no.	
2.150		53.0	27.0	208 2.150		4.800		86.0	52.0	208 4.800	664 4.800
2.180		53.0	27.0	208 2.180		4.850		86.0	52.0	208 4.850	
2.200		53.0	27.0	208 2.200		4.900		86.0	52.0	208 4.900	664 4.900
2.250		53.0	27.0	208 2.250		4.920		86.0	52.0	208 4.920	
2.260		53.0	27.0	208 2.260		4.950		86.0	52.0	208 4.950	
2.300		53.0	27.0	208 2.300	664 2.300	4.980		86.0	52.0	208 4.980	
2.350		53.0	27.0	208 2.350		5.000		86.0	52.0	208 5.000	664 5.000
2.370		57.0	30.0	208 2.370		5.060		86.0	52.0	208 5.060	664 5.060
2.380	3/32	57.0	30.0	208 2.380	664 2.380	5.080		86.0	52.0	208 5.080	
2.400		57.0	30.0	208 2.400	664 2.400	5.100		86.0	52.0	208 5.100	664 5.100
2.440		57.0	30.0	208 2.440		5.110		86.0	52.0	208 5.110	
2.450		57.0	30.0	208 2.450	664 2.450	5.150		86.0	52.0	208 5.150	
2.490		57.0	30.0	208 2.490		5.200		86.0	52.0	208 5.200	664 5.200
2.500		57.0	30.0	208 2.500	664 2.500	5.220		86.0	52.0	208 5.220	
2.530		57.0	30.0	208 2.530		5.300		86.0	52.0	208 5.300	
2.550		57.0	30.0	208 2.550		5.400		93.0	57.0	208 5.400	
2.570		57.0	30.0	208 2.570		5.500		93.0	57.0	208 5.500	664 5.500
2.580		57.0	30.0	208 2.580		5.520		93.0	57.0	208 5.520	
2.600		57.0	30.0	208 2.600	664 2.600	5.560	7/32	93.0	57.0	208 5.560	664 5.560
2.640		57.0	30.0	208 2.640		5.600		93.0	57.0	208 5.600	
2.650		57.0	30.0	208 2.650	664 2.650	5.610		93.0	57.0	208 5.610	
2.670		61.0	33.0	208 2.670		5.700		93.0	57.0	208 5.700	
2.700		61.0	33.0	208 2.700	664 2.700	5.750		93.0	57.0	208 5.750	
2.710		61.0	33.0	208 2.710	664 2.710	5.800		93.0	57.0	208 5.800	664 5.800
2.730		61.0	33.0	208 2.730		5.900		93.0	57.0	208 5.900	
2.750		61.0	33.0	208 2.750	664 2.750	5.940		93.0	57.0	208 5.940	
2.780	7/64	61.0	33.0	208 2.780	664 2.780	5.950	15/64	93.0	57.0	208 5.950	664 5.950
2.800		61.0	33.0	208 2.800		6.000		93.0	57.0	208 6.000	664 6.000
2.820		61.0	33.0	208 2.820		6.050		101.0	63.0	208 6.050	
2.850		61.0	33.0	208 2.850	664 2.850	6.100		101.0	63.0	208 6.100	
2.880		61.0	33.0	208 2.880		6.200		101.0	63.0	208 6.200	664 6.200
2.900		61.0	33.0	208 2.900		6.300		101.0	63.0	208 6.300	
2.950		61.0	33.0	208 2.950	664 2.950	6.350	1/4	101.0	63.0	208 6.350	664 6.350
2.970		61.0	33.0	208 2.970		6.400		101.0	63.0	208 6.400	664 6.400
3.000		61.0	33.0	208 3.000	664 3.000	6.450		101.0	63.0	208 6.450	
3.030		65.0	36.0	208 3.030		6.500		101.0	63.0	208 6.500	664 6.500
3.050		65.0	36.0	208 3.050	664 3.050	6.530		101.0	63.0	208 6.530	
3.100		65.0	36.0	208 3.100	664 3.100	6.550		101.0	63.0	208 6.550	
3.150		65.0	36.0	208 3.150		6.600		101.0	63.0	208 6.600	
3.170	1/8	65.0	36.0	208 3.170		6.630		101.0	63.0	208 6.630	
3.200		65.0	36.0	208 3.200	664 3.200	6.700		101.0	63.0	208 6.700	664 6.700
3.220		65.0	36.0	208 3.220		6.750	17/64	109.0	69.0	208 6.750	
3.250		65.0	36.0	208 3.250		6.800		109.0	69.0	208 6.800	664 6.800
3.260		65.0	36.0	208 3.260		6.880		109.0	69.0	208 6.880	
3.280		65.0	36.0	208 3.280		6.900		109.0	69.0	208 6.900	
3.300		65.0	36.0	208 3.300	664 3.300	7.000		109.0	69.0	208 7.000	664 7.000
3.320		65.0	36.0	208 3.320		7.030		109.0	69.0	208 7.030	
3.330		65.0	36.0	208 3.330		7.100		109.0	69.0	208 7.100	
3.340		65.0	36.0	208 3.340		7.140	9/32	109.0	69.0	208 7.140	
3.370		70.0	39.0	208 3.370		7.200		109.0	69.0	208 7.200	664 7.200
3.400		70.0	39.0	208 3.400	664 3.400	7.300		109.0	69.0	208 7.300	664 7.300
3.450		70.0	39.0	208 3.450		7.400		109.0	69.0	208 7.400	
3.500		70.0	39.0	208 3.500	664 3.500	7.500		109.0	69.0	208 7.500	664 7.500
3.530		70.0	39.0	208 3.530		7.540	19/64	117.0	75.0	208 7.540	664 7.540
3.570	9/64	70.0	39.0	208 3.570		7.600		117.0	75.0	208 7.600	
3.600		70.0	39.0	208 3.600	664 3.600	7.700		117.0	75.0	208 7.700	
3.650		70.0	39.0	208 3.650		7.800		117.0	75.0	208 7.800	
3.700		70.0	39.0	208 3.700	664 3.700	7.850		117.0	75.0	208 7.850	
3.750		70.0	39.0	208 3.750	664 3.750	7.900		117.0	75.0	208 7.900	664 7.900
3.800		75.0	43.0	208 3.800	664 3.800	7.940	5/16	117.0	75.0	208 7.940	
3.850		75.0	43.0	208 3.850		8.000		117.0	75.0	208 8.000	664 8.000
3.900		75.0	43.0	208 3.900	664 3.900	8.100		117.0	75.0	208 8.100	664 8.100
3.910		75.0	43.0	208 3.910		8.200		117.0	75.0	208 8.200	
3.970	5/32	75.0	43.0	208 3.970		8.330	21/64	117.0	75.0	208 8.330	
4.000		75.0	43.0	208 4.000	664 4.000	8.430		117.0	75.0	208 8.430	
4.050		75.0	43.0	208 4.050		8.500		117.0	75.0	208 8.500	664 8.500
4.090		75.0	43.0	208 4.090		8.600		125.0	81.0	208 8.600	
4.100		75.0	43.0	208 4.100	664 4.100	8.700		125.0	81.0	208 8.700	
4.130		75.0	43.0	208 4.130		8.730	11/32	125.0	81.0	208 8.730	664 8.730
4.150		75.0	43.0	208 4.150		8.800		125.0	81.0	208 8.800	664 8.800
4.200		75.0	43.0	208 4.200	664 4.200	9.000		125.0	81.0	208 9.000	664 9.000
4.250		75.0	43.0	208 4.250	664 4.250	9.100		125.0	81.0	208 9.100	
4.300		80.0	47.0	208 4.300		9.130	23/64	125.0	81.0	208 9.130	664 9.130
4.350		80.0	47.0	208 4.350		9.200		125.0	81.0	208 9.200	
4.370	11/64	80.0	47.0	208 4.370		9.300		125.0	81.0	208 9.300	
4.390		80.0	47.0	208 4.390		9.400		125.0	81.0	208 9.400	
4.400		80.0	47.0	208 4.400		9.500		125.0	81.0	208 9.500	664 9.500
4.450		80.0	47.0	208 4.450		9.520	3/8	133.0	87.0	208 9.520	
4.500		80.0	47.0	208 4.500	664 4.500	9.600		133.0	87.0	208 9.600	
4.600		80.0	47.0	208 4.600		9.700		133.0	87.0	208 9.700	
4.680		80.0	47.0	208 4.680		9.800		133.0	87.0	208 9.800	
4.700		80.0	47.0	208 4.700	664 4.700	9.900		133.0	87.0	208 9.900	
4.750		80.0	47.0	208 4.750		9.920	25/64	133.0	87.0	208 9.920	
4.760	3/16	86.0	52.0	208 4.760		10.000		133.0	87.0	208 10.000	664 10.000



Article no.				208	664	Article no.				208	664
d1 mm	inch	l1 mm	l2 mm	Order no.		d1 mm	inch	l1 mm	l2 mm	Order no.	
10.100		133.0	87.0	208 10.100	664 10.100	13.400		160.0	108.0	208 13.400	
10.200		133.0	87.0	208 10.200	664 10.200	13.500		160.0	108.0	208 13.500	664 13.500
10.250		133.0	87.0	208 10.250		13.700		160.0	108.0	208 13.700	
10.300		133.0	87.0	208 10.300		13.750		160.0	108.0	208 13.750	
10.320	13/32	133.0	87.0	208 10.320	664 10.320	13.800		160.0	108.0	208 13.800	
10.500		133.0	87.0	208 10.500	664 10.500	13.900		160.0	108.0	208 13.900	
10.600		133.0	87.0	208 10.600		14.000		160.0	108.0	208 14.000	
11.000		142.0	94.0	208 11.000	664 11.000	14.300		169.0	114.0	208 14.300	
11.100		142.0	94.0	208 11.100		14.500		169.0	114.0	208 14.500	
11.110	7/16	142.0	94.0	208 11.110		14.900		169.0	114.0	208 14.900	
11.300		142.0	94.0	208 11.300		15.000		169.0	114.0	208 15.000	
11.500		142.0	94.0	208 11.500		15.050		178.0	120.0	208 15.050	
11.800		142.0	94.0	208 11.800		15.250		178.0	120.0	208 15.250	
11.900		151.0	101.0	208 11.900		15.500		178.0	120.0	208 15.500	
11.910	15/32	151.0	101.0	208 11.910		15.700		178.0	120.0	208 15.700	
12.000		151.0	101.0	208 12.000	664 12.000	15.750		178.0	120.0	208 15.750	
12.200		151.0	101.0	208 12.200		15.870	5/8	178.0	120.0	208 15.870	
12.300	31/64	151.0	101.0	208 12.300		16.000		178.0	120.0	208 16.000	
12.400		151.0	101.0		664 12.400	17.500		191.0	130.0	208 17.500	
12.500		151.0	101.0	208 12.500	664 12.500	18.500		198.0	135.0	208 18.500	
12.700	1/2	151.0	101.0	208 12.700		19.000		198.0	135.0	208 19.000	
12.750		151.0	101.0	208 12.750		19.050	3/4	205.0	140.0	208 19.050	
13.000		151.0	101.0	208 13.000	664 13.000	20.000		205.0	140.0	208 20.000	
13.250		160.0	108.0	208 13.250							

HSS/HSCO drills



HSS/HSCO drills with straight shank

HSS/HSCO drills

Jobber drills

Article no. 206

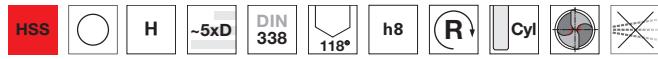

Web thinning ≥ Ø 14.500 • relieved cone

Cutting data page 448

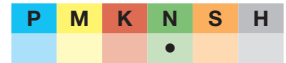

Jobber drills

Article no. 209

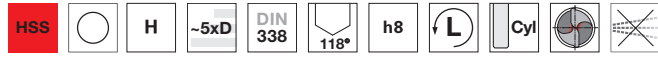

Web thinning ≥ Ø 14.200 • relieved cone

Cutting data page 448

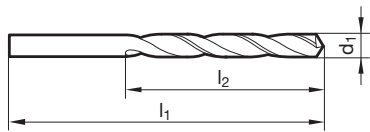

Article no.

206

209

Article no.

206

209

d1 mm	inch	l1 mm	l2 mm	Order no.	d1 mm	inch	l1 mm	l2 mm	Order no.
0.200		19.0	2.5	206 0.200	0.920		32.0	11.0	206 0.920
0.210		19.0	2.5	206 0.210	0.930		32.0	11.0	206 0.930
0.220		19.0	2.5	206 0.220	0.940		32.0	11.0	206 0.940
0.240		19.0	2.5	206 0.240	0.950		32.0	11.0	206 0.950
0.250		19.0	3.0	206 0.250	0.960		34.0	12.0	206 0.960
0.280		19.0	3.0	206 0.280	0.970		34.0	12.0	206 0.970
0.300		19.0	3.0	206 0.300	0.980		34.0	12.0	206 0.980
0.320		19.0	4.0	206 0.320	0.990		34.0	12.0	206 0.990
0.340		19.0	4.0	206 0.340	1.000		34.0	12.0	206 1.000
0.350		19.0	4.0	206 0.350	1.020		34.0	12.0	206 1.020
0.400	1/64	20.0	5.0	206 0.400	1.030		34.0	12.0	206 1.030
0.410		20.0	5.0	206 0.410	1.040		34.0	12.0	206 1.040
0.420		20.0	5.0	206 0.420	1.050		34.0	12.0	206 1.050
0.450		20.0	5.0	206 0.450	1.060		34.0	12.0	206 1.060
0.460		20.0	5.0	206 0.460	1.070		36.0	14.0	206 1.070
0.480		20.0	5.0	206 0.480	1.080		36.0	14.0	206 1.080
0.490		22.0	6.0	209 0.490	1.100		36.0	14.0	206 1.100
0.500		22.0	6.0	206 0.500	1.120		36.0	14.0	206 1.120
0.510		22.0	6.0	206 0.510	1.130		36.0	14.0	206 1.130
0.520		22.0	6.0	206 0.520	1.140		36.0	14.0	206 1.140
0.530		22.0	6.0	206 0.530	1.150		36.0	14.0	206 1.150
0.550		24.0	7.0	206 0.550	1.160		36.0	14.0	206 1.160
0.560		24.0	7.0	206 0.560	1.165		36.0	14.0	209 1.165
0.570		24.0	7.0	206 0.570	1.170		36.0	14.0	209 1.170
0.590		24.0	7.0	209 0.590	1.180		36.0	14.0	206 1.180
0.600		24.0	7.0	206 0.600	1.190	3/64	38.0	16.0	206 1.190
0.620		26.0	8.0	206 0.620	1.200		38.0	16.0	206 1.200
0.650		26.0	8.0	206 0.650	1.210		38.0	16.0	209 1.210
0.660		26.0	8.0	209 0.660	1.220		38.0	16.0	206 1.220
0.670		26.0	8.0	209 0.670	1.230		38.0	16.0	206 1.230
0.680		28.0	9.0	206 0.680	1.250		38.0	16.0	206 1.250
0.690		28.0	9.0	206 0.690	1.270		38.0	16.0	206 1.270
0.700		28.0	9.0	206 0.700	1.280		38.0	16.0	209 1.270
0.710		28.0	9.0	206 0.710	1.300		38.0	16.0	206 1.280
0.720		28.0	9.0	206 0.720	1.320		38.0	16.0	206 1.300
0.730		28.0	9.0	206 0.730	1.320		38.0	16.0	206 1.320
0.740		28.0	9.0	206 0.740	1.330		40.0	18.0	209 1.320
0.750		28.0	9.0	206 0.750	1.350		40.0	18.0	206 1.330
0.760		30.0	10.0	206 0.760	1.370		40.0	18.0	206 1.350
0.770		30.0	10.0	206 0.770	1.380		40.0	18.0	206 1.370
0.780		30.0	10.0	206 0.780	1.400		40.0	18.0	206 1.380
0.790	1/32	30.0	10.0	206 0.790	1.420		40.0	18.0	209 1.380
0.800		30.0	10.0	206 0.800	1.440		40.0	18.0	206 1.400
0.810		30.0	10.0	209 0.810	1.450		40.0	18.0	209 1.400
0.820		30.0	10.0	206 0.820	1.470		40.0	18.0	206 1.420
0.830		30.0	10.0	206 0.830	1.480		40.0	18.0	206 1.430
0.840		30.0	10.0	206 0.840	1.500		40.0	18.0	206 1.440
0.850		30.0	10.0	206 0.850	1.520		43.0	20.0	206 1.450
0.860		32.0	11.0	209 0.860	1.530		43.0	20.0	206 1.470
0.870		32.0	11.0	206 0.870	1.540		43.0	20.0	206 1.480
0.880		32.0	11.0	209 0.880	1.550		43.0	20.0	206 1.500
0.890		32.0	11.0	206 0.890	1.560		43.0	20.0	206 1.520
0.900		32.0	11.0	206 0.900	1.560		43.0	20.0	206 1.530
0.910		32.0	11.0	206 0.910	1.590	1/16	43.0	20.0	206 1.540
									206 1.550
									209 1.550
									209 1.560
									206 1.590



HSS/HSCO drills

Article no.				206	209	Article no.				206	209
d1 mm	inch	l1 mm	l2 mm	Order no.		d1 mm	inch	l1 mm	l2 mm	Order no.	
1.600		43.0	20.0	206 1.600	209 1.600	3.250		65.0	36.0	206 3.250	209 3.250
1.620		43.0	20.0	206 1.620		3.260		65.0	36.0	206 3.260	
1.640		43.0	20.0		209 1.640	3.270		65.0	36.0		209 3.270
1.650		43.0	20.0	206 1.650	209 1.650	3.300		65.0	36.0	206 3.300	209 3.300
1.670		43.0	20.0	206 1.670	209 1.670	3.350		65.0	36.0	206 3.350	209 3.350
1.700		43.0	20.0	206 1.700	209 1.700	3.400		70.0	39.0	206 3.400	209 3.400
1.720		46.0	22.0	206 1.720	209 1.720	3.450		70.0	39.0	206 3.450	209 3.450
1.730		46.0	22.0	206 1.730	209 1.730	3.470		70.0	39.0	206 3.470	209 3.470
1.750		46.0	22.0	206 1.750	209 1.750	3.500		70.0	39.0	206 3.500	209 3.500
1.780		46.0	22.0	206 1.780		3.520		70.0	39.0	206 3.520	
1.800		46.0	22.0	206 1.800	209 1.800	3.550		70.0	39.0	206 3.550	209 3.550
1.810		46.0	22.0		209 1.810	3.570	9/64	70.0	39.0	206 3.570	
1.820		46.0	22.0	206 1.820		3.580		70.0	39.0		209 3.580
1.850		46.0	22.0	206 1.850	209 1.850	3.600		70.0	39.0	206 3.600	
1.860		46.0	22.0		209 1.860	3.650		70.0	39.0	206 3.650	209 3.650
1.870		46.0	22.0	206 1.870	209 1.870	3.700		70.0	39.0	206 3.700	209 3.700
1.900		46.0	22.0	206 1.900	209 1.900	3.720		70.0	39.0	206 3.720	
1.920		49.0	24.0	206 1.920		3.730		70.0	39.0		209 3.730
1.930		49.0	24.0		209 1.930	3.750		70.0	39.0	206 3.750	
1.950		49.0	24.0	206 1.950		3.800		75.0	43.0	206 3.800	
1.960		49.0	24.0	206 1.960		3.830		75.0	43.0	206 3.830	209 3.830
1.980	5/64	49.0	24.0	206 1.980	209 1.980	3.850		75.0	43.0	206 3.850	
2.000		49.0	24.0	206 2.000	209 2.000	3.870		75.0	43.0	206 3.870	
2.020		49.0	24.0	206 2.020		3.880		75.0	43.0	206 3.880	
2.030		49.0	24.0	206 2.030		3.900		75.0	43.0	206 3.900	
2.040		49.0	24.0	206 2.040		3.910		75.0	43.0	206 3.910	
2.050		49.0	24.0	206 2.050	209 2.050	3.950		75.0	43.0	206 3.950	209 3.950
2.060		49.0	24.0	206 2.060		3.960		75.0	43.0		209 3.960
2.070		49.0	24.0	206 2.070		3.970	5/32	75.0	43.0	206 3.970	
2.080		49.0	24.0	206 2.080		4.000		75.0	43.0	206 4.000	209 4.000
2.100		49.0	24.0	206 2.100	209 2.100	4.020		75.0	43.0	206 4.020	
2.120		49.0	24.0	206 2.120		4.040		75.0	43.0	206 4.040	
2.140		53.0	27.0		209 2.140	4.050		75.0	43.0	206 4.050	
2.150		53.0	27.0	206 2.150		4.070		75.0	43.0	206 4.070	209 4.070
2.180		53.0	27.0	206 2.180		4.100		75.0	43.0	206 4.100	209 4.100
2.200		53.0	27.0	206 2.200	209 2.200	4.150		75.0	43.0	206 4.150	
2.220		53.0	27.0	206 2.220	209 2.220	4.200		75.0	43.0	206 4.200	209 4.200
2.230		53.0	27.0	206 2.230	209 2.230	4.250		75.0	43.0	206 4.250	
2.240		53.0	27.0		209 2.240	4.280		80.0	47.0		209 4.280
2.250		53.0	27.0	206 2.250		4.300		80.0	47.0	206 4.300	209 4.300
2.270		53.0	27.0	206 2.270		4.350		80.0	47.0	206 4.350	
2.290		53.0	27.0		209 2.290	4.370	11/64	80.0	47.0	206 4.370	209 4.370
2.300		53.0	27.0	206 2.300	209 2.300	4.400		80.0	47.0	206 4.400	209 4.400
2.320		53.0	27.0	206 2.320		4.450		80.0	47.0	206 4.450	
2.350		53.0	27.0	206 2.350	209 2.350	4.500		80.0	47.0	206 4.500	209 4.500
2.380	3/32	57.0	30.0	206 2.380		4.550		80.0	47.0		209 4.550
2.400		57.0	30.0	206 2.400	209 2.400	4.600		80.0	47.0	206 4.600	209 4.600
2.450		57.0	30.0	206 2.450	209 2.450	4.650		80.0	47.0	206 4.650	
2.470		57.0	30.0	206 2.470	209 2.470	4.700		80.0	47.0	206 4.700	
2.480		57.0	30.0	206 2.480		4.750		80.0	47.0	206 4.750	
2.500		57.0	30.0	206 2.500	209 2.500	4.760	3/16	86.0	52.0	206 4.760	
2.520		57.0	30.0	206 2.520		4.800		86.0	52.0	206 4.800	209 4.800
2.530		57.0	30.0	206 2.530	209 2.530	4.850		86.0	52.0	206 4.850	
2.550		57.0	30.0	206 2.550	209 2.550	4.870		86.0	52.0		209 4.870
2.570		57.0	30.0	206 2.570		4.900		86.0	52.0	206 4.900	
2.600		57.0	30.0	206 2.600	209 2.600	4.950		86.0	52.0	206 4.950	209 4.950
2.630		57.0	30.0	206 2.630		5.000		86.0	52.0	206 5.000	209 5.000
2.640		57.0	30.0	206 2.640		5.050		86.0	52.0	206 5.050	209 5.050
2.650		57.0	30.0	206 2.650	209 2.650	5.100		86.0	52.0	206 5.100	209 5.100
2.700		61.0	33.0	206 2.700	209 2.700	5.150		86.0	52.0	206 5.150	209 5.150
2.710		61.0	33.0	206 2.710		5.160	13/64	86.0	52.0	206 5.160	
2.750		61.0	33.0	206 2.750	209 2.750	5.200		86.0	52.0	206 5.200	209 5.200
2.780	7/64	61.0	33.0	206 2.780		5.250		86.0	52.0	206 5.250	209 5.250
2.800		61.0	33.0	206 2.800	209 2.800	5.300		86.0	52.0	206 5.300	209 5.300
2.820		61.0	33.0	206 2.820		5.310		93.0	57.0	206 5.310	
2.840		61.0	33.0	206 2.840		5.400		93.0	57.0	206 5.400	209 5.400
2.850		61.0	33.0	206 2.850	209 2.850	5.450		93.0	57.0	206 5.450	
2.900		61.0	33.0	206 2.900	209 2.900	5.500		93.0	57.0	206 5.500	209 5.500
2.920		61.0	33.0	206 2.920		5.560	7/32	93.0	57.0	206 5.560	
2.950		61.0	33.0	206 2.950	209 2.950	5.600		93.0	57.0	206 5.600	209 5.600
2.970		61.0	33.0	206 2.970		5.700		93.0	57.0	206 5.700	
3.000		61.0	33.0	206 3.000	209 3.000	5.750		93.0	57.0	206 5.750	
3.010		65.0	36.0	206 3.010		5.800		93.0	57.0	206 5.800	
3.020		65.0	36.0	206 3.020		5.850		93.0	57.0	206 5.850	209 5.850
3.030		65.0	36.0		209 3.030	5.900		93.0	57.0	206 5.900	
3.040		65.0	36.0	206 3.040		5.950	15/64	93.0	57.0	206 5.950	
3.050		65.0	36.0	206 3.050	209 3.050	6.000		93.0	57.0	206 6.000	209 6.000
3.060		65.0	36.0	206 3.060		6.050		101.0	63.0	206 6.050	209 6.050
3.070		65.0	36.0	206 3.070		6.100		101.0	63.0	206 6.100	209 6.100
3.100		65.0	36.0	206 3.100	209 3.100	6.150		101.0	63.0	206 6.150	
3.150		65.0	36.0	206 3.150	209 3.150	6.200		101.0	63.0	206 6.200	
3.170	1/8	65.0	36.0	206 3.170		6.250		101.0	63.0	206 6.250	
3.200		65.0	36.0	206 3.200	209 3.200	6.300		101.0	63.0	206 6.300	209 6.300
3.220		65.0	36.0	206 3.220		6.350	1/4	101.0	63.0	206 6.350	



HSS/HSCO drills with straight shank

HSS/HSCO drills

Article no.				206	209	Article no.				206	209
d1 mm	inch	l1 mm	l2 mm	Order no.		d1 mm	inch	l1 mm	l2 mm	Order no.	
6.400		101.0	63.0	206 6.400	209 6.400	9.600		133.0	87.0	206 9.600	
6.450		101.0	63.0	206 6.450		9.700		133.0	87.0	206 9.700	
6.500		101.0	63.0	206 6.500	209 6.500	9.800		133.0	87.0	206 9.800	
6.530		101.0	63.0	206 6.530		9.900		133.0	87.0	206 9.900	
6.550		101.0	63.0	206 6.550		9.920	25/64	133.0	87.0	206 9.920	
6.600		101.0	63.0	206 6.600		10.000		133.0	87.0	206 10.000	209 10.000
6.700		101.0	63.0	206 6.700	209 6.700	10.100		133.0	87.0	206 10.100	209 10.100
6.750	17/64	109.0	69.0	206 6.750		10.150		133.0	87.0	206 10.150	
6.800		109.0	69.0	206 6.800	209 6.800	10.200		133.0	87.0	206 10.200	
6.900		109.0	69.0	206 6.900	209 6.900	10.250		133.0	87.0	206 10.250	
7.000		109.0	69.0	206 7.000	209 7.000	10.320	13/32	133.0	87.0	206 10.320	
7.050		109.0	69.0	206 7.050		10.500		133.0	87.0	206 10.500	
7.100		109.0	69.0	206 7.100	209 7.100	10.600		133.0	87.0	206 10.600	
7.140	9/32	109.0	69.0	206 7.140		10.720	27/64	142.0	94.0	206 10.720	
7.200		109.0	69.0	206 7.200		10.800		142.0	94.0	206 10.800	
7.250		109.0	69.0	206 7.250		10.900		142.0	94.0	206 10.900	
7.300		109.0	69.0	206 7.300	209 7.300	11.000		142.0	94.0	206 11.000	209 11.000
7.350		109.0	69.0	206 7.350		11.110	7/16	142.0	94.0	206 11.110	
7.400		109.0	69.0	206 7.400		11.200		142.0	94.0	206 11.200	
7.500		109.0	69.0	206 7.500		11.300		142.0	94.0	206 11.300	
7.540	19/64	117.0	75.0	206 7.540		11.400		142.0	94.0	206 11.400	
7.600		117.0	75.0	206 7.600		11.500		142.0	94.0	206 11.500	
7.700		117.0	75.0	206 7.700	209 7.700	11.510	29/64	142.0	94.0	206 11.510	
7.750		117.0	75.0	206 7.750		11.900		151.0	101.0	206 11.900	
7.800		117.0	75.0	206 7.800	209 7.800	11.910		151.0	101.0	206 11.910	
7.850		117.0	75.0	206 7.850		12.000		151.0	101.0	206 12.000	
7.900		117.0	75.0	206 7.900		12.050		151.0	101.0		209 12.050
7.940	5/16	117.0	75.0	206 7.940		12.100		151.0	101.0	206 12.100	
8.000		117.0	75.0	206 8.000	209 8.000	12.150		151.0	101.0		209 12.150
8.050		117.0	75.0		209 8.050	12.200		151.0	101.0	206 12.200	209 12.200
8.100		117.0	75.0	206 8.100	209 8.100	12.300	31/64	151.0	101.0	206 12.300	
8.200		117.0	75.0	206 8.200		12.500		151.0	101.0	206 12.500	209 12.500
8.250		117.0	75.0	206 8.250		12.700	1/2	151.0	101.0	206 12.700	
8.300		117.0	75.0	206 8.300	209 8.300	12.800		151.0	101.0	206 12.800	
8.330	21/64	117.0	75.0	206 8.330		13.000		151.0	101.0	206 13.000	
8.400		117.0	75.0	206 8.400	209 8.400	13.200		151.0	101.0	206 13.200	
8.450		117.0	75.0		209 8.450	13.300		160.0	108.0		209 13.300
8.500		117.0	75.0	206 8.500		13.500		160.0	108.0	206 13.500	209 13.500
8.600		125.0	81.0	206 8.600	209 8.600	13.800		160.0	108.0	206 13.800	
8.700		125.0	81.0	206 8.700		14.000		160.0	108.0	206 14.000	209 14.000
8.730	11/32	125.0	81.0	206 8.730		14.200		169.0	114.0		209 14.200
8.750		125.0	81.0	206 8.750		14.300		169.0	114.0		209 14.300
8.800		125.0	81.0	206 8.800	209 8.800	14.400		169.0	114.0		209 14.400
8.900		125.0	81.0	206 8.900		14.500		169.0	114.0	206 14.500	209 14.500
9.000		125.0	81.0	206 9.000	209 9.000	15.000		169.0	114.0	206 15.000	
9.050		125.0	81.0	206 9.050		15.100		178.0	120.0		209 15.100
9.100		125.0	81.0	206 9.100	209 9.100	15.500		178.0	120.0	206 15.500	
9.130	23/64	125.0	81.0	206 9.130		16.000		178.0	120.0	206 16.000	
9.200		125.0	81.0	206 9.200		17.000		184.0	125.0	206 17.000	
9.250		125.0	81.0	206 9.250	209 9.250	18.000		191.0	130.0	206 18.000	209 18.000
9.300		125.0	81.0	206 9.300		19.000		198.0	135.0	206 19.000	
9.400		125.0	81.0	206 9.400		20.000		205.0	140.0	206 20.000	
9.500		125.0	81.0	206 9.500							
9.520	3/8	133.0	87.0	206 9.520							



Jobber drills

Article no. **207**



Cutting data page 451

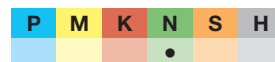
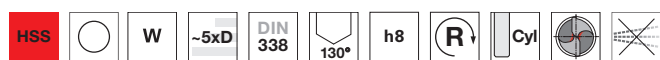

Web thinning $\geq \varnothing 14.500$ • relieved cone

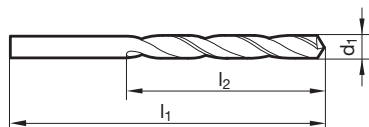

Article no. 207				Article no. 207					
d1 mm	inch	l1 mm	l2 mm	Order no.	d1 mm	inch	l1 mm	l2 mm	Order no.
0.200		19.0	2.5	207 0.200	1.770		46.0	22.0	207 1.770
0.250		19.0	3.0	207 0.250	1.780		46.0	22.0	207 1.780
0.300		19.0	3.0	207 0.300	1.800		46.0	22.0	207 1.800
0.340		19.0	4.0	207 0.340	1.820		46.0	22.0	207 1.820
0.350		19.0	4.0	207 0.350	1.850		46.0	22.0	207 1.850
0.400	1/64	20.0	5.0	207 0.400	1.900		46.0	22.0	207 1.900
0.410		20.0	5.0	207 0.410	1.920		49.0	24.0	207 1.920
0.450		20.0	5.0	207 0.450	1.930		49.0	24.0	207 1.930
0.460		20.0	5.0	207 0.460	1.950		49.0	24.0	207 1.950
0.500		22.0	6.0	207 0.500	1.980	5/64	49.0	24.0	207 1.980
0.520		22.0	6.0	207 0.520	2.000		49.0	24.0	207 2.000
0.550		24.0	7.0	207 0.550	2.020		49.0	24.0	207 2.020
0.570		24.0	7.0	207 0.570	2.030		49.0	24.0	207 2.030
0.600		24.0	7.0	207 0.600	2.050		49.0	24.0	207 2.050
0.610		26.0	8.0	207 0.610	2.060		49.0	24.0	207 2.060
0.620		26.0	8.0	207 0.620	2.080		49.0	24.0	207 2.080
0.650		26.0	8.0	207 0.650	2.100		49.0	24.0	207 2.100
0.660		26.0	8.0	207 0.660	2.150		53.0	27.0	207 2.150
0.700		28.0	9.0	207 0.700	2.200		53.0	27.0	207 2.200
0.720		28.0	9.0	207 0.720	2.250		53.0	27.0	207 2.250
0.750		28.0	9.0	207 0.750	2.300		53.0	27.0	207 2.300
0.790	1/32	30.0	10.0	207 0.790	2.320		53.0	27.0	207 2.320
0.800		30.0	10.0	207 0.800	2.350		53.0	27.0	207 2.350
0.810		30.0	10.0	207 0.810	2.380	3/32	57.0	30.0	207 2.380
0.840		30.0	10.0	207 0.840	2.400		57.0	30.0	207 2.400
0.850		30.0	10.0	207 0.850	2.450		57.0	30.0	207 2.450
0.870		32.0	11.0	207 0.870	2.500		57.0	30.0	207 2.500
0.900		32.0	11.0	207 0.900	2.530		57.0	30.0	207 2.530
0.950		32.0	11.0	207 0.950	2.550		57.0	30.0	207 2.550
0.970		34.0	12.0	207 0.970	2.600		57.0	30.0	207 2.600
1.000		34.0	12.0	207 1.000	2.650		57.0	30.0	207 2.650
1.010		34.0	12.0	207 1.010	2.700		61.0	33.0	207 2.700
1.020		34.0	12.0	207 1.020	2.730		61.0	33.0	207 2.730
1.050		34.0	12.0	207 1.050	2.750		61.0	33.0	207 2.750
1.100		36.0	14.0	207 1.100	2.780	7/64	61.0	33.0	207 2.780
1.120		36.0	14.0	207 1.120	2.800		61.0	33.0	207 2.800
1.150		36.0	14.0	207 1.150	2.820		61.0	33.0	207 2.820
1.180		36.0	14.0	207 1.180	2.830		61.0	33.0	207 2.830
1.190	3/64	38.0	16.0	207 1.190	2.850		61.0	33.0	207 2.850
1.200		38.0	16.0	207 1.200	2.900		61.0	33.0	207 2.900
1.220		38.0	16.0	207 1.220	2.930		61.0	33.0	207 2.930
1.250		38.0	16.0	207 1.250	2.950		61.0	33.0	207 2.950
1.270		38.0	16.0	207 1.270	3.000		61.0	33.0	207 3.000
1.280		38.0	16.0	207 1.280	3.030		65.0	36.0	207 3.030
1.300		38.0	16.0	207 1.300	3.050		65.0	36.0	207 3.050
1.330		40.0	18.0	207 1.330	3.100		65.0	36.0	207 3.100
1.350		40.0	18.0	207 1.350	3.150		65.0	36.0	207 3.150
1.380		40.0	18.0	207 1.380	3.170	1/8	65.0	36.0	207 3.170
1.400		40.0	18.0	207 1.400	3.200		65.0	36.0	207 3.200
1.420		40.0	18.0	207 1.420	3.250		65.0	36.0	207 3.250
1.430		40.0	18.0	207 1.430	3.260		65.0	36.0	207 3.260
1.450		40.0	18.0	207 1.450	3.300		65.0	36.0	207 3.300
1.500		40.0	18.0	207 1.500	3.350		65.0	36.0	207 3.350
1.510		43.0	20.0	207 1.510	3.380		70.0	39.0	207 3.380
1.520		43.0	20.0	207 1.520	3.400		70.0	39.0	207 3.400
1.530		43.0	20.0	207 1.530	3.450		70.0	39.0	207 3.450
1.550		43.0	20.0	207 1.550	3.500		70.0	39.0	207 3.500
1.570		43.0	20.0	207 1.570	3.530		70.0	39.0	207 3.530
1.590	1/16	43.0	20.0	207 1.590	3.550		70.0	39.0	207 3.550
1.600		43.0	20.0	207 1.600	3.570	9/64	70.0	39.0	207 3.570
1.610		43.0	20.0	207 1.610	3.600		70.0	39.0	207 3.600
1.630		43.0	20.0	207 1.630	3.650		70.0	39.0	207 3.650
1.650		43.0	20.0	207 1.650	3.700		70.0	39.0	207 3.700
1.680		43.0	20.0	207 1.680	3.730		70.0	39.0	207 3.730
1.700		43.0	20.0	207 1.700	3.750		70.0	39.0	207 3.750
1.750		46.0	22.0	207 1.750	3.800		75.0	43.0	207 3.800

HSS/HSCO drills



HSS/HSCO drills with straight shank

HSS/HSCO drills

Article no.				207	Article no.				207
d1 mm	inch	l1 mm	l2 mm	Order no.	d1 mm	inch	l1 mm	l2 mm	Order no.
3.850		75.0	43.0	207 3.850	8.200		117.0	75.0	207 8.200
3.900		75.0	43.0	207 3.900	8.250		117.0	75.0	207 8.250
3.950		75.0	43.0	207 3.950	8.300		117.0	75.0	207 8.300
3.970	5/32	75.0	43.0	207 3.970	8.400		117.0	75.0	207 8.400
4.000		75.0	43.0	207 4.000	8.500		117.0	75.0	207 8.500
4.040		75.0	43.0	207 4.040	8.600		125.0	81.0	207 8.600
4.050		75.0	43.0	207 4.050	8.700		125.0	81.0	207 8.700
4.100		75.0	43.0	207 4.100	8.730	11/32	125.0	81.0	207 8.730
4.150		75.0	43.0	207 4.150	8.750		125.0	81.0	207 8.750
4.200		75.0	43.0	207 4.200	8.800		125.0	81.0	207 8.800
4.220		75.0	43.0	207 4.220	8.840		125.0	81.0	207 8.840
4.250		75.0	43.0	207 4.250	8.900		125.0	81.0	207 8.900
4.300		80.0	47.0	207 4.300	9.000		125.0	81.0	207 9.000
4.350		80.0	47.0	207 4.350	9.090		125.0	81.0	207 9.090
4.400		80.0	47.0	207 4.400	9.100		125.0	81.0	207 9.100
4.500		80.0	47.0	207 4.500	9.130	23/64	125.0	81.0	207 9.130
4.550		80.0	47.0	207 4.550	9.200		125.0	81.0	207 9.200
4.600		80.0	47.0	207 4.600	9.300		125.0	81.0	207 9.300
4.650		80.0	47.0	207 4.650	9.340		125.0	81.0	207 9.340
4.700		80.0	47.0	207 4.700	9.400		125.0	81.0	207 9.400
4.750		80.0	47.0	207 4.750	9.500		125.0	81.0	207 9.500
4.760	3/16	86.0	52.0	207 4.760	9.520	3/8	133.0	87.0	207 9.520
4.800		86.0	52.0	207 4.800	9.600		133.0	87.0	207 9.600
4.850		86.0	52.0	207 4.850	9.700		133.0	87.0	207 9.700
4.900		86.0	52.0	207 4.900	9.800		133.0	87.0	207 9.800
5.000		86.0	52.0	207 5.000	9.900		133.0	87.0	207 9.900
5.030		86.0	52.0	207 5.030	9.920	25/64	133.0	87.0	207 9.920
5.050		86.0	52.0	207 5.050	10.000		133.0	87.0	207 10.000
5.100		86.0	52.0	207 5.100	10.080		133.0	87.0	207 10.080
5.160	13/64	86.0	52.0	207 5.160	10.100		133.0	87.0	207 10.100
5.200		86.0	52.0	207 5.200	10.200		133.0	87.0	207 10.200
5.250		86.0	52.0	207 5.250	10.250		133.0	87.0	207 10.250
5.300		86.0	52.0	207 5.300	10.300		133.0	87.0	207 10.300
5.400		93.0	57.0	207 5.400	10.400		133.0	87.0	207 10.400
5.450		93.0	57.0	207 5.450	10.500		133.0	87.0	207 10.500
5.500		93.0	57.0	207 5.500	10.700		142.0	94.0	207 10.700
5.550		93.0	57.0	207 5.550	10.800		142.0	94.0	207 10.800
5.560	7/32	93.0	57.0	207 5.560	10.900		142.0	94.0	207 10.900
5.600		93.0	57.0	207 5.600	11.000		142.0	94.0	207 11.000
5.700		93.0	57.0	207 5.700	11.110		142.0	94.0	207 11.110
5.750		93.0	57.0	207 5.750	11.200		142.0	94.0	207 11.200
5.800		93.0	57.0	207 5.800	11.500		142.0	94.0	207 11.500
5.900		93.0	57.0	207 5.900	11.510	29/64	142.0	94.0	207 11.510
5.950	15/64	93.0	57.0	207 5.950	11.600		142.0	94.0	207 11.600
6.000		93.0	57.0	207 6.000	11.700		142.0	94.0	207 11.700
6.050		101.0	63.0	207 6.050	11.750		142.0	94.0	207 11.750
6.100		101.0	63.0	207 6.100	11.800		142.0	94.0	207 11.800
6.150		101.0	63.0	207 6.150	11.900		151.0	101.0	207 11.900
6.200		101.0	63.0	207 6.200	12.000		151.0	101.0	207 12.000
6.250		101.0	63.0	207 6.250	12.100		151.0	101.0	207 12.100
6.300		101.0	63.0	207 6.300	12.200		151.0	101.0	207 12.200
6.350	1/4	101.0	63.0	207 6.350	12.500		151.0	101.0	207 12.500
6.400		101.0	63.0	207 6.400	12.600		151.0	101.0	207 12.600
6.500		101.0	63.0	207 6.500	12.700	1/2	151.0	101.0	207 12.700
6.530		101.0	63.0	207 6.530	12.800		151.0	101.0	207 12.800
6.550		101.0	63.0	207 6.550	12.900		151.0	101.0	207 12.900
6.600		101.0	63.0	207 6.600	13.000		151.0	101.0	207 13.000
6.630		101.0	63.0	207 6.630	13.100	33/64	151.0	101.0	207 13.100
6.650		101.0	63.0	207 6.650	13.200		151.0	101.0	207 13.200
6.700		101.0	63.0	207 6.700	13.500		160.0	108.0	207 13.500
6.750	17/64	109.0	69.0	207 6.750	13.800		160.0	108.0	207 13.800
6.800		109.0	69.0	207 6.800	14.000		160.0	108.0	207 14.000
6.850		109.0	69.0	207 6.850	14.500		169.0	114.0	207 14.500
6.900		109.0	69.0	207 6.900	14.700		169.0	114.0	207 14.700
7.000		109.0	69.0	207 7.000	15.000		169.0	114.0	207 15.000
7.100		109.0	69.0	207 7.100	15.500		178.0	120.0	207 15.500
7.140	9/32	109.0	69.0	207 7.140	15.600		178.0	120.0	207 15.600
7.200		109.0	69.0	207 7.200	16.000		178.0	120.0	207 16.000
7.250		109.0	69.0	207 7.250	16.500		184.0	125.0	207 16.500
7.300		109.0	69.0	207 7.300	17.000		184.0	125.0	207 17.000
7.400		109.0	69.0	207 7.400	17.500		191.0	130.0	207 17.500
7.500		109.0	69.0	207 7.500	18.000		191.0	130.0	207 18.000
7.540	19/64	117.0	75.0	207 7.540	19.000		198.0	135.0	207 19.000
7.600		117.0	75.0	207 7.600	20.000		205.0	140.0	207 20.000
7.700		117.0	75.0	207 7.700					
7.750		117.0	75.0	207 7.750					
7.800		117.0	75.0	207 7.800					
7.900		117.0	75.0	207 7.900					
7.940	5/16	117.0	75.0	207 7.940					
8.000		117.0	75.0	207 8.000					
8.030		117.0	75.0	207 8.030					
8.050		117.0	75.0	207 8.050					
8.100		117.0	75.0	207 8.100					
8.150		117.0	75.0	207 8.150					

Jobber drills

 Article no. **549**

Cutting data page 452



 Web thinning $\geq \varnothing 0.970$ • relieved cone • wide flutes • especially for drilling depths over 3xD

P	M	K	N	S	H
•		•	•		

Jobber drills

 Article no. **652**

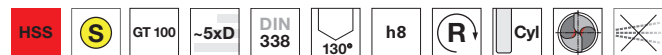
Cutting data page 452

 Web thinning $\geq \varnothing 1.000$ • relieved cone • wide flutes • especially for drilling depths over 3xD

P	M	K	N	S	H
•		•	○		

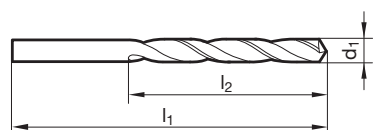

Article no.

549
652

Article no.

549
652

d1 mm	inch	l1 mm	l2 mm	Order no.	d1 mm	inch	l1 mm	l2 mm	Order no.
0.600		24.0	7.0	549 0.600	1.930		49.0	24.0	549 1.930 652 1.930
0.700		28.0	9.0	549 0.700	1.950		49.0	24.0	549 1.950 652 1.950
0.710		28.0	9.0	549 0.710	1.980	5/64	49.0	24.0	549 1.980 652 1.980
0.790	1/32	30.0	10.0	549 0.790	1.990		49.0	24.0	549 1.990 652 1.990
0.800		30.0	10.0	549 0.800	2.000		49.0	24.0	549 2.000 652 2.000
0.890		32.0	11.0	549 0.890	2.020		49.0	24.0	549 2.020
0.900		32.0	11.0	549 0.900	2.050		49.0	24.0	549 2.050 652 2.050
0.950		32.0	11.0	549 0.950	2.060		49.0	24.0	549 2.060 652 2.060
0.970		34.0	12.0	549 0.970	2.080		49.0	24.0	549 2.080 652 2.080
0.990		34.0	12.0	549 0.990	2.100		49.0	24.0	549 2.100 652 2.100
1.000		34.0	12.0	549 1.000 652 1.000	2.150		53.0	27.0	549 2.150 652 2.150
1.020		34.0	12.0	549 1.020 652 1.020	2.180		53.0	27.0	549 2.180 652 2.180
1.040		34.0	12.0	549 1.040 652 1.040	2.200		53.0	27.0	549 2.200 652 2.200
1.050		34.0	12.0	549 1.050	2.250		53.0	27.0	549 2.250
1.070		36.0	14.0	549 1.070 652 1.070	2.260		53.0	27.0	549 2.260 652 2.260
1.090		36.0	14.0	549 1.090 652 1.090	2.300		53.0	27.0	549 2.300 652 2.300
1.100		36.0	14.0	549 1.100 652 1.100	2.330		53.0	27.0	549 2.330
1.150		36.0	14.0	549 1.150	2.350		53.0	27.0	549 2.350 652 2.350
1.180		36.0	14.0	549 1.180 652 1.180	2.370		57.0	30.0	549 2.370 652 2.370
1.190	3/64	38.0	16.0	549 1.190 652 1.190	2.380	3/32	57.0	30.0	549 2.380 652 2.380
1.200		38.0	16.0	549 1.200 652 1.200	2.400		57.0	30.0	549 2.400 652 2.400
1.220		38.0	16.0	549 1.220 652 1.220	2.420		57.0	30.0	549 2.420
1.230		38.0	16.0	549 1.230	2.440		57.0	30.0	549 2.440 652 2.440
1.240		38.0	16.0	549 1.240	2.450		57.0	30.0	549 2.450 652 2.450
1.250		38.0	16.0	549 1.250 652 1.250	2.480		57.0	30.0	549 2.480
1.300		38.0	16.0	549 1.300 652 1.300	2.490		57.0	30.0	549 2.490 652 2.490
1.320		38.0	16.0	549 1.320 652 1.320	2.500		57.0	30.0	549 2.500 652 2.500
1.350		40.0	18.0	549 1.350 652 1.350	2.530		57.0	30.0	549 2.530 652 2.530
1.400		40.0	18.0	549 1.400 652 1.400	2.550		57.0	30.0	549 2.550 652 2.550
1.450		40.0	18.0	549 1.450 652 1.450	2.580		57.0	30.0	549 2.580 652 2.580
1.500		40.0	18.0	549 1.500 652 1.500	2.600		57.0	30.0	549 2.600 652 2.600
1.510		43.0	20.0	549 1.510 652 1.510	2.640		57.0	30.0	549 2.640 652 2.640
1.530		43.0	20.0	549 1.530 652 1.530	2.650		57.0	30.0	549 2.650 652 2.650
1.550		43.0	20.0	549 1.550 652 1.550	2.700		61.0	33.0	549 2.700 652 2.700
1.560		43.0	20.0	549 1.560	2.710		61.0	33.0	549 2.710 652 2.710
1.570		43.0	20.0	549 1.570	2.750		61.0	33.0	549 2.750 652 2.750
1.580		43.0	20.0	549 1.580	2.780	7/64	61.0	33.0	549 2.780 652 2.780
1.590	1/16	43.0	20.0	549 1.590 652 1.590	2.790		61.0	33.0	549 2.790 652 2.790
1.600		43.0	20.0	549 1.600 652 1.600	2.800		61.0	33.0	549 2.800 652 2.800
1.610		43.0	20.0	549 1.610 652 1.610	2.820		61.0	33.0	549 2.820 652 2.820
1.620		43.0	20.0	549 1.620	2.850		61.0	33.0	549 2.850 652 2.850
1.650		43.0	20.0	549 1.650 652 1.650	2.870		61.0	33.0	549 2.870 652 2.870
1.660		43.0	20.0	549 1.660	2.900		61.0	33.0	549 2.900 652 2.900
1.670		43.0	20.0	549 1.670	2.950		61.0	33.0	549 2.950 652 2.950
1.680		43.0	20.0	549 1.680	2.980		61.0	33.0	549 2.980
1.690		43.0	20.0	549 1.690	3.000		61.0	33.0	549 3.000 652 3.000
1.700		43.0	20.0	549 1.700 652 1.700	3.030		65.0	36.0	549 3.030
1.720		46.0	22.0	549 1.720 652 1.720	3.050		65.0	36.0	549 3.050 652 3.050
1.750		46.0	22.0	549 1.750 652 1.750	3.080		65.0	36.0	549 3.080
1.780		46.0	22.0	549 1.780 652 1.780	3.100		65.0	36.0	549 3.100 652 3.100
1.800		46.0	22.0	549 1.800 652 1.800	3.150		65.0	36.0	549 3.150
1.850		46.0	22.0	549 1.850 652 1.850	3.170	1/8	65.0	36.0	549 3.170 652 3.170
1.860		46.0	22.0	549 1.860	3.200		65.0	36.0	549 3.200 652 3.200
1.900		46.0	22.0	549 1.900 652 1.900	3.220		65.0	36.0	549 3.220



HSS/HSCO drills with straight shank

HSS/HSCO drills

Article no.				549	652	Article no.				549	652
d1 mm	inch	l1 mm	l2 mm	Order no.		d1 mm	inch	l1 mm	l2 mm	Order no.	
3.230		65.0	36.0	549 3.230		5.900		93.0	57.0	549 5.900	652 5.900
3.250		65.0	36.0	549 3.250	652 3.250	5.940		93.0	57.0	549 5.940	
3.260		65.0	36.0	549 3.260	652 3.260	5.950	15/64	93.0	57.0	549 5.950	652 5.950
3.300		65.0	36.0	549 3.300	652 3.300	6.000		93.0	57.0	549 6.000	652 6.000
3.350		65.0	36.0	549 3.350	652 3.350	6.040		101.0	63.0	549 6.040	652 6.040
3.400		70.0	39.0	549 3.400	652 3.400	6.050		101.0	63.0	549 6.050	
3.450		70.0	39.0	549 3.450	652 3.450	6.100		101.0	63.0	549 6.100	652 6.100
3.500		70.0	39.0	549 3.500	652 3.500	6.150		101.0	63.0	549 6.150	652 6.150
3.550		70.0	39.0	549 3.550		6.200		101.0	63.0	549 6.200	652 6.200
3.570	9/64	70.0	39.0	549 3.570	652 3.570	6.250		101.0	63.0	549 6.250	652 6.250
3.580		70.0	39.0	549 3.580		6.300		101.0	63.0	549 6.300	652 6.300
3.600		70.0	39.0	549 3.600	652 3.600	6.350	1/4	101.0	63.0	549 6.350	652 6.350
3.650		70.0	39.0		652 3.650	6.400		101.0	63.0	549 6.400	652 6.400
3.660		70.0	39.0	549 3.660	652 3.660	6.500		101.0	63.0	549 6.500	652 6.500
3.680		70.0	39.0	549 3.680		6.530		101.0	63.0	549 6.530	652 6.530
3.700		70.0	39.0	549 3.700	652 3.700	6.550		101.0	63.0	549 6.550	
3.730		70.0	39.0	549 3.730	652 3.730	6.600		101.0	63.0	549 6.600	652 6.600
3.750		70.0	39.0	549 3.750	652 3.750	6.630		101.0	63.0	549 6.630	652 6.630
3.800		75.0	43.0	549 3.800	652 3.800	6.700		101.0	63.0	549 6.700	652 6.700
3.860		75.0	43.0	549 3.860	652 3.860	6.750	17/64	109.0	69.0	549 6.750	652 6.750
3.870		75.0	43.0	549 3.870		6.800		109.0	69.0	549 6.800	652 6.800
3.900		75.0	43.0	549 3.900	652 3.900	6.830		109.0	69.0	549 6.830	
3.910		75.0	43.0	549 3.910	652 3.910	6.900		109.0	69.0	549 6.900	652 6.900
3.950		75.0	43.0	549 3.950		7.000		109.0	69.0	549 7.000	652 7.000
3.970	5/32	75.0	43.0	549 3.970	652 3.970	7.030		109.0	69.0	549 7.030	652 7.030
3.990		75.0	43.0	549 3.990	652 3.990	7.040		109.0	69.0	549 7.040	
4.000		75.0	43.0	549 4.000	652 4.000	7.050		109.0	69.0	549 7.050	
4.040		75.0	43.0	549 4.040	652 4.040	7.100		109.0	69.0	549 7.100	652 7.100
4.050		75.0	43.0	549 4.050	652 4.050	7.140	9/32	109.0	69.0	549 7.140	652 7.140
4.090		75.0	43.0	549 4.090	652 4.090	7.200		109.0	69.0	549 7.200	652 7.200
4.100		75.0	43.0	549 4.100	652 4.100	7.250		109.0	69.0	549 7.250	
4.150		75.0	43.0	549 4.150		7.300		109.0	69.0	549 7.300	652 7.300
4.200		75.0	43.0	549 4.200	652 4.200	7.370		109.0	69.0	549 7.370	652 7.370
4.220		75.0	43.0	549 4.220	652 4.220	7.400		109.0	69.0	549 7.400	652 7.400
4.250		75.0	43.0	549 4.250	652 4.250	7.490		109.0	69.0	549 7.490	652 7.490
4.300		80.0	47.0	549 4.300	652 4.300	7.500		109.0	69.0	549 7.500	652 7.500
4.370	11/64	80.0	47.0	549 4.370	652 4.370	7.540	19/64	117.0	75.0	549 7.540	652 7.540
4.390		80.0	47.0	549 4.390	652 4.390	7.580		117.0	75.0	549 7.580	
4.400		80.0	47.0	549 4.400	652 4.400	7.600		117.0	75.0	549 7.600	652 7.600
4.450		80.0	47.0	549 4.450	652 4.450	7.670		117.0	75.0	549 7.670	652 7.670
4.500		80.0	47.0	549 4.500	652 4.500	7.700		117.0	75.0	549 7.700	652 7.700
4.550		80.0	47.0	549 4.550		7.750		117.0	75.0	549 7.750	
4.570		80.0	47.0	549 4.570	652 4.570	7.800		117.0	75.0	549 7.800	652 7.800
4.600		80.0	47.0	549 4.600	652 4.600	7.900		117.0	75.0	549 7.900	652 7.900
4.620		80.0	47.0	549 4.620	652 4.620	7.940	5/16	117.0	75.0	549 7.940	652 7.940
4.650		80.0	47.0	549 4.650		8.000		117.0	75.0	549 8.000	652 8.000
4.700		80.0	47.0	549 4.700	652 4.700	8.030		117.0	75.0	549 8.030	652 8.030
4.750		80.0	47.0	549 4.750		8.100		117.0	75.0	549 8.100	652 8.100
4.760	3/16	86.0	52.0	549 4.760	652 4.760	8.150		117.0	75.0		652 8.150
4.800		86.0	52.0	549 4.800	652 4.800	8.200		117.0	75.0	549 8.200	652 8.200
4.850		86.0	52.0	549 4.850	652 4.850	8.250		117.0	75.0	549 8.250	
4.900		86.0	52.0	549 4.900	652 4.900	8.300		117.0	75.0	549 8.300	652 8.300
4.920		86.0	52.0	549 4.920	652 4.920	8.330	21/64	117.0	75.0	549 8.330	652 8.330
4.950		86.0	52.0	549 4.950		8.400		117.0	75.0	549 8.400	652 8.400
4.980		86.0	52.0	549 4.980	652 4.980	8.430		117.0	75.0	549 8.430	652 8.430
5.000		86.0	52.0	549 5.000	652 5.000	8.500		117.0	75.0	549 8.500	652 8.500
5.030		86.0	52.0	549 5.030		8.600		125.0	81.0	549 8.600	652 8.600
5.050		86.0	52.0	549 5.050		8.610		125.0	81.0	549 8.610	652 8.610
5.060		86.0	52.0	549 5.060	652 5.060	8.700		125.0	81.0	549 8.700	
5.100		86.0	52.0	549 5.100	652 5.100	8.730	11/32	125.0	81.0	549 8.730	652 8.730
5.110		86.0	52.0	549 5.110	652 5.110	8.750		125.0	81.0	549 8.750	
5.150		86.0	52.0	549 5.150		8.800		125.0	81.0	549 8.800	652 8.800
5.160	13/64	86.0	52.0	549 5.160	652 5.160	8.840		125.0	81.0	549 8.840	652 8.840
5.180		86.0	52.0	549 5.180	652 5.180	8.900		125.0	81.0	549 8.900	652 8.900
5.200		86.0	52.0	549 5.200	652 5.200	8.970		125.0	81.0	549 8.970	
5.220		86.0	52.0	549 5.220	652 5.220	9.000		125.0	81.0	549 9.000	652 9.000
5.250		86.0	52.0	549 5.250		9.090		125.0	81.0	549 9.090	
5.300		86.0	52.0	549 5.300	652 5.300	9.100		125.0	81.0	549 9.100	652 9.100
5.310		93.0	57.0	549 5.310	652 5.310	9.130	23/64	125.0	81.0	549 9.130	652 9.130
5.350		93.0	57.0	549 5.350		9.200		125.0	81.0	549 9.200	652 9.200
5.400		93.0	57.0	549 5.400	652 5.400	9.250		125.0	81.0	549 9.250	
5.410		93.0	57.0	549 5.410	652 5.410	9.300		125.0	81.0	549 9.300	652 9.300
5.450		93.0	57.0	549 5.450		9.340		125.0	81.0	549 9.340	652 9.340
5.500		93.0	57.0	549 5.500	652 5.500	9.350		125.0	81.0	549 9.350	
5.550		93.0	57.0	549 5.550		9.400		125.0	81.0	549 9.400	652 9.400
5.560	7/32	93.0	57.0	549 5.560	652 5.560	9.500		125.0	81.0	549 9.500	652 9.500
5.600		93.0	57.0	549 5.600	652 5.600	9.520	3/8	133.0	87.0	549 9.520	652 9.520
5.610		93.0	57.0	549 5.610	652 5.610	9.580		133.0	87.0	549 9.580	
5.650		93.0	57.0	549 5.650		9.600		133.0	87.0	549 9.600	652 9.600
5.700		93.0	57.0	549 5.700	652 5.700	9.700		133.0	87.0	549 9.700	652 9.700
5.750		93.0	57.0	549 5.750	652 5.750	9.750		133.0	87.0	549 9.750	
5.790		93.0	57.0	549 5.790	652 5.790	9.800		133.0	87.0	549 9.800	652 9.800
5.800		93.0	57.0	549 5.800	652 5.800	9.900		133.0	87.0	549 9.900	652 9.900
5.850		93.0	57.0	549 5.850		9.920	25/64	133.0	87.0	549 9.920	652 9.920



Article no.				549	652	Article no.				549	652
d1 mm	inch	l1 mm	l2 mm	Order no.		d1 mm	inch	l1 mm	l2 mm	Order no.	
10.000		133.0	87.0	549 10.000	652 10.000	12.500		151.0	101.0	549 12.500	652 12.500
10.080		133.0	87.0	549 10.080		12.700	1/2	151.0	101.0	549 12.700	652 12.700
10.100		133.0	87.0	549 10.100		12.750		151.0	101.0	549 12.750	
10.200		133.0	87.0	549 10.200	652 10.200	12.800		151.0	101.0	549 12.800	
10.260		133.0	87.0	549 10.260		12.900		151.0	101.0	549 12.900	
10.300		133.0	87.0	549 10.300	652 10.300	13.000		151.0	101.0	549 13.000	652 13.000
10.320	13/32	133.0	87.0	549 10.320	652 10.320	13.100	33/64	151.0	101.0	549 13.100	652 13.100
10.400		133.0	87.0	549 10.400		13.200		151.0	101.0	549 13.200	
10.490		133.0	87.0	549 10.490		13.490	17/32	160.0	108.0	549 13.490	652 13.490
10.500		133.0	87.0	549 10.500	652 10.500	13.500		160.0	108.0	549 13.500	
10.600		133.0	87.0	549 10.600		13.600		160.0	108.0	549 13.600	
10.700		142.0	94.0	549 10.700	652 10.700	13.700		160.0	108.0	549 13.700	
10.720	27/64	142.0	94.0	549 10.720	652 10.720	13.890	35/64	160.0	108.0	549 13.890	652 13.890
10.750		142.0	94.0	549 10.750		14.000		160.0	108.0	549 14.000	652 14.000
10.800		142.0	94.0	549 10.800		14.250		169.0	114.0	549 14.250	
10.900		142.0	94.0	549 10.900		14.290	9/16	169.0	114.0	549 14.290	652 14.290
11.000		142.0	94.0	549 11.000	652 11.000	14.300		169.0	114.0	549 14.300	
11.100		142.0	94.0	549 11.100		14.500		169.0	114.0	549 14.500	
11.110	7/16	142.0	94.0	549 11.110	652 11.110	14.680	37/64	169.0	114.0	549 14.680	
11.200		142.0	94.0	549 11.200	652 11.200	15.000		169.0	114.0	549 15.000	652 15.000
11.300		142.0	94.0	549 11.300		15.080	19/32	178.0	120.0	549 15.080	
11.400		142.0	94.0	549 11.400		15.400		178.0	120.0	549 15.400	
11.500		142.0	94.0	549 11.500	652 11.500	15.480	39/64	178.0	120.0	549 15.480	
11.510	29/64	142.0	94.0	549 11.510	652 11.510	15.500		178.0	120.0	549 15.500	
11.600		142.0	94.0	549 11.600	652 11.600	15.750		178.0	120.0	549 15.750	
11.700		142.0	94.0	549 11.700	652 11.700	15.870	5/8	178.0	120.0	549 15.870	
11.750		142.0	94.0	549 11.750		16.000		178.0	120.0	549 16.000	652 16.000
11.800		142.0	94.0	549 11.800							
11.900		151.0	101.0	549 11.900							
11.910	15/32	151.0	101.0	549 11.910	652 11.910						
12.000		151.0	101.0	549 12.000	652 12.000						
12.100		151.0	101.0	549 12.100	652 12.100						
12.150		151.0	101.0	549 12.150							
12.200		151.0	101.0	549 12.200	652 12.200						
12.300	31/64	151.0	101.0	549 12.300	652 12.300						
12.400		151.0	101.0	549 12.400							

HSS/HSCO drills



Jobber drills

Article no. **550**



Cutting data page 452



Web thinning $\geq \varnothing 1.000$ • relieved cone • wide flutes • especially for drilling depths over 3xD

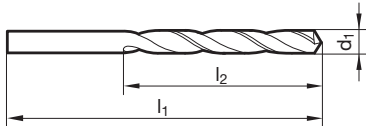

Article no.				550				Article no.				550			
d1 mm	inch	l1 mm	l2 mm	Order no.	d1 mm	inch	l1 mm	l2 mm	Order no.	d1 mm	inch	l1 mm	l2 mm	Order no.	
1.000		34.0	12.0	550 1.000	3.600		70.0	39.0	550 3.600						
1.300		38.0	16.0	550 1.300	3.650		70.0	39.0	550 3.650						
1.320		38.0	16.0	550 1.320	3.660		70.0	39.0	550 3.660						
1.350		40.0	18.0	550 1.350	3.700		70.0	39.0	550 3.700						
1.400		40.0	18.0	550 1.400	3.750		70.0	39.0	550 3.750						
1.450		40.0	18.0	550 1.450	3.800		75.0	43.0	550 3.800						
1.485		40.0	18.0	550 1.485	3.860		75.0	43.0	550 3.860						
1.500		40.0	18.0	550 1.500	3.900		75.0	43.0	550 3.900						
1.550		43.0	20.0	550 1.550	3.970	5/32	75.0	43.0	550 3.970						
1.580		43.0	20.0	550 1.580	4.000		75.0	43.0	550 4.000						
1.590	1/16	43.0	20.0	550 1.590	4.040		75.0	43.0	550 4.040						
1.600		43.0	20.0	550 1.600	4.100		75.0	43.0	550 4.100						
1.650		43.0	20.0	550 1.650	4.200		75.0	43.0	550 4.200						
1.700		43.0	20.0	550 1.700	4.300		80.0	47.0	550 4.300						
1.780		46.0	22.0	550 1.780	4.370	11/64	80.0	47.0	550 4.370						
1.800		46.0	22.0	550 1.800	4.450		80.0	47.0	550 4.450						
1.850		46.0	22.0	550 1.850	4.500		80.0	47.0	550 4.500						
1.900		46.0	22.0	550 1.900	4.600		80.0	47.0	550 4.600						
1.950		49.0	24.0	550 1.950	4.620		80.0	47.0	550 4.620						
1.980	5/64	49.0	24.0	550 1.980	4.760	3/16	86.0	52.0	550 4.760						
2.000		49.0	24.0	550 2.000	4.900		86.0	52.0	550 4.900						
2.030		49.0	24.0	550 2.030	5.000		86.0	52.0	550 5.000						
2.050		49.0	24.0	550 2.050	5.100		86.0	52.0	550 5.100						
2.080		49.0	24.0	550 2.080	5.200		86.0	52.0	550 5.200						
2.100		49.0	24.0	550 2.100	5.300		86.0	52.0	550 5.300						
2.150		53.0	27.0	550 2.150	5.400		93.0	57.0	550 5.400						
2.200		53.0	27.0	550 2.200	5.500		93.0	57.0	550 5.500						
2.250		53.0	27.0	550 2.250	5.560	7/32	93.0	57.0	550 5.560						
2.260		53.0	27.0	550 2.260	5.600		93.0	57.0	550 5.600						
2.300		53.0	27.0	550 2.300	5.700		93.0	57.0	550 5.700						
2.350		53.0	27.0	550 2.350	5.750		93.0	57.0	550 5.750						
2.370		57.0	30.0	550 2.370	5.790		93.0	57.0	550 5.790						
2.380	3/32	57.0	30.0	550 2.380	5.800		93.0	57.0	550 5.800						
2.400		57.0	30.0	550 2.400	5.900		93.0	57.0	550 5.900						
2.490		57.0	30.0	550 2.490	5.950	15/64	93.0	57.0	550 5.950						
2.500		57.0	30.0	550 2.500	6.000		93.0	57.0	550 6.000						
2.530		57.0	30.0	550 2.530	6.050		101.0	63.0	550 6.050						
2.550		57.0	30.0	550 2.550	6.100		101.0	63.0	550 6.100						
2.580		57.0	30.0	550 2.580	6.200		101.0	63.0	550 6.200						
2.600		57.0	30.0	550 2.600	6.350	1/4	101.0	63.0	550 6.350						
2.670		61.0	33.0	550 2.670	6.500		101.0	63.0	550 6.500						
2.700		61.0	33.0	550 2.700	6.600		101.0	63.0	550 6.600						
2.750		61.0	33.0	550 2.750	6.750	17/64	109.0	69.0	550 6.750						
2.780	7/64	61.0	33.0	550 2.780	6.800		109.0	69.0	550 6.800						
2.790		61.0	33.0	550 2.790	6.900		109.0	69.0	550 6.900						
2.800		61.0	33.0	550 2.800	7.000		109.0	69.0	550 7.000						
2.870		61.0	33.0	550 2.870	7.140	9/32	109.0	69.0	550 7.140						
2.900		61.0	33.0	550 2.900	7.200		109.0	69.0	550 7.200						
2.950		61.0	33.0	550 2.950	7.300		109.0	69.0	550 7.300						
3.000		61.0	33.0	550 3.000	7.400		109.0	69.0	550 7.400						
3.020		65.0	36.0	550 3.020	7.500		109.0	69.0	550 7.500						
3.050		65.0	36.0	550 3.050	7.540	19/64	117.0	75.0	550 7.540						
3.100		65.0	36.0	550 3.100	7.700		117.0	75.0	550 7.700						
3.150		65.0	36.0	550 3.150	7.800		117.0	75.0	550 7.800						
3.170	1/8	65.0	36.0	550 3.170	7.900		117.0	75.0	550 7.900						
3.175	1/8	65.0	36.0	550 3.175	7.940	5/16	117.0	75.0	550 7.940						
3.200		65.0	36.0	550 3.200	8.000		117.0	75.0	550 8.000						
3.250		65.0	36.0	550 3.250	8.100		117.0	75.0	550 8.100						
3.260		65.0	36.0	550 3.260	8.200		117.0	75.0	550 8.200						
3.300		65.0	36.0	550 3.300	8.300		117.0	75.0	550 8.300						
3.350		65.0	36.0	550 3.350	8.330	21/64	117.0	75.0	550 8.330						
3.400		70.0	39.0	550 3.400	8.400		117.0	75.0	550 8.400						
3.450		70.0	39.0	550 3.450	8.500		117.0	75.0	550 8.500						
3.500		70.0	39.0	550 3.500	8.700		125.0	81.0	550 8.700						
3.550		70.0	39.0	550 3.550	8.730	11/32	125.0	81.0	550 8.730						
3.570	9/64	70.0	39.0	550 3.570	8.800		125.0	81.0	550 8.800						



Article no.				550	Article no.				550
d1 mm	inch	l1 mm	l2 mm	Order no.	d1 mm	inch	l1 mm	l2 mm	Order no.
8.900		125.0	81.0	550 8.900	11.110	7/16	142.0	94.0	550 11.110
9.000		125.0	81.0	550 9.000	11.900		151.0	101.0	550 11.900
9.130	23/64	125.0	81.0	550 9.130	12.400		151.0	101.0	550 12.400
9.400		125.0	81.0	550 9.400	12.700	1/2	151.0	101.0	550 12.700
9.520	3/8	133.0	87.0	550 9.520	12.800		151.0	101.0	550 12.800
9.600		133.0	87.0	550 9.600	15.000		169.0	114.0	550 15.000
9.700		133.0	87.0	550 9.700	15.500		178.0	120.0	550 15.500
9.800		133.0	87.0	550 9.800					
10.000		133.0	87.0	550 10.000					
10.200		133.0	87.0	550 10.200					
10.600		133.0	87.0	550 10.600					
10.800		142.0	94.0	550 10.800					

HSS/HSCO drills



HSS/HSCO drills with straight shank

HSS/HSCO drills

Jobber drills

Article no. **305**



Cutting data page 442



Web thinning $\geq \varnothing 1.000$ • relieved cone • Co-alloyed high speed steel • increased wear resistance

Jobber drills

Article no. **2997**



Cutting data page 442

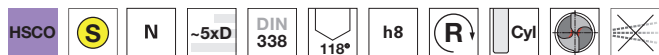

Web thinning $\geq \varnothing 1.000$ • relieved cone • Co-alloyed high speed steel • increased wear resistance

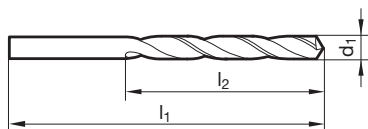

Article no.

305

2997

Article no.

305

2997

d1 mm	inch	l1 mm	l2 mm	Order no.	d1 mm	inch	l1 mm	l2 mm	Order no.
0.200		19.0	2.5	305 0.200	0.810		30.0	10.0	305 0.810
0.220		19.0	2.5	305 0.220	0.820		30.0	10.0	305 0.820
0.250		19.0	3.0	305 0.250	0.830		30.0	10.0	305 0.830
0.260		19.0	3.0	305 0.260	0.840		30.0	10.0	305 0.840
0.270		19.0	3.0	305 0.270	0.850		30.0	10.0	305 0.850
0.280		19.0	3.0	305 0.280	0.860		32.0	11.0	305 0.860
0.300		19.0	3.0	305 0.300	0.870		32.0	11.0	305 0.870
0.310		19.0	4.0	305 0.310	0.880		32.0	11.0	305 0.880
0.320		19.0	4.0	305 0.320	0.890		32.0	11.0	305 0.890
0.330		19.0	4.0	305 0.330	0.900		32.0	11.0	305 0.900
0.340		19.0	4.0	305 0.340	0.910		32.0	11.0	305 0.910
0.350		19.0	4.0	305 0.350	0.920		32.0	11.0	305 0.920
0.370		19.0	4.0	305 0.370	0.930		32.0	11.0	305 0.930
0.380		19.0	4.0	305 0.380	0.940		32.0	11.0	305 0.940
0.390		20.0	5.0	305 0.390	0.950		32.0	11.0	305 0.950
0.400	1/64	20.0	5.0	305 0.400	0.960		34.0	12.0	305 0.960
0.410		20.0	5.0	305 0.410	0.970		34.0	12.0	305 0.970
0.420		20.0	5.0	305 0.420	0.980		34.0	12.0	305 0.980
0.430		20.0	5.0	305 0.430	0.990		34.0	12.0	305 0.990
0.440		20.0	5.0	305 0.440	1.000		34.0	12.0	305 1.000
0.450		20.0	5.0	305 0.450	1.010		34.0	12.0	305 1.010
0.460		20.0	5.0	305 0.460	1.020		34.0	12.0	305 1.020
0.470		20.0	5.0	305 0.470	1.030		34.0	12.0	305 1.030
0.480		20.0	5.0	305 0.480	1.040		34.0	12.0	305 1.040
0.490		22.0	6.0	305 0.490	1.050		34.0	12.0	305 1.050
0.500		22.0	6.0	305 0.500	1.070		36.0	14.0	305 1.070
0.510		22.0	6.0	305 0.510	1.080		36.0	14.0	305 1.080
0.520		22.0	6.0	305 0.520	1.090		36.0	14.0	305 1.090
0.530		22.0	6.0	305 0.530	1.100		36.0	14.0	305 1.100
0.540		24.0	7.0	305 0.540	1.120		36.0	14.0	305 1.120
0.550		24.0	7.0	305 0.550	1.130		36.0	14.0	305 1.130
0.560		24.0	7.0	305 0.560	1.140		36.0	14.0	305 1.140
0.570		24.0	7.0	305 0.570	1.150		36.0	14.0	305 1.150
0.580		24.0	7.0	305 0.580	1.160		36.0	14.0	305 1.160
0.590		24.0	7.0	305 0.590	1.170		36.0	14.0	305 1.170
0.600		24.0	7.0	305 0.600	1.180		36.0	14.0	305 1.180
0.610		26.0	8.0	305 0.610	1.190	3/64	38.0	16.0	305 1.190
0.620		26.0	8.0	305 0.620	1.200		38.0	16.0	305 1.200 2997 1.200
0.640		26.0	8.0	305 0.640	1.210		38.0	16.0	305 1.210
0.650		26.0	8.0	305 0.650	1.220		38.0	16.0	305 1.220
0.660		26.0	8.0	305 0.660	1.230		38.0	16.0	305 1.230
0.670		26.0	8.0	305 0.670	1.250		38.0	16.0	305 1.250
0.680		28.0	9.0	305 0.680	1.260		38.0	16.0	305 1.260
0.700		28.0	9.0	305 0.700	1.280		38.0	16.0	305 1.280
0.710		28.0	9.0	305 0.710	1.290		38.0	16.0	305 1.290
0.720		28.0	9.0	305 0.720	1.300		38.0	16.0	305 1.300 2997 1.300
0.730		28.0	9.0	305 0.730	1.310		38.0	16.0	305 1.310
0.740		28.0	9.0	305 0.740	1.320		38.0	16.0	305 1.320
0.750		28.0	9.0	305 0.750	1.330		40.0	18.0	305 1.330
0.760		30.0	10.0	305 0.760	1.350		40.0	18.0	305 1.350
0.770		30.0	10.0	305 0.770	1.360		40.0	18.0	305 1.360
0.780		30.0	10.0	305 0.780	1.370		40.0	18.0	305 1.370
0.790	1/32	30.0	10.0	305 0.790	1.380		40.0	18.0	305 1.380
0.800		30.0	10.0	305 0.800	1.400		40.0	18.0	305 1.400 2997 1.400



Article no.				305	2997	Article no.				305	2997
d1 mm	inch	l1 mm	l2 mm	Order no.		d1 mm	inch	l1 mm	l2 mm	Order no.	
1.410		40.0	18.0	305 1.410		2.640		57.0	30.0	305 2.640	
1.420		40.0	18.0	305 1.420		2.650		57.0	30.0	305 2.650	
1.430		40.0	18.0	305 1.430		2.700		61.0	33.0	305 2.700	2997 2.700
1.440		40.0	18.0	305 1.440		2.710		61.0	33.0	305 2.710	
1.450		40.0	18.0	305 1.450		2.750		61.0	33.0	305 2.750	
1.460		40.0	18.0	305 1.460		2.780	7/64	61.0	33.0	305 2.780	
1.470		40.0	18.0	305 1.470		2.790		61.0	33.0	305 2.790	
1.480		40.0	18.0	305 1.480		2.800		61.0	33.0	305 2.800	2997 2.800
1.490		40.0	18.0	305 1.490		2.820		61.0	33.0	305 2.820	
1.500		40.0	18.0	305 1.500	2997 1.500	2.850		61.0	33.0	305 2.850	
1.510		43.0	20.0	305 1.510		2.870		61.0	33.0	305 2.870	
1.520		43.0	20.0	305 1.520		2.900		61.0	33.0	305 2.900	2997 2.900
1.530		43.0	20.0	305 1.530		2.920		61.0	33.0	305 2.920	
1.550		43.0	20.0	305 1.550		2.950		61.0	33.0	305 2.950	
1.560		43.0	20.0	305 1.560		3.000		61.0	33.0	305 3.000	2997 3.000
1.570		43.0	20.0	305 1.570		3.020		65.0	36.0	305 3.020	
1.580		43.0	20.0	305 1.580		3.030		65.0	36.0	305 3.030	
1.590	1/16	43.0	20.0	305 1.590		3.050		65.0	36.0	305 3.050	
1.600		43.0	20.0	305 1.600	2997 1.600	3.100		65.0	36.0	305 3.100	
1.610		43.0	20.0	305 1.610		3.150		65.0	36.0	305 3.150	
1.620		43.0	20.0	305 1.620		3.170	1/8	65.0	36.0	305 3.170	
1.640		43.0	20.0	305 1.640		3.200		65.0	36.0	305 3.200	
1.650		43.0	20.0	305 1.650		3.250		65.0	36.0	305 3.250	
1.660		43.0	20.0	305 1.660		3.260		65.0	36.0	305 3.260	
1.670		43.0	20.0	305 1.670		3.300		65.0	36.0	305 3.300	2997 3.300
1.680		43.0	20.0	305 1.680		3.330		65.0	36.0	305 3.330	
1.700		43.0	20.0	305 1.700		3.350		65.0	36.0	305 3.350	
1.710		46.0	22.0	305 1.710		3.400		70.0	39.0	305 3.400	2997 3.400
1.720		46.0	22.0	305 1.720		3.450		70.0	39.0	305 3.450	
1.730		46.0	22.0	305 1.730		3.500		70.0	39.0	305 3.500	2997 3.500
1.740		46.0	22.0	305 1.740		3.550		70.0	39.0	305 3.550	
1.750		46.0	22.0	305 1.750		3.570	9/64	70.0	39.0	305 3.570	
1.760		46.0	22.0	305 1.760		3.600		70.0	39.0	305 3.600	2997 3.600
1.780		46.0	22.0	305 1.780		3.650		70.0	39.0	305 3.650	
1.790		46.0	22.0	305 1.790		3.660		70.0	39.0	305 3.660	
1.800		46.0	22.0	305 1.800	2997 1.800	3.700		70.0	39.0	305 3.700	2997 3.700
1.810		46.0	22.0	305 1.810		3.730		70.0	39.0	305 3.730	
1.820		46.0	22.0	305 1.820		3.750		70.0	39.0	305 3.750	
1.830		46.0	22.0	305 1.830		3.800		75.0	43.0	305 3.800	2997 3.800
1.840		46.0	22.0	305 1.840		3.850		75.0	43.0	305 3.850	
1.850		46.0	22.0	305 1.850		3.860		75.0	43.0	305 3.860	
1.860		46.0	22.0	305 1.860		3.900		75.0	43.0	305 3.900	2997 3.900
1.900		46.0	22.0	305 1.900	2997 1.900	3.910		75.0	43.0	305 3.910	
1.910		49.0	24.0	305 1.910		3.970	5/32	75.0	43.0	305 3.970	
1.930		49.0	24.0	305 1.930		3.990		75.0	43.0	305 3.990	
1.950		49.0	24.0	305 1.950		4.000		75.0	43.0	305 4.000	2997 4.000
1.960		49.0	24.0	305 1.960		4.020		75.0	43.0	305 4.020	
1.970		49.0	24.0	305 1.970		4.040		75.0	43.0	305 4.040	
1.980	5/64	49.0	24.0	305 1.980		4.050		75.0	43.0	305 4.050	
1.990		49.0	24.0	305 1.990		4.070		75.0	43.0	305 4.070	
2.000		49.0	24.0	305 2.000	2997 2.000	4.090		75.0	43.0	305 4.090	
2.010		49.0	24.0	305 2.010		4.100		75.0	43.0	305 4.100	2997 4.100
2.020		49.0	24.0	305 2.020		4.120		75.0	43.0	305 4.120	
2.030		49.0	24.0	305 2.030		4.150		75.0	43.0	305 4.150	
2.040		49.0	24.0	305 2.040		4.170		75.0	43.0	305 4.170	
2.050		49.0	24.0	305 2.050		4.200		75.0	43.0	305 4.200	2997 4.200
2.060		49.0	24.0	305 2.060		4.220		75.0	43.0	305 4.220	
2.070		49.0	24.0	305 2.070		4.250		75.0	43.0	305 4.250	
2.080		49.0	24.0	305 2.080		4.300		80.0	47.0	305 4.300	2997 4.300
2.100		49.0	24.0	305 2.100	2997 2.100	4.370	11/64	80.0	47.0	305 4.370	
2.120		49.0	24.0	305 2.120		4.390		80.0	47.0	305 4.390	
2.150		53.0	27.0	305 2.150		4.400		80.0	47.0	305 4.400	2997 4.400
2.180		53.0	27.0	305 2.180		4.450		80.0	47.0	305 4.450	
2.200		53.0	27.0	305 2.200	2997 2.200	4.500		80.0	47.0	305 4.500	2997 4.500
2.230		53.0	27.0	305 2.230		4.550		80.0	47.0	305 4.550	
2.250		53.0	27.0	305 2.250		4.570		80.0	47.0	305 4.570	
2.260		53.0	27.0	305 2.260		4.600		80.0	47.0	305 4.600	
2.300		53.0	27.0	305 2.300	2997 2.300	4.620		80.0	47.0	305 4.620	
2.320		53.0	27.0	305 2.320		4.650		80.0	47.0	305 4.650	
2.350		53.0	27.0	305 2.350		4.700		80.0	47.0	305 4.700	2997 4.700
2.370		57.0	30.0	305 2.370		4.750		80.0	47.0	305 4.750	
2.380	3/32	57.0	30.0	305 2.380		4.760	3/16	86.0	52.0	305 4.760	
2.400		57.0	30.0	305 2.400	2997 2.400	4.800		86.0	52.0	305 4.800	2997 4.800
2.440		57.0	30.0	305 2.440		4.850		86.0	52.0	305 4.850	
2.450		57.0	30.0	305 2.450		4.900		86.0	52.0	305 4.900	2997 4.900
2.470		57.0	30.0	305 2.470		4.920		86.0	52.0	305 4.920	
2.490		57.0	30.0	305 2.490		4.980		86.0	52.0	305 4.980	
2.500		57.0	30.0	305 2.500	2997 2.500	5.000		86.0	52.0	305 5.000	2997 5.000
2.510		57.0	30.0	305 2.510		5.020		86.0	52.0	305 5.020	
2.520		57.0	30.0	305 2.520		5.050		86.0	52.0	305 5.050	
2.530		57.0	30.0	305 2.530		5.060		86.0	52.0	305 5.060	
2.550		57.0	30.0	305 2.550		5.100		86.0	52.0	305 5.100	
2.580		57.0	30.0	305 2.580		5.110		86.0	52.0	305 5.110	
2.600		57.0	30.0	305 2.600	2997 2.600	5.150		86.0	52.0	305 5.150	

HSS/HSCO drills



HSS/HSCO drills with straight shank

HSS/HSCO drills

Article no.				305	2997	Article no.				305	2997
d1 mm	inch	l1 mm	l2 mm	Order no.		d1 mm	inch	l1 mm	l2 mm	Order no.	
5.160	13/64	86.0	52.0	305 5.160		9.000		125.0	81.0	305 9.000	2997 9.000
5.180		86.0	52.0	305 5.180		9.090		125.0	81.0	305 9.090	
5.200		86.0	52.0	305 5.200	2997 5.200	9.100		125.0	81.0	305 9.100	
5.220		86.0	52.0	305 5.220		9.130	23/64	125.0	81.0	305 9.130	
5.250		86.0	52.0	305 5.250		9.200		125.0	81.0	305 9.200	
5.300		86.0	52.0	305 5.300	2997 5.300	9.250		125.0	81.0	305 9.250	
5.310		93.0	57.0	305 5.310		9.300		125.0	81.0	305 9.300	
5.400		93.0	57.0	305 5.400	2997 5.400	9.340		125.0	81.0	305 9.340	
5.410		93.0	57.0	305 5.410		9.400		125.0	81.0	305 9.400	2997 9.400
5.500		93.0	57.0	305 5.500	2997 5.500	9.500		125.0	81.0	305 9.500	2997 9.500
5.550		93.0	57.0	305 5.550		9.520	3/8	133.0	87.0	305 9.520	
5.560	7/32	93.0	57.0	305 5.560		9.580		133.0	87.0	305 9.580	
5.600		93.0	57.0	305 5.600	2997 5.600	9.600		133.0	87.0	305 9.600	2997 9.600
5.610		93.0	57.0	305 5.610		9.700		133.0	87.0	305 9.700	2997 9.700
5.650		93.0	57.0	305 5.650		9.750		133.0	87.0	305 9.750	
5.700		93.0	57.0	305 5.700		9.800		133.0	87.0	305 9.800	2997 9.800
5.750		93.0	57.0	305 5.750		9.900		133.0	87.0	305 9.900	
5.790		93.0	57.0	305 5.790		9.920	25/64	133.0	87.0	305 9.920	
5.800		93.0	57.0	305 5.800	2997 5.800	9.950		133.0	87.0	305 9.950	
5.900		93.0	57.0	305 5.900	2997 5.900	10.000		133.0	87.0	305 10.000	2997 10.000
5.940		93.0	57.0	305 5.940		10.050		133.0	87.0	305 10.050	
5.950	15/64	93.0	57.0	305 5.950		10.080		133.0	87.0	305 10.080	
6.000		93.0	57.0	305 6.000	2997 6.000	10.100		133.0	87.0	305 10.100	
6.040		101.0	63.0	305 6.040		10.200		133.0	87.0	305 10.200	
6.050		101.0	63.0	305 6.050		10.250		133.0	87.0	305 10.250	
6.100		101.0	63.0	305 6.100	2997 6.100	10.260		133.0	87.0	305 10.260	
6.150		101.0	63.0	305 6.150		10.300		133.0	87.0	305 10.300	
6.200		101.0	63.0	305 6.200	2997 6.200	10.320	13/32	133.0	87.0	305 10.320	
6.250		101.0	63.0	305 6.250		10.400		133.0	87.0	305 10.400	
6.300		101.0	63.0	305 6.300		10.490		133.0	87.0	305 10.490	
6.350	1/4	101.0	63.0	305 6.350		10.500		133.0	87.0	305 10.500	2997 10.500
6.400		101.0	63.0	305 6.400	2997 6.400	10.600		133.0	87.0	305 10.600	
6.450		101.0	63.0	305 6.450		10.700		142.0	94.0	305 10.700	
6.500		101.0	63.0	305 6.500	2997 6.500	10.720	27/64	142.0	94.0	305 10.720	
6.530		101.0	63.0	305 6.530		10.750		142.0	94.0	305 10.750	
6.600		101.0	63.0	305 6.600		10.800		142.0	94.0	305 10.800	2997 10.800
6.630		101.0	63.0	305 6.630		10.900		142.0	94.0	305 10.900	
6.700		101.0	63.0	305 6.700	2997 6.700	11.000		142.0	94.0	305 11.000	2997 11.000
6.750	17/64	109.0	69.0	305 6.750		11.100		142.0	94.0	305 11.100	
6.800		109.0	69.0	305 6.800	2997 6.800	11.110	7/16	142.0	94.0	305 11.110	
6.850		109.0	69.0	305 6.850		11.200		142.0	94.0	305 11.200	2997 11.200
6.900		109.0	69.0	305 6.900	2997 6.900	11.250		142.0	94.0	305 11.250	
6.950		109.0	69.0	305 6.950		11.300		142.0	94.0	305 11.300	
7.000		109.0	69.0	305 7.000	2997 7.000	11.400		142.0	94.0	305 11.400	
7.030		109.0	69.0	305 7.030		11.500		142.0	94.0	305 11.500	2997 11.500
7.050		109.0	69.0	305 7.050		11.510	29/64	142.0	94.0	305 11.510	
7.100		109.0	69.0	305 7.100	2997 7.100	11.600		142.0	94.0	305 11.600	
7.140	9/32	109.0	69.0	305 7.140		11.700		142.0	94.0	305 11.700	
7.200		109.0	69.0	305 7.200	2997 7.200	11.750		142.0	94.0	305 11.750	
7.250		109.0	69.0	305 7.250		11.800		142.0	94.0	305 11.800	
7.300		109.0	69.0	305 7.300	2997 7.300	11.900		151.0	101.0	305 11.900	
7.370		109.0	69.0	305 7.370		11.910	15/32	151.0	101.0	305 11.910	
7.400		109.0	69.0	305 7.400	2997 7.400	12.000		151.0	101.0	305 12.000	2997 12.000
7.490		109.0	69.0	305 7.490		12.100		151.0	101.0	305 12.100	
7.500		109.0	69.0	305 7.500	2997 7.500	12.200		151.0	101.0	305 12.200	
7.540	19/64	117.0	75.0	305 7.540		12.250		151.0	101.0	305 12.250	
7.600		117.0	75.0	305 7.600	2997 7.600	12.300	31/64	151.0	101.0	305 12.300	
7.670		117.0	75.0	305 7.670		12.400		151.0	101.0	305 12.400	
7.700		117.0	75.0	305 7.700		12.500		151.0	101.0	305 12.500	2997 12.500
7.750		117.0	75.0	305 7.750		12.600		151.0	101.0	305 12.600	
7.800		117.0	75.0	305 7.800	2997 7.800	12.700	1/2	151.0	101.0	305 12.700	2997 12.700
7.900		117.0	75.0	305 7.900	2997 7.900	12.750		151.0	101.0	305 12.750	
7.940	5/16	117.0	75.0	305 7.940		12.800		151.0	101.0	305 12.800	
8.000		117.0	75.0	305 8.000	2997 8.000	12.900		151.0	101.0	305 12.900	
8.030		117.0	75.0	305 8.030		13.000		151.0	101.0	305 13.000	2997 13.000
8.050		117.0	75.0	305 8.050		13.100	33/64	151.0	101.0	305 13.100	
8.100		117.0	75.0	305 8.100	2997 8.100	13.200		151.0	101.0	305 13.200	
8.150		117.0	75.0	305 8.150		13.300		160.0	108.0	305 13.300	
8.200		117.0	75.0	305 8.200	2997 8.200	13.490	17/32	160.0	108.0	305 13.490	
8.250		117.0	75.0	305 8.250		13.500		160.0	108.0	305 13.500	
8.300		117.0	75.0	305 8.300		13.600		160.0	108.0	305 13.600	
8.330	21/64	117.0	75.0	305 8.330		13.700		160.0	108.0	305 13.700	
8.400		117.0	75.0	305 8.400		13.750		160.0	108.0	305 13.750	
8.430		117.0	75.0	305 8.430		13.800		160.0	108.0	305 13.800	
8.500		117.0	75.0	305 8.500	2997 8.500	13.890	35/64	160.0	108.0	305 13.890	
8.550		125.0	81.0	305 8.550		13.900		160.0	108.0	305 13.900	
8.600		125.0	81.0	305 8.600		14.000		160.0	108.0	305 14.000	
8.610		125.0	81.0	305 8.610		14.100		169.0	114.0	305 14.100	
8.700		125.0	81.0	305 8.700		14.200		169.0	114.0	305 14.200	
8.730	11/32	125.0	81.0	305 8.730		14.290	9/16	169.0	114.0	305 14.290	
8.750		125.0	81.0	305 8.750		14.400		169.0	114.0	305 14.400	
8.800		125.0	81.0	305 8.800	2997 8.800	14.500		169.0	114.0	305 14.500	
8.840		125.0	81.0	305 8.840		14.680	37/64	169.0	114.0	305 14.680	
8.900		125.0	81.0	305 8.900	2997 8.900	14.700		169.0	114.0	305 14.700	



Article no.				305	2997	Article no.				305	2997
d1 mm	inch	l1 mm	l2 mm	Order no.		d1 mm	inch	l1 mm	l2 mm	Order no.	
15.000		169.0	114.0	305	15.000	17.500		191.0	130.0	305	17.500
15.250		178.0	120.0	305	15.250	18.000		191.0	130.0	305	18.000
15.300		178.0	120.0	305	15.300	18.500		198.0	135.0	305	18.500
15.480	39/64	178.0	120.0	305	15.480	19.000		198.0	135.0	305	19.000
15.500		178.0	120.0	305	15.500	19.500		205.0	140.0	305	19.500
15.750		178.0	120.0	305	15.750	19.840	25/32	205.0	140.0	305	19.840
15.870	5/8	178.0	120.0	305	15.870	20.000		205.0	140.0	305	20.000
16.000		178.0	120.0	305	16.000						
16.500		184.0	125.0	305	16.500						
16.670	21/32	184.0	125.0	305	16.670						
17.000		184.0	125.0	305	17.000						
17.460	11/16	191.0	130.0	305	17.460						

HSS/HSCO drills



HSS/HSCO drills with straight shank

HSS/HSCO drills

Jobber drills

Article no. 308



Cutting data page 442



Web thinning $\geq \varnothing 2.370$ • relieved cone • Co-alloyed high speed steel • increased wear resistance

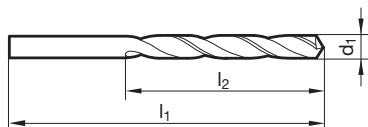

Article no.				308				Article no.				308			
d1 mm	inch	l1 mm	l2 mm	Order no.	d1 mm	inch	l1 mm	l2 mm	Order no.	d1 mm	inch	l1 mm	l2 mm	Order no.	
0.500		22.0	6.0	308 0.500	3.970	5/32	75.0	43.0	308 3.970						
0.560		24.0	7.0	308 0.560	3.990		75.0	43.0	308 3.990						
0.600		24.0	7.0	308 0.600	4.000		75.0	43.0	308 4.000						
0.750		28.0	9.0	308 0.750	4.040		75.0	43.0	308 4.040						
0.780		30.0	10.0	308 0.780	4.050		75.0	43.0	308 4.050						
0.800		30.0	10.0	308 0.800	4.090		75.0	43.0	308 4.090						
0.910		32.0	11.0	308 0.910	4.200		75.0	43.0	308 4.200						
0.980		34.0	12.0	308 0.980	4.220		75.0	43.0	308 4.220						
1.000		34.0	12.0	308 1.000	4.300		80.0	47.0	308 4.300						
1.030		34.0	12.0	308 1.030	4.350		80.0	47.0	308 4.350						
1.100		36.0	14.0	308 1.100	4.370	11/64	80.0	47.0	308 4.370						
1.190	3/64	38.0	16.0	308 1.190	4.390		80.0	47.0	308 4.390						
1.200		38.0	16.0	308 1.200	4.400		80.0	47.0	308 4.400						
1.300		38.0	16.0	308 1.300	4.500		80.0	47.0	308 4.500						
1.320		38.0	16.0	308 1.320	4.620		80.0	47.0	308 4.620						
1.350		40.0	18.0	308 1.350	4.650		80.0	47.0	308 4.650						
1.400		40.0	18.0	308 1.400	4.700		80.0	47.0	308 4.700						
1.430		40.0	18.0	308 1.430	4.760	3/16	86.0	52.0	308 4.760						
1.450		40.0	18.0	308 1.450	4.800		86.0	52.0	308 4.800						
1.470		40.0	18.0	308 1.470	4.900		86.0	52.0	308 4.900						
1.480		40.0	18.0	308 1.480	5.000		86.0	52.0	308 5.000						
1.490		40.0	18.0	308 1.490	5.060		86.0	52.0	308 5.060						
1.510		43.0	20.0	308 1.510	5.110		86.0	52.0	308 5.110						
1.600		43.0	20.0	308 1.600	5.160	13/64	86.0	52.0	308 5.160						
1.620		43.0	20.0	308 1.620	5.180		86.0	52.0	308 5.180						
1.700		43.0	20.0	308 1.700	5.200		86.0	52.0	308 5.200						
1.720		46.0	22.0	308 1.720	5.300		86.0	52.0	308 5.300						
1.750		46.0	22.0	308 1.750	5.400		93.0	57.0	308 5.400						
1.780		46.0	22.0	308 1.780	5.410		93.0	57.0	308 5.410						
1.800		46.0	22.0	308 1.800	5.550		93.0	57.0	308 5.550						
1.830		46.0	22.0	308 1.830	5.560	7/32	93.0	57.0	308 5.560						
1.850		46.0	22.0	308 1.850	5.600		93.0	57.0	308 5.600						
1.900		46.0	22.0	308 1.900	5.610		93.0	57.0	308 5.610						
1.930		49.0	24.0	308 1.930	5.700		93.0	57.0	308 5.700						
1.950		49.0	24.0	308 1.950	5.800		93.0	57.0	308 5.800						
1.980	5/64	49.0	24.0	308 1.980	5.900		93.0	57.0	308 5.900						
2.000		49.0	24.0	308 2.000	5.950	15/64	93.0	57.0	308 5.950						
2.060		49.0	24.0	308 2.060	6.000		93.0	57.0	308 6.000						
2.100		49.0	24.0	308 2.100	6.100		101.0	63.0	308 6.100						
2.200		53.0	27.0	308 2.200	6.250		101.0	63.0	308 6.250						
2.250		53.0	27.0	308 2.250	6.350	1/4	101.0	63.0	308 6.350						
2.260		53.0	27.0	308 2.260	6.700		101.0	63.0	308 6.700						
2.350		53.0	27.0	308 2.350	7.370		109.0	69.0	308 7.370						
2.380	3/32	57.0	30.0	308 2.380	7.400		109.0	69.0	308 7.400						
2.400		57.0	30.0	308 2.400	7.490		109.0	69.0	308 7.490						
2.500		57.0	30.0	308 2.500	7.500		109.0	69.0	308 7.500						
2.530		57.0	30.0	308 2.530	7.540	19/64	117.0	75.0	308 7.540						
2.600		57.0	30.0	308 2.600	8.000		117.0	75.0	308 8.000						
2.640		57.0	30.0	308 2.640	8.030		117.0	75.0	308 8.030						
2.780	7/64	61.0	33.0	308 2.780	8.330	21/64	117.0	75.0	308 8.330						
2.800		61.0	33.0	308 2.800	8.500		117.0	75.0	308 8.500						
2.950		61.0	33.0	308 2.950	8.600		125.0	81.0	308 8.600						
3.000		61.0	33.0	308 3.000	8.700		125.0	81.0	308 8.700						
3.100		65.0	36.0	308 3.100	8.730	11/32	125.0	81.0	308 8.730						
3.150		65.0	36.0	308 3.150	8.900		125.0	81.0	308 8.900						
3.170	1/8	65.0	36.0	308 3.170	9.000		125.0	81.0	308 9.000						
3.200		65.0	36.0	308 3.200	9.090		125.0	81.0	308 9.090						
3.300		65.0	36.0	308 3.300	9.100		125.0	81.0	308 9.100						
3.400		70.0	39.0	308 3.400	9.130	23/64	125.0	81.0	308 9.130						
3.450		70.0	39.0	308 3.450	9.200		125.0	81.0	308 9.200						
3.500		70.0	39.0	308 3.500	9.300		125.0	81.0	308 9.300						
3.600		70.0	39.0	308 3.600	9.340		125.0	81.0	308 9.340						
3.650		70.0	39.0	308 3.650	9.500		125.0	81.0	308 9.500						
3.700		70.0	39.0	308 3.700	9.520	3/8	133.0	87.0	308 9.520						
3.800		75.0	43.0	308 3.800	9.800		133.0	87.0	308 9.800						
3.900		75.0	43.0	308 3.900	9.900		133.0	87.0	308 9.900						



Article no.				308	Article no.				308
d1 mm	inch	l1 mm	l2 mm	Order no.	d1 mm	inch	l1 mm	l2 mm	Order no.
9.920	25/64	133.0	87.0	308 9.920	12.500		151.0	101.0	308 12.500
10.000		133.0	87.0	308 10.000	12.700	1/2	151.0	101.0	308 12.700
10.320	13/32	133.0	87.0	308 10.320	14.300		169.0	114.0	308 14.300
10.490		133.0	87.0	308 10.490	14.500		169.0	114.0	308 14.500
10.800		142.0	94.0	308 10.800	16.200		184.0	125.0	308 16.200
11.110	7/16	142.0	94.0	308 11.110	16.500		184.0	125.0	308 16.500
11.200		142.0	94.0	308 11.200	18.000		191.0	130.0	308 18.000
11.500		142.0	94.0	308 11.500					
11.510	29/64	142.0	94.0	308 11.510					
11.910	15/32	151.0	101.0	308 11.910					
12.050		151.0	101.0	308 12.050					
12.250		151.0	101.0	308 12.250					

HSS/HSCO drills



HSS/HSCO drills with straight shank

HSS/HSCO drills

Jobber drills

Article no. **622**



Cutting data page 452



P	M	K	N	S	H
●	●	●	○	○	○

Web thinning $\geq \varnothing 1.000$ • relieved cone • Co-alloyed high speed steel • wide flutes • increased wear resistance
 • especially for drilling depths over 3xD

Jobber drills

Article no. **658**



Cutting data page 452

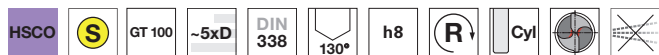

P	M	K	N	S	H
●	●	●	○	○	○

Web thinning $\geq \varnothing 1.000$ • relieved cone • Co-alloyed high speed steel • wide flutes • increased wear resistance
 • especially for drilling depths over 3xD

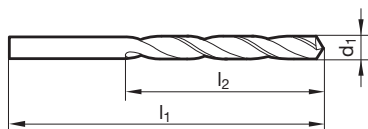

Article no.

622

658

Article no.

622

658

d1 mm	inch	l1 mm	l2 mm	Order no.		d1 mm	inch	l1 mm	l2 mm	Order no.	
1.000		34.0	12.0	622 1.000	658 1.000	2.400		57.0	30.0	622 2.400	658 2.400
1.020		34.0	12.0	622 1.020	658 1.020	2.420		57.0	30.0	622 2.420	
1.040		34.0	12.0	622 1.040		2.440		57.0	30.0	622 2.440	658 2.440
1.050		34.0	12.0	622 1.050	658 1.050	2.450		57.0	30.0	622 2.450	658 2.450
1.070		36.0	14.0	622 1.070	658 1.070	2.490		57.0	30.0	622 2.490	658 2.490
1.090		36.0	14.0	622 1.090		2.500		57.0	30.0	622 2.500	658 2.500
1.100		36.0	14.0	622 1.100	658 1.100	2.530		57.0	30.0	622 2.530	658 2.530
1.130		36.0	14.0	622 1.130	658 1.130	2.550		57.0	30.0	622 2.550	658 2.550
1.150		36.0	14.0	622 1.150	658 1.150	2.580		57.0	30.0	622 2.580	658 2.580
1.180		36.0	14.0	622 1.180		2.600		57.0	30.0	622 2.600	658 2.600
1.190	3/64	38.0	16.0	622 1.190	658 1.190	2.640		57.0	30.0	622 2.640	658 2.640
1.200		38.0	16.0	622 1.200	658 1.200	2.650		57.0	30.0	622 2.650	658 2.650
1.250		38.0	16.0	622 1.250		2.700		61.0	33.0	622 2.700	658 2.700
1.270		38.0	16.0	622 1.270		2.710		61.0	33.0	622 2.710	
1.300		38.0	16.0	622 1.300	658 1.300	2.750		61.0	33.0	622 2.750	658 2.750
1.320		38.0	16.0	622 1.320	658 1.320	2.780	7/64	61.0	33.0	622 2.780	658 2.780
1.350		40.0	18.0	622 1.350	658 1.350	2.790		61.0	33.0	622 2.790	658 2.790
1.400		40.0	18.0	622 1.400	658 1.400	2.800		61.0	33.0	622 2.800	658 2.800
1.430		40.0	18.0	622 1.430	658 1.430	2.820		61.0	33.0	622 2.820	658 2.820
1.440		40.0	18.0	622 1.440		2.850		61.0	33.0	622 2.850	
1.450		40.0	18.0	622 1.450	658 1.450	2.870		61.0	33.0	622 2.870	658 2.870
1.500		40.0	18.0	622 1.500	658 1.500	2.900		61.0	33.0	622 2.900	658 2.900
1.510		43.0	20.0	622 1.510	658 1.510	2.950		61.0	33.0	622 2.950	658 2.950
1.550		43.0	20.0	622 1.550	658 1.550	3.000		61.0	33.0	622 3.000	658 3.000
1.590	1/16	43.0	20.0	622 1.590	658 1.590	3.050		65.0	36.0	622 3.050	658 3.050
1.600		43.0	20.0	622 1.600	658 1.600	3.100		65.0	36.0	622 3.100	658 3.100
1.610		43.0	20.0	622 1.610	658 1.610	3.150		65.0	36.0	622 3.150	
1.630		43.0	20.0		658 1.630	3.170	1/8	65.0	36.0	622 3.170	658 3.170
1.650		43.0	20.0	622 1.650	658 1.650	3.200		65.0	36.0	622 3.200	658 3.200
1.700		43.0	20.0	622 1.700	658 1.700	3.250		65.0	36.0	622 3.250	658 3.250
1.780		46.0	22.0	622 1.780	658 1.780	3.260		65.0	36.0	622 3.260	658 3.260
1.800		46.0	22.0	622 1.800	658 1.800	3.300		65.0	36.0	622 3.300	658 3.300
1.850		46.0	22.0	622 1.850	658 1.850	3.400		70.0	39.0	622 3.400	658 3.400
1.900		46.0	22.0	622 1.900	658 1.900	3.450		70.0	39.0	622 3.450	658 3.450
1.920		49.0	24.0	622 1.920		3.500		70.0	39.0	622 3.500	658 3.500
1.930		49.0	24.0	622 1.930	658 1.930	3.570	9/64	70.0	39.0	622 3.570	658 3.570
1.950		49.0	24.0	622 1.950	658 1.950	3.600		70.0	39.0	622 3.600	658 3.600
1.960		49.0	24.0	622 1.960		3.650		70.0	39.0	622 3.650	
1.980	5/64	49.0	24.0	622 1.980	658 1.980	3.660		70.0	39.0	622 3.660	658 3.660
1.990		49.0	24.0	622 1.990	658 1.990	3.700		70.0	39.0	622 3.700	658 3.700
2.000		49.0	24.0	622 2.000	658 2.000	3.730		70.0	39.0	622 3.730	658 3.730
2.050		49.0	24.0	622 2.050	658 2.050	3.750		70.0	39.0		658 3.750
2.060		49.0	24.0	622 2.060	658 2.060	3.800		75.0	43.0	622 3.800	658 3.800
2.080		49.0	24.0	622 2.080	658 2.080	3.860		75.0	43.0	622 3.860	658 3.860
2.100		49.0	24.0	622 2.100	658 2.100	3.900		75.0	43.0	622 3.900	658 3.900
2.150		53.0	27.0	622 2.150	658 2.150	3.910		75.0	43.0	622 3.910	
2.180		53.0	27.0	622 2.180	658 2.180	3.970	5/32	75.0	43.0	622 3.970	658 3.970
2.200		53.0	27.0	622 2.200	658 2.200	3.990		75.0	43.0	622 3.990	
2.250		53.0	27.0	622 2.250	658 2.250	4.000		75.0	43.0	622 4.000	658 4.000
2.260		53.0	27.0	622 2.260	658 2.260	4.020		75.0	43.0	622 4.020	
2.300		53.0	27.0	622 2.300	658 2.300	4.030		75.0	43.0		658 4.030
2.350		53.0	27.0	622 2.350	658 2.350	4.040		75.0	43.0	622 4.040	658 4.040
2.370		57.0	30.0	622 2.370	658 2.370	4.050		75.0	43.0	622 4.050	658 4.050
2.380	3/32	57.0	30.0	622 2.380	658 2.380	4.090		75.0	43.0	622 4.090	658 4.090



Article no.				622	658	Article no.				622	658
d1 mm	inch	l1 mm	l2 mm	Order no.		d1 mm	inch	l1 mm	l2 mm	Order no.	
4.100		75.0	43.0	622 4.100	658 4.100	7.900		117.0	75.0	622 7.900	658 7.900
4.150		75.0	43.0	622 4.150		7.940	5/16	117.0	75.0	622 7.940	658 7.940
4.200		75.0	43.0	622 4.200	658 4.200	8.000		117.0	75.0	622 8.000	658 8.000
4.220		75.0	43.0	622 4.220	658 4.220	8.030		117.0	75.0	622 8.030	
4.250		75.0	43.0	622 4.250	658 4.250	8.100		117.0	75.0	622 8.100	658 8.100
4.300		80.0	47.0	622 4.300	658 4.300	8.200		117.0	75.0	622 8.200	658 8.200
4.370	11/64	80.0	47.0	622 4.370	658 4.370	8.300		117.0	75.0	622 8.300	658 8.300
4.390		80.0	47.0	622 4.390		8.330	21/64	117.0	75.0	622 8.330	
4.400		80.0	47.0	622 4.400	658 4.400	8.400		117.0	75.0	622 8.400	658 8.400
4.500		80.0	47.0	622 4.500	658 4.500	8.430		117.0	75.0	622 8.430	
4.550		80.0	47.0	622 4.550		8.500		117.0	75.0	622 8.500	658 8.500
4.570		80.0	47.0	622 4.570	658 4.570	8.600		125.0	81.0	622 8.600	658 8.600
4.600		80.0	47.0	622 4.600	658 4.600	8.610		125.0	81.0	622 8.610	
4.620		80.0	47.0	622 4.620	658 4.620	8.700		125.0	81.0	622 8.700	658 8.700
4.650		80.0	47.0	622 4.650		8.730	11/32	125.0	81.0	622 8.730	658 8.730
4.700		80.0	47.0	622 4.700	658 4.700	8.750		125.0	81.0		658 8.750
4.750		80.0	47.0	622 4.750		8.800		125.0	81.0	622 8.800	658 8.800
4.760	3/16	86.0	52.0	622 4.760	658 4.760	8.840		125.0	81.0	622 8.840	
4.800		86.0	52.0	622 4.800	658 4.800	8.900		125.0	81.0	622 8.900	658 8.900
4.850		86.0	52.0	622 4.850	658 4.850	9.000		125.0	81.0	622 9.000	658 9.000
4.900		86.0	52.0	622 4.900	658 4.900	9.090		125.0	81.0	622 9.090	
4.920		86.0	52.0	622 4.920	658 4.920	9.100		125.0	81.0	622 9.100	658 9.100
4.980		86.0	52.0	622 4.980	658 4.980	9.130	23/64	125.0	81.0	622 9.130	658 9.130
5.000		86.0	52.0	622 5.000	658 5.000	9.200		125.0	81.0	622 9.200	658 9.200
5.060		86.0	52.0	622 5.060	658 5.060	9.300		125.0	81.0	622 9.300	658 9.300
5.100		86.0	52.0	622 5.100	658 5.100	9.340		125.0	81.0	622 9.340	
5.110		86.0	52.0	622 5.110		9.400		125.0	81.0	622 9.400	658 9.400
5.160	13/64	86.0	52.0	622 5.160	658 5.160	9.500		125.0	81.0	622 9.500	658 9.500
5.180		86.0	52.0	622 5.180		9.520	3/8	133.0	87.0	622 9.520	658 9.520
5.200		86.0	52.0	622 5.200	658 5.200	9.580		133.0	87.0	622 9.580	
5.220		86.0	52.0	622 5.220		9.600		133.0	87.0	622 9.600	658 9.600
5.250		86.0	52.0	622 5.250		9.700		133.0	87.0	622 9.700	658 9.700
5.300		86.0	52.0	622 5.300	658 5.300	9.800		133.0	87.0	622 9.800	658 9.800
5.310		93.0	57.0	622 5.310		9.900		133.0	87.0	622 9.900	658 9.900
5.400		93.0	57.0	622 5.400	658 5.400	9.920	25/64	133.0	87.0	622 9.920	658 9.920
5.410		93.0	57.0	622 5.410		10.000		133.0	87.0	622 10.000	658 10.000
5.500		93.0	57.0	622 5.500	658 5.500	10.080		133.0	87.0	622 10.080	
5.560	7/32	93.0	57.0	622 5.560	658 5.560	10.100		133.0	87.0	622 10.100	658 10.100
5.600		93.0	57.0	622 5.600	658 5.600	10.200		133.0	87.0	622 10.200	658 10.200
5.610		93.0	57.0	622 5.610	658 5.610	10.250		133.0	87.0	622 10.250	
5.700		93.0	57.0	622 5.700	658 5.700	10.260		133.0	87.0	622 10.260	
5.750		93.0	57.0	622 5.750		10.300		133.0	87.0	622 10.300	658 10.300
5.790		93.0	57.0	622 5.790		10.320	13/32	133.0	87.0	622 10.320	658 10.320
5.800		93.0	57.0	622 5.800	658 5.800	10.400		133.0	87.0	622 10.400	658 10.400
5.850		93.0	57.0		658 5.850	10.500		133.0	87.0	622 10.500	658 10.500
5.900		93.0	57.0	622 5.900	658 5.900	10.600		133.0	87.0	622 10.600	
5.940		93.0	57.0	622 5.940		10.700		142.0	94.0	622 10.700	
5.950	15/64	93.0	57.0	622 5.950	658 5.950	10.720	27/64	142.0	94.0	622 10.720	658 10.720
6.000		93.0	57.0	622 6.000	658 6.000	10.800		142.0	94.0	622 10.800	658 10.800
6.040		101.0	63.0	622 6.040		10.900		142.0	94.0	622 10.900	
6.050		101.0	63.0	622 6.050		11.000		142.0	94.0	622 11.000	658 11.000
6.100		101.0	63.0	622 6.100	658 6.100	11.100		142.0	94.0	622 11.100	
6.150		101.0	63.0	622 6.150	658 6.150	11.110	7/16	142.0	94.0	622 11.110	658 11.110
6.200		101.0	63.0	622 6.200	658 6.200	11.200		142.0	94.0	622 11.200	658 11.200
6.250		101.0	63.0	622 6.250		11.300		142.0	94.0	622 11.300	
6.300		101.0	63.0	622 6.300	658 6.300	11.400		142.0	94.0	622 11.400	
6.350	1/4	101.0	63.0	622 6.350	658 6.350	11.500		142.0	94.0	622 11.500	658 11.500
6.400		101.0	63.0	622 6.400	658 6.400	11.510	29/64	142.0	94.0	622 11.510	
6.500		101.0	63.0	622 6.500	658 6.500	11.600		142.0	94.0	622 11.600	
6.530		101.0	63.0	622 6.530	658 6.530	11.700		142.0	94.0	622 11.700	658 11.700
6.600		101.0	63.0	622 6.600	658 6.600	11.800		142.0	94.0	622 11.800	658 11.800
6.630		101.0	63.0	622 6.630		11.910	15/32	151.0	101.0	622 11.910	658 11.910
6.650		101.0	63.0	622 6.650		12.000		151.0	101.0	622 12.000	658 12.000
6.700		101.0	63.0	622 6.700	658 6.700	12.500		151.0	101.0	622 12.500	658 12.500
6.750	17/64	109.0	69.0	622 6.750	658 6.750	12.700	1/2	151.0	101.0	622 12.700	
6.800		109.0	69.0	622 6.800	658 6.800	12.800		151.0	101.0		658 12.800
6.900		109.0	69.0	622 6.900	658 6.900	13.000		151.0	101.0	622 13.000	658 13.000
7.000		109.0	69.0	622 7.000	658 7.000	13.500		160.0	108.0	622 13.500	658 13.500
7.030		109.0	69.0	622 7.030		13.800		160.0	108.0	622 13.800	658 13.800
7.100		109.0	69.0	622 7.100	658 7.100	14.000		160.0	108.0	622 14.000	658 14.000
7.140	9/32	109.0	69.0	622 7.140	658 7.140	14.500		169.0	114.0	622 14.500	658 14.500
7.200		109.0	69.0	622 7.200	658 7.200	15.000		169.0	114.0	622 15.000	658 15.000
7.300		109.0	69.0	622 7.300	658 7.300	15.500		178.0	120.0	622 15.500	
7.370		109.0	69.0	622 7.370		16.000		178.0	120.0	622 16.000	658 16.000
7.400		109.0	69.0	622 7.400	658 7.400						
7.450		109.0	69.0	622 7.450							
7.490		109.0	69.0	622 7.490							
7.500		109.0	69.0	622 7.500	658 7.500						
7.540	19/64	117.0	75.0	622 7.540							
7.600		117.0	75.0	622 7.600	658 7.600						
7.670		117.0	75.0	622 7.670							
7.700		117.0	75.0	622 7.700	658 7.700						
7.750		117.0	75.0	622 7.750							
7.800		117.0	75.0	622 7.800	658 7.800						



HSS/HSCO drills with straight shank

HSS/HSCO drills

Jobber drills

Article no. **2459**



Cutting data page 453

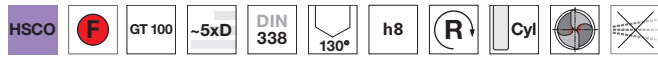

P	M	K	N	S	H
●	●	●	○	○	○

Web thinning $\geq \varnothing 1.000$ • relieved cone • Co-alloyed high speed steel • wide flutes • increased wear resistance
 • especially for drilling depths over 3xD

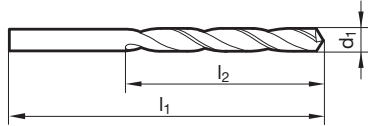

Article no. 2459				Article no. 2459					
d1 mm	inch	l1 mm	l2 mm	Order no.	d1 mm	inch	l1 mm	l2 mm	Order no.
1.000		34.0	12.0	2459 1.000	5.800		93.0	57.0	2459 5.800
1.100		36.0	14.0	2459 1.100	5.900		93.0	57.0	2459 5.900
1.200		38.0	16.0	2459 1.200	6.000		93.0	57.0	2459 6.000
1.300		38.0	16.0	2459 1.300	6.100		101.0	63.0	2459 6.100
1.400		40.0	18.0	2459 1.400	6.200		101.0	63.0	2459 6.200
1.500		40.0	18.0	2459 1.500	6.300		101.0	63.0	2459 6.300
1.600		43.0	20.0	2459 1.600	6.350	1/4	101.0	63.0	2459 6.350
1.700		43.0	20.0	2459 1.700	6.400		101.0	63.0	2459 6.400
1.800		46.0	22.0	2459 1.800	6.500		101.0	63.0	2459 6.500
1.900		46.0	22.0	2459 1.900	6.600		101.0	63.0	2459 6.600
2.000		49.0	24.0	2459 2.000	6.700		101.0	63.0	2459 6.700
2.100		49.0	24.0	2459 2.100	6.800		109.0	69.0	2459 6.800
2.200		53.0	27.0	2459 2.200	6.900		109.0	69.0	2459 6.900
2.300		53.0	27.0	2459 2.300	7.000		109.0	69.0	2459 7.000
2.400		57.0	30.0	2459 2.400	7.100		109.0	69.0	2459 7.100
2.500		57.0	30.0	2459 2.500	7.300		109.0	69.0	2459 7.300
2.600		57.0	30.0	2459 2.600	7.400		109.0	69.0	2459 7.400
2.700		61.0	33.0	2459 2.700	7.500		109.0	69.0	2459 7.500
2.800		61.0	33.0	2459 2.800	7.600		117.0	75.0	2459 7.600
2.900		61.0	33.0	2459 2.900	7.700		117.0	75.0	2459 7.700
3.000		61.0	33.0	2459 3.000	7.800		117.0	75.0	2459 7.800
3.050		65.0	36.0	2459 3.050	7.900		117.0	75.0	2459 7.900
3.100		65.0	36.0	2459 3.100	7.940	5/16	117.0	75.0	2459 7.940
3.170	1/8	65.0	36.0	2459 3.170	8.000		117.0	75.0	2459 8.000
3.200		65.0	36.0	2459 3.200	8.100		117.0	75.0	2459 8.100
3.300		65.0	36.0	2459 3.300	8.200		117.0	75.0	2459 8.200
3.400		70.0	39.0	2459 3.400	8.300		117.0	75.0	2459 8.300
3.450		70.0	39.0	2459 3.450	8.400		117.0	75.0	2459 8.400
3.500		70.0	39.0	2459 3.500	8.500		117.0	75.0	2459 8.500
3.600		70.0	39.0	2459 3.600	8.600		125.0	81.0	2459 8.600
3.660		70.0	39.0	2459 3.660	8.700		125.0	81.0	2459 8.700
3.700		70.0	39.0	2459 3.700	8.800		125.0	81.0	2459 8.800
3.750		70.0	39.0	2459 3.750	8.900		125.0	81.0	2459 8.900
3.800		75.0	43.0	2459 3.800	9.000		125.0	81.0	2459 9.000
3.900		75.0	43.0	2459 3.900	9.100		125.0	81.0	2459 9.100
3.970	5/32	75.0	43.0	2459 3.970	9.130	23/64	125.0	81.0	2459 9.130
4.000		75.0	43.0	2459 4.000	9.200		125.0	81.0	2459 9.200
4.040		75.0	43.0	2459 4.040	9.400		125.0	81.0	2459 9.400
4.100		75.0	43.0	2459 4.100	9.500		125.0	81.0	2459 9.500
4.200		75.0	43.0	2459 4.200	9.600		133.0	87.0	2459 9.600
4.300		80.0	47.0	2459 4.300	9.700		133.0	87.0	2459 9.700
4.370	11/64	80.0	47.0	2459 4.370	9.800		133.0	87.0	2459 9.800
4.400		80.0	47.0	2459 4.400	9.900		133.0	87.0	2459 9.900
4.500		80.0	47.0	2459 4.500	10.000		133.0	87.0	2459 10.000
4.600		80.0	47.0	2459 4.600	10.200		133.0	87.0	2459 10.200
4.700		80.0	47.0	2459 4.700	10.300		133.0	87.0	2459 10.300
4.760	3/16	86.0	52.0	2459 4.760	10.400		133.0	87.0	2459 10.400
4.800		86.0	52.0	2459 4.800	10.500		133.0	87.0	2459 10.500
4.900		86.0	52.0	2459 4.900	10.720	27/64	142.0	94.0	2459 10.720
4.920		86.0	52.0	2459 4.920	11.000		142.0	94.0	2459 11.000
5.000		86.0	52.0	2459 5.000	11.500		142.0	94.0	2459 11.500
5.100		86.0	52.0	2459 5.100	12.000		151.0	101.0	2459 12.000
5.160	13/64	86.0	52.0	2459 5.160	12.500		151.0	101.0	2459 12.500
5.200		86.0	52.0	2459 5.200	13.000		151.0	101.0	2459 13.000
5.300		86.0	52.0	2459 5.300	14.000		160.0	108.0	2459 14.000
5.400		93.0	57.0	2459 5.400	15.000		169.0	114.0	2459 15.000
5.500		93.0	57.0	2459 5.500					
5.560	7/32	93.0	57.0	2459 5.560					
5.600		93.0	57.0	2459 5.600					
5.700		93.0	57.0	2459 5.700					

Jobber drills

 Article no. **605**

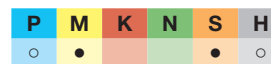
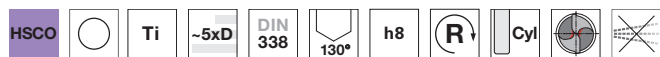

Cutting data page 454

 Web thinning $\geq \varnothing 0.970$ • relieved cone • Co-alloyed high speed steel • increased wear resistance

Jobber drills

 Article no. **657**

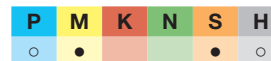
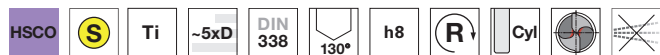
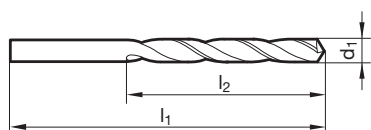
Cutting data page 454

 Web thinning $\geq \varnothing 1.000$ • relieved cone • Co-alloyed high speed steel • increased wear resistance

Article no. 605				Article no. 657				Article no. 605				Article no. 657			
d1 mm	inch	l1 mm	l2 mm	Order no.				d1 mm	inch	l1 mm	l2 mm	Order no.			
0.200		19.0	2.5	605 0.200				1.080		36.0	14.0	605 1.080			
0.300		19.0	3.0	605 0.300				1.090		36.0	14.0	605 1.090			
0.310		19.0	4.0	605 0.310				1.100		36.0	14.0	605 1.100		657 1.100	
0.320		19.0	4.0	605 0.320				1.140		36.0	14.0	605 1.140			
0.330		19.0	4.0	605 0.330				1.150		36.0	14.0	605 1.150		657 1.150	
0.340		19.0	4.0	605 0.340				1.180		36.0	14.0	605 1.180		657 1.180	
0.370		19.0	4.0	605 0.370				1.190	3/64	38.0	16.0	605 1.190		657 1.190	
0.380		19.0	4.0	605 0.380				1.200		38.0	16.0	605 1.200		657 1.200	
0.400	1/64	20.0	5.0	605 0.400				1.210		38.0	16.0	605 1.210			
0.410		20.0	5.0	605 0.410				1.230		38.0	16.0	605 1.230			
0.440		20.0	5.0	605 0.440				1.250		38.0	16.0	605 1.250		657 1.250	
0.450		20.0	5.0	605 0.450				1.290		38.0	16.0	605 1.290			
0.460		20.0	5.0	605 0.460				1.300		38.0	16.0	605 1.300		657 1.300	
0.500		22.0	6.0	605 0.500		657 0.500		1.320		38.0	16.0	605 1.320		657 1.320	
0.510		22.0	6.0	605 0.510				1.350		40.0	18.0	605 1.350			
0.530		22.0	6.0	605 0.530		657 0.530		1.390		40.0	18.0	605 1.390			
0.550		24.0	7.0	605 0.550				1.400		40.0	18.0	605 1.400		657 1.400	
0.570		24.0	7.0	605 0.570				1.450		40.0	18.0	605 1.450		657 1.450	
0.580		24.0	7.0	605 0.580				1.460		40.0	18.0	605 1.460			
0.600		24.0	7.0	605 0.600				1.500		40.0	18.0	605 1.500		657 1.500	
0.610		26.0	8.0	605 0.610				1.510		43.0	20.0	605 1.510		657 1.510	
0.640		26.0	8.0	605 0.640				1.520		43.0	20.0	605 1.520		657 1.520	
0.650		26.0	8.0	605 0.650		657 0.650		1.530		43.0	20.0	605 1.530			
0.660		26.0	8.0	605 0.660				1.550		43.0	20.0	605 1.550		657 1.550	
0.700		28.0	9.0	605 0.700		657 0.700		1.570		43.0	20.0	605 1.570			
0.710		28.0	9.0	605 0.710				1.590	1/16	43.0	20.0	605 1.590		657 1.590	
0.720		28.0	9.0	605 0.720				1.600		43.0	20.0	605 1.600			
0.740		28.0	9.0	605 0.740				1.610		43.0	20.0	605 1.610		657 1.610	
0.750		28.0	9.0	605 0.750		657 0.750		1.620		43.0	20.0	605 1.620		657 1.620	
0.760		30.0	10.0	605 0.760				1.650		43.0	20.0	605 1.650			
0.790	1/32	30.0	10.0	605 0.790				1.680		43.0	20.0	605 1.680			
0.800		30.0	10.0	605 0.800		657 0.800		1.700		43.0	20.0	605 1.700		657 1.700	
0.810		30.0	10.0	605 0.810				1.730		46.0	22.0	605 1.730			
0.820		30.0	10.0	605 0.820				1.750		46.0	22.0	605 1.750		657 1.750	
0.830		30.0	10.0	605 0.830				1.780		46.0	22.0	605 1.780		657 1.780	
0.840		30.0	10.0	605 0.840				1.800		46.0	22.0	605 1.800			
0.850		30.0	10.0	605 0.850		657 0.850		1.820		46.0	22.0	605 1.820			
0.860		32.0	11.0	605 0.860				1.850		46.0	22.0	605 1.850		657 1.850	
0.870		32.0	11.0	605 0.870				1.900		46.0	22.0	605 1.900		657 1.900	
0.880		32.0	11.0	605 0.880		657 0.880		1.930		49.0	24.0	605 1.930			
0.890		32.0	11.0	605 0.890				1.950		49.0	24.0	605 1.950		657 1.950	
0.900		32.0	11.0	605 0.900		657 0.900		1.970		49.0	24.0	605 1.970			
0.910		32.0	11.0	605 0.910				1.980	5/64	49.0	24.0	605 1.980		657 1.980	
0.920		32.0	11.0	605 0.920		657 0.920		1.990		49.0	24.0	605 1.990			
0.940		32.0	11.0	605 0.940		657 0.940		2.000		49.0	24.0	605 2.000		657 2.000	
0.950		32.0	11.0	605 0.950		657 0.950		2.020		49.0	24.0	605 2.020			
0.970		34.0	12.0	605 0.970				2.030		49.0	24.0	605 2.030			
0.980		34.0	12.0	605 0.980				2.050		49.0	24.0	605 2.050		657 2.050	
0.990		34.0	12.0	605 0.990				2.060		49.0	24.0	605 2.060			
1.000		34.0	12.0	605 1.000		657 1.000		2.080		49.0	24.0	605 2.080			
1.020		34.0	12.0	605 1.020				2.100		49.0	24.0	605 2.100		657 2.100	
1.040		34.0	12.0	605 1.040		657 1.040		2.120		49.0	24.0	605 2.120			
1.050		34.0	12.0	605 1.050		657 1.050		2.150		53.0	27.0	605 2.150		657 2.150	
1.070		36.0	14.0	605 1.070				2.180		53.0	27.0	605 2.180			



HSS/HSCO drills with straight shank

HSS/HSCO drills

Article no.				605	657	Article no.				605	657
d1 mm	inch	l1 mm	l2 mm	Order no.		d1 mm	inch	l1 mm	l2 mm	Order no.	
2.200		53.0	27.0	605 2.200	657 2.200	4.900		86.0	52.0	605 4.900	657 4.900
2.250		53.0	27.0	605 2.250	657 2.250	4.920		86.0	52.0	605 4.920	
2.260		53.0	27.0	605 2.260	657 2.260	4.980		86.0	52.0	605 4.980	
2.300		53.0	27.0	605 2.300	657 2.300	5.000		86.0	52.0	605 5.000	657 5.000
2.320		53.0	27.0	605 2.320		5.050		86.0	52.0	605 5.050	657 5.050
2.350		53.0	27.0	605 2.350	657 2.350	5.100		86.0	52.0	605 5.100	657 5.100
2.370		57.0	30.0	605 2.370		5.110		86.0	52.0	605 5.110	657 5.110
2.380	3/32	57.0	30.0	605 2.380	657 2.380	5.160	13/64	86.0	52.0	605 5.160	657 5.160
2.400		57.0	30.0	605 2.400	657 2.400	5.180		86.0	52.0	605 5.180	
2.440		57.0	30.0	605 2.440	657 2.440	5.200		86.0	52.0	605 5.200	657 5.200
2.450		57.0	30.0	605 2.450		5.220		86.0	52.0	605 5.220	
2.500		57.0	30.0	605 2.500	657 2.500	5.250		86.0	52.0	605 5.250	
2.520		57.0	30.0	605 2.520		5.300		86.0	52.0	605 5.300	657 5.300
2.530		57.0	30.0	605 2.530	657 2.530	5.400		93.0	57.0	605 5.400	657 5.400
2.550		57.0	30.0	605 2.550	657 2.550	5.410		93.0	57.0	605 5.410	
2.580		57.0	30.0	605 2.580		5.500		93.0	57.0	605 5.500	657 5.500
2.600		57.0	30.0	605 2.600	657 2.600	5.550		93.0	57.0	605 5.550	
2.640		57.0	30.0	605 2.640		5.560	7/32	93.0	57.0	605 5.560	657 5.560
2.650		57.0	30.0	605 2.650		5.600		93.0	57.0	605 5.600	657 5.600
2.700		61.0	33.0	605 2.700	657 2.700	5.610		93.0	57.0	605 5.610	657 5.610
2.710		61.0	33.0	605 2.710		5.700		93.0	57.0	605 5.700	657 5.700
2.750		61.0	33.0	605 2.750	657 2.750	5.750		93.0	57.0	605 5.750	
2.780	7/64	61.0	33.0	605 2.780	657 2.780	5.790		93.0	57.0	605 5.790	
2.790		61.0	33.0	605 2.790		5.800		93.0	57.0	605 5.800	657 5.800
2.800		61.0	33.0	605 2.800	657 2.800	5.900		93.0	57.0	605 5.900	657 5.900
2.810		61.0	33.0	605 2.810		5.940		93.0	57.0	605 5.940	
2.820		61.0	33.0	605 2.820	657 2.820	5.950	15/64	93.0	57.0	605 5.950	657 5.950
2.850		61.0	33.0	605 2.850		6.000		93.0	57.0	605 6.000	657 6.000
2.870		61.0	33.0	605 2.870		6.040		101.0	63.0	605 6.040	
2.900		61.0	33.0	605 2.900	657 2.900	6.050		101.0	63.0	605 6.050	
2.950		61.0	33.0	605 2.950	657 2.950	6.080		101.0	63.0	605 6.080	
3.000		61.0	33.0	605 3.000	657 3.000	6.100		101.0	63.0	605 6.100	657 6.100
3.030		65.0	36.0	605 3.030		6.200		101.0	63.0	605 6.200	657 6.200
3.050		65.0	36.0	605 3.050	657 3.050	6.250		101.0	63.0	605 6.250	
3.100		65.0	36.0	605 3.100	657 3.100	6.300		101.0	63.0	605 6.300	657 6.300
3.150		65.0	36.0	605 3.150	657 3.150	6.350	1/4	101.0	63.0	605 6.350	657 6.350
3.170	1/8	65.0	36.0	605 3.170	657 3.170	6.400		101.0	63.0	605 6.400	657 6.400
3.200		65.0	36.0	605 3.200	657 3.200	6.500		101.0	63.0	605 6.500	657 6.500
3.250		65.0	36.0	605 3.250	657 3.250	6.600		101.0	63.0	605 6.600	657 6.600
3.260		65.0	36.0	605 3.260	657 3.260	6.700		101.0	63.0	605 6.700	657 6.700
3.300		65.0	36.0	605 3.300	657 3.300	6.750	17/64	109.0	69.0	605 6.750	657 6.750
3.350		65.0	36.0	605 3.350	657 3.350	6.800		109.0	69.0	605 6.800	657 6.800
3.400		70.0	39.0	605 3.400	657 3.400	6.900		109.0	69.0	605 6.900	657 6.900
3.450		70.0	39.0	605 3.450		7.000		109.0	69.0	605 7.000	657 7.000
3.500		70.0	39.0	605 3.500	657 3.500	7.030		109.0	69.0	605 7.030	
3.550		70.0	39.0	605 3.550		7.100		109.0	69.0	605 7.100	657 7.100
3.570	9/64	70.0	39.0	605 3.570	657 3.570	7.140	9/32	109.0	69.0	605 7.140	657 7.140
3.600		70.0	39.0	605 3.600	657 3.600	7.200		109.0	69.0	605 7.200	657 7.200
3.650		70.0	39.0	605 3.650	657 3.650	7.300		109.0	69.0	605 7.300	657 7.300
3.660		70.0	39.0	605 3.660		7.370		109.0	69.0	605 7.370	
3.700		70.0	39.0	605 3.700	657 3.700	7.400		109.0	69.0	605 7.400	657 7.400
3.730		70.0	39.0	605 3.730		7.490		109.0	69.0	605 7.490	
3.750		70.0	39.0	605 3.750	657 3.750	7.500		109.0	69.0	605 7.500	657 7.500
3.800		75.0	43.0	605 3.800	657 3.800	7.540	19/64	117.0	75.0	605 7.540	657 7.540
3.900		75.0	43.0	605 3.900	657 3.900	7.600		117.0	75.0	605 7.600	657 7.600
3.950		75.0	43.0	605 3.950		7.670		117.0	75.0	605 7.670	
3.970	5/32	75.0	43.0	605 3.970	657 3.970	7.700		117.0	75.0	605 7.700	657 7.700
3.980		75.0	43.0	605 3.980		7.800		117.0	75.0	605 7.800	657 7.800
4.000		75.0	43.0	605 4.000	657 4.000	7.900		117.0	75.0	605 7.900	657 7.900
4.040		75.0	43.0	605 4.040		7.940	5/16	117.0	75.0	605 7.940	657 7.940
4.050		75.0	43.0	605 4.050	657 4.050	8.000		117.0	75.0	605 8.000	657 8.000
4.090		75.0	43.0	605 4.090		8.030		117.0	75.0	605 8.030	
4.100		75.0	43.0	605 4.100	657 4.100	8.100		117.0	75.0	605 8.100	657 8.100
4.150		75.0	43.0	605 4.150		8.200		117.0	75.0	605 8.200	657 8.200
4.200		75.0	43.0	605 4.200	657 4.200	8.300		117.0	75.0	605 8.300	657 8.300
4.220		75.0	43.0	605 4.220		8.330	21/64	117.0	75.0	605 8.330	
4.250		75.0	43.0	605 4.250	657 4.250	8.400		117.0	75.0	605 8.400	657 8.400
4.300		80.0	47.0	605 4.300	657 4.300	8.430		117.0	75.0	605 8.430	
4.350		80.0	47.0	605 4.350	657 4.350	8.500		117.0	75.0	605 8.500	657 8.500
4.370	11/64	80.0	47.0	605 4.370	657 4.370	8.550		125.0	81.0	605 8.550	657 8.550
4.390		80.0	47.0	605 4.390		8.600		125.0	81.0	605 8.600	657 8.600
4.400		80.0	47.0	605 4.400	657 4.400	8.700		125.0	81.0	605 8.700	657 8.700
4.450		80.0	47.0	605 4.450		8.730	11/32	125.0	81.0	605 8.730	657 8.730
4.500		80.0	47.0	605 4.500	657 4.500	8.800		125.0	81.0	605 8.800	657 8.800
4.570		80.0	47.0	605 4.570		8.840		125.0	81.0	605 8.840	
4.600		80.0	47.0	605 4.600	657 4.600	8.900		125.0	81.0	605 8.900	657 8.900
4.620		80.0	47.0	605 4.620		9.000		125.0	81.0	605 9.000	657 9.000
4.650		80.0	47.0	605 4.650		9.090		125.0	81.0	605 9.090	
4.700		80.0	47.0	605 4.700	657 4.700	9.100		125.0	81.0	605 9.100	657 9.100
4.750		80.0	47.0	605 4.750		9.130	23/64	125.0	81.0	605 9.130	657 9.130
4.760	3/16	86.0	52.0	605 4.760	657 4.760	9.200		125.0	81.0	605 9.200	657 9.200
4.790		86.0	52.0	605 4.790		9.300		125.0	81.0	605 9.300	657 9.300
4.800		86.0	52.0	605 4.800	657 4.800	9.340		125.0	81.0	605 9.340	
4.850		86.0	52.0	605 4.850		9.400		125.0	81.0	605 9.400	657 9.400



Article no.				605	657	Article no.				605	657
d1 mm	inch	l1 mm	l2 mm	Order no.		d1 mm	inch	l1 mm	l2 mm	Order no.	
9.500		125.0	81.0	605 9.500	657 9.500	11.910	15/32	151.0	101.0	605 11.910	657 11.910
9.520	3/8	133.0	87.0	605 9.520	657 9.520	12.000		151.0	101.0	605 12.000	657 12.000
9.580		133.0	87.0	605 9.580		12.100		151.0	101.0	605 12.100	657 12.100
9.600		133.0	87.0	605 9.600	657 9.600	12.200		151.0	101.0	605 12.200	
9.700		133.0	87.0	605 9.700	657 9.700	12.300	31/64	151.0	101.0	605 12.300	657 12.300
9.800		133.0	87.0	605 9.800	657 9.800	12.500		151.0	101.0	605 12.500	657 12.500
9.900		133.0	87.0	605 9.900	657 9.900	12.600		151.0	101.0	605 12.600	
9.920	25/64	133.0	87.0	605 9.920		12.700	1/2	151.0	101.0	605 12.700	657 12.700
10.000		133.0	87.0	605 10.000	657 10.000	12.800		151.0	101.0	605 12.800	
10.080		133.0	87.0	605 10.080		13.000		151.0	101.0	605 13.000	657 13.000
10.100		133.0	87.0	605 10.100	657 10.100	13.100	33/64	151.0	101.0	605 13.100	
10.200		133.0	87.0	605 10.200	657 10.200	13.500		160.0	108.0	605 13.500	657 13.500
10.260		133.0	87.0	605 10.260		13.800		160.0	108.0	605 13.800	
10.300		133.0	87.0	605 10.300	657 10.300	14.000		160.0	108.0	605 14.000	657 14.000
10.320	13/32	133.0	87.0	605 10.320	657 10.320	14.290	9/16	169.0	114.0	605 14.290	
10.400		133.0	87.0	605 10.400	657 10.400	14.500		169.0	114.0	605 14.500	657 14.500
10.490		133.0	87.0	605 10.490		14.680	37/64	169.0	114.0	605 14.680	
10.500		133.0	87.0	605 10.500	657 10.500	15.000		169.0	114.0	605 15.000	
10.600		133.0	87.0	605 10.600		15.480	39/64	178.0	120.0	605 15.480	
10.700		142.0	94.0	605 10.700	657 10.700	15.500		178.0	120.0	605 15.500	
10.720	27/64	142.0	94.0	605 10.720		15.870	5/8	178.0	120.0	605 15.870	
10.750		142.0	94.0	605 10.750		16.000		178.0	120.0	605 16.000	
10.800		142.0	94.0	605 10.800	657 10.800	16.270	41/64	184.0	125.0	605 16.270	
11.000		142.0	94.0	605 11.000	657 11.000	16.500		184.0	125.0	605 16.500	
11.100		142.0	94.0	605 11.100		16.670	21/32	184.0	125.0	605 16.670	
11.110	7/16	142.0	94.0	605 11.110	657 11.110	17.000		184.0	125.0	605 17.000	
11.200		142.0	94.0	605 11.200	657 11.200	17.070	43/64	191.0	130.0	605 17.070	
11.300		142.0	94.0	605 11.300		17.460	11/16	191.0	130.0	605 17.460	
11.400		142.0	94.0	605 11.400		17.500		191.0	130.0	605 17.500	
11.500		142.0	94.0	605 11.500	657 11.500	17.860	45/64	191.0	130.0	605 17.860	
11.510	29/64	142.0	94.0	605 11.510	657 11.510	18.000		191.0	130.0	605 18.000	
11.600		142.0	94.0	605 11.600		18.260	23/32	198.0	135.0	605 18.260	
11.700		142.0	94.0	605 11.700		18.650	47/64	198.0	135.0	605 18.650	
11.750		142.0	94.0	605 11.750	657 11.750	19.000		198.0	135.0	605 19.000	
11.800		142.0	94.0	605 11.800							
11.900		151.0	101.0	605 11.900							

HSS/HSCO drills



HSS/HSCO drills with straight shank

HSS/HSCO drills

Jobber drills

Article no. **2458**



Cutting data page 455

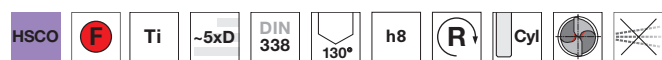

Web thinning $\geq \varnothing 1.000$ • relieved cone • Co-alloyed high speed steel • increased wear resistance

P	M	K	N	S	H
○	●	●	○	○	○

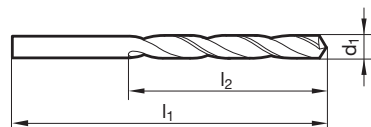

Article no. 2458				Article no. 2458					
d1	inch	l1	l2	Order no.	d1	inch	l1	l2	Order no.
mm		mm	mm		mm		mm	mm	
0.400	1/64	20.0	5.0	2458 0.400	5.400		93.0	57.0	2458 5.400
0.810		30.0	10.0	2458 0.810	5.500		93.0	57.0	2458 5.500
1.000		34.0	12.0	2458 1.000	5.560	7/32	93.0	57.0	2458 5.560
1.100		36.0	14.0	2458 1.100	5.600		93.0	57.0	2458 5.600
1.190	3/64	38.0	16.0	2458 1.190	5.700		93.0	57.0	2458 5.700
1.200		38.0	16.0	2458 1.200	5.800		93.0	57.0	2458 5.800
1.300		38.0	16.0	2458 1.300	5.900		93.0	57.0	2458 5.900
1.400		40.0	18.0	2458 1.400	6.000		93.0	57.0	2458 6.000
1.500		40.0	18.0	2458 1.500	6.100		101.0	63.0	2458 6.100
1.530		43.0	20.0	2458 1.530	6.200		101.0	63.0	2458 6.200
1.590	1/16	43.0	20.0	2458 1.590	6.300		101.0	63.0	2458 6.300
1.600		43.0	20.0	2458 1.600	6.350	1/4	101.0	63.0	2458 6.350
1.650		43.0	20.0	2458 1.650	6.400		101.0	63.0	2458 6.400
1.700		43.0	20.0	2458 1.700	6.500		101.0	63.0	2458 6.500
1.800		46.0	22.0	2458 1.800	6.600		101.0	63.0	2458 6.600
1.900		46.0	22.0	2458 1.900	6.700		101.0	63.0	2458 6.700
1.980	5/64	49.0	24.0	2458 1.980	6.750	17/64	109.0	69.0	2458 6.750
2.000		49.0	24.0	2458 2.000	6.800		109.0	69.0	2458 6.800
2.050		49.0	24.0	2458 2.050	6.900		109.0	69.0	2458 6.900
2.100		49.0	24.0	2458 2.100	7.000		109.0	69.0	2458 7.000
2.200		53.0	27.0	2458 2.200	7.100		109.0	69.0	2458 7.100
2.300		53.0	27.0	2458 2.300	7.140	9/32	109.0	69.0	2458 7.140
2.370		57.0	30.0	2458 2.370	7.200		109.0	69.0	2458 7.200
2.380	3/32	57.0	30.0	2458 2.380	7.400		109.0	69.0	2458 7.400
2.400		57.0	30.0	2458 2.400	7.500		109.0	69.0	2458 7.500
2.500		57.0	30.0	2458 2.500	7.540	19/64	117.0	75.0	2458 7.540
2.600		57.0	30.0	2458 2.600	7.600		117.0	75.0	2458 7.600
2.700		61.0	33.0	2458 2.700	7.700		117.0	75.0	2458 7.700
2.750		61.0	33.0	2458 2.750	7.800		117.0	75.0	2458 7.800
2.780	7/64	61.0	33.0	2458 2.780	7.900		117.0	75.0	2458 7.900
2.800		61.0	33.0	2458 2.800	7.940	5/16	117.0	75.0	2458 7.940
2.900		61.0	33.0	2458 2.900	8.000		117.0	75.0	2458 8.000
3.000		61.0	33.0	2458 3.000	8.100		117.0	75.0	2458 8.100
3.100		65.0	36.0	2458 3.100	8.200		117.0	75.0	2458 8.200
3.170	1/8	65.0	36.0	2458 3.170	8.300		117.0	75.0	2458 8.300
3.200		65.0	36.0	2458 3.200	8.330	21/64	117.0	75.0	2458 8.330
3.250		65.0	36.0	2458 3.250	8.400		117.0	75.0	2458 8.400
3.300		65.0	36.0	2458 3.300	8.500		117.0	75.0	2458 8.500
3.400		70.0	39.0	2458 3.400	8.600		125.0	81.0	2458 8.600
3.500		70.0	39.0	2458 3.500	8.700		125.0	81.0	2458 8.700
3.570	9/64	70.0	39.0	2458 3.570	8.730	11/32	125.0	81.0	2458 8.730
3.600		70.0	39.0	2458 3.600	8.800		125.0	81.0	2458 8.800
3.700		70.0	39.0	2458 3.700	9.000		125.0	81.0	2458 9.000
3.800		75.0	43.0	2458 3.800	9.100		125.0	81.0	2458 9.100
3.900		75.0	43.0	2458 3.900	9.200		125.0	81.0	2458 9.200
3.970	5/32	75.0	43.0	2458 3.970	9.300		125.0	81.0	2458 9.300
4.000		75.0	43.0	2458 4.000	9.400		125.0	81.0	2458 9.400
4.100		75.0	43.0	2458 4.100	9.500		125.0	81.0	2458 9.500
4.150		75.0	43.0	2458 4.150	9.520	3/8	133.0	87.0	2458 9.520
4.200		75.0	43.0	2458 4.200	9.600		133.0	87.0	2458 9.600
4.220		75.0	43.0	2458 4.220	9.700		133.0	87.0	2458 9.700
4.300		80.0	47.0	2458 4.300	9.800		133.0	87.0	2458 9.800
4.370	11/64	80.0	47.0	2458 4.370	9.900		133.0	87.0	2458 9.900
4.400		80.0	47.0	2458 4.400	9.920	25/64	133.0	87.0	2458 9.920
4.500		80.0	47.0	2458 4.500	10.000		133.0	87.0	2458 10.000
4.600		80.0	47.0	2458 4.600	10.100		133.0	87.0	2458 10.100
4.700		80.0	47.0	2458 4.700	10.200		133.0	87.0	2458 10.200
4.760	3/16	86.0	52.0	2458 4.760	10.300		133.0	87.0	2458 10.300
4.800		86.0	52.0	2458 4.800	10.320	13/32	133.0	87.0	2458 10.320
4.900		86.0	52.0	2458 4.900	10.400		133.0	87.0	2458 10.400
5.000		86.0	52.0	2458 5.000	10.500		133.0	87.0	2458 10.500
5.050		86.0	52.0	2458 5.050	10.720	27/64	142.0	94.0	2458 10.720
5.100		86.0	52.0	2458 5.100	10.800		142.0	94.0	2458 10.800
5.160	13/64	86.0	52.0	2458 5.160	11.000		142.0	94.0	2458 11.000
5.200		86.0	52.0	2458 5.200	11.110	7/16	142.0	94.0	2458 11.110
5.300		86.0	52.0	2458 5.300	11.500		142.0	94.0	2458 11.500



Article no.				2458	Article no.				2458
d1 mm	inch	l1 mm	l2 mm	Order no.	d1 mm	inch	l1 mm	l2 mm	Order no.
11.510	29/64	142.0	94.0	2458 11.510	15.000		169.0	114.0	2458 15.000
11.910	15/32	151.0	101.0	2458 11.910					
12.000		151.0	101.0	2458 12.000					
12.300	31/64	151.0	101.0	2458 12.300					
12.500		151.0	101.0	2458 12.500					
12.700	1/2	151.0	101.0	2458 12.700					
13.000		151.0	101.0	2458 13.000					
13.100	33/64	151.0	101.0	2458 13.100					
13.490	17/32	160.0	108.0	2458 13.490					
14.000		160.0	108.0	2458 14.000					
14.290	9/16	169.0	114.0	2458 14.290					
14.500		169.0	114.0	2458 14.500					

HSS/HSCO drills



Jobber drills

Article no. **629**



Cutting data page 449

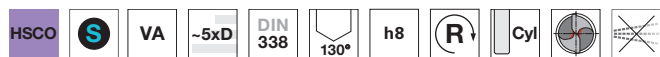

Web thinning $\geq \varnothing 1.000$ • optimised split point • Co-alloyed high speed steel • increased wear resistance

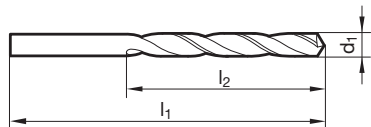

Article no.			629	Article no.			629
d1 mm	l1 mm	l2 mm	Order no.	d1 mm	l1 mm	l2 mm	Order no.
1.000	34.0	12.0	629 1.000	6.400	101.0	63.0	629 6.400
1.100	36.0	14.0	629 1.100	6.500	101.0	63.0	629 6.500
1.200	38.0	16.0	629 1.200	6.600	101.0	63.0	629 6.600
1.300	38.0	16.0	629 1.300	6.700	101.0	63.0	629 6.700
1.400	40.0	18.0	629 1.400	6.800	109.0	69.0	629 6.800
1.500	40.0	18.0	629 1.500	6.900	109.0	69.0	629 6.900
1.600	43.0	20.0	629 1.600	7.000	109.0	69.0	629 7.000
1.700	43.0	20.0	629 1.700	7.100	109.0	69.0	629 7.100
1.800	46.0	22.0	629 1.800	7.200	109.0	69.0	629 7.200
1.900	46.0	22.0	629 1.900	7.300	109.0	69.0	629 7.300
2.000	49.0	24.0	629 2.000	7.400	109.0	69.0	629 7.400
2.100	49.0	24.0	629 2.100	7.500	109.0	69.0	629 7.500
2.200	53.0	27.0	629 2.200	7.600	117.0	75.0	629 7.600
2.300	53.0	27.0	629 2.300	7.700	117.0	75.0	629 7.700
2.400	57.0	30.0	629 2.400	7.800	117.0	75.0	629 7.800
2.500	57.0	30.0	629 2.500	7.900	117.0	75.0	629 7.900
2.600	57.0	30.0	629 2.600	8.000	117.0	75.0	629 8.000
2.700	61.0	33.0	629 2.700	8.100	117.0	75.0	629 8.100
2.800	61.0	33.0	629 2.800	8.200	117.0	75.0	629 8.200
2.900	61.0	33.0	629 2.900	8.300	117.0	75.0	629 8.300
3.000	61.0	33.0	629 3.000	8.400	117.0	75.0	629 8.400
3.100	65.0	36.0	629 3.100	8.500	117.0	75.0	629 8.500
3.200	65.0	36.0	629 3.200	8.600	125.0	81.0	629 8.600
3.300	65.0	36.0	629 3.300	8.700	125.0	81.0	629 8.700
3.400	70.0	39.0	629 3.400	8.800	125.0	81.0	629 8.800
3.500	70.0	39.0	629 3.500	8.900	125.0	81.0	629 8.900
3.600	70.0	39.0	629 3.600	9.000	125.0	81.0	629 9.000
3.700	70.0	39.0	629 3.700	9.100	125.0	81.0	629 9.100
3.800	75.0	43.0	629 3.800	9.200	125.0	81.0	629 9.200
3.900	75.0	43.0	629 3.900	9.300	125.0	81.0	629 9.300
4.000	75.0	43.0	629 4.000	9.400	125.0	81.0	629 9.400
4.100	75.0	43.0	629 4.100	9.500	125.0	81.0	629 9.500
4.200	75.0	43.0	629 4.200	9.600	133.0	87.0	629 9.600
4.300	80.0	47.0	629 4.300	9.700	133.0	87.0	629 9.700
4.400	80.0	47.0	629 4.400	9.800	133.0	87.0	629 9.800
4.500	80.0	47.0	629 4.500	9.900	133.0	87.0	629 9.900
4.600	80.0	47.0	629 4.600	10.000	133.0	87.0	629 10.000
4.700	80.0	47.0	629 4.700	10.200	133.0	87.0	629 10.200
4.800	86.0	52.0	629 4.800	10.500	133.0	87.0	629 10.500
4.900	86.0	52.0	629 4.900	11.000	142.0	94.0	629 11.000
5.000	86.0	52.0	629 5.000	11.200	142.0	94.0	629 11.200
5.100	86.0	52.0	629 5.100	11.500	142.0	94.0	629 11.500
5.200	86.0	52.0	629 5.200	11.800	142.0	94.0	629 11.800
5.300	86.0	52.0	629 5.300	12.000	151.0	101.0	629 12.000
5.400	93.0	57.0	629 5.400	12.500	151.0	101.0	629 12.500
5.500	93.0	57.0	629 5.500	13.000	151.0	101.0	629 13.000
5.600	93.0	57.0	629 5.600				
5.700	93.0	57.0	629 5.700				
5.800	93.0	57.0	629 5.800				
5.900	93.0	57.0	629 5.900				
6.000	93.0	57.0	629 6.000				
6.100	101.0	63.0	629 6.100				
6.200	101.0	63.0	629 6.200				
6.300	101.0	63.0	629 6.300				



Jobber drills

Article no. **9000**



Cutting data page 456

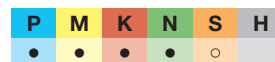

≥ Ø 4.00 mm with 3-flats on shank • 3-flats on shank prevent slipping in the chuck • for use in drilling machines with 3-jaw chucks • optimally suited for hand drilling machines and pillar drill machines • 4-facet point grind with split point ≥ Ø 1.000 • low feed force • fastest drilling progress • for universal application

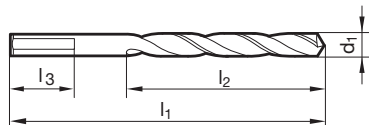

Article no. 9000				Article no. 9000					
d1 mm	inch	l1 mm	l2 mm	Order no.	d1 mm	inch	l1 mm	l2 mm	Order no.
1.000		34.0	12.0	9000 1.000	7.940	5/16	117.0	75.0	9000 7.940
1.500		40.0	18.0	9000 1.500	8.000		117.0	75.0	9000 8.000
1.590	1/16	43.0	20.0	9000 1.590	8.330	21/64	117.0	75.0	9000 8.330
1.980	5/64	49.0	24.0	9000 1.980	8.500		117.0	75.0	9000 8.500
2.000		49.0	24.0	9000 2.000	8.730	11/32	125.0	81.0	9000 8.730
2.380	3/32	57.0	30.0	9000 2.380	9.000		125.0	81.0	9000 9.000
2.500		57.0	30.0	9000 2.500	9.130	23/64	125.0	81.0	9000 9.130
2.780	7/64	61.0	33.0	9000 2.780	9.500		125.0	81.0	9000 9.500
3.000		61.0	33.0	9000 3.000	9.530		133.0	87.0	9000 9.531
3.180		65.0	36.0	9000 3.180	9.530	3/8	133.0	87.0	9000 9.530
3.200		65.0	36.0	9000 3.200	9.920	25/64	133.0	87.0	9000 9.920
3.300		65.0	36.0	9000 3.300	10.000		133.0	87.0	9000 10.000
3.500		70.0	39.0	9000 3.500	10.200		133.0	87.0	9000 10.200
3.570	9/64	70.0	39.0	9000 3.570	10.320	13/32	133.0	87.0	9000 10.320
3.970	5/32	75.0	43.0	9000 3.970	10.500		133.0	87.0	9000 10.500
4.000		75.0	43.0	9000 4.000	10.720	27/64	142.0	94.0	9000 10.720
4.200		75.0	43.0	9000 4.200	11.000		142.0	94.0	9000 11.000
4.370	11/64	80.0	47.0	9000 4.370	11.110	7/16	142.0	94.0	9000 11.110
4.500		80.0	47.0	9000 4.500	11.500		142.0	94.0	9000 11.500
4.760	3/16	86.0	52.0	9000 4.760	11.510	29/64	142.0	94.0	9000 11.510
5.000		86.0	52.0	9000 5.000	11.910	15/32	151.0	101.0	9000 11.910
5.100		86.0	52.0	9000 5.100	12.000		151.0	101.0	9000 12.000
5.160	13/64	86.0	52.0	9000 5.160	12.300	31/64	151.0	101.0	9000 12.300
5.200		86.0	52.0	9000 5.200	12.500		151.0	101.0	9000 12.500
5.500		93.0	57.0	9000 5.500	12.700	1/2	151.0	101.0	9000 12.700
5.560	7/32	93.0	57.0	9000 5.560	13.000		151.0	101.0	9000 13.000
5.950	15/64	93.0	57.0	9000 5.950					
6.000		93.0	57.0	9000 6.000					
6.350	1/4	101.0	63.0	9000 6.350					
6.500		101.0	63.0	9000 6.500					
6.750	17/64	109.0	69.0	9000 6.750					
6.800		109.0	69.0	9000 6.800					
7.000		109.0	69.0	9000 7.000					
7.150		109.0	69.0	9000 7.150					
7.500		109.0	69.0	9000 7.500					
7.540	19/64	117.0	75.0	9000 7.540					



HSS/HSCO drills with straight shank

HSS/HSCO drills

AeroX split point drills

Article no. 1018

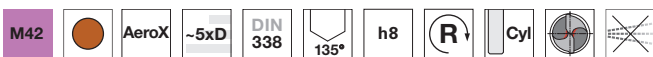

Cutting data page 457

P	M	K	N	S	H
•	•	•	•	•	○

Web thinning $\geq \varnothing 1.000$ • optimised split point • 8% cobalt-alloyed HSCO high speed steel for maximum tool life, high thermal resistance and hardness

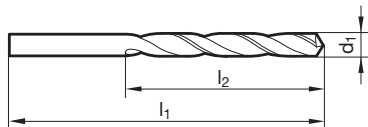

Article no.				1018	Article no.				1018
d1 mm	inch	l1 mm	l2 mm	Order no.	d1 mm	inch	l1 mm	l2 mm	Order no.
1.000		34.0	12.0	1018 1.000	6.300		101.0	63.0	1018 6.300
1.100		36.0	14.0	1018 1.100	6.350	1/4	101.0	63.0	1018 6.350
1.200		38.0	16.0	1018 1.200	6.400		101.0	63.0	1018 6.400
1.300		38.0	16.0	1018 1.300	6.500		101.0	63.0	1018 6.500
1.400		40.0	18.0	1018 1.400	6.600		101.0	63.0	1018 6.600
1.500		40.0	18.0	1018 1.500	6.700		101.0	63.0	1018 6.700
1.590	1/16	43.0	20.0	1018 1.590	6.750	17/64	109.0	69.0	1018 6.750
1.600		43.0	20.0	1018 1.600	6.800		109.0	69.0	1018 6.800
1.700		43.0	20.0	1018 1.700	6.900		109.0	69.0	1018 6.900
1.800		46.0	22.0	1018 1.800	7.000		109.0	69.0	1018 7.000
1.900		46.0	22.0	1018 1.900	7.100		109.0	69.0	1018 7.100
1.980	5/64	49.0	24.0	1018 1.980	7.140	9/32	109.0	69.0	1018 7.140
2.000		49.0	24.0	1018 2.000	7.200		109.0	69.0	1018 7.200
2.100		49.0	24.0	1018 2.100	7.300		109.0	69.0	1018 7.300
2.200		53.0	27.0	1018 2.200	7.400		109.0	69.0	1018 7.400
2.300		53.0	27.0	1018 2.300	7.500		109.0	69.0	1018 7.500
2.380	3/32	57.0	30.0	1018 2.380	7.540	19/64	117.0	75.0	1018 7.540
2.400		57.0	30.0	1018 2.400	7.600		117.0	75.0	1018 7.600
2.500		57.0	30.0	1018 2.500	7.700		117.0	75.0	1018 7.700
2.600		57.0	30.0	1018 2.600	7.800		117.0	75.0	1018 7.800
2.700		61.0	33.0	1018 2.700	7.900		117.0	75.0	1018 7.900
2.780	7/64	61.0	33.0	1018 2.780	7.940	5/16	117.0	75.0	1018 7.940
2.800		61.0	33.0	1018 2.800	8.000		117.0	75.0	1018 8.000
2.900		61.0	33.0	1018 2.900	8.100		117.0	75.0	1018 8.100
3.000		61.0	33.0	1018 3.000	8.200		117.0	75.0	1018 8.200
3.100		65.0	36.0	1018 3.100	8.300		117.0	75.0	1018 8.300
3.170	1/8	65.0	36.0	1018 3.170	8.330	21/64	117.0	75.0	1018 8.330
3.200		65.0	36.0	1018 3.200	8.400		117.0	75.0	1018 8.400
3.250		65.0	36.0	1018 3.250	8.500		117.0	75.0	1018 8.500
3.300		65.0	36.0	1018 3.300	8.600		125.0	81.0	1018 8.600
3.400		70.0	39.0	1018 3.400	8.700		125.0	81.0	1018 8.700
3.500		70.0	39.0	1018 3.500	8.730	11/32	125.0	81.0	1018 8.730
3.570	9/64	70.0	39.0	1018 3.570	8.800		125.0	81.0	1018 8.800
3.600		70.0	39.0	1018 3.600	8.900		125.0	81.0	1018 8.900
3.700		70.0	39.0	1018 3.700	9.000		125.0	81.0	1018 9.000
3.800		75.0	43.0	1018 3.800	9.100		125.0	81.0	1018 9.100
3.900		75.0	43.0	1018 3.900	9.130	23/64	125.0	81.0	1018 9.130
3.970	5/32	75.0	43.0	1018 3.970	9.200		125.0	81.0	1018 9.200
4.000		75.0	43.0	1018 4.000	9.300		125.0	81.0	1018 9.300
4.100		75.0	43.0	1018 4.100	9.500		125.0	81.0	1018 9.500
4.200		75.0	43.0	1018 4.200	9.520	3/8	133.0	87.0	1018 9.520
4.300		80.0	47.0	1018 4.300	9.600		133.0	87.0	1018 9.600
4.400		80.0	47.0	1018 4.400	9.700		133.0	87.0	1018 9.700
4.500		80.0	47.0	1018 4.500	9.800		133.0	87.0	1018 9.800
4.600		80.0	47.0	1018 4.600	9.900		133.0	87.0	1018 9.900
4.700		80.0	47.0	1018 4.700	9.920	25/64	133.0	87.0	1018 9.920
4.760	3/16	86.0	52.0	1018 4.760	10.000		133.0	87.0	1018 10.000
4.800		86.0	52.0	1018 4.800	10.100		133.0	87.0	1018 10.100
4.850		86.0	52.0	1018 4.850	10.200		133.0	87.0	1018 10.200
4.900		86.0	52.0	1018 4.900	10.300		133.0	87.0	1018 10.300
5.000		86.0	52.0	1018 5.000	10.320	13/32	133.0	87.0	1018 10.320
5.100		86.0	52.0	1018 5.100	10.500		133.0	87.0	1018 10.500
5.160	13/64	86.0	52.0	1018 5.160	10.720	27/64	142.0	94.0	1018 10.720
5.200		86.0	52.0	1018 5.200	10.800		142.0	94.0	1018 10.800
5.300		86.0	52.0	1018 5.300	11.000		142.0	94.0	1018 11.000
5.400		93.0	57.0	1018 5.400	11.110	7/16	142.0	94.0	1018 11.110
5.500		93.0	57.0	1018 5.500	11.500		142.0	94.0	1018 11.500
5.560	7/32	93.0	57.0	1018 5.560	11.510	29/64	142.0	94.0	1018 11.510
5.600		93.0	57.0	1018 5.600	11.910	15/32	151.0	101.0	1018 11.910
5.700		93.0	57.0	1018 5.700	12.000		151.0	101.0	1018 12.000
5.800		93.0	57.0	1018 5.800	12.200		151.0	101.0	1018 12.200
5.900		93.0	57.0	1018 5.900	12.300	31/64	151.0	101.0	1018 12.300
5.950	15/64	93.0	57.0	1018 5.950	12.500		151.0	101.0	1018 12.500
6.000		93.0	57.0	1018 6.000	12.700	1/2	151.0	101.0	1018 12.700
6.100		101.0	63.0	1018 6.100	12.800		151.0	101.0	1018 12.800
6.200		101.0	63.0	1018 6.200	13.000		151.0	101.0	1018 13.000

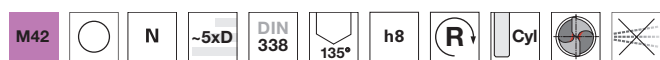

Jobber drills

 Article no. **1146**

 Web thinning $\geq \varnothing 1.000$ • relieved cone • high Co- and Mo-content • especially high wear resistance

Cutting data page 442-443

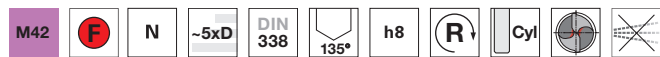
P	M	K	N	S	H
●	○	○	●	○	○

Jobber drills

 Article no. **1199**

 Web thinning $\geq \varnothing 1.000$ • optimised split point • 8% cobalt-alloyed HSCO high speed steel • especially high wear resistance

Cutting data page 442-443

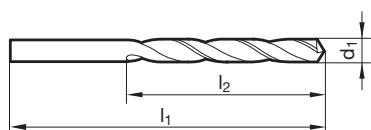
P	M	K	N	S	H
●	●	●	○	●	○



Article no.

1146	1199
-------------	-------------

Article no.

1146	1199
-------------	-------------

d1 mm	inch	l1 mm	l2 mm	Order no.	d1 mm	inch	l1 mm	l2 mm	Order no.
0.400	1/64	20.0	5.0	1146 0.400	5.400		93.0	57.0	1146 5.400
0.500		22.0	6.0	1146 0.500	5.500		93.0	57.0	1146 5.500
0.800		30.0	10.0	1146 0.800	5.600		93.0	57.0	1146 5.600
0.900		32.0	11.0	1146 0.900	5.700		93.0	57.0	1146 5.700
1.000		34.0	12.0	1146 1.000	5.800		93.0	57.0	1146 5.800
1.100		36.0	14.0	1146 1.100	5.900		93.0	57.0	1146 5.900
1.200		38.0	16.0	1146 1.200	5.950	15/64	93.0	57.0	1146 5.950
1.300		38.0	16.0	1146 1.300	6.000		93.0	57.0	1146 6.000
1.400		40.0	18.0	1146 1.400	6.100		101.0	63.0	1146 6.100
1.500		40.0	18.0	1146 1.500	6.200		101.0	63.0	1146 6.200
1.590	1/16	43.0	20.0	1146 1.590	6.300		101.0	63.0	1146 6.300
1.600		43.0	20.0	1146 1.600	6.350	1/4	101.0	63.0	1146 6.350
1.700		43.0	20.0	1146 1.700	6.400		101.0	63.0	1146 6.400
1.800		46.0	22.0	1146 1.800	6.500		101.0	63.0	1146 6.500
1.900		46.0	22.0	1146 1.900	6.600		101.0	63.0	1146 6.600
2.000		49.0	24.0	1146 2.000	6.700		101.0	63.0	1146 6.700
2.100		49.0	24.0	1146 2.100	6.750	17/64	109.0	69.0	1146 6.750
2.200		53.0	27.0	1146 2.200	6.800		109.0	69.0	1146 6.800
2.300		53.0	27.0	1146 2.300	6.900		109.0	69.0	1146 6.900
2.380	3/32	57.0	30.0	1146 2.380	7.000		109.0	69.0	1146 7.000
2.400		57.0	30.0	1146 2.400	7.100		109.0	69.0	1146 7.100
2.500		57.0	30.0	1146 2.500	7.200		109.0	69.0	1146 7.200
2.600		57.0	30.0	1146 2.600	7.300		109.0	69.0	1146 7.300
2.700		61.0	33.0	1146 2.700	7.400		109.0	69.0	1146 7.400
2.800		61.0	33.0	1146 2.800	7.500		109.0	69.0	1146 7.500
2.900		61.0	33.0	1146 2.900	7.540	19/64	117.0	75.0	1146 7.540
3.000		61.0	33.0	1146 3.000	7.600		117.0	75.0	1146 7.600
3.100		65.0	36.0	1146 3.100	7.700		117.0	75.0	1146 7.700
3.170	1/8	65.0	36.0	1146 3.170	7.800		117.0	75.0	1146 7.800
3.200		65.0	36.0	1146 3.200	7.900		117.0	75.0	1146 7.900
3.300		65.0	36.0	1146 3.300	8.000		117.0	75.0	1146 8.000
3.400		70.0	39.0	1146 3.400	8.100		117.0	75.0	1146 8.100
3.500		70.0	39.0	1146 3.500	8.200		117.0	75.0	1146 8.200
3.600		70.0	39.0	1146 3.600	8.300		117.0	75.0	1146 8.300
3.700		70.0	39.0	1146 3.700	8.400		117.0	75.0	1146 8.400
3.800		75.0	43.0	1146 3.800	8.500		117.0	75.0	1146 8.500
3.900		75.0	43.0	1146 3.900	8.600		125.0	81.0	1146 8.600
3.970	5/32	75.0	43.0	1146 3.970	8.700		125.0	81.0	1146 8.700
4.000		75.0	43.0	1146 4.000	8.730	11/32	125.0	81.0	1146 8.730
4.100		75.0	43.0	1146 4.100	8.800		125.0	81.0	1146 8.800
4.200		75.0	43.0	1146 4.200	8.900		125.0	81.0	1146 8.900
4.300		80.0	47.0	1146 4.300	9.000		125.0	81.0	1146 9.000
4.400		80.0	47.0	1146 4.400	9.100		125.0	81.0	1146 9.100
4.500		80.0	47.0	1146 4.500	9.200		125.0	81.0	1146 9.200
4.600		80.0	47.0	1146 4.600	9.300		125.0	81.0	1146 9.300
4.700		80.0	47.0	1146 4.700	9.400		125.0	81.0	1146 9.400
4.760	3/16	86.0	52.0	1146 4.760	9.500		125.0	81.0	1146 9.500
4.800		86.0	52.0	1146 4.800	9.600		133.0	87.0	1146 9.600
4.900		86.0	52.0	1146 4.900	9.700		133.0	87.0	1146 9.700
5.000		86.0	52.0	1146 5.000	9.800		133.0	87.0	1146 9.800
5.100		86.0	52.0	1146 5.100	9.900		133.0	87.0	1146 9.900
5.160	13/64	86.0	52.0		9.920	25/64	133.0	87.0	
5.200		86.0	52.0	1146 5.200	10.000		133.0	87.0	1146 10.000
5.300		86.0	52.0	1146 5.300	10.100		133.0	87.0	1146 10.100



HSS/HSCO drills with straight shank

HSS/HSCO drills

				Article no.		1146	1199					Article no.		1146	1199
d1 mm	inch	l1 mm	l2 mm	Order no.				d1 mm	inch	l1 mm	l2 mm	Order no.			
10.200		133.0	87.0	1146 10.200	1199 10.200			13.000		151.0	101.0	1146 13.000	1199 13.000		
10.500		133.0	87.0	1146 10.500	1199 10.500			13.100	33/64	151.0	101.0	1146 13.100			
10.800		142.0	94.0		1199 10.800			13.500		160.0	108.0	1146 13.500			
11.000		142.0	94.0	1146 11.000	1199 11.000			14.000		160.0	108.0	1146 14.000	1199 14.000		
11.200		142.0	94.0		1199 11.200			14.500		169.0	114.0	1146 14.500			
11.500		142.0	94.0	1146 11.500	1199 11.500			15.000		169.0	114.0	1146 15.000	1199 15.000		
11.510	29/64	142.0	94.0	1146 11.510				15.870	5/8	178.0	120.0	1146 15.870			
11.800		142.0	94.0		1199 11.800			16.000		178.0	120.0	1146 16.000	1199 16.000		
11.910	15/32	151.0	101.0	1146 11.910	1199 11.910										
12.000		151.0	101.0	1146 12.000	1199 12.000										
12.200		151.0	101.0		1199 12.200										
12.500		151.0	101.0	1146 12.500	1199 12.500										



Short flute drills

Article no. **693**



Cutting data page 458



P	M	K	N	S	H
●	○	●	○	●	○

Web thinning $\geq \varnothing 1.000$ • optimised split point • 8% cobalt-alloyed HSCO high speed steel • especially high wear resistance

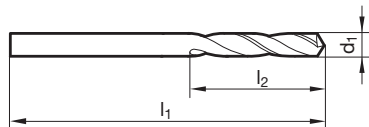

Article no.

693

Article no.

693

d1 mm	l1 mm	l2 mm	Order no.
1.000	34.0	6.0	693 1.000
1.500	40.0	9.0	693 1.500
2.000	49.0	12.0	693 2.000
2.500	57.0	14.0	693 2.500
3.000	61.0	16.0	693 3.000
3.200	65.0	18.0	693 3.200
3.300	65.0	18.0	693 3.300
3.500	70.0	20.0	693 3.500
4.000	75.0	22.0	693 4.000
4.200	75.0	22.0	693 4.200
4.500	80.0	24.0	693 4.500
5.000	86.0	26.0	693 5.000
5.500	93.0	28.0	693 5.500
6.000	93.0	28.0	693 6.000
6.500	101.0	31.0	693 6.500
6.800	109.0	34.0	693 6.800
7.000	109.0	34.0	693 7.000
7.500	109.0	34.0	693 7.500

d1 mm	l1 mm	l2 mm	Order no.
8.000	117.0	37.0	693 8.000
8.500	117.0	37.0	693 8.500
9.000	125.0	40.0	693 9.000
9.500	125.0	40.0	693 9.500
10.000	133.0	43.0	693 10.000
10.200	133.0	43.0	693 10.200
10.500	133.0	43.0	693 10.500
11.000	142.0	47.0	693 11.000
11.500	142.0	47.0	693 11.500
12.000	151.0	51.0	693 12.000
12.500	151.0	51.0	693 12.500
13.000	151.0	51.0	693 13.000

HSS/HSCO drills



HSS/HSCO drills with straight shank

HSS/HSCO drills

Jobber drills

Article no. **732**

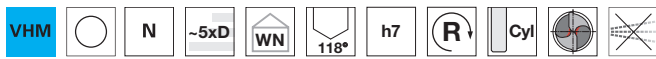

Web thinning $\geq \varnothing 2.060$ • facet point grind • main cutting edge form straight

Cutting data page 430

P	M	K	N	S	H
○	○	○	●	○	○

Jobber drills

Article no. **2464**



Web thinning $\geq \varnothing 2.060$ • facet point grind • main cutting edge form straight

Cutting data page 430

P	M	K	N	S	H
●	○	○	●	○	○

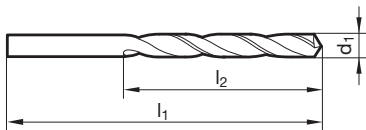

Article no.

732

2464

Article no.

732

2464

d1 mm	inch	l1 mm	l2 mm	Order no.		d1 mm	inch	l1 mm	l2 mm	Order no.	
1.000		34.0	12.0	732 1.000	2464 1.000	3.100		65.0	36.0	732 3.100	2464 3.100
1.020		34.0	12.0	732 1.020	2464 1.020	3.170	1/8	65.0	36.0	732 3.170	2464 3.170
1.040		34.0	12.0	732 1.040	2464 1.040	3.200		65.0	36.0	732 3.200	2464 3.200
1.070		36.0	14.0	732 1.070	2464 1.070	3.260		65.0	36.0	732 3.260	2464 3.260
1.090		36.0	14.0	732 1.090	2464 1.090	3.300		65.0	36.0	732 3.300	2464 3.300
1.100		36.0	14.0	732 1.100	2464 1.100	3.400		70.0	39.0	732 3.400	2464 3.400
1.180		36.0	14.0	732 1.180	2464 1.180	3.450		70.0	39.0	732 3.450	2464 3.450
1.190	3/64	38.0	16.0	732 1.190	2464 1.190	3.500		70.0	39.0	732 3.500	2464 3.500
1.200		38.0	16.0	732 1.200	2464 1.200	3.570	9/64	70.0	39.0	732 3.570	2464 3.570
1.300		38.0	16.0	732 1.300	2464 1.300	3.600		70.0	39.0	732 3.600	2464 3.600
1.320		38.0	16.0	732 1.320	2464 1.320	3.660		70.0	39.0	732 3.660	2464 3.660
1.400		40.0	18.0	732 1.400	2464 1.400	3.700		70.0	39.0	732 3.700	2464 3.700
1.500		40.0	18.0	732 1.500	2464 1.500	3.730		70.0	39.0	732 3.730	2464 3.730
1.510		43.0	20.0	732 1.510	2464 1.510	3.800		75.0	43.0	732 3.800	2464 3.800
1.590	1/16	43.0	20.0	732 1.590	2464 1.590	3.860		75.0	43.0	732 3.860	2464 3.860
1.600		43.0	20.0	732 1.600	2464 1.600	3.900		75.0	43.0	732 3.900	2464 3.900
1.610		43.0	20.0	732 1.610	2464 1.610	3.910		75.0	43.0	732 3.910	2464 3.910
1.700		43.0	20.0	732 1.700	2464 1.700	3.970	5/32	75.0	43.0	732 3.970	2464 3.970
1.780		46.0	22.0	732 1.780	2464 1.780	3.990		75.0	43.0	732 3.990	2464 3.990
1.800		46.0	22.0	732 1.800	2464 1.800	4.000		75.0	43.0	732 4.000	2464 4.000
1.850		46.0	22.0	732 1.850	2464 1.850	4.040		75.0	43.0	732 4.040	2464 4.040
1.900		46.0	22.0	732 1.900	2464 1.900	4.090		75.0	43.0	732 4.090	2464 4.090
1.930		49.0	24.0	732 1.930	2464 1.930	4.100		75.0	43.0	732 4.100	2464 4.100
1.980	5/64	49.0	24.0	732 1.980	2464 1.980	4.200		75.0	43.0	732 4.200	2464 4.200
1.990		49.0	24.0	732 1.990	2464 1.990	4.220		75.0	43.0	732 4.220	2464 4.220
2.000		49.0	24.0	732 2.000	2464 2.000	4.300		80.0	47.0	732 4.300	2464 4.300
2.060		49.0	24.0	732 2.060	2464 2.060	4.370	11/64	80.0	47.0	732 4.370	2464 4.370
2.080		49.0	24.0	732 2.080	2464 2.080	4.390		80.0	47.0	732 4.390	2464 4.390
2.100		49.0	24.0	732 2.100	2464 2.100	4.400		80.0	47.0	732 4.400	2464 4.400
2.180		53.0	27.0	732 2.180	2464 2.180	4.500		80.0	47.0	732 4.500	2464 4.500
2.200		53.0	27.0	732 2.200	2464 2.200	4.570		80.0	47.0	732 4.570	2464 4.570
2.260		53.0	27.0	732 2.260	2464 2.260	4.600		80.0	47.0	732 4.600	2464 4.600
2.300		53.0	27.0	732 2.300	2464 2.300	4.620		80.0	47.0	732 4.620	2464 4.620
2.370		57.0	30.0	732 2.370	2464 2.370	4.700		80.0	47.0	732 4.700	2464 4.700
2.380	3/32	57.0	30.0	732 2.380	2464 2.380	4.760	3/16	86.0	52.0	732 4.760	2464 4.760
2.400		57.0	30.0	732 2.400	2464 2.400	4.800		86.0	52.0	732 4.800	2464 4.800
2.440		57.0	30.0	732 2.440	2464 2.440	4.850		86.0	52.0	732 4.850	2464 4.850
2.490		57.0	30.0	732 2.490	2464 2.490	4.900		86.0	52.0	732 4.900	2464 4.900
2.500		57.0	30.0	732 2.500	2464 2.500	4.920		86.0	52.0	732 4.920	2464 4.920
2.530		57.0	30.0	732 2.530	2464 2.530	4.980		86.0	52.0	732 4.980	2464 4.980
2.580		57.0	30.0	732 2.580	2464 2.580	5.000		86.0	52.0	732 5.000	2464 5.000
2.600		57.0	30.0	732 2.600	2464 2.600	5.060		86.0	52.0	732 5.060	2464 5.060
2.640		57.0	30.0	732 2.640	2464 2.640	5.100		86.0	52.0	732 5.100	2464 5.100
2.700		61.0	33.0	732 2.700	2464 2.700	5.110		86.0	52.0	732 5.110	2464 5.110
2.710		61.0	33.0	732 2.710	2464 2.710	5.160	13/64	86.0	52.0	732 5.160	2464 5.160
2.780	7/64	61.0	33.0	732 2.780	2464 2.780	5.180		86.0	52.0	732 5.180	2464 5.180
2.790		61.0	33.0	732 2.790	2464 2.790	5.200		86.0	52.0	732 5.200	2464 5.200
2.800		61.0	33.0	732 2.800	2464 2.800	5.220		86.0	52.0	732 5.220	2464 5.220
2.820		61.0	33.0	732 2.820	2464 2.820	5.300		86.0	52.0	732 5.300	2464 5.300
2.870		61.0	33.0	732 2.870	2464 2.870	5.310		93.0	57.0	732 5.310	2464 5.310
2.900		61.0	33.0	732 2.900	2464 2.900	5.400		93.0	57.0	732 5.400	2464 5.400
2.950		61.0	33.0	732 2.950	2464 2.950	5.410		93.0	57.0	732 5.410	2464 5.410
3.000		61.0	33.0	732 3.000	2464 3.000	5.500		93.0	57.0	732 5.500	2464 5.500
3.050		65.0	36.0	732 3.050	2464 3.050	5.560	7/32	93.0	57.0	732 5.560	2464 5.560



Article no.				732	2464	Article no.				732	2464
d1 mm	inch	l1 mm	l2 mm	Order no.		d1 mm	inch	l1 mm	l2 mm	Order no.	
5.600		93.0	57.0	732 5.600	2464 5.600	8.400		117.0	75.0	732 8.400	2464 8.400
5.610		93.0	57.0	732 5.610	2464 5.610	8.430		117.0	75.0	732 8.430	2464 8.430
5.700		93.0	57.0	732 5.700	2464 5.700	8.500		117.0	75.0	732 8.500	2464 8.500
5.790		93.0	57.0	732 5.790	2464 5.790	8.600		125.0	81.0	732 8.600	2464 8.600
5.800		93.0	57.0	732 5.800	2464 5.800	8.610		125.0	81.0	732 8.610	2464 8.610
5.900		93.0	57.0	732 5.900	2464 5.900	8.700		125.0	81.0	732 8.700	2464 8.700
5.940		93.0	57.0	732 5.940	2464 5.940	8.730	11/32	125.0	81.0	732 8.730	2464 8.730
5.950	15/64	93.0	57.0	732 5.950	2464 5.950	8.800		125.0	81.0	732 8.800	2464 8.800
6.000		93.0	57.0	732 6.000	2464 6.000	8.840		125.0	81.0	732 8.840	2464 8.840
6.040		101.0	63.0	732 6.040	2464 6.040	8.900		125.0	81.0	732 8.900	2464 8.900
6.100		101.0	63.0	732 6.100	2464 6.100	9.000		125.0	81.0	732 9.000	2464 9.000
6.150		101.0	63.0	732 6.150	2464 6.150	9.090		125.0	81.0	732 9.090	2464 9.090
6.200		101.0	63.0	732 6.200	2464 6.200	9.100		125.0	81.0	732 9.100	2464 9.100
6.250		101.0	63.0	732 6.250	2464 6.250	9.130	23/64	125.0	81.0	732 9.130	2464 9.130
6.300		101.0	63.0	732 6.300	2464 6.300	9.200		125.0	81.0	732 9.200	2464 9.200
6.350	1/4	101.0	63.0	732 6.350	2464 6.350	9.300		125.0	81.0	732 9.300	2464 9.300
6.400		101.0	63.0	732 6.400	2464 6.400	9.340		125.0	81.0	732 9.340	2464 9.340
6.500		101.0	63.0	732 6.500	2464 6.500	9.400		125.0	81.0	732 9.400	2464 9.400
6.530		101.0	63.0	732 6.530	2464 6.530	9.500		125.0	81.0	732 9.500	2464 9.500
6.600		101.0	63.0	732 6.600	2464 6.600	9.520	3/8	133.0	87.0	732 9.520	2464 9.520
6.630		101.0	63.0	732 6.630	2464 6.630	9.580		133.0	87.0	732 9.580	2464 9.580
6.700		101.0	63.0	732 6.700	2464 6.700	9.600		133.0	87.0	732 9.600	2464 9.600
6.750	17/64	109.0	69.0	732 6.750	2464 6.750	9.700		133.0	87.0	732 9.700	2464 9.700
6.800		109.0	69.0	732 6.800	2464 6.800	9.800		133.0	87.0	732 9.800	2464 9.800
6.900		109.0	69.0	732 6.900	2464 6.900	9.900		133.0	87.0	732 9.900	2464 9.900
7.000		109.0	69.0	732 7.000	2464 7.000	9.920	25/64	133.0	87.0	732 9.920	2464 9.920
7.030		109.0	69.0	732 7.030	2464 7.030	10.000		133.0	87.0	732 10.000	2464 10.000
7.100		109.0	69.0	732 7.100	2464 7.100	10.080		133.0	87.0	732 10.080	2464 10.080
7.140	9/32	109.0	69.0	732 7.140	2464 7.140	10.200		133.0	87.0	732 10.200	2464 10.200
7.200		109.0	69.0	732 7.200	2464 7.200	10.260		133.0	87.0	732 10.260	2464 10.260
7.300		109.0	69.0	732 7.300	2464 7.300	10.300		133.0	87.0	732 10.300	2464 10.300
7.370		109.0	69.0	732 7.370	2464 7.370	10.320	13/32	133.0	87.0	732 10.320	2464 10.320
7.400		109.0	69.0	732 7.400	2464 7.400	10.490		133.0	87.0	732 10.490	2464 10.490
7.490		109.0	69.0	732 7.490	2464 7.490	10.500		133.0	87.0	732 10.500	2464 10.500
7.500		109.0	69.0	732 7.500	2464 7.500	10.720	27/64	142.0	94.0	732 10.720	2464 10.720
7.540	19/64	117.0	75.0	732 7.540	2464 7.540	11.000		142.0	94.0	732 11.000	2464 11.000
7.600		117.0	75.0	732 7.600	2464 7.600	11.110	7/16	142.0	94.0	732 11.110	2464 11.110
7.670		117.0	75.0	732 7.670	2464 7.670	11.500		142.0	94.0	732 11.500	2464 11.500
7.700		117.0	75.0	732 7.700	2464 7.700	11.510	29/64	142.0	94.0	732 11.510	2464 11.510
7.800		117.0	75.0	732 7.800	2464 7.800	11.910	15/32	151.0	101.0	732 11.910	2464 11.910
7.900		117.0	75.0	732 7.900	2464 7.900	12.000		151.0	101.0	732 12.000	2464 12.000
7.940	5/16	117.0	75.0	732 7.940	2464 7.940	12.300	31/64	151.0	101.0	732 12.300	2464 12.300
8.000		117.0	75.0	732 8.000	2464 8.000	12.700	1/2	151.0	101.0	732 12.700	2464 12.700
8.030		117.0	75.0	732 8.030	2464 8.030						
8.100		117.0	75.0	732 8.100	2464 8.100						
8.200		117.0	75.0	732 8.200	2464 8.200						
8.300		117.0	75.0	732 8.300	2464 8.300						
8.330	21/64	117.0	75.0	732 8.330	2464 8.330						



Jobber drills

Article no. **2601**

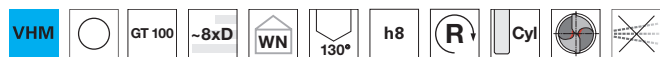

Web thinning $\geq \varnothing 3.170$ • relieved cone

Cutting data page 432

P	M	K	N	S	H
●	○	●	●	○	○

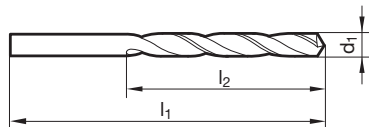

Article no.				2601	Article no.				2601
d1 mm	inch	l1 mm	l2 mm	Order no.	d1 mm	inch	l1 mm	l2 mm	Order no.
3.170	1/8	70.7	41.8	2601 3.170	6.900		106.6	74.6	2601 6.900
3.200		70.7	41.8	2601 3.200	7.000		106.6	74.6	2601 7.000
3.260		70.7	41.8	2601 3.260	7.030		106.6	74.6	2601 7.030
3.300		73.8	44.9	2601 3.300	7.140	9/32	109.7	76.7	2601 7.140
3.400		73.8	44.9	2601 3.400	7.370		109.7	76.7	2601 7.370
3.450		73.8	44.9	2601 3.450	7.490		112.8	79.7	2601 7.490
3.500		73.8	44.9	2601 3.500	7.500		112.8	79.7	2601 7.500
3.570	9/64	73.8	44.9	2601 3.570	7.540	19/64	112.8	79.7	2601 7.540
3.660		76.9	48.8	2601 3.660	7.670		112.8	79.7	2601 7.670
3.730		76.9	48.8	2601 3.730	7.940	5/16	115.9	82.8	2601 7.940
3.800		76.9	48.8	2601 3.800	8.000		115.9	82.8	2601 8.000
3.860		80.0	51.9	2601 3.860	8.030		115.9	82.8	2601 8.030
3.910		80.0	51.9	2601 3.910	8.200		119.0	86.0	2601 8.200
3.970	5/32	80.0	51.9	2601 3.970	8.330	21/64	119.0	86.0	2601 8.330
3.990		80.0	51.9	2601 3.990	8.430		123.1	89.1	2601 8.430
4.000		84.0	55.0	2601 4.000	8.500		123.1	89.1	2601 8.500
4.040		84.0	55.0	2601 4.040	8.610		123.1	89.1	2601 8.610
4.090		84.0	55.0	2601 4.090	8.730	11/32	123.1	89.1	2601 8.730
4.220		84.0	55.0	2601 4.220	8.840		126.1	91.1	2601 8.840
4.300		84.0	55.0	2601 4.300	9.000		126.1	91.1	2601 9.000
4.370	11/64	84.0	55.0	2601 4.370	9.090		126.1	91.1	2601 9.090
4.390		87.0	57.0	2601 4.390	9.130	23/64	126.1	91.1	2601 9.130
4.500		87.0	57.0	2601 4.500	9.340		129.2	94.2	2601 9.340
4.570		87.0	57.0	2601 4.570	9.500		129.2	94.2	2601 9.500
4.620		87.0	57.0	2601 4.620	9.520	3/8	129.2	94.2	2601 9.520
4.700		90.1	60.1	2601 4.700	9.580		129.2	94.2	2601 9.580
4.760	3/16	90.1	60.1	2601 4.760	9.800		132.4	97.4	2601 9.800
4.800		90.1	60.1	2601 4.800	9.920	25/64	132.4	97.4	2601 9.920
4.850		90.1	60.1	2601 4.850	10.000		132.4	97.4	2601 10.000
4.920		93.2	63.2	2601 4.920	10.080		132.4	97.4	2601 10.080
4.980		93.2	63.2	2601 4.980	10.260		135.5	100.5	2601 10.260
5.000		93.2	63.2	2601 5.000	10.320	13/32	135.5	100.5	2601 10.320
5.060		93.2	63.2	2601 5.060	10.490		135.5	100.5	2601 10.490
5.110		93.2	63.2	2601 5.110	10.500		135.5	100.5	2601 10.500
5.160	13/64	93.2	63.2	2601 5.160	10.720	27/64	139.4	102.5	2601 10.720
5.180		96.3	65.2	2601 5.180	11.000		142.5	105.6	2601 11.000
5.220		96.3	65.2	2601 5.220	11.110	7/16	142.5	105.6	2601 11.110
5.310		96.3	65.2	2601 5.310	11.500		145.6	108.7	2601 11.500
5.410		96.3	65.2	2601 5.410	11.510	29/64	145.6	108.7	2601 11.510
5.500		96.3	65.2	2601 5.500	11.910	15/32	148.8	112.7	2601 11.910
5.560	7/32	96.3	65.2	2601 5.560	12.000		151.9	113.9	2601 12.000
5.610		99.4	68.3	2601 5.610	12.300	31/64	151.9	113.9	2601 12.300
5.790		99.4	68.3	2601 5.790	12.500		155.1	117.1	2601 12.500
5.940		99.4	68.3	2601 5.940	12.700	1/2	155.1	117.1	2601 12.700
5.950	15/64	99.4	68.3	2601 5.950					
6.000		103.4	71.4	2601 6.000					
6.040		103.4	71.4	2601 6.040					
6.150		103.4	71.4	2601 6.150					
6.250		103.4	71.4	2601 6.250					
6.350	1/4	103.4	71.4	2601 6.350					
6.500		106.6	74.6	2601 6.500					
6.530		106.6	74.6	2601 6.530					
6.630		106.6	74.6	2601 6.630					
6.750	17/64	106.6	74.6	2601 6.750					

Bushing drills

 Article no. **211**

Cutting data page 459

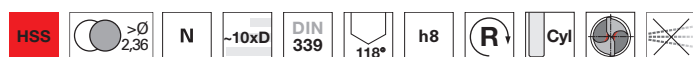

 Web thinning $\geq \varnothing 1.000$ • relieved cone • for drilling through drill bushes

P	M	K	N	S	H
•		•	○		

Bushing drills

 Article no. **666**

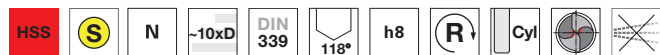
Cutting data page 459

 Web thinning $\geq \varnothing 1.000$ • relieved cone • for drilling through drill bushes

P	M	K	N	S	H
•		•	•		

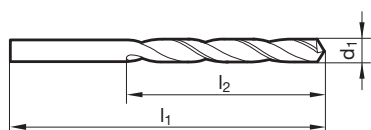

Article no.

211	666
------------	------------

Article no.

211	666
------------	------------

d1 mm	inch	l1 mm	l2 mm	Order no.		d1 mm	inch	l1 mm	l2 mm	Order no.	
0.800		42.0	22.0	211 0.800		3.250		84.0	55.0	211 3.250	
1.000		48.0	26.0	211 1.000	666 1.000	3.300		84.0	55.0	211 3.300	666 3.300
1.050		48.0	26.0	211 1.050		3.400		91.0	60.0	211 3.400	666 3.400
1.080		50.0	28.0	211 1.080		3.500		91.0	60.0	211 3.500	666 3.500
1.100		50.0	28.0	211 1.100	666 1.100	3.570	9/64	91.0	60.0		666 3.570
1.150		50.0	28.0	211 1.150		3.600		91.0	60.0	211 3.600	666 3.600
1.200		52.0	30.0	211 1.200	666 1.200	3.700		91.0	60.0	211 3.700	666 3.700
1.230		52.0	30.0	211 1.230		3.800		96.0	64.0	211 3.800	666 3.800
1.250		52.0	30.0	211 1.250		3.900		96.0	64.0	211 3.900	666 3.900
1.300		52.0	30.0	211 1.300	666 1.300	3.950		96.0	64.0	211 3.950	
1.350		55.0	33.0	211 1.350	666 1.350	4.000		96.0	64.0	211 4.000	666 4.000
1.400		55.0	33.0	211 1.400	666 1.400	4.100		96.0	64.0	211 4.100	666 4.100
1.450		55.0	33.0	211 1.450	666 1.450	4.200		96.0	64.0	211 4.200	666 4.200
1.460		55.0	33.0	211 1.460		4.300		102.0	69.0	211 4.300	666 4.300
1.500		55.0	33.0	211 1.500	666 1.500	4.400		102.0	69.0	211 4.400	666 4.400
1.510		58.0	35.0		666 1.510	4.500		102.0	69.0	211 4.500	666 4.500
1.580		58.0	35.0	211 1.580		4.580		102.0	69.0	211 4.580	
1.600		58.0	35.0	211 1.600	666 1.600	4.600		102.0	69.0	211 4.600	666 4.600
1.620		58.0	35.0	211 1.620		4.700		102.0	69.0	211 4.700	
1.650		58.0	35.0	211 1.650		4.750		102.0	69.0	211 4.750	
1.700		58.0	35.0	211 1.700	666 1.700	4.800		108.0	74.0	211 4.800	666 4.800
1.800		62.0	38.0	211 1.800	666 1.800	4.900		108.0	74.0	211 4.900	
1.850		62.0	38.0	211 1.850		5.000		108.0	74.0	211 5.000	666 5.000
1.900		62.0	38.0	211 1.900	666 1.900	5.100		108.0	74.0	211 5.100	666 5.100
1.930		66.0	41.0	211 1.930		5.150		108.0	74.0		666 5.150
1.980	5/64	66.0	41.0	211 1.980	666 1.980	5.200		108.0	74.0	211 5.200	
1.990		66.0	41.0	211 1.990	666 1.990	5.300		108.0	74.0	211 5.300	666 5.300
2.000		66.0	41.0	211 2.000	666 2.000	5.350		116.0	80.0	211 5.350	
2.020		66.0	41.0	211 2.020	666 2.020	5.400		116.0	80.0	211 5.400	666 5.400
2.030		66.0	41.0	211 2.030		5.500		116.0	80.0	211 5.500	666 5.500
2.050		66.0	41.0	211 2.050		5.600		116.0	80.0	211 5.600	666 5.600
2.100		66.0	41.0	211 2.100	666 2.100	5.700		116.0	80.0	211 5.700	666 5.700
2.150		70.0	44.0	211 2.150		5.800		116.0	80.0	211 5.800	666 5.800
2.200		70.0	44.0	211 2.200	666 2.200	6.000		116.0	80.0	211 6.000	666 6.000
2.250		70.0	44.0	211 2.250		6.200		124.0	86.0	211 6.200	666 6.200
2.300		70.0	44.0	211 2.300	666 2.300	6.400		124.0	86.0	211 6.400	
2.320		70.0	44.0	211 2.320		6.500		124.0	86.0	211 6.500	666 6.500
2.350		70.0	44.0	211 2.350		6.600		124.0	86.0		666 6.600
2.380	3/32	74.0	47.0	211 2.380		6.700		124.0	86.0	211 6.700	
2.400		74.0	47.0	211 2.400	666 2.400	6.800		133.0	93.0	211 6.800	666 6.800
2.450		74.0	47.0	211 2.450	666 2.450	6.900		133.0	93.0	211 6.900	666 6.900
2.500		74.0	47.0	211 2.500	666 2.500	7.000		133.0	93.0	211 7.000	666 7.000
2.550		74.0	47.0	211 2.550	666 2.550	7.050		133.0	93.0	211 7.050	
2.600		74.0	47.0	211 2.600	666 2.600	7.100		133.0	93.0	211 7.100	
2.650		74.0	47.0	211 2.650		7.200		133.0	93.0	211 7.200	666 7.200
2.700		79.0	51.0	211 2.700		7.300		133.0	93.0	211 7.300	
2.800		79.0	51.0	211 2.800	666 2.800	7.400		133.0	93.0	211 7.400	
2.900		79.0	51.0	211 2.900	666 2.900	7.500		133.0	93.0	211 7.500	666 7.500
2.950		79.0	51.0	211 2.950		7.600		142.0	100.0	211 7.600	
3.000		79.0	51.0	211 3.000	666 3.000	7.700		142.0	100.0		666 7.700
3.050		84.0	55.0	211 3.050		7.800		142.0	100.0		666 7.800
3.100		84.0	55.0	211 3.100	666 3.100	7.900		142.0	100.0		666 7.900
3.150		84.0	55.0	211 3.150	666 3.150	7.940	5/16	142.0	100.0		666 7.940
3.200		84.0	55.0	211 3.200	666 3.200	8.000		142.0	100.0	211 8.000	666 8.000



HSS/HSCO drills with straight shank

HSS/HSCO drills

Article no.				211	666	Article no.				211	666
d1 mm	inch	l1 mm	l2 mm	Order no.		d1 mm	inch	l1 mm	l2 mm	Order no.	
8.100		142.0	100.0	211 8.100		12.100		184.0	134.0	211 12.100	
8.120		142.0	100.0	211 8.120		12.300	31/64	184.0	134.0	211 12.300	
8.200		142.0	100.0	211 8.200	666 8.200	12.500		184.0	134.0	211 12.500	666 12.500
8.500		142.0	100.0	211 8.500	666 8.500	13.000		184.0	134.0	211 13.000	666 13.000
8.600		151.0	107.0	211 8.600	666 8.600	13.200		184.0	134.0	211 13.200	
8.700		151.0	107.0	211 8.700		13.500		194.0	142.0	211 13.500	
8.800		151.0	107.0	211 8.800		13.800		194.0	142.0	211 13.800	
8.900		151.0	107.0	211 8.900		14.200		202.0	147.0	211 14.200	
9.000		151.0	107.0	211 9.000	666 9.000	14.500		202.0	147.0	211 14.500	
9.200		151.0	107.0	211 9.200		15.000		202.0	147.0	211 15.000	
9.500		151.0	107.0	211 9.500	666 9.500	15.500		211.0	153.0	211 15.500	
9.600		162.1	116.0	211 9.600		17.000		218.0	159.0	211 17.000	
9.800		162.1	116.0	211 9.800		17.500		226.0	165.0	211 17.500	
10.000		162.1	116.0	211 10.000	666 10.000	18.000		226.0	165.0	211 18.000	
10.200		162.1	116.0	211 10.200	666 10.200	18.500		234.0	171.0	211 18.500	
10.500		162.1	116.0	211 10.500	666 10.500	19.000		234.0	171.0	211 19.000	
10.800		173.0	125.0	211 10.800		19.500		242.0	177.0	211 19.500	
11.000		173.0	125.0	211 11.000		20.000		242.0	177.0	211 20.000	
11.300		173.0	125.0	211 11.300							
11.400		173.0	125.0	211 11.400							
11.500		173.0	125.0	211 11.500	666 11.500						
11.700		173.0	125.0	211 11.700							
11.750		173.0	125.0	211 11.750							
12.000		184.0	134.0	211 12.000	666 12.000						

Long series twist drills

 Article no. **217**



Cutting data page 459

 Web thinning $\geq \varnothing 1.000$ • relieved cone • for deep holes

Long series twist drills

 Article no. **667**

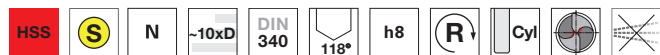
Cutting data page 459

 Web thinning $\geq \varnothing 1.000$ • relieved cone • for deep holes • for drilling through drill bushes

Article no. 217				Article no. 667		Article no. 217				Article no. 667	
d1 mm	inch	l1 mm	l2 mm	Order no.		d1 mm	inch	l1 mm	l2 mm	Order no.	
0.400	1/64	30.0	10.0	217 0.400		1.900		80.0	53.0	217 1.900	667 1.900
0.440		30.0	10.0	217 0.440		1.930		85.0	56.0	217 1.930	
0.450		30.0	10.0	217 0.450		1.950		85.0	56.0	217 1.950	667 1.950
0.470		30.0	10.0	217 0.470		1.980	5/64	85.0	56.0	217 1.980	667 1.980
0.500		32.0	12.0	217 0.500	667 0.500	1.990		85.0	56.0	217 1.990	
0.520		32.0	12.0	217 0.520		2.000		85.0	56.0	217 2.000	667 2.000
0.550		35.0	15.0	217 0.550		2.030		85.0	56.0	217 2.030	
0.570		35.0	15.0	217 0.570		2.050		85.0	56.0	217 2.050	667 2.050
0.600		35.0	15.0	217 0.600	667 0.600	2.060		85.0	56.0	217 2.060	
0.620		38.0	18.0	217 0.620		2.080		85.0	56.0	217 2.080	
0.650		38.0	18.0	217 0.650		2.100		85.0	56.0	217 2.100	667 2.100
0.700		42.0	21.0	217 0.700	667 0.700	2.150		90.0	59.0	217 2.150	
0.710		42.0	21.0	217 0.710		2.200		90.0	59.0	217 2.200	667 2.200
0.730		42.0	21.0	217 0.730		2.250		90.0	59.0	217 2.250	
0.750		42.0	21.0	217 0.750	667 0.750	2.260		90.0	59.0	217 2.260	
0.760		46.0	25.0	217 0.760		2.300		90.0	59.0	217 2.300	667 2.300
0.790	1/32	46.0	25.0	217 0.790		2.350		90.0	59.0	217 2.350	
0.800		46.0	25.0	217 0.800	667 0.800	2.380	3/32	95.0	62.0	217 2.380	667 2.380
0.820		46.0	25.0	217 0.820		2.400		95.0	62.0	217 2.400	667 2.400
0.850		46.0	25.0	217 0.850	667 0.850	2.420		95.0	62.0	217 2.420	
0.900		51.0	29.0	217 0.900	667 0.900	2.440		95.0	62.0	217 2.440	667 2.440
0.920		51.0	29.0	217 0.920		2.450		95.0	62.0	217 2.450	667 2.450
0.950		51.0	29.0	217 0.950	667 0.950	2.490		95.0	62.0	217 2.490	
0.970		56.0	33.0	217 0.970		2.500		95.0	62.0	217 2.500	667 2.500
1.000		56.0	33.0	217 1.000	667 1.000	2.530		95.0	62.0	217 2.530	
1.040		56.0	33.0	217 1.040		2.550		95.0	62.0	217 2.550	667 2.550
1.050		56.0	33.0	217 1.050		2.580		95.0	62.0	217 2.580	
1.070		60.0	37.0	217 1.070		2.600		95.0	62.0	217 2.600	
1.080		60.0	37.0	217 1.080		2.620		95.0	62.0	217 2.620	
1.100		60.0	37.0	217 1.100	667 1.100	2.640		95.0	62.0	217 2.640	
1.120		60.0	37.0	217 1.120		2.650		95.0	62.0	217 2.650	667 2.650
1.130		60.0	37.0	217 1.130		2.700		100.0	66.0	217 2.700	667 2.700
1.150		60.0	37.0	217 1.150	667 1.150	2.710		100.0	66.0	217 2.710	
1.180		60.0	37.0	217 1.180		2.750		100.0	66.0	217 2.750	667 2.750
1.190	3/64	65.0	41.0	217 1.190		2.780	7/64	100.0	66.0	217 2.780	667 2.780
1.200		65.0	41.0	217 1.200	667 1.200	2.790		100.0	66.0	217 2.790	
1.250		65.0	41.0	217 1.250	667 1.250	2.800		100.0	66.0	217 2.800	667 2.800
1.300		65.0	41.0	217 1.300	667 1.300	2.820		100.0	66.0	217 2.820	
1.350		70.0	45.0	217 1.350	667 1.350	2.850		100.0	66.0	217 2.850	667 2.850
1.400		70.0	45.0	217 1.400	667 1.400	2.870		100.0	66.0		667 2.870
1.450		70.0	45.0	217 1.450	667 1.450	2.900		100.0	66.0	217 2.900	667 2.900
1.490		70.0	45.0	217 1.490		2.950		100.0	66.0	217 2.950	
1.500		70.0	45.0	217 1.500	667 1.500	3.000		100.0	66.0	217 3.000	667 3.000
1.510		76.0	50.0	217 1.510		3.030		106.0	69.0	217 3.030	667 3.030
1.550		76.0	50.0	217 1.550	667 1.550	3.050		106.0	69.0	217 3.050	667 3.050
1.590	1/16	76.0	50.0	217 1.590	667 1.590	3.100		106.0	69.0	217 3.100	667 3.100
1.600		76.0	50.0	217 1.600	667 1.600	3.150		106.0	69.0	217 3.150	
1.610		76.0	50.0	217 1.610		3.170	1/8	106.0	69.0	217 3.170	667 3.170
1.650		76.0	50.0	217 1.650	667 1.650	3.200		106.0	69.0	217 3.200	667 3.200
1.700		76.0	50.0	217 1.700	667 1.700	3.250		106.0	69.0	217 3.250	667 3.250
1.750		80.0	53.0	217 1.750		3.260		106.0	69.0	217 3.260	
1.780		80.0	53.0	217 1.780		3.300		106.0	69.0	217 3.300	667 3.300
1.800		80.0	53.0	217 1.800	667 1.800	3.350		106.0	69.0	217 3.350	667 3.350
1.850		80.0	53.0	217 1.850	667 1.850	3.400		112.0	73.0	217 3.400	667 3.400



HSS/HSCO drills with straight shank

HSS/HSCO drills

Article no.				217	667	Article no.				217	667
d1 mm	inch	l1 mm	l2 mm	Order no.		d1 mm	inch	l1 mm	l2 mm	Order no.	
3.450		112.0	73.0	217 3.450		6.600		148.0	97.0	217 6.600	667 6.600
3.500		112.0	73.0	217 3.500	667 3.500	6.700		148.0	97.0	217 6.700	667 6.700
3.550		112.0	73.0	217 3.550		6.750	17/64	156.0	102.0	217 6.750	667 6.750
3.570	9/64	112.0	73.0	217 3.570	667 3.570	6.800		156.0	102.0	217 6.800	667 6.800
3.600		112.0	73.0	217 3.600	667 3.600	6.900		156.0	102.0	217 6.900	667 6.900
3.650		112.0	73.0	217 3.650	667 3.650	7.000		156.0	102.0	217 7.000	667 7.000
3.660		112.0	73.0	217 3.660		7.030		156.0	102.0	217 7.030	
3.700		112.0	73.0	217 3.700	667 3.700	7.100		156.0	102.0	217 7.100	667 7.100
3.750		112.0	73.0	217 3.750		7.140	9/32	156.0	102.0	217 7.140	667 7.140
3.800		119.0	78.0	217 3.800	667 3.800	7.200		156.0	102.0	217 7.200	667 7.200
3.850		119.0	78.0	217 3.850		7.250		156.0	102.0	667 7.250	
3.860		119.0	78.0	217 3.860		7.300		156.0	102.0	217 7.300	667 7.300
3.900		119.0	78.0	217 3.900	667 3.900	7.370		156.0	102.0	217 7.370	667 7.370
3.910		119.0	78.0	217 3.910		7.400		156.0	102.0	217 7.400	667 7.400
3.950		119.0	78.0	217 3.950	667 3.950	7.500		156.0	102.0	217 7.500	667 7.500
3.970	5/32	119.0	78.0	217 3.970	667 3.970	7.540	19/64	165.0	109.0	217 7.540	
4.000		119.0	78.0	217 4.000	667 4.000	7.600		165.0	109.0	217 7.600	
4.030		119.0	78.0	217 4.030		7.670		165.0	109.0	217 7.670	
4.040		119.0	78.0	217 4.040		7.700		165.0	109.0	217 7.700	667 7.700
4.050		119.0	78.0	217 4.050	667 4.050	7.800		165.0	109.0	217 7.800	
4.090		119.0	78.0	217 4.090		7.900		165.0	109.0	217 7.900	
4.100		119.0	78.0	217 4.100	667 4.100	7.940	5/16	165.0	109.0	217 7.940	667 7.940
4.150		119.0	78.0	217 4.150		8.000		165.0	109.0	217 8.000	667 8.000
4.200		119.0	78.0	217 4.200	667 4.200	8.030		165.0	109.0	217 8.030	
4.220		119.0	78.0	217 4.220		8.050		165.0	109.0		667 8.050
4.250		119.0	78.0	217 4.250	667 4.250	8.100		165.0	109.0	217 8.100	667 8.100
4.300		126.0	82.0	217 4.300	667 4.300	8.200		165.0	109.0	217 8.200	667 8.200
4.350		126.0	82.0	217 4.350		8.250		165.0	109.0	217 8.250	
4.370	11/64	126.0	82.0	217 4.370	667 4.370	8.300		165.0	109.0	217 8.300	
4.390		126.0	82.0	217 4.390		8.330	21/64	165.0	109.0	217 8.330	
4.400		126.0	82.0	217 4.400	667 4.400	8.400		165.0	109.0	217 8.400	667 8.400
4.450		126.0	82.0	217 4.450		8.430		165.0	109.0	217 8.430	
4.500		126.0	82.0	217 4.500	667 4.500	8.500		165.0	109.0	217 8.500	667 8.500
4.570		126.0	82.0	217 4.570	667 4.570	8.600		175.0	115.0	217 8.600	
4.600		126.0	82.0	217 4.600	667 4.600	8.610		175.0	115.0	217 8.610	
4.620		126.0	82.0	217 4.620	667 4.620	8.700		175.0	115.0	217 8.700	667 8.700
4.650		126.0	82.0	217 4.650	667 4.650	8.730	11/32	175.0	115.0	217 8.730	667 8.730
4.700		126.0	82.0	217 4.700		8.750		175.0	115.0	217 8.750	
4.750		126.0	82.0	217 4.750	667 4.750	8.800		175.0	115.0	217 8.800	667 8.800
4.760	3/16	132.0	87.0	217 4.760	667 4.760	8.840		175.0	115.0	217 8.840	
4.800		132.0	87.0	217 4.800		8.900		175.0	115.0	217 8.900	667 8.900
4.850		132.0	87.0	217 4.850	667 4.850	9.000		175.0	115.0	217 9.000	667 9.000
4.900		132.0	87.0	217 4.900	667 4.900	9.100		175.0	115.0	217 9.100	
4.950		132.0	87.0	217 4.950		9.130	23/64	175.0	115.0	217 9.130	
4.980		132.0	87.0	217 4.980	667 4.980	9.200		175.0	115.0	217 9.200	667 9.200
5.000		132.0	87.0	217 5.000	667 5.000	9.250		175.0	115.0	217 9.250	
5.030		132.0	87.0	217 5.030		9.300		175.0	115.0	217 9.300	667 9.300
5.050		132.0	87.0	217 5.050		9.400		175.0	115.0	217 9.400	667 9.400
5.060		132.0	87.0	217 5.060		9.500		175.0	115.0	217 9.500	667 9.500
5.100		132.0	87.0	217 5.100	667 5.100	9.520	3/8	184.0	121.0	217 9.520	667 9.520
5.110		132.0	87.0	217 5.110		9.600		184.0	121.0	217 9.600	667 9.600
5.150		132.0	87.0	217 5.150		9.700		184.0	121.0	217 9.700	667 9.700
5.160	13/64	132.0	87.0	217 5.160	667 5.160	9.750		184.0	121.0	217 9.750	
5.200		132.0	87.0	217 5.200	667 5.200	9.800		184.0	121.0	217 9.800	667 9.800
5.250		132.0	87.0	217 5.250	667 5.250	9.900		184.0	121.0	217 9.900	667 9.900
5.300		132.0	87.0	217 5.300	667 5.300	9.920	25/64	184.0	121.0	217 9.920	667 9.920
5.310		139.0	91.0	217 5.310		10.000		184.0	121.0	217 10.000	667 10.000
5.350		139.0	91.0	217 5.350		10.080		184.0	121.0	217 10.080	
5.400		139.0	91.0	217 5.400		10.100		184.0	121.0	217 10.100	
5.410		139.0	91.0	217 5.410		10.200		184.0	121.0	217 10.200	667 10.200
5.450		139.0	91.0	217 5.450		10.250		184.0	121.0	217 10.250	
5.500		139.0	91.0	217 5.500	667 5.500	10.260		184.0	121.0	217 10.260	
5.550		139.0	91.0	217 5.550		10.300		184.0	121.0	217 10.300	
5.560	7/32	139.0	91.0	217 5.560	667 5.560	10.320	13/32	184.0	121.0	217 10.320	667 10.320
5.600		139.0	91.0	217 5.600	667 5.600	10.400		184.0	121.0	217 10.400	
5.610		139.0	91.0	217 5.610		10.490		184.0	121.0	217 10.490	
5.650		139.0	91.0	217 5.650		10.500		184.0	121.0	217 10.500	667 10.500
5.700		139.0	91.0	217 5.700	667 5.700	10.600		184.0	121.0	217 10.600	
5.750		139.0	91.0	217 5.750		10.700		195.0	128.0	217 10.700	
5.790		139.0	91.0	217 5.790	667 5.790	10.720	27/64	195.0	128.0	217 10.720	667 10.720
5.800		139.0	91.0	217 5.800		10.750		195.0	128.0	217 10.750	
5.850		139.0	91.0	217 5.850		10.800		195.0	128.0	217 10.800	667 10.800
5.900		139.0	91.0	217 5.900	667 5.900	10.900		195.0	128.0	217 10.900	667 10.900
5.940		139.0	91.0	217 5.940		11.000		195.0	128.0	217 11.000	667 11.000
5.950	15/64	139.0	91.0	217 5.950		11.110	7/16	195.0	128.0	217 11.110	667 11.110
6.000		139.0	91.0	217 6.000	667 6.000	11.200		195.0	128.0	217 11.200	
6.060		148.0	97.0	217 6.060		11.300		195.0	128.0	217 11.300	
6.100		148.0	97.0	217 6.100	667 6.100	11.400		195.0	128.0	217 11.400	
6.200		148.0	97.0	217 6.200	667 6.200	11.500		195.0	128.0	217 11.500	667 11.500
6.250		148.0	97.0	217 6.250	667 6.250	11.510	29/64	195.0	128.0	217 11.510	
6.300		148.0	97.0	217 6.300		11.700		195.0	128.0	217 11.700	
6.350	1/4	148.0	97.0	217 6.350	667 6.350	11.750		195.0	128.0	217 11.750	667 11.750
6.400		148.0	97.0	217 6.400	667 6.400	11.800		195.0	128.0	217 11.800	667 11.800
6.500		148.0	97.0	217 6.500	667 6.500	11.910	15/32	205.0	134.0	217 11.910	667 11.910



Article no.				217	667	Article no.				217	667
d1 mm	inch	l1 mm	l2 mm	Order no.		d1 mm	inch	l1 mm	l2 mm	Order no.	
12.000		205.0	134.0	217 12.000	667 12.000	17.070	43/64	241.0	158.0	217 17.070	
12.100		205.0	134.0	217 12.100		17.460	11/16	241.0	158.0	217 17.460	667 17.460
12.200		205.0	134.0	217 12.200		17.500		241.0	158.0	217 17.500	
12.300	31/64	205.0	134.0	217 12.300		17.800		241.0	158.0	217 17.800	
12.500		205.0	134.0	217 12.500	667 12.500	17.860		241.0	158.0	217 17.860	
12.700	1/2	205.0	134.0	217 12.700	667 12.700	18.000		241.0	158.0	217 18.000	667 18.000
12.800		205.0	134.0	217 12.800		18.250		247.0	162.0		667 18.250
13.000		205.0	134.0	217 13.000	667 13.000	18.500		247.0	162.0	217 18.500	
13.100	33/64	205.0	134.0	217 13.100		18.650	47/64	247.0	162.0	217 18.650	
13.200		205.0	134.0	217 13.200		19.000		247.0	162.0	217 19.000	
13.490	17/32	214.0	140.0	217 13.490	667 13.490	19.050	3/4	254.0	166.0	217 19.050	
13.500		214.0	140.0	217 13.500	667 13.500	19.450		254.0	166.0	217 19.450	
13.750		214.0	140.0	217 13.750		19.500		254.0	166.0	217 19.500	
13.800		214.0	140.0	217 13.800	667 13.800	20.000		254.0	166.0	217 20.000	
13.890	35/64	214.0	140.0	217 13.890	667 13.890	20.240		261.0	171.0	217 20.240	
14.000		214.0	140.0	217 14.000	667 14.000	20.500		261.0	171.0	217 20.500	
14.200		220.0	144.0	217 14.200		20.640	13/16	261.0	171.0	217 20.640	
14.250		220.0	144.0	217 14.250		21.000		261.0	171.0	217 21.000	
14.290	9/16	220.0	144.0	217 14.290	667 14.290	21.030		261.0	171.0	217 21.030	
14.500		220.0	144.0	217 14.500	667 14.500	21.500		268.0	176.0	217 21.500	
14.750		220.0	144.0		667 14.750	21.830		268.0	176.0	217 21.830	
14.800		220.0	144.0		667 14.800	22.000		268.0	176.0	217 22.000	
14.900		220.0	144.0	217 14.900	667 14.900	22.220	7/8	268.0	176.0		667 22.220
15.000		220.0	144.0	217 15.000	667 15.000	22.620		275.0	180.0	217 22.620	
15.080	19/32	227.0	149.0	217 15.080	667 15.080	23.020		275.0	180.0	217 23.020	
15.250		227.0	149.0	217 15.250		23.810	15/16	282.0	185.0	217 23.810	
15.480	39/64	227.0	149.0	217 15.480		24.000		282.0	185.0	217 24.000	
15.500		227.0	149.0	217 15.500		25.000	63/64	282.0	185.0	217 25.000	
15.600		227.0	149.0	217 15.600		26.500		290.0	190.0	217 26.500	
15.870	5/8	227.0	149.0	217 15.870	667 15.870	28.570	1 1/8	307.0	201.0	217 28.570	
16.000		227.0	149.0	217 16.000	667 16.000	29.000		307.0	201.0	217 29.000	
16.270	41/64	235.0	154.0	217 16.270		29.500		307.0	201.0	217 29.500	
16.500		235.0	154.0	217 16.500	667 16.500	31.000		316.0	207.0	217 31.000	
16.670	21/32	235.0	154.0	217 16.670	667 16.670						
16.750		235.0	154.0		667 16.750						
17.000		235.0	154.0	217 17.000	667 17.000						

HSS/HSCO drills



Long series twist drills

Article no. **220**



Cutting data page 459



Web thinning $\geq \varnothing 14.750$ • relieved cone • for deep holes • for drilling through drill bushes

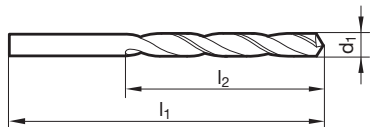

Article no. 220				Article no. 220					
d1 mm	inch	l1 mm	l2 mm	Order no.	d1 mm	inch	l1 mm	l2 mm	Order no.
0.450		30.0	10.0	220 0.450	4.000		119.0	78.0	220 4.000
0.900		51.0	29.0	220 0.900	4.050		119.0	78.0	220 4.050
1.100		60.0	37.0	220 1.100	4.300		126.0	82.0	220 4.300
1.200		65.0	41.0	220 1.200	4.500		126.0	82.0	220 4.500
1.400		70.0	45.0	220 1.400	4.780		132.0	87.0	220 4.780
1.500		70.0	45.0	220 1.500	4.800		132.0	87.0	220 4.800
1.600		76.0	50.0	220 1.600	5.000		132.0	87.0	220 5.000
1.630		76.0	50.0	220 1.630	5.100		132.0	87.0	220 5.100
1.800		80.0	53.0	220 1.800	5.700		139.0	91.0	220 5.700
1.850		80.0	53.0	220 1.850	6.000		139.0	91.0	220 6.000
1.900		80.0	53.0	220 1.900	6.500		148.0	97.0	220 6.500
2.000		85.0	56.0	220 2.000	6.800		156.0	102.0	220 6.800
2.500		95.0	62.0	220 2.500	7.200		156.0	102.0	220 7.200
2.900		100.0	66.0	220 2.900	7.500		156.0	102.0	220 7.500
2.950		100.0	66.0	220 2.950	8.000		165.0	109.0	220 8.000
3.000		100.0	66.0	220 3.000	9.000		175.0	115.0	220 9.000
3.070		106.0	69.0	220 3.070	10.500		184.0	121.0	220 10.500
3.100		106.0	69.0	220 3.100	11.900		205.0	134.0	220 11.900
3.250		106.0	69.0	220 3.250	12.000		205.0	134.0	220 12.000
3.300		106.0	69.0	220 3.300	12.500		205.0	134.0	220 12.500
3.400		112.0	73.0	220 3.400	13.500		214.0	140.0	220 13.500
3.550		112.0	73.0	220 3.550	19.000		247.0	162.0	220 19.000
3.600		112.0	73.0	220 3.600	20.000		254.0	166.0	220 20.000
3.700		112.0	73.0	220 3.700	25.500		290.0	190.0	220 25.500



Long series twist drills

Article no. **204**



Cutting data page 459

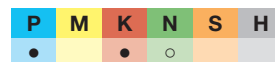
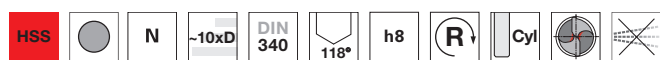

Web thinning $\geq \varnothing 2.950$ • relieved cone • with tang

HSS/HSCO drills

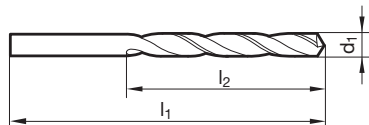

Article no. 204				Article no. 204					
d1	inch	l1	l2	Order no.	d1	inch	l1	l2	Order no.
2.950		100.0	66.0	204 2.950	6.900		156.0	102.0	204 6.900
3.000		100.0	66.0	204 3.000	7.000		156.0	102.0	204 7.000
3.100		106.0	69.0	204 3.100	7.500		156.0	102.0	204 7.500
3.200		106.0	69.0	204 3.200	7.700		165.0	109.0	204 7.700
3.300		106.0	69.0	204 3.300	7.800		165.0	109.0	204 7.800
3.400		112.0	73.0	204 3.400	8.000		165.0	109.0	204 8.000
3.500		112.0	73.0	204 3.500	8.250		165.0	109.0	204 8.250
3.800		119.0	78.0	204 3.800	8.400		165.0	109.0	204 8.400
3.900		119.0	78.0	204 3.900	8.450		165.0	109.0	204 8.450
4.000		119.0	78.0	204 4.000	8.500		165.0	109.0	204 8.500
4.050		119.0	78.0	204 4.050	8.600		175.0	115.0	204 8.600
4.100		119.0	78.0	204 4.100	8.700		175.0	115.0	204 8.700
4.200		119.0	78.0	204 4.200	8.750		175.0	115.0	204 8.750
4.250		119.0	78.0	204 4.250	8.800		175.0	115.0	204 8.800
4.300		126.0	82.0	204 4.300	9.000		175.0	115.0	204 9.000
4.400		126.0	82.0	204 4.400	9.300		175.0	115.0	204 9.300
4.500		126.0	82.0	204 4.500	9.400		175.0	115.0	204 9.400
4.700		126.0	82.0	204 4.700	9.800		184.0	121.0	204 9.800
4.800		132.0	87.0	204 4.800	10.000		184.0	121.0	204 10.000
5.000		132.0	87.0	204 5.000	10.200		184.0	121.0	204 10.200
5.080		132.0	87.0	204 5.080	10.300		184.0	121.0	204 10.300
5.100		132.0	87.0	204 5.100	10.500		184.0	121.0	204 10.500
5.200		132.0	87.0	204 5.200	10.800		195.0	128.0	204 10.800
5.500		139.0	91.0	204 5.500	12.000		205.0	134.0	204 12.000
5.600		139.0	91.0	204 5.600	13.000		205.0	134.0	204 13.000
5.800		139.0	91.0	204 5.800	25.250		290.0	190.0	204 25.250
5.900		139.0	91.0	204 5.900					
6.000		139.0	91.0	204 6.000					
6.100		148.0	97.0	204 6.100					
6.200		148.0	97.0	204 6.200					
6.300		148.0	97.0	204 6.300					
6.400		148.0	97.0	204 6.400					
6.500		148.0	97.0	204 6.500					
6.600		148.0	97.0	204 6.600					
6.700		148.0	97.0	204 6.700					
6.800		156.0	102.0	204 6.800					



HSS/HSCO drills

Long series twist drills

Article no. **218**



Cutting data page 460

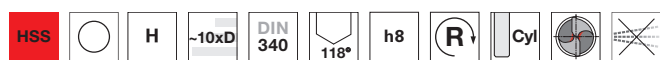

Web thinning $\geq \varnothing 15.000$ • relieved cone • for deep holes

P	M	K	N	S	H
			•		

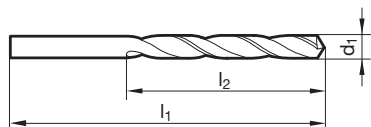

Article no.				218				Article no.				218			
d1	inch	l1	l2	Order no.	d1	inch	l1	l2	Order no.	d1	inch	l1	l2	Order no.	
mm		mm	mm		mm		mm	mm		mm		mm	mm		
0.500		32.0	12.0	218 0.500	3.250		106.0	69.0	218 3.250						
0.520		32.0	12.0	218 0.520	3.270		106.0	69.0	218 3.270						
0.550		35.0	15.0	218 0.550	3.300		106.0	69.0	218 3.300						
0.600		35.0	15.0	218 0.600	3.400		112.0	73.0	218 3.400						
0.650		38.0	18.0	218 0.650	3.500		112.0	73.0	218 3.500						
0.700		42.0	21.0	218 0.700	3.550		112.0	73.0	218 3.550						
0.750		42.0	21.0	218 0.750	3.600		112.0	73.0	218 3.600						
0.800		46.0	25.0	218 0.800	3.800		119.0	78.0	218 3.800						
0.840		46.0	25.0	218 0.840	3.900		119.0	78.0	218 3.900						
0.900		51.0	29.0	218 0.900	3.970	5/32	119.0	78.0	218 3.970						
0.950		51.0	29.0	218 0.950	4.000		119.0	78.0	218 4.000						
0.970		56.0	33.0	218 0.970	4.030		119.0	78.0	218 4.030						
1.000		56.0	33.0	218 1.000	4.100		119.0	78.0	218 4.100						
1.050		56.0	33.0	218 1.050	4.200		119.0	78.0	218 4.200						
1.100		60.0	37.0	218 1.100	4.300		126.0	82.0	218 4.300						
1.150		60.0	37.0	218 1.150	4.400		126.0	82.0	218 4.400						
1.200		65.0	41.0	218 1.200	4.500		126.0	82.0	218 4.500						
1.250		65.0	41.0	218 1.250	4.600		126.0	82.0	218 4.600						
1.300		65.0	41.0	218 1.300	4.700		126.0	82.0	218 4.700						
1.400		70.0	45.0	218 1.400	4.760	3/16	132.0	87.0	218 4.760						
1.500		70.0	45.0	218 1.500	4.900		132.0	87.0	218 4.900						
1.560		76.0	50.0	218 1.560	5.000		132.0	87.0	218 5.000						
1.570		76.0	50.0	218 1.570	5.100		132.0	87.0	218 5.100						
1.580		76.0	50.0	218 1.580	5.200		132.0	87.0	218 5.200						
1.600		76.0	50.0	218 1.600	5.300		132.0	87.0	218 5.300						
1.650		76.0	50.0	218 1.650	5.400		139.0	91.0	218 5.400						
1.700		76.0	50.0	218 1.700	5.450		139.0	91.0	218 5.450						
1.750		80.0	53.0	218 1.750	5.500		139.0	91.0	218 5.500						
1.800		80.0	53.0	218 1.800	5.600		139.0	91.0	218 5.600						
1.820		80.0	53.0	218 1.820	5.900		139.0	91.0	218 5.900						
1.850		80.0	53.0	218 1.850	6.000		139.0	91.0	218 6.000						
1.900		80.0	53.0	218 1.900	6.100		148.0	97.0	218 6.100						
1.950		85.0	56.0	218 1.950	6.200		148.0	97.0	218 6.200						
2.000		85.0	56.0	218 2.000	6.300		148.0	97.0	218 6.300						
2.100		85.0	56.0	218 2.100	6.500		148.0	97.0	218 6.500						
2.180		90.0	59.0	218 2.180	6.600		148.0	97.0	218 6.600						
2.200		90.0	59.0	218 2.200	6.800		156.0	102.0	218 6.800						
2.250		90.0	59.0	218 2.250	6.900		156.0	102.0	218 6.900						
2.300		90.0	59.0	218 2.300	7.000		156.0	102.0	218 7.000						
2.350		90.0	59.0	218 2.350	7.200		156.0	102.0	218 7.200						
2.400		95.0	62.0	218 2.400	7.350		156.0	102.0	218 7.350						
2.500		95.0	62.0	218 2.500	7.500		156.0	102.0	218 7.500						
2.550		95.0	62.0	218 2.550	7.700		165.0	109.0	218 7.700						
2.600		95.0	62.0	218 2.600	8.000		165.0	109.0	218 8.000						
2.650		95.0	62.0	218 2.650	8.300		165.0	109.0	218 8.300						
2.700		100.0	66.0	218 2.700	8.400		165.0	109.0	218 8.400						
2.800		100.0	66.0	218 2.800	9.000		175.0	115.0	218 9.000						
2.900		100.0	66.0	218 2.900	9.700		184.0	121.0	218 9.700						
3.000		100.0	66.0	218 3.000	10.000		184.0	121.0	218 10.000						
3.020		106.0	69.0	218 3.020	12.100		205.0	134.0	218 12.100						
3.060		106.0	69.0	218 3.060	14.000		214.0	140.0	218 14.000						
3.100		106.0	69.0	218 3.100	15.000		220.0	144.0	218 15.000						
3.180		106.0	69.0	218 3.180	16.000		227.0	149.0	218 16.000						
3.200		106.0	69.0	218 3.200											



Long series twist drills

Article no. **219**



Cutting data page 461

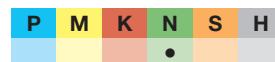
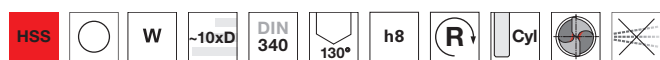

Web thinning $\geq \varnothing 14.500$ • relieved cone • for deep holes

HSS/HSCO drills

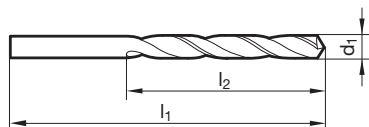

Article no. 219				Article no. 219					
d1 mm	inch	l1 mm	l2 mm	Order no.	d1 mm	inch	l1 mm	l2 mm	Order no.
0.500		32.0	12.0	219 0.500	3.400		112.0	73.0	219 3.400
0.600		35.0	15.0	219 0.600	3.500		112.0	73.0	219 3.500
0.650		38.0	18.0	219 0.650	3.600		112.0	73.0	219 3.600
0.700		42.0	21.0	219 0.700	3.650		112.0	73.0	219 3.650
0.740		42.0	21.0	219 0.740	3.700		112.0	73.0	219 3.700
0.750		42.0	21.0	219 0.750	3.750		112.0	73.0	219 3.750
0.800		46.0	25.0	219 0.800	3.800		119.0	78.0	219 3.800
0.850		46.0	25.0	219 0.850	3.830		119.0	78.0	219 3.830
0.900		51.0	29.0	219 0.900	3.900		119.0	78.0	219 3.900
0.950		51.0	29.0	219 0.950	3.920		119.0	78.0	219 3.920
0.970		56.0	33.0	219 0.970	4.000		119.0	78.0	219 4.000
0.980		56.0	33.0	219 0.980	4.100		119.0	78.0	219 4.100
1.000		56.0	33.0	219 1.000	4.150		119.0	78.0	219 4.150
1.100		60.0	37.0	219 1.100	4.200		119.0	78.0	219 4.200
1.180		60.0	37.0	219 1.180	4.250		119.0	78.0	219 4.250
1.190	3/64	65.0	41.0	219 1.190	4.300		126.0	82.0	219 4.300
1.200		65.0	41.0	219 1.200	4.400		126.0	82.0	219 4.400
1.220		65.0	41.0	219 1.220	4.500		126.0	82.0	219 4.500
1.250		65.0	41.0	219 1.250	4.700		126.0	82.0	219 4.700
1.300		65.0	41.0	219 1.300	4.800		132.0	87.0	219 4.800
1.350		70.0	45.0	219 1.350	4.830		132.0	87.0	219 4.830
1.370		70.0	45.0	219 1.370	4.870		132.0	87.0	219 4.870
1.400		70.0	45.0	219 1.400	4.900		132.0	87.0	219 4.900
1.440		70.0	45.0	219 1.440	5.000		132.0	87.0	219 5.000
1.500		70.0	45.0	219 1.500	5.100		132.0	87.0	219 5.100
1.520		76.0	50.0	219 1.520	5.200		132.0	87.0	219 5.200
1.600		76.0	50.0	219 1.600	5.300		132.0	87.0	219 5.300
1.610		76.0	50.0	219 1.610	5.400		139.0	91.0	219 5.400
1.650		76.0	50.0	219 1.650	5.500		139.0	91.0	219 5.500
1.700		76.0	50.0	219 1.700	5.650		139.0	91.0	219 5.650
1.750		80.0	53.0	219 1.750	5.700		139.0	91.0	219 5.700
1.760		80.0	53.0	219 1.760	5.800		139.0	91.0	219 5.800
1.780		80.0	53.0	219 1.780	5.900		139.0	91.0	219 5.900
1.800		80.0	53.0	219 1.800	5.980		139.0	91.0	219 5.980
1.850		80.0	53.0	219 1.850	6.000		139.0	91.0	219 6.000
1.900		80.0	53.0	219 1.900	6.100		148.0	97.0	219 6.100
1.950		85.0	56.0	219 1.950	6.300		148.0	97.0	219 6.300
2.000		85.0	56.0	219 2.000	6.400		148.0	97.0	219 6.400
2.050		85.0	56.0	219 2.050	6.500		148.0	97.0	219 6.500
2.100		85.0	56.0	219 2.100	6.600		148.0	97.0	219 6.600
2.150		90.0	59.0	219 2.150	6.700		148.0	97.0	219 6.700
2.200		90.0	59.0	219 2.200	6.800		156.0	102.0	219 6.800
2.250		90.0	59.0	219 2.250	6.900		156.0	102.0	219 6.900
2.300		90.0	59.0	219 2.300	7.000		156.0	102.0	219 7.000
2.350		90.0	59.0	219 2.350	7.100		156.0	102.0	219 7.100
2.380	3/32	95.0	62.0	219 2.380	7.300		156.0	102.0	219 7.300
2.400		95.0	62.0	219 2.400	7.400		156.0	102.0	219 7.400
2.430		95.0	62.0	219 2.430	7.500		156.0	102.0	219 7.500
2.500		95.0	62.0	219 2.500	7.700		165.0	109.0	219 7.700
2.550		95.0	62.0	219 2.550	7.800		165.0	109.0	219 7.800
2.600		95.0	62.0	219 2.600	7.850		165.0	109.0	219 7.850
2.650		95.0	62.0	219 2.650	8.000		165.0	109.0	219 8.000
2.700		100.0	66.0	219 2.700	8.100		165.0	109.0	219 8.100
2.750		100.0	66.0	219 2.750	8.300		165.0	109.0	219 8.300
2.800		100.0	66.0	219 2.800	8.500		165.0	109.0	219 8.500
2.850		100.0	66.0	219 2.850	8.550		175.0	115.0	219 8.550
2.900		100.0	66.0	219 2.900	8.600		175.0	115.0	219 8.600
2.950		100.0	66.0	219 2.950	8.700		175.0	115.0	219 8.700
3.000		100.0	66.0	219 3.000	8.750		175.0	115.0	219 8.750
3.050		106.0	69.0	219 3.050	8.800		175.0	115.0	219 8.800
3.100		106.0	69.0	219 3.100	8.900		175.0	115.0	219 8.900
3.170	1/8	106.0	69.0	219 3.170	9.000		175.0	115.0	219 9.000
3.200		106.0	69.0	219 3.200	9.100		175.0	115.0	219 9.100
3.250		106.0	69.0	219 3.250	9.300		175.0	115.0	219 9.300
3.300		106.0	69.0	219 3.300	9.700		184.0	121.0	219 9.700
3.350		106.0	69.0	219 3.350	9.800		184.0	121.0	219 9.800



HSS/HSCO drills with straight shank

HSS/HSCO drills

Article no.				219				Article no.				219			
d1 mm	inch	l1 mm	l2 mm	Order no.				d1 mm	inch	l1 mm	l2 mm	Order no.			
10.000		184.0	121.0	219 10.000				14.500		220.0	144.0	219 14.500			
10.500		184.0	121.0	219 10.500				15.000		220.0	144.0	219 15.000			
10.700		195.0	128.0	219 10.700				17.000		235.0	154.0	219 17.000			
10.750		195.0	128.0	219 10.750				19.000		247.0	162.0	219 19.000			
11.000		195.0	128.0	219 11.000				19.800		254.0	166.0	219 19.800			
11.300		195.0	128.0	219 11.300				19.840	25/32	254.0	166.0	219 19.840			
11.400		195.0	128.0	219 11.400				20.000		254.0	166.0	219 20.000			
11.500		195.0	128.0	219 11.500				20.640	13/16	261.0	171.0	219 20.640			
12.000		205.0	134.0	219 12.000											
13.100	33/64	205.0	134.0	219 13.100											
13.500		214.0	140.0	219 13.500											
14.000		214.0	140.0	219 14.000											

Long series twist drills

 Article no. **535**

 Web thinning $\geq \varnothing 1.000$ • relieved cone • wide flutes • in case of poor chip evacuation

Cutting data page 462

P	M	K	N	S	H
•		•	•		

Long series twist drills

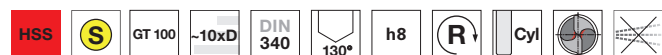
 Article no. **668**

 Web thinning $\geq \varnothing 1.000$ • relieved cone • wide flutes • in case of poor chip evacuation

Cutting data page 462

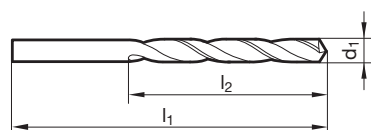
P	M	K	N	S	H
•		•	○		



Article no. 535				Article no. 668		Article no. 535				Article no. 668	
d1 mm	inch	l1 mm	l2 mm	Order no.		d1 mm	inch	l1 mm	l2 mm	Order no.	
1.000		56.0	33.0	535 1.000	668 1.000	2.500		95.0	62.0	535 2.500	668 2.500
1.020		56.0	33.0	535 1.020		2.530		95.0	62.0	535 2.530	668 2.530
1.040		56.0	33.0	535 1.040		2.550		95.0	62.0	535 2.550	668 2.550
1.050		56.0	33.0	535 1.050		2.580		95.0	62.0	535 2.580	668 2.580
1.070		60.0	37.0	535 1.070		2.600		95.0	62.0	535 2.600	668 2.600
1.090		60.0	37.0	535 1.090	668 1.090	2.640		95.0	62.0	535 2.640	668 2.640
1.100		60.0	37.0	535 1.100	668 1.100	2.650		95.0	62.0	535 2.650	
1.150		60.0	37.0	535 1.150		2.700		100.0	66.0	535 2.700	668 2.700
1.180		60.0	37.0	535 1.180	668 1.180	2.710		100.0	66.0	535 2.710	668 2.710
1.190	3/64	65.0	41.0	535 1.190	668 1.190	2.750		100.0	66.0	535 2.750	
1.200		65.0	41.0	535 1.200	668 1.200	2.780	7/64	100.0	66.0	535 2.780	668 2.780
1.250		65.0	41.0	535 1.250		2.790		100.0	66.0	535 2.790	
1.300		65.0	41.0	535 1.300	668 1.300	2.800		100.0	66.0	535 2.800	668 2.800
1.320		65.0	41.0	535 1.320	668 1.320	2.820		100.0	66.0	535 2.820	668 2.820
1.350		70.0	45.0	535 1.350		2.830		100.0	66.0	535 2.830	
1.400		70.0	45.0	535 1.400	668 1.400	2.850		100.0	66.0	535 2.850	
1.450		70.0	45.0	535 1.450		2.870		100.0	66.0	535 2.870	668 2.870
1.500		70.0	45.0	535 1.500	668 1.500	2.900		100.0	66.0	535 2.900	668 2.900
1.510		76.0	50.0	535 1.510	668 1.510	2.950		100.0	66.0	535 2.950	668 2.950
1.520		76.0	50.0	535 1.520		3.000		100.0	66.0	535 3.000	668 3.000
1.550		76.0	50.0	535 1.550		3.050		106.0	69.0	535 3.050	668 3.050
1.590	1/16	76.0	50.0	535 1.590	668 1.590	3.100		106.0	69.0	535 3.100	668 3.100
1.600		76.0	50.0	535 1.600	668 1.600	3.150		106.0	69.0	535 3.150	
1.650		76.0	50.0	535 1.650	668 1.650	3.170	1/8	106.0	69.0	535 3.170	668 3.170
1.670		76.0	50.0	535 1.670		3.200		106.0	69.0	535 3.200	668 3.200
1.700		76.0	50.0	535 1.700	668 1.700	3.250		106.0	69.0	535 3.250	668 3.250
1.750		80.0	53.0	535 1.750		3.260		106.0	69.0	535 3.260	
1.780		80.0	53.0	535 1.780		3.270		106.0	69.0	535 3.270	
1.800		80.0	53.0	535 1.800	668 1.800	3.300		106.0	69.0	535 3.300	668 3.300
1.850		80.0	53.0	535 1.850	668 1.850	3.400		112.0	73.0	535 3.400	668 3.400
1.900		80.0	53.0	535 1.900	668 1.900	3.450		112.0	73.0	535 3.450	668 3.450
1.930		85.0	56.0	535 1.930	668 1.930	3.500		112.0	73.0	535 3.500	668 3.500
1.950		85.0	56.0	535 1.950	668 1.950	3.550		112.0	73.0	535 3.550	
1.980	5/64	85.0	56.0	535 1.980	668 1.980	3.570	9/64	112.0	73.0	535 3.570	668 3.570
1.990		85.0	56.0	535 1.990	668 1.990	3.600		112.0	73.0	535 3.600	668 3.600
2.000		85.0	56.0	535 2.000	668 2.000	3.660		112.0	73.0	535 3.660	
2.050		85.0	56.0	535 2.050	668 2.050	3.700		112.0	73.0	535 3.700	668 3.700
2.060		85.0	56.0	535 2.060	668 2.060	3.730		112.0	73.0	535 3.730	668 3.730
2.080		85.0	56.0	535 2.080	668 2.080	3.750		112.0	73.0	535 3.750	
2.100		85.0	56.0	535 2.100	668 2.100	3.800		119.0	78.0	535 3.800	668 3.800
2.150		90.0	59.0	535 2.150		3.860		119.0	78.0	535 3.860	668 3.860
2.180		90.0	59.0	535 2.180	668 2.180	3.900		119.0	78.0	535 3.900	668 3.900
2.200		90.0	59.0	535 2.200	668 2.200	3.910		119.0	78.0	535 3.910	
2.250		90.0	59.0	535 2.250		3.970	5/32	119.0	78.0	535 3.970	668 3.970
2.260		90.0	59.0	535 2.260	668 2.260	3.990		119.0	78.0	535 3.990	
2.300		90.0	59.0	535 2.300	668 2.300	4.000		119.0	78.0	535 4.000	668 4.000
2.350		90.0	59.0	535 2.350		4.040		119.0	78.0	535 4.040	668 4.040
2.370		95.0	62.0	535 2.370		4.050		119.0	78.0	535 4.050	
2.380	3/32	95.0	62.0	535 2.380	668 2.380	4.090		119.0	78.0	535 4.090	668 4.090
2.400		95.0	62.0	535 2.400	668 2.400	4.100		119.0	78.0	535 4.100	668 4.100
2.440		95.0	62.0	535 2.440		4.130		119.0	78.0	535 4.130	
2.450		95.0	62.0	535 2.450		4.150		119.0	78.0	535 4.150	
2.480		95.0	62.0	535 2.480		4.200		119.0	78.0	535 4.200	668 4.200
2.490		95.0	62.0	535 2.490	668 2.490	4.220		119.0	78.0	535 4.220	668 4.220



HSS/HSCO drills with straight shank

HSS/HSCO drills

Article no.				535	668	Article no.				535	668
d1 mm	inch	l1 mm	l2 mm	Order no.		d1 mm	inch	l1 mm	l2 mm	Order no.	
4.250		119.0	78.0	535 4.250		7.670		165.0	109.0	535 7.670	
4.300		126.0	82.0	535 4.300	668 4.300	7.700		165.0	109.0	535 7.700	668 7.700
4.350		126.0	82.0	535 4.350		7.750		165.0	109.0	535 7.750	
4.370	11/64	126.0	82.0	535 4.370	668 4.370	7.800		165.0	109.0	535 7.800	668 7.800
4.390		126.0	82.0	535 4.390		7.850		165.0	109.0	535 7.850	
4.400		126.0	82.0	535 4.400	668 4.400	7.900		165.0	109.0	535 7.900	
4.500		126.0	82.0	535 4.500	668 4.500	7.940	5/16	165.0	109.0	535 7.940	668 7.940
4.570		126.0	82.0	535 4.570		8.000		165.0	109.0	535 8.000	668 8.000
4.600		126.0	82.0	535 4.600	668 4.600	8.030		165.0	109.0	535 8.030	
4.620		126.0	82.0	535 4.620		8.100		165.0	109.0	535 8.100	668 8.100
4.700		126.0	82.0	535 4.700	668 4.700	8.200		165.0	109.0	535 8.200	668 8.200
4.750		126.0	82.0	535 4.750		8.250		165.0	109.0	535 8.250	
4.760	3/16	132.0	87.0	535 4.760	668 4.760	8.300		165.0	109.0	535 8.300	668 8.300
4.800		132.0	87.0	535 4.800	668 4.800	8.330	21/64	165.0	109.0	535 8.330	
4.850		132.0	87.0	535 4.850	668 4.850	8.400		165.0	109.0	535 8.400	668 8.400
4.900		132.0	87.0	535 4.900		8.430		165.0	109.0	535 8.430	668 8.430
4.910		132.0	87.0		668 4.910	8.500		165.0	109.0	535 8.500	668 8.500
4.920		132.0	87.0	535 4.920	668 4.920	8.600		175.0	115.0	535 8.600	668 8.600
4.980		132.0	87.0	535 4.980		8.610		175.0	115.0	535 8.610	668 8.610
5.000		132.0	87.0	535 5.000	668 5.000	8.700		175.0	115.0	535 8.700	668 8.700
5.050		132.0	87.0	535 5.050		8.730	11/32	175.0	115.0	535 8.730	668 8.730
5.060		132.0	87.0	535 5.060	668 5.060	8.800		175.0	115.0	535 8.800	668 8.800
5.100		132.0	87.0	535 5.100	668 5.100	8.840		175.0	115.0	535 8.840	
5.110		132.0	87.0	535 5.110		8.900		175.0	115.0	535 8.900	668 8.900
5.160	13/64	132.0	87.0	535 5.160	668 5.160	9.000		175.0	115.0	535 9.000	668 9.000
5.180		132.0	87.0	535 5.180		9.090		175.0	115.0	535 9.090	
5.200		132.0	87.0	535 5.200	668 5.200	9.100		175.0	115.0	535 9.100	668 9.100
5.220		132.0	87.0	535 5.220		9.130	23/64	175.0	115.0	535 9.130	668 9.130
5.250		132.0	87.0	535 5.250		9.200		175.0	115.0	535 9.200	668 9.200
5.300		132.0	87.0	535 5.300	668 5.300	9.300		175.0	115.0	535 9.300	668 9.300
5.310		139.0	91.0	535 5.310		9.340		175.0	115.0	535 9.340	668 9.340
5.400		139.0	91.0	535 5.400	668 5.400	9.350		175.0	115.0	535 9.350	
5.410		139.0	91.0	535 5.410		9.400		175.0	115.0	535 9.400	668 9.400
5.500		139.0	91.0	535 5.500	668 5.500	9.500		175.0	115.0	535 9.500	668 9.500
5.560	7/32	139.0	91.0	535 5.560	668 5.560	9.520	3/8	184.0	121.0	535 9.520	668 9.520
5.600		139.0	91.0	535 5.600	668 5.600	9.600		184.0	121.0	535 9.600	
5.610		139.0	91.0	535 5.610		9.700		184.0	121.0	535 9.700	668 9.700
5.700		139.0	91.0	535 5.700	668 5.700	9.800		184.0	121.0	535 9.800	
5.750		139.0	91.0	535 5.750		9.900		184.0	121.0	535 9.900	668 9.900
5.790		139.0	91.0	535 5.790		9.920	25/64	184.0	121.0	535 9.920	668 9.920
5.800		139.0	91.0	535 5.800	668 5.800	10.000		184.0	121.0	535 10.000	668 10.000
5.900		139.0	91.0	535 5.900	668 5.900	10.080		184.0	121.0	535 10.080	
5.940		139.0	91.0	535 5.940		10.100		184.0	121.0	535 10.100	668 10.100
5.950	15/64	139.0	91.0	535 5.950	668 5.950	10.200		184.0	121.0	535 10.200	668 10.200
6.000		139.0	91.0	535 6.000	668 6.000	10.300		184.0	121.0	535 10.300	
6.040		148.0	97.0	535 6.040	668 6.040	10.320	13/32	184.0	121.0	535 10.320	668 10.320
6.050		148.0	97.0	535 6.050		10.400		184.0	121.0	535 10.400	
6.100		148.0	97.0	535 6.100	668 6.100	10.490		184.0	121.0	535 10.490	
6.150		148.0	97.0	535 6.150	668 6.150	10.500		184.0	121.0	535 10.500	668 10.500
6.200		148.0	97.0	535 6.200	668 6.200	10.600		184.0	121.0	535 10.600	
6.250		148.0	97.0	535 6.250	668 6.250	10.720	27/64	195.0	128.0	535 10.720	668 10.720
6.300		148.0	97.0	535 6.300	668 6.300	10.800		195.0	128.0	535 10.800	
6.350	1/4	148.0	97.0	535 6.350	668 6.350	10.900		195.0	128.0	535 10.900	
6.400		148.0	97.0	535 6.400	668 6.400	11.000		195.0	128.0	535 11.000	668 11.000
6.500		148.0	97.0	535 6.500	668 6.500	11.110	7/16	195.0	128.0	535 11.110	668 11.110
6.530		148.0	97.0	535 6.530	668 6.530	11.300		195.0	128.0	535 11.300	668 11.300
6.600		148.0	97.0	535 6.600	668 6.600	11.500		195.0	128.0	535 11.500	668 11.500
6.630		148.0	97.0	535 6.630	668 6.630	11.800		195.0	128.0	535 11.800	
6.700		148.0	97.0	535 6.700	668 6.700	11.910	15/32	205.0	134.0	535 11.910	668 11.910
6.750	17/64	156.0	102.0	535 6.750	668 6.750	12.000		205.0	134.0	535 12.000	668 12.000
6.800		156.0	102.0	535 6.800	668 6.800	12.150		205.0	134.0	535 12.150	
6.900		156.0	102.0	535 6.900	668 6.900	12.300	31/64	205.0	134.0	535 12.300	668 12.300
6.910		156.0	102.0	535 6.910		12.500		205.0	134.0	535 12.500	668 12.500
7.000		156.0	102.0	535 7.000	668 7.000	12.600		205.0	134.0	535 12.600	
7.030		156.0	102.0	535 7.030		12.700	1/2	205.0	134.0	535 12.700	668 12.700
7.040		156.0	102.0	535 7.040		13.000		205.0	134.0	535 13.000	668 13.000
7.100		156.0	102.0	535 7.100	668 7.100	13.100	33/64	205.0	134.0	535 13.100	
7.140	9/32	156.0	102.0	535 7.140	668 7.140	13.490	17/32	214.0	140.0	535 13.490	
7.200		156.0	102.0	535 7.200	668 7.200	13.500		214.0	140.0	535 13.500	
7.250		156.0	102.0		668 7.250	13.890	35/64	214.0	140.0	535 13.890	
7.300		156.0	102.0	535 7.300		13.900		214.0	140.0	535 13.900	
7.370		156.0	102.0	535 7.370		14.000		214.0	140.0	535 14.000	668 14.000
7.400		156.0	102.0	535 7.400							
7.450		156.0	102.0	535 7.450							
7.490		156.0	102.0	535 7.490							
7.500		156.0	102.0	535 7.500	668 7.500						
7.540	19/64	165.0	109.0	535 7.540							
7.600		165.0	109.0	535 7.600	668 7.600						



Long series twist drills

Article no. **501**



Cutting data page 464

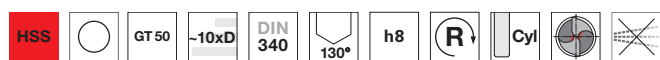

Web thinning $\geq \varnothing 2.370$ • relieved cone • especially large flute

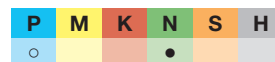

HSS/HSCO drills

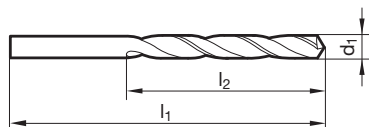

Article no. 501				Article no. 501					
d1 mm	inch	l1 mm	l2 mm	Order no.	d1 mm	inch	l1 mm	l2 mm	Order no.
1.000		56.0	33.0	501 1.000	3.100		106.0	69.0	501 3.100
1.020		56.0	33.0	501 1.020	3.170	1/8	106.0	69.0	501 3.170
1.040		56.0	33.0	501 1.040	3.200		106.0	69.0	501 3.200
1.070		60.0	37.0	501 1.070	3.250		106.0	69.0	501 3.250
1.090		60.0	37.0	501 1.090	3.260		106.0	69.0	501 3.260
1.100		60.0	37.0	501 1.100	3.300		106.0	69.0	501 3.300
1.180		60.0	37.0	501 1.180	3.350		106.0	69.0	501 3.350
1.190	3/64	65.0	41.0	501 1.190	3.400		112.0	73.0	501 3.400
1.200		65.0	41.0	501 1.200	3.450		112.0	73.0	501 3.450
1.250		65.0	41.0	501 1.250	3.500		112.0	73.0	501 3.500
1.300		65.0	41.0	501 1.300	3.570	9/64	112.0	73.0	501 3.570
1.320		65.0	41.0	501 1.320	3.600		112.0	73.0	501 3.600
1.400		70.0	45.0	501 1.400	3.650		112.0	73.0	501 3.650
1.450		70.0	45.0	501 1.450	3.660		112.0	73.0	501 3.660
1.480		70.0	45.0	501 1.480	3.700		112.0	73.0	501 3.700
1.500		70.0	45.0	501 1.500	3.800		119.0	78.0	501 3.800
1.510		76.0	50.0	501 1.510	3.860		119.0	78.0	501 3.860
1.590	1/16	76.0	50.0	501 1.590	3.900		119.0	78.0	501 3.900
1.600		76.0	50.0	501 1.600	3.910		119.0	78.0	501 3.910
1.610		76.0	50.0	501 1.610	3.970	5/32	119.0	78.0	501 3.970
1.700		76.0	50.0	501 1.700	3.990		119.0	78.0	501 3.990
1.750		80.0	53.0	501 1.750	4.000		119.0	78.0	501 4.000
1.780		80.0	53.0	501 1.780	4.040		119.0	78.0	501 4.040
1.800		80.0	53.0	501 1.800	4.050		119.0	78.0	501 4.050
1.850		80.0	53.0	501 1.850	4.090		119.0	78.0	501 4.090
1.900		80.0	53.0	501 1.900	4.100		119.0	78.0	501 4.100
1.930		85.0	56.0	501 1.930	4.200		119.0	78.0	501 4.200
1.950		85.0	56.0	501 1.950	4.220		119.0	78.0	501 4.220
1.980	5/64	85.0	56.0	501 1.980	4.250		119.0	78.0	501 4.250
2.000		85.0	56.0	501 2.000	4.300		126.0	82.0	501 4.300
2.050		85.0	56.0	501 2.050	4.350		126.0	82.0	501 4.350
2.060		85.0	56.0	501 2.060	4.370	11/64	126.0	82.0	501 4.370
2.080		85.0	56.0	501 2.080	4.400		126.0	82.0	501 4.400
2.100		85.0	56.0	501 2.100	4.500		126.0	82.0	501 4.500
2.180		90.0	59.0	501 2.180	4.570		126.0	82.0	501 4.570
2.200		90.0	59.0	501 2.200	4.600		126.0	82.0	501 4.600
2.250		90.0	59.0	501 2.250	4.620		126.0	82.0	501 4.620
2.260		90.0	59.0	501 2.260	4.700		126.0	82.0	501 4.700
2.300		90.0	59.0	501 2.300	4.750		126.0	82.0	501 4.750
2.350		90.0	59.0	501 2.350	4.760	3/16	132.0	87.0	501 4.760
2.370		95.0	62.0	501 2.370	4.800		132.0	87.0	501 4.800
2.380	3/32	95.0	62.0	501 2.380	4.850		132.0	87.0	501 4.850
2.400		95.0	62.0	501 2.400	4.900		132.0	87.0	501 4.900
2.440		95.0	62.0	501 2.440	4.920		132.0	87.0	501 4.920
2.450		95.0	62.0	501 2.450	4.980		132.0	87.0	501 4.980
2.490		95.0	62.0	501 2.490	5.000		132.0	87.0	501 5.000
2.500		95.0	62.0	501 2.500	5.060		132.0	87.0	501 5.060
2.520		95.0	62.0	501 2.520	5.100		132.0	87.0	501 5.100
2.530		95.0	62.0	501 2.530	5.110		132.0	87.0	501 5.110
2.550		95.0	62.0	501 2.550	5.160	13/64	132.0	87.0	501 5.160
2.580		95.0	62.0	501 2.580	5.180		132.0	87.0	501 5.180
2.600		95.0	62.0	501 2.600	5.200		132.0	87.0	501 5.200
2.640		95.0	62.0	501 2.640	5.300		132.0	87.0	501 5.300
2.650		95.0	62.0	501 2.650	5.310		139.0	91.0	501 5.310
2.700		100.0	66.0	501 2.700	5.400		139.0	91.0	501 5.400
2.710		100.0	66.0	501 2.710	5.410		139.0	91.0	501 5.410
2.750		100.0	66.0	501 2.750	5.500		139.0	91.0	501 5.500
2.780	7/64	100.0	66.0	501 2.780	5.560	7/32	139.0	91.0	501 5.560
2.790		100.0	66.0	501 2.790	5.600		139.0	91.0	501 5.600
2.800		100.0	66.0	501 2.800	5.610		139.0	91.0	501 5.610
2.820		100.0	66.0	501 2.820	5.650		139.0	91.0	501 5.650
2.870		100.0	66.0	501 2.870	5.700		139.0	91.0	501 5.700
2.900		100.0	66.0	501 2.900	5.790		139.0	91.0	501 5.790
2.950		100.0	66.0	501 2.950	5.800		139.0	91.0	501 5.800
3.000		100.0	66.0	501 3.000	5.900		139.0	91.0	501 5.900
3.050		106.0	69.0	501 3.050	5.940		139.0	91.0	501 5.940



HSS/HSCO drills with straight shank

HSS/HSCO drills

Article no.				501	Article no.				501
d1 mm	inch	l1 mm	l2 mm	Order no.	d1 mm	inch	l1 mm	l2 mm	Order no.
5.950	15/64	139.0	91.0	501 5.950	9.200		175.0	115.0	501 9.200
6.000		139.0	91.0	501 6.000	9.300		175.0	115.0	501 9.300
6.030		148.0	97.0	501 6.030	9.340		175.0	115.0	501 9.340
6.040		148.0	97.0	501 6.040	9.400		175.0	115.0	501 9.400
6.150		148.0	97.0	501 6.150	9.500		175.0	115.0	501 9.500
6.200		148.0	97.0	501 6.200	9.520	3/8	184.0	121.0	501 9.520
6.250		148.0	97.0	501 6.250	9.580		184.0	121.0	501 9.580
6.300		148.0	97.0	501 6.300	9.600		184.0	121.0	501 9.600
6.350	1/4	148.0	97.0	501 6.350	9.800		184.0	121.0	501 9.800
6.400		148.0	97.0	501 6.400	9.900		184.0	121.0	501 9.900
6.500		148.0	97.0	501 6.500	9.920	25/64	184.0	121.0	501 9.920
6.530		148.0	97.0	501 6.530	10.000		184.0	121.0	501 10.000
6.600		148.0	97.0	501 6.600	10.080		184.0	121.0	501 10.080
6.630		148.0	97.0	501 6.630	10.200		184.0	121.0	501 10.200
6.700		148.0	97.0	501 6.700	10.260		184.0	121.0	501 10.260
6.750	17/64	156.0	102.0	501 6.750	10.320	13/32	184.0	121.0	501 10.320
6.800		156.0	102.0	501 6.800	10.500		184.0	121.0	501 10.500
6.900		156.0	102.0	501 6.900	10.600		184.0	121.0	501 10.600
7.000		156.0	102.0	501 7.000	10.700		195.0	128.0	501 10.700
7.100		156.0	102.0	501 7.100	10.720	27/64	195.0	128.0	501 10.720
7.140	9/32	156.0	102.0	501 7.140	10.800		195.0	128.0	501 10.800
7.300		156.0	102.0	501 7.300	11.000		195.0	128.0	501 11.000
7.370		156.0	102.0	501 7.370	11.110	7/16	195.0	128.0	501 11.110
7.400		156.0	102.0	501 7.400	11.200		195.0	128.0	501 11.200
7.490		156.0	102.0	501 7.490	11.300		195.0	128.0	501 11.300
7.500		156.0	102.0	501 7.500	11.400		195.0	128.0	501 11.400
7.540	19/64	165.0	109.0	501 7.540	11.500		195.0	128.0	501 11.500
7.670		165.0	109.0	501 7.670	11.510	29/64	195.0	128.0	501 11.510
7.900		165.0	109.0	501 7.900	11.800		195.0	128.0	501 11.800
7.940	5/16	165.0	109.0	501 7.940	11.900		205.0	134.0	501 11.900
8.000		165.0	109.0	501 8.000	11.910	15/32	205.0	134.0	501 11.910
8.030		165.0	109.0	501 8.030	12.000		205.0	134.0	501 12.000
8.100		165.0	109.0	501 8.100	12.200		205.0	134.0	501 12.200
8.200		165.0	109.0	501 8.200	12.300	31/64	205.0	134.0	501 12.300
8.300		165.0	109.0	501 8.300	12.500		205.0	134.0	501 12.500
8.330	21/64	165.0	109.0	501 8.330	12.700	1/2	205.0	134.0	501 12.700
8.430		165.0	109.0	501 8.430	13.000		205.0	134.0	501 13.000
8.500		165.0	109.0	501 8.500	13.100	33/64	205.0	134.0	501 13.100
8.600		175.0	115.0	501 8.600	13.490	17/32	214.0	140.0	501 13.490
8.610		175.0	115.0	501 8.610	14.000		214.0	140.0	501 14.000
8.700		175.0	115.0	501 8.700					
8.730	11/32	175.0	115.0	501 8.730					
8.750		175.0	115.0	501 8.750					
8.900		175.0	115.0	501 8.900					
9.000		175.0	115.0	501 9.000					
9.090		175.0	115.0	501 9.090					
9.100		175.0	115.0	501 9.100					
9.130	23/64	175.0	115.0	501 9.130					



Long series twist drills

Article no. **317**



Cutting data page 459



Web thinning $\geq \varnothing 1.000$ • relieved cone • Co-alloyed high speed steel • increased wear resistance

HSS/HSCO drills

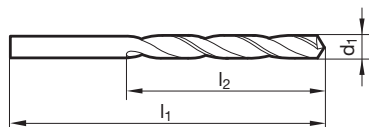

Article no.				317				Article no.				317			
d1 mm	inch	l1 mm	l2 mm	Order no.	d1 mm	inch	l1 mm	l2 mm	Order no.	d1 mm	inch	l1 mm	l2 mm	Order no.	
0.500		32.0	12.0	317 0.500	4.500		126.0	82.0	317 4.500						
0.600		35.0	15.0	317 0.600	4.600		126.0	82.0	317 4.600						
0.700		42.0	21.0	317 0.700	4.700		126.0	82.0	317 4.700						
0.750		42.0	21.0	317 0.750	4.760	3/16	132.0	87.0	317 4.760						
0.800		46.0	25.0	317 0.800	4.800		132.0	87.0	317 4.800						
0.850		46.0	25.0	317 0.850	4.850		132.0	87.0	317 4.850						
0.900		51.0	29.0	317 0.900	4.900		132.0	87.0	317 4.900						
0.950		51.0	29.0	317 0.950	5.000		132.0	87.0	317 5.000						
1.000		56.0	33.0	317 1.000	5.050		132.0	87.0	317 5.050						
1.020		56.0	33.0	317 1.020	5.100		132.0	87.0	317 5.100						
1.050		56.0	33.0	317 1.050	5.160	13/64	132.0	87.0	317 5.160						
1.100		60.0	37.0	317 1.100	5.200		132.0	87.0	317 5.200						
1.190	3/64	65.0	41.0	317 1.190	5.300		132.0	87.0	317 5.300						
1.200		65.0	41.0	317 1.200	5.400		139.0	91.0	317 5.400						
1.250		65.0	41.0	317 1.250	5.500		139.0	91.0	317 5.500						
1.300		65.0	41.0	317 1.300	5.560	7/32	139.0	91.0	317 5.560						
1.350		70.0	45.0	317 1.350	5.600		139.0	91.0	317 5.600						
1.400		70.0	45.0	317 1.400	5.700		139.0	91.0	317 5.700						
1.450		70.0	45.0	317 1.450	5.800		139.0	91.0	317 5.800						
1.500		70.0	45.0	317 1.500	5.900		139.0	91.0	317 5.900						
1.510		76.0	50.0	317 1.510	6.000		139.0	91.0	317 6.000						
1.550		76.0	50.0	317 1.550	6.100		148.0	97.0	317 6.100						
1.590	1/16	76.0	50.0	317 1.590	6.200		148.0	97.0	317 6.200						
1.600		76.0	50.0	317 1.600	6.300		148.0	97.0	317 6.300						
1.650		76.0	50.0	317 1.650	6.350	1/4	148.0	97.0	317 6.350						
1.700		76.0	50.0	317 1.700	6.400		148.0	97.0	317 6.400						
1.780		80.0	53.0	317 1.780	6.500		148.0	97.0	317 6.500						
1.800		80.0	53.0	317 1.800	6.600		148.0	97.0	317 6.600						
1.900		80.0	53.0	317 1.900	6.630		148.0	97.0	317 6.630						
1.950		85.0	56.0	317 1.950	6.750	17/64	156.0	102.0	317 6.750						
1.980	5/64	85.0	56.0	317 1.980	6.800		156.0	102.0	317 6.800						
2.000		85.0	56.0	317 2.000	6.900		156.0	102.0	317 6.900						
2.050		85.0	56.0	317 2.050	7.000		156.0	102.0	317 7.000						
2.100		85.0	56.0	317 2.100	7.140	9/32	156.0	102.0	317 7.140						
2.200		90.0	59.0	317 2.200	7.200		156.0	102.0	317 7.200						
2.300		90.0	59.0	317 2.300	7.250		156.0	102.0	317 7.250						
2.380	3/32	95.0	62.0	317 2.380	7.500		156.0	102.0	317 7.500						
2.400		95.0	62.0	317 2.400	7.540	19/64	165.0	109.0	317 7.540						
2.450		95.0	62.0	317 2.450	7.600		165.0	109.0	317 7.600						
2.500		95.0	62.0	317 2.500	7.700		165.0	109.0	317 7.700						
2.600		95.0	62.0	317 2.600	7.800		165.0	109.0	317 7.800						
2.700		100.0	66.0	317 2.700	7.940	5/16	165.0	109.0	317 7.940						
2.780	7/64	100.0	66.0	317 2.780	8.000		165.0	109.0	317 8.000						
2.800		100.0	66.0	317 2.800	8.100		165.0	109.0	317 8.100						
2.900		100.0	66.0	317 2.900	8.200		165.0	109.0	317 8.200						
3.000		100.0	66.0	317 3.000	8.330	21/64	165.0	109.0	317 8.330						
3.050		106.0	69.0	317 3.050	8.430		165.0	109.0	317 8.430						
3.100		106.0	69.0	317 3.100	8.500		165.0	109.0	317 8.500						
3.150		106.0	69.0	317 3.150	8.700		175.0	115.0	317 8.700						
3.170	1/8	106.0	69.0	317 3.170	8.730	11/32	175.0	115.0	317 8.730						
3.200		106.0	69.0	317 3.200	8.800		175.0	115.0	317 8.800						
3.250		106.0	69.0	317 3.250	9.000		175.0	115.0	317 9.000						
3.300		106.0	69.0	317 3.300	9.130	23/64	175.0	115.0	317 9.130						
3.400		112.0	73.0	317 3.400	9.200		175.0	115.0	317 9.200						
3.500		112.0	73.0	317 3.500	9.300		175.0	115.0	317 9.300						
3.570	9/64	112.0	73.0	317 3.570	9.400		175.0	115.0	317 9.400						
3.600		112.0	73.0	317 3.600	9.500		175.0	115.0	317 9.500						
3.700		112.0	73.0	317 3.700	9.520	3/8	184.0	121.0	317 9.520						
3.800		119.0	78.0	317 3.800	9.600		184.0	121.0	317 9.600						
3.900		119.0	78.0	317 3.900	9.700		184.0	121.0	317 9.700						
3.970	5/32	119.0	78.0	317 3.970	9.800		184.0	121.0	317 9.800						
4.000		119.0	78.0	317 4.000	9.920	25/64	184.0	121.0	317 9.920						
4.100		119.0	78.0	317 4.100	10.000		184.0	121.0	317 10.000						
4.200		119.0	78.0	317 4.200	10.100		184.0	121.0	317 10.100						
4.300		126.0	82.0	317 4.300	10.200		184.0	121.0	317 10.200						
4.400		126.0	82.0	317 4.400	10.320	13/32	184.0	121.0	317 10.320						



HSS/HSCO drills with straight shank

HSS/HSCO drills

Article no.				317				Article no.				317			
d1 mm	inch	l1 mm	l2 mm	Order no.				d1 mm	inch	l1 mm	l2 mm	Order no.			
10.500		184.0	121.0	317 10.500				13.890	35/64	214.0	140.0	317 13.890			
10.720	27/64	195.0	128.0	317 10.720				13.900		214.0	140.0	317 13.900			
10.750		195.0	128.0	317 10.750				14.000		214.0	140.0	317 14.000			
10.800		195.0	128.0	317 10.800				14.290	9/16	220.0	144.0	317 14.290			
11.000		195.0	128.0	317 11.000				14.400		220.0	144.0	317 14.400			
11.110	7/16	195.0	128.0	317 11.110				14.600		220.0	144.0	317 14.600			
11.200		195.0	128.0	317 11.200				14.680	37/64	220.0	144.0	317 14.680			
11.500		195.0	128.0	317 11.500				14.700		220.0	144.0	317 14.700			
11.510	29/64	195.0	128.0	317 11.510				14.900		220.0	144.0	317 14.900			
11.910	15/32	205.0	134.0	317 11.910				15.000		220.0	144.0	317 15.000			
12.000		205.0	134.0	317 12.000				15.080	19/32	227.0	149.0	317 15.080			
12.300	31/64	205.0	134.0	317 12.300				15.480	39/64	227.0	149.0	317 15.480			
12.500		205.0	134.0	317 12.500				15.800		227.0	149.0	317 15.800			
12.700	1/2	205.0	134.0	317 12.700				15.870	5/8	227.0	149.0	317 15.870			
13.000		205.0	134.0	317 13.000				16.000		227.0	149.0	317 16.000			
13.100	33/64	205.0	134.0	317 13.100				22.000		268.0	176.0	317 22.000			
13.490	17/32	214.0	140.0	317 13.490											
13.500		214.0	140.0	317 13.500											

Long series twist drills

 Article no. **336**

Cutting data page 462-463



P	M	K	N	S	H
●	●	●	●	○	○

 Web thinning $\geq \varnothing 1.000$ • relieved cone • Co-alloyed high speed steel • wide flutes • increased wear resistance • in case of poor chip evacuation

Long series twist drills

 Article no. **396**

Cutting data page 462-463

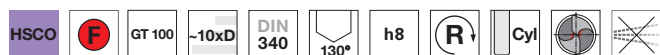

P	M	K	N	S	H
●	●	●	○	○	○

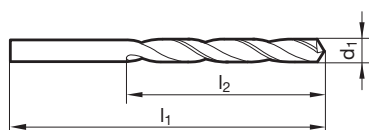
 Web thinning $\geq \varnothing 1.000$ • relieved cone • Co-alloyed high speed steel • wide flutes • especially high wear resistance • in case of poor chip evacuation

Article no.

336
396

Article no.

336
396

d1 mm	inch	l1 mm	l2 mm	Order no.		d1 mm	inch	l1 mm	l2 mm	Order no.	
1.000		56.0	33.0	336 1.000	396 1.000	2.780	7/64	100.0	66.0	336 2.780	
1.020		56.0	33.0	336 1.020		2.790		100.0	66.0	336 2.790	
1.040		56.0	33.0	336 1.040		2.800		100.0	66.0	336 2.800	396 2.800
1.070		60.0	37.0	336 1.070		2.820		100.0	66.0	336 2.820	
1.090		60.0	37.0	336 1.090		2.850		100.0	66.0	336 2.850	
1.100		60.0	37.0	336 1.100	396 1.100	2.870		100.0	66.0	336 2.870	
1.180		60.0	37.0	336 1.180		2.900		100.0	66.0	336 2.900	396 2.900
1.190	3/64	65.0	41.0	336 1.190		2.950		100.0	66.0	336 2.950	
1.200		65.0	41.0	336 1.200	396 1.200	3.000		100.0	66.0	336 3.000	396 3.000
1.250		65.0	41.0	336 1.250		3.050		106.0	69.0	336 3.050	
1.300		65.0	41.0	336 1.300	396 1.300	3.100		106.0	69.0	336 3.100	396 3.100
1.320		65.0	41.0	336 1.320		3.170	1/8	106.0	69.0	336 3.170	
1.400		70.0	45.0	336 1.400		3.200		106.0	69.0	336 3.200	396 3.200
1.500		70.0	45.0	336 1.500	396 1.500	3.260		106.0	69.0	336 3.260	
1.510		76.0	50.0	336 1.510		3.300		106.0	69.0	336 3.300	396 3.300
1.550		76.0	50.0	336 1.550		3.400		112.0	73.0	336 3.400	396 3.400
1.590	1/16	76.0	50.0	336 1.590		3.440		112.0	73.0	336 3.440	
1.600		76.0	50.0	336 1.600	396 1.600	3.450		112.0	73.0	336 3.450	
1.610		76.0	50.0	336 1.610		3.500		112.0	73.0	336 3.500	396 3.500
1.700		76.0	50.0	336 1.700	396 1.700	3.570	9/64	112.0	73.0	336 3.570	
1.750		80.0	53.0	336 1.750		3.600		112.0	73.0	336 3.600	396 3.600
1.780		80.0	53.0	336 1.780		3.660		112.0	73.0	336 3.660	
1.800		80.0	53.0	336 1.800	396 1.800	3.700		112.0	73.0	336 3.700	
1.850		80.0	53.0	336 1.850		3.730		112.0	73.0	336 3.730	
1.900		80.0	53.0	336 1.900	396 1.900	3.750		112.0	73.0	336 3.750	
1.930		85.0	56.0	336 1.930		3.800		119.0	78.0	336 3.800	396 3.800
1.980	5/64	85.0	56.0	336 1.980		3.860		119.0	78.0	336 3.860	
1.990		85.0	56.0	336 1.990		3.900		119.0	78.0	336 3.900	396 3.900
2.000		85.0	56.0	336 2.000	396 2.000	3.910		119.0	78.0	336 3.910	
2.050		85.0	56.0	336 2.050		3.970	5/32	119.0	78.0	336 3.970	
2.060		85.0	56.0	336 2.060		3.990		119.0	78.0	336 3.990	
2.080		85.0	56.0	336 2.080		4.000		119.0	78.0	336 4.000	396 4.000
2.100		85.0	56.0	336 2.100	396 2.100	4.040		119.0	78.0	336 4.040	
2.180		90.0	59.0	336 2.180		4.090		119.0	78.0	336 4.090	
2.200		90.0	59.0	336 2.200	396 2.200	4.100		119.0	78.0	336 4.100	396 4.100
2.250		90.0	59.0	336 2.250		4.200		119.0	78.0	336 4.200	396 4.200
2.260		90.0	59.0	336 2.260		4.220		119.0	78.0	336 4.220	
2.300		90.0	59.0	336 2.300	396 2.300	4.300		126.0	82.0	336 4.300	396 4.300
2.350		90.0	59.0	336 2.350		4.370	11/64	126.0	82.0	336 4.370	
2.370		95.0	62.0	336 2.370		4.390		126.0	82.0	336 4.390	
2.380	3/32	95.0	62.0	336 2.380		4.400		126.0	82.0	336 4.400	
2.400		95.0	62.0	336 2.400	396 2.400	4.500		126.0	82.0	336 4.500	396 4.500
2.440		95.0	62.0	336 2.440		4.570		126.0	82.0	336 4.570	
2.450		95.0	62.0	336 2.450		4.600		126.0	82.0	336 4.600	
2.490		95.0	62.0	336 2.490		4.620		126.0	82.0	336 4.620	
2.500		95.0	62.0	336 2.500	396 2.500	4.700		126.0	82.0	336 4.700	
2.530		95.0	62.0	336 2.530		4.760	3/16	132.0	87.0	336 4.760	
2.550		95.0	62.0	336 2.550		4.800		132.0	87.0	336 4.800	396 4.800
2.580		95.0	62.0	336 2.580		4.850		132.0	87.0	336 4.850	
2.600		95.0	62.0	336 2.600		4.900		132.0	87.0	336 4.900	
2.640		95.0	62.0	336 2.640		4.920		132.0	87.0	336 4.920	
2.700		100.0	66.0	336 2.700	396 2.700	4.980		132.0	87.0	336 4.980	
2.710		100.0	66.0	336 2.710		5.000		132.0	87.0	336 5.000	396 5.000
2.750		100.0	66.0	336 2.750		5.060		132.0	87.0	336 5.060	



HSS/HSCO drills with straight shank

HSS/HSCO drills

Article no.				336	396	Article no.				336	396
d1 mm	inch	l1 mm	l2 mm	Order no.		d1 mm	inch	l1 mm	l2 mm	Order no.	
5.100		132.0	87.0	336 5.100	396 5.100	8.200		165.0	109.0	336 8.200	396 8.200
5.110		132.0	87.0	336 5.110		8.300		165.0	109.0	336 8.300	
5.160	13/64	132.0	87.0	336 5.160		8.400		165.0	109.0	336 8.400	396 8.400
5.200		132.0	87.0	336 5.200	396 5.200	8.500		165.0	109.0	336 8.500	396 8.500
5.220		132.0	87.0	336 5.220		8.600		175.0	115.0	336 8.600	396 8.600
5.300		132.0	87.0	336 5.300		8.610		175.0	115.0	336 8.610	
5.310		139.0	91.0	336 5.310		8.700		175.0	115.0	336 8.700	
5.400		139.0	91.0	336 5.400	396 5.400	8.730	11/32	175.0	115.0	336 8.730	
5.410		139.0	91.0	336 5.410		8.800		175.0	115.0	336 8.800	396 8.800
5.500		139.0	91.0	336 5.500	396 5.500	8.840		175.0	115.0	336 8.840	
5.560	7/32	139.0	91.0	336 5.560		8.900		175.0	115.0	336 8.900	
5.600		139.0	91.0	336 5.600	396 5.600	9.000		175.0	115.0	336 9.000	396 9.000
5.610		139.0	91.0	336 5.610		9.090		175.0	115.0	336 9.090	
5.700		139.0	91.0	336 5.700		9.100		175.0	115.0	336 9.100	
5.790		139.0	91.0	336 5.790		9.200		175.0	115.0	336 9.200	396 9.200
5.800		139.0	91.0	336 5.800	396 5.800	9.300		175.0	115.0	336 9.300	396 9.300
5.900		139.0	91.0	336 5.900		9.340		175.0	115.0	336 9.340	
5.950	15/64	139.0	91.0	336 5.950		9.400		175.0	115.0	336 9.400	396 9.400
6.000		139.0	91.0	336 6.000	396 6.000	9.500		175.0	115.0	336 9.500	396 9.500
6.040		148.0	97.0	336 6.040		9.520	3/8	184.0	121.0	336 9.520	
6.100		148.0	97.0	336 6.100	396 6.100	9.600		184.0	121.0		396 9.600
6.150		148.0	97.0	336 6.150		9.700		184.0	121.0	336 9.700	396 9.700
6.200		148.0	97.0	336 6.200	396 6.200	9.750		184.0	121.0	336 9.750	
6.250		148.0	97.0	336 6.250		9.800		184.0	121.0	336 9.800	396 9.800
6.300		148.0	97.0	336 6.300		9.900		184.0	121.0	336 9.900	
6.350	1/4	148.0	97.0	336 6.350		10.000		184.0	121.0	336 10.000	396 10.000
6.400		148.0	97.0	336 6.400		10.200		184.0	121.0	336 10.200	396 10.200
6.500		148.0	97.0	336 6.500	396 6.500	10.500		184.0	121.0	336 10.500	396 10.500
6.530		148.0	97.0	336 6.530		10.750		195.0	128.0	336 10.750	
6.600		148.0	97.0	336 6.600	396 6.600	10.800		195.0	128.0	336 10.800	
6.630		148.0	97.0	336 6.630		10.900		195.0	128.0	336 10.900	
6.700		148.0	97.0	336 6.700	396 6.700	11.000		195.0	128.0	336 11.000	396 11.000
6.750	17/64	156.0	102.0	336 6.750		11.500		195.0	128.0	336 11.500	396 11.500
6.800		156.0	102.0	336 6.800	396 6.800	11.800		195.0	128.0	336 11.800	
6.900		156.0	102.0	336 6.900	396 6.900	11.910	15/32	205.0	134.0	336 11.910	
7.000		156.0	102.0	336 7.000	396 7.000	12.000		205.0	134.0	336 12.000	396 12.000
7.030		156.0	102.0	336 7.030		12.500		205.0	134.0	336 12.500	
7.100		156.0	102.0	336 7.100		13.000		205.0	134.0	336 13.000	
7.140	9/32	156.0	102.0	336 7.140		13.500		214.0	140.0	336 13.500	
7.200		156.0	102.0	336 7.200	396 7.200	14.000		214.0	140.0	336 14.000	
7.300		156.0	102.0	336 7.300		14.500		220.0	144.0	336 14.500	
7.370		156.0	102.0	336 7.370		15.000		220.0	144.0	336 15.000	
7.400		156.0	102.0	336 7.400	396 7.400	15.500		227.0	149.0	336 15.500	
7.500		156.0	102.0	336 7.500	396 7.500	16.000		227.0	149.0	336 16.000	
7.540	19/64	165.0	109.0	336 7.540							
7.600		165.0	109.0	336 7.600	396 7.600						
7.670		165.0	109.0	336 7.670							
7.700		165.0	109.0	336 7.700							
7.800		165.0	109.0	336 7.800	396 7.800						
7.900		165.0	109.0	336 7.900							
7.940	5/16	165.0	109.0	336 7.940							
8.000		165.0	109.0	336 8.000	396 8.000						
8.030		165.0	109.0	336 8.030							
8.100		165.0	109.0	336 8.100	396 8.100						

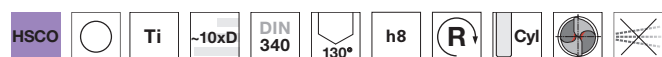

Long series twist drills

 Article no. **617**

 Web thinning $\geq \varnothing 1.000$ • relieved cone • Co-alloyed high speed steel • increased wear resistance

Cutting data page 465

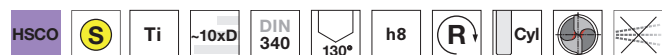
P	M	K	N	S	H
○	●	●	●	●	○

Long series twist drills

 Article no. **669**

 Web thinning $\geq \varnothing 1.000$ • relieved cone • Co-alloyed high speed steel • increased wear resistance

Cutting data page 465

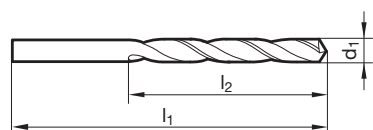
P	M	K	N	S	H
○	●	●	●	●	○



Article no. 617				Order no.		Article no. 669				Order no.	
d1 mm	inch	l1 mm	l2 mm			d1 mm	inch	l1 mm	l2 mm		
1.000		56.0	33.0	617 1.000	669 1.000	2.800		100.0	66.0	617 2.800	669 2.800
1.020		56.0	33.0	617 1.020		2.820		100.0	66.0	617 2.820	
1.040		56.0	33.0	617 1.040		2.870		100.0	66.0	617 2.870	
1.070		60.0	37.0	617 1.070		2.900		100.0	66.0	617 2.900	669 2.900
1.090		60.0	37.0	617 1.090		2.950		100.0	66.0	617 2.950	
1.100		60.0	37.0	617 1.100		3.000		100.0	66.0	617 3.000	669 3.000
1.180		60.0	37.0	617 1.180		3.050		106.0	69.0	617 3.050	
1.190	3/64	65.0	41.0	617 1.190		3.100		106.0	69.0	617 3.100	669 3.100
1.200		65.0	41.0	617 1.200	669 1.200	3.170	1/8	106.0	69.0	617 3.170	669 3.170
1.300		65.0	41.0	617 1.300	669 1.300	3.200		106.0	69.0	617 3.200	669 3.200
1.320		65.0	41.0	617 1.320		3.250		106.0	69.0	617 3.250	669 3.250
1.400		70.0	45.0	617 1.400	669 1.400	3.260		106.0	69.0	617 3.260	
1.450		70.0	45.0	617 1.450		3.280		106.0	69.0	617 3.280	
1.500		70.0	45.0	617 1.500	669 1.500	3.300		106.0	69.0	617 3.300	669 3.300
1.510		76.0	50.0	617 1.510		3.400		112.0	73.0	617 3.400	669 3.400
1.590	1/16	76.0	50.0	617 1.590	669 1.590	3.450		112.0	73.0	617 3.450	
1.600		76.0	50.0	617 1.600	669 1.600	3.500		112.0	73.0	617 3.500	669 3.500
1.610		76.0	50.0	617 1.610		3.570	9/64	112.0	73.0	617 3.570	669 3.570
1.650		76.0	50.0	617 1.650		3.600		112.0	73.0	617 3.600	669 3.600
1.700		76.0	50.0	617 1.700	669 1.700	3.660		112.0	73.0	617 3.660	
1.750		80.0	53.0	617 1.750		3.700		112.0	73.0	617 3.700	669 3.700
1.780		80.0	53.0	617 1.780		3.730		112.0	73.0	617 3.730	
1.800		80.0	53.0	617 1.800	669 1.800	3.800		119.0	78.0	617 3.800	669 3.800
1.850		80.0	53.0	617 1.850		3.860		119.0	78.0	617 3.860	
1.900		80.0	53.0	617 1.900	669 1.900	3.900		119.0	78.0	617 3.900	669 3.900
1.930		85.0	56.0	617 1.930		3.910		119.0	78.0	617 3.910	
1.950		85.0	56.0	617 1.950		3.970	5/32	119.0	78.0	617 3.970	669 3.970
1.980	5/64	85.0	56.0	617 1.980	669 1.980	3.990		119.0	78.0	617 3.990	
1.990		85.0	56.0	617 1.990		4.000		119.0	78.0	617 4.000	669 4.000
2.000		85.0	56.0	617 2.000	669 2.000	4.040		119.0	78.0	617 4.040	
2.050		85.0	56.0	617 2.050	669 2.050	4.050		119.0	78.0	617 4.050	
2.080		85.0	56.0	617 2.080		4.090		119.0	78.0	617 4.090	
2.100		85.0	56.0	617 2.100	669 2.100	4.100		119.0	78.0	617 4.100	669 4.100
2.150		90.0	59.0	617 2.150		4.200		119.0	78.0	617 4.200	669 4.200
2.180		90.0	59.0	617 2.180		4.220		119.0	78.0	617 4.220	
2.200		90.0	59.0	617 2.200	669 2.200	4.300		126.0	82.0	617 4.300	669 4.300
2.260		90.0	59.0	617 2.260		4.370	11/64	126.0	82.0	617 4.370	669 4.370
2.300		90.0	59.0	617 2.300	669 2.300	4.390		126.0	82.0	617 4.390	
2.370		95.0	62.0	617 2.370		4.400		126.0	82.0	617 4.400	669 4.400
2.380	3/32	95.0	62.0	617 2.380	669 2.380	4.500		126.0	82.0	617 4.500	669 4.500
2.400		95.0	62.0	617 2.400	669 2.400	4.570		126.0	82.0	617 4.570	
2.440		95.0	62.0	617 2.440		4.600		126.0	82.0	617 4.600	669 4.600
2.450		95.0	62.0	617 2.450		4.620		126.0	82.0	617 4.620	
2.490		95.0	62.0	617 2.490		4.700		126.0	82.0	617 4.700	669 4.700
2.500		95.0	62.0	617 2.500	669 2.500	4.760	3/16	132.0	87.0	617 4.760	669 4.760
2.550		95.0	62.0	617 2.550		4.800		132.0	87.0	617 4.800	669 4.800
2.580		95.0	62.0	617 2.580		4.850		132.0	87.0	617 4.850	
2.600		95.0	62.0	617 2.600	669 2.600	4.900		132.0	87.0	617 4.900	669 4.900
2.640		95.0	62.0	617 2.640		4.920		132.0	87.0	617 4.920	
2.700		100.0	66.0	617 2.700	669 2.700	4.950		132.0	87.0	617 4.950	
2.710		100.0	66.0	617 2.710		4.980		132.0	87.0	617 4.980	
2.750		100.0	66.0		669 2.750	5.000		132.0	87.0	617 5.000	669 5.000
2.780	7/64	100.0	66.0	617 2.780	669 2.780	5.060		132.0	87.0	617 5.060	
2.790		100.0	66.0	617 2.790		5.100		132.0	87.0	617 5.100	669 5.100



HSS/HSCO drills with straight shank

HSS/HSCO drills

Article no.				617	669	Article no.				617	669
d1 mm	inch	l1 mm	l2 mm	Order no.		d1 mm	inch	l1 mm	l2 mm	Order no.	
5.110		132.0	87.0	617 5.110		8.330	21/64	165.0	109.0	617 8.330	
5.160	13/64	132.0	87.0	617 5.160		8.400		165.0	109.0	617 8.400	669 8.400
5.180		132.0	87.0	617 5.180		8.500		165.0	109.0	617 8.500	669 8.500
5.200		132.0	87.0	617 5.200	669 5.200	8.600		175.0	115.0	617 8.600	
5.220		132.0	87.0	617 5.220		8.610		175.0	115.0	617 8.610	
5.300		132.0	87.0	617 5.300	669 5.300	8.700		175.0	115.0	617 8.700	
5.310		139.0	91.0	617 5.310		8.730	11/32	175.0	115.0	617 8.730	
5.400		139.0	91.0	617 5.400	669 5.400	8.800		175.0	115.0	617 8.800	669 8.800
5.410		139.0	91.0	617 5.410		8.840		175.0	115.0	617 8.840	
5.500		139.0	91.0	617 5.500	669 5.500	8.900		175.0	115.0	617 8.900	
5.600		139.0	91.0	617 5.600	669 5.600	9.000		175.0	115.0	617 9.000	669 9.000
5.610		139.0	91.0	617 5.610		9.090		175.0	115.0	617 9.090	
5.700		139.0	91.0	617 5.700	669 5.700	9.100		175.0	115.0	617 9.100	
5.790		139.0	91.0	617 5.790		9.130	23/64	175.0	115.0	617 9.130	669 9.130
5.800		139.0	91.0	617 5.800	669 5.800	9.200		175.0	115.0	617 9.200	
5.940		139.0	91.0	617 5.940		9.300		175.0	115.0	617 9.300	669 9.300
6.000		139.0	91.0	617 6.000	669 6.000	9.340		175.0	115.0	617 9.340	
6.040		148.0	97.0	617 6.040		9.400		175.0	115.0	617 9.400	
6.100		148.0	97.0	617 6.100	669 6.100	9.500		175.0	115.0	617 9.500	669 9.500
6.150		148.0	97.0	617 6.150		9.520	3/8	184.0	121.0	617 9.520	669 9.520
6.200		148.0	97.0	617 6.200	669 6.200	9.580		184.0	121.0	617 9.580	
6.250		148.0	97.0	617 6.250		9.600		184.0	121.0	617 9.600	
6.300		148.0	97.0	617 6.300	669 6.300	9.800		184.0	121.0	617 9.800	
6.350	1/4	148.0	97.0	617 6.350	669 6.350	9.900		184.0	121.0	617 9.900	669 9.900
6.400		148.0	97.0	617 6.400	669 6.400	9.920	25/64	184.0	121.0	617 9.920	
6.500		148.0	97.0	617 6.500	669 6.500	10.000		184.0	121.0	617 10.000	669 10.000
6.600		148.0	97.0	617 6.600		10.080		184.0	121.0	617 10.080	
6.630		148.0	97.0	617 6.630		10.100		184.0	121.0	617 10.100	
6.700		148.0	97.0	617 6.700	669 6.700	10.200		184.0	121.0	617 10.200	669 10.200
6.750	17/64	156.0	102.0	617 6.750	669 6.750	10.260		184.0	121.0	617 10.260	
6.800		156.0	102.0	617 6.800	669 6.800	10.320	13/32	184.0	121.0	617 10.320	
6.900		156.0	102.0	617 6.900	669 6.900	10.490		184.0	121.0	617 10.490	
7.000		156.0	102.0	617 7.000	669 7.000	10.500		184.0	121.0	617 10.500	
7.030		156.0	102.0	617 7.030		10.720	27/64	195.0	128.0	617 10.720	
7.100		156.0	102.0	617 7.100	669 7.100	11.000		195.0	128.0	617 11.000	
7.140	9/32	156.0	102.0	617 7.140	669 7.140	11.110	7/16	195.0	128.0	617 11.110	
7.200		156.0	102.0		669 7.200	11.500		195.0	128.0	617 11.500	
7.250		156.0	102.0	617 7.250		11.510	29/64	195.0	128.0	617 11.510	
7.300		156.0	102.0	617 7.300	669 7.300	11.910	15/32	205.0	134.0	617 11.910	
7.370		156.0	102.0	617 7.370		12.000		205.0	134.0	617 12.000	
7.400		156.0	102.0	617 7.400	669 7.400	12.200		205.0	134.0	617 12.200	
7.490		156.0	102.0	617 7.490		12.300	31/64	205.0	134.0	617 12.300	
7.500		156.0	102.0	617 7.500	669 7.500	12.500		205.0	134.0	617 12.500	
7.540	19/64	165.0	109.0	617 7.540	669 7.540	12.700	1/2	205.0	134.0	617 12.700	
7.670		165.0	109.0	617 7.670		13.000		205.0	134.0	617 13.000	
7.700		165.0	109.0	617 7.700	669 7.700	13.100	33/64	205.0	134.0	617 13.100	
7.800		165.0	109.0	617 7.800	669 7.800	13.490	17/32	214.0	140.0	617 13.490	
7.900		165.0	109.0	617 7.900	669 7.900	13.890	35/64	214.0	140.0	617 13.890	
7.940	5/16	165.0	109.0	617 7.940	669 7.940	14.290	9/16	220.0	144.0	617 14.290	
8.000		165.0	109.0	617 8.000	669 8.000	14.680	37/64	220.0	144.0	617 14.680	
8.030		165.0	109.0	617 8.030		15.000		220.0	144.0	617 15.000	
8.100		165.0	109.0	617 8.100		15.080	19/32	227.0	149.0	617 15.080	
8.200		165.0	109.0	617 8.200	669 8.200	15.480	39/64	227.0	149.0	617 15.480	
8.300		165.0	109.0	617 8.300		15.870	5/8	227.0	149.0	617 15.870	



Extra length twist drills, series 1

Article no. 235



Cutting data page 466



Web thinning ≥ Ø 2.380 • relieved cone • for extremely deep holes



HSS/HSCO drills

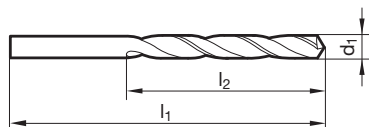

Article no. 235				Article no. 235					
d1 mm	inch	l1 mm	l2 mm	Order no.	d1 mm	inch	l1 mm	l2 mm	Order no.
1.600		115.0	75.0	235 1.600	6.200		215.0	150.0	235 6.200
1.700		115.0	75.0	235 1.700	6.250		215.0	150.0	235 6.250
1.800		120.0	80.0	235 1.800	6.300		215.0	150.0	235 6.300
1.900		120.0	80.0	235 1.900	6.350	1/4	215.0	150.0	235 6.350
1.930		125.0	85.0	235 1.930	6.400		215.0	150.0	235 6.400
1.950		125.0	85.0	235 1.950	6.500		215.0	150.0	235 6.500
2.000		125.0	85.0	235 2.000	6.600		215.0	150.0	235 6.600
2.050		125.0	85.0	235 2.050	6.700		215.0	150.0	235 6.700
2.100		125.0	85.0	235 2.100	6.750	17/64	225.0	155.0	235 6.750
2.200		135.0	90.0	235 2.200	6.800		225.0	155.0	235 6.800
2.300		135.0	90.0	235 2.300	7.000		225.0	155.0	235 7.000
2.350		135.0	90.0	235 2.350	7.100		225.0	155.0	235 7.100
2.380	3/32	140.0	95.0	235 2.380	7.200		225.0	155.0	235 7.200
2.400		140.0	95.0	235 2.400	7.400		225.0	155.0	235 7.400
2.500		140.0	95.0	235 2.500	7.500		225.0	155.0	235 7.500
2.600		140.0	95.0	235 2.600	7.700		240.0	165.0	235 7.700
2.700		150.0	100.0	235 2.700	7.800		240.0	165.0	235 7.800
2.800		150.0	100.0	235 2.800	7.900		240.0	165.0	235 7.900
2.900		150.0	100.0	235 2.900	7.940	5/16	240.0	165.0	235 7.940
3.000		150.0	100.0	235 3.000	8.000		240.0	165.0	235 8.000
3.100		155.0	105.0	235 3.100	8.100		240.0	165.0	235 8.100
3.170	1/8	155.0	105.0	235 3.170	8.200		240.0	165.0	235 8.200
3.200		155.0	105.0	235 3.200	8.400		240.0	165.0	235 8.400
3.250		155.0	105.0	235 3.250	8.500		240.0	165.0	235 8.500
3.300		155.0	105.0	235 3.300	8.700		250.0	175.0	235 8.700
3.400		165.0	115.0	235 3.400	8.730	11/32	250.0	175.0	235 8.730
3.500		165.0	115.0	235 3.500	8.800		250.0	175.0	235 8.800
3.570	9/64	165.0	115.0	235 3.570	9.000		250.0	175.0	235 9.000
3.600		165.0	115.0	235 3.600	9.130	23/64	250.0	175.0	235 9.130
3.650		165.0	115.0	235 3.650	9.500		250.0	175.0	235 9.500
3.700		165.0	115.0	235 3.700	9.520	3/8	265.0	185.0	235 9.520
3.750		165.0	115.0	235 3.750	9.600		265.0	185.0	235 9.600
3.800		175.0	120.0	235 3.800	9.700		265.0	185.0	235 9.700
3.900		175.0	120.0	235 3.900	9.800		265.0	185.0	235 9.800
3.970	5/32	175.0	120.0	235 3.970	9.900		265.0	185.0	235 9.900
4.000		175.0	120.0	235 4.000	9.920	25/64	265.0	185.0	235 9.920
4.100		175.0	120.0	235 4.100	10.000		265.0	185.0	235 10.000
4.200		175.0	120.0	235 4.200	10.100		265.0	185.0	235 10.100
4.300		185.0	125.0	235 4.300	10.200		265.0	185.0	235 10.200
4.370	11/64	185.0	125.0	235 4.370	10.250		265.0	185.0	235 10.250
4.400		185.0	125.0	235 4.400	10.320	13/32	265.0	185.0	235 10.320
4.500		185.0	125.0	235 4.500	10.500		265.0	185.0	235 10.500
4.600		185.0	125.0	235 4.600	11.000		280.0	195.0	235 11.000
4.700		185.0	125.0	235 4.700	11.500		280.0	195.0	235 11.500
4.760	3/16	195.0	135.0	235 4.760	11.510	29/64	280.0	195.0	235 11.510
4.800		195.0	135.0	235 4.800	11.800		280.0	195.0	235 11.800
4.900		195.0	135.0	235 4.900	12.000		295.0	205.0	235 12.000
5.000		195.0	135.0	235 5.000	12.100		295.0	205.0	235 12.100
5.100		195.0	135.0	235 5.100	12.250		295.0	205.0	235 12.250
5.200		195.0	135.0	235 5.200	12.300	31/64	295.0	205.0	235 12.300
5.300		195.0	135.0	235 5.300	12.500		295.0	205.0	235 12.500
5.400		205.0	140.0	235 5.400	12.700	1/2	295.0	205.0	235 12.700
5.500		205.0	140.0	235 5.500	13.000		295.0	205.0	235 13.000
5.560	7/32	205.0	140.0	235 5.560					
5.600		205.0	140.0	235 5.600					
5.700		205.0	140.0	235 5.700					
5.800		205.0	140.0	235 5.800					
5.900		205.0	140.0	235 5.900					
6.000		205.0	140.0	235 6.000					
6.100		215.0	150.0	235 6.100					



Extra length twist drills, series 1

Article no. **502**



Cutting data page 468



Web thinning $\geq \varnothing 1.950$ • relieved cone • wide flutes • for extremely deep holes • in case of poor chip evacuation

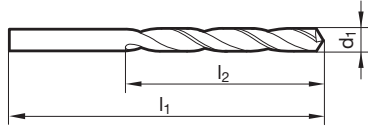

Article no. 502				Article no. 502					
d1 mm	inch	l1 mm	l2 mm	Order no.	d1 mm	inch	l1 mm	l2 mm	Order no.
1.950		125.0	85.0	502 1.950	6.050		215.0	150.0	502 6.050
2.000		125.0	85.0	502 2.000	6.100		215.0	150.0	502 6.100
2.050		125.0	85.0	502 2.050	6.200		215.0	150.0	502 6.200
2.100		125.0	85.0	502 2.100	6.250		215.0	150.0	502 6.250
2.200		135.0	90.0	502 2.200	6.300		215.0	150.0	502 6.300
2.300		135.0	90.0	502 2.300	6.350	1/4	215.0	150.0	502 6.350
2.370		140.0	95.0	502 2.370	6.400		215.0	150.0	502 6.400
2.380	3/32	140.0	95.0	502 2.380	6.500		215.0	150.0	502 6.500
2.400		140.0	95.0	502 2.400	6.600		215.0	150.0	502 6.600
2.500		140.0	95.0	502 2.500	6.700		215.0	150.0	502 6.700
2.550		140.0	95.0	502 2.550	6.750	17/64	225.0	155.0	502 6.750
2.580		140.0	95.0	502 2.580	6.800		225.0	155.0	502 6.800
2.600		140.0	95.0	502 2.600	6.900		225.0	155.0	502 6.900
2.700		150.0	100.0	502 2.700	7.000		225.0	155.0	502 7.000
2.780	7/64	150.0	100.0	502 2.780	7.100		225.0	155.0	502 7.100
2.800		150.0	100.0	502 2.800	7.200		225.0	155.0	502 7.200
2.850		150.0	100.0	502 2.850	7.300		225.0	155.0	502 7.300
2.870		150.0	100.0	502 2.870	7.400		225.0	155.0	502 7.400
2.900		150.0	100.0	502 2.900	7.500		225.0	155.0	502 7.500
2.950		150.0	100.0	502 2.950	7.540	19/64	240.0	165.0	502 7.540
3.000		150.0	100.0	502 3.000	7.600		240.0	165.0	502 7.600
3.030		155.0	105.0	502 3.030	7.700		240.0	165.0	502 7.700
3.100		155.0	105.0	502 3.100	7.750		240.0	165.0	502 7.750
3.170	1/8	155.0	105.0	502 3.170	7.800		240.0	165.0	502 7.800
3.200		155.0	105.0	502 3.200	7.900		240.0	165.0	502 7.900
3.250		155.0	105.0	502 3.250	7.940	5/16	240.0	165.0	502 7.940
3.300		155.0	105.0	502 3.300	8.000		240.0	165.0	502 8.000
3.400		165.0	115.0	502 3.400	8.100		240.0	165.0	502 8.100
3.500		165.0	115.0	502 3.500	8.200		240.0	165.0	502 8.200
3.570	9/64	165.0	115.0	502 3.570	8.300		240.0	165.0	502 8.300
3.600		165.0	115.0	502 3.600	8.330	21/64	240.0	165.0	502 8.330
3.700		165.0	115.0	502 3.700	8.400		240.0	165.0	502 8.400
3.750		165.0	115.0	502 3.750	8.430		240.0	165.0	502 8.430
3.800		175.0	120.0	502 3.800	8.500		240.0	165.0	502 8.500
3.860		175.0	120.0	502 3.860	8.600		250.0	175.0	502 8.600
3.900		175.0	120.0	502 3.900	8.700		250.0	175.0	502 8.700
3.970	5/32	175.0	120.0	502 3.970	8.730	11/32	250.0	175.0	502 8.730
4.000		175.0	120.0	502 4.000	8.800		250.0	175.0	502 8.800
4.100		175.0	120.0	502 4.100	9.000		250.0	175.0	502 9.000
4.200		175.0	120.0	502 4.200	9.200		250.0	175.0	502 9.200
4.300		185.0	125.0	502 4.300	9.300		250.0	175.0	502 9.300
4.370	11/64	185.0	125.0	502 4.370	9.400		250.0	175.0	502 9.400
4.400		185.0	125.0	502 4.400	9.500		250.0	175.0	502 9.500
4.500		185.0	125.0	502 4.500	9.520	3/8	265.0	185.0	502 9.520
4.570		185.0	125.0	502 4.570	9.600		265.0	185.0	502 9.600
4.600		185.0	125.0	502 4.600	9.700		265.0	185.0	502 9.700
4.700		185.0	125.0	502 4.700	9.800		265.0	185.0	502 9.800
4.760	3/16	195.0	135.0	502 4.760	9.900		265.0	185.0	502 9.900
4.800		195.0	135.0	502 4.800	9.920	25/64	265.0	185.0	502 9.920
4.900		195.0	135.0	502 4.900	10.000		265.0	185.0	502 10.000
5.000		195.0	135.0	502 5.000	10.200		265.0	185.0	502 10.200
5.100		195.0	135.0	502 5.100	10.320	13/32	265.0	185.0	502 10.320
5.110		195.0	135.0	502 5.110	10.500		265.0	185.0	502 10.500
5.160	13/64	195.0	135.0	502 5.160	10.720	27/64	280.0	195.0	502 10.720
5.200		195.0	135.0	502 5.200	11.000		280.0	195.0	502 11.000
5.300		195.0	135.0	502 5.300	11.110	7/16	280.0	195.0	502 11.110
5.400		205.0	140.0	502 5.400	11.200		280.0	195.0	502 11.200
5.500		205.0	140.0	502 5.500	11.500		280.0	195.0	502 11.500
5.560	7/32	205.0	140.0	502 5.560	11.510	29/64	280.0	195.0	502 11.510
5.600		205.0	140.0	502 5.600	11.750		280.0	195.0	502 11.750
5.700		205.0	140.0	502 5.700	11.800		280.0	195.0	502 11.800
5.750		205.0	140.0	502 5.750	12.000		295.0	205.0	502 12.000
5.800		205.0	140.0	502 5.800	12.500		295.0	205.0	502 12.500
5.900		205.0	140.0	502 5.900	12.700	1/2	295.0	205.0	502 12.700
5.950	15/64	205.0	140.0	502 5.950	13.000		295.0	205.0	502 13.000
6.000		205.0	140.0	502 6.000					



Extra length twist drills, series 1

Article no. 524



Cutting data page 467

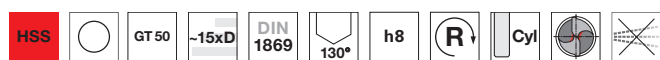

Web thinning ≥ Ø 2.380 • relieved cone • for extremely deep holes

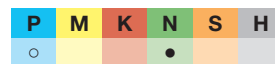

HSS/HSCO drills

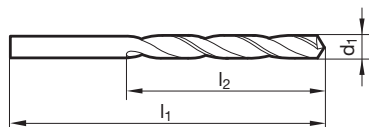

Article no. 524				Article no. 524					
d1 mm	inch	l1 mm	l2 mm	Order no.	d1 mm	inch	l1 mm	l2 mm	Order no.
2.000		125.0	85.0	524 2.000	5.800		205.0	140.0	524 5.800
2.100		125.0	85.0	524 2.100	5.900		205.0	140.0	524 5.900
2.200		135.0	90.0	524 2.200	5.950	15/64	205.0	140.0	524 5.950
2.300		135.0	90.0	524 2.300	6.000		205.0	140.0	524 6.000
2.350		135.0	90.0	524 2.350	6.350	1/4	215.0	150.0	524 6.350
2.380	3/32	140.0	95.0	524 2.380	6.400		215.0	150.0	524 6.400
2.400		140.0	95.0	524 2.400	6.500		215.0	150.0	524 6.500
2.450		140.0	95.0	524 2.450	6.600		215.0	150.0	524 6.600
2.500		140.0	95.0	524 2.500	6.700		215.0	150.0	524 6.700
2.600		140.0	95.0	524 2.600	6.750	17/64	225.0	155.0	524 6.750
2.780	7/64	150.0	100.0	524 2.780	7.000		225.0	155.0	524 7.000
2.800		150.0	100.0	524 2.800	7.100		225.0	155.0	524 7.100
2.900		150.0	100.0	524 2.900	7.140	9/32	225.0	155.0	524 7.140
3.000		150.0	100.0	524 3.000	7.300		225.0	155.0	524 7.300
3.100		155.0	105.0	524 3.100	7.500		225.0	155.0	524 7.500
3.170	1/8	155.0	105.0	524 3.170	7.540	19/64	240.0	165.0	524 7.540
3.200		155.0	105.0	524 3.200	7.800		240.0	165.0	524 7.800
3.300		155.0	105.0	524 3.300	7.900		240.0	165.0	524 7.900
3.350		155.0	105.0	524 3.350	7.940	5/16	240.0	165.0	524 7.940
3.400		165.0	115.0	524 3.400	8.000		240.0	165.0	524 8.000
3.450		165.0	115.0	524 3.450	8.100		240.0	165.0	524 8.100
3.500		165.0	115.0	524 3.500	8.300		240.0	165.0	524 8.300
3.530		165.0	115.0	524 3.530	8.330	21/64	240.0	165.0	524 8.330
3.570	9/64	165.0	115.0	524 3.570	8.600		250.0	175.0	524 8.600
3.600		165.0	115.0	524 3.600	8.730	11/32	250.0	175.0	524 8.730
3.700		165.0	115.0	524 3.700	8.900		250.0	175.0	524 8.900
3.800		175.0	120.0	524 3.800	9.000		250.0	175.0	524 9.000
3.900		175.0	120.0	524 3.900	9.130	23/64	250.0	175.0	524 9.130
3.970	5/32	175.0	120.0	524 3.970	9.500		250.0	175.0	524 9.500
4.000		175.0	120.0	524 4.000	9.520	3/8	265.0	185.0	524 9.520
4.100		175.0	120.0	524 4.100	10.000		265.0	185.0	524 10.000
4.200		175.0	120.0	524 4.200	10.320	13/32	265.0	185.0	524 10.320
4.250		175.0	120.0	524 4.250	10.500		265.0	185.0	524 10.500
4.300		185.0	125.0	524 4.300	11.000		280.0	195.0	524 11.000
4.370	11/64	185.0	125.0	524 4.370	11.110	7/16	280.0	195.0	524 11.110
4.400		185.0	125.0	524 4.400	11.500		280.0	195.0	524 11.500
4.500		185.0	125.0	524 4.500	11.910	15/32	295.0	205.0	524 11.910
4.600		185.0	125.0	524 4.600	12.000		295.0	205.0	524 12.000
4.760	3/16	195.0	135.0	524 4.760	12.700	1/2	295.0	205.0	524 12.700
4.800		195.0	135.0	524 4.800					
4.900		195.0	135.0	524 4.900					
5.000		195.0	135.0	524 5.000					
5.100		195.0	135.0	524 5.100					
5.160	13/64	195.0	135.0	524 5.160					
5.200		195.0	135.0	524 5.200					
5.400		205.0	140.0	524 5.400					
5.600		205.0	140.0	524 5.600					
5.700		205.0	140.0	524 5.700					



HSS/HSCO drills with straight shank

HSS/HSCO drills

Extra length twist drills, series 1

Article no. **618**

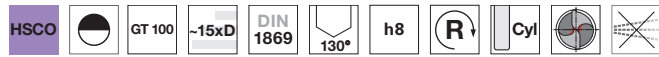

Web thinning $\geq \varnothing 2.700$ • relieved cone • Co-alloyed high speed steel • wide flutes • increased wear resistance • for extremely deep holes • in case of poor chip evacuation

Cutting data page 468-469

P	M	K	N	S	H
●	●	●	●	○	○

Extra length twist drills, series 1

Article no. **9670**

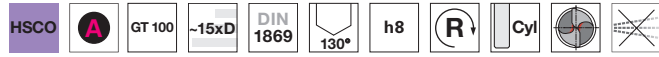

Web thinning $\geq \varnothing 1.980$ • relieved cone • wide flutes • for extremely deep holes • in case of poor chip evacuation • tip coating • maximum performance • for universal application • 5% cobalt-alloyed HSCO high speed steel for maximum tool life, high thermal resistance and hardness

Cutting data page 468-469

P	M	K	N	S	H
●	●	●	●	○	○

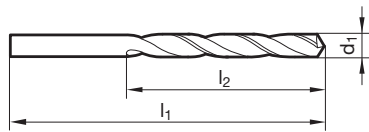

Article no.

618

9670

Article no.

618

9670

d1 mm	inch	l1 mm	l2 mm	Order no.	d1 mm	inch	l1 mm	l2 mm	Order no.
2.000		125.0	85.0	9670 2.000	6.100		215.0	150.0	618 6.100 9670 6.100
2.100		125.0	85.0	9670 2.100	6.200		215.0	150.0	618 6.200 9670 6.200
2.200		135.0	90.0	9670 2.200	6.300		215.0	150.0	618 6.300
2.300		135.0	90.0	9670 2.300	6.350	1/4	215.0	150.0	618 6.350 9670 6.350
2.380	3/32	140.0	95.0	9670 2.380	6.400		215.0	150.0	618 6.400 9670 6.400
2.400		140.0	95.0	9670 2.400	6.500		215.0	150.0	618 6.500 9670 6.500
2.500		140.0	95.0	9670 2.500	6.600		215.0	150.0	618 6.600
2.700		150.0	100.0	618 2.700 9670 2.700	6.700		215.0	150.0	618 6.700
2.780	7/64	150.0	100.0	9670 2.780	6.750	17/64	225.0	155.0	618 6.750
2.800		150.0	100.0	9670 2.800	6.800		225.0	155.0	618 6.800 9670 6.800
2.900		150.0	100.0	618 2.900	7.000		225.0	155.0	618 7.000 9670 7.000
2.950		150.0	100.0	9670 2.950	7.140	9/32	225.0	155.0	618 7.140
3.000		150.0	100.0	618 3.000 9670 3.000	7.400		225.0	155.0	618 7.400
3.100		155.0	105.0	618 3.100 9670 3.100	7.500		225.0	155.0	618 7.500 9670 7.500
3.170	1/8	155.0	105.0	618 3.170 9670 3.170	7.540	19/64	240.0	165.0	618 7.540
3.200		155.0	105.0	618 3.200 9670 3.200	7.700		240.0	165.0	618 7.700
3.300		155.0	105.0	618 3.300 9670 3.300	7.800		240.0	165.0	618 7.800
3.400		165.0	115.0	618 3.400	7.940	5/16	240.0	165.0	618 7.940
3.500		165.0	115.0	618 3.500 9670 3.500	8.000		240.0	165.0	618 8.000 9670 8.000
3.570	9/64	165.0	115.0	618 3.570	8.200		240.0	165.0	618 8.200
3.600		165.0	115.0	618 3.600 9670 3.600	8.330	21/64	240.0	165.0	618 8.330
3.700		165.0	115.0	618 3.700 9670 3.700	8.500		240.0	165.0	618 8.500 9670 8.500
3.750		165.0	115.0	618 3.750	8.700		250.0	175.0	618 8.700
3.800		175.0	120.0	618 3.800 9670 3.800	8.730	11/32	250.0	175.0	618 8.730
3.970	5/32	175.0	120.0	618 3.970 9670 3.970	8.800		250.0	175.0	618 8.800
4.000		175.0	120.0	618 4.000 9670 4.000	9.000		250.0	175.0	618 9.000 9670 9.000
4.100		175.0	120.0	618 4.100 9670 4.100	9.130	23/64	250.0	175.0	618 9.130
4.200		175.0	120.0	618 4.200 9670 4.200	9.400		250.0	175.0	618 9.400
4.300		185.0	125.0	618 4.300 9670 4.300	9.500		250.0	175.0	618 9.500 9670 9.500
4.370	11/64	185.0	125.0	618 4.370	9.520	3/8	265.0	185.0	618 9.520
4.400		185.0	125.0	618 4.400	9.700		265.0	185.0	618 9.700
4.500		185.0	125.0	618 4.500 9670 4.500	10.000		265.0	185.0	618 10.000 9670 10.000
4.600		185.0	125.0	618 4.600	10.200		265.0	185.0	9670 10.200
4.760	3/16	195.0	135.0	618 4.760 9670 4.760	10.500		265.0	185.0	9670 10.500
4.800		195.0	135.0	618 4.800 9670 4.800	11.000		280.0	195.0	9670 11.000
4.850		195.0	135.0	618 4.850	11.500		280.0	195.0	9670 11.500
5.000		195.0	135.0	618 5.000 9670 5.000	12.000		295.0	205.0	9670 12.000
5.100		195.0	135.0	618 5.100 9670 5.100	12.500		295.0	205.0	9670 12.500
5.160	13/64	195.0	135.0	618 5.160 9670 5.160	13.000		295.0	205.0	9670 13.000
5.200		195.0	135.0	618 5.200 9670 5.200					
5.300		195.0	135.0	618 5.300					
5.400		205.0	140.0	618 5.400					
5.500		205.0	140.0	618 5.500 9670 5.500					
5.560	7/32	205.0	140.0	618 5.560					
5.600		205.0	140.0	618 5.600					
5.700		205.0	140.0	618 5.700					
5.800		205.0	140.0	618 5.800					
6.000		205.0	140.0	618 6.000 9670 6.000					



Extra length twist drills, series 2

Article no. 236



Cutting data page 466

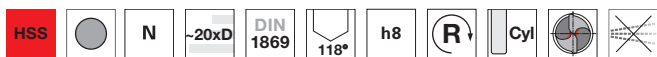

Web thinning $\geq \varnothing 2.700$ • relieved cone • for extremely deep holes

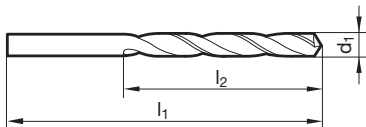

Article no. 236				Article no. 236					
d1 mm	inch	l1 mm	l2 mm	Order no.	d1 mm	inch	l1 mm	l2 mm	Order no.
2.700		190.0	130.0	236 2.700	6.800		290.0	200.0	236 6.800
2.900		190.0	130.0	236 2.900	7.000		290.0	200.0	236 7.000
3.000		190.0	130.0	236 3.000	7.140	9/32	290.0	200.0	236 7.140
3.100		200.0	135.0	236 3.100	7.500		290.0	200.0	236 7.500
3.170	1/8	200.0	135.0	236 3.170	7.540	19/64	305.0	210.0	236 7.540
3.200		200.0	135.0	236 3.200	7.800		305.0	210.0	236 7.800
3.300		200.0	135.0	236 3.300	7.940	5/16	305.0	210.0	236 7.940
3.500		210.0	145.0	236 3.500	8.000		305.0	210.0	236 8.000
3.570	9/64	210.0	145.0	236 3.570	8.100		305.0	210.0	236 8.100
3.600		210.0	145.0	236 3.600	8.500		305.0	210.0	236 8.500
3.800		220.0	150.0	236 3.800	8.700		320.0	220.0	236 8.700
3.900		220.0	150.0	236 3.900	8.730	11/32	320.0	220.0	236 8.730
3.970	5/32	220.0	150.0	236 3.970	8.800		320.0	220.0	236 8.800
4.000		220.0	150.0	236 4.000	9.000		320.0	220.0	236 9.000
4.100		220.0	150.0	236 4.100	9.130	23/64	320.0	220.0	236 9.130
4.200		220.0	150.0	236 4.200	9.500		320.0	220.0	236 9.500
4.500		235.0	160.0	236 4.500	9.800		340.0	235.0	236 9.800
4.760	3/16	245.0	170.0	236 4.760	10.000		340.0	235.0	236 10.000
4.800		245.0	170.0	236 4.800	10.200		340.0	235.0	236 10.200
5.000		245.0	170.0	236 5.000	10.500		340.0	235.0	236 10.500
5.200		245.0	170.0	236 5.200	11.000		365.0	250.0	236 11.000
5.500		260.0	180.0	236 5.500	11.500		365.0	250.0	236 11.500
5.560	7/32	260.0	180.0	236 5.560	11.510	29/64	365.0	250.0	236 11.510
5.800		260.0	180.0	236 5.800	11.750		365.0	250.0	236 11.750
5.900		260.0	180.0	236 5.900	12.000		375.0	260.0	236 12.000
6.000		260.0	180.0	236 6.000	13.000		375.0	260.0	236 13.000
6.200		275.0	190.0	236 6.200					
6.350	1/4	275.0	190.0	236 6.350					
6.500		275.0	190.0	236 6.500					
6.700		275.0	190.0	236 6.700					

HSS/HSCO drills



Extra length twist drills, series 2

Article no. **503**



Cutting data page 468

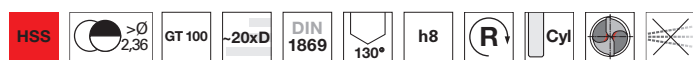

Web thinning $\geq \varnothing 2.000$ • relieved cone • wide flutes • for extremely deep holes • in case of poor chip evacuation

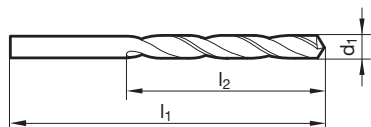

Article no.				503				Article no.				503			
d1	inch	l1	l2	Order no.	d1	inch	l1	l2	Order no.	d1	inch	l1	l2	Order no.	
mm		mm	mm		mm		mm	mm		mm		mm	mm		
2.000		160.0	110.0	503 2.000	6.600		275.0	190.0	503 6.600						
2.200		170.0	115.0	503 2.200	6.700		275.0	190.0	503 6.700						
2.300		170.0	115.0	503 2.300	6.750	17/64	290.0	200.0	503 6.750						
2.500		180.0	120.0	503 2.500	6.800		290.0	200.0	503 6.800						
2.800		190.0	130.0	503 2.800	7.000		290.0	200.0	503 7.000						
3.000		190.0	130.0	503 3.000	7.140	9/32	290.0	200.0	503 7.140						
3.030		200.0	135.0	503 3.030	7.500		290.0	200.0	503 7.500						
3.100		200.0	135.0	503 3.100	7.540	19/64	305.0	210.0	503 7.540						
3.170	1/8	200.0	135.0	503 3.170	7.800		305.0	210.0	503 7.800						
3.200		200.0	135.0	503 3.200	7.940	5/16	305.0	210.0	503 7.940						
3.300		200.0	135.0	503 3.300	8.000		305.0	210.0	503 8.000						
3.400		210.0	145.0	503 3.400	8.200		305.0	210.0	503 8.200						
3.500		210.0	145.0	503 3.500	8.330	21/64	305.0	210.0	503 8.330						
3.570	9/64	210.0	145.0	503 3.570	8.500		305.0	210.0	503 8.500						
3.600		210.0	145.0	503 3.600	8.600		320.0	220.0	503 8.600						
3.700		210.0	145.0	503 3.700	8.730	11/32	320.0	220.0	503 8.730						
3.800		220.0	150.0	503 3.800	8.800		320.0	220.0	503 8.800						
3.900		220.0	150.0	503 3.900	9.000		320.0	220.0	503 9.000						
3.970	5/32	220.0	150.0	503 3.970	9.100		320.0	220.0	503 9.100						
4.000		220.0	150.0	503 4.000	9.130	23/64	320.0	220.0	503 9.130						
4.100		220.0	150.0	503 4.100	9.500		320.0	220.0	503 9.500						
4.200		220.0	150.0	503 4.200	9.520	3/8	340.0	235.0	503 9.520						
4.300		235.0	160.0	503 4.300	9.700		340.0	235.0	503 9.700						
4.370	11/64	235.0	160.0	503 4.370	9.800		340.0	235.0	503 9.800						
4.400		235.0	160.0	503 4.400	9.920	25/64	340.0	235.0	503 9.920						
4.500		235.0	160.0	503 4.500	10.000		340.0	235.0	503 10.000						
4.760	3/16	245.0	170.0	503 4.760	10.200		340.0	235.0	503 10.200						
4.800		245.0	170.0	503 4.800	10.500		340.0	235.0	503 10.500						
4.900		245.0	170.0	503 4.900	10.720	27/64	365.0	250.0	503 10.720						
5.000		245.0	170.0	503 5.000	11.000		365.0	250.0	503 11.000						
5.100		245.0	170.0	503 5.100	11.110	7/16	365.0	250.0	503 11.110						
5.160	13/64	245.0	170.0	503 5.160	11.500		365.0	250.0	503 11.500						
5.200		245.0	170.0	503 5.200	11.510	29/64	365.0	250.0	503 11.510						
5.300		245.0	170.0	503 5.300	11.750		365.0	250.0	503 11.750						
5.400		260.0	180.0	503 5.400	11.910	15/32	375.0	260.0	503 11.910						
5.500		260.0	180.0	503 5.500	12.000		375.0	260.0	503 12.000						
5.560	7/32	260.0	180.0	503 5.560	12.300	31/64	375.0	260.0	503 12.300						
5.700		260.0	180.0	503 5.700	12.500		375.0	260.0	503 12.500						
5.800		260.0	180.0	503 5.800	12.700	1/2	375.0	260.0	503 12.700						
5.900		260.0	180.0	503 5.900	13.000		375.0	260.0	503 13.000						
5.950	15/64	260.0	180.0	503 5.950											
6.000		260.0	180.0	503 6.000											
6.100		275.0	190.0	503 6.100											
6.150		275.0	190.0	503 6.150											
6.200		275.0	190.0	503 6.200											
6.300		275.0	190.0	503 6.300											
6.350	1/4	275.0	190.0	503 6.350											
6.500		275.0	190.0	503 6.500											

Extra length twist drills, series 2

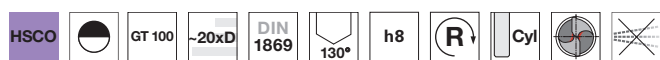
 Article no. **619**

Web thinning $\geq \varnothing 3.000$ • relieved cone • Co-alloyed high speed steel • wide flutes • increased wear resistance • for extremely deep holes • in case of poor chip evacuation

Cutting data page 468-469

P	M	K	N	S	H
●	●	●	●	○	○

Extra length twist drills, series 2

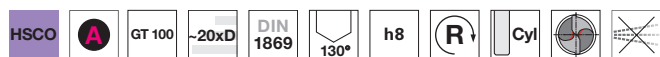
 Article no. **9671**

Web thinning $\geq \varnothing 2.300$ • relieved cone • wide flutes • for extremely deep holes • in case of poor chip evacuation • tip coating • maximum performance • for universal application • 5% cobalt-alloyed HSCO high speed steel for maximum tool life, high thermal resistance and hardness

Cutting data page 468-469

P	M	K	N	S	H
●	●	●	●	○	○

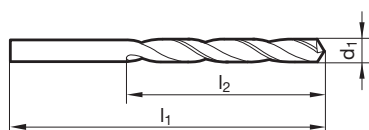

Article no.

619
9671

Article no.

619
9671

d1 mm	inch	l1 mm	l2 mm	Order no.	
2.000		160.0	110.0	9671 2.000	
2.300		170.0	115.0	9671 2.300	
2.500		180.0	120.0	9671 2.500	
2.700		190.0	130.0	9671 2.700	
2.800		190.0	130.0	9671 2.800	
3.000		190.0	130.0	619 3.000	9671 3.000
3.170	1/8	200.0	135.0	619 3.170	9671 3.170
3.200		200.0	135.0	619 3.200	9671 3.200
3.300		200.0	135.0	619 3.300	9671 3.300
3.500		210.0	145.0	619 3.500	9671 3.500
3.570	9/64	210.0	145.0	619 3.570	
3.970	5/32	220.0	150.0	619 3.970	
4.000		220.0	150.0	619 4.000	9671 4.000
4.100		220.0	150.0	619 4.100	
4.200		220.0	150.0	619 4.200	9671 4.200
4.370	11/64	235.0	160.0	619 4.370	
4.500		235.0	160.0	619 4.500	9671 4.500
4.760	3/16	245.0	170.0	619 4.760	9671 4.760
4.800		245.0	170.0	619 4.800	
4.900		245.0	170.0	619 4.900	
5.000		245.0	170.0	619 5.000	9671 5.000
5.200		245.0	170.0	619 5.200	9671 5.200
5.500		260.0	180.0	619 5.500	9671 5.500
5.560	7/32	260.0	180.0	619 5.560	
5.950	15/64	260.0	180.0	619 5.950	
6.000		260.0	180.0	619 6.000	9671 6.000
6.100		275.0	190.0	619 6.100	
6.200		275.0	190.0	619 6.200	
6.350	1/4	275.0	190.0	619 6.350	9671 6.350
6.500		275.0	190.0	619 6.500	9671 6.500

d1 mm	inch	l1 mm	l2 mm	Order no.	
6.750	17/64	290.0	200.0	619 6.750	
6.800		290.0	200.0	619 6.800	9671 6.800
7.000		290.0	200.0	619 7.000	9671 7.000
7.140	9/32	290.0	200.0	619 7.140	
7.500		290.0	200.0	619 7.500	9671 7.500
7.540	19/64	305.0	210.0	619 7.540	
7.600		305.0	210.0	619 7.600	
7.940	5/16	305.0	210.0	619 7.940	9671 7.940
8.000		305.0	210.0	619 8.000	9671 8.000
8.200		305.0	210.0	619 8.200	
8.500		305.0	210.0	619 8.500	9671 8.500
8.730	11/32	320.0	220.0	619 8.730	
9.000		320.0	220.0	619 9.000	9671 9.000
9.130	23/64	320.0	220.0	619 9.130	
9.500		320.0	220.0	619 9.500	9671 9.500
9.520	3/8	340.0	235.0	619 9.520	
9.600		340.0	235.0	619 9.600	
10.000		340.0	235.0	619 10.000	9671 10.000
10.200		340.0	235.0		9671 10.200
10.500		340.0	235.0		9671 10.500
11.000		365.0	250.0		9671 11.000
12.000		375.0	260.0		9671 12.000
13.000		375.0	260.0		9671 13.000



HSS/HSCO drills with straight shank

HSS/HSCO drills

Extra length twist drills, series 3

Article no. **237**



Cutting data page 466



Web thinning $\geq \varnothing 3.500$ • relieved cone • for extremely deep holes

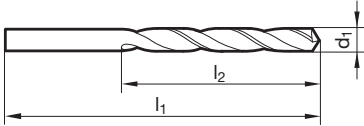

Article no.

237

Article no.

237

d1 mm	inch	l1 mm	l2 mm	Order no.
3.500		265.0	180.0	237 3.500
3.800		280.0	190.0	237 3.800
4.000		280.0	190.0	237 4.000
4.100		280.0	190.0	237 4.100
4.200		280.0	190.0	237 4.200
4.500		295.0	200.0	237 4.500
4.700		295.0	200.0	237 4.700
5.000		315.0	210.0	237 5.000
5.200		315.0	210.0	237 5.200
5.500		330.0	225.0	237 5.500
5.800		330.0	225.0	237 5.800
5.900		330.0	225.0	237 5.900
6.000		330.0	225.0	237 6.000
6.100		350.0	235.0	237 6.100
6.200		350.0	235.0	237 6.200
6.500		350.0	235.0	237 6.500
6.800		370.0	250.0	237 6.800
7.000		370.0	250.0	237 7.000

d1 mm	inch	l1 mm	l2 mm	Order no.
7.500		370.0	250.0	237 7.500
7.800		390.0	265.0	237 7.800
8.000		390.0	265.0	237 8.000
8.500		390.0	265.0	237 8.500
8.700		410.0	280.0	237 8.700
9.000		410.0	280.0	237 9.000
9.500		410.0	280.0	237 9.500
9.800		430.0	295.0	237 9.800
10.000		430.0	295.0	237 10.000
10.300		430.0	295.0	237 10.300
10.500		430.0	295.0	237 10.500
11.000		455.0	310.0	237 11.000
11.500		455.0	310.0	237 11.500
11.750		455.0	310.0	237 11.750
12.000		480.0	330.0	237 12.000
12.500		480.0	330.0	237 12.500
13.000		480.0	330.0	237 13.000



Extra length twist drills, series 3

Article no. **504**



Cutting data page 468

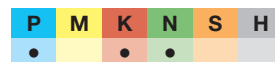
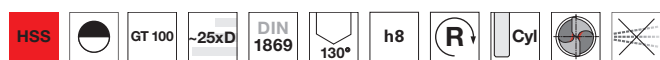

Web thinning $\geq \varnothing 2.500$ • relieved cone • wide flutes • in case of poor chip evacuation • for extremely deep holes

HSS/HSCO drills

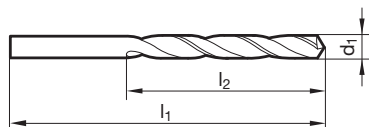

Article no. 504				Article no. 504					
d1 mm	inch	l1 mm	l2 mm	Order no.	d1 mm	inch	l1 mm	l2 mm	Order no.
2.500		225.0	150.0	504 2.500	7.000		370.0	250.0	504 7.000
3.000		240.0	160.0	504 3.000	7.140	9/32	370.0	250.0	504 7.140
3.100		250.0	170.0	504 3.100	7.200		370.0	250.0	504 7.200
3.170	1/8	250.0	170.0	504 3.170	7.500		370.0	250.0	504 7.500
3.200		250.0	170.0	504 3.200	7.540	19/64	390.0	265.0	504 7.540
3.300		250.0	170.0	504 3.300	7.750		390.0	265.0	504 7.750
3.400		265.0	180.0	504 3.400	7.800		390.0	265.0	504 7.800
3.500		265.0	180.0	504 3.500	7.940	5/16	390.0	265.0	504 7.940
3.570	9/64	265.0	180.0	504 3.570	8.000		390.0	265.0	504 8.000
3.600		265.0	180.0	504 3.600	8.200		390.0	265.0	504 8.200
3.700		265.0	180.0	504 3.700	8.330	21/64	390.0	265.0	504 8.330
3.800		280.0	190.0	504 3.800	8.500		390.0	265.0	504 8.500
3.900		280.0	190.0	504 3.900	8.600		410.0	280.0	504 8.600
3.970	5/32	280.0	190.0	504 3.970	8.730	11/32	410.0	280.0	504 8.730
4.000		280.0	190.0	504 4.000	8.800		410.0	280.0	504 8.800
4.100		280.0	190.0	504 4.100	9.000		410.0	280.0	504 9.000
4.200		280.0	190.0	504 4.200	9.200		410.0	280.0	504 9.200
4.300		295.0	200.0	504 4.300	9.500		410.0	280.0	504 9.500
4.370	11/64	295.0	200.0	504 4.370	9.520	3/8	430.0	295.0	504 9.520
4.400		295.0	200.0	504 4.400	9.530		430.0	295.0	504 9.530
4.500		295.0	200.0	504 4.500	9.920	25/64	430.0	295.0	504 9.920
4.600		295.0	200.0	504 4.600	10.000		430.0	295.0	504 10.000
4.760	3/16	315.0	210.0	504 4.760	10.320	13/32	430.0	295.0	504 10.320
4.800		315.0	210.0	504 4.800	10.500		430.0	295.0	504 10.500
4.900		315.0	210.0	504 4.900	10.720	27/64	455.0	310.0	504 10.720
5.000		315.0	210.0	504 5.000	11.000		455.0	310.0	504 11.000
5.100		315.0	210.0	504 5.100	11.110	7/16	455.0	310.0	504 11.110
5.200		315.0	210.0	504 5.200	11.500		455.0	310.0	504 11.500
5.500		330.0	225.0	504 5.500	12.000		480.0	330.0	504 12.000
5.560	7/32	330.0	225.0	504 5.560	12.200		480.0	330.0	504 12.200
5.800		330.0	225.0	504 5.800	12.500		480.0	330.0	504 12.500
5.950	15/64	330.0	225.0	504 5.950	13.000		480.0	330.0	504 13.000
6.000		330.0	225.0	504 6.000					
6.100		350.0	235.0	504 6.100					
6.200		350.0	235.0	504 6.200					
6.300		350.0	235.0	504 6.300					
6.350	1/4	350.0	235.0	504 6.350					
6.400		350.0	235.0	504 6.400					
6.500		350.0	235.0	504 6.500					
6.700		350.0	235.0	504 6.700					
6.750	17/64	370.0	250.0	504 6.750					
6.800		370.0	250.0	504 6.800					



HSS/HSCO drills with straight shank

HSS/HSCO drills

Extra length twist drills, series 3

Article no. 571

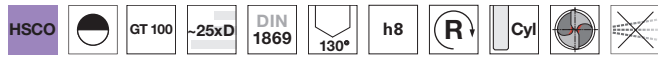

Web thinning $\geq \varnothing 2.500$ • relieved cone • wide flutes • for extremely deep holes • in case of poor chip evacuation • Co-alloyed high speed steel • increased wear resistance

Cutting data page 468-469

P	M	K	N	S	H
●	●	●	●	○	○

Extra length twist drills, series 3

Article no. 9672

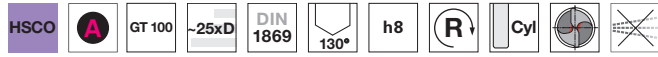

Web thinning $\geq \varnothing 2.500$ • relieved cone • wide flutes • for extremely deep holes • in case of poor chip evacuation • tip coating • maximum performance • for universal application • 5% cobalt-alloyed HSCO high speed steel for maximum tool life, high thermal resistance and hardness

Cutting data page 468-469

P	M	K	N	S	H
●	●	●	●	○	○

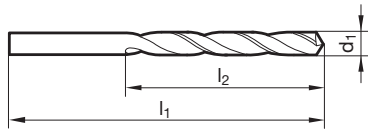

Article no.

571

9672

Article no.

571

9672

d1 mm	inch	l1 mm	l2 mm	Order no.	
2.500		225.0	150.0	571 2.500	9672 2.500
3.000		240.0	160.0	571 3.000	9672 3.000
3.100		250.0	170.0	571 3.100	
3.170	1/8	250.0	170.0	571 3.170	9672 3.170
3.200		250.0	170.0	571 3.200	9672 3.200
3.300		250.0	170.0	571 3.300	9672 3.300
3.400		265.0	180.0	571 3.400	
3.500		265.0	180.0	571 3.500	9672 3.500
3.700		265.0	180.0	571 3.700	
3.800		280.0	190.0	571 3.800	
3.900		280.0	190.0	571 3.900	
3.970	5/32	280.0	190.0	571 3.970	
4.000		280.0	190.0	571 4.000	9672 4.000
4.100		280.0	190.0	571 4.100	
4.200		280.0	190.0	571 4.200	9672 4.200
4.300		295.0	200.0	571 4.300	
4.500		295.0	200.0	571 4.500	9672 4.500
4.600		295.0	200.0	571 4.600	
4.760	3/16	315.0	210.0	571 4.760	9672 4.760
4.800		315.0	210.0	571 4.800	
4.900		315.0	210.0	571 4.900	
5.000		315.0	210.0	571 5.000	9672 5.000
5.100		315.0	210.0	571 5.100	
5.200		315.0	210.0	571 5.200	
5.500		330.0	225.0	571 5.500	9672 5.500
5.560	7/32	330.0	225.0	571 5.560	
5.800		330.0	225.0	571 5.800	
5.950	15/64	330.0	225.0	571 5.950	
6.000		330.0	225.0	571 6.000	9672 6.000
6.100		350.0	235.0	571 6.100	
6.200		350.0	235.0	571 6.200	
6.300		350.0	235.0	571 6.300	
6.350	1/4	350.0	235.0	571 6.350	9672 6.350
6.400		350.0	235.0	571 6.400	
6.500		350.0	235.0	571 6.500	9672 6.500
6.700		350.0	235.0	571 6.700	

d1 mm	inch	l1 mm	l2 mm	Order no.	
6.750	17/64	370.0	250.0	571 6.750	
6.800		370.0	250.0	571 6.800	
7.000		370.0	250.0	571 7.000	9672 7.000
7.140	9/32	370.0	250.0	571 7.140	
7.200		370.0	250.0	571 7.200	
7.500		370.0	250.0	571 7.500	
7.750		390.0	265.0	571 7.750	
7.800		390.0	265.0	571 7.800	
7.940	5/16	390.0	265.0	571 7.940	
8.000		390.0	265.0	571 8.000	9672 8.000
8.200		390.0	265.0	571 8.200	
8.500		390.0	265.0	571 8.500	
8.600		410.0	280.0	571 8.600	
8.730	11/32	410.0	280.0	571 8.730	
8.800		410.0	280.0	571 8.800	
9.000		410.0	280.0	571 9.000	9672 9.000
9.500		410.0	280.0	571 9.500	
9.520	3/8	430.0	295.0	571 9.520	
10.000		430.0	295.0	571 10.000	9672 10.000
10.320	13/32	430.0	295.0	571 10.320	
10.500		430.0	295.0	571 10.500	
10.720	27/64	455.0	310.0	571 10.720	
11.000		455.0	310.0	571 11.000	
11.110	7/16	455.0	310.0	571 11.110	
11.500		455.0	310.0	571 11.500	
12.000		480.0	330.0	571 12.000	
12.200		480.0	330.0	571 12.200	
12.500		480.0	330.0	571 12.500	
13.000		480.0	330.0	571 13.000	



Extra length twist drills

 Article no. **242**

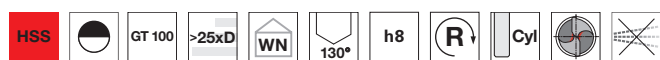
Cutting data page 468

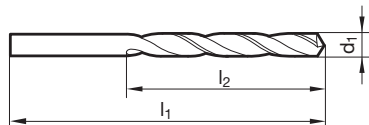

P	M	K	N	S	H
•		•	•		

 Web thinning $\geq \varnothing 6.000$ • relieved cone • wide flutes • for extremely deep holes • in case of poor chip evacuation

 Article no. **242**

 Article no. **242**

d1 mm	inch	l1 mm	l2 mm	Order no.
6.000		500.0	400.0	242 6.000
8.000		500.0	400.0	242 8.000
10.000		600.0	500.0	242 10.000
11.000		600.0	500.0	242 11.000
12.000		600.0	500.0	242 12.000

d1 mm	inch	l1 mm	l2 mm	Order no.

Extra length twist drills

 Article no. **243**

Cutting data page 468

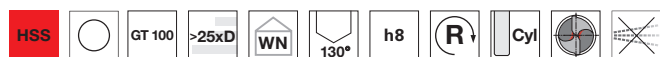

P	M	K	N	S	H
•		•	•		

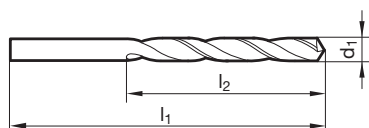
 Web thinning $\geq \varnothing 8.000$ • relieved cone • wide flutes • for extremely deep holes • in case of poor chip evacuation

 Article no. **243**

 Article no. **243**

d1 mm	inch	l1 mm	l2 mm	Order no.
8.000		750.0	650.0	243 8.000
10.000		750.0	650.0	243 10.000
11.000		750.0	650.0	243 11.000
12.000		750.0	650.0	243 12.000

d1 mm	inch	l1 mm	l2 mm	Order no.

Extra length twist drills

 Article no. **244**

Cutting data page 468

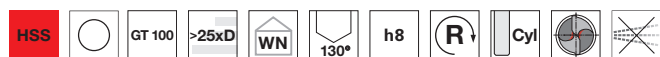

P	M	K	N	S	H
•		•	•		

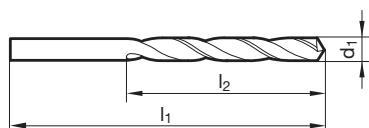
 Web thinning $\geq \varnothing 10.000$ • relieved cone • wide flutes • for extremely deep holes • in case of poor chip evacuation

 Article no. **244**

 Article no. **244**

d1 mm	inch	l1 mm	l2 mm	Order no.
10.000		1000.0	850.0	244 10.000
11.000		1000.0	850.0	244 11.000
12.000		1000.0	850.0	244 12.000

d1 mm	inch	l1 mm	l2 mm	Order no.



Aircraft extension drills, 6 inches long

Article no. **577**



Cutting data page 459

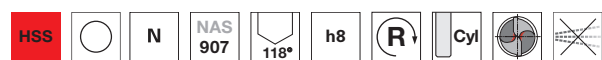

Web thinning $\geq \varnothing 1.500$ • relieved cone

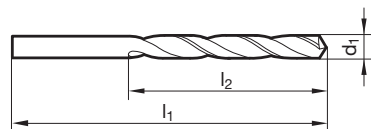

Article no. 577				Article no. 577					
d1 mm	inch	l1 mm	l2 mm	Order no.	d1 mm	inch	l1 mm	l2 mm	Order no.
1.500		153.0	23.0	577 1.500	4.220		154.0	55.0	577 4.220
1.590	1/16	153.0	26.0	577 1.590	4.390		154.0	60.0	577 4.390
1.750		153.0	26.0	577 1.750	4.500		154.0	60.0	577 4.500
1.780		153.0	26.0	577 1.780	4.570		154.0	60.0	577 4.570
1.900		153.0	26.0	577 1.900	4.760	3/16	154.0	63.5	577 4.760
1.930		153.0	29.0	577 1.930	4.800		154.0	63.5	577 4.800
1.980	5/64	153.0	29.0	577 1.980	4.850		154.0	63.5	577 4.850
2.000		153.0	29.0	577 2.000	4.920		154.0	63.5	577 4.920
2.100		153.0	29.0	577 2.100	4.980		154.0	63.5	577 4.980
2.300		153.0	32.5	577 2.300	5.000		154.0	63.5	577 5.000
2.380	3/32	153.0	37.0	577 2.380	5.160	13/64	154.0	63.5	577 5.160
2.400		153.0	37.0	577 2.400	5.500		154.0	68.5	577 5.500
2.490		153.0	37.0	577 2.490	5.560	7/32	154.0	68.5	577 5.560
2.500		153.0	37.0	577 2.500	5.800		154.0	68.5	577 5.800
2.530		153.0	37.0	577 2.530	5.940		154.0	68.5	577 5.940
2.580		153.0	37.0	577 2.580	5.950	15/64	154.0	68.5	577 5.950
2.870		153.0	42.0	577 2.870	6.150		154.0	75.0	577 6.150
3.000		153.0	42.0	577 3.000	6.200		154.0	75.0	577 6.200
3.170	1/8	153.0	42.0	577 3.170	6.350	1/4	154.0	75.0	577 6.350
3.200		153.0	42.0	577 3.200	6.530		154.0	75.0	577 6.530
3.260		153.0	42.0	577 3.260	6.800		155.0	80.0	577 6.800
3.500		154.0	49.0	577 3.500	7.000		155.0	80.0	577 7.000
3.570	9/64	154.0	49.0	577 3.570	7.700		155.0	90.0	577 7.700
3.800		154.0	55.0	577 3.800	7.940	5/16	155.0	90.0	577 7.940
3.860		154.0	55.0	577 3.860	8.000		155.0	90.0	577 8.000
3.910		154.0	55.0	577 3.910					
3.970	5/32	154.0	55.0	577 3.970					
4.000		154.0	55.0	577 4.000					
4.040		154.0	55.0	577 4.040					
4.090		154.0	55.0	577 4.090					



Aircraft extension drills, 6 inches long

Article no. **579**



Cutting data page 459

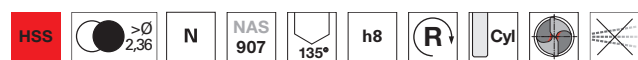

Web thinning $\geq \varnothing 1.500$ • relieved cone



HSS/HSCO drills

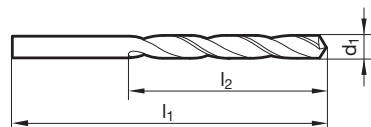

Article no.

579

Article no.

579

d1 mm	inch	l1 mm	l2 mm	Order no.
1.500		153.0	23.0	579 1.500
1.590	1/16	153.0	26.0	579 1.590
1.780		153.0	26.0	579 1.780
1.980	5/64	153.0	29.0	579 1.980
2.000		153.0	29.0	579 2.000
2.380	3/32	153.0	37.0	579 2.380
2.400		153.0	37.0	579 2.400
2.490		153.0	37.0	579 2.490
2.500		153.0	37.0	579 2.500
2.580		153.0	37.0	579 2.580
2.640		153.0	37.0	579 2.640
2.710		153.0	42.0	579 2.710
2.780	7/64	153.0	42.0	579 2.780
2.790		153.0	42.0	579 2.790
2.820		153.0	42.0	579 2.820
2.870		153.0	42.0	579 2.870
2.950		153.0	42.0	579 2.950
3.000		153.0	42.0	579 3.000
3.050		153.0	42.0	579 3.050
3.170	1/8	153.0	42.0	579 3.170
3.200		153.0	42.0	579 3.200
3.260		153.0	42.0	579 3.260
3.450		154.0	49.0	579 3.450
3.500		154.0	49.0	579 3.500
3.570	9/64	154.0	49.0	579 3.570
3.600		154.0	49.0	579 3.600
3.660		154.0	49.0	579 3.660
3.800		154.0	55.0	579 3.800
3.970	5/32	154.0	55.0	579 3.970
3.990		154.0	55.0	579 3.990

d1 mm	inch	l1 mm	l2 mm	Order no.
4.000		154.0	55.0	579 4.000
4.040		154.0	55.0	579 4.040
4.090		154.0	55.0	579 4.090
4.370	11/64	154.0	60.0	579 4.370
4.500		154.0	60.0	579 4.500
4.620		154.0	60.0	579 4.620
4.760	3/16	154.0	63.5	579 4.760
4.800		154.0	63.5	579 4.800
4.920		154.0	63.5	579 4.920
4.980		154.0	63.5	579 4.980
5.000		154.0	63.5	579 5.000
5.560	7/32	154.0	68.5	579 5.560
5.800		154.0	68.5	579 5.800
5.940		154.0	68.5	579 5.940
5.950	15/64	154.0	68.5	579 5.950
6.040		154.0	75.0	579 6.040
6.350	1/4	154.0	75.0	579 6.350
6.450		154.0	75.0	579 6.450
6.530		154.0	75.0	579 6.530
6.750	17/64	155.0	80.0	579 6.750
7.940	5/16	155.0	90.0	579 7.940
8.000		155.0	90.0	579 8.000



Aircraft extension drills, 12 inches long

Article no. **578**



Cutting data page 459



Web thinning $\geq \varnothing 1.500$ • relieved cone

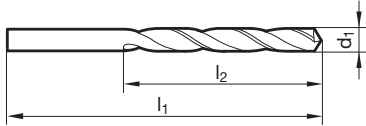

Article no. 578				Article no. 578					
d1 mm	inch	l1 mm	l2 mm	Order no.	d1 mm	inch	l1 mm	l2 mm	Order no.
1.500		306.0	23.0	578 1.500	3.970	5/32	308.0	55.0	578 3.970
1.590	1/16	306.0	26.0	578 1.590	4.000		308.0	55.0	578 4.000
1.780		306.0	26.0	578 1.780	4.040		308.0	55.0	578 4.040
1.850		306.0	26.0	578 1.850	4.090		308.0	55.0	578 4.090
1.930		306.0	29.0	578 1.930	4.220		308.0	55.0	578 4.220
2.000		306.0	29.0	578 2.000	4.500		308.0	60.0	578 4.500
2.180		306.0	32.5	578 2.180	4.570		308.0	60.0	578 4.570
2.260		306.0	32.5	578 2.260	4.620		308.0	60.0	578 4.620
2.380	3/32	306.0	37.0	578 2.380	4.760	3/16	308.0	63.5	578 4.760
2.440		306.0	37.0	578 2.440	4.800		308.0	63.5	578 4.800
2.490		306.0	37.0	578 2.490	4.920		308.0	63.5	578 4.920
2.500		306.0	37.0	578 2.500	4.980		308.0	63.5	578 4.980
2.580		306.0	37.0	578 2.580	5.000		308.0	63.5	578 5.000
2.640		306.0	37.0	578 2.640	5.160	13/64	308.0	63.5	578 5.160
2.790		306.0	42.0	578 2.790	5.500		308.0	68.5	578 5.500
2.820		306.0	42.0	578 2.820	5.560	7/32	308.0	68.5	578 5.560
3.000		306.0	42.0	578 3.000	5.800		308.0	68.5	578 5.800
3.170	1/8	306.0	42.0	578 3.170	5.950	15/64	308.0	68.5	578 5.950
3.200		306.0	42.0	578 3.200	6.000		308.0	68.5	578 6.000
3.260		306.0	42.0	578 3.260	6.040		308.0	75.0	578 6.040
3.500		308.0	49.0	578 3.500	6.350	1/4	308.0	75.0	578 6.350
3.570	9/64	308.0	49.0	578 3.570	6.530		308.0	75.0	578 6.530
3.660		308.0	49.0	578 3.660	7.000		310.0	80.0	578 7.000
3.800		308.0	55.0	578 3.800	8.000		310.0	90.0	578 8.000



Aircraft extension drills, 12 inches long

Article no. **580**



Cutting data page 459

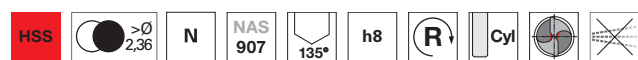

Web thinning $\geq \varnothing 1.500$ • relieved cone



HSS/HSCO drills

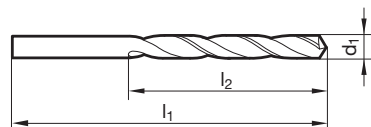

Article no.

580

Article no.

580

d1 mm	inch	l1 mm	l2 mm	Order no.
1.500		306.0	23.0	580 1.500
1.590	1/16	306.0	26.0	580 1.590
1.780		306.0	26.0	580 1.780
1.980	5/64	306.0	29.0	580 1.980
2.000		306.0	29.0	580 2.000
2.380	3/32	306.0	37.0	580 2.380
2.490		306.0	37.0	580 2.490
2.500		306.0	37.0	580 2.500
2.580		306.0	37.0	580 2.580
2.710		306.0	42.0	580 2.710
2.870		306.0	42.0	580 2.870
2.950		306.0	42.0	580 2.950
3.000		306.0	42.0	580 3.000
3.170	1/8	306.0	42.0	580 3.170
3.260		306.0	42.0	580 3.260
3.660		308.0	49.0	580 3.660
3.730		308.0	49.0	580 3.730
3.800		308.0	55.0	580 3.800
3.970	5/32	308.0	55.0	580 3.970
3.990		308.0	55.0	580 3.990
4.000		308.0	55.0	580 4.000
4.040		308.0	55.0	580 4.040
4.300		308.0	60.0	580 4.300
4.500		308.0	60.0	580 4.500

d1 mm	inch	l1 mm	l2 mm	Order no.
4.570		308.0	60.0	580 4.570
4.700		308.0	60.0	580 4.700
4.760	3/16	308.0	63.5	580 4.760
4.800		308.0	63.5	580 4.800
4.850		308.0	63.5	580 4.850
4.920		308.0	63.5	580 4.920
5.000		308.0	63.5	580 5.000
5.060		308.0	63.5	580 5.060
5.110		308.0	63.5	580 5.110
5.160	13/64	308.0	63.5	580 5.160
5.560	7/32	308.0	68.5	580 5.560
5.790		308.0	68.5	580 5.790
5.950	15/64	308.0	68.5	580 5.950
6.000		308.0	68.5	580 6.000
6.040		308.0	75.0	580 6.040
6.150		308.0	75.0	580 6.150
6.250		308.0	75.0	580 6.250
6.350	1/4	308.0	75.0	580 6.350
6.530		308.0	75.0	580 6.530
6.800		310.0	80.0	580 6.800
7.940	5/16	310.0	90.0	580 7.940
8.000		310.0	90.0	580 8.000

d1 mm	inch	l1 mm	l2 mm	Order no.
4.570		308.0	60.0	580 4.570
4.700		308.0	60.0	580 4.700
4.760	3/16	308.0	63.5	580 4.760
4.800		308.0	63.5	580 4.800
4.850		308.0	63.5	580 4.850
4.920		308.0	63.5	580 4.920
5.000		308.0	63.5	580 5.000
5.060		308.0	63.5	580 5.060
5.110		308.0	63.5	580 5.110
5.160	13/64	308.0	63.5	580 5.160
5.560	7/32	308.0	68.5	580 5.560
5.790		308.0	68.5	580 5.790
5.950	15/64	308.0	68.5	580 5.950
6.000		308.0	68.5	580 6.000
6.040		308.0	75.0	580 6.040
6.150		308.0	75.0	580 6.150
6.250		308.0	75.0	580 6.250
6.350	1/4	308.0	75.0	580 6.350
6.530		308.0	75.0	580 6.530
6.800		310.0	80.0	580 6.800
7.940	5/16	310.0	90.0	580 7.940
8.000		310.0	90.0	580 8.000



HSS/HSCO drills with straight shank

HSS/HSCO drills

Twist drills with coolant ducts

Article no. **390**



Cutting data page 472

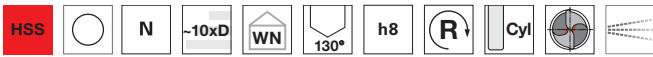

Web thinning $\geq \varnothing 3.000$ • relieved cone • also for drilling through drill bushes • especially for drilling depths over 5xD

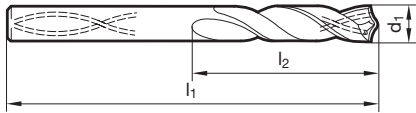

Article no. 390				Article no. 390			
d1 mm	l1 mm	l2 mm	Order no.	d1 mm	l1 mm	l2 mm	Order no.
3.000	100.0	66.0	390 3.000	7.500	156.0	102.0	390 7.500
3.300	106.0	69.0	390 3.300	8.000	165.0	109.0	390 8.000
3.500	112.0	73.0	390 3.500	8.500	165.0	109.0	390 8.500
4.000	119.0	78.0	390 4.000	9.000	175.0	115.0	390 9.000
4.200	119.0	78.0	390 4.200	9.500	175.0	115.0	390 9.500
4.500	126.0	82.0	390 4.500	10.000	184.0	121.0	390 10.000
5.000	132.0	87.0	390 5.000	10.200	184.0	121.0	390 10.200
5.500	139.0	91.0	390 5.500	10.500	184.0	121.0	390 10.500
6.000	139.0	91.0	390 6.000	11.000	195.0	128.0	390 11.000
6.500	148.0	97.0	390 6.500	11.500	195.0	128.0	390 11.500
6.800	156.0	102.0	390 6.800	12.000	205.0	134.0	390 12.000
7.000	156.0	102.0	390 7.000	13.000	205.0	134.0	390 13.000

Twist drills with coolant ducts

Article no. **1132**



Cutting data page 471



Web thinning $\geq \varnothing 5.000$ • relieved cone • Co-alloyed high speed steel • increased wear resistance

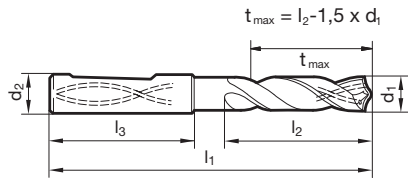

Article no. 1132							Article no. 1132						
d1 mm	inch	d2 mm	l1 mm	l2 mm	l3 mm	Order no.	d1 mm	inch	d2 mm	l1 mm	l2 mm	l3 mm	Order no.
5.000		6.0	82.0	44.0	36.0	1132 5.000	12.000		12.0	118.0	71.0	45.0	1132 12.000
5.500		6.0	82.0	44.0	36.0	1132 5.500	12.500		14.0	124.0	77.0	45.0	1132 12.500
6.000		6.0	82.0	44.0	36.0	1132 6.000	13.000		14.0	124.0	77.0	45.0	1132 13.000
6.500		8.0	91.0	53.0	36.0	1132 6.500	13.500		14.0	124.0	77.0	45.0	1132 13.500
6.800		8.0	91.0	53.0	36.0	1132 6.800	14.000		14.0	124.0	77.0	45.0	1132 14.000
7.000		8.0	91.0	53.0	36.0	1132 7.000	14.500		16.0	133.0	83.0	48.0	1132 14.500
7.500		8.0	91.0	53.0	36.0	1132 7.500	15.000		16.0	133.0	83.0	48.0	1132 15.000
7.800		8.0	91.0	53.0	36.0	1132 7.800	15.500		16.0	133.0	83.0	48.0	1132 15.500
8.000		8.0	91.0	53.0	36.0	1132 8.000	16.000		16.0	133.0	83.0	48.0	1132 16.000
8.500		10.0	103.0	61.0	40.0	1132 8.500	16.500		18.0	143.0	93.0	48.0	1132 16.500
9.000		10.0	103.0	61.0	40.0	1132 9.000	17.000		18.0	143.0	93.0	48.0	1132 17.000
9.500		10.0	103.0	61.0	40.0	1132 9.500	17.500		18.0	143.0	93.0	48.0	1132 17.500
10.000		10.0	103.0	61.0	40.0	1132 10.000	18.000		18.0	143.0	93.0	48.0	1132 18.000
10.200		12.0	118.0	71.0	45.0	1132 10.200	19.000		20.0	153.0	101.0	50.0	1132 19.000
10.320	13/32	12.0	118.0	71.0	45.0	1132 10.320	19.500		20.0	153.0	101.0	50.0	1132 19.500
10.500		12.0	118.0	71.0	45.0	1132 10.500	20.000		20.0	153.0	101.0	50.0	1132 20.000
11.000		12.0	118.0	71.0	45.0	1132 11.000							
11.500		12.0	118.0	71.0	45.0	1132 11.500							



Drills with shank Ø 12.7 mm

Article no. **268**



Cutting data page 442



P	M	K	N	S	H
•		•	○		

Web thinning ≥ Ø 14.290 • relieved cone • with solid shank

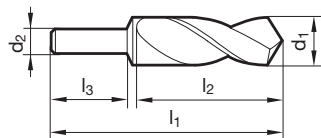

Article no. **268**

d1 mm	d2 mm	l1 mm	l2 mm	l3 mm	Order no.
13.000	12.7	156.0	82.0	57.0	268 13.000
13.500	12.7	156.0	82.0	57.0	268 13.500
14.000	12.7	156.0	82.0	57.0	268 14.000
14.500	12.7	157.0	83.0	57.0	268 14.500
15.000	12.7	157.0	83.0	57.0	268 15.000
15.500	12.7	157.0	83.0	57.0	268 15.500
15.870	12.7	157.0	83.0	57.0	268 15.870
16.000	12.7	157.0	83.0	57.0	268 16.000
16.500	12.7	158.0	84.0	57.0	268 16.500
16.670	12.7	158.0	84.0	57.0	268 16.670
17.000	12.7	158.0	84.0	57.0	268 17.000
17.460	12.7	158.0	84.0	57.0	268 17.460
17.500	12.7	158.0	84.0	57.0	268 17.500
18.000	12.7	158.0	84.0	57.0	268 18.000
19.000	12.7	158.0	84.0	57.0	268 19.000
19.050	12.7	159.0	85.0	57.0	268 19.050
19.500	12.7	159.0	85.0	57.0	268 19.500
19.840	12.7	159.0	85.0	57.0	268 19.840

Article no. **268**

d1 mm	d2 mm	l1 mm	l2 mm	l3 mm	Order no.
20.000	12.7	159.0	85.0	57.0	268 20.000
21.000	12.7	159.0	85.0	57.0	268 21.000
22.000	12.7	159.0	85.0	57.0	268 22.000
22.220	12.7	159.0	85.0	57.0	268 22.220
23.000	12.7	159.0	85.0	57.0	268 23.000
23.020	12.7	159.0	85.0	57.0	268 23.020
23.810	12.7	160.0	86.0	57.0	268 23.810
24.000	12.7	160.0	86.0	57.0	268 24.000
25.000	12.7	160.0	86.0	57.0	268 25.000
25.400	12.7	160.0	86.0	57.0	268 25.400
28.570	12.7	160.0	86.0	57.0	268 28.570

HSS/HSCO drills



HSS/HSCO drills with straight shank

HSS/HSCO drills

Drills with shank Ø 16.0 mm

Article no. 128



Cutting data page 442

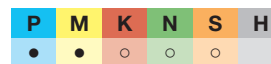
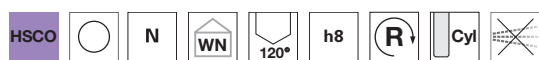

without point grinding • Co-alloyed high speed steel • increased wear resistance • with solid shank • blank, centering on both sides • for modification, e.g. to diameter, step grind or form grind

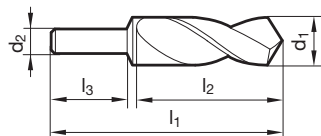

Article no. 128

d1 mm	d2 mm	l1 mm	l2 mm	l3 mm	Order no.
16.000	16.0	130.0	88.0	42.0	128 16.000
16.500	16.0	130.0	88.0	40.0	128 16.500
17.000	16.0	130.0	88.0	40.0	128 17.000
17.500	16.0	130.0	88.0	40.0	128 17.500
18.000	16.0	130.0	88.0	40.0	128 18.000
19.000	16.0	130.0	88.0	40.0	128 19.000
20.000	16.0	130.0	88.0	40.0	128 20.000
20.500	16.0	130.0	88.0	40.0	128 20.500
21.000	16.0	130.0	88.0	40.0	128 21.000
21.500	16.0	130.0	88.0	40.0	128 21.500
22.000	16.0	130.0	88.0	40.0	128 22.000
22.500	16.0	130.0	88.0	40.0	128 22.500
23.000	16.0	130.0	88.0	40.0	128 23.000
23.500	16.0	130.0	88.0	40.0	128 23.500
24.000	16.0	130.0	88.0	40.0	128 24.000
24.500	16.0	130.0	88.0	40.0	128 24.500
25.000	16.0	130.0	88.0	40.0	128 25.000
25.500	16.0	140.0	98.0	40.0	128 25.500

Article no. 128

d1 mm	d2 mm	l1 mm	l2 mm	l3 mm	Order no.
26.000	16.0	140.0	98.0	40.0	128 26.000
27.000	16.0	140.0	98.0	40.0	128 27.000
28.000	16.0	140.0	98.0	40.0	128 28.000
28.500	16.0	140.0	98.0	40.0	128 28.500
30.000	16.0	140.0	98.0	40.0	128 30.000
31.000	16.0	140.0	98.0	40.0	128 31.000
32.000	16.0	140.0	98.0	40.0	128 32.000
35.000	16.0	140.0	98.0	40.0	128 35.000
38.000	16.0	140.0	98.0	40.0	128 38.000
40.000	16.0	140.0	98.0	40.0	128 40.000

Twist drill sets

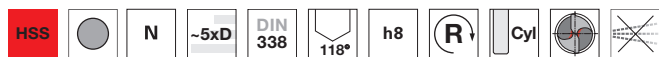
 Article no. **201**

Web thinning $\geq \varnothing 1.000$ • relieved cone • Sets with the most common drill dimensions are available for fitters and craftsmen, which can be supplied with bakelite stands and cassettes. Other set combinations are possible on request.

Article no.

201

d1	increasing by	supplement. \varnothing	Pieces/set	Order no.
1.0-5.9	0.1		50	201 0.015
1.0-10.5	0.5	3.3/4.2/6.8/10.2	24	201 0.018
1.0-10.5	0.5	1.9/2.1/2.6/2.9/3.2/3.3/3.8/4.2/5.1/6.8/7.9/10.2	32	201 0.019
1.0-13.0	0.5		25	201 0.014
1.0-10.0	0.5		19	201 0.013
6.0-10.0	0.1		41	201 0.016
1.0-5.0	0.1		41	201 0.011
1.02-5.79	1/64		60	201 0.026
5.1-10.0	0.1		50	201 0.012
1/16 - 1/2	1/64		29	201 0.021

Twist drill sets

 Article no. **17**

relieved cone • Sets with the most common drill dimensions are available for fitters and craftsmen, which can be supplied with bakelite stands and cassettes. Other set combinations are possible on request.

Article no.

17

d1	increasing by	supplement. \varnothing	Pieces/set	Order no.
1.0-5.9	0.1		50	17 6.015
1.0-13.0	0.5		25	17 6.014
1.0-10.0	0.5		19	17 6.013
6.0-10.0	0.1		41	17 6.016
1/16 - 1/2	1/64		29	17 6.021



Twist drill sets

Article no. **16**

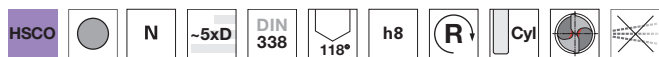

Web thinning $\geq \varnothing 1.000$ • relieved cone • Sets with the most common drill dimensions are available for fitters and craftsmen, which can be supplied with bakelite stands and cassettes. Other set combinations are possible on request.

				Article no.	16
d1	increasing by	supplement. \varnothing	Pieces/set	Order no.	
1.0-5.9	0.1		50	16 3.015	
1.0-13.0	0.5		25	16 3.014	
1.0-10.0	0.5		19	16 3.013	
6.0-10.0	0.1		41	16 3.016	
1/16 - 1/2	1/64		29	16 3.021	

Twist drill sets

Article no. **18**

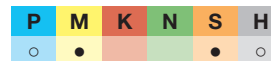
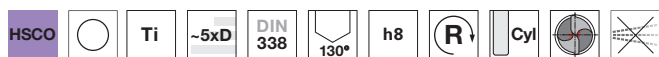

Web thinning $\geq \varnothing 0.970$ • relieved cone • Sets with the most common drill dimensions are available for fitters and craftsmen, which can be supplied with bakelite stands and cassettes. Other set combinations are possible on request.

				Article no.	18
d1	increasing by	supplement. \varnothing	Pieces/set	Order no.	
1.0-5.9	0.1		50	18 8.015	
6.0-10.0	0.1		41	18 8.016	
1.0-10.0	0.5		19	18 8.013	
1.0-13.0	0.5		25	18 8.014	
1.0-10.5	0.5	3.3/4.2/6.8/10.2	24	18 8.018	



Twist drill sets

Article no. **9001**



≥ Ø 4.00 mm with 3-flats on shank • 3-flats on shank prevent slipping in the chuck • for use in drilling machines with 3-jaw chucks • optimally suited for hand drilling machines and pillar drill machines • 4-facet point grind with split point ≥ Ø 1.000 • low feed force • fastest drilling progress • for universal application

Article no. **9001**

d1	increasing by	supplement. Ø	Pieces/set	Order no.
1.0-10.0	0.5		19	9001 0.013
1.0-13.0	0.5		25	9001 0.014

AeroX split point drill sets

Article no. **1083**

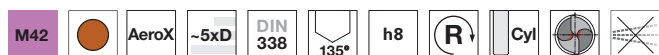

Web thinning ≥ Ø 1.000 • optimised split point • 8% cobalt-alloyed HSCO high speed steel • Sets with the most common drill dimensions are available for fitters and craftsmen, which can be supplied with bakelite stands and cassettes. Other set combinations are possible on request.

Article no. **1083**

d1	increasing by	supplement. Ø	Pieces/set	Order no.
1.0-10.0	0.5		19	1083 0.013
1.0-13.0	0.5		25	1083 0.014
1/16 - 1/2	1/64		29	1083 0.021



HSS/HSCO drills

Short flute drill sets

Article no. **6030**



M42

H
3xD

h8

P	M	K	N	S	H
●	○	●	○	●	○

optimised split point • 8% cobalt-alloyed HSCO high speed steel • especially high wear resistance • consisting of art. no. 693

Article no. **6030**

d1	increasing by	supplement. Ø	Pieces/set	Order no.
1.0-10.5	0.5	3.3/4.2/6.8/10.2	24	6030 0.018

Jobber drills

 Article no. **363**

Cutting data page 446

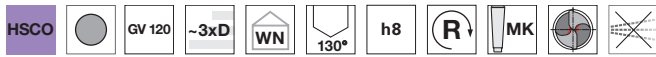

P	M	K	N	S	H
●	●	●	○	○	○

 Web thinning $\geq \varnothing 7.000$ • relieved cone • Co-alloyed high speed steel • increased wear resistance

Jobber drills

 Article no. **663**

Cutting data page 446

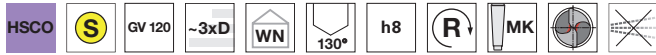

P	M	K	N	S	H
●	●	●	○	●	○

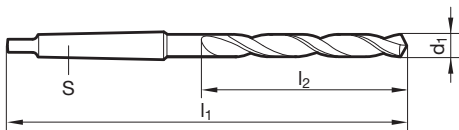
 Web thinning $\geq \varnothing 9.000$ • relieved cone • Co-alloyed high speed steel • increased wear resistance

Article no. 363					Article no. 663								
d1 mm	inch	S	l1 mm	l2 mm	Order no.		d1 mm	inch	S	l1 mm	l2 mm	Order no.	
8.100		MK-1	130.0	49.0	363	8.100	20.000		MK-3	212.0	91.0	363	20.000
8.200		MK-1	130.0	49.0	363	8.200	20.500		MK-3	216.0	95.0	363	20.500
8.500		MK-1	130.0	49.0	363	8.500	21.000		MK-3	216.0	95.0	363	21.000
8.600		MK-1	134.0	53.0	363	8.600	21.500		MK-3	219.0	98.0	363	21.500
9.000		MK-1	134.0	53.0	363	9.000	22.000		MK-3	219.0	98.0	363	22.000
9.920	25/64	MK-1	138.0	57.0	363	9.920	22.220	7/8	MK-3	219.0	98.0	363	22.220
10.000		MK-1	138.0	57.0	363	10.000	23.000		MK-3	222.0	101.0	363	23.000
10.200		MK-1	138.0	57.0	363	10.200	24.000		MK-3	225.0	104.0	363	24.000
10.500		MK-1	138.0	57.0	363	10.500	24.500		MK-3	225.0	104.0	363	24.500
10.750		MK-1	142.0	61.0	363	10.750	25.000	63/64	MK-3	225.0	104.0	363	25.000
11.000		MK-1	142.0	61.0	363	11.000	26.000		MK-4	256.0	107.0	363	26.000
11.750		MK-1	142.0	61.0	363	11.750	26.500		MK-4	256.0	107.0	363	26.500
12.000		MK-1	147.0	66.0	363	12.000	27.000		MK-4	259.0	110.0	363	27.000
12.500		MK-1	147.0	66.0	363	12.500	27.500		MK-4	259.0	110.0	363	27.500
13.000		MK-1	147.0	66.0	363	13.000	28.000		MK-4	259.0	110.0	363	28.000
13.500		MK-2	168.0	70.0	363	13.500	29.000		MK-4	263.0	114.0	363	29.000
14.000		MK-2	168.0	70.0	363	14.000	30.000		MK-4	263.0	114.0	363	30.000
14.250		MK-2	172.0	74.0	363	14.250	31.000		MK-4	266.0	117.0	363	31.000
14.500		MK-2	172.0	74.0	363	14.500	32.000		MK-4	269.0	120.0	363	32.000
15.000		MK-2	172.0	74.0	363	15.000	33.000		MK-4	269.0	120.0	363	33.000
15.500		MK-2	176.0	78.0	363	15.500	37.000		MK-4	276.0	127.0	363	37.000
16.000		MK-2	176.0	78.0	363	16.000							
16.500		MK-2	179.0	81.0	363	16.500							
17.000		MK-2	179.0	81.0	363	17.000							
17.070	43/64	MK-2	183.0	85.0	363	17.070							
17.500		MK-2	183.0	85.0	363	17.500							
18.000		MK-2	183.0	85.0	363	18.000							
18.500		MK-2	186.0	88.0	363	18.500							
19.000		MK-2	186.0	88.0	363	19.000							
19.450	49/64	MK-3	212.0	91.0	363	19.450							



HSS/HSCO drills with morse taper

HSS/HSCO drills

Twist drills

Article no. **245**



Cutting data page 442



Web thinning $\geq \varnothing 14.050$ • relieved cone

P	M	K	N	S	H
•		•	○		

Twist drills

Article no. **654**



Cutting data page 442

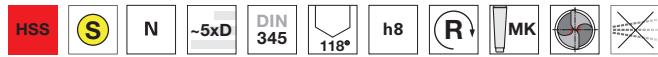

Web thinning $\geq \varnothing 3.000$ • relieved cone

P	M	K	N	S	H
•		•	○		

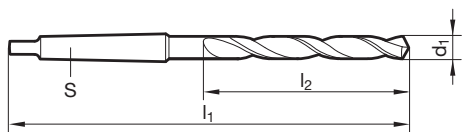

Article no. 245					Article no. 654					
d1 mm	inch	S	l1 mm	l2 mm	Order no.					
2.000		MK-1	101.0	24.0	245 2.000					
2.500		MK-1	111.0	30.0	245 2.500					
2.780	7/64	MK-1	114.0	33.0	245 2.780					
3.000		MK-1	114.0	33.0	245 3.000	654 3.000				
3.170	1/8	MK-1	117.0	36.0	245 3.170					
3.200		MK-1	117.0	36.0	245 3.200					
3.250		MK-1	117.0	36.0	245 3.250					
3.300		MK-1	117.0	36.0	245 3.300					
3.450		MK-1	120.0	39.0	245 3.450					
3.500		MK-1	120.0	39.0	245 3.500	654 3.500				
3.570	9/64	MK-1	120.0	39.0	245 3.570					
3.800		MK-1	124.0	43.0	245 3.800					
3.970	5/32	MK-1	124.0	43.0	245 3.970					
4.000		MK-1	124.0	43.0	245 4.000	654 4.000				
4.100		MK-1	124.0	43.0	245 4.100	654 4.100				
4.200		MK-1	124.0	43.0	245 4.200					
4.250		MK-1	124.0	43.0	245 4.250					
4.300		MK-1	128.0	47.0	245 4.300					
4.370	11/64	MK-1	128.0	47.0	245 4.370	654 4.370				
4.400		MK-1	128.0	47.0	245 4.400					
4.500		MK-1	128.0	47.0	245 4.500	654 4.500				
4.600		MK-1	128.0	47.0	245 4.600					
4.750		MK-1	128.0	47.0	245 4.750					
4.760	3/16	MK-1	133.0	52.0	245 4.760	654 4.760				
4.800		MK-1	133.0	52.0	245 4.800					
5.000		MK-1	133.0	52.0	245 5.000	654 5.000				
5.100		MK-1	133.0	52.0	245 5.100					
5.160	13/64	MK-1	133.0	52.0	245 5.160	654 5.160				
5.200		MK-1	133.0	52.0	245 5.200					
5.250		MK-1	133.0	52.0	245 5.250					
5.300		MK-1	133.0	52.0	245 5.300					
5.500		MK-1	138.0	57.0	245 5.500					
5.560	7/32	MK-1	138.0	57.0	245 5.560					
5.600		MK-1	138.0	57.0	245 5.600					
5.700		MK-1	138.0	57.0	245 5.700					
5.750		MK-1	138.0	57.0	245 5.750					
5.800		MK-1	138.0	57.0	245 5.800					
5.900		MK-1	138.0	57.0	245 5.900					
5.950	15/64	MK-1	138.0	57.0	245 5.950					
6.000		MK-1	138.0	57.0	245 6.000	654 6.000				
6.100		MK-1	144.0	63.0	245 6.100					
6.200		MK-1	144.0	63.0	245 6.200					
6.300		MK-1	144.0	63.0	245 6.300					
6.350	1/4	MK-1	144.0	63.0	245 6.350					
6.400		MK-1	144.0	63.0	245 6.400					
6.500		MK-1	144.0	63.0	245 6.500	654 6.500				
6.600		MK-1	144.0	63.0	245 6.600					
6.700		MK-1	144.0	63.0	245 6.700					
6.750	17/64	MK-1	150.0	69.0	245 6.750	654 6.750				
6.800		MK-1	150.0	69.0	245 6.800	654 6.800				
6.900		MK-1	150.0	69.0	245 6.900					
7.000		MK-1	150.0	69.0	245 7.000	654 7.000				
7.140	9/32	MK-1	150.0	69.0	245 7.140	654 7.140				
7.200		MK-1	150.0	69.0	245 7.200					
7.250		MK-1	150.0	69.0						
7.300		MK-1	150.0	69.0						
7.400		MK-1	150.0	69.0						
7.500		MK-1	150.0	69.0						
7.540	19/64	MK-1	156.0	75.0						
7.600		MK-1	156.0	75.0						
7.700		MK-1	156.0	75.0						
7.750		MK-1	156.0	75.0						
7.800		MK-1	156.0	75.0						
7.900		MK-1	156.0	75.0						
7.940	5/16	MK-1	156.0	75.0						
8.000		MK-1	156.0	75.0						
8.050		MK-1	156.0	75.0						
8.100		MK-1	156.0	75.0						
8.200		MK-1	156.0	75.0						
8.250		MK-1	156.0	75.0						
8.300		MK-1	156.0	75.0						
8.330	21/64	MK-1	156.0	75.0						
8.400		MK-1	156.0	75.0						
8.500		MK-1	156.0	75.0						
8.600		MK-1	162.0	81.0						
8.700		MK-1	162.0	81.0						
8.730	11/32	MK-1	162.0	81.0						
8.750		MK-1	162.0	81.0						
8.800		MK-1	162.0	81.0						
8.900		MK-1	162.0	81.0						
9.000		MK-1	162.0	81.0						
9.100		MK-1	162.0	81.0						
9.130	23/64	MK-1	162.0	81.0						
9.200		MK-1	162.0	81.0						
9.250		MK-1	162.0	81.0						
9.300		MK-1	162.0	81.0						
9.500		MK-1	162.0	81.0						
9.520	3/8	MK-1	168.0	87.0						
9.600		MK-1	168.0	87.0						
9.750		MK-1	168.0	87.0						
9.800		MK-1	168.0	87.0						
9.900		MK-1	168.0	87.0						
9.920	25/64	MK-1	168.0	87.0						
10.000		MK-1	168.0	87.0						
10.100		MK-1	168.0	87.0						
10.200		MK-1	168.0	87.0						
10.250		MK-1	168.0	87.0						
10.300		MK-1	168.0	87.0						
10.320	13/32	MK-1	168.0	87.0						
10.400		MK-1	168.0	87.0						
10.500		MK-1	168.0	87.0						
10.600		MK-1	168.0	87.0						
10.700		MK-1	175.0	94.0						
10.720	27/64	MK-1	175.0	94.0						
10.750		MK-1	175.0	94.0						
10.800		MK-1	175.0	94.0						
10.900		MK-1	175.0	94.0						
11.000		MK-1	175.0	94.0						



Article no.					245	654	Article no.					245	654
d1 mm	inch	S	l1 mm	l2 mm	Order no.		d1 mm	inch	S	l1 mm	l2 mm	Order no.	
11.100		MK-1	175.0	94.0	245 11.100		17.250		MK-2	228.0	130.0	245 17.250	654 17.250
11.110	7/16	MK-1	175.0	94.0	245 11.110	654 11.110	17.300		MK-2	228.0	130.0	245 17.300	
11.200		MK-1	175.0	94.0	245 11.200	654 11.200	17.400		MK-2	228.0	130.0	245 17.400	
11.250		MK-1	175.0	94.0	245 11.250	654 11.250	17.460	11/16	MK-2	228.0	130.0	245 17.460	
11.300		MK-1	175.0	94.0	245 11.300		17.500		MK-2	228.0	130.0	245 17.500	654 17.500
11.500		MK-1	175.0	94.0	245 11.500	654 11.500	17.600		MK-2	228.0	130.0	245 17.600	
11.510	29/64	MK-1	175.0	94.0	245 11.510	654 11.510	17.700		MK-2	228.0	130.0	245 17.700	
11.600		MK-1	175.0	94.0	245 11.600		17.750		MK-2	228.0	130.0	245 17.750	654 17.750
11.700		MK-1	175.0	94.0	245 11.700		17.800		MK-2	228.0	130.0	245 17.800	
11.750		MK-1	175.0	94.0	245 11.750	654 11.750	17.860	45/64	MK-2	228.0	130.0	245 17.860	
11.800		MK-1	175.0	94.0	245 11.800	654 11.800	17.900		MK-2	228.0	130.0	245 17.900	
11.900		MK-1	182.0	101.0	245 11.900		18.000		MK-2	228.0	130.0	245 18.000	654 18.000
11.910	15/32	MK-1	182.0	101.0	245 11.910	654 11.910	18.100		MK-2	233.0	135.0	245 18.100	
12.000		MK-1	182.0	101.0	245 12.000	654 12.000	18.200		MK-2	233.0	135.0	245 18.200	
12.100		MK-1	182.0	101.0	245 12.100		18.250		MK-2	233.0	135.0	245 18.250	654 18.250
12.200		MK-1	182.0	101.0	245 12.200	654 12.200	18.260	23/32	MK-2	233.0	135.0	245 18.260	654 18.260
12.250		MK-1	182.0	101.0	245 12.250	654 12.250	18.300		MK-2	233.0	135.0	245 18.300	
12.300	31/64	MK-1	182.0	101.0	245 12.300	654 12.300	18.500		MK-2	233.0	135.0	245 18.500	654 18.500
12.500		MK-1	182.0	101.0	245 12.500	654 12.500	18.650	47/64	MK-2	233.0	135.0	245 18.650	654 18.650
12.600		MK-1	182.0	101.0	245 12.600		18.750		MK-2	233.0	135.0	245 18.750	
12.700	1/2	MK-1	182.0	101.0	245 12.700	654 12.700	18.800		MK-2	233.0	135.0	245 18.800	
12.750		MK-1	182.0	101.0	245 12.750	654 12.750	18.900		MK-2	233.0	135.0	245 18.900	
12.800		MK-1	182.0	101.0	245 12.800		19.000		MK-2	233.0	135.0	245 19.000	654 19.000
12.900		MK-1	182.0	101.0	245 12.900		19.050	3/4	MK-2	238.0	140.0	245 19.050	654 19.050
13.000		MK-1	182.0	101.0	245 13.000	654 13.000	19.100		MK-2	238.0	140.0	245 19.100	
13.100	33/64	MK-1	182.0	101.0	245 13.100	654 13.100	19.200		MK-2	238.0	140.0	245 19.200	
13.200		MK-1	182.0	101.0	245 13.200		19.250		MK-2	238.0	140.0	245 19.250	
13.250		MK-1	189.0	108.0	245 13.250	654 13.250	19.300		MK-2	238.0	140.0	245 19.300	
13.300		MK-1	189.0	108.0	245 13.300		19.400		MK-2	238.0	140.0	245 19.400	
13.490	17/32	MK-1	189.0	108.0	245 13.490	654 13.490	19.450	49/64	MK-2	238.0	140.0	245 19.450	654 19.450
13.500		MK-1	189.0	108.0	245 13.500	654 13.500	19.500		MK-2	238.0	140.0	245 19.500	654 19.500
13.600		MK-1	189.0	108.0	245 13.600		19.700		MK-2	238.0	140.0	245 19.700	
13.700		MK-1	189.0	108.0	245 13.700		19.750		MK-2	238.0	140.0	245 19.750	654 19.750
13.750		MK-1	189.0	108.0	245 13.750	654 13.750	19.800		MK-2	238.0	140.0	245 19.800	
13.800		MK-1	189.0	108.0	245 13.800		19.840	25/32	MK-2	238.0	140.0	245 19.840	654 19.840
13.890	35/64	MK-1	189.0	108.0	245 13.890	654 13.890	20.000		MK-2	238.0	140.0	245 20.000	654 20.000
14.000		MK-1	189.0	108.0	245 14.000	654 14.000	20.100		MK-2	243.0	145.0	245 20.100	
14.050		MK-2	212.0	114.0	245 14.050		20.200		MK-2	243.0	145.0	245 20.200	
14.100		MK-2	212.0	114.0	245 14.100		20.240	51/64	MK-2	243.0	145.0	245 20.240	
14.200		MK-2	212.0	114.0	245 14.200	654 14.200	20.250		MK-2	243.0	145.0	245 20.250	654 20.250
14.250		MK-2	212.0	114.0	245 14.250	654 14.250	20.300		MK-2	243.0	145.0	245 20.300	
14.290	9/16	MK-2	212.0	114.0	245 14.290	654 14.290	20.400		MK-2	243.0	145.0	245 20.400	
14.300		MK-2	212.0	114.0	245 14.300		20.500		MK-2	243.0	145.0	245 20.500	654 20.500
14.400		MK-2	212.0	114.0	245 14.400		20.600		MK-2	243.0	145.0	245 20.600	
14.500		MK-2	212.0	114.0	245 14.500	654 14.500	20.640	13/16	MK-2	243.0	145.0	245 20.640	
14.600		MK-2	212.0	114.0	245 14.600	654 14.600	20.750		MK-2	243.0	145.0	245 20.750	654 20.750
14.680	37/64	MK-2	212.0	114.0	245 14.680	654 14.680	20.800		MK-2	243.0	145.0	245 20.800	
14.700		MK-2	212.0	114.0	245 14.700		20.900		MK-2	243.0	145.0	245 20.900	
14.750		MK-2	212.0	114.0	245 14.750	654 14.750	21.000		MK-2	243.0	145.0	245 21.000	654 21.000
14.800		MK-2	212.0	114.0	245 14.800		21.030	53/64	MK-2	243.0	145.0	245 21.030	
14.900		MK-2	212.0	114.0	245 14.900	654 14.900	21.200		MK-2	243.0	145.0	245 21.200	
15.000		MK-2	212.0	114.0	245 15.000	654 15.000	21.250		MK-2	248.0	150.0	245 21.250	654 21.250
15.080	19/32	MK-2	218.0	120.0	245 15.080		21.400		MK-2	248.0	150.0	245 21.400	
15.100		MK-2	218.0	120.0	245 15.100	654 15.100	21.430	27/32	MK-2	248.0	150.0	245 21.430	654 21.430
15.200		MK-2	218.0	120.0	245 15.200		21.500		MK-2	248.0	150.0	245 21.500	654 21.500
15.250		MK-2	218.0	120.0	245 15.250	654 15.250	21.700		MK-2	248.0	150.0	245 21.700	
15.300		MK-2	218.0	120.0	245 15.300		21.750		MK-2	248.0	150.0	245 21.750	654 21.750
15.400		MK-2	218.0	120.0	245 15.400		21.830	55/64	MK-2	248.0	150.0	245 21.830	654 21.830
15.480	39/64	MK-2	218.0	120.0	245 15.480	654 15.480	22.000		MK-2	248.0	150.0	245 22.000	654 22.000
15.500		MK-2	218.0	120.0	245 15.500	654 15.500	22.100		MK-2	248.0	150.0	245 22.100	
15.600		MK-2	218.0	120.0	245 15.600		22.200		MK-2	248.0	150.0	245 22.200	
15.700		MK-2	218.0	120.0	245 15.700		22.220	7/8	MK-2	248.0	150.0	245 22.220	654 22.220
15.750		MK-2	218.0	120.0	245 15.750	654 15.750	22.250		MK-2	248.0	150.0	245 22.250	
15.800		MK-2	218.0	120.0	245 15.800		22.300		MK-2	248.0	150.0	245 22.300	
15.870	5/8	MK-2	218.0	120.0	245 15.870	654 15.870	22.400		MK-2	248.0	150.0	245 22.400	
15.900		MK-2	218.0	120.0	245 15.900		22.500		MK-2	253.0	155.0	245 22.500	654 22.500
16.000		MK-2	218.0	120.0	245 16.000	654 16.000	22.620	57/64	MK-2	253.0	155.0	245 22.620	
16.100		MK-2	223.0	125.0	245 16.100		22.750		MK-2	253.0	155.0	245 22.750	
16.200		MK-2	223.0	125.0	245 16.200	654 16.200	23.000		MK-2	253.0	155.0	245 23.000	654 23.000
16.250		MK-2	223.0	125.0	245 16.250		23.020	29/32	MK-2	253.0	155.0	245 23.020	
16.270	41/64	MK-2	223.0	125.0	245 16.270		23.250		MK-3	276.0	155.0	245 23.250	
16.300		MK-2	223.0	125.0	245 16.300		23.420	59/64	MK-3	276.0	155.0	245 23.420	
16.400		MK-2	223.0	125.0	245 16.400		23.500		MK-3	276.0	155.0	245 23.500	654 23.500
16.500		MK-2	223.0	125.0	245 16.500	654 16.500	23.750		MK-3	281.0	160.0	245 23.750	654 23.750
16.600		MK-2	223.0	125.0	245 16.600		23.810	15/16	MK-3	281.0	160.0	245 23.810	
16.670	21/32	MK-2	223.0	125.0	245 16.670		23.900		MK-3	281.0	160.0	245 23.900	
16.700		MK-2	223.0	125.0	245 16.700		24.000		MK-3	281.0	160.0	245 24.000	654 24.000
16.750		MK-2	223.0	125.0	245 16.750		24.100		MK-3	281.0	160.0	245 24.100	
16.800		MK-2	223.0	125.0	245 16.800		24.210	61/64	MK-3	281.0	160.0	245 24.210	
16.900		MK-2	223.0	125.0	245 16.900		24.250		MK-3	281.0	160.0	245 24.250	
17.000		MK-2	223.0	125.0	245 17.000	654 17.000	24.500		MK-3	281.0	160.0	245 24.500	654 24.500
17.070	43/64	MK-2	228.0	130.0	245 17.070	654 17.070	24.610	31/32	MK-3	281.0	160.0	245 24.610	
17.100		MK-2	228.0	130.0	245 17.100		24.700		MK-3	281.0	160.0	245 24.700	
17.200		MK-2	228.0	130.0	245 17.200		24.750		MK-3	281.0	160.0	245 24.750	

HSS/HSCO drills



HSS/HSCO drills with morse taper

HSS/HSCO drills

Article no.					245	654	Article no.					245	654
d1 mm	inch	S	l1 mm	l2 mm	Order no.		d1 mm	inch	S	l1 mm	l2 mm	Order no.	
25.000	63/64	MK-3	281.0	160.0	245 25.000	654 25.000	40.750		MK-4	354.0	205.0	245 40.750	
25.100		MK-3	286.0	165.0	245 25.100		41.000		MK-4	354.0	205.0	245 41.000	
25.200		MK-3	286.0	165.0	245 25.200		41.270	1 5/8	MK-4	354.0	205.0	245 41.270	
25.250		MK-3	286.0	165.0	245 25.250		41.500		MK-4	354.0	205.0	245 41.500	
25.300		MK-3	286.0	165.0	245 25.300		42.000		MK-4	354.0	205.0	245 42.000	
25.400	1	MK-3	286.0	165.0	245 25.400	654 25.400	42.500		MK-4	354.0	205.0	245 42.500	
25.500		MK-3	286.0	165.0	245 25.500	654 25.500	43.000		MK-4	359.0	210.0	245 43.000	
25.750		MK-3	286.0	165.0	245 25.750		43.500		MK-4	359.0	210.0	245 43.500	
25.800	1 1/64	MK-3	286.0	165.0	245 25.800		44.000		MK-4	359.0	210.0	245 44.000	
26.000		MK-3	286.0	165.0	245 26.000	654 26.000	44.450	1 3/4	MK-4	359.0	210.0	245 44.450	
26.190	1 1/32	MK-3	286.0	165.0	245 26.190		44.500		MK-4	359.0	210.0	245 44.500	
26.250		MK-3	286.0	165.0	245 26.250		45.000		MK-4	359.0	210.0	245 45.000	
26.500		MK-3	286.0	165.0	245 26.500	654 26.500	45.500		MK-4	364.0	215.0	245 45.500	
26.590	1 3/64	MK-3	291.0	170.0	245 26.590		46.000		MK-4	364.0	215.0	245 46.000	
26.750		MK-3	291.0	170.0	245 26.750		46.430	1 53/64	MK-4	364.0	215.0	245 46.430	
26.990	1 1/16	MK-3	291.0	170.0	245 26.990	654 26.990	46.500		MK-4	364.0	215.0	245 46.500	
27.000		MK-3	291.0	170.0	245 27.000	654 27.000	47.000		MK-4	364.0	215.0	245 47.000	
27.250		MK-3	291.0	170.0	245 27.250		47.230	1 55/64	MK-4	364.0	215.0	245 47.230	
27.380	1 5/64	MK-3	291.0	170.0		654 27.380	47.500		MK-4	364.0	215.0	245 47.500	
27.500		MK-3	291.0	170.0	245 27.500	654 27.500	47.620	1 7/8	MK-4	369.0	220.0	245 47.620	
27.750		MK-3	291.0	170.0	245 27.750		48.000		MK-4	369.0	220.0	245 48.000	
27.780	1 3/32	MK-3	291.0	170.0	245 27.780		48.500		MK-4	369.0	220.0	245 48.500	
27.800		MK-3	291.0	170.0	245 27.800		48.820	1 59/64	MK-4	369.0	220.0	245 48.820	
28.000		MK-3	291.0	170.0	245 28.000	654 28.000	49.000		MK-4	369.0	220.0	245 49.000	
28.250		MK-3	296.0	175.0	245 28.250		49.500		MK-4	369.0	220.0	245 49.500	
28.500		MK-3	296.0	175.0	245 28.500	654 28.500	50.000		MK-4	369.0	220.0	245 50.000	
28.570	1 1/8	MK-3	296.0	175.0	245 28.570	654 28.570	50.500		MK-4	374.0	225.0	245 50.500	
28.750		MK-3	296.0	175.0	245 28.750		50.800	2	MK-4	374.0	225.0	245 50.800	
29.000		MK-3	296.0	175.0	245 29.000	654 29.000	51.000		MK-5	412.0	225.0	245 51.000	
29.250		MK-3	296.0	175.0	245 29.250		52.000		MK-5	412.0	225.0	245 52.000	
29.500		MK-3	296.0	175.0	245 29.500	654 29.500	53.000		MK-5	412.0	225.0	245 53.000	
29.750		MK-3	296.0	175.0	245 29.750	654 29.750	54.000		MK-5	417.0	230.0	245 54.000	
30.000		MK-3	296.0	175.0	245 30.000	654 30.000	55.000		MK-5	417.0	230.0	245 55.000	
30.100		MK-3	301.0	180.0	245 30.100		56.000		MK-5	417.0	230.0	245 56.000	
30.160	1 3/16	MK-3	301.0	180.0	245 30.160		56.500		MK-5	422.0	235.0	245 56.500	
30.250		MK-3	301.0	180.0	245 30.250		57.000		MK-5	422.0	235.0	245 57.000	
30.500		MK-3	301.0	180.0	245 30.500	654 30.500	58.000		MK-5	422.0	235.0	245 58.000	
30.560	1 13/64	MK-3	301.0	180.0	245 30.560		59.000		MK-5	422.0	235.0	245 59.000	
30.750		MK-3	301.0	180.0	245 30.750		60.000		MK-5	422.0	235.0	245 60.000	
31.000		MK-3	301.0	180.0	245 31.000	654 31.000	61.000		MK-5	427.0	240.0	245 61.000	
31.250		MK-3	301.0	180.0	245 31.250		62.000		MK-5	427.0	240.0	245 62.000	
31.500		MK-3	301.0	180.0	245 31.500		63.000		MK-5	427.0	240.0	245 63.000	
31.750	1 1/4	MK-3	306.0	185.0	245 31.750		63.500	2 1/2	MK-5	432.0	245.0	245 63.500	
32.000		MK-4	334.0	185.0	245 32.000		65.000		MK-5	432.0	245.0	245 65.000	
32.150	1 17/64	MK-4	334.0	185.0	245 32.150		66.670	2 5/8	MK-5	432.0	245.0	245 66.670	
32.250		MK-4	334.0	185.0	245 32.250		67.500		MK-5	437.0	250.0	245 67.500	
32.500		MK-4	334.0	185.0	245 32.500		68.000		MK-5	437.0	250.0	245 68.000	
32.750		MK-4	334.0	185.0	245 32.750		69.850	2 3/4	MK-5	437.0	250.0	245 69.850	
33.000		MK-4	334.0	185.0	245 33.000		70.000		MK-5	437.0	250.0	245 70.000	
33.340	1 5/16	MK-4	334.0	185.0	245 33.340		71.500		MK-5	442.0	255.0	245 71.500	
33.500		MK-4	334.0	185.0	245 33.500		72.000		MK-5	442.0	255.0	245 72.000	
34.000		MK-4	339.0	190.0	245 34.000		73.000		MK-5	442.0	255.0	245 73.000	
34.500		MK-4	339.0	190.0	245 34.500		75.000		MK-5	442.0	255.0	245 75.000	
34.750		MK-4	339.0	190.0	245 34.750		76.500		MK-6	514.0	260.0	245 76.500	
34.920	1 3/8	MK-4	339.0	190.0	245 34.920		77.000		MK-6	514.0	260.0	245 77.000	
35.000		MK-4	339.0	190.0	245 35.000		77.790	3 1/16	MK-6	514.0	260.0	245 77.790	
35.500		MK-4	339.0	190.0	245 35.500		78.000		MK-6	514.0	260.0	245 78.000	
36.000		MK-4	344.0	195.0	245 36.000		78.580	3 3/32	MK-6	514.0	260.0	245 78.580	
36.500		MK-4	344.0	195.0	245 36.500		79.500		MK-6	514.0	260.0	245 79.500	
36.750		MK-4	344.0	195.0	245 36.750		87.310	3 7/16	MK-6	524.0	270.0	245 87.310	
37.000		MK-4	344.0	195.0	245 37.000		93.000		MK-6	529.0	275.0	245 93.000	
37.310	1 15/32	MK-4	344.0	195.0	245 37.310		94.000		MK-6	529.0	275.0	245 94.000	
37.500		MK-4	344.0	195.0	245 37.500		94.500		MK-6	529.0	275.0	245 94.500	
37.700	1 31/64	MK-4	349.0	200.0	245 37.700		95.500		MK-6	534.0	280.0	245 95.500	
38.000		MK-4	349.0	200.0	245 38.000		96.000		MK-6	534.0	280.0	245 96.000	
38.100	1 1/2	MK-4	349.0	200.0	245 38.100		98.000		MK-6	534.0	280.0	245 98.000	
38.500	1 33/64	MK-4	349.0	200.0	245 38.500								
39.000		MK-4	349.0	200.0	245 39.000								
39.500		MK-4	349.0	200.0	245 39.500								
39.690	1 9/16	MK-4	349.0	200.0	245 39.690								
40.000		MK-4	349.0	200.0	245 40.000								
40.500		MK-4	354.0	205.0	245 40.500								

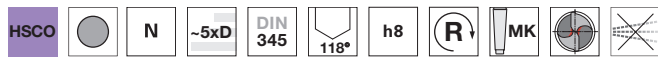

Twist drills

 Article no. **345**

 Web thinning $\geq \varnothing 3.000$ • relieved cone • Co-alloyed high speed steel • increased wear resistance

Cutting data page 442

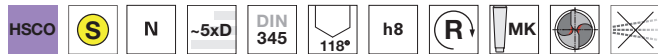
P	M	K	N	S	H
●	○	●	○	○	○

Twist drills

 Article no. **661**

 Web thinning $\geq \varnothing 7.940$ • relieved cone • Co-alloyed high speed steel • increased wear resistance

Cutting data page 442

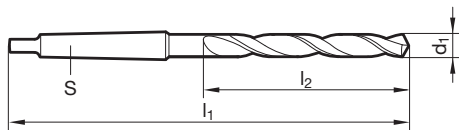
P	M	K	N	S	H
●	○	●	○	○	○



Article no. 345					Article no. 661					Article no. 345					Article no. 661				
d1 mm	inch	S	l1 mm	l2 mm	Order no.					d1 mm	inch	S	l1 mm	l2 mm	Order no.				
4.000		MK-1	124.0	43.0	345 4.000					13.750		MK-1	189.0	108.0	345 13.750				
5.000		MK-1	133.0	52.0	345 5.000					13.800		MK-1	189.0	108.0	345 13.800				
5.500		MK-1	138.0	57.0	345 5.500					13.890	35/64	MK-1	189.0	108.0	345 13.890				
6.000		MK-1	138.0	57.0	345 6.000					13.900		MK-1	189.0	108.0	345 13.900				
6.500		MK-1	144.0	63.0	345 6.500					14.000		MK-1	189.0	108.0	345 14.000	661 14.000			
6.700		MK-1	144.0	63.0	345 6.700					14.100		MK-2	212.0	114.0	345 14.100				
6.750	17/64	MK-1	150.0	69.0	345 6.750					14.200		MK-2	212.0	114.0	345 14.200				
6.800		MK-1	150.0	69.0	345 6.800					14.250		MK-2	212.0	114.0	345 14.250				
7.000		MK-1	150.0	69.0	345 7.000					14.290	9/16	MK-2	212.0	114.0	345 14.290				
7.500		MK-1	150.0	69.0	345 7.500					14.300		MK-2	212.0	114.0	345 14.300				
8.000		MK-1	156.0	75.0	345 8.000	661 8.000				14.500		MK-2	212.0	114.0	345 14.500	661 14.500			
8.200		MK-1	156.0	75.0	345 8.200		661 8.500			14.750		MK-2	212.0	114.0	345 14.750				
8.500		MK-1	156.0	75.0	345 8.500		661 8.500			15.000		MK-2	212.0	114.0	345 15.000		661 15.000		
8.700		MK-1	162.0	81.0	345 8.700					15.080	19/32	MK-2	218.0	120.0	345 15.080				
9.000		MK-1	162.0	81.0	345 9.000	661 9.000				15.250		MK-2	218.0	120.0	345 15.250				
9.500		MK-1	162.0	81.0	345 9.500	661 9.500				15.500		MK-2	218.0	120.0	345 15.500	661 15.500			
9.520	3/8	MK-1	168.0	87.0	345 9.520					15.750		MK-2	218.0	120.0	345 15.750				
9.920	25/64	MK-1	168.0	87.0	345 9.920					15.870	5/8	MK-2	218.0	120.0	345 15.870				
10.000		MK-1	168.0	87.0	345 10.000	661 10.000				16.000		MK-2	218.0	120.0	345 16.000	661 16.000			
10.100		MK-1	168.0	87.0	345 10.100					16.100		MK-2	223.0	125.0	345 16.100				
10.150		MK-1	168.0	87.0	345 10.150					16.250		MK-2	223.0	125.0	345 16.250				
10.200		MK-1	168.0	87.0	345 10.200					16.500		MK-2	223.0	125.0	345 16.500	661 16.500			
10.250		MK-1	168.0	87.0	345 10.250					16.670	21/32	MK-2	223.0	125.0	345 16.670				
10.300		MK-1	168.0	87.0	345 10.300					16.750		MK-2	223.0	125.0	345 16.750				
10.320	13/32	MK-1	168.0	87.0	345 10.320					17.000		MK-2	223.0	125.0	345 17.000	661 17.000			
10.500		MK-1	168.0	87.0	345 10.500					17.070	43/64	MK-2	228.0	130.0	345 17.070	661 17.070			
10.700		MK-1	175.0	94.0	345 10.700					17.250		MK-2	228.0	130.0	345 17.250				
10.720	27/64	MK-1	175.0	94.0	345 10.720					17.460	11/16	MK-2	228.0	130.0	345 17.460	661 17.460			
10.750		MK-1	175.0	94.0	345 10.750					17.500		MK-2	228.0	130.0	345 17.500	661 17.500			
10.800		MK-1	175.0	94.0	345 10.800					17.750		MK-2	228.0	130.0	345 17.750				
11.000		MK-1	175.0	94.0	345 11.000	661 11.000				18.000		MK-2	228.0	130.0	345 18.000	661 18.000			
11.110	7/16	MK-1	175.0	94.0	345 11.110					18.200		MK-2	233.0	135.0	345 18.200				
11.200		MK-1	175.0	94.0	345 11.200					18.250		MK-2	233.0	135.0	345 18.250				
11.500		MK-1	175.0	94.0	345 11.500					18.260	23/32	MK-2	233.0	135.0	345 18.260				
11.750		MK-1	175.0	94.0	345 11.750					18.500		MK-2	233.0	135.0	345 18.500				
11.800		MK-1	175.0	94.0	345 11.800					18.650	47/64	MK-2	233.0	135.0	345 18.650				
11.900		MK-1	182.0	101.0	345 11.900					18.750		MK-2	233.0	135.0	345 18.750				
11.910		MK-1	182.0	101.0	345 11.910					19.000		MK-2	233.0	135.0	345 19.000	661 19.000			
12.000		MK-1	182.0	101.0	345 12.000	661 12.000				19.050	3/4	MK-2	238.0	140.0	345 19.050				
12.100		MK-1	182.0	101.0	345 12.100					19.250		MK-2	238.0	140.0	345 19.250				
12.200		MK-1	182.0	101.0	345 12.200					19.450	49/64	MK-2	238.0	140.0	345 19.450				
12.250		MK-1	182.0	101.0	345 12.250					19.500		MK-2	238.0	140.0	345 19.500	661 19.500			
12.500		MK-1	182.0	101.0	345 12.500	661 12.500				19.750		MK-2	238.0	140.0	345 19.750				
12.700	1/2	MK-1	182.0	101.0	345 12.700					19.840	25/32	MK-2	238.0	140.0	345 19.840				
12.750		MK-1	182.0	101.0	345 12.750					20.000		MK-2	238.0	140.0	345 20.000	661 20.000			
12.800		MK-1	182.0	101.0	345 12.800					20.250		MK-2	243.0	145.0	345 20.250				
13.000		MK-1	182.0	101.0	345 13.000	661 13.000				20.500		MK-2	243.0	145.0	345 20.500				
13.100	33/64	MK-1	182.0	101.0	345 13.100					20.640	13/16	MK-2	243.0	145.0	345 20.640				
13.200		MK-1	182.0	101.0	345 13.200					20.750		MK-2	243.0	145.0	345 20.750				
13.250		MK-1	189.0	108.0	345 13.250					21.000		MK-2	243.0	145.0	345 21.000	661 21.000			
13.490	17/32	MK-1	189.0	108.0	345 13.490					21.250		MK-2	248.0	150.0	345 21.250				
13.500		MK-1	189.0	108.0	345 13.500	661 13.500				21.500		MK-2	248.0	150.0	345 21.500				
13.600		MK-1	189.0	108.0	345 13.600					22.000		MK-2	248.0	150.0	345 22.000	661 22.000			
13.700		MK-1	189.0	108.0	345 13.700					22.220	7/8	MK-2	248.0	150.0	345 22.220				



HSS/HSCO drills with morse taper

HSS/HSCO drills

Article no.					345	661	Article no.					345	661
d1 mm	inch	S	l1 mm	l2 mm	Order no.		d1 mm	inch	S	l1 mm	l2 mm	Order no.	
22.250		MK-2	248.0	150.0	345	22.250	31.000		MK-3	301.0	180.0	345	31.000
22.500		MK-2	253.0	155.0	345	22.500	31.500		MK-3	301.0	180.0	345	31.500
23.000		MK-2	253.0	155.0	345	23.000	31.750	1 1/4	MK-3	306.0	185.0	345	31.750
23.020	29/32	MK-2	253.0	155.0	345	23.020	32.000		MK-4	334.0	185.0	345	32.000
23.500		MK-3	276.0	155.0	345	23.500	32.500		MK-4	334.0	185.0	345	32.500
23.810	15/16	MK-3	281.0	160.0		661 23.810	33.000		MK-4	334.0	185.0	345	33.000
24.000		MK-3	281.0	160.0	345	24.000	34.000		MK-4	339.0	190.0	345	34.000
24.210	61/64	MK-3	281.0	160.0	345	24.210	35.000		MK-4	339.0	190.0	345	35.000
24.500		MK-3	281.0	160.0	345	24.500	36.000		MK-4	344.0	195.0	345	36.000
25.000	63/64	MK-3	281.0	160.0	345	25.000	37.000		MK-4	344.0	195.0	345	37.000
25.250		MK-3	286.0	165.0	345	25.250	38.000		MK-4	349.0	200.0	345	38.000
25.400	1	MK-3	286.0	165.0	345	25.400	39.000		MK-4	349.0	200.0	345	39.000
25.500		MK-3	286.0	165.0	345	25.500	40.000		MK-4	349.0	200.0	345	40.000
26.000		MK-3	286.0	165.0	345	26.000	42.000		MK-4	354.0	205.0	345	42.000
26.500		MK-3	286.0	165.0	345	26.500	43.000		MK-4	359.0	210.0	345	43.000
27.000		MK-3	291.0	170.0	345	27.000	45.000		MK-4	359.0	210.0	345	45.000
27.500		MK-3	291.0	170.0	345	27.500	50.000		MK-4	369.0	220.0	345	50.000
28.000		MK-3	291.0	170.0	345	28.000							
28.500		MK-3	296.0	175.0	345	28.500							
28.570	1 1/8	MK-3	296.0	175.0	345	28.570							
29.000		MK-3	296.0	175.0	345	29.000							
29.500		MK-3	296.0	175.0	345	29.500							
30.000		MK-3	296.0	175.0	345	30.000							
30.500		MK-3	301.0	180.0	345	30.500							



Twist drills

Article no. 645



Cutting data page 452



P	M	K	N	S	H
•	•	•	•	○	○

Web thinning $\geq \varnothing 9.520$ • relieved cone • Co-alloyed high speed steel • wide flutes • increased wear resistance
 • especially for drilling depths over 3xD

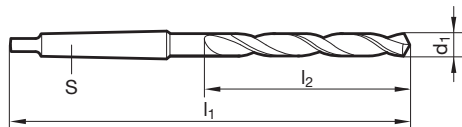

Article no. 645

d1 mm	inch	S	l1 mm	l2 mm	Order no.
10.000		MK-1	168.0	87.0	645 10.000
10.200		MK-1	168.0	87.0	645 10.200
10.500		MK-1	168.0	87.0	645 10.500
10.720	27/64	MK-1	175.0	94.0	645 10.720
10.800		MK-1	175.0	94.0	645 10.800
11.000		MK-1	175.0	94.0	645 11.000
11.500		MK-1	175.0	94.0	645 11.500
12.000		MK-1	182.0	101.0	645 12.000
12.200		MK-1	182.0	101.0	645 12.200
12.500		MK-1	182.0	101.0	645 12.500
13.000		MK-1	182.0	101.0	645 13.000
13.200		MK-1	182.0	101.0	645 13.200
13.500		MK-1	189.0	108.0	645 13.500
14.000		MK-1	189.0	108.0	645 14.000
14.250		MK-2	212.0	114.0	645 14.250
14.500		MK-2	212.0	114.0	645 14.500
15.000		MK-2	212.0	114.0	645 15.000
15.250		MK-2	218.0	120.0	645 15.250
15.500		MK-2	218.0	120.0	645 15.500
15.750		MK-2	218.0	120.0	645 15.750
16.000		MK-2	218.0	120.0	645 16.000
16.500		MK-2	223.0	125.0	645 16.500
17.000		MK-2	223.0	125.0	645 17.000
17.250		MK-2	228.0	130.0	645 17.250

Article no. 645

d1 mm	inch	S	l1 mm	l2 mm	Order no.
17.500		MK-2	228.0	130.0	645 17.500
18.000		MK-2	228.0	130.0	645 18.000
18.500		MK-2	233.0	135.0	645 18.500
19.000		MK-2	233.0	135.0	645 19.000
20.000		MK-2	238.0	140.0	645 20.000
20.500		MK-2	243.0	145.0	645 20.500
21.000		MK-2	243.0	145.0	645 21.000
22.000		MK-2	248.0	150.0	645 22.000
22.250		MK-2	248.0	150.0	645 22.250
22.620	57/64	MK-2	253.0	155.0	645 22.620
23.000		MK-2	253.0	155.0	645 23.000
24.000		MK-3	281.0	160.0	645 24.000
25.000	63/64	MK-3	281.0	160.0	645 25.000
26.000		MK-3	286.0	165.0	645 26.000
26.500		MK-3	286.0	165.0	645 26.500
30.000		MK-3	296.0	175.0	645 30.000
31.000		MK-3	301.0	180.0	645 31.000
33.000		MK-4	334.0	185.0	645 33.000
39.000		MK-4	349.0	200.0	645 39.000

HSS/HSCO drills



Twist drills

Article no. **1262**



Cutting data page 470



relieved cone • Co-alloyed high speed steel • increased wear resistance

P	M	K	N	S	H
○	●	○	○	○	○

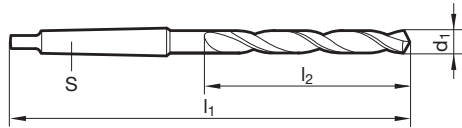

Article no. **1262**

d1 mm	inch	S	l1 mm	l2 mm	Order no.
10.000		MK-1	168.0	87.0	1262 10.000
10.200		MK-1	168.0	87.0	1262 10.200
10.500		MK-1	168.0	87.0	1262 10.500
10.800		MK-1	175.0	94.0	1262 10.800
11.000		MK-1	175.0	94.0	1262 11.000
11.500		MK-1	175.0	94.0	1262 11.500
11.800		MK-1	175.0	94.0	1262 11.800
12.000		MK-1	182.0	101.0	1262 12.000
12.500		MK-1	182.0	101.0	1262 12.500
13.000		MK-1	182.0	101.0	1262 13.000
13.500		MK-1	189.0	108.0	1262 13.500
13.800		MK-1	189.0	108.0	1262 13.800
14.000		MK-1	189.0	108.0	1262 14.000
14.250		MK-2	212.0	114.0	1262 14.250
14.500		MK-2	212.0	114.0	1262 14.500
14.750		MK-2	212.0	114.0	1262 14.750
15.000		MK-2	212.0	114.0	1262 15.000
15.250		MK-2	218.0	120.0	1262 15.250
15.500		MK-2	218.0	120.0	1262 15.500
15.750		MK-2	218.0	120.0	1262 15.750
16.000		MK-2	218.0	120.0	1262 16.000
16.250		MK-2	223.0	125.0	1262 16.250
16.500		MK-2	223.0	125.0	1262 16.500
16.750		MK-2	223.0	125.0	1262 16.750
17.000		MK-2	223.0	125.0	1262 17.000
17.500		MK-2	228.0	130.0	1262 17.500
18.000		MK-2	228.0	130.0	1262 18.000
18.250		MK-2	233.0	135.0	1262 18.250
18.500		MK-2	233.0	135.0	1262 18.500
18.750		MK-2	233.0	135.0	1262 18.750

Article no. **1262**

d1 mm	inch	S	l1 mm	l2 mm	Order no.
19.000		MK-2	233.0	135.0	1262 19.000
19.500		MK-2	238.0	140.0	1262 19.500
20.000		MK-2	238.0	140.0	1262 20.000
20.250		MK-2	243.0	145.0	1262 20.250
20.500		MK-2	243.0	145.0	1262 20.500
20.750		MK-2	243.0	145.0	1262 20.750
21.000		MK-2	243.0	145.0	1262 21.000
21.500		MK-2	248.0	150.0	1262 21.500
21.750		MK-2	248.0	150.0	1262 21.750
22.000		MK-2	248.0	150.0	1262 22.000
22.500		MK-2	253.0	155.0	1262 22.500
23.000		MK-2	253.0	155.0	1262 23.000
23.420	59/64	MK-3	276.0	155.0	1262 23.420
23.500		MK-3	276.0	155.0	1262 23.500
24.000		MK-3	281.0	160.0	1262 24.000
24.500		MK-3	281.0	160.0	1262 24.500
25.000	63/64	MK-3	281.0	160.0	1262 25.000
25.500		MK-3	286.0	165.0	1262 25.500
26.000		MK-3	286.0	165.0	1262 26.000
26.500		MK-3	286.0	165.0	1262 26.500
27.000		MK-3	291.0	170.0	1262 27.000
27.500		MK-3	291.0	170.0	1262 27.500
28.000		MK-3	291.0	170.0	1262 28.000
28.500		MK-3	296.0	175.0	1262 28.500
29.000		MK-3	296.0	175.0	1262 29.000
30.000		MK-3	296.0	175.0	1262 30.000
32.000		MK-4	334.0	185.0	1262 32.000



Bushing drills

Article no. **257**



Cutting data page 459

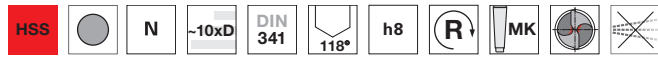

Web thinning $\geq \varnothing 14.100$ • relieved cone • for drilling through drill bushes

P	M	K	N	S	H
•		•	○		

HSS/HSCO drills

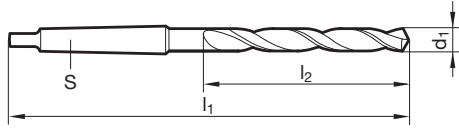

Article no. **257**

Article no. **257**

d1 mm	inch	S	l1 mm	l2 mm	Order no.	d1 mm	inch	S	l1 mm	l2 mm	Order no.
4.000		MK-1	145.0	64.0	257 4.000	12.800		MK-1	215.0	134.0	257 12.800
4.100		MK-1	145.0	64.0	257 4.100	13.000		MK-1	215.0	134.0	257 13.000
4.200		MK-1	145.0	64.0	257 4.200	13.100	33/64	MK-1	215.0	134.0	257 13.100
5.000		MK-1	155.0	74.0	257 5.000	13.200		MK-1	215.0	134.0	257 13.200
5.100		MK-1	155.0	74.0	257 5.100	13.500		MK-1	223.0	142.0	257 13.500
5.200		MK-1	155.0	74.0	257 5.200	13.750		MK-1	223.0	142.0	257 13.750
5.500		MK-1	161.0	80.0	257 5.500	13.800		MK-1	223.0	142.0	257 13.800
5.800		MK-1	161.0	80.0	257 5.800	13.900		MK-1	223.0	142.0	257 13.900
6.000		MK-1	161.0	80.0	257 6.000	14.000		MK-1	223.0	142.0	257 14.000
6.500		MK-1	167.0	86.0	257 6.500	14.100		MK-2	245.0	147.0	257 14.100
6.600		MK-1	167.0	86.0	257 6.600	14.200		MK-2	245.0	147.0	257 14.200
6.700		MK-1	167.0	86.0	257 6.700	14.250		MK-2	245.0	147.0	257 14.250
6.750	17/64	MK-1	174.0	93.0	257 6.750	14.290	9/16	MK-2	245.0	147.0	257 14.290
6.800		MK-1	174.0	93.0	257 6.800	14.300		MK-2	245.0	147.0	257 14.300
6.900		MK-1	174.0	93.0	257 6.900	14.400		MK-2	245.0	147.0	257 14.400
7.000		MK-1	174.0	93.0	257 7.000	14.500		MK-2	245.0	147.0	257 14.500
7.100		MK-1	174.0	93.0	257 7.100	14.750		MK-2	245.0	147.0	257 14.750
7.200		MK-1	174.0	93.0	257 7.200	14.900		MK-2	245.0	147.0	257 14.900
7.300		MK-1	174.0	93.0	257 7.300	15.000		MK-2	245.0	147.0	257 15.000
7.400		MK-1	174.0	93.0	257 7.400	15.200		MK-2	251.0	153.0	257 15.200
7.500		MK-1	174.0	93.0	257 7.500	15.250		MK-2	251.0	153.0	257 15.250
7.600		MK-1	181.0	100.0	257 7.600	15.500		MK-2	251.0	153.0	257 15.500
7.800		MK-1	181.0	100.0	257 7.800	15.600		MK-2	251.0	153.0	257 15.600
8.000		MK-1	181.0	100.0	257 8.000	15.750		MK-2	251.0	153.0	257 15.750
8.050		MK-1	181.0	100.0	257 8.050	16.000		MK-2	251.0	153.0	257 16.000
8.200		MK-1	181.0	100.0	257 8.200	16.100		MK-2	257.0	159.0	257 16.100
8.250		MK-1	181.0	100.0	257 8.250	16.200		MK-2	257.0	159.0	257 16.200
8.500		MK-1	181.0	100.0	257 8.500	16.250		MK-2	257.0	159.0	257 16.250
8.750		MK-1	188.0	107.0	257 8.750	16.500		MK-2	257.0	159.0	257 16.500
8.800		MK-1	188.0	107.0	257 8.800	16.670	21/32	MK-2	257.0	159.0	257 16.670
9.000		MK-1	188.0	107.0	257 9.000	16.750		MK-2	257.0	159.0	257 16.750
9.200		MK-1	188.0	107.0	257 9.200	17.000		MK-2	257.0	159.0	257 17.000
9.300		MK-1	188.0	107.0	257 9.300	17.250		MK-2	263.0	165.0	257 17.250
9.400		MK-1	188.0	107.0	257 9.400	17.460	11/16	MK-2	263.0	165.0	257 17.460
9.500		MK-1	188.0	107.0	257 9.500	17.500		MK-2	263.0	165.0	257 17.500
9.600		MK-1	197.0	116.0	257 9.600	17.750		MK-2	263.0	165.0	257 17.750
9.700		MK-1	197.0	116.0	257 9.700	18.000		MK-2	263.0	165.0	257 18.000
9.800		MK-1	197.0	116.0	257 9.800	18.250		MK-2	269.0	171.0	257 18.250
9.900		MK-1	197.0	116.0	257 9.900	18.500		MK-2	269.0	171.0	257 18.500
10.000		MK-1	197.0	116.0	257 10.000	18.750		MK-2	269.0	171.0	257 18.750
10.050		MK-1	197.0	116.0	257 10.050	19.000		MK-2	269.0	171.0	257 19.000
10.100		MK-1	197.0	116.0	257 10.100	19.250		MK-2	275.0	177.0	257 19.250
10.200		MK-1	197.0	116.0	257 10.200	19.500		MK-2	275.0	177.0	257 19.500
10.250		MK-1	197.0	116.0	257 10.250	19.750		MK-2	275.0	177.0	257 19.750
10.300		MK-1	197.0	116.0	257 10.300	19.840	25/32	MK-2	275.0	177.0	257 19.840
10.400		MK-1	197.0	116.0	257 10.400	20.000		MK-2	275.0	177.0	257 20.000
10.500		MK-1	197.0	116.0	257 10.500	20.250		MK-2	282.0	184.0	257 20.250
10.600		MK-1	197.0	116.0	257 10.600	20.500		MK-2	282.0	184.0	257 20.500
10.700		MK-1	206.0	125.0	257 10.700	20.640	13/16	MK-2	282.0	184.0	257 20.640
10.750		MK-1	206.0	125.0	257 10.750	21.000		MK-2	282.0	184.0	257 21.000
10.800		MK-1	206.0	125.0	257 10.800	21.500		MK-2	289.0	191.0	257 21.500
10.900		MK-1	206.0	125.0	257 10.900	21.750		MK-2	289.0	191.0	257 21.750
11.000		MK-1	206.0	125.0	257 11.000	21.830	55/64	MK-2	289.0	191.0	257 21.830
11.200		MK-1	206.0	125.0	257 11.200	22.000		MK-2	289.0	191.0	257 22.000
11.400		MK-1	206.0	125.0	257 11.400	22.220	7/8	MK-2	289.0	191.0	257 22.220
11.500		MK-1	206.0	125.0	257 11.500	22.250		MK-2	289.0	191.0	257 22.250
11.750		MK-1	206.0	125.0	257 11.750	22.500		MK-2	296.0	198.0	257 22.500
11.800		MK-1	206.0	125.0	257 11.800	23.000		MK-2	296.0	198.0	257 23.000
12.000		MK-1	215.0	134.0	257 12.000	23.500		MK-3	319.0	198.0	257 23.500
12.100		MK-1	215.0	134.0	257 12.100	23.750		MK-3	327.0	206.0	257 23.750
12.200		MK-1	215.0	134.0	257 12.200	23.810	15/16	MK-3	327.0	206.0	257 23.810
12.250		MK-1	215.0	134.0	257 12.250	24.000		MK-3	327.0	206.0	257 24.000
12.300	31/64	MK-1	215.0	134.0	257 12.300	24.250		MK-3	327.0	206.0	257 24.250
12.400		MK-1	215.0	134.0	257 12.400	24.500		MK-3	327.0	206.0	257 24.500
12.500		MK-1	215.0	134.0	257 12.500	25.000	63/64	MK-3	327.0	206.0	257 25.000
12.600		MK-1	215.0	134.0	257 12.600	25.250		MK-3	335.0	214.0	257 25.250



HSS/HSCO drills with morse taper

HSS/HSCO drills

Article no.					257	Article no.					257
d1 mm	inch	S	l1 mm	l2 mm	Order no.	d1 mm	inch	S	l1 mm	l2 mm	Order no.
25.500		MK-3	335.0	214.0	257 25.500	35.000		MK-4	406.0	257.0	257 35.000
26.000		MK-3	335.0	214.0	257 26.000	36.000		MK-4	416.0	267.0	257 36.000
26.500		MK-3	335.0	214.0	257 26.500	36.120	1 27/64	MK-4	416.0	267.0	257 36.120
26.590	1 3/64	MK-3	343.0	222.0	257 26.590	36.910	1 29/64	MK-4	416.0	267.0	257 36.910
26.990	1 1/16	MK-3	343.0	222.0	257 26.990	37.000		MK-4	416.0	267.0	257 37.000
27.000		MK-3	343.0	222.0	257 27.000	37.500		MK-4	416.0	267.0	257 37.500
27.380	1 5/64	MK-3	343.0	222.0	257 27.380	38.000		MK-4	426.0	277.0	257 38.000
27.500		MK-3	343.0	222.0	257 27.500	39.000		MK-4	426.0	277.0	257 39.000
28.000		MK-3	343.0	222.0	257 28.000	39.500		MK-4	426.0	277.0	257 39.500
28.500		MK-3	351.0	230.0	257 28.500	40.000		MK-4	426.0	277.0	257 40.000
29.000		MK-3	351.0	230.0	257 29.000	41.000		MK-4	436.0	287.0	257 41.000
29.500		MK-3	351.0	230.0	257 29.500	42.000		MK-4	436.0	287.0	257 42.000
30.000		MK-3	351.0	230.0	257 30.000	43.000		MK-4	447.0	298.0	257 43.000
30.500		MK-3	360.0	239.0	257 30.500	44.000		MK-4	447.0	298.0	257 44.000
31.000		MK-3	360.0	239.0	257 31.000	45.000		MK-4	447.0	298.0	257 45.000
32.000		MK-4	397.0	248.0	257 32.000	48.000		MK-4	470.0	321.0	257 48.000
33.000		MK-4	397.0	248.0	257 33.000	49.000		MK-4	470.0	321.0	257 49.000
34.000		MK-4	406.0	257.0	257 34.000	50.000		MK-4	470.0	321.0	257 50.000



Bushing drills

Article no. 551



Cutting data page 462



Web thinning $\geq \varnothing 5.500$ • relieved cone • wide flutes • in case of poor chip evacuation

P	M	K	N	S	H
•		•	•		

HSS/HSCO drills

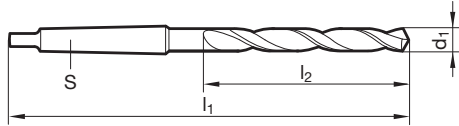

Article no. 551

Article no. 551

d1 mm	inch	S	l1 mm	l2 mm	Order no.	d1 mm	inch	S	l1 mm	l2 mm	Order no.
5.500		MK-1	161.0	80.0	551 5.500	13.500		MK-1	223.0	142.0	551 13.500
5.550		MK-1	161.0	80.0	551 5.550	13.800		MK-1	223.0	142.0	551 13.800
6.350	1/4	MK-1	167.0	86.0	551 6.350	13.890	35/64	MK-1	223.0	142.0	551 13.890
6.500		MK-1	167.0	86.0	551 6.500	14.000		MK-1	223.0	142.0	551 14.000
6.750	17/64	MK-1	174.0	93.0	551 6.750	14.200		MK-2	245.0	147.0	551 14.200
6.800		MK-1	174.0	93.0	551 6.800	14.250		MK-2	245.0	147.0	551 14.250
7.000		MK-1	174.0	93.0	551 7.000	14.290	9/16	MK-2	245.0	147.0	551 14.290
7.500		MK-1	174.0	93.0	551 7.500	14.500		MK-2	245.0	147.0	551 14.500
7.940	5/16	MK-1	181.0	100.0	551 7.940	14.680		MK-2	245.0	147.0	551 14.680
8.000		MK-1	181.0	100.0	551 8.000	14.750		MK-2	245.0	147.0	551 14.750
8.100		MK-1	181.0	100.0	551 8.100	15.000		MK-2	245.0	147.0	551 15.000
8.200		MK-1	181.0	100.0	551 8.200	15.250		MK-2	251.0	153.0	551 15.250
8.330	21/64	MK-1	181.0	100.0	551 8.330	15.480	39/64	MK-2	251.0	153.0	551 15.480
8.500		MK-1	181.0	100.0	551 8.500	15.500		MK-2	251.0	153.0	551 15.500
8.600		MK-1	188.0	107.0	551 8.600	15.750		MK-2	251.0	153.0	551 15.750
8.700		MK-1	188.0	107.0	551 8.700	16.000		MK-2	251.0	153.0	551 16.000
8.750		MK-1	188.0	107.0	551 8.750	16.500		MK-2	257.0	159.0	551 16.500
9.000		MK-1	188.0	107.0	551 9.000	16.670	21/32	MK-2	257.0	159.0	551 16.670
9.500		MK-1	188.0	107.0	551 9.500	16.800		MK-2	257.0	159.0	551 16.800
9.520	3/8	MK-1	197.0	116.0	551 9.520	17.000		MK-2	257.0	159.0	551 17.000
9.800		MK-1	197.0	116.0	551 9.800	17.460	11/16	MK-2	263.0	165.0	551 17.460
9.900		MK-1	197.0	116.0	551 9.900	17.500		MK-2	263.0	165.0	551 17.500
9.920	25/64	MK-1	197.0	116.0	551 9.920	18.000		MK-2	263.0	165.0	551 18.000
10.000		MK-1	197.0	116.0	551 10.000	18.260	23/32	MK-2	269.0	171.0	551 18.260
10.200		MK-1	197.0	116.0	551 10.200	19.000		MK-2	269.0	171.0	551 19.000
10.250		MK-1	197.0	116.0	551 10.250	19.500		MK-2	275.0	177.0	551 19.500
10.320	13/32	MK-1	197.0	116.0	551 10.320	19.840	25/32	MK-2	275.0	177.0	551 19.840
10.500		MK-1	197.0	116.0	551 10.500	20.000		MK-2	275.0	177.0	551 20.000
11.000		MK-1	206.0	125.0	551 11.000	21.000		MK-2	282.0	184.0	551 21.000
11.110	7/16	MK-1	206.0	125.0	551 11.110	22.000		MK-2	289.0	191.0	551 22.000
11.500		MK-1	206.0	125.0	551 11.500	23.000		MK-2	296.0	198.0	551 23.000
11.750		MK-1	206.0	125.0	551 11.750	23.500		MK-3	319.0	198.0	551 23.500
11.800		MK-1	206.0	125.0	551 11.800	24.000		MK-3	327.0	206.0	551 24.000
11.910		MK-1	215.0	134.0	551 11.910	25.000	63/64	MK-3	327.0	206.0	551 25.000
12.000		MK-1	215.0	134.0	551 12.000	26.000		MK-3	335.0	214.0	551 26.000
12.300	31/64	MK-1	215.0	134.0	551 12.300	28.570	1 1/8	MK-3	351.0	230.0	551 28.570
12.500		MK-1	215.0	134.0	551 12.500	29.000		MK-3	351.0	230.0	551 29.000
12.700	1/2	MK-1	215.0	134.0	551 12.700	30.000		MK-3	351.0	230.0	551 30.000
12.800		MK-1	215.0	134.0	551 12.800	30.560	1 13/64	MK-3	360.0	239.0	551 30.560
13.000		MK-1	215.0	134.0	551 13.000	31.500		MK-3	360.0	239.0	551 31.500
13.100	33/64	MK-1	215.0	134.0	551 13.100	32.000		MK-4	397.0	248.0	551 32.000
13.490	17/32	MK-1	223.0	142.0	551 13.490						



Bushing drills

Article no. **357**



Cutting data page 459

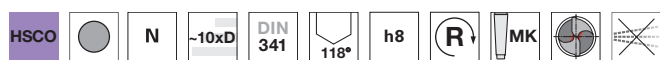

Web thinning $\geq \varnothing 4.750$ • relieved cone • Co-alloyed high speed steel • increased wear resistance • for drilling through drill bushes

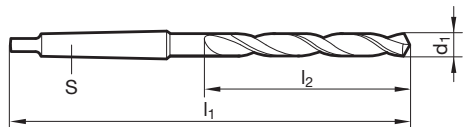

Article no. **357**

d1 mm	inch	S	l1 mm	l2 mm	Order no.
4.750		MK-1	150.0	69.0	357 4.750
5.000		MK-1	155.0	74.0	357 5.000
5.400		MK-1	161.0	80.0	357 5.400
6.000		MK-1	161.0	80.0	357 6.000
6.800		MK-1	174.0	93.0	357 6.800
7.000		MK-1	174.0	93.0	357 7.000
8.000		MK-1	181.0	100.0	357 8.000
8.200		MK-1	181.0	100.0	357 8.200
8.500		MK-1	181.0	100.0	357 8.500
8.800		MK-1	188.0	107.0	357 8.800
9.000		MK-1	188.0	107.0	357 9.000
9.500		MK-1	188.0	107.0	357 9.500
9.800		MK-1	197.0	116.0	357 9.800
10.000		MK-1	197.0	116.0	357 10.000
10.200		MK-1	197.0	116.0	357 10.200
10.250		MK-1	197.0	116.0	357 10.250
10.500		MK-1	197.0	116.0	357 10.500
11.000		MK-1	206.0	125.0	357 11.000
11.500		MK-1	206.0	125.0	357 11.500
11.750		MK-1	206.0	125.0	357 11.750
12.000		MK-1	215.0	134.0	357 12.000
12.250		MK-1	215.0	134.0	357 12.250
12.500		MK-1	215.0	134.0	357 12.500
13.000		MK-1	215.0	134.0	357 13.000

Article no. **357**

d1 mm	inch	S	l1 mm	l2 mm	Order no.
13.500		MK-1	223.0	142.0	357 13.500
14.000		MK-1	223.0	142.0	357 14.000
14.500		MK-2	245.0	147.0	357 14.500
14.750		MK-2	245.0	147.0	357 14.750
15.000		MK-2	245.0	147.0	357 15.000
16.000		MK-2	251.0	153.0	357 16.000
16.500		MK-2	257.0	159.0	357 16.500
17.000		MK-2	257.0	159.0	357 17.000
17.500		MK-2	263.0	165.0	357 17.500
18.000		MK-2	263.0	165.0	357 18.000
19.000		MK-2	269.0	171.0	357 19.000
20.000		MK-2	275.0	177.0	357 20.000
21.000		MK-2	282.0	184.0	357 21.000
22.000		MK-2	289.0	191.0	357 22.000
23.000		MK-2	296.0	198.0	357 23.000
24.000		MK-3	327.0	206.0	357 24.000
25.000	63/64	MK-3	327.0	206.0	357 25.000
26.000		MK-3	335.0	214.0	357 26.000
26.500		MK-3	335.0	214.0	357 26.500
27.000		MK-3	343.0	222.0	357 27.000
28.000		MK-3	343.0	222.0	357 28.000
30.000		MK-3	351.0	230.0	357 30.000
33.000		MK-4	397.0	248.0	357 33.000
40.000		MK-4	426.0	277.0	357 40.000



Bushing drills

Article no. **623**



Cutting data page 462

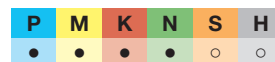

Web thinning $\geq \varnothing 10.000$ • relieved cone • Co-alloyed high speed steel • wide flutes • increased wear resistance • in case of poor chip evacuation

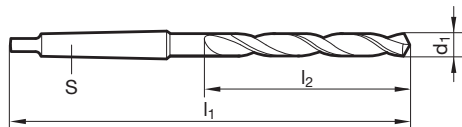

Article no. **623**

d1 mm	inch	S	l1 mm	l2 mm	Order no.
10.000		MK-1	197.0	116.0	623 10.000
10.200		MK-1	197.0	116.0	623 10.200
10.320	13/32	MK-1	197.0	116.0	623 10.320
10.500		MK-1	197.0	116.0	623 10.500
10.800		MK-1	206.0	125.0	623 10.800
11.000		MK-1	206.0	125.0	623 11.000
11.200		MK-1	206.0	125.0	623 11.200
11.500		MK-1	206.0	125.0	623 11.500
11.800		MK-1	206.0	125.0	623 11.800
12.000		MK-1	215.0	134.0	623 12.000
12.200		MK-1	215.0	134.0	623 12.200
12.400		MK-1	215.0	134.0	623 12.400
12.500		MK-1	215.0	134.0	623 12.500
12.800		MK-1	215.0	134.0	623 12.800
13.000		MK-1	215.0	134.0	623 13.000
13.490	17/32	MK-1	223.0	142.0	623 13.490
13.500		MK-1	223.0	142.0	623 13.500
13.890	35/64	MK-1	223.0	142.0	623 13.890
14.000		MK-1	223.0	142.0	623 14.000
14.200		MK-2	245.0	147.0	623 14.200
14.290	9/16	MK-2	245.0	147.0	623 14.290
14.500		MK-2	245.0	147.0	623 14.500
14.680	37/64	MK-2	245.0	147.0	623 14.680
15.000		MK-2	245.0	147.0	623 15.000

Article no. **623**

d1 mm	inch	S	l1 mm	l2 mm	Order no.
15.500		MK-2	251.0	153.0	623 15.500
15.800		MK-2	251.0	153.0	623 15.800
16.000		MK-2	251.0	153.0	623 16.000
16.500		MK-2	257.0	159.0	623 16.500
17.000		MK-2	257.0	159.0	623 17.000
17.500		MK-2	263.0	165.0	623 17.500
18.000		MK-2	263.0	165.0	623 18.000
18.500		MK-2	269.0	171.0	623 18.500
19.000		MK-2	269.0	171.0	623 19.000
19.500		MK-2	275.0	177.0	623 19.500
20.000		MK-2	275.0	177.0	623 20.000
20.500		MK-2	282.0	184.0	623 20.500
21.000		MK-2	282.0	184.0	623 21.000
22.000		MK-2	289.0	191.0	623 22.000
22.500		MK-2	296.0	198.0	623 22.500
24.000		MK-3	327.0	206.0	623 24.000
25.000	63/64	MK-3	327.0	206.0	623 25.000
26.000		MK-3	335.0	214.0	623 26.000



Extra length twist drills, series 1

Article no. **266**



Cutting data page 466

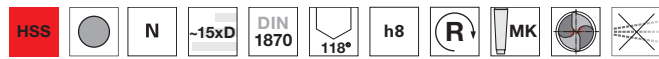

Web thinning $\geq \varnothing 7.800$ • relieved cone • for extremely deep holes

P	M	K	N	S	H
•		•	○		

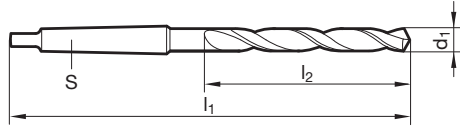

Article no. **266**

Article no. **266**

d1 mm	inch	S	l1 mm	l2 mm	Order no.
8.000		MK-1	265.0	165.0	266 8.000
8.500		MK-1	265.0	165.0	266 8.500
8.800		MK-1	275.0	175.0	266 8.800
9.000		MK-1	275.0	175.0	266 9.000
9.500		MK-1	275.0	175.0	266 9.500
10.000		MK-1	285.0	185.0	266 10.000
10.200		MK-1	285.0	185.0	266 10.200
10.250		MK-1	285.0	185.0	266 10.250
10.320	13/32	MK-1	285.0	185.0	266 10.320
10.500		MK-1	285.0	185.0	266 10.500
11.000		MK-1	300.0	195.0	266 11.000
11.400		MK-1	300.0	195.0	266 11.400
11.500		MK-1	300.0	195.0	266 11.500
11.750		MK-1	300.0	195.0	266 11.750
11.800		MK-1	300.0	195.0	266 11.800
12.000		MK-1	310.0	205.0	266 12.000
12.200		MK-1	310.0	205.0	266 12.200
12.500		MK-1	310.0	205.0	266 12.500
12.700	1/2	MK-1	310.0	205.0	266 12.700
13.000		MK-1	310.0	205.0	266 13.000
13.500		MK-1	325.0	220.0	266 13.500
13.750		MK-1	325.0	220.0	266 13.750
14.000		MK-1	325.0	220.0	266 14.000
14.290	9/16	MK-2	340.0	220.0	266 14.290
14.500		MK-2	340.0	220.0	266 14.500
15.000		MK-2	340.0	220.0	266 15.000
15.250		MK-2	355.0	230.0	266 15.250
15.500		MK-2	355.0	230.0	266 15.500
15.750		MK-2	355.0	230.0	266 15.750
15.800		MK-2	355.0	230.0	266 15.800
16.000		MK-2	355.0	230.0	266 16.000
16.250		MK-2	355.0	230.0	266 16.250
16.500		MK-2	355.0	230.0	266 16.500
16.670	21/32	MK-2	355.0	230.0	266 16.670
17.000		MK-2	355.0	230.0	266 17.000
17.500		MK-2	370.0	245.0	266 17.500
17.750		MK-2	370.0	245.0	266 17.750
18.000		MK-2	370.0	245.0	266 18.000
18.500		MK-2	370.0	245.0	266 18.500
18.650	47/64	MK-2	370.0	245.0	266 18.650
19.000		MK-2	370.0	245.0	266 19.000
19.500		MK-2	385.0	260.0	266 19.500

d1 mm	inch	S	l1 mm	l2 mm	Order no.
19.750		MK-2	385.0	260.0	266 19.750
20.000		MK-2	385.0	260.0	266 20.000
20.500		MK-2	385.0	260.0	266 20.500
20.640	13/16	MK-2	385.0	260.0	266 20.640
21.000		MK-2	385.0	260.0	266 21.000
21.500		MK-2	405.0	270.0	266 21.500
22.000		MK-2	405.0	270.0	266 22.000
22.500		MK-2	405.0	270.0	266 22.500
23.000		MK-2	405.0	270.0	266 23.000
23.020	29/32	MK-2	405.0	270.0	266 23.020
23.500		MK-3	425.0	270.0	266 23.500
24.000		MK-3	440.0	290.0	266 24.000
24.500		MK-3	440.0	290.0	266 24.500
25.000	63/64	MK-3	440.0	290.0	266 25.000
26.000		MK-3	440.0	290.0	266 26.000
26.500		MK-3	440.0	290.0	266 26.500
27.000		MK-3	460.0	305.0	266 27.000
28.000		MK-3	460.0	305.0	266 28.000
29.000		MK-3	460.0	305.0	266 29.000
30.000		MK-3	460.0	305.0	266 30.000
30.500		MK-3	480.0	320.0	266 30.500
31.000		MK-3	480.0	320.0	266 31.000
32.000		MK-4	505.0	320.0	266 32.000
33.000		MK-4	505.0	320.0	266 33.000
34.000		MK-4	530.0	340.0	266 34.000
35.000		MK-4	530.0	340.0	266 35.000
36.000		MK-4	530.0	340.0	266 36.000
38.000		MK-4	555.0	360.0	266 38.000
39.000		MK-4	555.0	360.0	266 39.000
40.000		MK-4	555.0	360.0	266 40.000
42.000		MK-4	555.0	360.0	266 42.000
45.000		MK-4	585.0	385.0	266 45.000
48.000		MK-4	605.0	405.0	266 48.000
50.000		MK-4	605.0	405.0	266 50.000



Extra length twist drills, series 1

Article no. 526



Cutting data page 468



Web thinning ≥ Ø 5.800 • relieved cone • wide flutes • for extremely deep holes • in case of poor chip evacuation

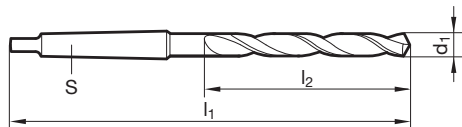

Article no. 526

Article no. 526

d1 mm	inch	S	l1 mm	l2 mm	Order no.	d1 mm	inch	S	l1 mm	l2 mm	Order no.
8.000		MK-1	265.0	165.0	526 8.000	17.000		MK-2	355.0	230.0	526 17.000
8.500		MK-1	265.0	165.0	526 8.500	17.460	11/16	MK-2	370.0	245.0	526 17.460
8.700		MK-1	275.0	175.0	526 8.700	17.500		MK-2	370.0	245.0	526 17.500
9.000		MK-1	275.0	175.0	526 9.000	18.000		MK-2	370.0	245.0	526 18.000
9.500		MK-1	275.0	175.0	526 9.500	18.500		MK-2	370.0	245.0	526 18.500
9.520	3/8	MK-1	285.0	185.0	526 9.520	19.000		MK-2	370.0	245.0	526 19.000
9.800		MK-1	285.0	185.0	526 9.800	19.500		MK-2	385.0	260.0	526 19.500
10.000		MK-1	285.0	185.0	526 10.000	20.000		MK-2	385.0	260.0	526 20.000
10.200		MK-1	285.0	185.0	526 10.200	20.500		MK-2	385.0	260.0	526 20.500
10.500		MK-1	285.0	185.0	526 10.500	21.000		MK-2	385.0	260.0	526 21.000
10.720	27/64	MK-1	300.0	195.0	526 10.720	21.500		MK-2	405.0	270.0	526 21.500
11.000		MK-1	300.0	195.0	526 11.000	22.000		MK-2	405.0	270.0	526 22.000
11.110	7/16	MK-1	300.0	195.0	526 11.110	23.000		MK-2	405.0	270.0	526 23.000
11.500		MK-1	300.0	195.0	526 11.500	24.000		MK-3	440.0	290.0	526 24.000
11.750		MK-1	300.0	195.0	526 11.750	25.000	63/64	MK-3	440.0	290.0	526 25.000
12.000		MK-1	310.0	205.0	526 12.000	26.000		MK-3	440.0	290.0	526 26.000
12.500		MK-1	310.0	205.0	526 12.500	26.500		MK-3	440.0	290.0	526 26.500
12.700	1/2	MK-1	310.0	205.0	526 12.700	28.000		MK-3	460.0	305.0	526 28.000
13.000		MK-1	310.0	205.0	526 13.000	29.000		MK-3	460.0	305.0	526 29.000
13.490	17/32	MK-1	325.0	220.0	526 13.490	30.000		MK-3	460.0	305.0	526 30.000
13.500		MK-1	325.0	220.0	526 13.500	30.160	1 3/16	MK-3	480.0	320.0	526 30.160
14.000		MK-1	325.0	220.0	526 14.000						
14.200		MK-2	340.0	220.0	526 14.200						
14.290	9/16	MK-2	340.0	220.0	526 14.290						
14.500		MK-2	340.0	220.0	526 14.500						
15.000		MK-2	340.0	220.0	526 15.000						
15.500		MK-2	355.0	230.0	526 15.500						
15.870	5/8	MK-2	355.0	230.0	526 15.870						
16.000		MK-2	355.0	230.0	526 16.000						
16.500		MK-2	355.0	230.0	526 16.500						

HSS/HSCO drills



Extra length twist drills, series 1

Article no. **620**



Cutting data page 468



P	M	K	N	S	H
●	●	●	●	○	○

Web thinning $\geq \varnothing 9.520$ • relieved cone • Co-alloyed high speed steel • wide flutes • increased wear resistance • for extremely deep holes • in case of poor chip evacuation

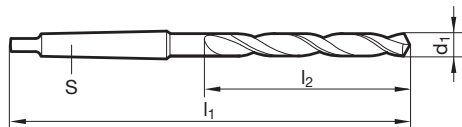

Article no. **620**

Article no. **620**

d1 mm	inch	S	l1 mm	l2 mm	Order no.	d1 mm	inch	S	l1 mm	l2 mm	Order no.
9.520	3/8	MK-1	285.0	185.0	620 9.520	15.080	19/32	MK-2	355.0	230.0	620 15.080
10.000		MK-1	285.0	185.0	620 10.000	15.500		MK-2	355.0	230.0	620 15.500
10.200		MK-1	285.0	185.0	620 10.200	16.000		MK-2	355.0	230.0	620 16.000
10.320	13/32	MK-1	285.0	185.0	620 10.320	16.500		MK-2	355.0	230.0	620 16.500
10.500		MK-1	285.0	185.0	620 10.500	17.000		MK-2	355.0	230.0	620 17.000
11.000		MK-1	300.0	195.0	620 11.000	17.500		MK-2	370.0	245.0	620 17.500
11.110	7/16	MK-1	300.0	195.0	620 11.110	18.000		MK-2	370.0	245.0	620 18.000
11.500		MK-1	300.0	195.0	620 11.500	18.500		MK-2	370.0	245.0	620 18.500
12.000		MK-1	310.0	205.0	620 12.000	19.000		MK-2	370.0	245.0	620 19.000
12.300	31/64	MK-1	310.0	205.0	620 12.300	20.000		MK-2	385.0	260.0	620 20.000
12.500		MK-1	310.0	205.0	620 12.500	21.000		MK-2	385.0	260.0	620 21.000
12.700	1/2	MK-1	310.0	205.0	620 12.700	22.000		MK-2	405.0	270.0	620 22.000
13.000		MK-1	310.0	205.0	620 13.000	23.000		MK-2	405.0	270.0	620 23.000
13.500		MK-1	325.0	220.0	620 13.500	25.500		MK-3	440.0	290.0	620 25.500
14.000		MK-1	325.0	220.0	620 14.000	26.000		MK-3	440.0	290.0	620 26.000
14.290	9/16	MK-2	340.0	220.0	620 14.290	29.370	1 5/32	MK-3	460.0	305.0	620 29.370
14.500		MK-2	340.0	220.0	620 14.500	30.000		MK-3	460.0	305.0	620 30.000
15.000		MK-2	340.0	220.0	620 15.000						



Extra length twist drills, series 2

Article no. 267



Cutting data page 466

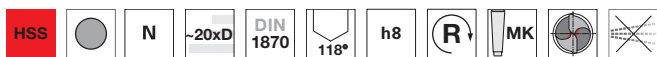

Web thinning $\geq \varnothing 7.700$ • relieved cone • for extremely deep holes

HSS/HSCO drills

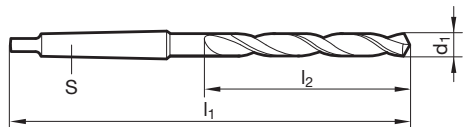

Article no. **267**

d1 mm	inch	S	l1 mm	l2 mm	Order no.
8.000		MK-1	330.0	210.0	267 8.000
8.500		MK-1	330.0	210.0	267 8.500
9.000		MK-1	345.0	220.0	267 9.000
10.000		MK-1	360.0	235.0	267 10.000
10.200		MK-1	360.0	235.0	267 10.200
10.500		MK-1	360.0	235.0	267 10.500
11.000		MK-1	375.0	250.0	267 11.000
11.500		MK-1	375.0	250.0	267 11.500
11.750		MK-1	375.0	250.0	267 11.750
11.800		MK-1	375.0	250.0	267 11.800
12.000		MK-1	395.0	260.0	267 12.000
13.000		MK-1	395.0	260.0	267 13.000
13.500		MK-1	410.0	275.0	267 13.500
14.000		MK-1	410.0	275.0	267 14.000
14.500		MK-2	425.0	275.0	267 14.500
15.000		MK-2	425.0	275.0	267 15.000
15.480	39/64	MK-2	445.0	295.0	267 15.480
15.500		MK-2	445.0	295.0	267 15.500
16.000		MK-2	445.0	295.0	267 16.000
16.500		MK-2	445.0	295.0	267 16.500
17.000		MK-2	445.0	295.0	267 17.000
17.070	43/64	MK-2	465.0	310.0	267 17.070
17.500		MK-2	465.0	310.0	267 17.500
18.000		MK-2	465.0	310.0	267 18.000
18.500		MK-2	465.0	310.0	267 18.500
19.000		MK-2	465.0	310.0	267 19.000
19.500		MK-2	490.0	325.0	267 19.500
20.000		MK-2	490.0	325.0	267 20.000
20.640	13/16	MK-2	490.0	325.0	267 20.640
21.000		MK-2	490.0	325.0	267 21.000

Article no. **267**

d1 mm	inch	S	l1 mm	l2 mm	Order no.
21.430	27/32	MK-2	515.0	345.0	267 21.430
21.500		MK-2	515.0	345.0	267 21.500
21.830	55/64	MK-2	515.0	345.0	267 21.830
22.000		MK-2	515.0	345.0	267 22.000
22.800		MK-2	515.0	345.0	267 22.800
23.000		MK-2	515.0	345.0	267 23.000
23.020	29/32	MK-2	515.0	345.0	267 23.020
23.750		MK-3	555.0	365.0	267 23.750
23.810	15/16	MK-3	555.0	365.0	267 23.810
24.000		MK-3	555.0	365.0	267 24.000
24.500		MK-3	555.0	365.0	267 24.500
25.000	63/64	MK-3	555.0	365.0	267 25.000
26.000		MK-3	555.0	365.0	267 26.000
28.000		MK-3	580.0	385.0	267 28.000
29.500		MK-3	580.0	385.0	267 29.500
30.000		MK-3	580.0	385.0	267 30.000
31.000		MK-3	610.0	410.0	267 31.000
32.000		MK-4	635.0	410.0	267 32.000
34.000		MK-4	665.0	430.0	267 34.000
40.000		MK-4	695.0	460.0	267 40.000
45.000		MK-4	735.0	490.0	267 45.000



Extra length twist drills, series 2

Article no. **527**



Cutting data page 468



Web thinning $\geq \varnothing 7.800$ • relieved cone • wide flutes • in case of poor chip evacuation • for extremely deep holes

P	M	K	N	S	H
•		•	•		

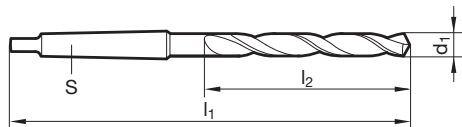

Article no. **527**

d1 mm	inch	S	l1 mm	l2 mm	Order no.
8.000		MK-1	330.0	210.0	527 8.000
8.500		MK-1	330.0	210.0	527 8.500
9.000		MK-1	345.0	220.0	527 9.000
9.500		MK-1	345.0	220.0	527 9.500
10.000		MK-1	360.0	235.0	527 10.000
10.500		MK-1	360.0	235.0	527 10.500
11.000		MK-1	375.0	250.0	527 11.000
11.110	7/16	MK-1	375.0	250.0	527 11.110
11.500		MK-1	375.0	250.0	527 11.500
11.510	29/64	MK-1	375.0	250.0	527 11.510
11.800		MK-1	375.0	250.0	527 11.800
11.910	15/32	MK-1	395.0	260.0	527 11.910
12.000		MK-1	395.0	260.0	527 12.000
12.500		MK-1	395.0	260.0	527 12.500
12.700	1/2	MK-1	395.0	260.0	527 12.700
13.000		MK-1	395.0	260.0	527 13.000
13.500		MK-1	410.0	275.0	527 13.500
13.700		MK-1	410.0	275.0	527 13.700
13.800		MK-1	410.0	275.0	527 13.800
13.890	35/64	MK-1	410.0	275.0	527 13.890
14.000		MK-1	410.0	275.0	527 14.000
14.290	9/16	MK-2	425.0	275.0	527 14.290
14.500		MK-2	425.0	275.0	527 14.500
15.000		MK-2	425.0	275.0	527 15.000
15.500		MK-2	445.0	295.0	527 15.500
16.000		MK-2	445.0	295.0	527 16.000
16.500		MK-2	445.0	295.0	527 16.500
17.000		MK-2	445.0	295.0	527 17.000
17.070	43/64	MK-2	465.0	310.0	527 17.070
17.500		MK-2	465.0	310.0	527 17.500

Article no. **527**

d1 mm	inch	S	l1 mm	l2 mm	Order no.
18.000		MK-2	465.0	310.0	527 18.000
18.500		MK-2	465.0	310.0	527 18.500
19.000		MK-2	465.0	310.0	527 19.000
19.450	49/64	MK-2	490.0	325.0	527 19.450
19.500		MK-2	490.0	325.0	527 19.500
20.000		MK-2	490.0	325.0	527 20.000
20.500		MK-2	490.0	325.0	527 20.500
21.000		MK-2	490.0	325.0	527 21.000
21.030	53/64	MK-2	490.0	325.0	527 21.030
21.430	27/32	MK-2	515.0	345.0	527 21.430
22.000		MK-2	515.0	345.0	527 22.000
23.000		MK-2	515.0	345.0	527 23.000
24.000		MK-3	555.0	365.0	527 24.000
25.000	63/64	MK-3	555.0	365.0	527 25.000
26.000		MK-3	555.0	365.0	527 26.000
26.500		MK-3	555.0	365.0	527 26.500
27.000		MK-3	580.0	385.0	527 27.000
28.000		MK-3	580.0	385.0	527 28.000
29.000		MK-3	580.0	385.0	527 29.000
29.500		MK-3	580.0	385.0	527 29.500
30.000		MK-3	580.0	385.0	527 30.000



Extra length twist drills, series 2

Article no. **621**



Cutting data page 468



Web thinning $\geq \varnothing 9.520$ • relieved cone • Co-alloyed high speed steel • wide flutes • increased wear resistance • in case of poor chip evacuation • for extremely deep holes

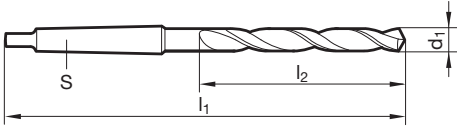

Article no. **621**

Article no. **621**

d1 mm	inch	S	l1 mm	l2 mm	Order no.
9.520	3/8	MK-1	360.0	235.0	621 9.520
10.000		MK-1	360.0	235.0	621 10.000
10.500		MK-1	360.0	235.0	621 10.500
11.000		MK-1	375.0	250.0	621 11.000
11.500		MK-1	375.0	250.0	621 11.500
11.510	29/64	MK-1	375.0	250.0	621 11.510
12.000		MK-1	395.0	260.0	621 12.000
12.500		MK-1	395.0	260.0	621 12.500
12.700	1/2	MK-1	395.0	260.0	621 12.700
13.000		MK-1	395.0	260.0	621 13.000
13.500		MK-1	410.0	275.0	621 13.500
14.000		MK-1	410.0	275.0	621 14.000

d1 mm	inch	S	l1 mm	l2 mm	Order no.
14.500		MK-2	425.0	275.0	621 14.500
15.000		MK-2	425.0	275.0	621 15.000
16.000		MK-2	445.0	295.0	621 16.000
18.000		MK-2	465.0	310.0	621 18.000
18.500		MK-2	465.0	310.0	621 18.500
19.000		MK-2	465.0	310.0	621 19.000
20.000		MK-2	490.0	325.0	621 20.000
21.430	27/32	MK-2	515.0	345.0	621 21.430
23.420	59/64	MK-3	535.0	345.0	621 23.420



Extra length twist drills

Article no. **564**



Cutting data page 468



Web thinning $\geq \varnothing 6.000$ • relieved cone • wide flutes • in case of poor chip evacuation • for extremely deep holes

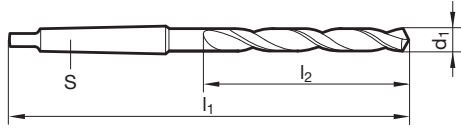

Article no. **564**

Article no. **564**

d1 mm	inch	S	l1 mm	l2 mm	Order no.
6.000		MK-1	300.0	220.0	564 6.000
6.500		MK-1	300.0	220.0	564 6.500
7.000		MK-1	300.0	220.0	564 7.000
8.000		MK-1	350.0	270.0	564 8.000
8.500		MK-1	350.0	270.0	564 8.500
9.000		MK-1	350.0	270.0	564 9.000

d1 mm	inch	S	l1 mm	l2 mm	Order no.
10.000		MK-1	350.0	270.0	564 10.000

Extra length twist drills

Article no. **565**



Cutting data page 468



Web thinning $\geq \varnothing 6.000$ • relieved cone • wide flutes • in case of poor chip evacuation • for extremely deep holes

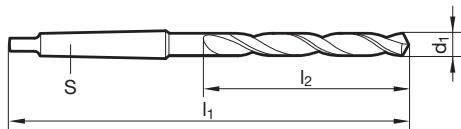

Article no. **565**

Article no. **565**

d1 mm	inch	S	l1 mm	l2 mm	Order no.
6.000		MK-1	425.0	345.0	565 6.000
6.500		MK-1	425.0	345.0	565 6.500
7.000		MK-1	425.0	345.0	565 7.000
7.500		MK-1	425.0	345.0	565 7.500
8.000		MK-1	425.0	345.0	565 8.000
8.500		MK-1	425.0	345.0	565 8.500
9.000		MK-1	425.0	345.0	565 9.000
10.000		MK-1	425.0	345.0	565 10.000
11.000		MK-1	425.0	345.0	565 11.000
12.000		MK-1	425.0	345.0	565 12.000
13.000		MK-1	425.0	345.0	565 13.000
14.000		MK-1	425.0	345.0	565 14.000

d1 mm	inch	S	l1 mm	l2 mm	Order no.
15.000		MK-2	425.0	325.0	565 15.000
16.000		MK-2	425.0	325.0	565 16.000
17.000		MK-2	425.0	325.0	565 17.000



Extra length twist drills

Article no. **566**



Cutting data page 468



P	M	K	N	S	H
•		•	•		

Web thinning $\geq \varnothing 8.000$ • relieved cone • wide flutes • in case of poor chip evacuation • for extremely deep holes

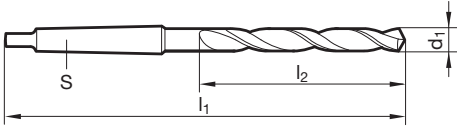

Article no. **566**

Article no. **566**

d1 mm	inch	S	l1 mm	l2 mm	Order no.
8.000		MK-1	500.0	420.0	566 8.000
8.500		MK-1	500.0	420.0	566 8.500
9.000		MK-1	500.0	420.0	566 9.000
9.500		MK-1	500.0	420.0	566 9.500
10.000		MK-1	500.0	420.0	566 10.000
11.000		MK-1	500.0	420.0	566 11.000
12.000		MK-1	500.0	420.0	566 12.000
13.000		MK-1	500.0	420.0	566 13.000
14.000		MK-1	500.0	420.0	566 14.000
15.000		MK-2	500.0	400.0	566 15.000
16.000		MK-2	500.0	400.0	566 16.000
17.000		MK-2	500.0	400.0	566 17.000

d1 mm	inch	S	l1 mm	l2 mm	Order no.
18.000		MK-2	500.0	400.0	566 18.000
19.000		MK-2	500.0	400.0	566 19.000
20.000		MK-2	500.0	400.0	566 20.000
21.000		MK-2	500.0	400.0	566 21.000
22.000		MK-2	500.0	400.0	566 22.000
35.000		MK-4	500.0	350.0	566 35.000
40.000		MK-4	500.0	350.0	566 40.000

Extra length twist drills

Article no. **293**



Cutting data page 468



P	M	K	N	S	H
•		•	•		

Web thinning $\geq \varnothing 14.000$ • relieved cone • wide flutes • in case of poor chip evacuation • for extremely deep holes

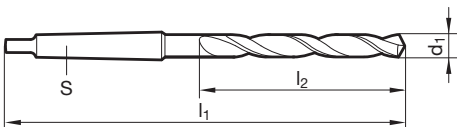

Article no. **293**

Article no. **293**

d1 mm	inch	S	l1 mm	l2 mm	Order no.
14.000		MK-1	600.0	500.0	293 14.000
15.000		MK-2	600.0	500.0	293 15.000
16.000		MK-2	600.0	500.0	293 16.000
17.000		MK-2	600.0	500.0	293 17.000
18.000		MK-2	600.0	500.0	293 18.000
19.000		MK-2	600.0	500.0	293 19.000
20.000		MK-2	600.0	500.0	293 20.000
21.000		MK-2	600.0	500.0	293 21.000
22.000		MK-2	600.0	500.0	293 22.000
23.000		MK-2	600.0	500.0	293 23.000
24.000		MK-3	600.0	475.0	293 24.000
25.000	63/64	MK-3	600.0	475.0	293 25.000

d1 mm	inch	S	l1 mm	l2 mm	Order no.
26.000		MK-3	600.0	475.0	293 26.000
28.000		MK-3	600.0	475.0	293 28.000
30.000		MK-3	600.0	475.0	293 30.000
32.000		MK-4	600.0	450.0	293 32.000
35.000		MK-4	600.0	450.0	293 35.000
38.000		MK-4	600.0	450.0	293 38.000
40.000		MK-4	600.0	450.0	293 40.000



Extra length twist drills

Article no. **298**



Cutting data page 468

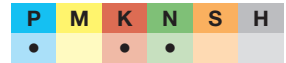

Web thinning $\geq \varnothing 14.000$ • relieved cone • wide flutes • in case of poor chip evacuation • for extremely deep holes

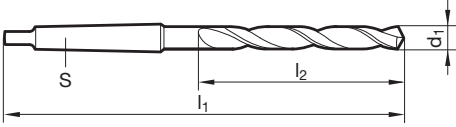

Article no. **298**

Article no. **298**

d1 mm	inch	S	l1 mm	l2 mm	Order no.
14.000		MK-1	750.0	650.0	298 14.000
15.000		MK-2	750.0	650.0	298 15.000
16.000		MK-2	750.0	650.0	298 16.000
18.000		MK-2	750.0	650.0	298 18.000

d1 mm	inch	S	l1 mm	l2 mm	Order no.

Extra length twist drills

Article no. **299**



Cutting data page 468



Web thinning $\geq \varnothing 14.000$ • relieved cone • wide flutes • in case of poor chip evacuation • for extremely deep holes

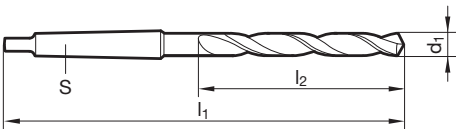

Article no. **299**

Article no. **299**

d1 mm	inch	S	l1 mm	l2 mm	Order no.
14.000		MK-1	1000.0	850.0	299 14.000
15.000		MK-2	1000.0	850.0	299 15.000
16.000		MK-2	1000.0	850.0	299 16.000
18.000		MK-2	1000.0	850.0	299 18.000

d1 mm	inch	S	l1 mm	l2 mm	Order no.



Twist drills with internal coolant, flute length to company standard

Article no. **254**



Cutting data page 474

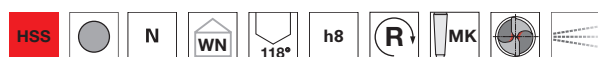

Web thinning $\geq \varnothing 8.000$ • relieved cone • axial and radial coolant supply through morse taper shank (similar to DIN 228 form BK) • opening and closing the necessary coolant supply possible with the supplied screw

HSS/HSCO drills

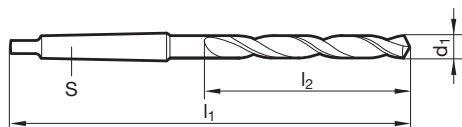

Article no. **254**

d1 mm	inch	S	l1 mm	l2 mm	Order no.
8.000		MK-2	268.0	116.0	254 8.000
9.000		MK-2	268.0	116.0	254 9.000
10.000		MK-3	268.0	116.0	254 10.000
10.500		MK-3	268.0	116.0	254 10.500
11.000		MK-3	278.0	125.0	254 11.000
12.000		MK-3	287.0	134.0	254 12.000
13.000		MK-3	287.0	134.0	254 13.000
13.500		MK-3	285.0	142.0	254 13.500
14.000		MK-3	285.0	142.0	254 14.000
15.000		MK-3	300.0	147.0	254 15.000
16.000		MK-3	306.0	153.0	254 16.000
17.000		MK-3	311.0	159.0	254 17.000
17.500		MK-3	318.0	165.0	254 17.500
18.000		MK-3	318.0	165.0	254 18.000
19.000		MK-3	324.0	171.0	254 19.000
20.000		MK-3	330.0	177.0	254 20.000
21.000		MK-3	343.0	184.0	254 21.000
22.000		MK-3	350.0	191.0	254 22.000
23.000		MK-3	357.0	198.0	254 23.000
24.000		MK-3	365.0	206.0	254 24.000
25.000	63/64	MK-3	365.0	206.0	254 25.000
26.000		MK-3	373.0	214.0	254 26.000
27.000		MK-4	407.0	222.0	254 27.000
28.000		MK-4	407.0	222.0	254 28.000

Article no. **254**

d1 mm	inch	S	l1 mm	l2 mm	Order no.
29.000		MK-4	410.0	225.0	254 29.000
30.000		MK-4	410.0	225.0	254 30.000
31.000		MK-4	410.0	225.0	254 31.000
32.000		MK-4	410.0	225.0	254 32.000
33.000		MK-4	410.0	225.0	254 33.000
34.000		MK-4	410.0	225.0	254 34.000
35.000		MK-4	410.0	225.0	254 35.000
36.000		MK-4	410.0	225.0	254 36.000
37.000		MK-4	410.0	225.0	254 37.000
38.000		MK-4	410.0	225.0	254 38.000
39.000		MK-4	410.0	225.0	254 39.000
40.000		MK-4	410.0	225.0	254 40.000
41.000		MK-4	410.0	225.0	254 41.000
42.000		MK-4	410.0	225.0	254 42.000
43.000		MK-4	410.0	225.0	254 43.000
44.000		MK-4	410.0	225.0	254 44.000
45.000		MK-4	410.0	225.0	254 45.000
46.000		MK-4	410.0	225.0	254 46.000
47.000		MK-4	410.0	225.0	254 47.000
48.000		MK-4	410.0	225.0	254 48.000
49.000		MK-4	410.0	225.0	254 49.000
50.000		MK-4	410.0	225.0	254 50.000



HSS/HSCO drills with morse taper

HSS/HSCO drills

Twist drills with internal coolant, flute length to company standard

Article no. 255



Cutting data page 474

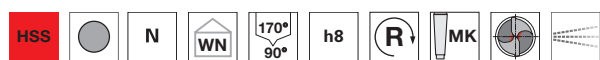

Web thinning $\geq \varnothing 8.000$ • relieved cone • special point geometry with 170° point angle and 90° centre point • very good self-centering • axial and radial coolant supply through morse taper shank (similar to DIN 228 form BK) • opening and closing the necessary coolant supply possible with the supplied screw

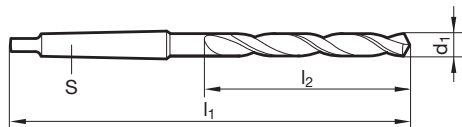

Article no. 255

d1 mm	inch	S	l1 mm	l2 mm	Order no.
8.000		MK-2	268.0	116.0	255 8.000
9.000		MK-2	268.0	116.0	255 9.000
10.000		MK-3	268.0	116.0	255 10.000
10.500		MK-3	268.0	116.0	255 10.500
11.000		MK-3	278.0	125.0	255 11.000
12.000		MK-3	287.0	134.0	255 12.000
13.000		MK-3	287.0	134.0	255 13.000
13.500		MK-3	285.0	142.0	255 13.500
14.000		MK-3	285.0	142.0	255 14.000
15.000		MK-3	300.0	147.0	255 15.000
16.000		MK-3	306.0	153.0	255 16.000
17.000		MK-3	311.0	159.0	255 17.000
17.500		MK-3	318.0	165.0	255 17.500
18.000		MK-3	318.0	165.0	255 18.000
19.000		MK-3	324.0	171.0	255 19.000
20.000		MK-3	330.0	177.0	255 20.000
21.000		MK-3	343.0	184.0	255 21.000
22.000		MK-3	350.0	191.0	255 22.000
23.000		MK-3	357.0	198.0	255 23.000
24.000		MK-3	365.0	206.0	255 24.000
25.000	63/64	MK-3	365.0	206.0	255 25.000
26.000		MK-3	373.0	214.0	255 26.000
27.000		MK-4	375.0	193.0	255 27.000
28.000		MK-4	375.0	193.0	255 28.000

Article no. 255

d1 mm	inch	S	l1 mm	l2 mm	Order no.
29.000		MK-4	375.0	193.0	255 29.000
30.000		MK-4	375.0	193.0	255 30.000
31.000		MK-4	375.0	193.0	255 31.000
32.000		MK-4	375.0	193.0	255 32.000
33.000		MK-4	375.0	193.0	255 33.000
34.000		MK-4	375.0	193.0	255 34.000
35.000		MK-4	375.0	193.0	255 35.000
36.000		MK-4	375.0	193.0	255 36.000
37.000		MK-4	375.0	193.0	255 37.000
38.000		MK-4	375.0	193.0	255 38.000
39.000		MK-4	375.0	193.0	255 39.000
40.000		MK-4	375.0	193.0	255 40.000
41.000		MK-4	375.0	193.0	255 41.000
42.000		MK-4	375.0	193.0	255 42.000



HSS/HSCO drills with morse taper

HSS/HSCO drills

Twist drills with internal coolant, flute length to DIN 341

Article no. 270

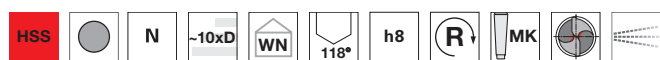

Web thinning $\geq \varnothing 10.000$ • relieved cone • for drilling through drill bushes • axial coolant supply through morse taper

Cutting data page 472-473

P	M	K	N	S	H
•	○	•	•	○	○

Twist drills with internal coolant, flute length to DIN 341

Article no. 370

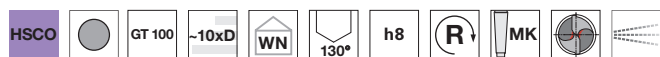

Web thinning $\geq \varnothing 11.000$ • relieved cone • for drilling through drill bushes • axial coolant supply through morse taper
• Co-alloyed high speed steel • increased wear resistance

Cutting data page 472-473

P	M	K	N	S	H
•	•	•	•	○	○

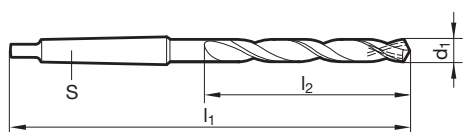

Article no. 270					370		Article no. 270					370		
d1 mm	inch	S	l1 mm	l2 mm	Order no.		d1 mm	inch	S	l1 mm	l2 mm	Order no.		
10.000		MK-2	233.0	116.0	270	10.000	22.000		MK-3	327.0	191.0	270	22.000	370 22.000
11.000		MK-2	242.0	125.0	270	11.000	23.000		MK-3	334.0	198.0	270	23.000	370 23.000
12.000		MK-2	251.0	134.0	270	12.000	24.000		MK-3	342.0	206.0	270	24.000	370 24.000
12.500		MK-2	251.0	134.0	270	12.500	25.000	63/64	MK-3	342.0	206.0	270	25.000	
13.000		MK-2	251.0	134.0	270	13.000	26.000		MK-3	350.0	214.0	270	26.000	
13.500		MK-2	259.0	142.0	270	13.500	26.500		MK-3	350.0	214.0	270	26.500	
14.000		MK-2	259.0	142.0	270	14.000	27.000		MK-4	385.0	222.0	270	27.000	
14.290	9/16	MK-2	264.0	147.0	270	14.290	28.000		MK-4	385.0	222.0	270	28.000	
14.500		MK-2	264.0	147.0	270	14.500	29.000		MK-4	393.0	230.0	270	29.000	
15.000		MK-2	264.0	147.0	270	15.000	29.370	1 5/32	MK-4	393.0	230.0		370 29.370	
15.500		MK-2	270.0	153.0	270	15.500	29.500		MK-4	393.0	230.0	270	29.500	370 29.500
16.000		MK-2	270.0	153.0	270	16.000	30.000		MK-4	393.0	230.0	270	30.000	
16.500		MK-2	276.0	159.0	270	16.500	31.000		MK-4	402.0	239.0		370 31.000	
17.000		MK-2	276.0	159.0	270	17.000	32.000		MK-4	421.0	248.0	270	32.000	370 32.000
17.460	11/16	MK-2	282.0	165.0	270	17.460	33.000		MK-4	421.0	248.0	270	33.000	370 33.000
17.500		MK-2	282.0	165.0	270	17.500	34.000		MK-4	430.0	257.0	270	34.000	
18.000		MK-2	282.0	165.0	270	18.000	35.000		MK-4	430.0	257.0	270	35.000	
18.500		MK-3	307.0	171.0	270	18.500	40.000		MK-4	450.0	277.0	270	40.000	
19.000		MK-3	307.0	171.0	270	19.000								
19.500		MK-3	313.0	177.0	270	19.500								
20.000		MK-3	313.0	177.0	270	20.000								
20.500		MK-3	320.0	184.0	270	20.500								
21.000		MK-3	320.0	184.0	270	21.000								
21.500		MK-3	327.0	191.0		21.500								



Twist drills with internal coolant, flute length to DIN 1870

Article no. **374**



Cutting data page 475

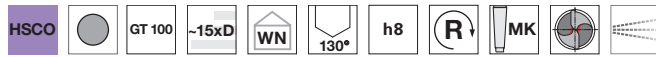

Web thinning $\geq \varnothing 11.000$ • for drilling through drill bushes • axial coolant supply through morse taper • relieved cone
 • increased wear resistance • Co-alloyed high speed steel

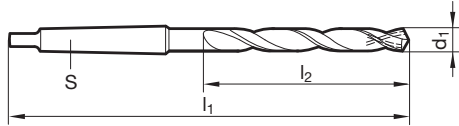

Article no. **374**

d1 mm	inch	S	l1 mm	l2 mm	Order no.
11.000		MK-2	312.0	195.0	374 11.000
12.000		MK-2	322.0	205.0	374 12.000
12.300	31/64	MK-2	322.0	205.0	374 12.300
12.500		MK-2	322.0	205.0	374 12.500
13.000		MK-2	322.0	205.0	374 13.000
14.000		MK-2	337.0	220.0	374 14.000
15.000		MK-2	337.0	220.0	374 15.000
16.000		MK-2	347.0	230.0	374 16.000
17.500		MK-2	362.0	245.0	374 17.500
18.000		MK-2	362.0	245.0	374 18.000
18.500		MK-3	381.0	245.0	374 18.500
19.840	25/32	MK-3	396.0	260.0	374 19.840

Article no. **374**

d1 mm	inch	S	l1 mm	l2 mm	Order no.
20.000		MK-3	396.0	260.0	374 20.000
21.000		MK-3	396.0	260.0	374 21.000
21.500		MK-3	406.0	270.0	374 21.500
28.570	1 1/8	MK-4	468.0	305.0	374 28.570
30.960	1 7/32	MK-4	483.0	320.0	374 30.960
32.250		MK-4	493.0	320.0	374 32.250
34.000		MK-4	513.0	340.0	374 34.000



Centre drills

Centre drills

Centre drills without flat

Article no. **736**



Cutting data page 476



P	M	K	N	S	H
○	○	○	○	○	○

Web thinning $\geq \varnothing 2.000$ • relieved cone • without protective countersink • for centre holes to DIN 332, part 1, form A
 • $d1 \leq 0.8$ mm: not double ended

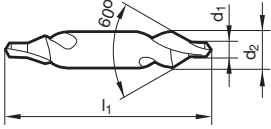

Article no. **736**

Article no. **736**

d1 mm	d2 mm	l1 mm	Order no.
0.500	3.15	25.00	736 0.500
0.800	3.15	25.00	736 0.800
1.000	3.15	31.50	736 1.000
1.250	3.15	31.50	736 1.250
1.600	4.00	35.50	736 1.600
2.000	5.00	40.00	736 2.000

d1 mm	d2 mm	l1 mm	Order no.
2.500	6.30	45.00	736 2.500
3.150	8.00	50.00	736 3.150
4.000	10.00	56.00	736 4.000
5.000	12.50	63.00	736 5.000
6.300	16.00	71.00	736 6.300



Centre drills without flat

Article no. **381**



HSCo N

Web thinning $\geq \varnothing 2.000$ • relieved cone • without protective countersink • increased wear resistance • for centre holes to DIN 332, part 1, form A

Cutting data page 477

P	M	K	N	S	H
●	●	●	●	○	

Centre drills without flat

Article no. **6503**



HSCo N

Web thinning $\geq \varnothing 2.000$ • relieved cone • without protective countersink • for centre holes to DIN 332, part 1, form A
• $d1 \leq 0.8$ mm: not double ended

Cutting data page 477

P	M	K	N	S	H
●	●	●	○	●	

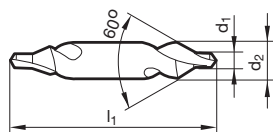

Article no. 381			381		6503		Article no. 381			381		6503		
d1 mm	d2 mm	l1 mm	Order no.		d1 mm	d2 mm	l1 mm	Order no.		d1 mm	d2 mm	l1 mm	Order no.	
0.500	3.15	25.00			0.500			381 0.500	6503 0.500	3.150	8.00	50.00	381 3.150	6503 3.150
1.000	3.15	31.50	381 1.000	6503 1.000	4.000	10.00	56.00	381 4.000	6503 4.000					
1.250	3.15	31.50	381 1.250	6503 1.250										
1.600	4.00	35.50	381 1.600	6503 1.600										
2.000	5.00	40.00	381 2.000	6503 2.000										
2.500	6.30	45.00	381 2.500	6503 2.500										

Centre drills without flat

Article no. **581**



HSS N

Web thinning $\geq \varnothing 2.000$ • relieved cone • without protective countersink • for centre holes to DIN 332, part 1, form A
• $d1 \leq 0.8$ mm: not double ended

Cutting data page 478

P	M	K	N	S	H
●	○	●	●	○	

Centre drills without flat

Article no. **613**



HSS N

Web thinning $\geq \varnothing 2.000$ • relieved cone • without protective countersink • for centre holes to DIN 332, part 1, form A
• $d1 \leq 0.8$ mm: not double ended • increased wear resistance

Cutting data page 478

P	M	K	N	S	H
●	○	●	●	○	

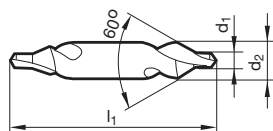

Article no. 581			581		613		Article no. 581			581		613		
d1 mm	d2 mm	l1 mm	Order no.		d1 mm	d2 mm	l1 mm	Order no.		d1 mm	d2 mm	l1 mm	Order no.	
0.500	3.15	25.00	581 0.500	613 0.500	10.000	25.00	100.00	581 10.000	613 10.000	12.500	31.50	125.00	581 12.500	613 12.500
0.800	3.15	25.00	581 0.800	613 0.800										
1.000	3.15	31.50	581 1.000	613 1.000										
1.250	3.15	31.50	581 1.250	613 1.250										
1.600	4.00	35.50	581 1.600	613 1.600										
2.000	5.00	40.00	581 2.000	613 2.000										
2.500	6.30	45.00	581 2.500	613 2.500										
3.150	8.00	50.00	581 3.150	613 3.150										
4.000	10.00	56.00	581 4.000	613 4.000										
5.000	12.50	63.00	581 5.000	613 5.000										
6.300	16.00	71.00	581 6.300	613 6.300										
8.000	20.00	80.00	581 8.000	613 8.000										



Centre drills

Centre drills

Centre drills without flat

Article no. **582**



Cutting data page 478



Web thinning $\geq \varnothing 2.000$ • relieved cone • without protective countersink • for centre holes to DIN 332, part 1, form A
• $d1 \leq 0.8$ mm: not double ended

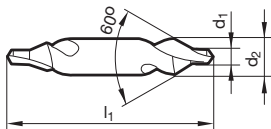

Article no. **582**

Article no. **582**

d1 mm	d2 mm	l1 mm	Order no.
0.500	3.15	25.00	582 0.500
0.800	3.15	25.00	582 0.800
1.000	3.15	31.50	582 1.000
1.250	3.15	31.50	582 1.250
1.600	4.00	35.50	582 1.600
2.000	5.00	40.00	582 2.000
2.500	6.30	45.00	582 2.500
3.150	8.00	50.00	582 3.150
4.000	10.00	56.00	582 4.000
5.000	12.50	63.00	582 5.000
6.300	16.00	71.00	582 6.300
8.000	20.00	80.00	582 8.000

d1 mm	d2 mm	l1 mm	Order no.
10.000	25.00	100.00	582 10.000
12.500	31.50	125.00	582 12.500



Centre drills without flat

Article no. **583**



Cutting data page 478

P	M	K	N	S	H
●	○	●	●	○	

Web thinning $\geq \varnothing 2.000$ • relieved cone • correct positioning between lathe centres • for centre holes to DIN 332 part 1, form R • $d1 \leq 0.8$ mm: not double ended

Centre drills without flat

Article no. **614**



Cutting data page 478

P	M	K	N	S	H
●	○	●	●	○	

Web thinning $\geq \varnothing 2.000$ • relieved cone • increased wear resistance • correct positioning between lathe centres • for centre holes to DIN 332 part 1, form R • $d1 \leq 0.8$ mm: not double ended

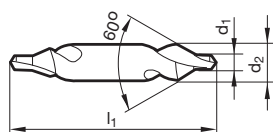

Article no. 583			614		Article no. 583			614	
d1 mm	d2 mm	l1 mm	Order no.		d1 mm	d2 mm	l1 mm	Order no.	
0.500	3.15	25.00	583 0.500		10.000	25.00	100.00	583 10.000	
0.800	3.15	25.00	583 0.800	614 0.800	12.500	31.50	125.00	583 12.500	
1.000	3.15	31.50	583 1.000	614 1.000					
1.250	3.15	31.50	583 1.250	614 1.250					
1.600	4.00	35.50	583 1.600	614 1.600					
2.000	5.00	40.00	583 2.000	614 2.000					
2.500	6.30	45.00	583 2.500	614 2.500					
3.150	8.00	50.00	583 3.150	614 3.150					
4.000	10.00	56.00	583 4.000	614 4.000					
5.000	12.50	63.00	583 5.000	614 5.000					
6.300	16.00	71.00	583 6.300	614 6.300					
8.000	20.00	80.00	583 8.000	614 8.000					

Centre drills without flat

Article no. **584**



Cutting data page 478

P	M	K	N	S	H
●	○	●	●	○	

Web thinning $\geq \varnothing 2.000$ • relieved cone • correct positioning between lathe centres • for centre holes to DIN 332 part 1, form R • $d1 \leq 0.8$ mm: not double ended

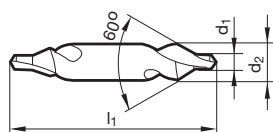

Article no. 584			584		Article no. 584			584	
d1 mm	d2 mm	l1 mm	Order no.		d1 mm	d2 mm	l1 mm	Order no.	
0.800	3.15	25.00	584 0.800		2.500	6.30	45.00	584 2.500	
1.000	3.15	31.50	584 1.000		3.150	8.00	50.00	584 3.150	
1.250	3.15	31.50	584 1.250		4.000	10.00	56.00	584 4.000	
1.600	4.00	35.50	584 1.600		5.000	12.50	63.00	584 5.000	
2.000	5.00	40.00	584 2.000						
2.400	6.30	45.00	584 2.400						



Centre drills

Centre drills

Centre drills without flat

Article no. **585**



Cutting data page 478



P	M	K	N	S	H
●	○	●	○	○	○

Web thinning $\geq \varnothing 2.000$ • relieved cone • for centre holes to DIN 332, sheet 1, form B • with protective 120° countersink

Centre drills without flat

Article no. **6504**



Cutting data page 478



P	M	K	N	S	H
●	○	●	○	●	○

Web thinning $\geq \varnothing 2.000$ • relieved cone • for centre holes to DIN 332, sheet 1, form B • with protective 120° countersink

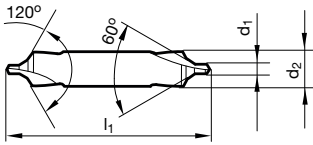

Article no.

585

6504

Article no.

585

6504

d1 mm	d2 mm	l1 mm
1.000	4.00	35.50
1.250	5.00	40.00
1.600	6.30	45.00
2.000	8.00	50.00
2.500	10.00	56.00
3.150	11.20	60.00

Order no.	
585 1.000	6504 1.000
585 1.250	6504 1.250
585 1.600	6504 1.600
585 2.000	6504 2.000
585 2.500	6504 2.500
585 3.150	6504 3.150

d1 mm	d2 mm	l1 mm
4.000	14.00	67.00
5.000	18.00	75.00
6.300	20.00	80.00
8.000	25.00	100.00
10.000	31.50	125.00

Order no.	
585 4.000	6504 4.000
585 5.000	6504 5.000
585 6.300	6504 6.300
585 8.000	
585 10.000	



Centre drills without flat

Article no. 594



Cutting data page 478



Web thinning $\geq \varnothing 1.980$ • relieved cone • for centre holes form A to US standards

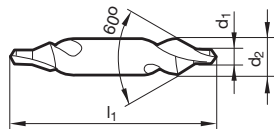

Article no. 594

Size	d1 mm	inch	d2 mm	l1 mm	Order no.
1	1.190	3/64	3.18	32.00	594 1.190
2	1.980	5/64	4.76	48.00	594 1.980
3	2.780	7/64	6.35	51.00	594 2.780
4	3.170	1/8	7.94	54.00	594 3.170
5	4.760	3/16	11.11	70.00	594 4.760
6	5.560	7/32	12.70	76.00	594 5.560

Article no. 594

Size	d1 mm	inch	d2 mm	l1 mm	Order no.
7	6.350	1/4	15.88	83.00	594 6.350
8	7.940	5/16	19.05	89.00	594 7.940

Centre drills without flat

Article no. 595



Cutting data page 478



Web thinning $\geq \varnothing 2.380$ • relieved cone • for centre holes form B to US standards

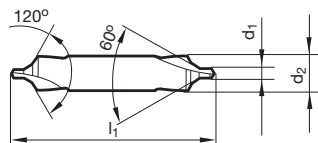

Article no. 595

Size	d1 mm	inch	d2 mm	l1 mm	Order no.
11	1.190	3/64	3.18	32.00	595 1.190
12	1.590	1/16	4.76	48.00	595 1.590
13	2.380	3/32	6.35	51.00	595 2.380
14	2.780	7/64	7.94	54.00	595 2.780
15	3.970	5/32	11.11	70.00	595 3.970
16	4.760	3/16	12.70	76.00	595 4.760

Article no. 595

Size	d1 mm	inch	d2 mm	l1 mm	Order no.
17	5.560	7/32	15.88	83.00	595 5.560
18	6.350	1/4	19.05	89.00	595 6.350

Centre drills without flat

Article no. 292



Cutting data page 478



Web thinning $\geq \varnothing 1.190$ • relieved cone • for centre holes form A to British standards

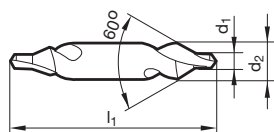

Article no. 292

Size	d1 mm	inch	d2 mm	l1 mm	Order no.
1	1.190	3/64	3.17	38.00	292 1.190
2	1.590	1/16	4.76	44.00	292 1.590
3	2.380	3/32	6.35	51.00	292 2.380
4	3.170	1/8	7.94	57.00	292 3.170
5	4.760	3/16	11.11	63.00	292 4.760
6	6.350	1/4	15.87	76.00	292 6.350

Article no. 292

Size	d1 mm	inch	d2 mm	l1 mm	Order no.
7	7.940	5/16	19.05	89.00	292 7.940



Centre drills without flat

Article no. **281**



Cutting data page 478



P	M	K	N	S	H
●	○	●	●	○	

Web thinning $\geq \varnothing 2.000$ • relieved cone • without protective countersink • for centre holes to DIN 332 sheet 1 (issue 09.1960x retracted), form A • $d1 \leq 0.8$ mm: not double ended

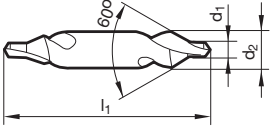

Article no. 281			Article no. 281				
d1 mm	d2 mm	l1 mm	Order no.	d1 mm	d2 mm	l1 mm	Order no.
0.500	3.15	25.00	281 0.500	3.150	10.00	56.00	281 3.150
1.000	3.15	31.50	281 1.000	4.000	12.50	63.00	281 4.000
1.250	4.00	35.50	281 1.250	5.000	16.00	71.00	281 5.000
1.600	5.00	40.00	281 1.600	6.300	20.00	80.00	281 6.300
2.000	6.30	45.00	281 2.000	8.000	25.00	100.00	281 8.000
2.500	8.00	50.00	281 2.500	10.000	31.50	125.00	281 10.000

Centre drills without flat

Article no. **280**



Cutting data page 478



P	M	K	N	S	H
●	○	●	●	○	

Web thinning $\geq \varnothing 2.000$ • relieved cone • extra-long centre drill • without protective countersink • for centre holes to DIN 332, sheet 1, form A • for centre holes to DIN 332 sheet 1 (issue 09.1960x retracted), form A

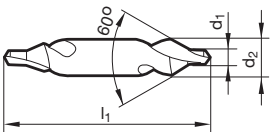

Article no. 280			Article no. 280				
d1 mm	d2 mm	l1 mm	Order no.	d1 mm	d2 mm	l1 mm	Order no.
1.000	4.00	120.00	280 1.000				
1.600	5.00	120.00	280 1.600				
2.000	6.00	120.00	280 2.000				
2.500	8.00	120.00	280 2.500				
3.150	10.00	120.00	280 3.150				



Centre drills with flat

Article no. **587**



Cutting data page 478

P	M	K	N	S	H
●	○	●	●	○	

Web thinning $\geq \varnothing 2.000$ • relieved cone • for centre holes to DIN 332, part 1, form A • without protective countersink

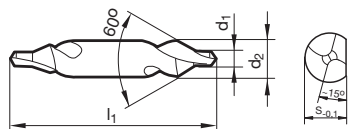

Article no. **587**

Article no. **587**

d1 mm	d2 mm	l1 mm	S mm	Order no.
1.600	4.00	35.50	3.25	587 1.600
2.000	5.00	40.00	4.20	587 2.000
2.500	6.30	45.00	5.35	587 2.500
3.150	8.00	50.00	6.95	587 3.150
4.000	10.00	56.00	8.40	587 4.000
5.000	12.50	63.00	10.95	587 5.000

d1 mm	d2 mm	l1 mm	S mm	Order no.
6.300	16.00	71.00	14.00	587 6.300
8.000	20.00	80.00	17.90	587 8.000
10.000	25.00	100.00	22.50	587 10.000
12.500	31.50	125.00	28.40	587 12.500

Centre drills with flat

Article no. **588**



Cutting data page 478

P	M	K	N	S	H
●	○	●	●	○	

Web thinning $\geq \varnothing 2.000$ • relieved cone • correct positioning between lathe centres • for centre holes to DIN 332 part 1, form R

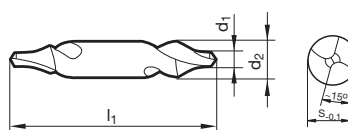

Article no. **588**

Article no. **588**

d1 mm	d2 mm	l1 mm	S mm	Order no.
1.000	3.15	31.50	2.35	588 1.000
1.600		35.50		588 1.600
2.000	5.00	40.00	4.20	588 2.000
2.500	6.30	45.00	5.35	588 2.500
3.150	8.00	50.00	6.95	588 3.150
4.000	10.00	56.00	8.40	588 4.000

d1 mm	d2 mm	l1 mm	S mm	Order no.
5.000	12.50	63.00	10.95	588 5.000
6.300	16.00	71.00	14.00	588 6.300
8.000	20.00	80.00	17.90	588 8.000
10.000	25.00	100.00	22.50	588 10.000

Centre drills with flat

Article no. **589**



Cutting data page 478

P	M	K	N	S	H
●	○	●	●	○	

Web thinning $\geq \varnothing 2.000$ • relieved cone • for centre holes to DIN 332, sheet 1, form B • with protective 120° countersink

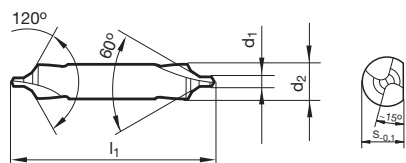

Article no. **589**

Article no. **589**

d1 mm	d2 mm	l1 mm	S mm	Order no.
1.600	6.30	45.00	5.35	589 1.600
2.000	8.00	50.00	6.95	589 2.000
2.500	10.00	56.00	8.40	589 2.500
3.150	11.20	60.00	10.00	589 3.150
4.000	14.00	67.00	12.65	589 4.000
5.000	18.00	75.00	16.40	589 5.000

d1 mm	d2 mm	l1 mm	S mm	Order no.
6.300	20.00	80.00	17.90	589 6.300
8.000	25.00	100.00	22.50	589 8.000



NC spotting drills

NC spotting drills

90° NC spotting drills

Article no. **723**



Cutting data page 479



facet point grind • only suitable for spotting

P	M	K	N	S	H
○	○	○	●	○	○

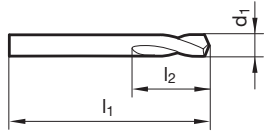

Article no. 723				Article no. 723					
d1 mm	inch	l1 mm	l2 mm	Order no.	d1 mm	inch	l1 mm	l2 mm	Order no.
4.000		55.0	12.0	723 4.000	20.000		131.0	45.0	723 20.000
5.000		62.0	14.0	723 5.000					
6.000		66.0	16.0	723 6.000					
6.350	1/4	70.0	17.0	723 6.350					
8.000		79.0	21.0	723 8.000					
9.520	3/8	89.0	25.0	723 9.520					
10.000		89.0	25.0	723 10.000					
12.000		102.0	30.0	723 12.000					
12.700	1/2	102.0	30.0	723 12.700					
15.870	5/8	115.0	37.5	723 15.870					
16.000		115.0	37.5	723 16.000					
19.050	3/4	131.0	45.0	723 19.050					

90° NC spotting drills

Article no. **6027**



Cutting data page 479

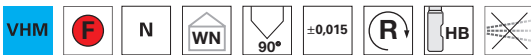

facet point grind • only suitable for spotting • ≥ Ø 6.0 mm with clamping surface shank form HB • inch dimensions are without clamping surface

P	M	K	N	S	H
●	●	●	○	●	○

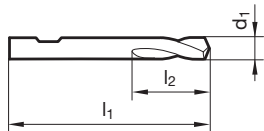

Article no. 6027				Article no. 6027					
d1 mm	inch	l1 mm	l2 mm	Order no.	d1 mm	inch	l1 mm	l2 mm	Order no.
4.000		55.0	12.0	6027 4.000	20.000		131.0	45.0	6027 20.000
5.000		62.0	14.0	6027 5.000					
6.000		66.0	16.0	6027 6.000					
6.350	1/4	70.0	17.0	6027 6.350					
8.000		79.0	21.0	6027 8.000					
9.520	3/8	89.0	25.0	6027 9.520					
10.000		89.0	25.0	6027 10.000					
12.000		102.0	30.0	6027 12.000					
12.700	1/2	102.0	30.0	6027 12.700					
15.870	5/8	115.0	37.5	6027 15.870					
16.000		115.0	37.5	6027 16.000					
19.050	3/4	131.0	45.0	6027 19.050					



90° NC spotting drills

Article no. 1133



Cutting data page 480



relieved cone • only suitable for spotting • $\geq \varnothing 6.0$ mm with driving face to DIN 1835-B • Co-alloyed high speed steel
 • increased wear resistance

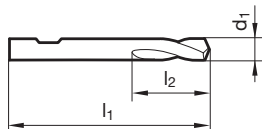

Article no. 1133			Article no. 1133				
d1 mm	l1 mm	l2 mm	Order no.	d1 mm	l1 mm	l2 mm	Order no.
3.000	46.0	12.0	1133 3.000	12.000	102.0	30.0	1133 12.000
4.000	55.0	12.0	1133 4.000	16.000	115.0	37.5	1133 16.000
5.000	62.0	14.0	1133 5.000	20.000	131.0	45.0	1133 20.000
6.000	66.0	16.0	1133 6.000				
8.000	79.0	21.0	1133 8.000				
10.000	89.0	25.0	1133 10.000				

NC spotting drills



NC spotting drills

NC spotting drills

90° NC spotting drills

Article no. 557



Cutting data page 481

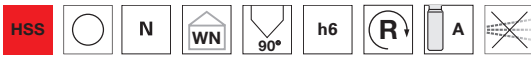

relieved cone • only suitable for spotting

P	M	K	N	S	H
•	○	•	•	○	

90° NC spotting drills

Article no. 568



Cutting data page 481



relieved cone • only suitable for spotting

P	M	K	N	S	H
•	○	•	•	○	

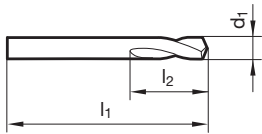

		Article no.		557	568
d1	inch	l1	l2	Order no.	
3.000		46.0	12.0	557 3.000	568 3.000
4.000		55.0	12.0	557 4.000	568 4.000
5.000		62.0	14.0	557 5.000	568 5.000
6.000		66.0	16.0	557 6.000	568 6.000
6.350	1/4	70.0	17.0	557 6.350	568 6.350
8.000		79.0	21.0	557 8.000	568 8.000
9.000		84.0	22.0	557 9.000	
9.520	3/8	89.0	25.0	557 9.520	568 9.520
10.000		89.0	25.0	557 10.000	568 10.000
12.000		102.0	30.0	557 12.000	568 12.000
12.700	1/2	102.0	30.0	557 12.700	568 12.700
13.000		102.0	30.0	557 13.000	

		Article no.		557	568
d1	inch	l1	l2	Order no.	
14.000		107.0	33.5	557 14.000	
15.870	5/8	115.0	37.5	557 15.870	568 15.870
16.000		115.0	37.5	557 16.000	568 16.000
19.050	3/4	131.0	45.0	557 19.050	568 19.050
20.000		131.0	45.0	557 20.000	568 20.000
25.000	63/64	151.0	53.0	557 25.000	568 25.000
25.400	1	156.0	53.0	557 25.400	568 25.400

90° NC spotting drills

Article no. 559



Cutting data page 481



relieved cone • only suitable for spotting

P	M	K	N	S	H
•	○	•	•	○	

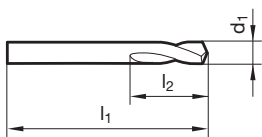

		Article no.		559
d1	inch	l1	l2	Order no.
6.350	1/4	105.0	17.0	559 6.350
8.000		118.0	21.0	559 8.000
9.520	3/8	132.0	25.0	559 9.520
12.700	1/2	159.0	30.0	559 12.700
15.870	5/8	186.0	37.5	559 15.870
19.050	3/4	213.0	45.0	559 19.050

		Article no.		559
d1	inch	l1	l2	Order no.
25.400	1	216.0	53.0	559 25.400



120° NC spotting drills

Article no. 724



Cutting data page 479

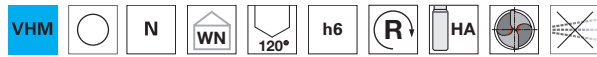

Web thinning $\geq \varnothing 13.500$ • facet point grind • only suitable for spotting

P	M	K	N	S	H
○	○	○	●	○	○

NC spotting drills

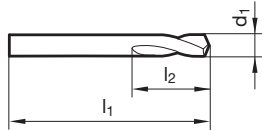

Article no. 724					Article no. 724				
d1 mm	inch	l1 mm	l2 mm	Order no.	d1 mm	inch	l1 mm	l2 mm	Order no.
5.000		62.0	14.0	724 5.000	12.000		102.0	30.0	724 12.000
6.000		66.0	16.0	724 6.000	12.700	1/2	102.0	30.0	724 12.700
6.350	1/4	70.0	17.0	724 6.350	15.870	5/8	115.0	37.5	724 15.870
8.000		79.0	21.0	724 8.000	16.000		115.0	37.5	724 16.000
9.520	3/8	89.0	25.0	724 9.520	19.050	3/4	131.0	45.0	724 19.050
10.000		89.0	25.0	724 10.000	20.000		131.0	45.0	724 20.000

120° NC spotting drills

Article no. 6028



Cutting data page 479

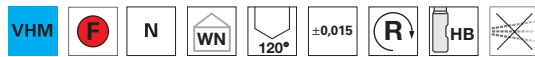

facet point grind • only suitable for spotting • $\geq \varnothing 6.0$ mm with clamping surface shank form HB • inch dimensions are without clamping surface

P	M	K	N	S	H
●	○	○	○	○	○

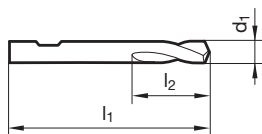

Article no. 6028					Article no. 6028				
d1 mm	inch	l1 mm	l2 mm	Order no.	d1 mm	inch	l1 mm	l2 mm	Order no.
3.000		46.0	12.0	6028 3.000	20.000		131.0	45.0	6028 20.000
5.000		62.0	14.0	6028 5.000					
6.000		66.0	16.0	6028 6.000					
6.350	1/4	70.0	17.0	6028 6.350					
8.000		79.0	21.0	6028 8.000					
9.520	3/8	89.0	25.0	6028 9.520					
10.000		89.0	25.0	6028 10.000					
12.000		102.0	30.0	6028 12.000					
12.700	1/2	102.0	30.0	6028 12.700					
15.870	5/8	115.0	37.5	6028 15.870					
16.000		115.0	37.5	6028 16.000					
19.050	3/4	131.0	45.0	6028 19.050					



NC spotting drills

NC spotting drills

120° NC spotting drills

Article no. 1135



Cutting data page 480

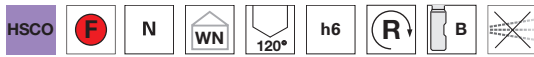

relieved cone • only suitable for spotting • $\geq \varnothing 6.0$ mm with driving face to DIN 1835-B • Co-alloyed high speed steel
• increased wear resistance

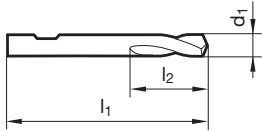

Article no. 1135			Article no. 1135				
d1 mm	l1 mm	l2 mm	Order no.	d1 mm	l1 mm	l2 mm	Order no.
3.000	46.0	12.0	1135 3.000	12.000	102.0	30.0	1135 12.000
4.000	55.0	12.0	1135 4.000	16.000	115.0	37.5	1135 16.000
5.000	62.0	14.0	1135 5.000	20.000	131.0	45.0	1135 20.000
6.000	66.0	16.0	1135 6.000				
8.000	79.0	21.0	1135 8.000				
10.000	89.0	25.0	1135 10.000				

120° NC spotting drills

Article no. 556



Cutting data page 481

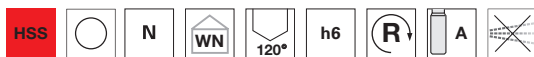

relieved cone • only suitable for spotting

120° NC spotting drills

Article no. 567



Cutting data page 481

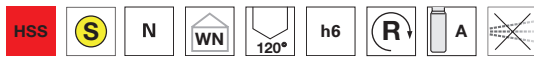

relieved cone • only suitable for spotting

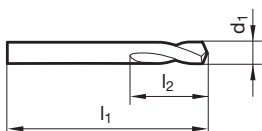

Article no. 556				Article no. 567		Article no. 556				Article no. 567	
d1 mm	inch	l1 mm	l2 mm	Order no.		d1 mm	inch	l1 mm	l2 mm	Order no.	
3.000		46.0	12.0	556 3.000	567 3.000	12.700	1/2	102.0	30.0	556 12.700	567 12.700
4.000		55.0	12.0	556 4.000	567 4.000	14.000		107.0	33.5	556 14.000	
5.000		62.0	14.0	556 5.000	567 5.000	15.000		111.0	33.5	556 15.000	
5.600		66.0	16.0	556 5.600		15.870	5/8	115.0	37.5	556 15.870	567 15.870
6.000		66.0	16.0	556 6.000	567 6.000	16.000		115.0	37.5	556 16.000	567 16.000
6.350	1/4	70.0	17.0	556 6.350	567 6.350	19.050	3/4	131.0	45.0	556 19.050	567 19.050
6.500		70.0	17.0	556 6.500		20.000		131.0	45.0	556 20.000	567 20.000
7.000		74.0	19.0	556 7.000		25.000	63/64	151.0	53.0	556 25.000	567 25.000
8.000		79.0	21.0	556 8.000	567 8.000	25.400	1	156.0	53.0	556 25.400	567 25.400
9.520	3/8	89.0	25.0	556 9.520	567 9.520						
10.000		89.0	25.0	556 10.000	567 10.000						
12.000		102.0	30.0	556 12.000	567 12.000						



142° NC spotting drills

Article no. 546



Cutting data page 479

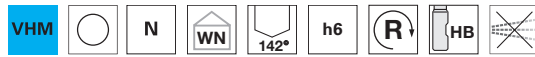

P	M	K	N	S	H
○	○	○	●	○	○

facet point grind • only suitable for spotting • $\geq \varnothing 6.0$ mm with clamping surface shank form HB

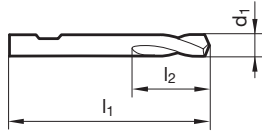

Article no. 546			Article no. 546				
d1 mm	l1 mm	l2 mm	Order no.	d1 mm	l1 mm	l2 mm	Order no.
4.000	55.0	12.0	546 4.000	16.000	115.0	37.5	546 16.000
5.000	62.0	14.0	546 5.000	20.000	131.0	45.0	546 20.000
6.000	66.0	16.0	546 6.000				
8.000	79.0	21.0	546 8.000				
10.000	89.0	25.0	546 10.000				
12.000	102.0	30.0	546 12.000				

142° NC spotting drills

Article no. 6029



Cutting data page 479

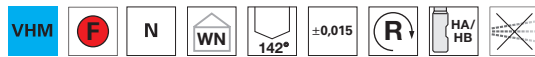

P	M	K	N	S	H
●	●	●	○	●	○

facet point grind • only suitable for spotting • $\geq \varnothing 6.0$ mm with clamping surface shank form HB • $\leq \varnothing 3.0$ mm shank- $\varnothing 4.0$ mm with HA shank

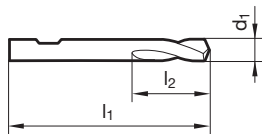

Article no. 6029			Article no. 6029				
d1 mm	l1 mm	l2 mm	Order no.	d1 mm	l1 mm	l2 mm	Order no.
1.000	50.0	3.0	6029 1.000	8.000	79.0	21.0	6029 8.000
2.000	50.0	6.0	6029 2.000	10.000	89.0	25.0	6029 10.000
3.000	50.0	9.0	6029 3.000	12.000	102.0	30.0	6029 12.000
4.000	55.0	12.0	6029 4.000	16.000	115.0	37.5	6029 16.000
5.000	62.0	14.0	6029 5.000	20.000	131.0	45.0	6029 20.000
6.000	66.0	16.0	6029 6.000				



Straight shank drills double-ended

NC spotting drills

Straight shank drills double-ended

Article no. 554



Cutting data page 481

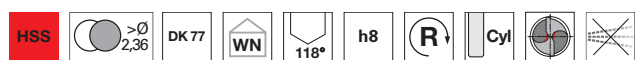

P	M	K	N	S	H
●	○	●	●	○	○

Web thinning $\geq \varnothing 1.450$ • relieved cone • for application on both sides • for hand drilling machines in car body construction

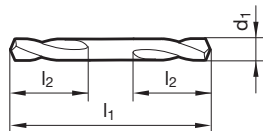

Article no. 554			Article no. 554				
d1 mm	l1 mm	l2 mm	Order no.	d1 mm	l1 mm	l2 mm	Order no.
1.500	32.0	6.0	554 1.500	4.400	58.0	15.5	554 4.400
2.000	38.0	7.5	554 2.000	4.500	58.0	15.5	554 4.500
2.100	38.0	7.5	554 2.100	4.600	58.0	15.5	554 4.600
2.200	40.0	8.5	554 2.200	4.760	62.0	17.0	554 4.760
2.300	40.0	8.5	554 2.300	4.800	62.0	17.0	554 4.800
2.400	43.0	9.5	554 2.400	4.900	62.0	17.0	554 4.900
2.500	43.0	9.5	554 2.500	5.000	62.0	17.0	554 5.000
2.600	43.0	9.5	554 2.600	5.100	62.0	17.0	554 5.100
2.700	46.0	10.6	554 2.700	5.200	62.0	17.0	554 5.200
2.800	46.0	10.6	554 2.800	5.300	62.0	17.0	554 5.300
3.000	46.0	10.6	554 3.000	5.500	66.0	19.0	554 5.500
3.100	49.0	11.2	554 3.100	5.950	66.0	19.0	554 5.950
3.170	49.0	11.2	554 3.170	6.000	66.0	19.0	554 6.000
3.200	49.0	11.2	554 3.200	6.100	70.0	21.2	554 6.100
3.300	49.0	11.2	554 3.300	6.350	70.0	21.2	554 6.350
3.500	52.0	12.5	554 3.500	6.500	70.0	21.2	554 6.500
3.570	52.0	12.5	554 3.570	6.800	74.0	23.6	554 6.800
3.600	52.0	12.5	554 3.600	7.000	74.0	23.6	554 7.000
3.700	52.0	12.5	554 3.700	7.500	74.0	23.6	554 7.500
3.970	55.0	14.0	554 3.970	8.000	79.0	25.0	554 8.000
4.000	55.0	14.0	554 4.000	8.500	79.0	25.0	554 8.500
4.100	55.0	14.0	554 4.100	8.600	84.0	25.0	554 8.600
4.200	55.0	14.0	554 4.200	9.000	84.0	25.0	554 9.000
4.300	58.0	15.5	554 4.300	10.000	89.0	25.0	554 10.000



Spot weld drills

Article no. 1137



Cutting data page 480

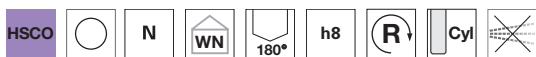

P	M	K	N	S	H
●	○	●	○	○	

relieved cone • optimally suited for the removal of welding spots in sheet steel, i.e. for repairs in the automotive industry or replacing car body parts

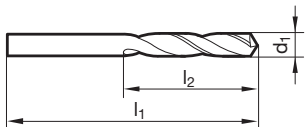

Article no. 1137			Order no.
d1 mm	l1 mm	l2 mm	
6.000	66.0	28.0	1137 6.000
8.000	79.0	37.0	1137 8.000
10.000	89.0	43.0	1137 10.000

Article no. 1137			Order no.
d1 mm	l1 mm	l2 mm	

Spot weld drills

Article no. 6996



Cutting data page 480

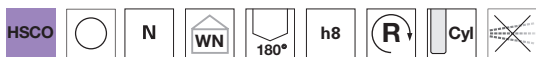

P	M	K	N	S	H
●	○	●	○	○	

relieved cone • optimally suited for the removal of welding spots in sheet steel, i.e. for repairs in the automotive industry or replacing car body parts

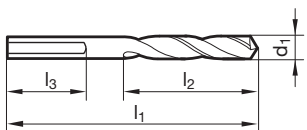

Article no. 6996				Order no.
d1 mm	l1 mm	l2 mm	l3 mm	
8.000	40.0	18.0	10.5	6996 8.000
8.000	44.0	20.0	16.0	6996 8.001

Article no. 6996				Order no.
d1 mm	l1 mm	l2 mm	l3 mm	



Step drills

Step drills/Core drills

Stepped drills for centring according to DIN 332

Article no. **274**



Cutting data page 482



Web thinning $\geq \varnothing 8.000$ • web thinning value refers to nom.- $\varnothing d1$ • relieved cone • shank with flat • 60° countersink angle • for tapping size holes with centering to DIN 332, sheet 2, form D • application on centring/cut-off machines

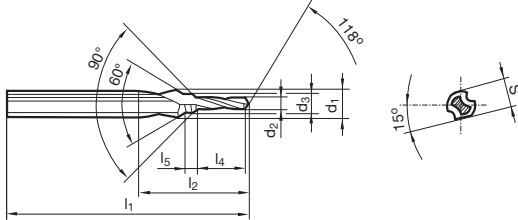

Article no.

274

d1 h7 mm	d2 h8 mm	d3 mm	l1 mm	l2 mm	l4 mm	l5 mm	S mm	for thread	Order no.
8.000	3.30	4.30	63.00	23.00	11.00	1.60	6.75	M 4	274 8.000
10.000	4.20	5.30	67.00	27.00	13.00	2.15	8.45	M 5	274 10.000
12.500	5.00	6.40	71.00	33.00	16.00	2.90	10.45	M 6	274 12.500
14.000	6.80	8.40	88.00	41.00	19.50	3.50	12.50	M 8	274 14.000
16.000	8.50	10.50	94.00	47.00	23.00	4.70	14.85	M10	274 16.000
20.000	10.20	13.00	105.00	59.00	28.00	6.50	18.45	M12	274 20.000
25.000	14.00	17.00	132.00	67.00	33.00	8.30	23.40	M16	274 25.000
31.500	17.50	21.00	145.00	76.50	38.00	10.35	29.35	M20	274 31.500
40.000	21.00	25.00	160.00	90.00	45.00	12.00	36.50	M24	274 40.000

Stepped drills for centring according to DIN 332

Article no. **574**



Cutting data page 482



Web thinning $\geq \varnothing 8.000$ • web thinning value refers to nom.- $\varnothing d1$ • relieved cone • shank with flat • 60° countersink angle • for centre holes to DIN 332, sheet 2, form DR • application on centring/cut-off machines

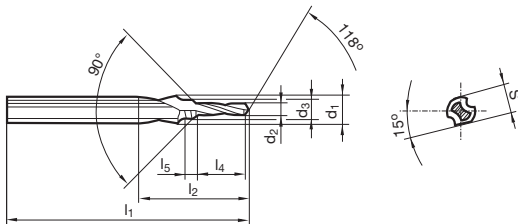

Article no.

574

d1 h7 mm	d2 h8 mm	d3 mm	l1 mm	l2 mm	l4 mm	l5 mm	S mm	for thread	Order no.
8.000	3.30	4.30	63.00	23.00	11.00	1.60	6.75	M 4	574 8.000
10.000	4.20	5.30	67.00	27.00	13.00	2.15	8.45	M 5	574 10.000
12.500	5.00	6.40	71.00	33.00	16.00	2.90	10.45	M 6	574 12.500
14.000	6.80	8.40	88.00	41.00	19.50	3.50	12.50	M 8	574 14.000
16.000	8.50	10.50	94.00	47.00	23.00	4.70	14.85	M10	574 16.000
20.000	10.20	13.00	105.00	59.00	28.00	6.50	18.45	M12	574 20.000
25.000	14.00	17.00	132.00	67.00	33.00	8.30	23.40	M16	574 25.000
31.500	17.50	21.00	145.00	76.50	38.00	10.35	29.35	M20	574 31.500
40.000	21.00	25.00	160.00	90.00	45.00	12.00	36.50	M24	574 40.000



Stepped drills for centring according to DIN 332

Article no. 575

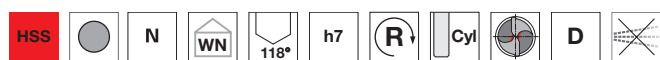

Cutting data page 482

P	M	K	N	S	H
●	○	●	○	○	○

Web thinning $\geq \varnothing 8.000$ • web thinning value refers to nom.- $\varnothing d1$ • relieved cone • 60° countersink angle • for tapping size holes with centering to DIN 332, sheet 2, form D

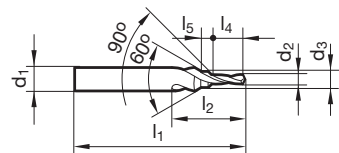

Article no. 575

d1 h7 mm	d2 h8 mm	d3 mm	l1 mm	l2 mm	l4 mm	l5 mm	for thread	Order no.
8.000	3.30	4.30	63.00	23.00	11.00	1.60	M 4	575 8.000
10.000	4.20	5.30	67.00	27.00	13.00	2.15	M 5	575 10.000
12.500	5.00	6.40	71.00	33.00	16.00	2.90	M 6	575 12.500
14.000	6.80	8.40	88.00	41.00	19.50	3.50	M 8	575 14.000
16.000	8.50	10.50	94.00	47.00	23.00	4.70	M10	575 16.000
20.000	10.20	13.00	105.00	59.00	28.00	6.50	M12	575 20.000

Stepped drills for centring according to DIN 332

Article no. 576



Cutting data page 482

P	M	K	N	S	H
●	○	●	○	○	○

Web thinning $\geq \varnothing 14.000$ • web thinning value refers to nom.- $\varnothing d1$ • relieved cone • 60° countersink angle • for tapping size holes with centering to DIN 332, sheet 2, form D

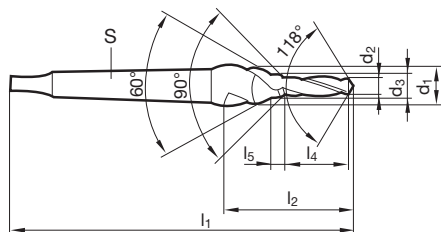

Article no. 576

d1 h7 mm	d2 h8 mm	d3 mm	l1 mm	l2 mm	l4 mm	l5 mm	for thread	Order no.
14.000	6.80	8.40	110.00	41.00	19.50	3.50	M 8	576 14.000
16.000	8.50	10.50	131.00	47.00	23.00	4.70	M10	576 16.000
20.000	10.20	13.00	145.00	59.00	28.00	6.50	M12	576 20.000
25.000	14.00	17.00	172.00	67.00	33.00	8.30	M16	576 25.000
31.500	17.50	21.00	184.00	76.50	38.00	10.35	M20	576 31.500
40.000	21.00	25.00	222.00	90.00	45.00	12.00	M24	576 40.000



Step drills

Step drills/Core drills

Straight shank short step drills with straight shank

Article no. **378**



Cutting data page 482



P	M	K	N	S	H
●	○	●	●	○	

Web thinning $\geq \varnothing 6.000$ • web thinning value refers to nom.- $\varnothing d1$ • relieved cone • very high torsional stability • for CNC- and NC machines • for through-holes to DIN EN 20273, fine series • for 90° screwhead countersinks to DIN 74, form A • f dependent on small diameter • vc dependent on large diameter

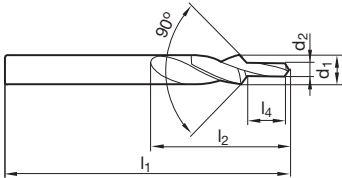

Article no. **378**

d1 mm	d2 h6 mm	l1 mm	l2 mm	l4 mm	for thread	Order no.
6.000	3.20	66.00	28.00	9.00	M 3	378 6.000
8.000	4.30	79.00	37.00	11.00	M 4	378 8.000
10.000	5.30	89.00	43.00	13.00	M 5	378 10.000
11.500	6.40	95.00	47.00	15.00	M 6	378 11.500
15.000	8.40	111.00	56.00	19.00	M 8	378 15.000
19.000	10.50	127.00	64.00	23.00	M10	378 19.000

Straight shank short step drills with straight shank

Article no. **238**



Cutting data page 482



P	M	K	N	S	H
●	○	●	●	●	

Web thinning $\geq \varnothing 6.000$ • web thinning value refers to nom.- $\varnothing d1$ • with universal TiN-coating for higher wear resistance and higher tool life • relieved cone • very high torsional stability • for CNC- and NC machines • for through-holes to DIN EN 20273, fine series • for 90° screwhead countersinks to DIN 74, form A • f dependent on small diameter • vc dependent on large diameter

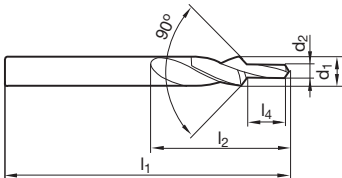

Article no. **238**

d1 mm	d2 h6 mm	l1 mm	l2 mm	l4 mm	for thread	Order no.
6.000	3.20	66.00	28.00	9.00	M 3	238 6.000
8.000	4.30	79.00	37.00	11.00	M 4	238 8.000
10.000	5.30	89.00	43.00	13.00	M 5	238 10.000
11.500	6.40	95.00	47.00	15.00	M 6	238 11.500
15.000	8.40	111.00	56.00	19.00	M 8	238 15.000
19.000	10.50	127.00	64.00	23.00	M10	238 19.000



Straight shank short step drills with straight shank

Article no. 1147



Cutting data page 482



P	M	K	N	S	H
•	○	•	•	○	

Web thinning $\geq \varnothing 6.600$ • web thinning value refers to nom.- $\varnothing d1$ • relieved cone • very high torsional stability • for CNC- and NC machines • for through-holes to DIN EN 20273, series medium • for 90° screwhead countersinks to DIN 74, form A • f dependent on small diameter • vc dependent on large diameter

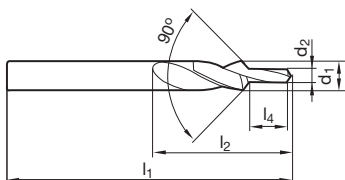

Article no.

1147

d1 mm	d2 h6 mm	l1 mm	l2 mm	l4 mm	for thread	Order no.
6.600	3.40	70.00	31.00	9.00	M 3	1147 6.600
9.000	4.50	84.00	40.00	11.00	M 4	1147 9.000
11.000	5.50	95.00	47.00	13.00	M 5	1147 11.000
13.000	6.60	102.00	51.00	15.00	M 6	1147 13.000
17.200	9.00	123.00	62.00	19.00	M 8	1147 17.200
21.500	11.00	141.00	70.00	23.00	M10	1147 21.500

Step drills/Core drills



Straight shank short step drills with straight shank

Article no. **379**



Cutting data page 482



P	M	K	N	S	H
●	○	●	●	○	○

Web thinning $\geq \varnothing 6.000$ • web thinning value refers to nom.- $\varnothing d1$ • relieved cone • very high torsional stability • for CNC- and NC machines • for through-holes to DIN EN 20273, series medium • for 180° countersink screw heads to DIN 974-1, series 1 • for screws DIN 6912, 7984, 34821, DIN EN ISO 1207, 4762, 14579, 14580 • f dependent on small diameter • vc dependent on large diameter

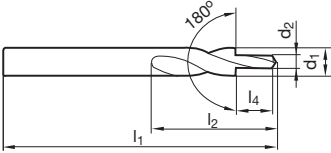

Article no.

379

d1 mm	d2 h6 mm	l1 mm	l2 mm	l4 mm	for thread	Order no.
6.000	3.40	66.00	28.00	9.00	M 3	379 6.000
8.000	4.50	79.00	37.00	11.00	M 4	379 8.000
10.000	5.50	89.00	43.00	13.00	M 5	379 10.000
11.000	6.60	95.00	47.00	15.00	M 6	379 11.000
15.000	9.00	111.00	56.00	19.00	M 8	379 15.000
18.000	11.00	123.00	62.00	23.00	M10	379 18.000

Straight shank short step drills with straight shank

Article no. **249**



Cutting data page 482

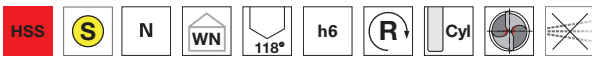

P	M	K	N	S	H
●	○	●	●	●	○

Web thinning $\geq \varnothing 6.000$ • web thinning value refers to nom.- $\varnothing d1$ • with universal TiN-coating • relieved cone • very high torsional stability • for CNC- and NC machines • for through-holes to DIN EN 20273, series medium • for 180° countersink screw heads to DIN 974-1, series 1 • for screws DIN 6912, 7984, 34821, DIN EN ISO 1207, 4762, 14579, 14580 • f dependent on small diameter • vc dependent on large diameter

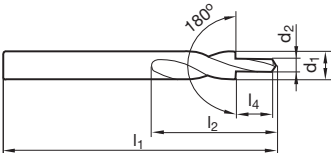

Article no.

249

d1 mm	d2 h6 mm	l1 mm	l2 mm	l4 mm	for thread	Order no.
6.000	3.40	66.00	28.00	9.00	M 3	249 6.000
8.000	4.50	79.00	37.00	11.00	M 4	249 8.000
10.000	5.50	89.00	43.00	13.00	M 5	249 10.000
11.000	6.60	95.00	47.00	15.00	M 6	249 11.000
15.000	9.00	111.00	56.00	19.00	M 8	249 15.000
18.000	11.00	123.00	62.00	23.00	M10	249 18.000



Straight shank short step drills with straight shank

Article no. 380



Cutting data page 482



Web thinning $\geq \varnothing 3.400$ • web thinning value refers to nom.- $\varnothing d1$ • relieved cone • very high torsional stability • for CNC- and NC machines • for tapped core holes according to DIN 336 • for countersinking 90° acc. to through holes to DIN EN 20273, series medium • f dependent on small diameter • vc dependent on large diameter

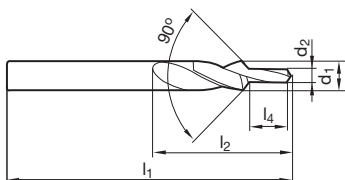

Article no. 380

d1 mm	d2 h6 mm	l1 mm	l2 mm	l4 mm	for thread	Order no.
3.400	2.50	52.00	20.00	8.80	M 3	380 3.400
4.500	3.30	58.00	24.00	11.40	M 4	380 4.500
5.500	4.20	66.00	28.00	13.60	M 5	380 5.500
6.600	5.00	70.00	31.00	16.50	M 6	380 6.600
9.000	6.80	84.00	40.00	21.00	M 8	380 9.000
11.000	8.50	95.00	47.00	25.50	M10	380 11.000
13.500	10.20	107.00	54.00	30.00	M12	380 13.500

Straight shank short step drills with straight shank

Article no. 250



Cutting data page 482



Web thinning $\geq \varnothing 3.400$ • web thinning value refers to nom.- $\varnothing d1$ • with universal TiN-coating • relieved cone • very high torsional stability • for CNC- and NC machines • for tapped core holes according to DIN 336 • for countersinking 90° acc. to through holes to DIN EN 20273, series medium • f dependent on small diameter • vc dependent on large diameter

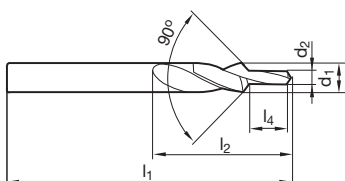

Article no. 250

d1 mm	d2 h6 mm	l1 mm	l2 mm	l4 mm	for thread	Order no.
3.400	2.50	52.00	20.00	8.80	M 3	250 3.400
4.500	3.30	58.00	24.00	11.40	M 4	250 4.500
5.500	4.20	66.00	28.00	13.60	M 5	250 5.500
6.600	5.00	70.00	31.00	16.50	M 6	250 6.600
9.000	6.80	84.00	40.00	21.00	M 8	250 9.000
11.000	8.50	95.00	47.00	25.50	M10	250 11.000
13.500	10.20	107.00	54.00	30.00	M12	250 13.500



Step drills

Step drills/Core drills

Straight shank subland drills

Article no. **536**



Cutting data page 482

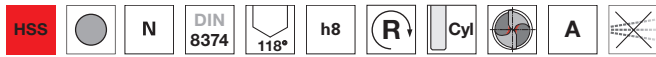

Web thinning $\geq \varnothing 6.000$ • web thinning value refers to nom.- $\varnothing d1$ • relieved cone • for through-holes to DIN EN 20273, fine series • for screw head counterbores 90° • f dependent on small diameter • vc dependent on large diameter

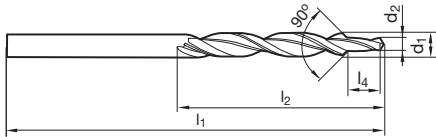

Article no. **536**

d1 h8 mm	d2 h9 mm	l1 mm	l2 mm	l4 mm	for thread	Order no.
6.000	3.20	93.00	57.00	9.00	M 3	536 6.000
8.000	4.30	117.00	75.00	11.00	M 4	536 8.000
10.000	5.30	133.00	87.00	13.00	M 5	536 10.000
11.500	6.40	142.00	94.00	15.00	M 6	536 11.500
15.000	8.40	169.00	114.00	19.00	M 8	536 15.000
19.000	10.50	198.00	135.00	23.00	M10	536 19.000

Straight shank subland drills

Article no. **636**



Cutting data page 482



Web thinning $\geq \varnothing 6.600$ • web thinning value refers to nom.- $\varnothing d1$ • relieved cone • for through-holes to DIN EN 20273, series medium • for screw head counterbores 90° to DIN 74 Part 1 (edition 12.1980 withdrawn), form A and B, medium design • f dependent on small diameter • vc dependent on large diameter

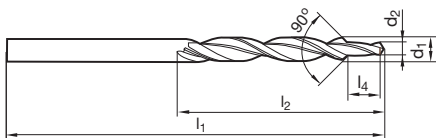

Article no. **636**

d1 h8 mm	d2 h9 mm	l1 mm	l2 mm	l4 mm	for thread	Order no.
6.600	3.40	101.00	63.00	9.00	M 3	636 6.600
9.000	4.50	125.00	81.00	11.00	M 4	636 9.000
11.000	5.50	142.00	94.00	13.00	M 5	636 11.000
13.000	6.60	151.00	101.00	15.00	M 6	636 13.000
17.200	9.00	191.00	130.00	19.00	M 8	636 17.200



Straight shank subland drills

Article no. 538

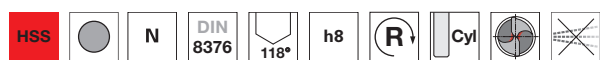

Cutting data page 482



Web thinning $\geq \varnothing 6.000$ • web thinning value refers to nom.- $\varnothing d_1$ • relieved cone • for through-holes to DIN EN 20273, series medium • for 180° countersink screw heads to DIN 974-1, series 1 • for screws DIN 6912, 7984, 34821, DIN EN ISO 1207, 4762, 14579, 14580 and DIN 7513, 7516, 7500-1 • f dependent on small diameter • vc dependent on large diameter

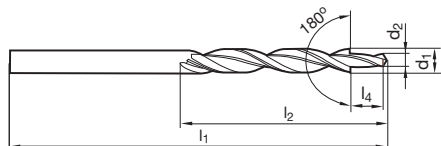

Article no. 538

d1 h8 mm	d2 h9 mm	l1 mm	l2 mm	l4 mm	for thread	Order no.
6.000	3.40	93.00	57.00	9.00	M 3	538 6.000
6.500	3.40	101.00	63.00	9.00	M 3	538 6.500
8.000	4.50	117.00	75.00	11.00	M 4	538 8.000
10.000	5.50	133.00	87.00	13.00	M 5	538 10.000
11.000	6.60	142.00	94.00	15.00	M 6	538 11.000
15.000	9.00	169.00	114.00	19.00	M 8	538 15.000
18.000	11.00	191.00	130.00	23.00	M10	538 18.000

Straight shank subland drills

Article no. 514



Cutting data page 482



Web thinning $\geq \varnothing 5.900$ • web thinning value refers to nom.- $\varnothing d_1$ • relieved cone • for through-holes with old countersinks form H, J, K to DIN 75 part 2 (issue 04.1968 retracted), medium and fine design • for screws to DIN 84, 912, 6912 • f dependent on small diameter • vc dependent on large diameter

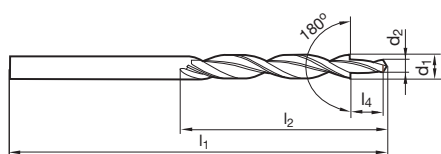

Article no. 514

d1 h8 mm	d2 h9 mm	l1 mm	l2 mm	l4 mm	for thread	Order no.
5.900	3.20	93.00	57.00	11.00	M 3	514 5.900
7.400	4.30	109.00	69.00	13.00	M 4	514 7.400
8.000	4.80	117.00	75.00	13.00	M 4	514 8.000
9.400	5.30	125.00	81.00	16.00	M 5	514 9.400
10.000	5.80	133.00	87.00	16.00	M 5	514 10.000
10.400	6.40	133.00	87.00	19.00	M 6	514 10.400
11.000	7.00	142.00	94.00	19.00	M 6	514 11.000
13.500	8.40	160.00	108.00	22.00	M 8	514 13.500
16.500	10.50	184.00	125.00	25.00	M10	514 16.500
17.500	11.50	191.00	130.00	25.00	M10	514 17.500



Step drills

Step drills/Core drills

Straight shank subland drills

Article no. **540**



Cutting data page 482



Web thinning $\geq \varnothing 3.400$ • web thinning value refers to nom.- $\varnothing d1$ • relieved cone • for tapped core holes according to DIN 336 • for countersinking 90° acc. to through holes to DIN EN 20273, series medium • f dependent on small diameter • vc dependent on large diameter

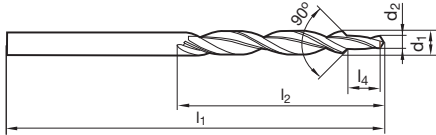

Article no.

540

d1 h8 mm	d2 h9 mm	l1 mm	l2 mm	l4 mm	for thread	Order no.
3.400	2.50	70.00	39.00	8.80	M 3	540 3.400
4.500	3.30	80.00	47.00	11.40	M 4	540 4.500
5.500	4.20	93.00	57.00	13.60	M 5	540 5.500
6.600	5.00	101.00	63.00	16.50	M 6	540 6.600
9.000	6.80	125.00	81.00	21.00	M 8	540 9.000
11.000	8.50	142.00	94.00	25.50	M10	540 11.000
13.500	10.20	160.00	108.00	30.00	M12	540 13.500



Taper shank subland drills

Article no. 539



Cutting data page 482

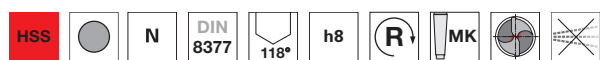

Web thinning $\geq \varnothing 10.000$ • web thinning value refers to nom.- $\varnothing d_1$ • relieved cone • for through-holes to DIN EN 20273, series medium • for 180° countersink screw heads to DIN 974-1, series 1 • for screws DIN 6912, 7984, 34821, DIN EN ISO 1207, 4762, 14579, 14580 and DIN 7513, 7516, 7500-1 • f dependent on small diameter • vc dependent on large diameter

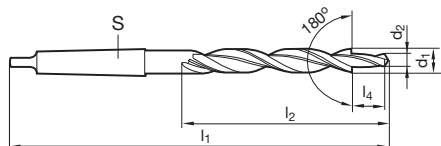

Article no. 539

d1 h8 mm	d2 h9 mm	S	l1 mm	l2 mm	l4 mm	for thread	Order no.
10.000	5.50	MK-1	168.00	87.00	13.00	M 5	539 10.000
11.000	6.60	MK-1	175.00	94.00	15.00	M 6	539 11.000
15.000	9.00	MK-2	212.00	114.00	19.00	M 8	539 15.000
18.000	11.00	MK-2	228.00	130.00	23.00	M10	539 18.000
20.000	13.50	MK-2	238.00	140.00	27.00	M12	539 20.000
24.000	15.50	MK-3	281.00	160.00	31.00	M14	539 24.000
26.000	17.50	MK-3	286.00	165.00	35.00	M16	539 26.000
30.000	20.00	MK-3	296.00	175.00	39.00	M18	539 30.000
33.000	22.00	MK-4	334.00	185.00	43.00	M20	539 33.000

Taper shank subland drills

Article no. 541



Cutting data page 482



Web thinning $\geq \varnothing 9.000$ • web thinning value refers to nom.- $\varnothing d_1$ • relieved cone • for tapped core holes according to DIN 336 • for countersinking 90° acc. to through holes to DIN EN 20273, series medium • f dependent on small diameter • vc dependent on large diameter

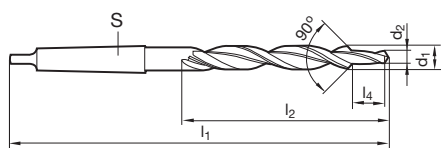

Article no. 541

d1 h8 mm	d2 h9 mm	S	l1 mm	l2 mm	l4 mm	for thread	Order no.
9.000	6.80	MK-1	162.00	81.00	21.00	M 8	541 9.000
11.000	8.50	MK-1	175.00	94.00	25.50	M10	541 11.000
13.500	10.20	MK-1	189.00	108.00	30.00	M12	541 13.500
15.500	12.00	MK-2	218.00	120.00	34.50	M14	541 15.500
17.500	14.00	MK-2	228.00	130.00	38.50	M16	541 17.500
20.000	15.50	MK-2	238.00	140.00	43.50	M18	541 20.000
22.000	17.50	MK-2	248.00	150.00	47.50	M20	541 22.000



Straight shank core drills

Article no. **533**



Cutting data page 483

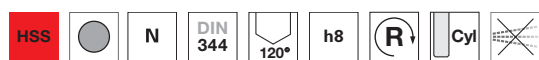

relieved cone • especially high rigidity • for pre-drilled/pre-cast/pre-punched holes • with tang to DIN 1809 • corrects alignment inaccuracies • corrects circularity errors • improves surface quality of hole • chamfer dia. < tapping size hole • observe min. pilot hole diameter "d0" • perfect finish reaming after core drilling

P	M	K	N	S	H
●	○	●	○	○	

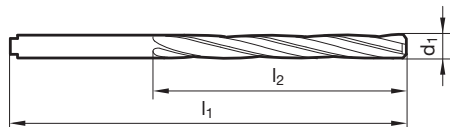

Article no. 533				Article no. 533					
d1 mm	l1 mm	l2 mm	d0 ≥ mm	Order no.	d1 mm	l1 mm	l2 mm	d0 ≥ mm	Order no.
3.800	96.0	64.0	2.8	533 3.800	8.800	151.0	107.0	6.3	533 8.800
4.000	96.0	64.0	2.8	533 4.000	8.850	151.0	107.0	6.3	533 8.850
4.100	96.0	64.0	2.8	533 4.100	9.000	151.0	107.0	6.3	533 9.000
4.400	102.0	69.0	3.2	533 4.400	9.100	151.0	107.0	6.3	533 9.100
4.500	102.0	69.0	3.2	533 4.500	9.200	151.0	107.0	6.3	533 9.200
4.600	102.0	69.0	3.2	533 4.600	9.250	151.0	107.0	6.3	533 9.250
4.750	102.0	69.0	3.2	533 4.750	9.300	151.0	107.0	6.3	533 9.300
4.800	108.0	74.0	3.5	533 4.800	9.400	151.0	107.0	6.3	533 9.400
4.900	108.0	74.0	3.5	533 4.900	9.500	151.0	107.0	6.3	533 9.500
5.000	108.0	74.0	3.5	533 5.000	9.600	162.0	116.0	7.0	533 9.600
5.050	108.0	74.0	3.5	533 5.050	9.650	162.0	116.0	7.0	533 9.650
5.100	108.0	74.0	3.5	533 5.100	9.800	162.0	116.0	7.0	533 9.800
5.300	108.0	74.0	3.5	533 5.300	10.000	162.0	116.0	7.0	533 10.000
5.400	116.0	80.0	4.2	533 5.400	10.100	162.0	116.0	7.0	533 10.100
5.500	116.0	80.0	4.2	533 5.500	10.200	162.0	116.0	7.0	533 10.200
5.550	116.0	80.0	4.2	533 5.550	10.300	162.0	116.0	7.0	533 10.300
5.750	116.0	80.0	4.2	533 5.750	10.500	162.0	116.0	7.0	533 10.500
5.800	116.0	80.0	4.2	533 5.800	10.600	162.0	116.0	7.0	533 10.600
5.850	116.0	80.0	4.2	533 5.850	10.700	173.0	125.0	7.7	533 10.700
5.900	116.0	80.0	4.2	533 5.900	10.750	173.0	125.0	7.7	533 10.750
6.000	116.0	80.0	4.2	533 6.000	10.800	173.0	125.0	7.7	533 10.800
6.100	124.0	86.0	4.2	533 6.100	11.000	173.0	125.0	7.7	533 11.000
6.200	124.0	86.0	4.2	533 6.200	11.250	173.0	125.0	7.7	533 11.250
6.300	124.0	86.0	4.2	533 6.300	11.300	173.0	125.0	7.7	533 11.300
6.400	124.0	86.0	4.2	533 6.400	11.750	184.0	134.0	8.4	533 11.750
6.500	124.0	86.0	4.2	533 6.500	11.800	184.0	134.0	8.4	533 11.800
6.700	124.0	86.0	4.2	533 6.700	12.000	184.0	134.0	8.4	533 12.000
6.800	133.0	93.0	4.9	533 6.800	12.200	184.0	134.0	8.4	533 12.200
7.000	133.0	93.0	4.9	533 7.000	12.300	184.0	134.0	8.4	533 12.300
7.150	133.0	93.0	4.9	533 7.150	12.500	184.0	134.0	8.4	533 12.500
7.200	133.0	93.0	4.9	533 7.200	12.750	184.0	134.0	9.1	533 12.750
7.250	133.0	93.0	4.9	533 7.250	13.000	184.0	134.0	9.1	533 13.000
7.500	133.0	93.0	4.9	533 7.500	13.100	184.0	134.0	9.1	533 13.100
7.600	142.0	100.0	5.6	533 7.600	13.500	194.0	142.0	9.8	533 13.500
7.700	142.0	100.0	5.6	533 7.700	13.750	194.0	142.0	9.8	533 13.750
7.750	142.0	100.0	5.6	533 7.750	14.000	194.0	142.0	9.8	533 14.000
7.800	142.0	100.0	5.6	533 7.800	14.750	202.0	147.0	10.5	533 14.750
7.950	142.0	100.0	5.6	533 7.950	15.000	202.0	147.0	10.5	533 15.000
8.000	142.0	100.0	5.6	533 8.000	15.750	211.0	153.0	11.2	533 15.750
8.050	142.0	100.0	5.6	533 8.050	16.000	211.0	153.0	11.2	533 16.000
8.100	142.0	100.0	5.6	533 8.100	16.750	218.0	159.0	11.9	533 16.750
8.200	142.0	100.0	5.6	533 8.200	17.000	218.0	159.0	11.9	533 17.000
8.250	142.0	100.0	5.6	533 8.250	18.000	226.0	165.0	12.6	533 18.000
8.300	142.0	100.0	5.6	533 8.300	20.000	242.0	177.0	14.0	533 20.000
8.400	142.0	100.0	5.6	533 8.400					
8.500	142.0	100.0	5.6	533 8.500					
8.600	151.0	107.0	6.3	533 8.600					
8.700	151.0	107.0	6.3	533 8.700					



Taper shank core drills

Article no. 534



Cutting data page 483



relieved cone • especially high rigidity • for pre-drilled/pre-cast/pre-punched holes • corrects alignment inaccuracies
 • corrects circularity errors • improves surface quality of hole • chamfer dia. < tapping size hole • observe min. pilot hole diameter "d0" • perfect finish reaming after core drilling

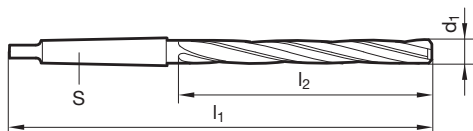

Article no. 534

Article no. 534

d1 mm	S	l1 mm	l2 mm	d0 ≥ mm	Order no.	d1 mm	S	l1 mm	l2 mm	d0 ≥ mm	Order no.
7.800	MK-1	156.0	75.0	5.6	534 7.800	21.700	MK-2	248.0	150.0	15.3	534 21.700
8.000	MK-1	156.0	75.0	5.6	534 8.000	21.750	MK-2	248.0	150.0	15.3	534 21.750
8.800	MK-1	162.0	81.0	6.3	534 8.800	22.000	MK-2	248.0	150.0	15.3	534 22.000
9.000	MK-1	162.0	81.0	6.3	534 9.000	22.250	MK-2	248.0	150.0	15.3	534 22.250
9.700	MK-1	168.0	87.0	7.0	534 9.700	22.500	MK-2	253.0	155.0	16.0	534 22.500
9.800	MK-1	168.0	87.0	7.0	534 9.800	22.700	MK-2	253.0	155.0	16.0	534 22.700
9.900	MK-1	168.0	87.0	7.0	534 9.900	22.750	MK-2	253.0	155.0	16.0	534 22.750
10.000	MK-1	168.0	87.0	7.0	534 10.000	23.000	MK-2	253.0	155.0	16.0	534 23.000
10.100	MK-1	168.0	87.0	7.0	534 10.100	23.500	MK-2	253.0	155.0	16.0	534 23.500
10.200	MK-1	168.0	87.0	7.0	534 10.200	23.700	MK-3	281.0	160.0	16.6	534 23.700
10.750	MK-1	175.0	94.0	7.7	534 10.750	24.000	MK-3	281.0	160.0	16.6	534 24.000
11.000	MK-1	175.0	94.0	7.7	534 11.000	24.200	MK-3	281.0	160.0	16.6	534 24.200
11.100	MK-1	175.0	94.0	7.7	534 11.100	24.500	MK-3	281.0	160.0	17.3	534 24.500
11.250	MK-1	175.0	94.0	7.7	534 11.250	24.700	MK-3	281.0	160.0	17.3	534 24.700
11.500	MK-1	175.0	94.0	7.7	534 11.500	24.750	MK-3	281.0	160.0	17.3	534 24.750
11.750	MK-1	182.0	101.0	8.4	534 11.750	25.000	MK-3	281.0	160.0	17.3	534 25.000
11.800	MK-1	182.0	101.0	8.4	534 11.800	25.250	MK-3	286.0	165.0	18.0	534 25.250
12.000	MK-1	182.0	101.0	8.4	534 12.000	25.500	MK-3	286.0	165.0	18.0	534 25.500
12.100	MK-1	182.0	101.0	8.4	534 12.100	25.600	MK-3	286.0	165.0	18.0	534 25.600
12.200	MK-1	182.0	101.0	8.4	534 12.200	25.700	MK-3	286.0	165.0	18.0	534 25.700
12.300	MK-1	182.0	101.0	8.4	534 12.300	26.000	MK-3	286.0	165.0	18.0	534 26.000
12.500	MK-1	182.0	101.0	8.4	534 12.500	26.500	MK-3	286.0	165.0	18.0	534 26.500
12.700	MK-1	182.0	101.0	9.1	534 12.700	26.700	MK-3	291.0	170.0	18.6	534 26.700
12.750	MK-1	182.0	101.0	9.1	534 12.750	27.000	MK-3	291.0	170.0	18.6	534 27.000
13.000	MK-1	182.0	101.0	9.1	534 13.000	27.500	MK-3	291.0	170.0	18.6	534 27.500
13.250	MK-1	189.0	108.0	9.8	534 13.250	27.700	MK-3	291.0	170.0	19.3	534 27.700
13.500	MK-1	189.0	108.0	9.8	534 13.500	28.000	MK-3	291.0	170.0	19.3	534 28.000
13.750	MK-1	189.0	108.0	9.8	534 13.750	28.700	MK-3	296.0	175.0	20.0	534 28.700
13.800	MK-1	189.0	108.0	9.8	534 13.800	29.000	MK-3	296.0	175.0	20.0	534 29.000
14.000	MK-1	189.0	108.0	9.8	534 14.000	29.500	MK-3	296.0	175.0	20.5	534 29.500
14.100	MK-2	212.0	114.0	10.5	534 14.100	29.700	MK-3	296.0	175.0	20.5	534 29.700
14.500	MK-2	212.0	114.0	10.5	534 14.500	29.750	MK-3	296.0	175.0	20.5	534 29.750
14.750	MK-2	212.0	114.0	10.5	534 14.750	30.000	MK-3	296.0	175.0	20.5	534 30.000
15.000	MK-2	212.0	114.0	10.5	534 15.000	30.500	MK-3	301.0	180.0	21.0	534 30.500
15.250	MK-2	218.0	120.0	11.2	534 15.250	30.600	MK-3	301.0	180.0	21.0	534 30.600
15.500	MK-2	218.0	120.0	11.2	534 15.500	31.000	MK-3	301.0	180.0	21.0	534 31.000
15.600	MK-2	218.0	120.0	11.2	534 15.600	31.500	MK-3	301.0	180.0	21.0	534 31.500
15.750	MK-2	218.0	120.0	11.2	534 15.750	31.600	MK-4	334.0	185.0	22.0	534 31.600
15.900	MK-2	218.0	120.0	11.2	534 15.900	32.000	MK-4	334.0	185.0	22.0	534 32.000
16.000	MK-2	218.0	120.0	11.2	534 16.000	32.600	MK-4	334.0	185.0	23.0	534 32.600
16.150	MK-2	223.0	125.0	11.9	534 16.150	33.000	MK-4	334.0	185.0	23.0	534 33.000
16.200	MK-2	223.0	125.0	11.9	534 16.200	33.600	MK-4	339.0	190.0	24.0	534 33.600
16.250	MK-2	223.0	125.0	11.9	534 16.250	34.000	MK-4	339.0	190.0	24.0	534 34.000
16.500	MK-2	223.0	125.0	11.9	534 16.500	34.600	MK-4	339.0	190.0	25.0	534 34.600
16.750	MK-2	223.0	125.0	11.9	534 16.750	35.000	MK-4	339.0	190.0	25.0	534 35.000
17.000	MK-2	223.0	125.0	11.9	534 17.000	35.600	MK-4	344.0	195.0	25.5	534 35.600
17.500	MK-2	228.0	130.0	12.6	534 17.500	36.000	MK-4	344.0	195.0	25.5	534 36.000
17.750	MK-2	228.0	130.0	12.6	534 17.750	36.600	MK-4	344.0	195.0	26.0	534 36.600
18.000	MK-2	228.0	130.0	12.6	534 18.000	37.600	MK-4	349.0	200.0	26.5	534 37.600
18.100	MK-2	233.0	135.0	13.3	534 18.100	38.000	MK-4	349.0	200.0	26.5	534 38.000
18.250	MK-2	233.0	135.0	13.3	534 18.250	39.000	MK-4	349.0	200.0	27.0	534 39.000
18.500	MK-2	233.0	135.0	13.3	534 18.500	39.600	MK-4	349.0	200.0	28.0	534 39.600
18.700	MK-2	233.0	135.0	13.3	534 18.700	40.000	MK-4	349.0	200.0	28.0	534 40.000
18.750	MK-2	233.0	135.0	13.3	534 18.750	44.000	MK-4	359.0	210.0	30.5	534 44.000
19.000	MK-2	233.0	135.0	13.3	534 19.000	44.600	MK-4	359.0	210.0	31.0	534 44.600
19.250	MK-2	238.0	140.0	14.0	534 19.250	45.000	MK-4	359.0	210.0	31.0	534 45.000
19.500	MK-2	238.0	140.0	14.0	534 19.500	50.000	MK-4	369.0	220.0	34.5	534 50.000
19.700	MK-2	238.0	140.0	14.0	534 19.700						
19.750	MK-2	238.0	140.0	14.0	534 19.750						
20.000	MK-2	238.0	140.0	14.0	534 20.000						
20.200	MK-2	243.0	145.0	14.6	534 20.200						
20.250	MK-2	243.0	145.0	14.6	534 20.250						
20.500	MK-2	243.0	145.0	14.6	534 20.500						
20.700	MK-2	243.0	145.0	14.6	534 20.700						
21.000	MK-2	243.0	145.0	14.6	534 21.000						
21.500	MK-2	248.0	150.0	15.3	534 21.500						

Step drills/Core drills



Taper shank core drills

Article no. **555**



Cutting data page 483

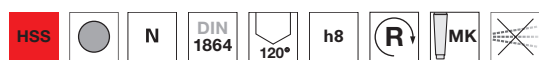

P	M	K	N	S	H
●	○	●	○	○	

relieved cone • especially high rigidity • for pre-drilled/pre-cast/pre-punched holes • corrects alignment inaccuracies
 • corrects circularity errors • improves surface quality of hole • chamfer dia. < tapping size hole • observe min. pilot hole diameter "d0" • perfect finish reaming after core drilling

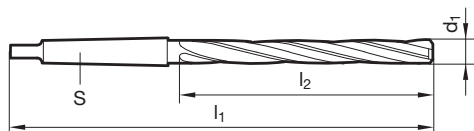

Article no. **555**

d1 mm	S	l1 mm	l2 mm	d0 ≥ mm	Order no.
7.800	MK-1	181.0	100.0	5.6	555 7.800
8.000	MK-1	181.0	100.0	5.6	555 8.000
8.800	MK-1	188.0	107.0	6.3	555 8.800
9.000	MK-1	188.0	107.0	6.3	555 9.000
9.700	MK-1	197.0	116.0	7.0	555 9.700
9.800	MK-1	197.0	116.0	7.0	555 9.800
10.000	MK-1	197.0	116.0	7.0	555 10.000
10.100	MK-1	197.0	116.0	7.0	555 10.100
10.500	MK-1	197.0	116.0	7.0	555 10.500
11.750	MK-1	215.0	134.0	8.4	555 11.750
12.000	MK-1	215.0	134.0	8.4	555 12.000
12.750	MK-1	215.0	134.0	9.1	555 12.750
13.000	MK-1	215.0	134.0	9.1	555 13.000
13.750	MK-1	223.0	142.0	9.8	555 13.750
14.000	MK-1	223.0	142.0	9.8	555 14.000
15.000	MK-2	245.0	147.0	10.5	555 15.000
15.750	MK-2	251.0	153.0	11.2	555 15.750
16.000	MK-2	251.0	153.0	11.2	555 16.000

Article no. **555**

d1 mm	S	l1 mm	l2 mm	d0 ≥ mm	Order no.
17.750	MK-2	263.0	165.0	12.6	555 17.750
19.000	MK-2	269.0	171.0	13.3	555 19.000
19.700	MK-2	275.0	177.0	14.0	555 19.700
20.000	MK-2	275.0	177.0	14.0	555 20.000
20.700	MK-2	282.0	184.0	14.6	555 20.700
21.700	MK-2	289.0	191.0	15.3	555 21.700
22.000	MK-2	289.0	191.0	15.3	555 22.000
23.000	MK-2	296.0	198.0	16.0	555 23.000
24.000	MK-3	327.0	206.0	16.6	555 24.000
25.000	MK-3	327.0	206.0	17.3	555 25.000
25.700	MK-3	335.0	214.0	18.0	555 25.700
30.000	MK-3	351.0	230.0	20.5	555 30.000



Taper pin drills

Article no. **531**



Cutting data page 484

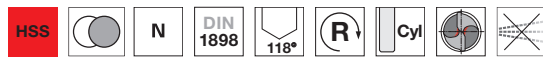

Web thinning $\geq \varnothing 1.000$ • relieved cone • for tapered holes for holding taper pins to DIN 1 (new: DIN EN 22339) and DIN 7978 (new: DIN EN 28736) • with tang

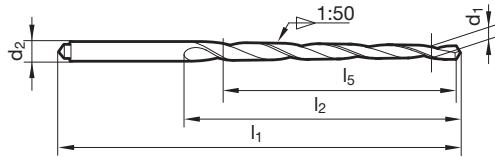

Article no. **531**

d1 mm	d2 mm	l1 mm	l2 mm	l5 mm	Order no.
1.500	2.00	64	39	34	531 1.500
2.000	3.15	86	52	48	531 2.000
2.500	3.15	86	52	48	531 2.500
3.000	4.00	100	63	58	531 3.000
3.500	5.00	112	74	68	531 3.500
4.000	5.00	112	74	68	531 4.000
4.500	6.30	122	81	73	531 4.500
5.000	6.30	122	81	73	531 5.000
6.000	8.00	160	114	105	531 6.000
6.500	10.00	207	157	145	531 6.500
8.000	10.00	207	157	145	531 8.000
10.000	12.50	245	190	175	531 10.000

Article no. **531**

d1 mm	d2 mm	l1 mm	l2 mm	l5 mm	Order no.
12.000	16.00	290	228	210	531 12.000

Taper pin drills

Article no. **532**



Cutting data page 484



Web thinning $\geq \varnothing 5.000$ • relieved cone • for tapered holes for holding taper pins to DIN 1 (new: DIN EN 22339, DIN 7978 (new: DIN EN 28736), DIN 7977 (new: DIN EN 28737) and DIN 258

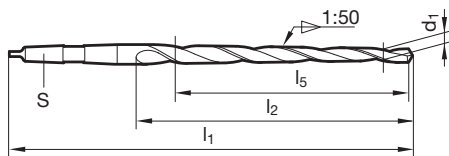

Article no. **532**

d1 mm	S	l1 mm	l2 mm	l5 mm	Order no.
5.000	MK-1	155.0	81.0	73.0	532 5.000
6.000	MK-1	187.0	108.0	105.0	532 6.000
8.000	MK-1	227.0	149.0	145.0	532 8.000
10.000	MK-1	257.0	180.0	175.0	532 10.000
12.000	MK-2	315.0	219.0	210.0	532 12.000
13.000	MK-2	325.0	229.0	220.0	532 13.000

Article no. **532**

d1 mm	S	l1 mm	l2 mm	l5 mm	Order no.
14.000	MK-2	325.0	229.0	220.0	532 14.000
16.000	MK-2	335.0	239.0	230.0	532 16.000
20.000	MK-3	377.0	263.0	250.0	532 20.000
25.000	MK-3	427.0	311.0	300.0	532 25.000



ExclusiveLine micro-precision drills without/with coolant ducts, ≤ 7xD





Machining group			f (mm/rev) with nom. Ø									
			v _c (m/min)		0.5	0.8	1	1.2	1.5	2	2.5	3
P1.1.1 Unalloyed steel, annealed, 0.15 % C, Rm 420 N/mm ² , 125 HB	100	110	0.0400	0.0640	0.0800	0.0960	0.1200	0.1600	0.2000	0.2400		
P1.1.2 Unalloyed steel, heat-treated, 0.15 % C, Rm 420 N/mm ² , 125 HB	90	100	0.0360	0.0575	0.0720	0.0865	0.1080	0.1440	0.1800	0.2160		
P1.1.3 Unalloyed steel, annealed, 0.45 % C, Rm 640 N/mm ² , 190 HB	90	100	0.0360	0.0575	0.0720	0.0865	0.1080	0.1440	0.1800	0.2160		
P1.1.4 Unalloyed steel, heat-treated, 0.45 % C, Rm 640 N/mm ² , 190 HB	85	95	0.0340	0.0545	0.0680	0.0815	0.1020	0.1360	0.1700	0.2040		
P1.1.5 Unalloyed steel, heat-treated, 0.45 % C, Rm 850 N/mm ² , 250 HB	85	95	0.0340	0.0545	0.0680	0.0815	0.1020	0.1360	0.1700	0.2040		
P1.1.6 Unalloyed steel, annealed, 0.75 % C, Rm 915 N/mm ² , 270 HB	80	90	0.0320	0.0510	0.0640	0.0770	0.0960	0.1280	0.1600	0.1920		
P1.1.7 Unalloyed steel, heat-treated, 0.75 % C, Rm 1020 N/mm ² , 300 HB	75	85	0.0300	0.0480	0.0600	0.0720	0.0900	0.1200	0.1500	0.1800		
P2.1.1 Low-alloy steel, annealed, Rm 610 N/mm ² , 180 HB	80	90	0.0350	0.0560	0.0700	0.0840	0.1050	0.1400	0.1750	0.2100		
P2.1.2 Low-alloy steel, heat-treated, Rm 930 N/mm ² , 275 HB	80	90	0.0350	0.0560	0.0700	0.0840	0.1050	0.1400	0.1750	0.2100		
P2.1.3 Low-alloy steel, heat-treated, Rm 1020 N/mm ² , 300 HB	70	70	0.0300	0.0475	0.0595	0.0715	0.0895	0.1190	0.1490	0.1785		
P2.1.4 Low-alloy steel, heat-treated, Rm 1190 N/mm ² , 350 HB	60	60	0.0265	0.0420	0.0525	0.0630	0.0790	0.1050	0.1315	0.1575		
P3.1.1 High-alloy steel and tool steel, annealed, Rm 680 N/mm ² , 200 HB	45	45	0.0300	0.0480	0.0600	0.0720	0.0900	0.1200	0.1500	0.1800		
P3.1.2 High-alloy steel and tool steel, hardened and tempered, Rm 1100 N/mm ² , 325 HB	40	40	0.0255	0.0410	0.0510	0.0610	0.0765	0.1020	0.1275	0.1530		
M1.1.1 Stainless steel, ferritic/martensitic, with machining additives	30	70	0.0110	0.0175	0.0220	0.0265	0.0330	0.0440	0.0550	0.0660		
M1.1.2 Stainless steel, ferritic/martensitic, annealed, Rm 680 N/mm ² , 200 HB	25	65	0.0100	0.0160	0.0200	0.0240	0.0295	0.0395	0.0495	0.0595		
M1.1.3 Stainless steel, ferritic/martensitic, heat-treated, Rm 810 N/mm ² , 240 HB	25	60	0.0095	0.0150	0.0185	0.0225	0.0280	0.0375	0.0465	0.0560		
M2.1.1 Stainless steel, austenitic, quenched, 180 HB	15	60	0.0060	0.0095	0.0120	0.0145	0.0180	0.0240	0.0300	0.0360		
M2.2.1 Duplex steel, high-strength stainless steels	15	50	0.0050	0.0080	0.0100	0.0120	0.0155	0.0205	0.0255	0.0305		
K1.1.1 Grey cast iron, pearlitic/ferritic, 180 HB	130	150	0.0550	0.0880	0.1100	0.1320	0.1650	0.2200	0.2750	0.3300		
K1.1.2 Grey cast iron, pearlitic/martensitic, 260 HB	110	130	0.0470	0.0750	0.0935	0.1120	0.1400	0.1870	0.2340	0.2805		
K1.2.1 Cast iron with spheroidal graphite, ferritic, 160 HB	110	130	0.0470	0.0750	0.0935	0.1120	0.1400	0.1870	0.2340	0.2805		
K1.2.2 Cast iron with spheroidal graphite, pearlitic, 250 HB	105	120	0.0440	0.0705	0.0880	0.1055	0.1320	0.1760	0.2200	0.2640		
K1.3.1 Malleable cast iron, ferritic, 130 HB	105	120	0.0440	0.0705	0.0880	0.1055	0.1320	0.1760	0.2200	0.2640		
K1.3.2 Malleable cast iron, pearlitic, 230 HB	90	105	0.0385	0.0615	0.0770	0.0925	0.1155	0.1540	0.1925	0.2310		
K2.1.1 Vermicular graphite cast iron (GJV)												
K2.2.1 Austenitic-ferritic spheroidal graphite cast iron (ADI)												
N1.1.1 Wrought aluminium alloys, non-hardened, 60 HB	100	150	0.0550	0.0880	0.1100	0.1320	0.1650	0.2200	0.2750	0.3300		
N1.1.2 Wrought aluminium alloys, hardened, 100 HB	100	150	0.0550	0.0880	0.1100	0.1320	0.1650	0.2200	0.2750	0.3300		
N2.1.1 Aluminium casting alloys, non-hardened, ≤ 12 % Si, 75 HB	135	135	0.0210	0.0335	0.0420	0.0505	0.0630	0.0840	0.1050	0.1260		
N2.1.2 Aluminium casting alloys, hardened, ≤ 12 % Si, 90 HB	135	135	0.0210	0.0335	0.0420	0.0505	0.0630	0.0840	0.1050	0.1260		
N2.1.3 Aluminium casting alloys, non-hardened, > 12 % Si, 130 HB	115	115	0.0180	0.0285	0.0355	0.0430	0.0535	0.0715	0.0895	0.1070		
N3.1.1 Copper and copper alloys: Free-machining alloy, Pb > 1 %												
N3.1.2 Copper and copper alloys: CuZn, CuSnZn												
N3.1.3 Copper and copper alloys: CuSn, lead-free copper and copper electrolyte												
N4.1.1 Non-metallic materials: Duroplastics, fibre-reinforced plastics												
N4.1.2 Non-metallic materials: Hard rubber, wood, etc.												
N4.1.3 Non-metallic materials: Graphite												
S1.1.1 Heat-resistant alloys, Fe-based, annealed, 200 HB	20	35	0.0060	0.0095	0.0120	0.0145	0.0180	0.0240	0.0300	0.0360		
S1.1.2 Heat-resistant alloys, Fe-based, hardened, 280 HB	15	30	0.0050	0.0075	0.0095	0.0115	0.0145	0.0190	0.0240	0.0290		
S1.1.3 Heat-resistant alloys, Ni- or Co-based, annealed, 250 HB	15	30	0.0060	0.0095	0.0120	0.0145	0.0180	0.0240	0.0300	0.0360		
S1.1.4 Heat-resistant alloys, Ni- or Co-based, hardened, 350 HB	10	20	0.0040	0.0065	0.0085	0.0100	0.0125	0.0170	0.0210	0.0250		
S1.1.5 Heat-resistant alloys, Ni- or Co-based, cast, 320 HB	10	20	0.0040	0.0065	0.0085	0.0100	0.0125	0.0170	0.0210	0.0250		
S2.1.1 Titanium alloys, pure titanium, Rm 400 N/mm ²	15	35	0.0060	0.0095	0.0120	0.0145	0.0180	0.0240	0.0300	0.0360		
S2.1.2 Titanium alloys, Alpha and Beta alloys, hardened, Rm 1050 N/mm ²	10	25	0.0050	0.0075	0.0095	0.0115	0.0145	0.0190	0.0240	0.0290		
H1.1.1 Hardened steel, hardened and tempered, < 55 HRC												
H1.1.2 Hardened steel, hardened and tempered, < 60 HRC												
H1.1.3 Hardened steel, hardened and tempered, > 60 HRC												
H2.1.1 Chilled cast iron, 400 HB												
H2.1.2 Chilled cast iron, hardened and tempered, < 55 HRC												



ExclusiveLine micro-precision drills with coolant ducts, > 7xD



Cutting data

Machining group		f (mm/rev) with nom. Ø							
		v _c (m/min)	1	1.2	1.5	1.8	2	2.2	2.5
									
P1.1.1 Unalloyed steel, annealed, 0.15 % C, Rm 420 N/mm ² , 125 HB	105	0.0400	0.0480	0.0600	0.0720	0.0800	0.0880	0.1000	0.1200
P1.1.2 Unalloyed steel, heat-treated, 0.15 % C, Rm 420 N/mm ² , 125 HB	95	0.0360	0.0430	0.0540	0.0650	0.0720	0.0790	0.0900	0.1080
P1.1.3 Unalloyed steel, annealed, 0.45 % C, Rm 640 N/mm ² , 190 HB	95	0.0360	0.0430	0.0540	0.0650	0.0720	0.0790	0.0900	0.1080
P1.1.4 Unalloyed steel, heat-treated, 0.45 % C, Rm 640 N/mm ² , 190 HB	90	0.0340	0.0410	0.0510	0.0610	0.0680	0.0750	0.0850	0.1020
P1.1.5 Unalloyed steel, heat-treated, 0.45 % C, Rm 850 N/mm ² , 250 HB	90	0.0340	0.0410	0.0510	0.0610	0.0680	0.0750	0.0850	0.1020
P1.1.6 Unalloyed steel, annealed, 0.75 % C, Rm 915 N/mm ² , 270 HB	85	0.0320	0.0385	0.0480	0.0575	0.0640	0.0705	0.0800	0.0960
P1.1.7 Unalloyed steel, heat-treated, 0.75 % C, Rm 1020 N/mm ² , 300 HB	80	0.0300	0.0360	0.0450	0.0540	0.0600	0.0660	0.0750	0.0900
P2.1.1 Low-alloy steel, annealed, Rm 610 N/mm ² , 180 HB	90	0.0400	0.0480	0.0600	0.0720	0.0800	0.0880	0.1000	0.1200
P2.1.2 Low-alloy steel, heat-treated, Rm 930 N/mm ² , 275 HB	90	0.0400	0.0480	0.0600	0.0720	0.0800	0.0880	0.1000	0.1200
P2.1.3 Low-alloy steel, heat-treated, Rm 1020 N/mm ² , 300 HB	75	0.0340	0.0410	0.0510	0.0610	0.0680	0.0750	0.0850	0.1020
P2.1.4 Low-alloy steel, heat-treated, Rm 1190 N/mm ² , 350 HB	70	0.0300	0.0360	0.0450	0.0540	0.0600	0.0660	0.0750	0.0900
P3.1.1 High-alloy steel and tool steel, annealed, Rm 680 N/mm ² , 200 HB	50	0.0400	0.0480	0.0600	0.0720	0.0800	0.0880	0.1000	0.1200
P3.1.2 High-alloy steel and tool steel, hardened and tempered, Rm 1100 N/mm ² , 325 HB	45	0.0340	0.0410	0.0510	0.0610	0.0680	0.0750	0.0850	0.1020
M1.1.1 Stainless steel, ferritic/martensitic, with machining additives	70	0.0220	0.0265	0.0330	0.0395	0.0440	0.0485	0.0550	0.0660
M1.1.2 Stainless steel, ferritic/martensitic, annealed, Rm 680 N/mm ² , 200 HB	65	0.0200	0.0240	0.0295	0.0355	0.0395	0.0435	0.0495	0.0595
M1.1.3 Stainless steel, ferritic/martensitic, heat-treated, Rm 810 N/mm ² , 240 HB	60	0.0185	0.0225	0.0280	0.0335	0.0375	0.0410	0.0465	0.0560
M2.1.1 Stainless steel, austenitic, quenched, 180 HB	60	0.0150	0.0180	0.0225	0.0270	0.0300	0.0330	0.0375	0.0450
M2.2.1 Duplex steel, high-strength stainless steels	50	0.0130	0.0155	0.0190	0.0230	0.0255	0.0280	0.0320	0.0385
K1.1.1 Grey cast iron, pearlitic/ferritic, 180 HB	150	0.0600	0.0720	0.0900	0.1080	0.1200	0.1320	0.1500	0.1800
K1.1.2 Grey cast iron, pearlitic/martensitic, 260 HB	130	0.0510	0.0610	0.0765	0.0920	0.1020	0.1120	0.1275	0.1530
K1.2.1 Cast iron with spheroidal graphite, ferritic, 160 HB	130	0.0510	0.0610	0.0765	0.0920	0.1020	0.1120	0.1275	0.1530
K1.2.2 Cast iron with spheroidal graphite, pearlitic, 250 HB	120	0.0480	0.0575	0.0720	0.0865	0.0960	0.1055	0.1200	0.1440
K1.3.1 Malleable cast iron, ferritic, 130 HB	120	0.0480	0.0575	0.0720	0.0865	0.0960	0.1055	0.1200	0.1440
K1.3.2 Malleable cast iron, pearlitic, 230 HB	105	0.0420	0.0505	0.0630	0.0755	0.0840	0.0925	0.1050	0.1260
K2.1.1 Vermicular graphite cast iron (GJV)									
K2.2.1 Austenitic-ferritic spheroidal graphite cast iron (ADI)									
N1.1.1 Wrought aluminium alloys, non-hardened, 60 HB	150	0.0900	0.1080	0.1350	0.1620	0.1800	0.1980	0.2250	0.2700
N1.1.2 Wrought aluminium alloys, hardened, 100 HB	150	0.0900	0.1080	0.1350	0.1620	0.1800	0.1980	0.2250	0.2700
N2.1.1 Aluminium casting alloys, non-hardened, ≤ 12 % Si, 75 HB	135	0.0420	0.0505	0.0630	0.0755	0.0840	0.0925	0.1050	0.1260
N2.1.2 Aluminium casting alloys, hardened, ≤ 12 % Si, 90 HB	135	0.0420	0.0505	0.0630	0.0755	0.0840	0.0925	0.1050	0.1260
N2.1.3 Aluminium casting alloys, non-hardened, > 12 % Si, 130 HB	115	0.0355	0.0430	0.0535	0.0645	0.0715	0.0785	0.0895	0.1070
N3.1.1 Copper and copper alloys: Free-machining alloy, Pb > 1 %									
N3.1.2 Copper and copper alloys: CuZn, CuSnZn									
N3.1.3 Copper and copper alloys: CuSn, lead-free copper and copper electrolyte									
N4.1.1 Non-metallic materials: Duroplastics, fibre-reinforced plastics									
N4.1.2 Non-metallic materials: Hard rubber, wood, etc.									
N4.1.3 Non-metallic materials: Graphite									
S1.1.1 Heat-resistant alloys, Fe-based, annealed, 200 HB	35	0.0120	0.0145	0.0180	0.0215	0.0240	0.0265	0.0300	0.0360
S1.1.2 Heat-resistant alloys, Fe-based, hardened, 280 HB	30	0.0095	0.0115	0.0145	0.0175	0.0190	0.0210	0.0240	0.0290
S1.1.3 Heat-resistant alloys, Ni- or Co-based, annealed, 250 HB	30	0.0120	0.0145	0.0180	0.0215	0.0240	0.0265	0.0300	0.0360
S1.1.4 Heat-resistant alloys, Ni- or Co-based, hardened, 350 HB	20	0.0085	0.0100	0.0125	0.0150	0.0170	0.0185	0.0210	0.0250
S1.1.5 Heat-resistant alloys, Ni- or Co-based, cast, 320 HB	20	0.0085	0.0100	0.0125	0.0150	0.0170	0.0185	0.0210	0.0250
S2.1.1 Titanium alloys, pure titanium, Rm 400 N/mm ²	35	0.0120	0.0145	0.0180	0.0215	0.0240	0.0265	0.0300	0.0360
S2.1.2 Titanium alloys, Alpha and Beta alloys, hardened, Rm 1050 N/mm ²	25	0.0095	0.0115	0.0145	0.0175	0.0190	0.0210	0.0240	0.0290
H1.1.1 Hardened steel, hardened and tempered, < 55 HRC									
H1.1.2 Hardened steel, hardened and tempered, < 60 HRC									
H1.1.3 Hardened steel, hardened and tempered, > 60 HRC									
H2.1.1 Chilled cast iron, 400 HB									
H2.1.2 Chilled cast iron, hardened and tempered, < 55 HRC									



ExclusiveLine micro-precision drills VA without coolant ducts, 3xD



Machining group	 v_c (m/min)	f (mm/rev) with nom. Ø							
		0.5	0.8	1	1.2	1.5	2	2.5	3
P1.1.1 Unalloyed steel, annealed, 0.15 % C, Rm 420 N/mm ² , 125 HB	90	0.0400	0.0640	0.0800	0.0960	0.1200	0.1600	0.2000	0.2400
P1.1.2 Unalloyed steel, heat-treated, 0.15 % C, Rm 420 N/mm ² , 125 HB	80	0.0360	0.0575	0.0720	0.0865	0.1080	0.1440	0.1800	0.2160
P1.1.3 Unalloyed steel, annealed, 0.45 % C, Rm 640 N/mm ² , 190 HB	80	0.0360	0.0575	0.0720	0.0865	0.1080	0.1440	0.1800	0.2160
P1.1.4 Unalloyed steel, heat-treated, 0.45 % C, Rm 640 N/mm ² , 190 HB	75	0.0340	0.0545	0.0680	0.0815	0.1020	0.1360	0.1700	0.2040
P1.1.5 Unalloyed steel, heat-treated, 0.45 % C, Rm 850 N/mm ² , 250 HB	75	0.0340	0.0545	0.0680	0.0815	0.1020	0.1360	0.1700	0.2040
P1.1.6 Unalloyed steel, annealed, 0.75 % C, Rm 915 N/mm ² , 270 HB	70	0.0320	0.0510	0.0640	0.0770	0.0960	0.1280	0.1600	0.1920
P1.1.7 Unalloyed steel, heat-treated, 0.75 % C, Rm 1020 N/mm ² , 300 HB	70	0.0300	0.0480	0.0600	0.0720	0.0900	0.1200	0.1500	0.1800
P2.1.1 Low-alloy steel, annealed, Rm 610 N/mm ² , 180 HB	80	0.0350	0.0560	0.0700	0.0840	0.1050	0.1400	0.1750	0.2100
P2.1.2 Low-alloy steel, heat-treated, Rm 930 N/mm ² , 275 HB	80	0.0350	0.0560	0.0700	0.0840	0.1050	0.1400	0.1750	0.2100
P2.1.3 Low-alloy steel, heat-treated, Rm 1020 N/mm ² , 300 HB	70	0.0300	0.0475	0.0595	0.0715	0.0895	0.1190	0.1490	0.1785
P2.1.4 Low-alloy steel, heat-treated, Rm 1190 N/mm ² , 350 HB	60	0.0265	0.0420	0.0525	0.0630	0.0790	0.1050	0.1315	0.1575
P3.1.1 High-alloy steel and tool steel, annealed, Rm 680 N/mm ² , 200 HB	60	0.0350	0.0560	0.0700	0.0840	0.1050	0.1400	0.1750	0.2100
P3.1.2 High-alloy steel and tool steel, hardened and tempered, Rm 1100 N/mm ² , 325 HB	50	0.0300	0.0475	0.0595	0.0715	0.0895	0.1190	0.1490	0.1785
M1.1.1 Stainless steel, ferritic/martensitic, with machining additives	40	0.0125	0.0200	0.0250	0.0300	0.0375	0.0500	0.0625	0.0750
M1.1.2 Stainless steel, ferritic/martensitic, annealed, Rm 680 N/mm ² , 200 HB	35	0.0115	0.0180	0.0225	0.0270	0.0340	0.0450	0.0565	0.0675
M1.1.3 Stainless steel, ferritic/martensitic, heat-treated, Rm 810 N/mm ² , 240 HB	35	0.0105	0.0170	0.0215	0.0255	0.0320	0.0425	0.0530	0.0640
M2.1.1 Stainless steel, austenitic, quenched, 180 HB	25	0.0075	0.0120	0.0150	0.0180	0.0225	0.0300	0.0375	0.0450
M2.2.1 Duplex steel, high-strength stainless steels	20	0.0065	0.0100	0.0130	0.0155	0.0190	0.0255	0.0320	0.0385
K1.1.1 Grey cast iron, pearlitic/ferritic, 180 HB									
K1.1.2 Grey cast iron, pearlitic/martensitic, 260 HB									
K1.2.1 Cast iron with spheroidal graphite, ferritic, 160 HB									
K1.2.2 Cast iron with spheroidal graphite, pearlitic, 250 HB									
K1.3.1 Malleable cast iron, ferritic, 130 HB									
K1.3.2 Malleable cast iron, pearlitic, 230 HB									
K2.1.1 Vermicular graphite cast iron (GJV)									
K2.2.1 Austenitic-ferritic spheroidal graphite cast iron (ADI)									
N1.1.1 Wrought aluminium alloys, non-hardened, 60 HB	270	0.0300	0.0480	0.0600	0.0720	0.0900	0.1200	0.1500	0.1800
N1.1.2 Wrought aluminium alloys, hardened, 100 HB	270	0.0300	0.0480	0.0600	0.0720	0.0900	0.1200	0.1500	0.1800
N2.1.1 Aluminium casting alloys, non-hardened, ≤ 12 % Si, 75 HB	180	0.0400	0.0640	0.0800	0.0960	0.1200	0.1600	0.2000	0.2400
N2.1.2 Aluminium casting alloys, hardened, ≤ 12 % Si, 90 HB	180	0.0400	0.0640	0.0800	0.0960	0.1200	0.1600	0.2000	0.2400
N2.1.3 Aluminium casting alloys, non-hardened, > 12 % Si, 130 HB	155	0.0340	0.0545	0.0680	0.0815	0.1020	0.1360	0.1700	0.2040
N3.1.1 Copper and copper alloys: Free-machining alloy, Pb > 1 %	125	0.0300	0.0480	0.0600	0.0720	0.0900	0.1200	0.1500	0.1800
N3.1.2 Copper and copper alloys: CuZn, CuSnZn	105	0.0255	0.0410	0.0510	0.0610	0.0765	0.1020	0.1275	0.1530
N3.1.3 Copper and copper alloys: CuSn, lead-free copper and copper electrolyte	100	0.0240	0.0385	0.0480	0.0575	0.0720	0.0960	0.1200	0.1440
N4.1.1 Non-metallic materials: Duroplastics, fibre-reinforced plastics									
N4.1.2 Non-metallic materials: Hard rubber, wood, etc.									
N4.1.3 Non-metallic materials: Graphite									
S1.1.1 Heat-resistant alloys, Fe-based, annealed, 200 HB	30	0.0100	0.0160	0.0200	0.0240	0.0300	0.0400	0.0500	0.0600
S1.1.2 Heat-resistant alloys, Fe-based, hardened, 280 HB	25	0.0080	0.0130	0.0160	0.0190	0.0240	0.0320	0.0400	0.0480
S1.1.3 Heat-resistant alloys, Ni- or Co-based, annealed, 250 HB	25	0.0100	0.0160	0.0200	0.0240	0.0300	0.0400	0.0500	0.0600
S1.1.4 Heat-resistant alloys, Ni- or Co-based, hardened, 350 HB	15	0.0070	0.0110	0.0140	0.0170	0.0210	0.0280	0.0350	0.0420
S1.1.5 Heat-resistant alloys, Ni- or Co-based, cast, 320 HB	20	0.0070	0.0110	0.0140	0.0170	0.0210	0.0280	0.0350	0.0420
S2.1.1 Titanium alloys, pure titanium, Rm 400 N/mm ²	25	0.0075	0.0120	0.0150	0.0180	0.0225	0.0300	0.0375	0.0450
S2.1.2 Titanium alloys, Alpha and Beta alloys, hardened, Rm 1050 N/mm ²	15	0.0060	0.0095	0.0120	0.0145	0.0180	0.0240	0.0300	0.0360
H1.1.1 Hardened steel, hardened and tempered, < 55 HRC									
H1.1.2 Hardened steel, hardened and tempered, < 60 HRC									
H1.1.3 Hardened steel, hardened and tempered, > 60 HRC									
H2.1.1 Chilled cast iron, 400 HB									
H2.1.2 Chilled cast iron, hardened and tempered, < 55 HRC									



ExclusiveLine micro-precision drills VA with coolant ducts, ≤ 6xD



Cutting data

Machining group		f (mm/rev) with nom. Ø							
			1	1.2	1.5	1.8	2	2.2	2.5
	v _c (m/min)								
P1.1.1 Unalloyed steel, annealed, 0.15 % C, Rm 420 N/mm ² , 125 HB	100	0.0500	0.0600	0.0750	0.0900	0.1000	0.1100	0.1250	0.1500
P1.1.2 Unalloyed steel, heat-treated, 0.15 % C, Rm 420 N/mm ² , 125 HB	90	0.0450	0.0540	0.0675	0.0810	0.0900	0.0990	0.1125	0.1350
P1.1.3 Unalloyed steel, annealed, 0.45 % C, Rm 640 N/mm ² , 190 HB	90	0.0450	0.0540	0.0675	0.0810	0.0900	0.0990	0.1125	0.1350
P1.1.4 Unalloyed steel, heat-treated, 0.45 % C, Rm 640 N/mm ² , 190 HB	85	0.0425	0.0510	0.0640	0.0765	0.0850	0.0935	0.1065	0.1275
P1.1.5 Unalloyed steel, heat-treated, 0.45 % C, Rm 850 N/mm ² , 250 HB	85	0.0425	0.0510	0.0640	0.0765	0.0850	0.0935	0.1065	0.1275
P1.1.6 Unalloyed steel, annealed, 0.75 % C, Rm 915 N/mm ² , 270 HB	80	0.0400	0.0480	0.0600	0.0720	0.0800	0.0880	0.1000	0.1200
P1.1.7 Unalloyed steel, heat-treated, 0.75 % C, Rm 1020 N/mm ² , 300 HB	75	0.0375	0.0450	0.0565	0.0675	0.0750	0.0825	0.0940	0.1125
P2.1.1 Low-alloy steel, annealed, Rm 610 N/mm ² , 180 HB	90	0.0500	0.0600	0.0750	0.0900	0.1000	0.1100	0.1250	0.1500
P2.1.2 Low-alloy steel, heat-treated, Rm 930 N/mm ² , 275 HB	90	0.0500	0.0600	0.0750	0.0900	0.1000	0.1100	0.1250	0.1500
P2.1.3 Low-alloy steel, heat-treated, Rm 1020 N/mm ² , 300 HB	75	0.0425	0.0510	0.0640	0.0765	0.0850	0.0935	0.1065	0.1275
P2.1.4 Low-alloy steel, heat-treated, Rm 1190 N/mm ² , 350 HB	70	0.0375	0.0450	0.0565	0.0675	0.0750	0.0825	0.0940	0.1125
P3.1.1 High-alloy steel and tool steel, annealed, Rm 680 N/mm ² , 200 HB	70	0.0500	0.0600	0.0750	0.0900	0.1000	0.1100	0.1250	0.1500
P3.1.2 High-alloy steel and tool steel, hardened and tempered, Rm 1100 N/mm ² , 325 HB	60	0.0425	0.0510	0.0640	0.0765	0.0850	0.0935	0.1065	0.1275
M1.1.1 Stainless steel, ferritic/martensitic, with machining additives	100	0.0370	0.0445	0.0555	0.0665	0.0740	0.0815	0.0925	0.1110
M1.1.2 Stainless steel, ferritic/martensitic, annealed, Rm 680 N/mm ² , 200 HB	90	0.0335	0.0400	0.0500	0.0600	0.0665	0.0735	0.0830	0.1000
M1.1.3 Stainless steel, ferritic/martensitic, heat-treated, Rm 810 N/mm ² , 240 HB	85	0.0315	0.0375	0.0470	0.0565	0.0630	0.0690	0.0785	0.0945
M2.1.1 Stainless steel, austenitic, quenched, 180 HB	80	0.0300	0.0360	0.0450	0.0540	0.0600	0.0660	0.0750	0.0900
M2.2.1 Duplex steel, high-strength stainless steels	70	0.0255	0.0305	0.0385	0.0460	0.0510	0.0560	0.0640	0.0765
K1.1.1 Grey cast iron, pearlitic/ferritic, 180 HB									
K1.1.2 Grey cast iron, pearlitic/martensitic, 260 HB									
K1.2.1 Cast iron with spheroidal graphite, ferritic, 160 HB									
K1.2.2 Cast iron with spheroidal graphite, pearlitic, 250 HB									
K1.3.1 Malleable cast iron, ferritic, 130 HB									
K1.3.2 Malleable cast iron, pearlitic, 230 HB									
K2.1.1 Vermicular graphite cast iron (GJV)									
K2.2.1 Austenitic-ferritic spheroidal graphite cast iron (ADI)									
N1.1.1 Wrought aluminium alloys, non-hardened, 60 HB	300	0.0600	0.0720	0.0900	0.1080	0.1200	0.1320	0.1500	0.1800
N1.1.2 Wrought aluminium alloys, hardened, 100 HB	300	0.0600	0.0720	0.0900	0.1080	0.1200	0.1320	0.1500	0.1800
N2.1.1 Aluminium casting alloys, non-hardened, ≤ 12 % Si, 75 HB	200	0.0800	0.0960	0.1200	0.1440	0.1600	0.1760	0.2000	0.2400
N2.1.2 Aluminium casting alloys, hardened, ≤ 12 % Si, 90 HB	200	0.0800	0.0960	0.1200	0.1440	0.1600	0.1760	0.2000	0.2400
N2.1.3 Aluminium casting alloys, non-hardened, > 12 % Si, 130 HB	170	0.0680	0.0815	0.1020	0.1225	0.1360	0.1495	0.1700	0.2040
N3.1.1 Copper and copper alloys: Free-machining alloy, Pb > 1 %	150	0.0500	0.0600	0.0750	0.0900	0.1000	0.1100	0.1250	0.1500
N3.1.2 Copper and copper alloys: CuZn, CuSnZn	130	0.0425	0.0510	0.0640	0.0765	0.0850	0.0935	0.1065	0.1275
N3.1.3 Copper and copper alloys: CuSn, lead-free copper and copper electrolyte	120	0.0400	0.0480	0.0600	0.0720	0.0800	0.0880	0.1000	0.1200
N4.1.1 Non-metallic materials: Duroplastics, fibre-reinforced plastics									
N4.1.2 Non-metallic materials: Hard rubber, wood, etc.									
N4.1.3 Non-metallic materials: Graphite									
S1.1.1 Heat-resistant alloys, Fe-based, annealed, 200 HB	50	0.0200	0.0240	0.0300	0.0360	0.0400	0.0440	0.0500	0.0600
S1.1.2 Heat-resistant alloys, Fe-based, hardened, 280 HB	40	0.0160	0.0190	0.0240	0.0290	0.0320	0.0350	0.0400	0.0480
S1.1.3 Heat-resistant alloys, Ni- or Co-based, annealed, 250 HB	45	0.0200	0.0240	0.0300	0.0360	0.0400	0.0440	0.0500	0.0600
S1.1.4 Heat-resistant alloys, Ni- or Co-based, hardened, 350 HB	30	0.0140	0.0170	0.0210	0.0250	0.0280	0.0310	0.0350	0.0420
S1.1.5 Heat-resistant alloys, Ni- or Co-based, cast, 320 HB	30	0.0140	0.0170	0.0210	0.0250	0.0280	0.0310	0.0350	0.0420
S2.1.1 Titanium alloys, pure titanium, Rm 400 N/mm ²	45	0.0150	0.0180	0.0225	0.0270	0.0300	0.0330	0.0375	0.0450
S2.1.2 Titanium alloys, Alpha and Beta alloys, hardened, Rm 1050 N/mm ²	35	0.0120	0.0145	0.0180	0.0215	0.0240	0.0265	0.0300	0.0360
H1.1.1 Hardened steel, hardened and tempered, < 55 HRC									
H1.1.2 Hardened steel, hardened and tempered, < 60 HRC									
H1.1.3 Hardened steel, hardened and tempered, > 60 HRC									
H2.1.1 Chilled cast iron, 400 HB									
H2.1.2 Chilled cast iron, hardened and tempered, < 55 HRC									



ExclusiveLine micro-precision drills VA with coolant ducts, > 6xD



Machining group		f (mm/rev) with nom. Ø							
			1	1.2	1.5	1.8	2	2.2	2.5
	v _c (m/min)								
P1.1.1 Unalloyed steel, annealed, 0.15 % C, Rm 420 N/mm ² , 125 HB	100	0.0300	0.0360	0.0450	0.0540	0.0600	0.0660	0.0750	0.0900
P1.1.2 Unalloyed steel, heat-treated, 0.15 % C, Rm 420 N/mm ² , 125 HB	90	0.0270	0.0325	0.0405	0.0485	0.0540	0.0595	0.0675	0.0810
P1.1.3 Unalloyed steel, annealed, 0.45 % C, Rm 640 N/mm ² , 190 HB	90	0.0270	0.0325	0.0405	0.0485	0.0540	0.0595	0.0675	0.0810
P1.1.4 Unalloyed steel, heat-treated, 0.45 % C, Rm 640 N/mm ² , 190 HB	85	0.0255	0.0305	0.0385	0.0460	0.0510	0.0560	0.0640	0.0765
P1.1.5 Unalloyed steel, heat-treated, 0.45 % C, Rm 850 N/mm ² , 250 HB	85	0.0255	0.0305	0.0385	0.0460	0.0510	0.0560	0.0640	0.0765
P1.1.6 Unalloyed steel, annealed, 0.75 % C, Rm 915 N/mm ² , 270 HB	80	0.0240	0.0290	0.0360	0.0430	0.0480	0.0530	0.0600	0.0720
P1.1.7 Unalloyed steel, heat-treated, 0.75 % C, Rm 1020 N/mm ² , 300 HB	75	0.0225	0.0270	0.0340	0.0405	0.0450	0.0495	0.0560	0.0675
P2.1.1 Low-alloy steel, annealed, Rm 610 N/mm ² , 180 HB	90	0.0300	0.0360	0.0450	0.0540	0.0600	0.0660	0.0750	0.0900
P2.1.2 Low-alloy steel, heat-treated, Rm 930 N/mm ² , 275 HB	90	0.0300	0.0360	0.0450	0.0540	0.0600	0.0660	0.0750	0.0900
P2.1.3 Low-alloy steel, heat-treated, Rm 1020 N/mm ² , 300 HB	75	0.0255	0.0305	0.0385	0.0460	0.0510	0.0560	0.0640	0.0765
P2.1.4 Low-alloy steel, heat-treated, Rm 1190 N/mm ² , 350 HB	70	0.0225	0.0270	0.0340	0.0405	0.0450	0.0495	0.0560	0.0675
P3.1.1 High-alloy steel and tool steel, annealed, Rm 680 N/mm ² , 200 HB	70	0.0300	0.0360	0.0450	0.0540	0.0600	0.0660	0.0750	0.0900
P3.1.2 High-alloy steel and tool steel, hardened and tempered, Rm 1100 N/mm ² , 325 HB	60	0.0255	0.0305	0.0385	0.0460	0.0510	0.0560	0.0640	0.0765
M1.1.1 Stainless steel, ferritic/martensitic, with machining additives	100	0.0370	0.0445	0.0555	0.0665	0.0740	0.0815	0.0925	0.1110
M1.1.2 Stainless steel, ferritic/martensitic, annealed, Rm 680 N/mm ² , 200 HB	90	0.0335	0.0400	0.0500	0.0600	0.0665	0.0735	0.0830	0.1000
M1.1.3 Stainless steel, ferritic/martensitic, heat-treated, Rm 810 N/mm ² , 240 HB	85	0.0315	0.0375	0.0470	0.0565	0.0630	0.0690	0.0785	0.0945
M2.1.1 Stainless steel, austenitic, quenched, 180 HB	80	0.0300	0.0360	0.0450	0.0540	0.0600	0.0660	0.0750	0.0900
M2.2.1 Duplex steel, high-strength stainless steels	70	0.0255	0.0305	0.0385	0.0460	0.0510	0.0560	0.0640	0.0765
K1.1.1 Grey cast iron, pearlitic/ferritic, 180 HB									
K1.1.2 Grey cast iron, pearlitic/martensitic, 260 HB									
K1.2.1 Cast iron with spheroidal graphite, ferritic, 160 HB									
K1.2.2 Cast iron with spheroidal graphite, pearlitic, 250 HB									
K1.3.1 Malleable cast iron, ferritic, 130 HB									
K1.3.2 Malleable cast iron, pearlitic, 230 HB									
K2.1.1 Vermicular graphite cast iron (GJV)									
K2.2.1 Austenitic-ferritic spheroidal graphite cast iron (ADI)									
N1.1.1 Wrought aluminium alloys, non-hardened, 60 HB	300	0.0400	0.0480	0.0600	0.0720	0.0800	0.0880	0.1000	0.1200
N1.1.2 Wrought aluminium alloys, hardened, 100 HB	300	0.0400	0.0480	0.0600	0.0720	0.0800	0.0880	0.1000	0.1200
N2.1.1 Aluminium casting alloys, non-hardened, ≤ 12 % Si, 75 HB	200	0.0600	0.0720	0.0900	0.1080	0.1200	0.1320	0.1500	0.1800
N2.1.2 Aluminium casting alloys, hardened, ≤ 12 % Si, 90 HB	200	0.0600	0.0720	0.0900	0.1080	0.1200	0.1320	0.1500	0.1800
N2.1.3 Aluminium casting alloys, non-hardened, > 12 % Si, 130 HB	170	0.0510	0.0610	0.0765	0.0920	0.1020	0.1120	0.1275	0.1530
N3.1.1 Copper and copper alloys: Free-machining alloy, Pb > 1 %	150	0.0300	0.0360	0.0450	0.0540	0.0600	0.0660	0.0750	0.0900
N3.1.2 Copper and copper alloys: CuZn, CuSnZn	130	0.0255	0.0305	0.0385	0.0460	0.0510	0.0560	0.0640	0.0765
N3.1.3 Copper and copper alloys: CuSn, lead-free copper and copper electrolyte	120	0.0240	0.0290	0.0360	0.0430	0.0480	0.0530	0.0600	0.0720
N4.1.1 Non-metallic materials: Duroplastics, fibre-reinforced plastics									
N4.1.2 Non-metallic materials: Hard rubber, wood, etc.									
N4.1.3 Non-metallic materials: Graphite									
S1.1.1 Heat-resistant alloys, Fe-based, annealed, 200 HB	50	0.0200	0.0240	0.0300	0.0360	0.0400	0.0440	0.0500	0.0600
S1.1.2 Heat-resistant alloys, Fe-based, hardened, 280 HB	40	0.0160	0.0190	0.0240	0.0290	0.0320	0.0350	0.0400	0.0480
S1.1.3 Heat-resistant alloys, Ni- or Co-based, annealed, 250 HB	45	0.0200	0.0240	0.0300	0.0360	0.0400	0.0440	0.0500	0.0600
S1.1.4 Heat-resistant alloys, Ni- or Co-based, hardened, 350 HB	30	0.0140	0.0170	0.0210	0.0250	0.0280	0.0310	0.0350	0.0420
S1.1.5 Heat-resistant alloys, Ni- or Co-based, cast, 320 HB	30	0.0140	0.0170	0.0210	0.0250	0.0280	0.0310	0.0350	0.0420
S2.1.1 Titanium alloys, pure titanium, Rm 400 N/mm ²	40	0.0120	0.0145	0.0180	0.0215	0.0240	0.0265	0.0300	0.0360
S2.1.2 Titanium alloys, Alpha and Beta alloys, hardened, Rm 1050 N/mm ²	30	0.0095	0.0115	0.0145	0.0175	0.0190	0.0210	0.0240	0.0290
H1.1.1 Hardened steel, hardened and tempered, < 55 HRC									
H1.1.2 Hardened steel, hardened and tempered, < 60 HRC									
H1.1.3 Hardened steel, hardened and tempered, > 60 HRC									
H2.1.1 Chilled cast iron, 400 HB									
H2.1.2 Chilled cast iron, hardened and tempered, < 55 HRC									



ExclusiveLine micro-precision drills XL with coolant ducts, 20xD



Cutting data

Machining group	 A v _c (m/min)	f (mm/rev) with nom. Ø							
		1	1.2	1.5	1.8	2	2.2	2.5	3
P1.1.1 Unalloyed steel, annealed, 0.15 % C, Rm 420 N/mm ² , 125 HB	100	0.0450	0.0540	0.0675	0.0810	0.0900	0.0990	0.1125	0.1350
P1.1.2 Unalloyed steel, heat-treated, 0.15 % C, Rm 420 N/mm ² , 125 HB	90	0.0405	0.0485	0.0610	0.0730	0.0810	0.0890	0.1015	0.1215
P1.1.3 Unalloyed steel, annealed, 0.45 % C, Rm 640 N/mm ² , 190 HB	90	0.0405	0.0485	0.0610	0.0730	0.0810	0.0890	0.1015	0.1215
P1.1.4 Unalloyed steel, heat-treated, 0.45 % C, Rm 640 N/mm ² , 190 HB	85	0.0385	0.0460	0.0575	0.0690	0.0765	0.0840	0.0955	0.1145
P1.1.5 Unalloyed steel, heat-treated, 0.45 % C, Rm 850 N/mm ² , 250 HB	85	0.0385	0.0460	0.0575	0.0690	0.0765	0.0840	0.0955	0.1145
P1.1.6 Unalloyed steel, annealed, 0.75 % C, Rm 915 N/mm ² , 270 HB	80	0.0360	0.0430	0.0540	0.0650	0.0720	0.0790	0.0900	0.1080
P1.1.7 Unalloyed steel, heat-treated, 0.75 % C, Rm 1020 N/mm ² , 300 HB	75	0.0340	0.0405	0.0505	0.0610	0.0675	0.0745	0.0845	0.1015
P2.1.1 Low-alloy steel, annealed, Rm 610 N/mm ² , 180 HB	90	0.0350	0.0420	0.0525	0.0630	0.0700	0.0770	0.0875	0.1050
P2.1.2 Low-alloy steel, heat-treated, Rm 930 N/mm ² , 275 HB	90	0.0350	0.0420	0.0525	0.0630	0.0700	0.0770	0.0875	0.1050
P2.1.3 Low-alloy steel, heat-treated, Rm 1020 N/mm ² , 300 HB	75	0.0300	0.0355	0.0445	0.0535	0.0595	0.0655	0.0745	0.0895
P2.1.4 Low-alloy steel, heat-treated, Rm 1190 N/mm ² , 350 HB	70	0.0265	0.0315	0.0395	0.0475	0.0525	0.0580	0.0655	0.0790
P3.1.1 High-alloy steel and tool steel, annealed, Rm 680 N/mm ² , 200 HB	80	0.0250	0.0300	0.0375	0.0450	0.0500	0.0550	0.0625	0.0750
P3.1.2 High-alloy steel and tool steel, hardened and tempered, Rm 1100 N/mm ² , 325 HB	70	0.0215	0.0255	0.0320	0.0385	0.0425	0.0470	0.0530	0.0640
M1.1.1 Stainless steel, ferritic/martensitic, with machining additives	80	0.0200	0.0240	0.0300	0.0360	0.0400	0.0440	0.0500	0.0600
M1.1.2 Stainless steel, ferritic/martensitic, annealed, Rm 680 N/mm ² , 200 HB	70	0.0180	0.0215	0.0270	0.0325	0.0360	0.0395	0.0450	0.0540
M1.1.3 Stainless steel, ferritic/martensitic, heat-treated, Rm 810 N/mm ² , 240 HB	70	0.0170	0.0205	0.0255	0.0305	0.0340	0.0375	0.0425	0.0510
M2.1.1 Stainless steel, austenitic, quenched, 180 HB	80	0.0200	0.0240	0.0300	0.0360	0.0400	0.0440	0.0500	0.0600
M2.2.1 Duplex steel, high-strength stainless steels	70	0.0170	0.0205	0.0255	0.0305	0.0340	0.0375	0.0425	0.0510
K1.1.1 Grey cast iron, pearlitic/ferritic, 180 HB	140	0.0600	0.0720	0.0900	0.1080	0.1200	0.1320	0.1500	0.1800
K1.1.2 Grey cast iron, pearlitic/martensitic, 260 HB	120	0.0510	0.0610	0.0765	0.0920	0.1020	0.1120	0.1275	0.1530
K1.2.1 Cast iron with spheroidal graphite, ferritic, 160 HB	120	0.0510	0.0610	0.0765	0.0920	0.1020	0.1120	0.1275	0.1530
K1.2.2 Cast iron with spheroidal graphite, pearlitic, 250 HB	110	0.0480	0.0575	0.0720	0.0865	0.0960	0.1055	0.1200	0.1440
K1.3.1 Malleable cast iron, ferritic, 130 HB	110	0.0480	0.0575	0.0720	0.0865	0.0960	0.1055	0.1200	0.1440
K1.3.2 Malleable cast iron, pearlitic, 230 HB	100	0.0420	0.0505	0.0630	0.0755	0.0840	0.0925	0.1050	0.1260
K2.1.1 Vermicular graphite cast iron (GJV)									
K2.2.1 Austenitic-ferritic spheroidal graphite cast iron (ADI)									
N1.1.1 Wrought aluminium alloys, non-hardened, 60 HB	135	0.0600	0.0720	0.0900	0.1080	0.1200	0.1320	0.1500	0.1800
N1.1.2 Wrought aluminium alloys, hardened, 100 HB	135	0.0600	0.0720	0.0900	0.1080	0.1200	0.1320	0.1500	0.1800
N2.1.1 Aluminium casting alloys, non-hardened, ≤ 12 % Si, 75 HB	135	0.0800	0.0960	0.1200	0.1440	0.1600	0.1760	0.2000	0.2400
N2.1.2 Aluminium casting alloys, hardened, ≤ 12 % Si, 90 HB	135	0.0800	0.0960	0.1200	0.1440	0.1600	0.1760	0.2000	0.2400
N2.1.3 Aluminium casting alloys, non-hardened, > 12 % Si, 130 HB	115	0.0680	0.0815	0.1020	0.1225	0.1360	0.1495	0.1700	0.2040
N3.1.1 Copper and copper alloys: Free-machining alloy, Pb > 1 %	130	0.0350	0.0420	0.0525	0.0630	0.0700	0.0770	0.0875	0.1050
N3.1.2 Copper and copper alloys: CuZn, CuSnZn	110	0.0300	0.0355	0.0445	0.0535	0.0595	0.0655	0.0745	0.0895
N3.1.3 Copper and copper alloys: CuSn, lead-free copper and copper electrolyte	105	0.0280	0.0335	0.0420	0.0505	0.0560	0.0615	0.0700	0.0840
N4.1.1 Non-metallic materials: Duroplastics, fibre-reinforced plastics									
N4.1.2 Non-metallic materials: Hard rubber, wood, etc.									
N4.1.3 Non-metallic materials: Graphite									
S1.1.1 Heat-resistant alloys, Fe-based, annealed, 200 HB	40	0.0150	0.0180	0.0225	0.0270	0.0300	0.0330	0.0375	0.0450
S1.1.2 Heat-resistant alloys, Fe-based, hardened, 280 HB	30	0.0120	0.0145	0.0180	0.0215	0.0240	0.0265	0.0300	0.0360
S1.1.3 Heat-resistant alloys, Ni- or Co-based, annealed, 250 HB	35	0.0150	0.0180	0.0225	0.0270	0.0300	0.0330	0.0375	0.0450
S1.1.4 Heat-resistant alloys, Ni- or Co-based, hardened, 350 HB	20	0.0105	0.0125	0.0160	0.0190	0.0210	0.0230	0.0260	0.0315
S1.1.5 Heat-resistant alloys, Ni- or Co-based, cast, 320 HB	25	0.0105	0.0125	0.0160	0.0190	0.0210	0.0230	0.0260	0.0315
S2.1.1 Titanium alloys, pure titanium, Rm 400 N/mm ²	35	0.0120	0.0145	0.0180	0.0215	0.0240	0.0265	0.0300	0.0360
S2.1.2 Titanium alloys, Alpha and Beta alloys, hardened, Rm 1050 N/mm ²	25	0.0095	0.0115	0.0145	0.0175	0.0190	0.0210	0.0240	0.0290
H1.1.1 Hardened steel, hardened and tempered, < 55 HRC									
H1.1.2 Hardened steel, hardened and tempered, < 60 HRC									
H1.1.3 Hardened steel, hardened and tempered, > 60 HRC									
H2.1.1 Chilled cast iron, 400 HB									
H2.1.2 Chilled cast iron, hardened and tempered, < 55 HRC									



Solid carbide micro-precision drills without coolant ducts, bright



Machining group		f (mm/rev) with nom. Ø							
	v _c (m/min)	0.2	0.5	0.8	1	1.5	2	2.5	3
P1.1.1 Unalloyed steel, annealed, 0.15 % C, Rm 420 N/mm ² , 125 HB	50	0.0070	0.0175	0.0280	0.0350	0.0525	0.0700	0.0875	0.1050
P1.1.2 Unalloyed steel, heat-treated, 0.15 % C, Rm 420 N/mm ² , 125 HB	45	0.0065	0.0160	0.0250	0.0315	0.0475	0.0630	0.0790	0.0945
P1.1.3 Unalloyed steel, annealed, 0.45 % C, Rm 640 N/mm ² , 190 HB	45	0.0065	0.0160	0.0250	0.0315	0.0475	0.0630	0.0790	0.0945
P1.1.4 Unalloyed steel, heat-treated, 0.45 % C, Rm 640 N/mm ² , 190 HB	45	0.0060	0.0150	0.0240	0.0300	0.0445	0.0595	0.0745	0.0895
P1.1.5 Unalloyed steel, heat-treated, 0.45 % C, Rm 850 N/mm ² , 250 HB	45	0.0060	0.0150	0.0240	0.0300	0.0445	0.0595	0.0745	0.0895
P1.1.6 Unalloyed steel, annealed, 0.75 % C, Rm 915 N/mm ² , 270 HB	40	0.0055	0.0140	0.0225	0.0280	0.0420	0.0560	0.0700	0.0840
P1.1.7 Unalloyed steel, heat-treated, 0.75 % C, Rm 1020 N/mm ² , 300 HB	40	0.0055	0.0130	0.0210	0.0265	0.0395	0.0525	0.0655	0.0790
P2.1.1 Low-alloy steel, annealed, Rm 610 N/mm ² , 180 HB	30	0.0060	0.0145	0.0230	0.0290	0.0435	0.0580	0.0725	0.0870
P2.1.2 Low-alloy steel, heat-treated, Rm 930 N/mm ² , 275 HB	30	0.0060	0.0145	0.0230	0.0290	0.0435	0.0580	0.0725	0.0870
P2.1.3 Low-alloy steel, heat-treated, Rm 1020 N/mm ² , 300 HB									
P2.1.4 Low-alloy steel, heat-treated, Rm 1190 N/mm ² , 350 HB									
P3.1.1 High-alloy steel and tool steel, annealed, Rm 680 N/mm ² , 200 HB									
P3.1.2 High-alloy steel and tool steel, hardened and tempered, Rm 1100 N/mm ² , 325 HB									
M1.1.1 Stainless steel, ferritic/martensitic, with machining additives	20	0.0040	0.0100	0.0160	0.0200	0.0300	0.0400	0.0500	0.0600
M1.1.2 Stainless steel, ferritic/martensitic, annealed, Rm 680 N/mm ² , 200 HB	20	0.0035	0.0090	0.0145	0.0180	0.0270	0.0360	0.0450	0.0540
M1.1.3 Stainless steel, ferritic/martensitic, heat-treated, Rm 810 N/mm ² , 240 HB	15	0.0035	0.0085	0.0135	0.0170	0.0255	0.0340	0.0425	0.0510
M2.1.1 Stainless steel, austenitic, quenched, 180 HB	15	0.0030	0.0075	0.0120	0.0150	0.0225	0.0300	0.0375	0.0450
M2.2.1 Duplex steel, high-strength stainless steels	15	0.0025	0.0065	0.0100	0.0130	0.0190	0.0255	0.0320	0.0385
K1.1.1 Grey cast iron, pearlitic/ferritic, 180 HB	60	0.0070	0.0175	0.0280	0.0350	0.0525	0.0700	0.0875	0.1050
K1.1.2 Grey cast iron, pearlitic/martensitic, 260 HB	50	0.0060	0.0150	0.0240	0.0300	0.0445	0.0595	0.0745	0.0895
K1.2.1 Cast iron with spheroidal graphite, ferritic, 160 HB	50	0.0060	0.0150	0.0240	0.0300	0.0445	0.0595	0.0745	0.0895
K1.2.2 Cast iron with spheroidal graphite, pearlitic, 250 HB	50	0.0055	0.0140	0.0225	0.0280	0.0420	0.0560	0.0700	0.0840
K1.3.1 Malleable cast iron, ferritic, 130 HB	50	0.0055	0.0140	0.0225	0.0280	0.0420	0.0560	0.0700	0.0840
K1.3.2 Malleable cast iron, pearlitic, 230 HB	40	0.0050	0.0125	0.0195	0.0245	0.0370	0.0490	0.0615	0.0735
K2.1.1 Vermicular graphite cast iron (GJV)									
K2.2.1 Austenitic-ferritic spheroidal graphite cast iron (ADI)									
N1.1.1 Wrought aluminium alloys, non-hardened, 60 HB	160	0.0120	0.0300	0.0480	0.0600	0.0900	0.1200	0.1500	0.1800
N1.1.2 Wrought aluminium alloys, hardened, 100 HB	160	0.0120	0.0300	0.0480	0.0600	0.0900	0.1200	0.1500	0.1800
N2.1.1 Aluminium casting alloys, non-hardened, ≤ 12 % Si, 75 HB	100	0.0100	0.0250	0.0400	0.0500	0.0750	0.1000	0.1250	0.1500
N2.1.2 Aluminium casting alloys, hardened, ≤ 12 % Si, 90 HB	100	0.0100	0.0250	0.0400	0.0500	0.0750	0.1000	0.1250	0.1500
N2.1.3 Aluminium casting alloys, non-hardened, > 12 % Si, 130 HB	85	0.0085	0.0215	0.0340	0.0425	0.0640	0.0850	0.1065	0.1275
N3.1.1 Copper and copper alloys: Free-machining alloy, Pb > 1 %	80	0.0080	0.0205	0.0330	0.0410	0.0615	0.0820	0.1025	0.1230
N3.1.2 Copper and copper alloys: CuZn, CuSnZn	70	0.0070	0.0175	0.0280	0.0350	0.0525	0.0695	0.0870	0.1045
N3.1.3 Copper and copper alloys: CuSn, lead-free copper and copper electrolyte	65	0.0065	0.0165	0.0260	0.0330	0.0490	0.0655	0.0820	0.0985
N4.1.1 Non-metallic materials: Duroplastics, fibre-reinforced plastics	100	0.0060	0.0145	0.0230	0.0290	0.0435	0.0580	0.0725	0.0870
N4.1.2 Non-metallic materials: Hard rubber, wood, etc.	100	0.0060	0.0145	0.0230	0.0290	0.0435	0.0580	0.0725	0.0870
N4.1.3 Non-metallic materials: Graphite									
S1.1.1 Heat-resistant alloys, Fe-based, annealed, 200 HB	15	0.0040	0.0100	0.0160	0.0200	0.0300	0.0400	0.0500	0.0600
S1.1.2 Heat-resistant alloys, Fe-based, hardened, 280 HB	10	0.0030	0.0080	0.0130	0.0160	0.0240	0.0320	0.0400	0.0480
S1.1.3 Heat-resistant alloys, Ni- or Co-based, annealed, 250 HB	15	0.0040	0.0100	0.0160	0.0200	0.0300	0.0400	0.0500	0.0600
S1.1.4 Heat-resistant alloys, Ni- or Co-based, hardened, 350 HB	10	0.0030	0.0070	0.0110	0.0140	0.0210	0.0280	0.0350	0.0420
S1.1.5 Heat-resistant alloys, Ni- or Co-based, cast, 320 HB	10	0.0030	0.0070	0.0110	0.0140	0.0210	0.0280	0.0350	0.0420
S2.1.1 Titanium alloys, pure titanium, Rm 400 N/mm ²	10	0.0030	0.0075	0.0120	0.0150	0.0225	0.0300	0.0375	0.0450
S2.1.2 Titanium alloys, Alpha and Beta alloys, hardened, Rm 1050 N/mm ²	10	0.0025	0.0060	0.0095	0.0120	0.0180	0.0240	0.0300	0.0360
H1.1.1 Hardened steel, hardened and tempered, < 55 HRC									
H1.1.2 Hardened steel, hardened and tempered, < 60 HRC									
H1.1.3 Hardened steel, hardened and tempered, > 60 HRC									
H2.1.1 Chilled cast iron, 400 HB									
H2.1.2 Chilled cast iron, hardened and tempered, < 55 HRC									



Solid carbide micro-precision drills without coolant ducts, TiAlN



Cutting data

Machining group		f (mm/rev) with nom. Ø								
		v _c (m/min)	0.2	0.5	0.8	1	1.5	2	2.5	3
P1.1.1 Unalloyed steel, annealed, 0.15 % C, Rm 420 N/mm ² , 125 HB	80	0.0120	0.0300	0.0480	0.0600	0.0900	0.1200	0.1500	0.1800	
P1.1.2 Unalloyed steel, heat-treated, 0.15 % C, Rm 420 N/mm ² , 125 HB	70	0.0110	0.0270	0.0430	0.0540	0.0810	0.1080	0.1350	0.1620	
P1.1.3 Unalloyed steel, annealed, 0.45 % C, Rm 640 N/mm ² , 190 HB	70	0.0110	0.0270	0.0430	0.0540	0.0810	0.1080	0.1350	0.1620	
P1.1.4 Unalloyed steel, heat-treated, 0.45 % C, Rm 640 N/mm ² , 190 HB	70	0.0100	0.0255	0.0410	0.0510	0.0765	0.1020	0.1275	0.1530	
P1.1.5 Unalloyed steel, heat-treated, 0.45 % C, Rm 850 N/mm ² , 250 HB	70	0.0100	0.0255	0.0410	0.0510	0.0765	0.1020	0.1275	0.1530	
P1.1.6 Unalloyed steel, annealed, 0.75 % C, Rm 915 N/mm ² , 270 HB	65	0.0095	0.0240	0.0385	0.0480	0.0720	0.0960	0.1200	0.1440	
P1.1.7 Unalloyed steel, heat-treated, 0.75 % C, Rm 1020 N/mm ² , 300 HB	60	0.0090	0.0225	0.0360	0.0450	0.0675	0.0900	0.1125	0.1350	
P2.1.1 Low-alloy steel, annealed, Rm 610 N/mm ² , 180 HB	70	0.0120	0.0300	0.0480	0.0600	0.0900	0.1200	0.1500	0.1800	
P2.1.2 Low-alloy steel, heat-treated, Rm 930 N/mm ² , 275 HB	70	0.0120	0.0300	0.0480	0.0600	0.0900	0.1200	0.1500	0.1800	
P2.1.3 Low-alloy steel, heat-treated, Rm 1020 N/mm ² , 300 HB	60	0.0100	0.0255	0.0410	0.0510	0.0765	0.1020	0.1275	0.1530	
P2.1.4 Low-alloy steel, heat-treated, Rm 1190 N/mm ² , 350 HB	55	0.0090	0.0225	0.0360	0.0450	0.0675	0.0900	0.1125	0.1350	
P3.1.1 High-alloy steel and tool steel, annealed, Rm 680 N/mm ² , 200 HB	40	0.0080	0.0200	0.0320	0.0400	0.0600	0.0800	0.1000	0.1200	
P3.1.2 High-alloy steel and tool steel, hardened and tempered, Rm 1100 N/mm ² , 325 HB	35	0.0070	0.0170	0.0270	0.0340	0.0510	0.0680	0.0850	0.1020	
M1.1.1 Stainless steel, ferritic/martensitic, with machining additives	25	0.0035	0.0090	0.0145	0.0180	0.0270	0.0360	0.0450	0.0540	
M1.1.2 Stainless steel, ferritic/martensitic, annealed, Rm 680 N/mm ² , 200 HB	25	0.0030	0.0080	0.0130	0.0160	0.0245	0.0325	0.0405	0.0485	
M1.1.3 Stainless steel, ferritic/martensitic, heat-treated, Rm 810 N/mm ² , 240 HB	20	0.0030	0.0075	0.0120	0.0155	0.0230	0.0305	0.0380	0.0460	
M2.1.1 Stainless steel, austenitic, quenched, 180 HB	15	0.0020	0.0050	0.0080	0.0100	0.0150	0.0200	0.0250	0.0300	
M2.2.1 Duplex steel, high-strength stainless steels	15	0.0015	0.0045	0.0070	0.0085	0.0130	0.0170	0.0215	0.0255	
K1.1.1 Grey cast iron, pearlitic/ferritic, 180 HB	100	0.0080	0.0200	0.0320	0.0400	0.0600	0.0800	0.1000	0.1200	
K1.1.2 Grey cast iron, pearlitic/martensitic, 260 HB	85	0.0070	0.0170	0.0270	0.0340	0.0510	0.0680	0.0850	0.1020	
K1.2.1 Cast iron with spheroidal graphite, ferritic, 160 HB	85	0.0070	0.0170	0.0270	0.0340	0.0510	0.0680	0.0850	0.1020	
K1.2.2 Cast iron with spheroidal graphite, pearlitic, 250 HB	80	0.0065	0.0160	0.0255	0.0320	0.0480	0.0640	0.0800	0.0960	
K1.3.1 Malleable cast iron, ferritic, 130 HB	80	0.0065	0.0160	0.0255	0.0320	0.0480	0.0640	0.0800	0.0960	
K1.3.2 Malleable cast iron, pearlitic, 230 HB	70	0.0055	0.0140	0.0225	0.0280	0.0420	0.0560	0.0700	0.0840	
K2.1.1 Vermicular graphite cast iron (GJV)										
K2.2.1 Austenitic-ferritic spheroidal graphite cast iron (ADI)										
N1.1.1 Wrought aluminium alloys, non-hardened, 60 HB	100	0.0120	0.0300	0.0480	0.0600	0.0900	0.1200	0.1500	0.1800	
N1.1.2 Wrought aluminium alloys, hardened, 100 HB	100	0.0120	0.0300	0.0480	0.0600	0.0900	0.1200	0.1500	0.1800	
N2.1.1 Aluminium casting alloys, non-hardened, ≤ 12 % Si, 75 HB	75	0.0100	0.0250	0.0400	0.0500	0.0750	0.1000	0.1250	0.1500	
N2.1.2 Aluminium casting alloys, hardened, ≤ 12 % Si, 90 HB	75	0.0100	0.0250	0.0400	0.0500	0.0750	0.1000	0.1250	0.1500	
N2.1.3 Aluminium casting alloys, non-hardened, > 12 % Si, 130 HB	65	0.0085	0.0215	0.0340	0.0425	0.0640	0.0850	0.1065	0.1275	
N3.1.1 Copper and copper alloys: Free-machining alloy, Pb > 1 %	55	0.0080	0.0200	0.0320	0.0400	0.0600	0.0800	0.1000	0.1200	
N3.1.2 Copper and copper alloys: CuZn, CuSnZn	45	0.0070	0.0170	0.0270	0.0340	0.0510	0.0680	0.0850	0.1020	
N3.1.3 Copper and copper alloys: CuSn, lead-free copper and copper electrolyte	45	0.0065	0.0160	0.0255	0.0320	0.0480	0.0640	0.0800	0.0960	
N4.1.1 Non-metallic materials: Duroplastics, fibre-reinforced plastics										
N4.1.2 Non-metallic materials: Hard rubber, wood, etc.										
N4.1.3 Non-metallic materials: Graphite										
S1.1.1 Heat-resistant alloys, Fe-based, annealed, 200 HB	15	0.0020	0.0050	0.0080	0.0100	0.0150	0.0200	0.0250	0.0300	
S1.1.2 Heat-resistant alloys, Fe-based, hardened, 280 HB	10	0.0015	0.0040	0.0065	0.0080	0.0120	0.0160	0.0200	0.0240	
S1.1.3 Heat-resistant alloys, Ni- or Co-based, annealed, 250 HB	15	0.0020	0.0050	0.0080	0.0100	0.0150	0.0200	0.0250	0.0300	
S1.1.4 Heat-resistant alloys, Ni- or Co-based, hardened, 350 HB	10	0.0015	0.0035	0.0055	0.0070	0.0105	0.0140	0.0175	0.0210	
S1.1.5 Heat-resistant alloys, Ni- or Co-based, cast, 320 HB	10	0.0015	0.0035	0.0055	0.0070	0.0105	0.0140	0.0175	0.0210	
S2.1.1 Titanium alloys, pure titanium, Rm 400 N/mm ²	10	0.0020	0.0050	0.0080	0.0100	0.0150	0.0200	0.0250	0.0300	
S2.1.2 Titanium alloys, Alpha and Beta alloys, hardened, Rm 1050 N/mm ²	10	0.0015	0.0040	0.0065	0.0080	0.0120	0.0160	0.0200	0.0240	
H1.1.1 Hardened steel, hardened and tempered, < 55 HRC										
H1.1.2 Hardened steel, hardened and tempered, < 60 HRC										
H1.1.3 Hardened steel, hardened and tempered, > 60 HRC										
H2.1.1 Chilled cast iron, 400 HB										
H2.1.2 Chilled cast iron, hardened and tempered, < 55 HRC										



HSS-E-PM micro-precision drills without coolant ducts



Machining group			f (mm/rev) with nom. Ø										
			v _c (m/min)		0.05	0.2	0.5	0.8	1	1.2	1.5	1.8	2
P1.1.1 Unalloyed steel, annealed, 0.15 % C, Rm 420 N/mm ² , 125 HB	33	38	0.002	0.006	0.016	0.026	0.032	0.038	0.048	0.058	0.064		
P1.1.2 Unalloyed steel, heat-treated, 0.15 % C, Rm 420 N/mm ² , 125 HB	28	32	0.001	0.005	0.013	0.020	0.026	0.031	0.038	0.046	0.051		
P1.1.3 Unalloyed steel, annealed, 0.45 % C, Rm 640 N/mm ² , 190 HB	28	32	0.001	0.005	0.013	0.020	0.026	0.031	0.038	0.046	0.051		
P1.1.4 Unalloyed steel, heat-treated, 0.45 % C, Rm 640 N/mm ² , 190 HB	28	32	0.001	0.005	0.013	0.020	0.026	0.031	0.038	0.046	0.051		
P1.1.5 Unalloyed steel, heat-treated, 0.45 % C, Rm 850 N/mm ² , 250 HB	25	28	0.001	0.005	0.013	0.020	0.026	0.031	0.038	0.046	0.051		
P1.1.6 Unalloyed steel, annealed, 0.75 % C, Rm 915 N/mm ² , 270 HB	23	26	0.001	0.005	0.013	0.020	0.026	0.031	0.038	0.046	0.051		
P1.1.7 Unalloyed steel, heat-treated, 0.75 % C, Rm 1020 N/mm ² , 300 HB	20	23	0.001	0.005	0.013	0.020	0.026	0.031	0.038	0.046	0.051		
P2.1.1 Low-alloy steel, annealed, Rm 610 N/mm ² , 180 HB	20	23	0.001	0.004	0.010	0.016	0.020	0.025	0.031	0.037	0.041		
P2.1.2 Low-alloy steel, heat-treated, Rm 930 N/mm ² , 275 HB	14	16	0.001	0.003	0.008	0.013	0.016	0.020	0.025	0.030	0.033		
P2.1.3 Low-alloy steel, heat-treated, Rm 1020 N/mm ² , 300 HB	12	14	0.001	0.003	0.008	0.013	0.016	0.020	0.025	0.030	0.033		
P2.1.4 Low-alloy steel, heat-treated, Rm 1190 N/mm ² , 350 HB	11	13	0.001	0.003	0.006	0.010	0.013	0.015	0.019	0.023	0.026		
P3.1.1 High-alloy steel and tool steel, annealed, Rm 680 N/mm ² , 200 HB	15	17	0.001	0.004	0.010	0.016	0.020	0.025	0.031	0.037	0.041		
P3.1.2 High-alloy steel and tool steel, hardened and tempered, Rm 1100 N/mm ² , 325 HB	11	13	0.001	0.003	0.008	0.013	0.016	0.020	0.025	0.030	0.033		
M1.1.1 Stainless steel, ferritic/martensitic, with machining additives	12	13	0.001	0.003	0.008	0.013	0.016	0.019	0.024	0.029	0.032		
M1.1.2 Stainless steel, ferritic/martensitic, annealed, Rm 680 N/mm ² , 200 HB	11	12	0.001	0.003	0.008	0.013	0.016	0.019	0.024	0.029	0.032		
M1.1.3 Stainless steel, ferritic/martensitic, heat-treated, Rm 810 N/mm ² , 240 HB	10	11	0.001	0.003	0.006	0.010	0.013	0.015	0.019	0.023	0.026		
M2.1.1 Stainless steel, austenitic, quenched, 180 HB	9	11	0.001	0.003	0.008	0.013	0.016	0.019	0.024	0.029	0.032		
M2.2.1 Duplex steel, high-strength stainless steels		8	0.001	0.003	0.006	0.010	0.013	0.015	0.019	0.023	0.026		
K1.1.1 Grey cast iron, pearlitic/ferritic, 180 HB	35	40	0.002	0.006	0.016	0.026	0.032	0.038	0.048	0.058	0.064		
K1.1.2 Grey cast iron, pearlitic/martensitic, 260 HB	28	32	0.002	0.006	0.016	0.026	0.032	0.038	0.048	0.058	0.064		
K1.2.1 Cast iron with spheroidal graphite, ferritic, 160 HB	30	34	0.002	0.006	0.016	0.026	0.032	0.038	0.048	0.058	0.064		
K1.2.2 Cast iron with spheroidal graphite, pearlitic, 250 HB	23	26	0.001	0.005	0.013	0.020	0.026	0.031	0.038	0.046	0.051		
K1.3.1 Malleable cast iron, ferritic, 130 HB	30	34	0.002	0.006	0.016	0.026	0.032	0.038	0.048	0.058	0.064		
K1.3.2 Malleable cast iron, pearlitic, 230 HB	23	26	0.001	0.005	0.013	0.020	0.026	0.031	0.038	0.046	0.051		
K2.1.1 Vermicular graphite cast iron (GJV)	29	34	0.001	0.005	0.013	0.020	0.026	0.031	0.038	0.046	0.051		
K2.2.1 Austenitic-ferritic spheroidal graphite cast iron (ADI)		17	0.001	0.003	0.006	0.010	0.013	0.015	0.019	0.023	0.026		
N1.1.1 Wrought aluminium alloys, non-hardened, 60 HB	70		0.002	0.008	0.020	0.033	0.041	0.049	0.061	0.074	0.082		
N1.1.2 Wrought aluminium alloys, hardened, 100 HB	70		0.002	0.008	0.020	0.033	0.041	0.049	0.061	0.074	0.082		
N2.1.1 Aluminium casting alloys, non-hardened, ≤ 12 % Si, 75 HB	59	67	0.002	0.006	0.016	0.026	0.032	0.038	0.048	0.058	0.064		
N2.1.2 Aluminium casting alloys, hardened, ≤ 12 % Si, 90 HB	47	54	0.001	0.005	0.013	0.020	0.026	0.031	0.038	0.046	0.051		
N2.1.3 Aluminium casting alloys, non-hardened, > 12 % Si, 130 HB	41	47	0.001	0.005	0.013	0.020	0.026	0.031	0.038	0.046	0.051		
N3.1.1 Copper and copper alloys: Free-machining alloy, Pb > 1 %	70	81	0.001	0.005	0.013	0.020	0.026	0.031	0.038	0.046	0.051		
N3.1.2 Copper and copper alloys: CuZn, CuSnZn	42	48	0.001	0.004	0.010	0.016	0.020	0.025	0.031	0.037	0.041		
N3.1.3 Copper and copper alloys: CuSn, lead-free copper and copper electrolyte	56	65	0.001	0.004	0.010	0.016	0.020	0.025	0.031	0.037	0.041		
N4.1.1 Non-metallic materials: Duroplastics, fibre-reinforced plastics	23	27	0.001	0.005	0.013	0.020	0.026	0.031	0.038	0.046	0.051		
N4.1.2 Non-metallic materials: Hard rubber, wood, etc.	23	27	0.001	0.005	0.013	0.020	0.026	0.031	0.038	0.046	0.051		
N4.1.3 Non-metallic materials: Graphite													
S1.1.1 Heat-resistant alloys, Fe-based, annealed, 200 HB	7	8	0.001	0.003	0.006	0.010	0.013	0.015	0.019	0.023	0.026		
S1.1.2 Heat-resistant alloys, Fe-based, hardened, 280 HB	6	6	0.001	0.002	0.005	0.008	0.010	0.012	0.015	0.018	0.020		
S1.1.3 Heat-resistant alloys, Ni- or Co-based, annealed, 250 HB	6	7	0.001	0.003	0.006	0.010	0.013	0.015	0.019	0.023	0.026		
S1.1.4 Heat-resistant alloys, Ni- or Co-based, hardened, 350 HB	4	4	0.001	0.002	0.005	0.008	0.010	0.012	0.015	0.018	0.020		
S1.1.5 Heat-resistant alloys, Ni- or Co-based, cast, 320 HB	4	5	0.001	0.002	0.005	0.008	0.010	0.012	0.015	0.018	0.020		
S2.1.1 Titanium alloys, pure titanium, Rm 400 N/mm ²	6	7	0.001	0.003	0.006	0.010	0.013	0.015	0.019	0.023	0.026		
S2.1.2 Titanium alloys, Alpha and Beta alloys, hardened, Rm 1050 N/mm ²	4	4	0.001	0.002	0.005	0.008	0.010	0.012	0.015	0.018	0.020		
H1.1.1 Hardened steel, hardened and tempered, < 55 HRC													
H1.1.2 Hardened steel, hardened and tempered, < 60 HRC													
H1.1.3 Hardened steel, hardened and tempered, > 60 HRC													
H2.1.1 Chilled cast iron, 400 HB													
H2.1.2 Chilled cast iron, hardened and tempered, < 55 HRC													



EXCLUSIVELINE®

MICRO-PRECISION DRILLS VA

SIGNIFICANTLY LONGER TOOL LIVES AND FEED

RATES IN DIFFICULT-TO-MACHINE MATERIALS

- Reliable chip removal thanks to smooth surfaces and HiPIMS coating
- Up to twice the feed rate
- The newly developed flute profile with a concave main cutting edge for more aggressive cutting behaviour
- Ø 0,5 – 3,0 mm | with IC from Ø 1,0 mm



Pilot drills with coolant ducts, RT 100 FB





Machining group		f (mm/rev) with nom. Ø							
	v _c (m/min)	3	6	8	10	12	14	16	20
P1.1.1 Unalloyed steel, annealed, 0.15 % C, Rm 420 N/mm ² , 125 HB	100	0.075	0.130	0.160	0.190	0.220	0.250	0.275	0.325
P1.1.2 Unalloyed steel, heat-treated, 0.15 % C, Rm 420 N/mm ² , 125 HB	90	0.070	0.115	0.145	0.175	0.200	0.225	0.245	0.295
P1.1.3 Unalloyed steel, annealed, 0.45 % C, Rm 640 N/mm ² , 190 HB	90	0.070	0.115	0.145	0.175	0.200	0.225	0.245	0.295
P1.1.4 Unalloyed steel, heat-treated, 0.45 % C, Rm 640 N/mm ² , 190 HB	85	0.065	0.110	0.140	0.165	0.185	0.210	0.235	0.275
P1.1.5 Unalloyed steel, heat-treated, 0.45 % C, Rm 850 N/mm ² , 250 HB	85	0.065	0.110	0.140	0.165	0.185	0.210	0.235	0.275
P1.1.6 Unalloyed steel, annealed, 0.75 % C, Rm 915 N/mm ² , 270 HB	80	0.060	0.105	0.130	0.155	0.175	0.200	0.220	0.260
P1.1.7 Unalloyed steel, heat-treated, 0.75 % C, Rm 1020 N/mm ² , 300 HB	75	0.060	0.100	0.120	0.145	0.165	0.185	0.205	0.245
P2.1.1 Low-alloy steel, annealed, Rm 610 N/mm ² , 180 HB	80	0.060	0.105	0.130	0.155	0.175	0.200	0.220	0.260
P2.1.2 Low-alloy steel, heat-treated, Rm 930 N/mm ² , 275 HB	80	0.060	0.105	0.130	0.155	0.175	0.200	0.220	0.260
P2.1.3 Low-alloy steel, heat-treated, Rm 1020 N/mm ² , 300 HB	70	0.050	0.090	0.110	0.130	0.150	0.170	0.185	0.220
P2.1.4 Low-alloy steel, heat-treated, Rm 1190 N/mm ² , 350 HB	60	0.045	0.080	0.095	0.115	0.130	0.150	0.165	0.195
P3.1.1 High-alloy steel and tool steel, annealed, Rm 680 N/mm ² , 200 HB	50	0.050	0.080	0.100	0.120	0.140	0.155	0.175	0.205
P3.1.2 High-alloy steel and tool steel, hardened and tempered, Rm 1100 N/mm ² , 325 HB	45	0.040	0.070	0.085	0.105	0.120	0.135	0.145	0.175
M1.1.1 Stainless steel, ferritic/martensitic, with machining additives	45	0.050	0.080	0.100	0.120	0.140	0.155	0.175	0.205
M1.1.2 Stainless steel, ferritic/martensitic, annealed, Rm 680 N/mm ² , 200 HB	40	0.045	0.075	0.090	0.110	0.125	0.140	0.155	0.185
M1.1.3 Stainless steel, ferritic/martensitic, heat-treated, Rm 810 N/mm ² , 240 HB	40	0.040	0.070	0.085	0.105	0.120	0.135	0.145	0.175
M2.1.1 Stainless steel, austenitic, quenched, 180 HB	40	0.050	0.080	0.100	0.120	0.140	0.155	0.175	0.205
M2.2.1 Duplex steel, high-strength stainless steels	35	0.040	0.070	0.085	0.105	0.120	0.135	0.145	0.175
K1.1.1 Grey cast iron, pearlitic/ferritic, 180 HB	100	0.075	0.130	0.160	0.190	0.220	0.250	0.275	0.325
K1.1.2 Grey cast iron, pearlitic/martensitic, 260 HB	85	0.065	0.110	0.140	0.165	0.185	0.210	0.235	0.275
K1.2.1 Cast iron with spheroidal graphite, ferritic, 160 HB	85	0.065	0.110	0.140	0.165	0.185	0.210	0.235	0.275
K1.2.2 Cast iron with spheroidal graphite, pearlitic, 250 HB	80	0.060	0.105	0.130	0.155	0.175	0.200	0.220	0.260
K1.3.1 Malleable cast iron, ferritic, 130 HB	80	0.060	0.105	0.130	0.155	0.175	0.200	0.220	0.260
K1.3.2 Malleable cast iron, pearlitic, 230 HB	70	0.055	0.090	0.115	0.135	0.155	0.175	0.190	0.230
K2.1.1 Vermicular graphite cast iron (GJV)	80	0.075	0.130	0.160	0.190	0.220	0.250	0.275	0.325
K2.2.1 Austenitic-ferritic spheroidal graphite cast iron (ADI)	60	0.060	0.100	0.120	0.145	0.165	0.185	0.205	0.245
N1.1.1 Wrought aluminium alloys, non-hardened, 60 HB	185	0.095	0.165	0.205	0.240	0.275	0.310	0.345	0.405
N1.1.2 Wrought aluminium alloys, hardened, 100 HB	185	0.095	0.165	0.205	0.240	0.275	0.310	0.345	0.405
N2.1.1 Aluminium casting alloys, non-hardened, ≤ 12 % Si, 75 HB	170	0.095	0.165	0.205	0.240	0.275	0.310	0.345	0.405
N2.1.2 Aluminium casting alloys, hardened, ≤ 12 % Si, 90 HB	170	0.095	0.165	0.205	0.240	0.275	0.310	0.345	0.405
N2.1.3 Aluminium casting alloys, non-hardened, > 12 % Si, 130 HB	145	0.080	0.140	0.170	0.205	0.235	0.265	0.290	0.345
N3.1.1 Copper and copper alloys: Free-machining alloy, Pb > 1 %	120	0.095	0.165	0.205	0.240	0.275	0.310	0.345	0.405
N3.1.2 Copper and copper alloys: CuZn, CuSnZn	100	0.080	0.140	0.170	0.205	0.235	0.265	0.290	0.345
N3.1.3 Copper and copper alloys: CuSn, lead-free copper and copper electrolyte	95	0.075	0.130	0.160	0.190	0.220	0.250	0.275	0.325
N4.1.1 Non-metallic materials: Duroplastics, fibre-reinforced plastics									
N4.1.2 Non-metallic materials: Hard rubber, wood, etc.									
N4.1.3 Non-metallic materials: Graphite									
S1.1.1 Heat-resistant alloys, Fe-based, annealed, 200 HB	30	0.050	0.080	0.100	0.120	0.140	0.155	0.175	0.205
S1.1.2 Heat-resistant alloys, Fe-based, hardened, 280 HB	25	0.040	0.065	0.080	0.095	0.110	0.125	0.140	0.165
S1.1.3 Heat-resistant alloys, Ni- or Co-based, annealed, 250 HB	25	0.050	0.080	0.100	0.120	0.140	0.155	0.175	0.205
S1.1.4 Heat-resistant alloys, Ni- or Co-based, hardened, 350 HB	15	0.035	0.055	0.070	0.085	0.095	0.110	0.120	0.145
S1.1.5 Heat-resistant alloys, Ni- or Co-based, cast, 320 HB	20	0.035	0.055	0.070	0.085	0.095	0.110	0.120	0.145
S2.1.1 Titanium alloys, pure titanium, Rm 400 N/mm ²	30	0.050	0.080	0.100	0.120	0.140	0.155	0.175	0.205
S2.1.2 Titanium alloys, Alpha and Beta alloys, hardened, Rm 1050 N/mm ²	25	0.040	0.065	0.080	0.095	0.110	0.125	0.140	0.165
H1.1.1 Hardened steel, hardened and tempered, < 55 HRC	35	0.030	0.050	0.065	0.075	0.090	0.100	0.110	0.130
H1.1.2 Hardened steel, hardened and tempered, < 60 HRC									
H1.1.3 Hardened steel, hardened and tempered, > 60 HRC									
H2.1.1 Chilled cast iron, 400 HB	25	0.040	0.065	0.080	0.095	0.110	0.125	0.135	0.165
H2.1.2 Chilled cast iron, hardened and tempered, < 55 HRC	20	0.025	0.045	0.055	0.065	0.075	0.085	0.095	0.115



Ratio drills without coolant ducts, RT 100 U, 3xD





Machining group		f (mm/rev) with nom. Ø							
		v _c (m/min)	3	6	8	10	12	14	16
									
P1.1.1 Unalloyed steel, annealed, 0.15 % C, Rm 420 N/mm ² , 125 HB	130	0.155	0.260	0.325	0.385	0.440	0.495	0.550	0.650
P1.1.2 Unalloyed steel, heat-treated, 0.15 % C, Rm 420 N/mm ² , 125 HB	115	0.140	0.235	0.290	0.345	0.395	0.445	0.495	0.585
P1.1.3 Unalloyed steel, annealed, 0.45 % C, Rm 640 N/mm ² , 190 HB	115	0.140	0.235	0.290	0.345	0.395	0.445	0.495	0.585
P1.1.4 Unalloyed steel, heat-treated, 0.45 % C, Rm 640 N/mm ² , 190 HB	110	0.130	0.220	0.275	0.325	0.375	0.420	0.465	0.555
P1.1.5 Unalloyed steel, heat-treated, 0.45 % C, Rm 850 N/mm ² , 250 HB	110	0.130	0.220	0.275	0.325	0.375	0.420	0.465	0.555
P1.1.6 Unalloyed steel, annealed, 0.75 % C, Rm 915 N/mm ² , 270 HB	105	0.125	0.210	0.260	0.305	0.355	0.395	0.440	0.520
P1.1.7 Unalloyed steel, heat-treated, 0.75 % C, Rm 1020 N/mm ² , 300 HB	100	0.115	0.195	0.245	0.290	0.330	0.370	0.410	0.490
P2.1.1 Low-alloy steel, annealed, Rm 610 N/mm ² , 180 HB	105	0.125	0.210	0.260	0.305	0.355	0.395	0.440	0.520
P2.1.2 Low-alloy steel, heat-treated, Rm 930 N/mm ² , 275 HB	105	0.125	0.210	0.260	0.305	0.355	0.395	0.440	0.520
P2.1.3 Low-alloy steel, heat-treated, Rm 1020 N/mm ² , 300 HB	90	0.105	0.175	0.220	0.260	0.300	0.335	0.375	0.440
P2.1.4 Low-alloy steel, heat-treated, Rm 1190 N/mm ² , 350 HB	80	0.090	0.155	0.195	0.230	0.265	0.295	0.330	0.390
P3.1.1 High-alloy steel and tool steel, annealed, Rm 680 N/mm ² , 200 HB	65	0.095	0.165	0.205	0.240	0.275	0.310	0.345	0.405
P3.1.2 High-alloy steel and tool steel, hardened and tempered, Rm 1100 N/mm ² , 325 HB	55	0.080	0.140	0.170	0.205	0.235	0.265	0.290	0.345
M1.1.1 Stainless steel, ferritic/martensitic, with machining additives	40	0.040	0.065	0.080	0.095	0.110	0.125	0.135	0.165
M1.1.2 Stainless steel, ferritic/martensitic, annealed, Rm 680 N/mm ² , 200 HB	35	0.035	0.060	0.075	0.085	0.100	0.110	0.125	0.145
M1.1.3 Stainless steel, ferritic/martensitic, heat-treated, Rm 810 N/mm ² , 240 HB	35	0.035	0.055	0.070	0.080	0.095	0.105	0.115	0.140
M2.1.1 Stainless steel, austenitic, quenched, 180 HB	25	0.030	0.050	0.065	0.075	0.090	0.100	0.110	0.130
M2.2.1 Duplex steel, high-strength stainless steels	20	0.025	0.045	0.055	0.065	0.075	0.085	0.095	0.110
K1.1.1 Grey cast iron, pearlitic/ferritic, 180 HB	90	0.125	0.210	0.260	0.305	0.355	0.395	0.440	0.520
K1.1.2 Grey cast iron, pearlitic/martensitic, 260 HB	75	0.105	0.175	0.220	0.260	0.300	0.335	0.375	0.440
K1.2.1 Cast iron with spheroidal graphite, ferritic, 160 HB	75	0.105	0.175	0.220	0.260	0.300	0.335	0.375	0.440
K1.2.2 Cast iron with spheroidal graphite, pearlitic, 250 HB	70	0.100	0.165	0.205	0.245	0.280	0.315	0.350	0.415
K1.3.1 Malleable cast iron, ferritic, 130 HB	70	0.100	0.165	0.205	0.245	0.280	0.315	0.350	0.415
K1.3.2 Malleable cast iron, pearlitic, 230 HB	65	0.085	0.145	0.180	0.215	0.245	0.280	0.305	0.365
K2.1.1 Vermicular graphite cast iron (GJV)	70	0.125	0.210	0.260	0.305	0.355	0.395	0.440	0.520
K2.2.1 Austenitic-ferritic spheroidal graphite cast iron (ADI)	55	0.090	0.155	0.195	0.230	0.265	0.295	0.330	0.390
N1.1.1 Wrought aluminium alloys, non-hardened, 60 HB	165	0.125	0.210	0.260	0.305	0.355	0.395	0.440	0.520
N1.1.2 Wrought aluminium alloys, hardened, 100 HB	165	0.125	0.210	0.260	0.305	0.355	0.395	0.440	0.520
N2.1.1 Aluminium casting alloys, non-hardened, ≤ 12 % Si, 75 HB	150	0.125	0.210	0.260	0.305	0.355	0.395	0.440	0.520
N2.1.2 Aluminium casting alloys, hardened, ≤ 12 % Si, 90 HB	150	0.125	0.210	0.260	0.305	0.355	0.395	0.440	0.520
N2.1.3 Aluminium casting alloys, non-hardened, > 12 % Si, 130 HB	130	0.105	0.175	0.220	0.260	0.300	0.335	0.375	0.440
N3.1.1 Copper and copper alloys: Free-machining alloy, Pb > 1 %	110	0.095	0.165	0.205	0.240	0.275	0.310	0.345	0.405
N3.1.2 Copper and copper alloys: CuZn, CuSnZn	95	0.080	0.140	0.170	0.205	0.235	0.265	0.290	0.345
N3.1.3 Copper and copper alloys: CuSn, lead-free copper and copper electrolyte	90	0.075	0.130	0.160	0.190	0.220	0.250	0.275	0.325
N4.1.1 Non-metallic materials: Duroplastics, fibre-reinforced plastics									
N4.1.2 Non-metallic materials: Hard rubber, wood, etc.									
N4.1.3 Non-metallic materials: Graphite									
S1.1.1 Heat-resistant alloys, Fe-based, annealed, 200 HB	30	0.060	0.105	0.130	0.155	0.175	0.200	0.220	0.260
S1.1.2 Heat-resistant alloys, Fe-based, hardened, 280 HB	25	0.050	0.085	0.105	0.120	0.140	0.160	0.175	0.205
S1.1.3 Heat-resistant alloys, Ni- or Co-based, annealed, 250 HB	25	0.060	0.105	0.130	0.155	0.175	0.200	0.220	0.260
S1.1.4 Heat-resistant alloys, Ni- or Co-based, hardened, 350 HB	15	0.045	0.075	0.090	0.105	0.125	0.140	0.155	0.180
S1.1.5 Heat-resistant alloys, Ni- or Co-based, cast, 320 HB	20	0.045	0.075	0.090	0.105	0.125	0.140	0.155	0.180
S2.1.1 Titanium alloys, pure titanium, Rm 400 N/mm ²	15	0.030	0.050	0.065	0.075	0.090	0.100	0.110	0.130
S2.1.2 Titanium alloys, Alpha and Beta alloys, hardened, Rm 1050 N/mm ²	10	0.025	0.040	0.050	0.060	0.070	0.080	0.090	0.105
H1.1.1 Hardened steel, hardened and tempered, < 55 HRC	35	0.030	0.050	0.065	0.075	0.090	0.100	0.110	0.130
H1.1.2 Hardened steel, hardened and tempered, < 60 HRC	25	0.025	0.040	0.050	0.060	0.070	0.080	0.090	0.105
H1.1.3 Hardened steel, hardened and tempered, > 60 HRC	20	0.025	0.040	0.050	0.060	0.065	0.075	0.085	0.100
H2.1.1 Chilled cast iron, 400 HB	25	0.040	0.065	0.080	0.095	0.110	0.125	0.135	0.165
H2.1.2 Chilled cast iron, hardened and tempered, < 55 HRC	20	0.025	0.045	0.055	0.065	0.075	0.085	0.095	0.115



Ratio drills without coolant ducts, RT 100 U, 5xD



Machining group		f (mm/rev) with nom. Ø							
		v _c (m/min)	3	6	8	10	12	14	16
									
P1.1.1 Unalloyed steel, annealed, 0.15 % C, Rm 420 N/mm ² , 125 HB	130	0.155	0.260	0.325	0.385	0.440	0.495	0.550	0.650
P1.1.2 Unalloyed steel, heat-treated, 0.15 % C, Rm 420 N/mm ² , 125 HB	115	0.140	0.235	0.290	0.345	0.395	0.445	0.495	0.585
P1.1.3 Unalloyed steel, annealed, 0.45 % C, Rm 640 N/mm ² , 190 HB	115	0.140	0.235	0.290	0.345	0.395	0.445	0.495	0.585
P1.1.4 Unalloyed steel, heat-treated, 0.45 % C, Rm 640 N/mm ² , 190 HB	110	0.130	0.220	0.275	0.325	0.375	0.420	0.465	0.555
P1.1.5 Unalloyed steel, heat-treated, 0.45 % C, Rm 850 N/mm ² , 250 HB	110	0.130	0.220	0.275	0.325	0.375	0.420	0.465	0.555
P1.1.6 Unalloyed steel, annealed, 0.75 % C, Rm 915 N/mm ² , 270 HB	105	0.125	0.210	0.260	0.305	0.355	0.395	0.440	0.520
P1.1.7 Unalloyed steel, heat-treated, 0.75 % C, Rm 1020 N/mm ² , 300 HB	100	0.115	0.195	0.245	0.290	0.330	0.370	0.410	0.490
P2.1.1 Low-alloy steel, annealed, Rm 610 N/mm ² , 180 HB	105	0.125	0.210	0.260	0.305	0.355	0.395	0.440	0.520
P2.1.2 Low-alloy steel, heat-treated, Rm 930 N/mm ² , 275 HB	105	0.125	0.210	0.260	0.305	0.355	0.395	0.440	0.520
P2.1.3 Low-alloy steel, heat-treated, Rm 1020 N/mm ² , 300 HB	90	0.105	0.175	0.220	0.260	0.300	0.335	0.375	0.440
P2.1.4 Low-alloy steel, heat-treated, Rm 1190 N/mm ² , 350 HB	80	0.090	0.155	0.195	0.230	0.265	0.295	0.330	0.390
P3.1.1 High-alloy steel and tool steel, annealed, Rm 680 N/mm ² , 200 HB	65	0.095	0.165	0.205	0.240	0.275	0.310	0.345	0.405
P3.1.2 High-alloy steel and tool steel, hardened and tempered, Rm 1100 N/mm ² , 325 HB	55	0.080	0.140	0.170	0.205	0.235	0.265	0.290	0.345
M1.1.1 Stainless steel, ferritic/martensitic, with machining additives	45	0.040	0.065	0.080	0.095	0.110	0.125	0.135	0.165
M1.1.2 Stainless steel, ferritic/martensitic, annealed, Rm 680 N/mm ² , 200 HB	40	0.035	0.060	0.075	0.085	0.100	0.110	0.125	0.145
M1.1.3 Stainless steel, ferritic/martensitic, heat-treated, Rm 810 N/mm ² , 240 HB	40	0.035	0.055	0.070	0.080	0.095	0.105	0.115	0.140
M2.1.1 Stainless steel, austenitic, quenched, 180 HB	25	0.030	0.050	0.065	0.075	0.090	0.100	0.110	0.130
M2.2.1 Duplex steel, high-strength stainless steels	20	0.025	0.045	0.055	0.065	0.075	0.085	0.095	0.110
K1.1.1 Grey cast iron, pearlitic/ferritic, 180 HB	90	0.125	0.210	0.260	0.305	0.355	0.395	0.440	0.520
K1.1.2 Grey cast iron, pearlitic/martensitic, 260 HB	75	0.105	0.175	0.220	0.260	0.300	0.335	0.375	0.440
K1.2.1 Cast iron with spheroidal graphite, ferritic, 160 HB	75	0.105	0.175	0.220	0.260	0.300	0.335	0.375	0.440
K1.2.2 Cast iron with spheroidal graphite, pearlitic, 250 HB	70	0.100	0.165	0.205	0.245	0.280	0.315	0.350	0.415
K1.3.1 Malleable cast iron, ferritic, 130 HB	70	0.100	0.165	0.205	0.245	0.280	0.315	0.350	0.415
K1.3.2 Malleable cast iron, pearlitic, 230 HB	65	0.085	0.145	0.180	0.215	0.245	0.280	0.305	0.365
K2.1.1 Vermicular graphite cast iron (GJV)	70	0.125	0.210	0.260	0.305	0.355	0.395	0.440	0.520
K2.2.1 Austenitic-ferritic spheroidal graphite cast iron (ADI)	55	0.090	0.155	0.195	0.230	0.265	0.295	0.330	0.390
N1.1.1 Wrought aluminium alloys, non-hardened, 60 HB	165	0.125	0.210	0.260	0.305	0.355	0.395	0.440	0.520
N1.1.2 Wrought aluminium alloys, hardened, 100 HB	165	0.125	0.210	0.260	0.305	0.355	0.395	0.440	0.520
N2.1.1 Aluminium casting alloys, non-hardened, ≤ 12 % Si, 75 HB	150	0.125	0.210	0.260	0.305	0.355	0.395	0.440	0.520
N2.1.2 Aluminium casting alloys, hardened, ≤ 12 % Si, 90 HB	150	0.125	0.210	0.260	0.305	0.355	0.395	0.440	0.520
N2.1.3 Aluminium casting alloys, non-hardened, > 12 % Si, 130 HB	130	0.105	0.175	0.220	0.260	0.300	0.335	0.375	0.440
N3.1.1 Copper and copper alloys: Free-machining alloy, Pb > 1 %	130	0.125	0.210	0.260	0.305	0.355	0.395	0.440	0.520
N3.1.2 Copper and copper alloys: CuZn, CuSnZn	110	0.105	0.175	0.220	0.260	0.300	0.335	0.375	0.440
N3.1.3 Copper and copper alloys: CuSn, lead-free copper and copper electrolyte	105	0.100	0.165	0.205	0.245	0.280	0.315	0.350	0.415
N4.1.1 Non-metallic materials: Duroplastics, fibre-reinforced plastics									
N4.1.2 Non-metallic materials: Hard rubber, wood, etc.									
N4.1.3 Non-metallic materials: Graphite									
S1.1.1 Heat-resistant alloys, Fe-based, annealed, 200 HB	30	0.050	0.080	0.100	0.120	0.140	0.155	0.175	0.205
S1.1.2 Heat-resistant alloys, Fe-based, hardened, 280 HB	25	0.040	0.065	0.080	0.095	0.110	0.125	0.140	0.165
S1.1.3 Heat-resistant alloys, Ni- or Co-based, annealed, 250 HB	25	0.050	0.080	0.100	0.120	0.140	0.155	0.175	0.205
S1.1.4 Heat-resistant alloys, Ni- or Co-based, hardened, 350 HB	15	0.035	0.055	0.070	0.085	0.095	0.110	0.120	0.145
S1.1.5 Heat-resistant alloys, Ni- or Co-based, cast, 320 HB	20	0.035	0.055	0.070	0.085	0.095	0.110	0.120	0.145
S2.1.1 Titanium alloys, pure titanium, Rm 400 N/mm ²	15	0.030	0.050	0.065	0.075	0.090	0.100	0.110	0.130
S2.1.2 Titanium alloys, Alpha and Beta alloys, hardened, Rm 1050 N/mm ²	10	0.025	0.040	0.050	0.060	0.070	0.080	0.090	0.105
H1.1.1 Hardened steel, hardened and tempered, < 55 HRC	35	0.030	0.050	0.065	0.075	0.090	0.100	0.110	0.130
H1.1.2 Hardened steel, hardened and tempered, < 60 HRC	25	0.025	0.040	0.050	0.060	0.070	0.080	0.090	0.105
H1.1.3 Hardened steel, hardened and tempered, > 60 HRC	20	0.025	0.040	0.050	0.060	0.065	0.075	0.085	0.100
H2.1.1 Chilled cast iron, 400 HB	25	0.040	0.065	0.080	0.095	0.110	0.125	0.135	0.165
H2.1.2 Chilled cast iron, hardened and tempered, < 55 HRC	20	0.025	0.045	0.055	0.065	0.075	0.085	0.095	0.115



Ratio drills without coolant ducts, RT 100 HF, 3xD



Machining group		f (mm/rev) with nom. Ø								
			3	6	8	10	12	14	16	20
	v _c (m/min)									
P1.1.1 Unalloyed steel, annealed, 0.15 % C, Rm 420 N/mm ² , 125 HB		130	0.155	0.260	0.325	0.385	0.440	0.495	0.550	0.650
P1.1.2 Unalloyed steel, heat-treated, 0.15 % C, Rm 420 N/mm ² , 125 HB		115	0.140	0.235	0.290	0.345	0.395	0.445	0.495	0.585
P1.1.3 Unalloyed steel, annealed, 0.45 % C, Rm 640 N/mm ² , 190 HB		115	0.140	0.235	0.290	0.345	0.395	0.445	0.495	0.585
P1.1.4 Unalloyed steel, heat-treated, 0.45 % C, Rm 640 N/mm ² , 190 HB		110	0.130	0.220	0.275	0.325	0.375	0.420	0.465	0.555
P1.1.5 Unalloyed steel, heat-treated, 0.45 % C, Rm 850 N/mm ² , 250 HB		110	0.130	0.220	0.275	0.325	0.375	0.420	0.465	0.555
P1.1.6 Unalloyed steel, annealed, 0.75 % C, Rm 915 N/mm ² , 270 HB		105	0.125	0.210	0.260	0.305	0.355	0.395	0.440	0.520
P1.1.7 Unalloyed steel, heat-treated, 0.75 % C, Rm 1020 N/mm ² , 300 HB		100	0.115	0.195	0.245	0.290	0.330	0.370	0.410	0.490
P2.1.1 Low-alloy steel, annealed, Rm 610 N/mm ² , 180 HB		105	0.125	0.210	0.260	0.305	0.355	0.395	0.440	0.520
P2.1.2 Low-alloy steel, heat-treated, Rm 930 N/mm ² , 275 HB		105	0.125	0.210	0.260	0.305	0.355	0.395	0.440	0.520
P2.1.3 Low-alloy steel, heat-treated, Rm 1020 N/mm ² , 300 HB		90	0.105	0.175	0.220	0.260	0.300	0.335	0.375	0.440
P2.1.4 Low-alloy steel, heat-treated, Rm 1190 N/mm ² , 350 HB		80	0.090	0.155	0.195	0.230	0.265	0.295	0.330	0.390
P3.1.1 High-alloy steel and tool steel, annealed, Rm 680 N/mm ² , 200 HB		65	0.095	0.165	0.205	0.240	0.275	0.310	0.345	0.405
P3.1.2 High-alloy steel and tool steel, hardened and tempered, Rm 1100 N/mm ² , 325 HB		55	0.080	0.140	0.170	0.205	0.235	0.265	0.290	0.345
M1.1.1 Stainless steel, ferritic/martensitic, with machining additives										
M1.1.2 Stainless steel, ferritic/martensitic, annealed, Rm 680 N/mm ² , 200 HB										
M1.1.3 Stainless steel, ferritic/martensitic, heat-treated, Rm 810 N/mm ² , 240 HB										
M2.1.1 Stainless steel, austenitic, quenched, 180 HB										
M2.2.1 Duplex steel, high-strength stainless steels										
K1.1.1 Grey cast iron, pearlitic/ferritic, 180 HB										
K1.1.2 Grey cast iron, pearlitic/martensitic, 260 HB										
K1.2.1 Cast iron with spheroidal graphite, ferritic, 160 HB										
K1.2.2 Cast iron with spheroidal graphite, pearlitic, 250 HB										
K1.3.1 Malleable cast iron, ferritic, 130 HB										
K1.3.2 Malleable cast iron, pearlitic, 230 HB										
K2.1.1 Vermicular graphite cast iron (GJV)										
K2.2.1 Austenitic-ferritic spheroidal graphite cast iron (ADI)										
N1.1.1 Wrought aluminium alloys, non-hardened, 60 HB										
N1.1.2 Wrought aluminium alloys, hardened, 100 HB										
N2.1.1 Aluminium casting alloys, non-hardened, ≤ 12 % Si, 75 HB										
N2.1.2 Aluminium casting alloys, hardened, ≤ 12 % Si, 90 HB										
N2.1.3 Aluminium casting alloys, non-hardened, > 12 % Si, 130 HB										
N3.1.1 Copper and copper alloys: Free-machining alloy, Pb > 1 %										
N3.1.2 Copper and copper alloys: CuZn, CuSnZn										
N3.1.3 Copper and copper alloys: CuSn, lead-free copper and copper electrolyte										
N4.1.1 Non-metallic materials: Duroplastics, fibre-reinforced plastics										
N4.1.2 Non-metallic materials: Hard rubber, wood, etc.										
N4.1.3 Non-metallic materials: Graphite										
S1.1.1 Heat-resistant alloys, Fe-based, annealed, 200 HB		30	0.060	0.105	0.130	0.155	0.175	0.200	0.220	0.260
S1.1.2 Heat-resistant alloys, Fe-based, hardened, 280 HB		25	0.050	0.085	0.105	0.120	0.140	0.160	0.175	0.205
S1.1.3 Heat-resistant alloys, Ni- or Co-based, annealed, 250 HB		25	0.060	0.105	0.130	0.155	0.175	0.200	0.220	0.260
S1.1.4 Heat-resistant alloys, Ni- or Co-based, hardened, 350 HB		15	0.045	0.075	0.090	0.105	0.125	0.140	0.155	0.180
S1.1.5 Heat-resistant alloys, Ni- or Co-based, cast, 320 HB		20	0.045	0.075	0.090	0.105	0.125	0.140	0.155	0.180
S2.1.1 Titanium alloys, pure titanium, Rm 400 N/mm ²		20	0.030	0.050	0.065	0.075	0.090	0.100	0.110	0.130
S2.1.2 Titanium alloys, Alpha and Beta alloys, hardened, Rm 1050 N/mm ²		15	0.025	0.040	0.050	0.060	0.070	0.080	0.090	0.105
H1.1.1 Hardened steel, hardened and tempered, < 55 HRC		40	0.030	0.050	0.065	0.075	0.090	0.100	0.110	0.130
H1.1.2 Hardened steel, hardened and tempered, < 60 HRC		25	0.025	0.040	0.050	0.060	0.070	0.080	0.090	0.105
H1.1.3 Hardened steel, hardened and tempered, > 60 HRC		25	0.025	0.040	0.050	0.060	0.065	0.075	0.085	0.100
H2.1.1 Chilled cast iron, 400 HB										
H2.1.2 Chilled cast iron, hardened and tempered, < 55 HRC										



Ratio drills with coolant ducts, RT 100 U, 3xD





Machining group		f (mm/rev) with nom. Ø							
		F							
	v _c (m/min)	3	6	8	10	12	14	16	20
P1.1.1 Unalloyed steel, annealed, 0.15 % C, Rm 420 N/mm ² , 125 HB	145	0.155	0.260	0.325	0.385	0.440	0.495	0.550	0.650
P1.1.2 Unalloyed steel, heat-treated, 0.15 % C, Rm 420 N/mm ² , 125 HB	130	0.140	0.235	0.290	0.345	0.395	0.445	0.495	0.585
P1.1.3 Unalloyed steel, annealed, 0.45 % C, Rm 640 N/mm ² , 190 HB	130	0.140	0.235	0.290	0.345	0.395	0.445	0.495	0.585
P1.1.4 Unalloyed steel, heat-treated, 0.45 % C, Rm 640 N/mm ² , 190 HB	125	0.130	0.220	0.275	0.325	0.375	0.420	0.465	0.555
P1.1.5 Unalloyed steel, heat-treated, 0.45 % C, Rm 850 N/mm ² , 250 HB	125	0.130	0.220	0.275	0.325	0.375	0.420	0.465	0.555
P1.1.6 Unalloyed steel, annealed, 0.75 % C, Rm 915 N/mm ² , 270 HB	115	0.125	0.210	0.260	0.305	0.355	0.395	0.440	0.520
P1.1.7 Unalloyed steel, heat-treated, 0.75 % C, Rm 1020 N/mm ² , 300 HB	110	0.115	0.195	0.245	0.290	0.330	0.370	0.410	0.490
P2.1.1 Low-alloy steel, annealed, Rm 610 N/mm ² , 180 HB	120	0.125	0.210	0.260	0.305	0.355	0.395	0.440	0.520
P2.1.2 Low-alloy steel, heat-treated, Rm 930 N/mm ² , 275 HB	120	0.125	0.210	0.260	0.305	0.355	0.395	0.440	0.520
P2.1.3 Low-alloy steel, heat-treated, Rm 1020 N/mm ² , 300 HB	100	0.105	0.175	0.220	0.260	0.300	0.335	0.375	0.440
P2.1.4 Low-alloy steel, heat-treated, Rm 1190 N/mm ² , 350 HB	90	0.090	0.155	0.195	0.230	0.265	0.295	0.330	0.390
P3.1.1 High-alloy steel and tool steel, annealed, Rm 680 N/mm ² , 200 HB	80	0.095	0.165	0.205	0.240	0.275	0.310	0.345	0.405
P3.1.2 High-alloy steel and tool steel, hardened and tempered, Rm 1100 N/mm ² , 325 HB	70	0.080	0.140	0.170	0.205	0.235	0.265	0.290	0.345
M1.1.1 Stainless steel, ferritic/martensitic, with machining additives	60	0.075	0.130	0.160	0.190	0.220	0.250	0.275	0.325
M1.1.2 Stainless steel, ferritic/martensitic, annealed, Rm 680 N/mm ² , 200 HB	55	0.070	0.115	0.145	0.175	0.200	0.225	0.245	0.295
M1.1.3 Stainless steel, ferritic/martensitic, heat-treated, Rm 810 N/mm ² , 240 HB	50	0.065	0.110	0.140	0.165	0.185	0.210	0.235	0.275
M2.1.1 Stainless steel, austenitic, quenched, 180 HB	55	0.040	0.065	0.080	0.095	0.110	0.125	0.135	0.165
M2.2.1 Duplex steel, high-strength stainless steels	45	0.035	0.055	0.070	0.080	0.095	0.105	0.115	0.140
K1.1.1 Grey cast iron, pearlitic/ferritic, 180 HB	110	0.155	0.260	0.325	0.385	0.440	0.495	0.550	0.650
K1.1.2 Grey cast iron, pearlitic/martensitic, 260 HB	95	0.130	0.220	0.275	0.325	0.375	0.420	0.465	0.555
K1.2.1 Cast iron with spheroidal graphite, ferritic, 160 HB	95	0.130	0.220	0.275	0.325	0.375	0.420	0.465	0.555
K1.2.2 Cast iron with spheroidal graphite, pearlitic, 250 HB	90	0.125	0.210	0.260	0.305	0.355	0.395	0.440	0.520
K1.3.1 Malleable cast iron, ferritic, 130 HB	90	0.125	0.210	0.260	0.305	0.355	0.395	0.440	0.520
K1.3.2 Malleable cast iron, pearlitic, 230 HB	75	0.110	0.180	0.225	0.270	0.310	0.345	0.385	0.455
K2.1.1 Vermicular graphite cast iron (GJV)	90	0.155	0.260	0.325	0.385	0.440	0.495	0.550	0.650
K2.2.1 Austenitic-ferritic spheroidal graphite cast iron (ADI)	70	0.115	0.195	0.245	0.290	0.330	0.370	0.410	0.490
N1.1.1 Wrought aluminium alloys, non-hardened, 60 HB	185	0.155	0.260	0.325	0.385	0.440	0.495	0.550	0.650
N1.1.2 Wrought aluminium alloys, hardened, 100 HB	185	0.155	0.260	0.325	0.385	0.440	0.495	0.550	0.650
N2.1.1 Aluminium casting alloys, non-hardened, ≤ 12 % Si, 75 HB	170	0.155	0.260	0.325	0.385	0.440	0.495	0.550	0.650
N2.1.2 Aluminium casting alloys, hardened, ≤ 12 % Si, 90 HB	170	0.155	0.260	0.325	0.385	0.440	0.495	0.550	0.650
N2.1.3 Aluminium casting alloys, non-hardened, > 12 % Si, 130 HB	145	0.130	0.220	0.275	0.325	0.375	0.420	0.465	0.555
N3.1.1 Copper and copper alloys: Free-machining alloy, Pb > 1 %	130	0.125	0.210	0.260	0.305	0.355	0.395	0.440	0.520
N3.1.2 Copper and copper alloys: CuZn, CuSnZn	110	0.105	0.175	0.220	0.260	0.300	0.335	0.375	0.440
N3.1.3 Copper and copper alloys: CuSn, lead-free copper and copper electrolyte	105	0.100	0.165	0.205	0.245	0.280	0.315	0.350	0.415
N4.1.1 Non-metallic materials: Duroplastics, fibre-reinforced plastics									
N4.1.2 Non-metallic materials: Hard rubber, wood, etc.									
N4.1.3 Non-metallic materials: Graphite									
S1.1.1 Heat-resistant alloys, Fe-based, annealed, 200 HB	40	0.060	0.105	0.130	0.155	0.175	0.200	0.220	0.260
S1.1.2 Heat-resistant alloys, Fe-based, hardened, 280 HB	30	0.050	0.085	0.105	0.120	0.140	0.160	0.175	0.205
S1.1.3 Heat-resistant alloys, Ni- or Co-based, annealed, 250 HB	35	0.060	0.105	0.130	0.155	0.175	0.200	0.220	0.260
S1.1.4 Heat-resistant alloys, Ni- or Co-based, hardened, 350 HB	20	0.045	0.075	0.090	0.105	0.125	0.140	0.155	0.180
S1.1.5 Heat-resistant alloys, Ni- or Co-based, cast, 320 HB	25	0.045	0.075	0.090	0.105	0.125	0.140	0.155	0.180
S2.1.1 Titanium alloys, pure titanium, Rm 400 N/mm ²	40	0.060	0.105	0.130	0.155	0.175	0.200	0.220	0.260
S2.1.2 Titanium alloys, Alpha and Beta alloys, hardened, Rm 1050 N/mm ²	30	0.050	0.085	0.105	0.120	0.140	0.160	0.175	0.205
H1.1.1 Hardened steel, hardened and tempered, < 55 HRC	50	0.040	0.065	0.080	0.095	0.110	0.125	0.135	0.165
H1.1.2 Hardened steel, hardened and tempered, < 60 HRC	35	0.030	0.050	0.065	0.075	0.090	0.100	0.110	0.130
H1.1.3 Hardened steel, hardened and tempered, > 60 HRC	30	0.030	0.050	0.060	0.070	0.085	0.095	0.105	0.120
H2.1.1 Chilled cast iron, 400 HB	40	0.050	0.080	0.100	0.120	0.140	0.155	0.175	0.205
H2.1.2 Chilled cast iron, hardened and tempered, < 55 HRC	30	0.035	0.055	0.070	0.085	0.095	0.110	0.120	0.145



Ratio drills with coolant ducts, RT 100 U, 5xD



Machining group		f (mm/rev) with nom. Ø							
		v _c (m/min)	3	6	8	10	12	14	16
									
P1.1.1 Unalloyed steel, annealed, 0.15 % C, Rm 420 N/mm ² , 125 HB	145	0.155	0.260	0.325	0.385	0.440	0.495	0.550	0.650
P1.1.2 Unalloyed steel, heat-treated, 0.15 % C, Rm 420 N/mm ² , 125 HB	130	0.140	0.235	0.290	0.345	0.395	0.445	0.495	0.585
P1.1.3 Unalloyed steel, annealed, 0.45 % C, Rm 640 N/mm ² , 190 HB	130	0.140	0.235	0.290	0.345	0.395	0.445	0.495	0.585
P1.1.4 Unalloyed steel, heat-treated, 0.45 % C, Rm 640 N/mm ² , 190 HB	125	0.130	0.220	0.275	0.325	0.375	0.420	0.465	0.555
P1.1.5 Unalloyed steel, heat-treated, 0.45 % C, Rm 850 N/mm ² , 250 HB	125	0.130	0.220	0.275	0.325	0.375	0.420	0.465	0.555
P1.1.6 Unalloyed steel, annealed, 0.75 % C, Rm 915 N/mm ² , 270 HB	115	0.125	0.210	0.260	0.305	0.355	0.395	0.440	0.520
P1.1.7 Unalloyed steel, heat-treated, 0.75 % C, Rm 1020 N/mm ² , 300 HB	110	0.115	0.195	0.245	0.290	0.330	0.370	0.410	0.490
P2.1.1 Low-alloy steel, annealed, Rm 610 N/mm ² , 180 HB	120	0.125	0.210	0.260	0.305	0.355	0.395	0.440	0.520
P2.1.2 Low-alloy steel, heat-treated, Rm 930 N/mm ² , 275 HB	120	0.125	0.210	0.260	0.305	0.355	0.395	0.440	0.520
P2.1.3 Low-alloy steel, heat-treated, Rm 1020 N/mm ² , 300 HB	100	0.105	0.175	0.220	0.260	0.300	0.335	0.375	0.440
P2.1.4 Low-alloy steel, heat-treated, Rm 1190 N/mm ² , 350 HB	90	0.090	0.155	0.195	0.230	0.265	0.295	0.330	0.390
P3.1.1 High-alloy steel and tool steel, annealed, Rm 680 N/mm ² , 200 HB	70	0.095	0.165	0.205	0.240	0.275	0.310	0.345	0.405
P3.1.2 High-alloy steel and tool steel, hardened and tempered, Rm 1100 N/mm ² , 325 HB	60	0.080	0.140	0.170	0.205	0.235	0.265	0.290	0.345
M1.1.1 Stainless steel, ferritic/martensitic, with machining additives	60	0.075	0.130	0.160	0.190	0.220	0.250	0.275	0.325
M1.1.2 Stainless steel, ferritic/martensitic, annealed, Rm 680 N/mm ² , 200 HB	55	0.070	0.115	0.145	0.175	0.200	0.225	0.245	0.295
M1.1.3 Stainless steel, ferritic/martensitic, heat-treated, Rm 810 N/mm ² , 240 HB	50	0.065	0.110	0.140	0.165	0.185	0.210	0.235	0.275
M2.1.1 Stainless steel, austenitic, quenched, 180 HB	55	0.040	0.065	0.080	0.095	0.110	0.125	0.135	0.165
M2.2.1 Duplex steel, high-strength stainless steels	45	0.035	0.055	0.070	0.080	0.095	0.105	0.115	0.140
K1.1.1 Grey cast iron, pearlitic/ferritic, 180 HB	110	0.155	0.260	0.325	0.385	0.440	0.495	0.550	0.650
K1.1.2 Grey cast iron, pearlitic/martensitic, 260 HB	95	0.130	0.220	0.275	0.325	0.375	0.420	0.465	0.555
K1.2.1 Cast iron with spheroidal graphite, ferritic, 160 HB	95	0.130	0.220	0.275	0.325	0.375	0.420	0.465	0.555
K1.2.2 Cast iron with spheroidal graphite, pearlitic, 250 HB	90	0.125	0.210	0.260	0.305	0.355	0.395	0.440	0.520
K1.3.1 Malleable cast iron, ferritic, 130 HB	90	0.125	0.210	0.260	0.305	0.355	0.395	0.440	0.520
K1.3.2 Malleable cast iron, pearlitic, 230 HB	75	0.110	0.180	0.225	0.270	0.310	0.345	0.385	0.455
K2.1.1 Vermicular graphite cast iron (GJV)	90	0.155	0.260	0.325	0.385	0.440	0.495	0.550	0.650
K2.2.1 Austenitic-ferritic spheroidal graphite cast iron (ADI)	70	0.115	0.195	0.245	0.290	0.330	0.370	0.410	0.490
N1.1.1 Wrought aluminium alloys, non-hardened, 60 HB	185	0.155	0.260	0.325	0.385	0.440	0.495	0.550	0.650
N1.1.2 Wrought aluminium alloys, hardened, 100 HB	185	0.155	0.260	0.325	0.385	0.440	0.495	0.550	0.650
N2.1.1 Aluminium casting alloys, non-hardened, ≤ 12 % Si, 75 HB	170	0.155	0.260	0.325	0.385	0.440	0.495	0.550	0.650
N2.1.2 Aluminium casting alloys, hardened, ≤ 12 % Si, 90 HB	170	0.155	0.260	0.325	0.385	0.440	0.495	0.550	0.650
N2.1.3 Aluminium casting alloys, non-hardened, > 12 % Si, 130 HB	145	0.130	0.220	0.275	0.325	0.375	0.420	0.465	0.555
N3.1.1 Copper and copper alloys: Free-machining alloy, Pb > 1 %	130	0.125	0.210	0.260	0.305	0.355	0.395	0.440	0.520
N3.1.2 Copper and copper alloys: CuZn, CuSnZn	110	0.105	0.175	0.220	0.260	0.300	0.335	0.375	0.440
N3.1.3 Copper and copper alloys: CuSn, lead-free copper and copper electrolyte	105	0.100	0.165	0.205	0.245	0.280	0.315	0.350	0.415
N4.1.1 Non-metallic materials: Duroplastics, fibre-reinforced plastics									
N4.1.2 Non-metallic materials: Hard rubber, wood, etc.									
N4.1.3 Non-metallic materials: Graphite									
S1.1.1 Heat-resistant alloys, Fe-based, annealed, 200 HB	40	0.060	0.105	0.130	0.155	0.175	0.200	0.220	0.260
S1.1.2 Heat-resistant alloys, Fe-based, hardened, 280 HB	30	0.050	0.085	0.105	0.120	0.140	0.160	0.175	0.205
S1.1.3 Heat-resistant alloys, Ni- or Co-based, annealed, 250 HB	35	0.060	0.105	0.130	0.155	0.175	0.200	0.220	0.260
S1.1.4 Heat-resistant alloys, Ni- or Co-based, hardened, 350 HB	20	0.045	0.075	0.090	0.105	0.125	0.140	0.155	0.180
S1.1.5 Heat-resistant alloys, Ni- or Co-based, cast, 320 HB	25	0.045	0.075	0.090	0.105	0.125	0.140	0.155	0.180
S2.1.1 Titanium alloys, pure titanium, Rm 400 N/mm ²	40	0.060	0.105	0.130	0.155	0.175	0.200	0.220	0.260
S2.1.2 Titanium alloys, Alpha and Beta alloys, hardened, Rm 1050 N/mm ²	30	0.050	0.085	0.105	0.120	0.140	0.160	0.175	0.205
H1.1.1 Hardened steel, hardened and tempered, < 55 HRC	50	0.040	0.065	0.080	0.095	0.110	0.125	0.135	0.165
H1.1.2 Hardened steel, hardened and tempered, < 60 HRC	35	0.030	0.050	0.065	0.075	0.090	0.100	0.110	0.130
H1.1.3 Hardened steel, hardened and tempered, > 60 HRC	30	0.030	0.050	0.060	0.070	0.085	0.095	0.105	0.120
H2.1.1 Chilled cast iron, 400 HB	40	0.050	0.080	0.100	0.120	0.140	0.155	0.175	0.205
H2.1.2 Chilled cast iron, hardened and tempered, < 55 HRC	30	0.035	0.055	0.070	0.085	0.095	0.110	0.120	0.145



Ratio drills with coolant ducts, RT 100 U, 7xD



Machining group		f (mm/rev) with nom. Ø							
		F							
	v _c (m/min)	3	6	8	10	12	14	16	20
P1.1.1 Unalloyed steel, annealed, 0.15 % C, Rm 420 N/mm ² , 125 HB	145	0.125	0.210	0.260	0.305	0.355	0.395	0.440	0.520
P1.1.2 Unalloyed steel, heat-treated, 0.15 % C, Rm 420 N/mm ² , 125 HB	130	0.110	0.185	0.235	0.275	0.315	0.355	0.395	0.470
P1.1.3 Unalloyed steel, annealed, 0.45 % C, Rm 640 N/mm ² , 190 HB	130	0.110	0.185	0.235	0.275	0.315	0.355	0.395	0.470
P1.1.4 Unalloyed steel, heat-treated, 0.45 % C, Rm 640 N/mm ² , 190 HB	125	0.105	0.175	0.220	0.260	0.300	0.335	0.375	0.440
P1.1.5 Unalloyed steel, heat-treated, 0.45 % C, Rm 850 N/mm ² , 250 HB	125	0.105	0.175	0.220	0.260	0.300	0.335	0.375	0.440
P1.1.6 Unalloyed steel, annealed, 0.75 % C, Rm 915 N/mm ² , 270 HB	115	0.100	0.165	0.205	0.245	0.280	0.315	0.350	0.415
P1.1.7 Unalloyed steel, heat-treated, 0.75 % C, Rm 1020 N/mm ² , 300 HB	110	0.090	0.155	0.195	0.230	0.265	0.295	0.330	0.390
P2.1.1 Low-alloy steel, annealed, Rm 610 N/mm ² , 180 HB	120	0.095	0.165	0.205	0.240	0.275	0.310	0.345	0.405
P2.1.2 Low-alloy steel, heat-treated, Rm 930 N/mm ² , 275 HB	120	0.095	0.165	0.205	0.240	0.275	0.310	0.345	0.405
P2.1.3 Low-alloy steel, heat-treated, Rm 1020 N/mm ² , 300 HB	100	0.080	0.140	0.170	0.205	0.235	0.265	0.290	0.345
P2.1.4 Low-alloy steel, heat-treated, Rm 1190 N/mm ² , 350 HB	90	0.070	0.120	0.150	0.180	0.205	0.230	0.255	0.305
P3.1.1 High-alloy steel and tool steel, annealed, Rm 680 N/mm ² , 200 HB	80	0.075	0.130	0.160	0.190	0.220	0.250	0.275	0.325
P3.1.2 High-alloy steel and tool steel, hardened and tempered, Rm 1100 N/mm ² , 325 HB	70	0.065	0.110	0.140	0.165	0.185	0.210	0.235	0.275
M1.1.1 Stainless steel, ferritic/martensitic, with machining additives	60	0.060	0.105	0.130	0.155	0.175	0.200	0.220	0.260
M1.1.2 Stainless steel, ferritic/martensitic, annealed, Rm 680 N/mm ² , 200 HB	55	0.055	0.095	0.115	0.140	0.160	0.180	0.195	0.235
M1.1.3 Stainless steel, ferritic/martensitic, heat-treated, Rm 810 N/mm ² , 240 HB	50	0.050	0.090	0.110	0.130	0.150	0.170	0.185	0.220
M2.1.1 Stainless steel, austenitic, quenched, 180 HB	55	0.040	0.065	0.080	0.095	0.110	0.125	0.135	0.165
M2.2.1 Duplex steel, high-strength stainless steels	45	0.035	0.055	0.070	0.080	0.095	0.105	0.115	0.140
K1.1.1 Grey cast iron, pearlitic/ferritic, 180 HB	110	0.155	0.260	0.325	0.385	0.440	0.495	0.550	0.650
K1.1.2 Grey cast iron, pearlitic/martensitic, 260 HB	95	0.130	0.220	0.275	0.325	0.375	0.420	0.465	0.555
K1.2.1 Cast iron with spheroidal graphite, ferritic, 160 HB	95	0.130	0.220	0.275	0.325	0.375	0.420	0.465	0.555
K1.2.2 Cast iron with spheroidal graphite, pearlitic, 250 HB	90	0.125	0.210	0.260	0.305	0.355	0.395	0.440	0.520
K1.3.1 Malleable cast iron, ferritic, 130 HB	90	0.125	0.210	0.260	0.305	0.355	0.395	0.440	0.520
K1.3.2 Malleable cast iron, pearlitic, 230 HB	75	0.110	0.180	0.225	0.270	0.310	0.345	0.385	0.455
K2.1.1 Vermicular graphite cast iron (GJV)	90	0.155	0.260	0.325	0.385	0.440	0.495	0.550	0.650
K2.2.1 Austenitic-ferritic spheroidal graphite cast iron (ADI)	70	0.115	0.195	0.245	0.290	0.330	0.370	0.410	0.490
N1.1.1 Wrought aluminium alloys, non-hardened, 60 HB	185	0.155	0.260	0.325	0.385	0.440	0.495	0.550	0.650
N1.1.2 Wrought aluminium alloys, hardened, 100 HB	185	0.155	0.260	0.325	0.385	0.440	0.495	0.550	0.650
N2.1.1 Aluminium casting alloys, non-hardened, ≤ 12 % Si, 75 HB	170	0.155	0.260	0.325	0.385	0.440	0.495	0.550	0.650
N2.1.2 Aluminium casting alloys, hardened, ≤ 12 % Si, 90 HB	170	0.155	0.260	0.325	0.385	0.440	0.495	0.550	0.650
N2.1.3 Aluminium casting alloys, non-hardened, > 12 % Si, 130 HB	145	0.130	0.220	0.275	0.325	0.375	0.420	0.465	0.555
N3.1.1 Copper and copper alloys: Free-machining alloy, Pb > 1 %	130	0.125	0.210	0.260	0.305	0.355	0.395	0.440	0.520
N3.1.2 Copper and copper alloys: CuZn, CuSnZn	110	0.105	0.175	0.220	0.260	0.300	0.335	0.375	0.440
N3.1.3 Copper and copper alloys: CuSn, lead-free copper and copper electrolyte	105	0.100	0.165	0.205	0.245	0.280	0.315	0.350	0.415
N4.1.1 Non-metallic materials: Duroplastics, fibre-reinforced plastics									
N4.1.2 Non-metallic materials: Hard rubber, wood, etc.									
N4.1.3 Non-metallic materials: Graphite									
S1.1.1 Heat-resistant alloys, Fe-based, annealed, 200 HB	40	0.050	0.080	0.100	0.120	0.140	0.155	0.175	0.205
S1.1.2 Heat-resistant alloys, Fe-based, hardened, 280 HB	30	0.040	0.065	0.080	0.095	0.110	0.125	0.140	0.165
S1.1.3 Heat-resistant alloys, Ni- or Co-based, annealed, 250 HB	35	0.050	0.080	0.100	0.120	0.140	0.155	0.175	0.205
S1.1.4 Heat-resistant alloys, Ni- or Co-based, hardened, 350 HB	20	0.035	0.055	0.070	0.085	0.095	0.110	0.120	0.145
S1.1.5 Heat-resistant alloys, Ni- or Co-based, cast, 320 HB	25	0.035	0.055	0.070	0.085	0.095	0.110	0.120	0.145
S2.1.1 Titanium alloys, pure titanium, Rm 400 N/mm ²	40	0.050	0.080	0.100	0.120	0.140	0.155	0.175	0.205
S2.1.2 Titanium alloys, Alpha and Beta alloys, hardened, Rm 1050 N/mm ²	30	0.040	0.065	0.080	0.095	0.110	0.125	0.140	0.165
H1.1.1 Hardened steel, hardened and tempered, < 55 HRC	50	0.040	0.065	0.080	0.095	0.110	0.125	0.135	0.165
H1.1.2 Hardened steel, hardened and tempered, < 60 HRC	35	0.030	0.050	0.065	0.075	0.090	0.100	0.110	0.130
H1.1.3 Hardened steel, hardened and tempered, > 60 HRC	30	0.030	0.050	0.060	0.070	0.085	0.095	0.105	0.120
H2.1.1 Chilled cast iron, 400 HB	40	0.040	0.065	0.080	0.095	0.110	0.125	0.135	0.165
H2.1.2 Chilled cast iron, hardened and tempered, < 55 HRC	30	0.025	0.045	0.055	0.065	0.075	0.085	0.095	0.115



Ratio drills with coolant ducts, RT 100 U, 12xD





Machining group		f (mm/rev) with nom. Ø								
		F								
	v _c (m/min)		3	6	8	10	12	14	16	20
P1.1.1 Unalloyed steel, annealed, 0.15 % C, Rm 420 N/mm ² , 125 HB		110	0.125	0.210	0.260	0.305	0.355	0.395	0.440	0.520
P1.1.2 Unalloyed steel, heat-treated, 0.15 % C, Rm 420 N/mm ² , 125 HB		100	0.110	0.185	0.235	0.275	0.315	0.355	0.395	0.470
P1.1.3 Unalloyed steel, annealed, 0.45 % C, Rm 640 N/mm ² , 190 HB		100	0.110	0.185	0.235	0.275	0.315	0.355	0.395	0.470
P1.1.4 Unalloyed steel, heat-treated, 0.45 % C, Rm 640 N/mm ² , 190 HB		95	0.105	0.175	0.220	0.260	0.300	0.335	0.375	0.440
P1.1.5 Unalloyed steel, heat-treated, 0.45 % C, Rm 850 N/mm ² , 250 HB		95	0.105	0.175	0.220	0.260	0.300	0.335	0.375	0.440
P1.1.6 Unalloyed steel, annealed, 0.75 % C, Rm 915 N/mm ² , 270 HB		90	0.100	0.165	0.205	0.245	0.280	0.315	0.350	0.415
P1.1.7 Unalloyed steel, heat-treated, 0.75 % C, Rm 1020 N/mm ² , 300 HB		85	0.090	0.155	0.195	0.230	0.265	0.295	0.330	0.390
P2.1.1 Low-alloy steel, annealed, Rm 610 N/mm ² , 180 HB		110	0.095	0.165	0.205	0.240	0.275	0.310	0.345	0.405
P2.1.2 Low-alloy steel, heat-treated, Rm 930 N/mm ² , 275 HB		110	0.095	0.165	0.205	0.240	0.275	0.310	0.345	0.405
P2.1.3 Low-alloy steel, heat-treated, Rm 1020 N/mm ² , 300 HB		95	0.080	0.140	0.170	0.205	0.235	0.265	0.290	0.345
P2.1.4 Low-alloy steel, heat-treated, Rm 1190 N/mm ² , 350 HB		85	0.070	0.120	0.150	0.180	0.205	0.230	0.255	0.305
P3.1.1 High-alloy steel and tool steel, annealed, Rm 680 N/mm ² , 200 HB		80	0.075	0.130	0.160	0.190	0.220	0.250	0.275	0.325
P3.1.2 High-alloy steel and tool steel, hardened and tempered, Rm 1100 N/mm ² , 325 HB		70	0.065	0.110	0.140	0.165	0.185	0.210	0.235	0.275
M1.1.1 Stainless steel, ferritic/martensitic, with machining additives		60	0.060	0.105	0.130	0.155	0.175	0.200	0.220	0.260
M1.1.2 Stainless steel, ferritic/martensitic, annealed, Rm 680 N/mm ² , 200 HB		55	0.055	0.095	0.115	0.140	0.160	0.180	0.195	0.235
M1.1.3 Stainless steel, ferritic/martensitic, heat-treated, Rm 810 N/mm ² , 240 HB		50	0.050	0.090	0.110	0.130	0.150	0.170	0.185	0.220
M2.1.1 Stainless steel, austenitic, quenched, 180 HB		55	0.040	0.065	0.080	0.095	0.110	0.125	0.135	0.165
M2.2.1 Duplex steel, high-strength stainless steels		45	0.035	0.055	0.070	0.080	0.095	0.105	0.115	0.140
K1.1.1 Grey cast iron, pearlitic/ferritic, 180 HB		110	0.125	0.210	0.260	0.305	0.355	0.395	0.440	0.520
K1.1.2 Grey cast iron, pearlitic/martensitic, 260 HB		95	0.105	0.175	0.220	0.260	0.300	0.335	0.375	0.440
K1.2.1 Cast iron with spheroidal graphite, ferritic, 160 HB		95	0.105	0.175	0.220	0.260	0.300	0.335	0.375	0.440
K1.2.2 Cast iron with spheroidal graphite, pearlitic, 250 HB		90	0.100	0.165	0.205	0.245	0.280	0.315	0.350	0.415
K1.3.1 Malleable cast iron, ferritic, 130 HB		90	0.100	0.165	0.205	0.245	0.280	0.315	0.350	0.415
K1.3.2 Malleable cast iron, pearlitic, 230 HB		75	0.085	0.145	0.180	0.215	0.245	0.280	0.305	0.365
K2.1.1 Vermicular graphite cast iron (GJV)		90	0.125	0.210	0.260	0.305	0.355	0.395	0.440	0.520
K2.2.1 Austenitic-ferritic spheroidal graphite cast iron (ADI)		70	0.090	0.155	0.195	0.230	0.265	0.295	0.330	0.390
N1.1.1 Wrought aluminium alloys, non-hardened, 60 HB		185	0.125	0.210	0.260	0.305	0.355	0.395	0.440	0.520
N1.1.2 Wrought aluminium alloys, hardened, 100 HB		185	0.125	0.210	0.260	0.305	0.355	0.395	0.440	0.520
N2.1.1 Aluminium casting alloys, non-hardened, ≤ 12 % Si, 75 HB		170	0.125	0.210	0.260	0.305	0.355	0.395	0.440	0.520
N2.1.2 Aluminium casting alloys, hardened, ≤ 12 % Si, 90 HB		170	0.125	0.210	0.260	0.305	0.355	0.395	0.440	0.520
N2.1.3 Aluminium casting alloys, non-hardened, > 12 % Si, 130 HB		145	0.105	0.175	0.220	0.260	0.300	0.335	0.375	0.440
N3.1.1 Copper and copper alloys: Free-machining alloy, Pb > 1 %		130	0.095	0.165	0.205	0.240	0.275	0.310	0.345	0.405
N3.1.2 Copper and copper alloys: CuZn, CuSnZn		110	0.080	0.140	0.170	0.205	0.235	0.265	0.290	0.345
N3.1.3 Copper and copper alloys: CuSn, lead-free copper and copper electrolyte		105	0.075	0.130	0.160	0.190	0.220	0.250	0.275	0.325
N4.1.1 Non-metallic materials: Duroplastics, fibre-reinforced plastics										
N4.1.2 Non-metallic materials: Hard rubber, wood, etc.										
N4.1.3 Non-metallic materials: Graphite										
S1.1.1 Heat-resistant alloys, Fe-based, annealed, 200 HB										
S1.1.2 Heat-resistant alloys, Fe-based, hardened, 280 HB										
S1.1.3 Heat-resistant alloys, Ni- or Co-based, annealed, 250 HB										
S1.1.4 Heat-resistant alloys, Ni- or Co-based, hardened, 350 HB										
S1.1.5 Heat-resistant alloys, Ni- or Co-based, cast, 320 HB										
S2.1.1 Titanium alloys, pure titanium, Rm 400 N/mm ²										
S2.1.2 Titanium alloys, Alpha and Beta alloys, hardened, Rm 1050 N/mm ²										
H1.1.1 Hardened steel, hardened and tempered, < 55 HRC										
H1.1.2 Hardened steel, hardened and tempered, < 60 HRC										
H1.1.3 Hardened steel, hardened and tempered, > 60 HRC										
H2.1.1 Chilled cast iron, 400 HB										
H2.1.2 Chilled cast iron, hardened and tempered, < 55 HRC										



Ratio drills with coolant ducts, RT 100 HF, ≤ 5xD





Machining group		f (mm/rev) with nom. Ø							
			3	6	8	10	12	14	16
	v _c (m/min)								
P1.1.1 Unalloyed steel, annealed, 0.15 % C, Rm 420 N/mm ² , 125 HB	145	0.155	0.260	0.325	0.385	0.440	0.495	0.550	0.650
P1.1.2 Unalloyed steel, heat-treated, 0.15 % C, Rm 420 N/mm ² , 125 HB	130	0.140	0.235	0.290	0.345	0.395	0.445	0.495	0.585
P1.1.3 Unalloyed steel, annealed, 0.45 % C, Rm 640 N/mm ² , 190 HB	130	0.140	0.235	0.290	0.345	0.395	0.445	0.495	0.585
P1.1.4 Unalloyed steel, heat-treated, 0.45 % C, Rm 640 N/mm ² , 190 HB	125	0.130	0.220	0.275	0.325	0.375	0.420	0.465	0.555
P1.1.5 Unalloyed steel, heat-treated, 0.45 % C, Rm 850 N/mm ² , 250 HB	125	0.130	0.220	0.275	0.325	0.375	0.420	0.465	0.555
P1.1.6 Unalloyed steel, annealed, 0.75 % C, Rm 915 N/mm ² , 270 HB	115	0.125	0.210	0.260	0.305	0.355	0.395	0.440	0.520
P1.1.7 Unalloyed steel, heat-treated, 0.75 % C, Rm 1020 N/mm ² , 300 HB	110	0.115	0.195	0.245	0.290	0.330	0.370	0.410	0.490
P2.1.1 Low-alloy steel, annealed, Rm 610 N/mm ² , 180 HB	120	0.125	0.210	0.260	0.305	0.355	0.395	0.440	0.520
P2.1.2 Low-alloy steel, heat-treated, Rm 930 N/mm ² , 275 HB	120	0.125	0.210	0.260	0.305	0.355	0.395	0.440	0.520
P2.1.3 Low-alloy steel, heat-treated, Rm 1020 N/mm ² , 300 HB	100	0.105	0.175	0.220	0.260	0.300	0.335	0.375	0.440
P2.1.4 Low-alloy steel, heat-treated, Rm 1190 N/mm ² , 350 HB	90	0.090	0.155	0.195	0.230	0.265	0.295	0.330	0.390
P3.1.1 High-alloy steel and tool steel, annealed, Rm 680 N/mm ² , 200 HB	80	0.095	0.165	0.205	0.240	0.275	0.310	0.345	0.405
P3.1.2 High-alloy steel and tool steel, hardened and tempered, Rm 1100 N/mm ² , 325 HB	70	0.080	0.140	0.170	0.205	0.235	0.265	0.290	0.345
M1.1.1 Stainless steel, ferritic/martensitic, with machining additives									
M1.1.2 Stainless steel, ferritic/martensitic, annealed, Rm 680 N/mm ² , 200 HB									
M1.1.3 Stainless steel, ferritic/martensitic, heat-treated, Rm 810 N/mm ² , 240 HB									
M2.1.1 Stainless steel, austenitic, quenched, 180 HB									
M2.2.1 Duplex steel, high-strength stainless steels									
K1.1.1 Grey cast iron, pearlitic/ferritic, 180 HB									
K1.1.2 Grey cast iron, pearlitic/martensitic, 260 HB									
K1.2.1 Cast iron with spheroidal graphite, ferritic, 160 HB									
K1.2.2 Cast iron with spheroidal graphite, pearlitic, 250 HB									
K1.3.1 Malleable cast iron, ferritic, 130 HB									
K1.3.2 Malleable cast iron, pearlitic, 230 HB									
K2.1.1 Vermicular graphite cast iron (GJV)									
K2.2.1 Austenitic-ferritic spheroidal graphite cast iron (ADI)									
N1.1.1 Wrought aluminium alloys, non-hardened, 60 HB									
N1.1.2 Wrought aluminium alloys, hardened, 100 HB									
N2.1.1 Aluminium casting alloys, non-hardened, ≤ 12 % Si, 75 HB									
N2.1.2 Aluminium casting alloys, hardened, ≤ 12 % Si, 90 HB									
N2.1.3 Aluminium casting alloys, non-hardened, > 12 % Si, 130 HB									
N3.1.1 Copper and copper alloys: Free-machining alloy, Pb > 1 %									
N3.1.2 Copper and copper alloys: CuZn, CuSnZn									
N3.1.3 Copper and copper alloys: CuSn, lead-free copper and copper electrolyte									
N4.1.1 Non-metallic materials: Duroplastics, fibre-reinforced plastics									
N4.1.2 Non-metallic materials: Hard rubber, wood, etc.									
N4.1.3 Non-metallic materials: Graphite									
S1.1.1 Heat-resistant alloys, Fe-based, annealed, 200 HB	45	0.060	0.105	0.130	0.155	0.175	0.200	0.220	0.260
S1.1.2 Heat-resistant alloys, Fe-based, hardened, 280 HB	35	0.050	0.085	0.105	0.120	0.140	0.160	0.175	0.205
S1.1.3 Heat-resistant alloys, Ni- or Co-based, annealed, 250 HB	40	0.060	0.105	0.130	0.155	0.175	0.200	0.220	0.260
S1.1.4 Heat-resistant alloys, Ni- or Co-based, hardened, 350 HB	25	0.045	0.075	0.090	0.105	0.125	0.140	0.155	0.180
S1.1.5 Heat-resistant alloys, Ni- or Co-based, cast, 320 HB	25	0.045	0.075	0.090	0.105	0.125	0.140	0.155	0.180
S2.1.1 Titanium alloys, pure titanium, Rm 400 N/mm ²	45	0.060	0.105	0.130	0.155	0.175	0.200	0.220	0.260
S2.1.2 Titanium alloys, Alpha and Beta alloys, hardened, Rm 1050 N/mm ²	35	0.050	0.085	0.105	0.120	0.140	0.160	0.175	0.205
H1.1.1 Hardened steel, hardened and tempered, < 55 HRC	55	0.050	0.080	0.100	0.120	0.140	0.155	0.175	0.205
H1.1.2 Hardened steel, hardened and tempered, < 60 HRC	35	0.040	0.065	0.080	0.095	0.110	0.125	0.140	0.165
H1.1.3 Hardened steel, hardened and tempered, > 60 HRC	35	0.035	0.060	0.075	0.090	0.105	0.115	0.130	0.155
H2.1.1 Chilled cast iron, 400 HB									
H2.1.2 Chilled cast iron, hardened and tempered, < 55 HRC									



Ratio drills with coolant ducts, RT 100 HF, 7xD



Machining group		f (mm/rev) with nom. Ø							
			3	6	8	10	12	14	16
	v _c (m/min)								
P1.1.1 Unalloyed steel, annealed, 0.15 % C, Rm 420 N/mm ² , 125 HB	145	0.095	0.165	0.205	0.240	0.275	0.310	0.345	0.405
P1.1.2 Unalloyed steel, heat-treated, 0.15 % C, Rm 420 N/mm ² , 125 HB	130	0.085	0.145	0.180	0.215	0.250	0.280	0.310	0.365
P1.1.3 Unalloyed steel, annealed, 0.45 % C, Rm 640 N/mm ² , 190 HB	130	0.085	0.145	0.180	0.215	0.250	0.280	0.310	0.365
P1.1.4 Unalloyed steel, heat-treated, 0.45 % C, Rm 640 N/mm ² , 190 HB	125	0.080	0.140	0.170	0.205	0.235	0.265	0.290	0.345
P1.1.5 Unalloyed steel, heat-treated, 0.45 % C, Rm 850 N/mm ² , 250 HB	125	0.080	0.140	0.170	0.205	0.235	0.265	0.290	0.345
P1.1.6 Unalloyed steel, annealed, 0.75 % C, Rm 915 N/mm ² , 270 HB	115	0.075	0.130	0.160	0.190	0.220	0.250	0.275	0.325
P1.1.7 Unalloyed steel, heat-treated, 0.75 % C, Rm 1020 N/mm ² , 300 HB	110	0.070	0.120	0.150	0.180	0.205	0.230	0.255	0.305
P2.1.1 Low-alloy steel, annealed, Rm 610 N/mm ² , 180 HB	120	0.095	0.165	0.205	0.240	0.275	0.310	0.345	0.405
P2.1.2 Low-alloy steel, heat-treated, Rm 930 N/mm ² , 275 HB	120	0.095	0.165	0.205	0.240	0.275	0.310	0.345	0.405
P2.1.3 Low-alloy steel, heat-treated, Rm 1020 N/mm ² , 300 HB	100	0.080	0.140	0.170	0.205	0.235	0.265	0.290	0.345
P2.1.4 Low-alloy steel, heat-treated, Rm 1190 N/mm ² , 350 HB	90	0.070	0.120	0.150	0.180	0.205	0.230	0.255	0.305
P3.1.1 High-alloy steel and tool steel, annealed, Rm 680 N/mm ² , 200 HB	80	0.075	0.130	0.160	0.190	0.220	0.250	0.275	0.325
P3.1.2 High-alloy steel and tool steel, hardened and tempered, Rm 1100 N/mm ² , 325 HB	70	0.065	0.110	0.140	0.165	0.185	0.210	0.235	0.275
M1.1.1 Stainless steel, ferritic/martensitic, with machining additives									
M1.1.2 Stainless steel, ferritic/martensitic, annealed, Rm 680 N/mm ² , 200 HB									
M1.1.3 Stainless steel, ferritic/martensitic, heat-treated, Rm 810 N/mm ² , 240 HB									
M2.1.1 Stainless steel, austenitic, quenched, 180 HB									
M2.2.1 Duplex steel, high-strength stainless steels									
K1.1.1 Grey cast iron, pearlitic/ferritic, 180 HB									
K1.1.2 Grey cast iron, pearlitic/martensitic, 260 HB									
K1.2.1 Cast iron with spheroidal graphite, ferritic, 160 HB									
K1.2.2 Cast iron with spheroidal graphite, pearlitic, 250 HB									
K1.3.1 Malleable cast iron, ferritic, 130 HB									
K1.3.2 Malleable cast iron, pearlitic, 230 HB									
K2.1.1 Vermicular graphite cast iron (GJV)									
K2.2.1 Austenitic-ferritic spheroidal graphite cast iron (ADI)									
N1.1.1 Wrought aluminium alloys, non-hardened, 60 HB									
N1.1.2 Wrought aluminium alloys, hardened, 100 HB									
N2.1.1 Aluminium casting alloys, non-hardened, ≤ 12 % Si, 75 HB									
N2.1.2 Aluminium casting alloys, hardened, ≤ 12 % Si, 90 HB									
N2.1.3 Aluminium casting alloys, non-hardened, > 12 % Si, 130 HB									
N3.1.1 Copper and copper alloys: Free-machining alloy, Pb > 1 %									
N3.1.2 Copper and copper alloys: CuZn, CuSnZn									
N3.1.3 Copper and copper alloys: CuSn, lead-free copper and copper electrolyte									
N4.1.1 Non-metallic materials: Duroplastics, fibre-reinforced plastics									
N4.1.2 Non-metallic materials: Hard rubber, wood, etc.									
N4.1.3 Non-metallic materials: Graphite									
S1.1.1 Heat-resistant alloys, Fe-based, annealed, 200 HB	45	0.050	0.080	0.100	0.120	0.140	0.155	0.175	0.205
S1.1.2 Heat-resistant alloys, Fe-based, hardened, 280 HB	35	0.040	0.065	0.080	0.095	0.110	0.125	0.140	0.165
S1.1.3 Heat-resistant alloys, Ni- or Co-based, annealed, 250 HB	40	0.050	0.080	0.100	0.120	0.140	0.155	0.175	0.205
S1.1.4 Heat-resistant alloys, Ni- or Co-based, hardened, 350 HB	25	0.035	0.055	0.070	0.085	0.095	0.110	0.120	0.145
S1.1.5 Heat-resistant alloys, Ni- or Co-based, cast, 320 HB	25	0.035	0.055	0.070	0.085	0.095	0.110	0.120	0.145
S2.1.1 Titanium alloys, pure titanium, Rm 400 N/mm ²	45	0.050	0.080	0.100	0.120	0.140	0.155	0.175	0.205
S2.1.2 Titanium alloys, Alpha and Beta alloys, hardened, Rm 1050 N/mm ²	35	0.040	0.065	0.080	0.095	0.110	0.125	0.140	0.165
H1.1.1 Hardened steel, hardened and tempered, < 55 HRC	55	0.040	0.065	0.080	0.095	0.110	0.125	0.135	0.165
H1.1.2 Hardened steel, hardened and tempered, < 60 HRC	35	0.030	0.050	0.065	0.075	0.090	0.100	0.110	0.130
H1.1.3 Hardened steel, hardened and tempered, > 60 HRC	35	0.030	0.050	0.060	0.070	0.085	0.095	0.105	0.120
H2.1.1 Chilled cast iron, 400 HB									
H2.1.2 Chilled cast iron, hardened and tempered, < 55 HRC									



Ratio drills with coolant ducts, RT 100 XF, ≤ 5xD



Machining group		f (mm/rev) with nom. Ø							
		F							
	v _c (m/min)	3	6	8	10	12	14	16	20
P1.1.1 Unalloyed steel, annealed, 0.15 % C, Rm 420 N/mm ² , 125 HB	180	0.190	0.325	0.405	0.480	0.550	0.620	0.685	0.815
P1.1.2 Unalloyed steel, heat-treated, 0.15 % C, Rm 420 N/mm ² , 125 HB	160	0.175	0.295	0.365	0.430	0.495	0.560	0.615	0.730
P1.1.3 Unalloyed steel, annealed, 0.45 % C, Rm 640 N/mm ² , 190 HB	160	0.175	0.295	0.365	0.430	0.495	0.560	0.615	0.730
P1.1.4 Unalloyed steel, heat-treated, 0.45 % C, Rm 640 N/mm ² , 190 HB	155	0.165	0.275	0.345	0.410	0.470	0.525	0.585	0.690
P1.1.5 Unalloyed steel, heat-treated, 0.45 % C, Rm 850 N/mm ² , 250 HB	155	0.165	0.275	0.345	0.410	0.470	0.525	0.585	0.690
P1.1.6 Unalloyed steel, annealed, 0.75 % C, Rm 915 N/mm ² , 270 HB	145	0.155	0.260	0.325	0.385	0.440	0.495	0.550	0.650
P1.1.7 Unalloyed steel, heat-treated, 0.75 % C, Rm 1020 N/mm ² , 300 HB	135	0.145	0.245	0.305	0.360	0.415	0.465	0.515	0.610
P2.1.1 Low-alloy steel, annealed, Rm 610 N/mm ² , 180 HB	120	0.155	0.260	0.325	0.385	0.440	0.495	0.550	0.650
P2.1.2 Low-alloy steel, heat-treated, Rm 930 N/mm ² , 275 HB	120	0.155	0.260	0.325	0.385	0.440	0.495	0.550	0.650
P2.1.3 Low-alloy steel, heat-treated, Rm 1020 N/mm ² , 300 HB	100	0.130	0.220	0.275	0.325	0.375	0.420	0.465	0.555
P2.1.4 Low-alloy steel, heat-treated, Rm 1190 N/mm ² , 350 HB	90	0.115	0.195	0.245	0.290	0.330	0.370	0.410	0.490
P3.1.1 High-alloy steel and tool steel, annealed, Rm 680 N/mm ² , 200 HB	90	0.125	0.210	0.260	0.305	0.355	0.395	0.440	0.520
P3.1.2 High-alloy steel and tool steel, hardened and tempered, Rm 1100 N/mm ² , 325 HB	75	0.105	0.175	0.220	0.260	0.300	0.335	0.375	0.440
M1.1.1 Stainless steel, ferritic/martensitic, with machining additives	80	0.075	0.130	0.160	0.190	0.220	0.250	0.275	0.325
M1.1.2 Stainless steel, ferritic/martensitic, annealed, Rm 680 N/mm ² , 200 HB	70	0.070	0.115	0.145	0.175	0.200	0.225	0.245	0.295
M1.1.3 Stainless steel, ferritic/martensitic, heat-treated, Rm 810 N/mm ² , 240 HB	70	0.065	0.110	0.140	0.165	0.185	0.210	0.235	0.275
M2.1.1 Stainless steel, austenitic, quenched, 180 HB									
M2.2.1 Duplex steel, high-strength stainless steels									
K1.1.1 Grey cast iron, pearlitic/ferritic, 180 HB	110	0.155	0.260	0.325	0.385	0.440	0.495	0.550	0.650
K1.1.2 Grey cast iron, pearlitic/martensitic, 260 HB	95	0.130	0.220	0.275	0.325	0.375	0.420	0.465	0.555
K1.2.1 Cast iron with spheroidal graphite, ferritic, 160 HB	95	0.130	0.220	0.275	0.325	0.375	0.420	0.465	0.555
K1.2.2 Cast iron with spheroidal graphite, pearlitic, 250 HB	90	0.125	0.210	0.260	0.305	0.355	0.395	0.440	0.520
K1.3.1 Malleable cast iron, ferritic, 130 HB	90	0.125	0.210	0.260	0.305	0.355	0.395	0.440	0.520
K1.3.2 Malleable cast iron, pearlitic, 230 HB	75	0.110	0.180	0.225	0.270	0.310	0.345	0.385	0.455
K2.1.1 Vermicular graphite cast iron (GJV)	90	0.155	0.260	0.325	0.385	0.440	0.495	0.550	0.650
K2.2.1 Austenitic-ferritic spheroidal graphite cast iron (ADI)	70	0.115	0.195	0.245	0.290	0.330	0.370	0.410	0.490
N1.1.1 Wrought aluminium alloys, non-hardened, 60 HB									
N1.1.2 Wrought aluminium alloys, hardened, 100 HB									
N2.1.1 Aluminium casting alloys, non-hardened, ≤ 12 % Si, 75 HB									
N2.1.2 Aluminium casting alloys, hardened, ≤ 12 % Si, 90 HB									
N2.1.3 Aluminium casting alloys, non-hardened, > 12 % Si, 130 HB									
N3.1.1 Copper and copper alloys: Free-machining alloy, Pb > 1 %									
N3.1.2 Copper and copper alloys: CuZn, CuSnZn									
N3.1.3 Copper and copper alloys: CuSn, lead-free copper and copper electrolyte									
N4.1.1 Non-metallic materials: Duroplastics, fibre-reinforced plastics									
N4.1.2 Non-metallic materials: Hard rubber, wood, etc.									
N4.1.3 Non-metallic materials: Graphite									
S1.1.1 Heat-resistant alloys, Fe-based, annealed, 200 HB	40	0.060	0.105	0.130	0.155	0.175	0.200	0.220	0.260
S1.1.2 Heat-resistant alloys, Fe-based, hardened, 280 HB	30	0.050	0.085	0.105	0.120	0.140	0.160	0.175	0.205
S1.1.3 Heat-resistant alloys, Ni- or Co-based, annealed, 250 HB	35	0.060	0.105	0.130	0.155	0.175	0.200	0.220	0.260
S1.1.4 Heat-resistant alloys, Ni- or Co-based, hardened, 350 HB	20	0.045	0.075	0.090	0.105	0.125	0.140	0.155	0.180
S1.1.5 Heat-resistant alloys, Ni- or Co-based, cast, 320 HB	25	0.045	0.075	0.090	0.105	0.125	0.140	0.155	0.180
S2.1.1 Titanium alloys, pure titanium, Rm 400 N/mm ²	40	0.060	0.105	0.130	0.155	0.175	0.200	0.220	0.260
S2.1.2 Titanium alloys, Alpha and Beta alloys, hardened, Rm 1050 N/mm ²	30	0.050	0.085	0.105	0.120	0.140	0.160	0.175	0.205
H1.1.1 Hardened steel, hardened and tempered, < 55 HRC	55	0.050	0.080	0.100	0.120	0.140	0.155	0.175	0.205
H1.1.2 Hardened steel, hardened and tempered, < 60 HRC									
H1.1.3 Hardened steel, hardened and tempered, > 60 HRC									
H2.1.1 Chilled cast iron, 400 HB									
H2.1.2 Chilled cast iron, hardened and tempered, < 55 HRC									



Ratio drills with coolant ducts, RT 100 XF, $\geq 7 \times D$ 

Machining group		f (mm/rev) with nom. Ø								
		F								
	v_c (m/min)		3	6	8	10	12	14	16	20
P1.1.1 Unalloyed steel, annealed, 0.15 % C, Rm 420 N/mm ² , 125 HB		160	0.190	0.325	0.405	0.480	0.550	0.620	0.685	0.815
P1.1.2 Unalloyed steel, heat-treated, 0.15 % C, Rm 420 N/mm ² , 125 HB		145	0.175	0.295	0.365	0.430	0.495	0.560	0.615	0.730
P1.1.3 Unalloyed steel, annealed, 0.45 % C, Rm 640 N/mm ² , 190 HB		145	0.175	0.295	0.365	0.430	0.495	0.560	0.615	0.730
P1.1.4 Unalloyed steel, heat-treated, 0.45 % C, Rm 640 N/mm ² , 190 HB		135	0.165	0.275	0.345	0.410	0.470	0.525	0.585	0.690
P1.1.5 Unalloyed steel, heat-treated, 0.45 % C, Rm 850 N/mm ² , 250 HB		135	0.165	0.275	0.345	0.410	0.470	0.525	0.585	0.690
P1.1.6 Unalloyed steel, annealed, 0.75 % C, Rm 915 N/mm ² , 270 HB		130	0.155	0.260	0.325	0.385	0.440	0.495	0.550	0.650
P1.1.7 Unalloyed steel, heat-treated, 0.75 % C, Rm 1020 N/mm ² , 300 HB		120	0.145	0.245	0.305	0.360	0.415	0.465	0.515	0.610
P2.1.1 Low-alloy steel, annealed, Rm 610 N/mm ² , 180 HB		110	0.155	0.260	0.325	0.385	0.440	0.495	0.550	0.650
P2.1.2 Low-alloy steel, heat-treated, Rm 930 N/mm ² , 275 HB		110	0.155	0.260	0.325	0.385	0.440	0.495	0.550	0.650
P2.1.3 Low-alloy steel, heat-treated, Rm 1020 N/mm ² , 300 HB		95	0.130	0.220	0.275	0.325	0.375	0.420	0.465	0.555
P2.1.4 Low-alloy steel, heat-treated, Rm 1190 N/mm ² , 350 HB		85	0.115	0.195	0.245	0.290	0.330	0.370	0.410	0.490
P3.1.1 High-alloy steel and tool steel, annealed, Rm 680 N/mm ² , 200 HB		80	0.125	0.210	0.260	0.305	0.355	0.395	0.440	0.520
P3.1.2 High-alloy steel and tool steel, hardened and tempered, Rm 1100 N/mm ² , 325 HB		70	0.105	0.175	0.220	0.260	0.300	0.335	0.375	0.440
M1.1.1 Stainless steel, ferritic/martensitic, with machining additives		70	0.075	0.130	0.160	0.190	0.220	0.250	0.275	0.325
M1.1.2 Stainless steel, ferritic/martensitic, annealed, Rm 680 N/mm ² , 200 HB		65	0.070	0.115	0.145	0.175	0.200	0.225	0.245	0.295
M1.1.3 Stainless steel, ferritic/martensitic, heat-treated, Rm 810 N/mm ² , 240 HB		60	0.065	0.110	0.140	0.165	0.185	0.210	0.235	0.275
M2.1.1 Stainless steel, austenitic, quenched, 180 HB										
M2.2.1 Duplex steel, high-strength stainless steels										
K1.1.1 Grey cast iron, pearlitic/ferritic, 180 HB		110	0.155	0.260	0.325	0.385	0.440	0.495	0.550	0.650
K1.1.2 Grey cast iron, pearlitic/martensitic, 260 HB		95	0.130	0.220	0.275	0.325	0.375	0.420	0.465	0.555
K1.2.1 Cast iron with spheroidal graphite, ferritic, 160 HB		95	0.130	0.220	0.275	0.325	0.375	0.420	0.465	0.555
K1.2.2 Cast iron with spheroidal graphite, pearlitic, 250 HB		90	0.125	0.210	0.260	0.305	0.355	0.395	0.440	0.520
K1.3.1 Malleable cast iron, ferritic, 130 HB		90	0.125	0.210	0.260	0.305	0.355	0.395	0.440	0.520
K1.3.2 Malleable cast iron, pearlitic, 230 HB		75	0.110	0.180	0.225	0.270	0.310	0.345	0.385	0.455
K2.1.1 Vermicular graphite cast iron (GJV)		90	0.155	0.260	0.325	0.385	0.440	0.495	0.550	0.650
K2.2.1 Austenitic-ferritic spheroidal graphite cast iron (ADI)		70	0.115	0.195	0.245	0.290	0.330	0.370	0.410	0.490
N1.1.1 Wrought aluminium alloys, non-hardened, 60 HB										
N1.1.2 Wrought aluminium alloys, hardened, 100 HB										
N2.1.1 Aluminium casting alloys, non-hardened, ≤ 12 % Si, 75 HB										
N2.1.2 Aluminium casting alloys, hardened, ≤ 12 % Si, 90 HB										
N2.1.3 Aluminium casting alloys, non-hardened, > 12 % Si, 130 HB										
N3.1.1 Copper and copper alloys: Free-machining alloy, Pb > 1 %										
N3.1.2 Copper and copper alloys: CuZn, CuSnZn										
N3.1.3 Copper and copper alloys: CuSn, lead-free copper and copper electrolyte										
N4.1.1 Non-metallic materials: Duroplastics, fibre-reinforced plastics										
N4.1.2 Non-metallic materials: Hard rubber, wood, etc.										
N4.1.3 Non-metallic materials: Graphite										
S1.1.1 Heat-resistant alloys, Fe-based, annealed, 200 HB		40	0.050	0.080	0.100	0.120	0.140	0.155	0.175	0.205
S1.1.2 Heat-resistant alloys, Fe-based, hardened, 280 HB		30	0.040	0.065	0.080	0.095	0.110	0.125	0.140	0.165
S1.1.3 Heat-resistant alloys, Ni- or Co-based, annealed, 250 HB		35	0.050	0.080	0.100	0.120	0.140	0.155	0.175	0.205
S1.1.4 Heat-resistant alloys, Ni- or Co-based, hardened, 350 HB		20	0.035	0.055	0.070	0.085	0.095	0.110	0.120	0.145
S1.1.5 Heat-resistant alloys, Ni- or Co-based, cast, 320 HB		25	0.035	0.055	0.070	0.085	0.095	0.110	0.120	0.145
S2.1.1 Titanium alloys, pure titanium, Rm 400 N/mm ²		40	0.050	0.080	0.100	0.120	0.140	0.155	0.175	0.205
S2.1.2 Titanium alloys, Alpha and Beta alloys, hardened, Rm 1050 N/mm ²		30	0.040	0.065	0.080	0.095	0.110	0.125	0.140	0.165
H1.1.1 Hardened steel, hardened and tempered, < 55 HRC		55	0.040	0.065	0.080	0.095	0.110	0.125	0.135	0.165
H1.1.2 Hardened steel, hardened and tempered, < 60 HRC										
H1.1.3 Hardened steel, hardened and tempered, > 60 HRC										
H2.1.1 Chilled cast iron, 400 HB										
H2.1.2 Chilled cast iron, hardened and tempered, < 55 HRC										



Ratio drills with coolant ducts, RT 100 VA, ≤ 5xD





Machining group		f (mm/rev) with nom. Ø							
			3	6	8	10	12	14	16
	v _c (m/min)								
P1.1.1 Unalloyed steel, annealed, 0.15 % C, Rm 420 N/mm ² , 125 HB									
P1.1.2 Unalloyed steel, heat-treated, 0.15 % C, Rm 420 N/mm ² , 125 HB									
P1.1.3 Unalloyed steel, annealed, 0.45 % C, Rm 640 N/mm ² , 190 HB									
P1.1.4 Unalloyed steel, heat-treated, 0.45 % C, Rm 640 N/mm ² , 190 HB									
P1.1.5 Unalloyed steel, heat-treated, 0.45 % C, Rm 850 N/mm ² , 250 HB									
P1.1.6 Unalloyed steel, annealed, 0.75 % C, Rm 915 N/mm ² , 270 HB									
P1.1.7 Unalloyed steel, heat-treated, 0.75 % C, Rm 1020 N/mm ² , 300 HB									
P2.1.1 Low-alloy steel, annealed, Rm 610 N/mm ² , 180 HB									
P2.1.2 Low-alloy steel, heat-treated, Rm 930 N/mm ² , 275 HB									
P2.1.3 Low-alloy steel, heat-treated, Rm 1020 N/mm ² , 300 HB									
P2.1.4 Low-alloy steel, heat-treated, Rm 1190 N/mm ² , 350 HB									
P3.1.1 High-alloy steel and tool steel, annealed, Rm 680 N/mm ² , 200 HB									
P3.1.2 High-alloy steel and tool steel, hardened and tempered, Rm 1100 N/mm ² , 325 HB									
M1.1.1 Stainless steel, ferritic/martensitic, with machining additives	80	0.075	0.130	0.160	0.190	0.220	0.250	0.275	0.325
M1.1.2 Stainless steel, ferritic/martensitic, annealed, Rm 680 N/mm ² , 200 HB	70	0.070	0.115	0.145	0.175	0.200	0.225	0.245	0.295
M1.1.3 Stainless steel, ferritic/martensitic, heat-treated, Rm 810 N/mm ² , 240 HB	70	0.065	0.110	0.140	0.165	0.185	0.210	0.235	0.275
M2.1.1 Stainless steel, austenitic, quenched, 180 HB	60	0.060	0.105	0.130	0.155	0.175	0.200	0.220	0.260
M2.2.1 Duplex steel, high-strength stainless steels	50	0.050	0.090	0.110	0.130	0.150	0.170	0.185	0.220
K1.1.1 Grey cast iron, pearlitic/ferritic, 180 HB									
K1.1.2 Grey cast iron, pearlitic/martensitic, 260 HB									
K1.2.1 Cast iron with spheroidal graphite, ferritic, 160 HB									
K1.2.2 Cast iron with spheroidal graphite, pearlitic, 250 HB									
K1.3.1 Malleable cast iron, ferritic, 130 HB									
K1.3.2 Malleable cast iron, pearlitic, 230 HB									
K2.1.1 Vermicular graphite cast iron (GJV)									
K2.2.1 Austenitic-ferritic spheroidal graphite cast iron (ADI)									
N1.1.1 Wrought aluminium alloys, non-hardened, 60 HB									
N1.1.2 Wrought aluminium alloys, hardened, 100 HB									
N2.1.1 Aluminium casting alloys, non-hardened, ≤ 12 % Si, 75 HB									
N2.1.2 Aluminium casting alloys, hardened, ≤ 12 % Si, 90 HB									
N2.1.3 Aluminium casting alloys, non-hardened, > 12 % Si, 130 HB									
N3.1.1 Copper and copper alloys: Free-machining alloy, Pb > 1 %									
N3.1.2 Copper and copper alloys: CuZn, CuSnZn									
N3.1.3 Copper and copper alloys: CuSn, lead-free copper and copper electrolyte									
N4.1.1 Non-metallic materials: Duroplastics, fibre-reinforced plastics									
N4.1.2 Non-metallic materials: Hard rubber, wood, etc.									
N4.1.3 Non-metallic materials: Graphite									
S1.1.1 Heat-resistant alloys, Fe-based, annealed, 200 HB	45	0.060	0.105	0.130	0.155	0.175	0.200	0.220	0.260
S1.1.2 Heat-resistant alloys, Fe-based, hardened, 280 HB	35	0.050	0.085	0.105	0.120	0.140	0.160	0.175	0.205
S1.1.3 Heat-resistant alloys, Ni- or Co-based, annealed, 250 HB	40	0.060	0.105	0.130	0.155	0.175	0.200	0.220	0.260
S1.1.4 Heat-resistant alloys, Ni- or Co-based, hardened, 350 HB	25	0.045	0.075	0.090	0.105	0.125	0.140	0.155	0.180
S1.1.5 Heat-resistant alloys, Ni- or Co-based, cast, 320 HB	25	0.045	0.075	0.090	0.105	0.125	0.140	0.155	0.180
S2.1.1 Titanium alloys, pure titanium, Rm 400 N/mm ²	45	0.060	0.105	0.130	0.155	0.175	0.200	0.220	0.260
S2.1.2 Titanium alloys, Alpha and Beta alloys, hardened, Rm 1050 N/mm ²	35	0.050	0.085	0.105	0.120	0.140	0.160	0.175	0.205
H1.1.1 Hardened steel, hardened and tempered, < 55 HRC									
H1.1.2 Hardened steel, hardened and tempered, < 60 HRC									
H1.1.3 Hardened steel, hardened and tempered, > 60 HRC									
H2.1.1 Chilled cast iron, 400 HB									
H2.1.2 Chilled cast iron, hardened and tempered, < 55 HRC									



Ratio drills with coolant ducts, RT 100 AL, 5xD





Cutting data

Machining group		f (mm/rev) with nom. Ø								
			3	6	8	10	12	14	16	20
	v _c (m/min)									
P1.1.1 Unalloyed steel, annealed, 0.15 % C, Rm 420 N/mm ² , 125 HB										
P1.1.2 Unalloyed steel, heat-treated, 0.15 % C, Rm 420 N/mm ² , 125 HB										
P1.1.3 Unalloyed steel, annealed, 0.45 % C, Rm 640 N/mm ² , 190 HB										
P1.1.4 Unalloyed steel, heat-treated, 0.45 % C, Rm 640 N/mm ² , 190 HB										
P1.1.5 Unalloyed steel, heat-treated, 0.45 % C, Rm 850 N/mm ² , 250 HB										
P1.1.6 Unalloyed steel, annealed, 0.75 % C, Rm 915 N/mm ² , 270 HB										
P1.1.7 Unalloyed steel, heat-treated, 0.75 % C, Rm 1020 N/mm ² , 300 HB										
P2.1.1 Low-alloy steel, annealed, Rm 610 N/mm ² , 180 HB										
P2.1.2 Low-alloy steel, heat-treated, Rm 930 N/mm ² , 275 HB										
P2.1.3 Low-alloy steel, heat-treated, Rm 1020 N/mm ² , 300 HB										
P2.1.4 Low-alloy steel, heat-treated, Rm 1190 N/mm ² , 350 HB										
P3.1.1 High-alloy steel and tool steel, annealed, Rm 680 N/mm ² , 200 HB										
P3.1.2 High-alloy steel and tool steel, hardened and tempered, Rm 1100 N/mm ² , 325 HB										
M1.1.1 Stainless steel, ferritic/martensitic, with machining additives										
M1.1.2 Stainless steel, ferritic/martensitic, annealed, Rm 680 N/mm ² , 200 HB										
M1.1.3 Stainless steel, ferritic/martensitic, heat-treated, Rm 810 N/mm ² , 240 HB										
M2.1.1 Stainless steel, austenitic, quenched, 180 HB										
M2.2.1 Duplex steel, high-strength stainless steels										
K1.1.1 Grey cast iron, pearlitic/ferritic, 180 HB										
K1.1.2 Grey cast iron, pearlitic/martensitic, 260 HB										
K1.2.1 Cast iron with spheroidal graphite, ferritic, 160 HB										
K1.2.2 Cast iron with spheroidal graphite, pearlitic, 250 HB										
K1.3.1 Malleable cast iron, ferritic, 130 HB										
K1.3.2 Malleable cast iron, pearlitic, 230 HB										
K2.1.1 Vermicular graphite cast iron (GJV)										
K2.2.1 Austenitic-ferritic spheroidal graphite cast iron (ADI)										
N1.1.1 Wrought aluminium alloys, non-hardened, 60 HB	240	0.190	0.325	0.405	0.480	0.550	0.620	0.685	0.815	
N1.1.2 Wrought aluminium alloys, hardened, 100 HB	240	0.190	0.325	0.405	0.480	0.550	0.620	0.685	0.815	
N2.1.1 Aluminium casting alloys, non-hardened, ≤ 12 % Si, 75 HB	220	0.190	0.325	0.405	0.480	0.550	0.620	0.685	0.815	
N2.1.2 Aluminium casting alloys, hardened, ≤ 12 % Si, 90 HB	220	0.190	0.325	0.405	0.480	0.550	0.620	0.685	0.815	
N2.1.3 Aluminium casting alloys, non-hardened, > 12 % Si, 130 HB	185	0.165	0.275	0.345	0.410	0.470	0.525	0.585	0.690	
N3.1.1 Copper and copper alloys: Free-machining alloy, Pb > 1 %	160	0.125	0.210	0.260	0.305	0.355	0.395	0.440	0.520	
N3.1.2 Copper and copper alloys: CuZn, CuSnZn	135	0.105	0.175	0.220	0.260	0.300	0.335	0.375	0.440	
N3.1.3 Copper and copper alloys: CuSn, lead-free copper and copper electrolyte	130	0.100	0.165	0.205	0.245	0.280	0.315	0.350	0.415	
N4.1.1 Non-metallic materials: Duroplastics, fibre-reinforced plastics	90	0.040	0.065	0.080	0.095	0.110	0.125	0.135	0.165	
N4.1.2 Non-metallic materials: Hard rubber, wood, etc.	90	0.040	0.065	0.080	0.095	0.110	0.125	0.135	0.165	
N4.1.3 Non-metallic materials: Graphite										
S1.1.1 Heat-resistant alloys, Fe-based, annealed, 200 HB										
S1.1.2 Heat-resistant alloys, Fe-based, hardened, 280 HB										
S1.1.3 Heat-resistant alloys, Ni- or Co-based, annealed, 250 HB										
S1.1.4 Heat-resistant alloys, Ni- or Co-based, hardened, 350 HB										
S1.1.5 Heat-resistant alloys, Ni- or Co-based, cast, 320 HB										
S2.1.1 Titanium alloys, pure titanium, Rm 400 N/mm ²										
S2.1.2 Titanium alloys, Alpha and Beta alloys, hardened, Rm 1050 N/mm ²										
H1.1.1 Hardened steel, hardened and tempered, < 55 HRC										
H1.1.2 Hardened steel, hardened and tempered, < 60 HRC										
H1.1.3 Hardened steel, hardened and tempered, > 60 HRC										
H2.1.1 Chilled cast iron, 400 HB										
H2.1.2 Chilled cast iron, hardened and tempered, < 55 HRC										



Ratio drills with coolant ducts, RT 100 R, 5xD





Machining group		f (mm/rev) with nom. Ø							
		v _c (m/min)	3	6	8	10	12	14	16
									
P1.1.1 Unalloyed steel, annealed, 0.15 % C, Rm 420 N/mm ² , 125 HB									
P1.1.2 Unalloyed steel, heat-treated, 0.15 % C, Rm 420 N/mm ² , 125 HB									
P1.1.3 Unalloyed steel, annealed, 0.45 % C, Rm 640 N/mm ² , 190 HB									
P1.1.4 Unalloyed steel, heat-treated, 0.45 % C, Rm 640 N/mm ² , 190 HB									
P1.1.5 Unalloyed steel, heat-treated, 0.45 % C, Rm 850 N/mm ² , 250 HB									
P1.1.6 Unalloyed steel, annealed, 0.75 % C, Rm 915 N/mm ² , 270 HB									
P1.1.7 Unalloyed steel, heat-treated, 0.75 % C, Rm 1020 N/mm ² , 300 HB									
P2.1.1 Low-alloy steel, annealed, Rm 610 N/mm ² , 180 HB									
P2.1.2 Low-alloy steel, heat-treated, Rm 930 N/mm ² , 275 HB									
P2.1.3 Low-alloy steel, heat-treated, Rm 1020 N/mm ² , 300 HB									
P2.1.4 Low-alloy steel, heat-treated, Rm 1190 N/mm ² , 350 HB									
P3.1.1 High-alloy steel and tool steel, annealed, Rm 680 N/mm ² , 200 HB									
P3.1.2 High-alloy steel and tool steel, hardened and tempered, Rm 1100 N/mm ² , 325 HB									
M1.1.1 Stainless steel, ferritic/martensitic, with machining additives									
M1.1.2 Stainless steel, ferritic/martensitic, annealed, Rm 680 N/mm ² , 200 HB									
M1.1.3 Stainless steel, ferritic/martensitic, heat-treated, Rm 810 N/mm ² , 240 HB									
M2.1.1 Stainless steel, austenitic, quenched, 180 HB									
M2.2.1 Duplex steel, high-strength stainless steels									
K1.1.1 Grey cast iron, pearlitic/ferritic, 180 HB	130	0.190	0.325	0.405	0.480	0.550	0.620	0.685	0.815
K1.1.2 Grey cast iron, pearlitic/martensitic, 260 HB	110	0.165	0.275	0.345	0.410	0.470	0.525	0.585	0.690
K1.2.1 Cast iron with spheroidal graphite, ferritic, 160 HB	110	0.165	0.275	0.345	0.410	0.470	0.525	0.585	0.690
K1.2.2 Cast iron with spheroidal graphite, pearlitic, 250 HB	105	0.155	0.260	0.325	0.385	0.440	0.495	0.550	0.650
K1.3.1 Malleable cast iron, ferritic, 130 HB	105	0.155	0.260	0.325	0.385	0.440	0.495	0.550	0.650
K1.3.2 Malleable cast iron, pearlitic, 230 HB	90	0.135	0.230	0.285	0.335	0.385	0.435	0.480	0.570
K2.1.1 Vermicular graphite cast iron (GJV)	100	0.190	0.325	0.405	0.480	0.550	0.620	0.685	0.815
K2.2.1 Austenitic-ferritic spheroidal graphite cast iron (ADI)	75	0.145	0.245	0.305	0.360	0.415	0.465	0.515	0.610
N1.1.1 Wrought aluminium alloys, non-hardened, 60 HB									
N1.1.2 Wrought aluminium alloys, hardened, 100 HB									
N2.1.1 Aluminium casting alloys, non-hardened, ≤ 12 % Si, 75 HB									
N2.1.2 Aluminium casting alloys, hardened, ≤ 12 % Si, 90 HB									
N2.1.3 Aluminium casting alloys, non-hardened, > 12 % Si, 130 HB									
N3.1.1 Copper and copper alloys: Free-machining alloy, Pb > 1 %									
N3.1.2 Copper and copper alloys: CuZn, CuSnZn									
N3.1.3 Copper and copper alloys: CuSn, lead-free copper and copper electrolyte									
N4.1.1 Non-metallic materials: Duroplastics, fibre-reinforced plastics									
N4.1.2 Non-metallic materials: Hard rubber, wood, etc.									
N4.1.3 Non-metallic materials: Graphite									
S1.1.1 Heat-resistant alloys, Fe-based, annealed, 200 HB									
S1.1.2 Heat-resistant alloys, Fe-based, hardened, 280 HB									
S1.1.3 Heat-resistant alloys, Ni- or Co-based, annealed, 250 HB									
S1.1.4 Heat-resistant alloys, Ni- or Co-based, hardened, 350 HB									
S1.1.5 Heat-resistant alloys, Ni- or Co-based, cast, 320 HB									
S2.1.1 Titanium alloys, pure titanium, Rm 400 N/mm ²									
S2.1.2 Titanium alloys, Alpha and Beta alloys, hardened, Rm 1050 N/mm ²									
H1.1.1 Hardened steel, hardened and tempered, < 55 HRC									
H1.1.2 Hardened steel, hardened and tempered, < 60 HRC									
H1.1.3 Hardened steel, hardened and tempered, > 60 HRC									
H2.1.1 Chilled cast iron, 400 HB									
H2.1.2 Chilled cast iron, hardened and tempered, < 55 HRC									



Ratio drills with coolant ducts, RT 100 R, 7xD





Machining group	 	f (mm/rev) with nom. Ø							
		v _c (m/min)	3	6	8	10	12	14	16
	P1.1.1 Unalloyed steel, annealed, 0.15 % C, Rm 420 N/mm ² , 125 HB								
P1.1.2 Unalloyed steel, heat-treated, 0.15 % C, Rm 420 N/mm ² , 125 HB									
P1.1.3 Unalloyed steel, annealed, 0.45 % C, Rm 640 N/mm ² , 190 HB									
P1.1.4 Unalloyed steel, heat-treated, 0.45 % C, Rm 640 N/mm ² , 190 HB									
P1.1.5 Unalloyed steel, heat-treated, 0.45 % C, Rm 850 N/mm ² , 250 HB									
P1.1.6 Unalloyed steel, annealed, 0.75 % C, Rm 915 N/mm ² , 270 HB									
P1.1.7 Unalloyed steel, heat-treated, 0.75 % C, Rm 1020 N/mm ² , 300 HB									
P2.1.1 Low-alloy steel, annealed, Rm 610 N/mm ² , 180 HB									
P2.1.2 Low-alloy steel, heat-treated, Rm 930 N/mm ² , 275 HB									
P2.1.3 Low-alloy steel, heat-treated, Rm 1020 N/mm ² , 300 HB									
P2.1.4 Low-alloy steel, heat-treated, Rm 1190 N/mm ² , 350 HB									
P3.1.1 High-alloy steel and tool steel, annealed, Rm 680 N/mm ² , 200 HB									
P3.1.2 High-alloy steel and tool steel, hardened and tempered, Rm 1100 N/mm ² , 325 HB									
M1.1.1 Stainless steel, ferritic/martensitic, with machining additives									
M1.1.2 Stainless steel, ferritic/martensitic, annealed, Rm 680 N/mm ² , 200 HB									
M1.1.3 Stainless steel, ferritic/martensitic, heat-treated, Rm 810 N/mm ² , 240 HB									
M2.1.1 Stainless steel, austenitic, quenched, 180 HB									
M2.2.1 Duplex steel, high-strength stainless steels									
K1.1.1 Grey cast iron, pearlitic/ferritic, 180 HB	130	0.155	0.260	0.325	0.385	0.440	0.495	0.550	0.650
K1.1.2 Grey cast iron, pearlitic/martensitic, 260 HB	110	0.130	0.220	0.275	0.325	0.375	0.420	0.465	0.555
K1.2.1 Cast iron with spheroidal graphite, ferritic, 160 HB	110	0.130	0.220	0.275	0.325	0.375	0.420	0.465	0.555
K1.2.2 Cast iron with spheroidal graphite, pearlitic, 250 HB	105	0.125	0.210	0.260	0.305	0.355	0.395	0.440	0.520
K1.3.1 Malleable cast iron, ferritic, 130 HB	105	0.125	0.210	0.260	0.305	0.355	0.395	0.440	0.520
K1.3.2 Malleable cast iron, pearlitic, 230 HB	90	0.110	0.180	0.225	0.270	0.310	0.345	0.385	0.455
K2.1.1 Vermicular graphite cast iron (GJV)	100	0.155	0.260	0.325	0.385	0.440	0.495	0.550	0.650
K2.2.1 Austenitic-ferritic spheroidal graphite cast iron (ADI)	75	0.115	0.195	0.245	0.290	0.330	0.370	0.410	0.490
N1.1.1 Wrought aluminium alloys, non-hardened, 60 HB									
N1.1.2 Wrought aluminium alloys, hardened, 100 HB									
N2.1.1 Aluminium casting alloys, non-hardened, ≤ 12 % Si, 75 HB									
N2.1.2 Aluminium casting alloys, hardened, ≤ 12 % Si, 90 HB									
N2.1.3 Aluminium casting alloys, non-hardened, > 12 % Si, 130 HB									
N3.1.1 Copper and copper alloys: Free-machining alloy, Pb > 1 %									
N3.1.2 Copper and copper alloys: CuZn, CuSnZn									
N3.1.3 Copper and copper alloys: CuSn, lead-free copper and copper electrolyte									
N4.1.1 Non-metallic materials: Duroplastics, fibre-reinforced plastics									
N4.1.2 Non-metallic materials: Hard rubber, wood, etc.									
N4.1.3 Non-metallic materials: Graphite									
S1.1.1 Heat-resistant alloys, Fe-based, annealed, 200 HB									
S1.1.2 Heat-resistant alloys, Fe-based, hardened, 280 HB									
S1.1.3 Heat-resistant alloys, Ni- or Co-based, annealed, 250 HB									
S1.1.4 Heat-resistant alloys, Ni- or Co-based, hardened, 350 HB									
S1.1.5 Heat-resistant alloys, Ni- or Co-based, cast, 320 HB									
S2.1.1 Titanium alloys, pure titanium, Rm 400 N/mm ²									
S2.1.2 Titanium alloys, Alpha and Beta alloys, hardened, Rm 1050 N/mm ²									
H1.1.1 Hardened steel, hardened and tempered, < 55 HRC									
H1.1.2 Hardened steel, hardened and tempered, < 60 HRC									
H1.1.3 Hardened steel, hardened and tempered, > 60 HRC									
H2.1.1 Chilled cast iron, 400 HB									
H2.1.2 Chilled cast iron, hardened and tempered, < 55 HRC									



Ratio drills with coolant ducts, RT 150 GG, 120°, 4xD





Machining group		f (mm/rev) with nom. Ø							
			3	6	8	10	12	14	16
	v _c (m/min)								
P1.1.1 Unalloyed steel, annealed, 0.15 % C, Rm 420 N/mm ² , 125 HB									
P1.1.2 Unalloyed steel, heat-treated, 0.15 % C, Rm 420 N/mm ² , 125 HB									
P1.1.3 Unalloyed steel, annealed, 0.45 % C, Rm 640 N/mm ² , 190 HB									
P1.1.4 Unalloyed steel, heat-treated, 0.45 % C, Rm 640 N/mm ² , 190 HB									
P1.1.5 Unalloyed steel, heat-treated, 0.45 % C, Rm 850 N/mm ² , 250 HB									
P1.1.6 Unalloyed steel, annealed, 0.75 % C, Rm 915 N/mm ² , 270 HB									
P1.1.7 Unalloyed steel, heat-treated, 0.75 % C, Rm 1020 N/mm ² , 300 HB									
P2.1.1 Low-alloy steel, annealed, Rm 610 N/mm ² , 180 HB									
P2.1.2 Low-alloy steel, heat-treated, Rm 930 N/mm ² , 275 HB									
P2.1.3 Low-alloy steel, heat-treated, Rm 1020 N/mm ² , 300 HB									
P2.1.4 Low-alloy steel, heat-treated, Rm 1190 N/mm ² , 350 HB									
P3.1.1 High-alloy steel and tool steel, annealed, Rm 680 N/mm ² , 200 HB									
P3.1.2 High-alloy steel and tool steel, hardened and tempered, Rm 1100 N/mm ² , 325 HB									
M1.1.1 Stainless steel, ferritic/martensitic, with machining additives									
M1.1.2 Stainless steel, ferritic/martensitic, annealed, Rm 680 N/mm ² , 200 HB									
M1.1.3 Stainless steel, ferritic/martensitic, heat-treated, Rm 810 N/mm ² , 240 HB									
M2.1.1 Stainless steel, austenitic, quenched, 180 HB									
M2.2.1 Duplex steel, high-strength stainless steels									
K1.1.1 Grey cast iron, pearlitic/ferritic, 180 HB	100	0.125	0.210	0.260	0.305	0.355	0.395	0.440	0.520
K1.1.2 Grey cast iron, pearlitic/martensitic, 260 HB	85	0.105	0.175	0.220	0.260	0.300	0.335	0.375	0.440
K1.2.1 Cast iron with spheroidal graphite, ferritic, 160 HB	85	0.105	0.175	0.220	0.260	0.300	0.335	0.375	0.440
K1.2.2 Cast iron with spheroidal graphite, pearlitic, 250 HB	80	0.100	0.165	0.205	0.245	0.280	0.315	0.350	0.415
K1.3.1 Malleable cast iron, ferritic, 130 HB	80	0.100	0.165	0.205	0.245	0.280	0.315	0.350	0.415
K1.3.2 Malleable cast iron, pearlitic, 230 HB	70	0.085	0.145	0.180	0.215	0.245	0.280	0.305	0.365
K2.1.1 Vermicular graphite cast iron (GJV)									
K2.2.1 Austenitic-ferritic spheroidal graphite cast iron (ADI)									
N1.1.1 Wrought aluminium alloys, non-hardened, 60 HB	210	0.155	0.260	0.325	0.385	0.440	0.495	0.550	0.650
N1.1.2 Wrought aluminium alloys, hardened, 100 HB	210	0.155	0.260	0.325	0.385	0.440	0.495	0.550	0.650
N2.1.1 Aluminium casting alloys, non-hardened, ≤ 12 % Si, 75 HB	190	0.155	0.260	0.325	0.385	0.440	0.495	0.550	0.650
N2.1.2 Aluminium casting alloys, hardened, ≤ 12 % Si, 90 HB	190	0.155	0.260	0.325	0.385	0.440	0.495	0.550	0.650
N2.1.3 Aluminium casting alloys, non-hardened, > 12 % Si, 130 HB	160	0.130	0.220	0.275	0.325	0.375	0.420	0.465	0.555
N3.1.1 Copper and copper alloys: Free-machining alloy, Pb > 1 %									
N3.1.2 Copper and copper alloys: CuZn, CuSnZn									
N3.1.3 Copper and copper alloys: CuSn, lead-free copper and copper electrolyte									
N4.1.1 Non-metallic materials: Duroplastics, fibre-reinforced plastics									
N4.1.2 Non-metallic materials: Hard rubber, wood, etc.									
N4.1.3 Non-metallic materials: Graphite									
S1.1.1 Heat-resistant alloys, Fe-based, annealed, 200 HB									
S1.1.2 Heat-resistant alloys, Fe-based, hardened, 280 HB									
S1.1.3 Heat-resistant alloys, Ni- or Co-based, annealed, 250 HB									
S1.1.4 Heat-resistant alloys, Ni- or Co-based, hardened, 350 HB									
S1.1.5 Heat-resistant alloys, Ni- or Co-based, cast, 320 HB									
S2.1.1 Titanium alloys, pure titanium, Rm 400 N/mm ²									
S2.1.2 Titanium alloys, Alpha and Beta alloys, hardened, Rm 1050 N/mm ²									
H1.1.1 Hardened steel, hardened and tempered, < 55 HRC									
H1.1.2 Hardened steel, hardened and tempered, < 60 HRC									
H1.1.3 Hardened steel, hardened and tempered, > 60 HRC									
H2.1.1 Chilled cast iron, 400 HB	35	0.04	0.065	0.08	0.095	0.11	0.125	0.135	0.165
H2.1.2 Chilled cast iron, hardened and tempered, < 55 HRC	25	0.025	0.045	0.055	0.065	0.075	0.085	0.095	0.115



Ratio drills with coolant ducts, RT 150 GG, 120°, 7xD





Machining group		f (mm/rev) with nom. Ø							
			3	6	8	10	12	14	16
	v _c (m/min)								
P1.1.1 Unalloyed steel, annealed, 0.15 % C, Rm 420 N/mm ² , 125 HB									
P1.1.2 Unalloyed steel, heat-treated, 0.15 % C, Rm 420 N/mm ² , 125 HB									
P1.1.3 Unalloyed steel, annealed, 0.45 % C, Rm 640 N/mm ² , 190 HB									
P1.1.4 Unalloyed steel, heat-treated, 0.45 % C, Rm 640 N/mm ² , 190 HB									
P1.1.5 Unalloyed steel, heat-treated, 0.45 % C, Rm 850 N/mm ² , 250 HB									
P1.1.6 Unalloyed steel, annealed, 0.75 % C, Rm 915 N/mm ² , 270 HB									
P1.1.7 Unalloyed steel, heat-treated, 0.75 % C, Rm 1020 N/mm ² , 300 HB									
P2.1.1 Low-alloy steel, annealed, Rm 610 N/mm ² , 180 HB									
P2.1.2 Low-alloy steel, heat-treated, Rm 930 N/mm ² , 275 HB									
P2.1.3 Low-alloy steel, heat-treated, Rm 1020 N/mm ² , 300 HB									
P2.1.4 Low-alloy steel, heat-treated, Rm 1190 N/mm ² , 350 HB									
P3.1.1 High-alloy steel and tool steel, annealed, Rm 680 N/mm ² , 200 HB									
P3.1.2 High-alloy steel and tool steel, hardened and tempered, Rm 1100 N/mm ² , 325 HB									
M1.1.1 Stainless steel, ferritic/martensitic, with machining additives									
M1.1.2 Stainless steel, ferritic/martensitic, annealed, Rm 680 N/mm ² , 200 HB									
M1.1.3 Stainless steel, ferritic/martensitic, heat-treated, Rm 810 N/mm ² , 240 HB									
M2.1.1 Stainless steel, austenitic, quenched, 180 HB									
M2.2.1 Duplex steel, high-strength stainless steels									
K1.1.1 Grey cast iron, pearlitic/ferritic, 180 HB	100	0.125	0.210	0.260	0.305	0.355	0.395	0.440	0.520
K1.1.2 Grey cast iron, pearlitic/martensitic, 260 HB	85	0.105	0.175	0.220	0.260	0.300	0.335	0.375	0.440
K1.2.1 Cast iron with spheroidal graphite, ferritic, 160 HB	85	0.105	0.175	0.220	0.260	0.300	0.335	0.375	0.440
K1.2.2 Cast iron with spheroidal graphite, pearlitic, 250 HB	80	0.100	0.165	0.205	0.245	0.280	0.315	0.350	0.415
K1.3.1 Malleable cast iron, ferritic, 130 HB	80	0.100	0.165	0.205	0.245	0.280	0.315	0.350	0.415
K1.3.2 Malleable cast iron, pearlitic, 230 HB	70	0.085	0.145	0.180	0.215	0.245	0.280	0.305	0.365
K2.1.1 Vermicular graphite cast iron (GJV)									
K2.2.1 Austenitic-ferritic spheroidal graphite cast iron (ADI)									
N1.1.1 Wrought aluminium alloys, non-hardened, 60 HB	210	0.155	0.260	0.325	0.385	0.440	0.495	0.550	0.650
N1.1.2 Wrought aluminium alloys, hardened, 100 HB	210	0.155	0.260	0.325	0.385	0.440	0.495	0.550	0.650
N2.1.1 Aluminium casting alloys, non-hardened, ≤ 12 % Si, 75 HB	190	0.155	0.260	0.325	0.385	0.440	0.495	0.550	0.650
N2.1.2 Aluminium casting alloys, hardened, ≤ 12 % Si, 90 HB	190	0.155	0.260	0.325	0.385	0.440	0.495	0.550	0.650
N2.1.3 Aluminium casting alloys, non-hardened, > 12 % Si, 130 HB	160	0.130	0.220	0.275	0.325	0.375	0.420	0.465	0.555
N3.1.1 Copper and copper alloys: Free-machining alloy, Pb > 1 %									
N3.1.2 Copper and copper alloys: CuZn, CuSnZn									
N3.1.3 Copper and copper alloys: CuSn, lead-free copper and copper electrolyte									
N4.1.1 Non-metallic materials: Duroplastics, fibre-reinforced plastics									
N4.1.2 Non-metallic materials: Hard rubber, wood, etc.									
N4.1.3 Non-metallic materials: Graphite									
S1.1.1 Heat-resistant alloys, Fe-based, annealed, 200 HB									
S1.1.2 Heat-resistant alloys, Fe-based, hardened, 280 HB									
S1.1.3 Heat-resistant alloys, Ni- or Co-based, annealed, 250 HB									
S1.1.4 Heat-resistant alloys, Ni- or Co-based, hardened, 350 HB									
S1.1.5 Heat-resistant alloys, Ni- or Co-based, cast, 320 HB									
S2.1.1 Titanium alloys, pure titanium, Rm 400 N/mm ²									
S2.1.2 Titanium alloys, Alpha and Beta alloys, hardened, Rm 1050 N/mm ²									
H1.1.1 Hardened steel, hardened and tempered, < 55 HRC									
H1.1.2 Hardened steel, hardened and tempered, < 60 HRC									
H1.1.3 Hardened steel, hardened and tempered, > 60 HRC									
H2.1.1 Chilled cast iron, 400 HB	35	0.040	0.065	0.080	0.095	0.110	0.125	0.135	0.165
H2.1.2 Chilled cast iron, hardened and tempered, < 55 HRC	25	0.025	0.045	0.055	0.065	0.075	0.085	0.095	0.115



Ratio drills with coolant ducts, RT 150 GG, 120°, 10xD





Machining group		f (mm/rev) with nom. Ø							
			3	6	8	10	12	14	16
	v _c (m/min)								
P1.1.1 Unalloyed steel, annealed, 0.15 % C, Rm 420 N/mm ² , 125 HB									
P1.1.2 Unalloyed steel, heat-treated, 0.15 % C, Rm 420 N/mm ² , 125 HB									
P1.1.3 Unalloyed steel, annealed, 0.45 % C, Rm 640 N/mm ² , 190 HB									
P1.1.4 Unalloyed steel, heat-treated, 0.45 % C, Rm 640 N/mm ² , 190 HB									
P1.1.5 Unalloyed steel, heat-treated, 0.45 % C, Rm 850 N/mm ² , 250 HB									
P1.1.6 Unalloyed steel, annealed, 0.75 % C, Rm 915 N/mm ² , 270 HB									
P1.1.7 Unalloyed steel, heat-treated, 0.75 % C, Rm 1020 N/mm ² , 300 HB									
P2.1.1 Low-alloy steel, annealed, Rm 610 N/mm ² , 180 HB									
P2.1.2 Low-alloy steel, heat-treated, Rm 930 N/mm ² , 275 HB									
P2.1.3 Low-alloy steel, heat-treated, Rm 1020 N/mm ² , 300 HB									
P2.1.4 Low-alloy steel, heat-treated, Rm 1190 N/mm ² , 350 HB									
P3.1.1 High-alloy steel and tool steel, annealed, Rm 680 N/mm ² , 200 HB									
P3.1.2 High-alloy steel and tool steel, hardened and tempered, Rm 1100 N/mm ² , 325 HB									
M1.1.1 Stainless steel, ferritic/martensitic, with machining additives									
M1.1.2 Stainless steel, ferritic/martensitic, annealed, Rm 680 N/mm ² , 200 HB									
M1.1.3 Stainless steel, ferritic/martensitic, heat-treated, Rm 810 N/mm ² , 240 HB									
M2.1.1 Stainless steel, austenitic, quenched, 180 HB									
M2.2.1 Duplex steel, high-strength stainless steels									
K1.1.1 Grey cast iron, pearlitic/ferritic, 180 HB	100	0.095	0.165	0.205	0.240	0.275	0.310	0.345	0.405
K1.1.2 Grey cast iron, pearlitic/martensitic, 260 HB	85	0.080	0.140	0.170	0.205	0.235	0.265	0.290	0.345
K1.2.1 Cast iron with spheroidal graphite, ferritic, 160 HB	85	0.080	0.140	0.170	0.205	0.235	0.265	0.290	0.345
K1.2.2 Cast iron with spheroidal graphite, pearlitic, 250 HB	80	0.075	0.130	0.160	0.190	0.220	0.250	0.275	0.325
K1.3.1 Malleable cast iron, ferritic, 130 HB	80	0.075	0.130	0.160	0.190	0.220	0.250	0.275	0.325
K1.3.2 Malleable cast iron, pearlitic, 230 HB	70	0.065	0.115	0.140	0.170	0.195	0.215	0.240	0.285
K2.1.1 Vermicular graphite cast iron (GJV)									
K2.2.1 Austenitic-ferritic spheroidal graphite cast iron (ADI)									
N1.1.1 Wrought aluminium alloys, non-hardened, 60 HB	210	0.125	0.210	0.260	0.305	0.355	0.395	0.440	0.520
N1.1.2 Wrought aluminium alloys, hardened, 100 HB	210	0.125	0.210	0.260	0.305	0.355	0.395	0.440	0.520
N2.1.1 Aluminium casting alloys, non-hardened, ≤ 12 % Si, 75 HB	190	0.125	0.210	0.260	0.305	0.355	0.395	0.440	0.520
N2.1.2 Aluminium casting alloys, hardened, ≤ 12 % Si, 90 HB	190	0.125	0.210	0.260	0.305	0.355	0.395	0.440	0.520
N2.1.3 Aluminium casting alloys, non-hardened, > 12 % Si, 130 HB	160	0.105	0.175	0.220	0.260	0.300	0.335	0.375	0.440
N3.1.1 Copper and copper alloys: Free-machining alloy, Pb > 1 %									
N3.1.2 Copper and copper alloys: CuZn, CuSnZn									
N3.1.3 Copper and copper alloys: CuSn, lead-free copper and copper electrolyte									
N4.1.1 Non-metallic materials: Duroplastics, fibre-reinforced plastics									
N4.1.2 Non-metallic materials: Hard rubber, wood, etc.									
N4.1.3 Non-metallic materials: Graphite									
S1.1.1 Heat-resistant alloys, Fe-based, annealed, 200 HB									
S1.1.2 Heat-resistant alloys, Fe-based, hardened, 280 HB									
S1.1.3 Heat-resistant alloys, Ni- or Co-based, annealed, 250 HB									
S1.1.4 Heat-resistant alloys, Ni- or Co-based, hardened, 350 HB									
S1.1.5 Heat-resistant alloys, Ni- or Co-based, cast, 320 HB									
S2.1.1 Titanium alloys, pure titanium, Rm 400 N/mm ²									
S2.1.2 Titanium alloys, Alpha and Beta alloys, hardened, Rm 1050 N/mm ²									
H1.1.1 Hardened steel, hardened and tempered, < 55 HRC									
H1.1.2 Hardened steel, hardened and tempered, < 60 HRC									
H1.1.3 Hardened steel, hardened and tempered, > 60 HRC									
H2.1.1 Chilled cast iron, 400 HB	35	0.040	0.065	0.080	0.095	0.110	0.125	0.135	0.165
H2.1.2 Chilled cast iron, hardened and tempered, < 55 HRC	25	0.025	0.045	0.055	0.065	0.075	0.085	0.095	0.115



Ratio drills with coolant ducts, RT 150 GG, 130°, 4xD





Machining group		f (mm/rev) with nom. Ø							
			3	6	8	10	12	14	16
	v _c (m/min)								
P1.1.1 Unalloyed steel, annealed, 0.15 % C, Rm 420 N/mm ² , 125 HB									
P1.1.2 Unalloyed steel, heat-treated, 0.15 % C, Rm 420 N/mm ² , 125 HB									
P1.1.3 Unalloyed steel, annealed, 0.45 % C, Rm 640 N/mm ² , 190 HB									
P1.1.4 Unalloyed steel, heat-treated, 0.45 % C, Rm 640 N/mm ² , 190 HB									
P1.1.5 Unalloyed steel, heat-treated, 0.45 % C, Rm 850 N/mm ² , 250 HB									
P1.1.6 Unalloyed steel, annealed, 0.75 % C, Rm 915 N/mm ² , 270 HB									
P1.1.7 Unalloyed steel, heat-treated, 0.75 % C, Rm 1020 N/mm ² , 300 HB									
P2.1.1 Low-alloy steel, annealed, Rm 610 N/mm ² , 180 HB									
P2.1.2 Low-alloy steel, heat-treated, Rm 930 N/mm ² , 275 HB									
P2.1.3 Low-alloy steel, heat-treated, Rm 1020 N/mm ² , 300 HB									
P2.1.4 Low-alloy steel, heat-treated, Rm 1190 N/mm ² , 350 HB									
P3.1.1 High-alloy steel and tool steel, annealed, Rm 680 N/mm ² , 200 HB									
P3.1.2 High-alloy steel and tool steel, hardened and tempered, Rm 1100 N/mm ² , 325 HB									
M1.1.1 Stainless steel, ferritic/martensitic, with machining additives									
M1.1.2 Stainless steel, ferritic/martensitic, annealed, Rm 680 N/mm ² , 200 HB									
M1.1.3 Stainless steel, ferritic/martensitic, heat-treated, Rm 810 N/mm ² , 240 HB									
M2.1.1 Stainless steel, austenitic, quenched, 180 HB									
M2.2.1 Duplex steel, high-strength stainless steels									
K1.1.1 Grey cast iron, pearlitic/ferritic, 180 HB	105	0.125	0.210	0.260	0.305	0.355	0.395	0.440	0.520
K1.1.2 Grey cast iron, pearlitic/martensitic, 260 HB	90	0.105	0.175	0.220	0.260	0.300	0.335	0.375	0.440
K1.2.1 Cast iron with spheroidal graphite, ferritic, 160 HB	90	0.105	0.175	0.220	0.260	0.300	0.335	0.375	0.440
K1.2.2 Cast iron with spheroidal graphite, pearlitic, 250 HB	85	0.100	0.165	0.205	0.245	0.280	0.315	0.350	0.415
K1.3.1 Malleable cast iron, ferritic, 130 HB	85	0.100	0.165	0.205	0.245	0.280	0.315	0.350	0.415
K1.3.2 Malleable cast iron, pearlitic, 230 HB	75	0.085	0.145	0.180	0.215	0.245	0.280	0.305	0.365
K2.1.1 Vermicular graphite cast iron (GJV)									
K2.2.1 Austenitic-ferritic spheroidal graphite cast iron (ADI)									
N1.1.1 Wrought aluminium alloys, non-hardened, 60 HB	200	0.155	0.260	0.325	0.385	0.440	0.495	0.550	0.650
N1.1.2 Wrought aluminium alloys, hardened, 100 HB	200	0.155	0.260	0.325	0.385	0.440	0.495	0.550	0.650
N2.1.1 Aluminium casting alloys, non-hardened, ≤ 12 % Si, 75 HB	180	0.155	0.260	0.325	0.385	0.440	0.495	0.550	0.650
N2.1.2 Aluminium casting alloys, hardened, ≤ 12 % Si, 90 HB	180	0.155	0.260	0.325	0.385	0.440	0.495	0.550	0.650
N2.1.3 Aluminium casting alloys, non-hardened, > 12 % Si, 130 HB	155	0.130	0.220	0.275	0.325	0.375	0.420	0.465	0.555
N3.1.1 Copper and copper alloys: Free-machining alloy, Pb > 1 %									
N3.1.2 Copper and copper alloys: CuZn, CuSnZn									
N3.1.3 Copper and copper alloys: CuSn, lead-free copper and copper electrolyte									
N4.1.1 Non-metallic materials: Duroplastics, fibre-reinforced plastics									
N4.1.2 Non-metallic materials: Hard rubber, wood, etc.									
N4.1.3 Non-metallic materials: Graphite									
S1.1.1 Heat-resistant alloys, Fe-based, annealed, 200 HB									
S1.1.2 Heat-resistant alloys, Fe-based, hardened, 280 HB									
S1.1.3 Heat-resistant alloys, Ni- or Co-based, annealed, 250 HB									
S1.1.4 Heat-resistant alloys, Ni- or Co-based, hardened, 350 HB									
S1.1.5 Heat-resistant alloys, Ni- or Co-based, cast, 320 HB									
S2.1.1 Titanium alloys, pure titanium, Rm 400 N/mm ²									
S2.1.2 Titanium alloys, Alpha and Beta alloys, hardened, Rm 1050 N/mm ²									
H1.1.1 Hardened steel, hardened and tempered, < 55 HRC									
H1.1.2 Hardened steel, hardened and tempered, < 60 HRC									
H1.1.3 Hardened steel, hardened and tempered, > 60 HRC									
H2.1.1 Chilled cast iron, 400 HB	35	0.04	0.065	0.08	0.095	0.11	0.125	0.135	0.165
H2.1.2 Chilled cast iron, hardened and tempered, < 55 HRC	25	0.025	0.045	0.055	0.065	0.075	0.085	0.095	0.115



Ratio drills with coolant ducts, RT 150 GG, 130°, 7xD





Machining group		f (mm/rev) with nom. Ø							
			3	6	8	10	12	14	16
	v _c (m/min)								
P1.1.1 Unalloyed steel, annealed, 0.15 % C, Rm 420 N/mm ² , 125 HB									
P1.1.2 Unalloyed steel, heat-treated, 0.15 % C, Rm 420 N/mm ² , 125 HB									
P1.1.3 Unalloyed steel, annealed, 0.45 % C, Rm 640 N/mm ² , 190 HB									
P1.1.4 Unalloyed steel, heat-treated, 0.45 % C, Rm 640 N/mm ² , 190 HB									
P1.1.5 Unalloyed steel, heat-treated, 0.45 % C, Rm 850 N/mm ² , 250 HB									
P1.1.6 Unalloyed steel, annealed, 0.75 % C, Rm 915 N/mm ² , 270 HB									
P1.1.7 Unalloyed steel, heat-treated, 0.75 % C, Rm 1020 N/mm ² , 300 HB									
P2.1.1 Low-alloy steel, annealed, Rm 610 N/mm ² , 180 HB									
P2.1.2 Low-alloy steel, heat-treated, Rm 930 N/mm ² , 275 HB									
P2.1.3 Low-alloy steel, heat-treated, Rm 1020 N/mm ² , 300 HB									
P2.1.4 Low-alloy steel, heat-treated, Rm 1190 N/mm ² , 350 HB									
P3.1.1 High-alloy steel and tool steel, annealed, Rm 680 N/mm ² , 200 HB									
P3.1.2 High-alloy steel and tool steel, hardened and tempered, Rm 1100 N/mm ² , 325 HB									
M1.1.1 Stainless steel, ferritic/martensitic, with machining additives									
M1.1.2 Stainless steel, ferritic/martensitic, annealed, Rm 680 N/mm ² , 200 HB									
M1.1.3 Stainless steel, ferritic/martensitic, heat-treated, Rm 810 N/mm ² , 240 HB									
M2.1.1 Stainless steel, austenitic, quenched, 180 HB									
M2.2.1 Duplex steel, high-strength stainless steels									
K1.1.1 Grey cast iron, pearlitic/ferritic, 180 HB	105	0.125	0.210	0.260	0.305	0.355	0.395	0.440	0.520
K1.1.2 Grey cast iron, pearlitic/martensitic, 260 HB	90	0.105	0.175	0.220	0.260	0.300	0.335	0.375	0.440
K1.2.1 Cast iron with spheroidal graphite, ferritic, 160 HB	90	0.105	0.175	0.220	0.260	0.300	0.335	0.375	0.440
K1.2.2 Cast iron with spheroidal graphite, pearlitic, 250 HB	85	0.100	0.165	0.205	0.245	0.280	0.315	0.350	0.415
K1.3.1 Malleable cast iron, ferritic, 130 HB	85	0.100	0.165	0.205	0.245	0.280	0.315	0.350	0.415
K1.3.2 Malleable cast iron, pearlitic, 230 HB	75	0.085	0.145	0.180	0.215	0.245	0.280	0.305	0.365
K2.1.1 Vermicular graphite cast iron (GJV)									
K2.2.1 Austenitic-ferritic spheroidal graphite cast iron (ADI)									
N1.1.1 Wrought aluminium alloys, non-hardened, 60 HB	200	0.155	0.260	0.325	0.385	0.440	0.495	0.550	0.650
N1.1.2 Wrought aluminium alloys, hardened, 100 HB	200	0.155	0.260	0.325	0.385	0.440	0.495	0.550	0.650
N2.1.1 Aluminium casting alloys, non-hardened, ≤ 12 % Si, 75 HB	180	0.155	0.260	0.325	0.385	0.440	0.495	0.550	0.650
N2.1.2 Aluminium casting alloys, hardened, ≤ 12 % Si, 90 HB	180	0.155	0.260	0.325	0.385	0.440	0.495	0.550	0.650
N2.1.3 Aluminium casting alloys, non-hardened, > 12 % Si, 130 HB	155	0.130	0.220	0.275	0.325	0.375	0.420	0.465	0.555
N3.1.1 Copper and copper alloys: Free-machining alloy, Pb > 1 %									
N3.1.2 Copper and copper alloys: CuZn, CuSnZn									
N3.1.3 Copper and copper alloys: CuSn, lead-free copper and copper electrolyte									
N4.1.1 Non-metallic materials: Duroplastics, fibre-reinforced plastics									
N4.1.2 Non-metallic materials: Hard rubber, wood, etc.									
N4.1.3 Non-metallic materials: Graphite									
S1.1.1 Heat-resistant alloys, Fe-based, annealed, 200 HB									
S1.1.2 Heat-resistant alloys, Fe-based, hardened, 280 HB									
S1.1.3 Heat-resistant alloys, Ni- or Co-based, annealed, 250 HB									
S1.1.4 Heat-resistant alloys, Ni- or Co-based, hardened, 350 HB									
S1.1.5 Heat-resistant alloys, Ni- or Co-based, cast, 320 HB									
S2.1.1 Titanium alloys, pure titanium, Rm 400 N/mm ²									
S2.1.2 Titanium alloys, Alpha and Beta alloys, hardened, Rm 1050 N/mm ²									
H1.1.1 Hardened steel, hardened and tempered, < 55 HRC									
H1.1.2 Hardened steel, hardened and tempered, < 60 HRC									
H1.1.3 Hardened steel, hardened and tempered, > 60 HRC									
H2.1.1 Chilled cast iron, 400 HB	40	0.040	0.065	0.080	0.095	0.110	0.125	0.135	0.165
H2.1.2 Chilled cast iron, hardened and tempered, < 55 HRC	30	0.025	0.045	0.055	0.065	0.075	0.085	0.095	0.115



Ratio drills with coolant ducts, RT 150 GG, 130°, 10xD





Cutting data

Machining group		f (mm/rev) with nom. Ø							
			3	6	8	10	12	14	16
	v _c (m/min)								
P1.1.1 Unalloyed steel, annealed, 0.15 % C, Rm 420 N/mm ² , 125 HB									
P1.1.2 Unalloyed steel, heat-treated, 0.15 % C, Rm 420 N/mm ² , 125 HB									
P1.1.3 Unalloyed steel, annealed, 0.45 % C, Rm 640 N/mm ² , 190 HB									
P1.1.4 Unalloyed steel, heat-treated, 0.45 % C, Rm 640 N/mm ² , 190 HB									
P1.1.5 Unalloyed steel, heat-treated, 0.45 % C, Rm 850 N/mm ² , 250 HB									
P1.1.6 Unalloyed steel, annealed, 0.75 % C, Rm 915 N/mm ² , 270 HB									
P1.1.7 Unalloyed steel, heat-treated, 0.75 % C, Rm 1020 N/mm ² , 300 HB									
P2.1.1 Low-alloy steel, annealed, Rm 610 N/mm ² , 180 HB									
P2.1.2 Low-alloy steel, heat-treated, Rm 930 N/mm ² , 275 HB									
P2.1.3 Low-alloy steel, heat-treated, Rm 1020 N/mm ² , 300 HB									
P2.1.4 Low-alloy steel, heat-treated, Rm 1190 N/mm ² , 350 HB									
P3.1.1 High-alloy steel and tool steel, annealed, Rm 680 N/mm ² , 200 HB									
P3.1.2 High-alloy steel and tool steel, hardened and tempered, Rm 1100 N/mm ² , 325 HB									
M1.1.1 Stainless steel, ferritic/martensitic, with machining additives									
M1.1.2 Stainless steel, ferritic/martensitic, annealed, Rm 680 N/mm ² , 200 HB									
M1.1.3 Stainless steel, ferritic/martensitic, heat-treated, Rm 810 N/mm ² , 240 HB									
M2.1.1 Stainless steel, austenitic, quenched, 180 HB									
M2.2.1 Duplex steel, high-strength stainless steels									
K1.1.1 Grey cast iron, pearlitic/ferritic, 180 HB	105	0.095	0.165	0.205	0.240	0.275	0.310	0.345	0.405
K1.1.2 Grey cast iron, pearlitic/martensitic, 260 HB	90	0.080	0.140	0.170	0.205	0.235	0.265	0.290	0.345
K1.2.1 Cast iron with spheroidal graphite, ferritic, 160 HB	90	0.080	0.140	0.170	0.205	0.235	0.265	0.290	0.345
K1.2.2 Cast iron with spheroidal graphite, pearlitic, 250 HB	85	0.075	0.130	0.160	0.190	0.220	0.250	0.275	0.325
K1.3.1 Malleable cast iron, ferritic, 130 HB	85	0.075	0.130	0.160	0.190	0.220	0.250	0.275	0.325
K1.3.2 Malleable cast iron, pearlitic, 230 HB	75	0.065	0.115	0.140	0.170	0.195	0.215	0.240	0.285
K2.1.1 Vermicular graphite cast iron (GJV)									
K2.2.1 Austenitic-ferritic spheroidal graphite cast iron (ADI)									
N1.1.1 Wrought aluminium alloys, non-hardened, 60 HB	200	0.125	0.210	0.260	0.305	0.355	0.395	0.440	0.520
N1.1.2 Wrought aluminium alloys, hardened, 100 HB	200	0.125	0.210	0.260	0.305	0.355	0.395	0.440	0.520
N2.1.1 Aluminium casting alloys, non-hardened, ≤ 12 % Si, 75 HB	180	0.125	0.210	0.260	0.305	0.355	0.395	0.440	0.520
N2.1.2 Aluminium casting alloys, hardened, ≤ 12 % Si, 90 HB	180	0.125	0.210	0.260	0.305	0.355	0.395	0.440	0.520
N2.1.3 Aluminium casting alloys, non-hardened, > 12 % Si, 130 HB	155	0.105	0.175	0.220	0.260	0.300	0.335	0.375	0.440
N3.1.1 Copper and copper alloys: Free-machining alloy, Pb > 1 %									
N3.1.2 Copper and copper alloys: CuZn, CuSnZn									
N3.1.3 Copper and copper alloys: CuSn, lead-free copper and copper electrolyte									
N4.1.1 Non-metallic materials: Duroplastics, fibre-reinforced plastics									
N4.1.2 Non-metallic materials: Hard rubber, wood, etc.									
N4.1.3 Non-metallic materials: Graphite									
S1.1.1 Heat-resistant alloys, Fe-based, annealed, 200 HB									
S1.1.2 Heat-resistant alloys, Fe-based, hardened, 280 HB									
S1.1.3 Heat-resistant alloys, Ni- or Co-based, annealed, 250 HB									
S1.1.4 Heat-resistant alloys, Ni- or Co-based, hardened, 350 HB									
S1.1.5 Heat-resistant alloys, Ni- or Co-based, cast, 320 HB									
S2.1.1 Titanium alloys, pure titanium, Rm 400 N/mm ²									
S2.1.2 Titanium alloys, Alpha and Beta alloys, hardened, Rm 1050 N/mm ²									
H1.1.1 Hardened steel, hardened and tempered, < 55 HRC									
H1.1.2 Hardened steel, hardened and tempered, < 60 HRC									
H1.1.3 Hardened steel, hardened and tempered, > 60 HRC									
H2.1.1 Chilled cast iron, 400 HB	40	0.040	0.065	0.080	0.095	0.110	0.125	0.135	0.165
H2.1.2 Chilled cast iron, hardened and tempered, < 55 HRC	30	0.025	0.045	0.055	0.065	0.075	0.085	0.095	0.115



Ratio drills with coolant ducts, RT 150 GN, 15xD





Machining group		f (mm/rev) with nom. Ø							
			3	6	8	10	12	14	16
	v _c (m/min)								
P1.1.1 Unalloyed steel, annealed, 0.15 % C, Rm 420 N/mm ² , 125 HB									
P1.1.2 Unalloyed steel, heat-treated, 0.15 % C, Rm 420 N/mm ² , 125 HB									
P1.1.3 Unalloyed steel, annealed, 0.45 % C, Rm 640 N/mm ² , 190 HB									
P1.1.4 Unalloyed steel, heat-treated, 0.45 % C, Rm 640 N/mm ² , 190 HB									
P1.1.5 Unalloyed steel, heat-treated, 0.45 % C, Rm 850 N/mm ² , 250 HB									
P1.1.6 Unalloyed steel, annealed, 0.75 % C, Rm 915 N/mm ² , 270 HB									
P1.1.7 Unalloyed steel, heat-treated, 0.75 % C, Rm 1020 N/mm ² , 300 HB									
P2.1.1 Low-alloy steel, annealed, Rm 610 N/mm ² , 180 HB									
P2.1.2 Low-alloy steel, heat-treated, Rm 930 N/mm ² , 275 HB									
P2.1.3 Low-alloy steel, heat-treated, Rm 1020 N/mm ² , 300 HB									
P2.1.4 Low-alloy steel, heat-treated, Rm 1190 N/mm ² , 350 HB									
P3.1.1 High-alloy steel and tool steel, annealed, Rm 680 N/mm ² , 200 HB									
P3.1.2 High-alloy steel and tool steel, hardened and tempered, Rm 1100 N/mm ² , 325 HB									
M1.1.1 Stainless steel, ferritic/martensitic, with machining additives									
M1.1.2 Stainless steel, ferritic/martensitic, annealed, Rm 680 N/mm ² , 200 HB									
M1.1.3 Stainless steel, ferritic/martensitic, heat-treated, Rm 810 N/mm ² , 240 HB									
M2.1.1 Stainless steel, austenitic, quenched, 180 HB									
M2.2.1 Duplex steel, high-strength stainless steels									
K1.1.1 Grey cast iron, pearlitic/ferritic, 180 HB	90	0.075	0.130	0.160	0.190	0.220	0.250	0.275	0.325
K1.1.2 Grey cast iron, pearlitic/martensitic, 260 HB	75	0.065	0.110	0.140	0.165	0.185	0.210	0.235	0.275
K1.2.1 Cast iron with spheroidal graphite, ferritic, 160 HB	75	0.065	0.110	0.140	0.165	0.185	0.210	0.235	0.275
K1.2.2 Cast iron with spheroidal graphite, pearlitic, 250 HB	70	0.060	0.105	0.130	0.155	0.175	0.200	0.220	0.260
K1.3.1 Malleable cast iron, ferritic, 130 HB	70	0.060	0.105	0.130	0.155	0.175	0.200	0.220	0.260
K1.3.2 Malleable cast iron, pearlitic, 230 HB	65	0.055	0.090	0.115	0.135	0.155	0.175	0.190	0.230
K2.1.1 Vermicular graphite cast iron (GJV)									
K2.2.1 Austenitic-ferritic spheroidal graphite cast iron (ADI)									
N1.1.1 Wrought aluminium alloys, non-hardened, 60 HB	210	0.125	0.210	0.260	0.305	0.355	0.395	0.440	0.520
N1.1.2 Wrought aluminium alloys, hardened, 100 HB	210	0.125	0.210	0.260	0.305	0.355	0.395	0.440	0.520
N2.1.1 Aluminium casting alloys, non-hardened, ≤ 12 % Si, 75 HB	190	0.125	0.210	0.260	0.305	0.355	0.395	0.440	0.520
N2.1.2 Aluminium casting alloys, hardened, ≤ 12 % Si, 90 HB	190	0.125	0.210	0.260	0.305	0.355	0.395	0.440	0.520
N2.1.3 Aluminium casting alloys, non-hardened, > 12 % Si, 130 HB	160	0.105	0.175	0.220	0.260	0.300	0.335	0.375	0.440
N3.1.1 Copper and copper alloys: Free-machining alloy, Pb > 1 %									
N3.1.2 Copper and copper alloys: CuZn, CuSnZn									
N3.1.3 Copper and copper alloys: CuSn, lead-free copper and copper electrolyte									
N4.1.1 Non-metallic materials: Duroplastics, fibre-reinforced plastics									
N4.1.2 Non-metallic materials: Hard rubber, wood, etc.									
N4.1.3 Non-metallic materials: Graphite									
S1.1.1 Heat-resistant alloys, Fe-based, annealed, 200 HB									
S1.1.2 Heat-resistant alloys, Fe-based, hardened, 280 HB									
S1.1.3 Heat-resistant alloys, Ni- or Co-based, annealed, 250 HB									
S1.1.4 Heat-resistant alloys, Ni- or Co-based, hardened, 350 HB									
S1.1.5 Heat-resistant alloys, Ni- or Co-based, cast, 320 HB									
S2.1.1 Titanium alloys, pure titanium, Rm 400 N/mm ²									
S2.1.2 Titanium alloys, Alpha and Beta alloys, hardened, Rm 1050 N/mm ²									
H1.1.1 Hardened steel, hardened and tempered, < 55 HRC									
H1.1.2 Hardened steel, hardened and tempered, < 60 HRC									
H1.1.3 Hardened steel, hardened and tempered, > 60 HRC									
H2.1.1 Chilled cast iron, 400 HB	40	0.030	0.050	0.065	0.075	0.090	0.100	0.110	0.130
H2.1.2 Chilled cast iron, hardened and tempered, < 55 HRC	30	0.020	0.035	0.045	0.055	0.060	0.070	0.075	0.090



Ratio drills with coolant ducts, RT 100 T AL, ≤ 25xD



Machining group	 	f (mm/rev) with nom. Ø							
		v _c (m/min)	3	4	5	6	8	10	12
	P1.1.1 Unalloyed steel, annealed, 0.15 % C, Rm 420 N/mm ² , 125 HB								
P1.1.2 Unalloyed steel, heat-treated, 0.15 % C, Rm 420 N/mm ² , 125 HB									
P1.1.3 Unalloyed steel, annealed, 0.45 % C, Rm 640 N/mm ² , 190 HB									
P1.1.4 Unalloyed steel, heat-treated, 0.45 % C, Rm 640 N/mm ² , 190 HB									
P1.1.5 Unalloyed steel, heat-treated, 0.45 % C, Rm 850 N/mm ² , 250 HB									
P1.1.6 Unalloyed steel, annealed, 0.75 % C, Rm 915 N/mm ² , 270 HB									
P1.1.7 Unalloyed steel, heat-treated, 0.75 % C, Rm 1020 N/mm ² , 300 HB									
P2.1.1 Low-alloy steel, annealed, Rm 610 N/mm ² , 180 HB									
P2.1.2 Low-alloy steel, heat-treated, Rm 930 N/mm ² , 275 HB									
P2.1.3 Low-alloy steel, heat-treated, Rm 1020 N/mm ² , 300 HB									
P2.1.4 Low-alloy steel, heat-treated, Rm 1190 N/mm ² , 350 HB									
P3.1.1 High-alloy steel and tool steel, annealed, Rm 680 N/mm ² , 200 HB									
P3.1.2 High-alloy steel and tool steel, hardened and tempered, Rm 1100 N/mm ² , 325 HB									
M1.1.1 Stainless steel, ferritic/martensitic, with machining additives									
M1.1.2 Stainless steel, ferritic/martensitic, annealed, Rm 680 N/mm ² , 200 HB									
M1.1.3 Stainless steel, ferritic/martensitic, heat-treated, Rm 810 N/mm ² , 240 HB									
M2.1.1 Stainless steel, austenitic, quenched, 180 HB									
M2.2.1 Duplex steel, high-strength stainless steels									
K1.1.1 Grey cast iron, pearlitic/ferritic, 180 HB									
K1.1.2 Grey cast iron, pearlitic/martensitic, 260 HB									
K1.2.1 Cast iron with spheroidal graphite, ferritic, 160 HB									
K1.2.2 Cast iron with spheroidal graphite, pearlitic, 250 HB									
K1.3.1 Malleable cast iron, ferritic, 130 HB									
K1.3.2 Malleable cast iron, pearlitic, 230 HB									
K2.1.1 Vermicular graphite cast iron (GJV)									
K2.2.1 Austenitic-ferritic spheroidal graphite cast iron (ADI)									
N1.1.1 Wrought aluminium alloys, non-hardened, 60 HB	120	0.155	0.190	0.225	0.260	0.325	0.385	0.440	0.495
N1.1.2 Wrought aluminium alloys, hardened, 100 HB	120	0.155	0.190	0.225	0.260	0.325	0.385	0.440	0.495
N2.1.1 Aluminium casting alloys, non-hardened, ≤ 12 % Si, 75 HB	110	0.190	0.240	0.285	0.325	0.405	0.480	0.550	0.620
N2.1.2 Aluminium casting alloys, hardened, ≤ 12 % Si, 90 HB	110	0.190	0.240	0.285	0.325	0.405	0.480	0.550	0.620
N2.1.3 Aluminium casting alloys, non-hardened, > 12 % Si, 130 HB	95	0.165	0.205	0.240	0.275	0.345	0.410	0.470	0.525
N3.1.1 Copper and copper alloys: Free-machining alloy, Pb > 1 %	140	0.125	0.155	0.180	0.210	0.260	0.305	0.355	0.395
N3.1.2 Copper and copper alloys: CuZn, CuSnZn	120	0.105	0.130	0.155	0.175	0.220	0.260	0.300	0.335
N3.1.3 Copper and copper alloys: CuSn, lead-free copper and copper electrolyte	110	0.100	0.120	0.145	0.165	0.205	0.245	0.280	0.315
N4.1.1 Non-metallic materials: Duroplastics, fibre-reinforced plastics	90	0.040	0.050	0.055	0.065	0.080	0.095	0.110	0.125
N4.1.2 Non-metallic materials: Hard rubber, wood, etc.									
N4.1.3 Non-metallic materials: Graphite									
S1.1.1 Heat-resistant alloys, Fe-based, annealed, 200 HB									
S1.1.2 Heat-resistant alloys, Fe-based, hardened, 280 HB									
S1.1.3 Heat-resistant alloys, Ni- or Co-based, annealed, 250 HB									
S1.1.4 Heat-resistant alloys, Ni- or Co-based, hardened, 350 HB									
S1.1.5 Heat-resistant alloys, Ni- or Co-based, cast, 320 HB									
S2.1.1 Titanium alloys, pure titanium, Rm 400 N/mm ²									
S2.1.2 Titanium alloys, Alpha and Beta alloys, hardened, Rm 1050 N/mm ²									
H1.1.1 Hardened steel, hardened and tempered, < 55 HRC									
H1.1.2 Hardened steel, hardened and tempered, < 60 HRC									
H1.1.3 Hardened steel, hardened and tempered, > 60 HRC									
H2.1.1 Chilled cast iron, 400 HB									
H2.1.2 Chilled cast iron, hardened and tempered, < 55 HRC									



Ratio drills with coolant ducts, RT 100 T, 15xD



Machining group		f (mm/rev) with nom. Ø							
		A							
	v _c (m/min)	3	4	6	8	10	12	14	16
P1.1.1 Unalloyed steel, annealed, 0.15 % C, Rm 420 N/mm ² , 125 HB	120	0.155	0.190	0.260	0.325	0.385	0.440	0.495	0.550
P1.1.2 Unalloyed steel, heat-treated, 0.15 % C, Rm 420 N/mm ² , 125 HB	110	0.140	0.170	0.235	0.290	0.345	0.395	0.445	0.495
P1.1.3 Unalloyed steel, annealed, 0.45 % C, Rm 640 N/mm ² , 190 HB	110	0.140	0.170	0.235	0.290	0.345	0.395	0.445	0.495
P1.1.4 Unalloyed steel, heat-treated, 0.45 % C, Rm 640 N/mm ² , 190 HB	100	0.130	0.165	0.220	0.275	0.325	0.375	0.420	0.465
P1.1.5 Unalloyed steel, heat-treated, 0.45 % C, Rm 850 N/mm ² , 250 HB	100	0.130	0.165	0.220	0.275	0.325	0.375	0.420	0.465
P1.1.6 Unalloyed steel, annealed, 0.75 % C, Rm 915 N/mm ² , 270 HB	95	0.125	0.155	0.210	0.260	0.305	0.355	0.395	0.440
P1.1.7 Unalloyed steel, heat-treated, 0.75 % C, Rm 1020 N/mm ² , 300 HB	90	0.115	0.145	0.195	0.245	0.290	0.330	0.370	0.410
P2.1.1 Low-alloy steel, annealed, Rm 610 N/mm ² , 180 HB	110	0.125	0.155	0.210	0.260	0.305	0.355	0.395	0.440
P2.1.2 Low-alloy steel, heat-treated, Rm 930 N/mm ² , 275 HB	110	0.125	0.155	0.210	0.260	0.305	0.355	0.395	0.440
P2.1.3 Low-alloy steel, heat-treated, Rm 1020 N/mm ² , 300 HB	95	0.105	0.130	0.175	0.220	0.260	0.300	0.335	0.375
P2.1.4 Low-alloy steel, heat-treated, Rm 1190 N/mm ² , 350 HB	85	0.090	0.115	0.155	0.195	0.230	0.265	0.295	0.330
P3.1.1 High-alloy steel and tool steel, annealed, Rm 680 N/mm ² , 200 HB	100	0.095	0.120	0.165	0.205	0.240	0.275	0.310	0.345
P3.1.2 High-alloy steel and tool steel, hardened and tempered, Rm 1100 N/mm ² , 325 HB	85	0.080	0.100	0.140	0.170	0.205	0.235	0.265	0.290
M1.1.1 Stainless steel, ferritic/martensitic, with machining additives	100	0.075	0.095	0.130	0.160	0.190	0.220	0.250	0.275
M1.1.2 Stainless steel, ferritic/martensitic, annealed, Rm 680 N/mm ² , 200 HB	90	0.070	0.085	0.115	0.145	0.175	0.200	0.225	0.245
M1.1.3 Stainless steel, ferritic/martensitic, heat-treated, Rm 810 N/mm ² , 240 HB	85	0.065	0.080	0.110	0.140	0.165	0.185	0.210	0.235
M2.1.1 Stainless steel, austenitic, quenched, 180 HB	70	0.050	0.060	0.080	0.100	0.120	0.140	0.155	0.175
M2.2.1 Duplex steel, high-strength stainless steels	60	0.040	0.050	0.070	0.085	0.105	0.120	0.135	0.145
K1.1.1 Grey cast iron, pearlitic/ferritic, 180 HB	120	0.155	0.190	0.260	0.325	0.385	0.440	0.495	0.550
K1.1.2 Grey cast iron, pearlitic/martensitic, 260 HB	100	0.130	0.165	0.220	0.275	0.325	0.375	0.420	0.465
K1.2.1 Cast iron with spheroidal graphite, ferritic, 160 HB	100	0.130	0.165	0.220	0.275	0.325	0.375	0.420	0.465
K1.2.2 Cast iron with spheroidal graphite, pearlitic, 250 HB	95	0.125	0.155	0.210	0.260	0.305	0.355	0.395	0.440
K1.3.1 Malleable cast iron, ferritic, 130 HB	95	0.125	0.155	0.210	0.260	0.305	0.355	0.395	0.440
K1.3.2 Malleable cast iron, pearlitic, 230 HB	85	0.110	0.135	0.180	0.225	0.270	0.310	0.345	0.385
K2.1.1 Vermicular graphite cast iron (GJV)	100	0.095	0.120	0.165	0.205	0.240	0.275	0.310	0.345
K2.2.1 Austenitic-ferritic spheroidal graphite cast iron (ADI)	75	0.070	0.090	0.120	0.150	0.180	0.205	0.230	0.255
N1.1.1 Wrought aluminium alloys, non-hardened, 60 HB									
N1.1.2 Wrought aluminium alloys, hardened, 100 HB									
N2.1.1 Aluminium casting alloys, non-hardened, ≤ 12 % Si, 75 HB									
N2.1.2 Aluminium casting alloys, hardened, ≤ 12 % Si, 90 HB									
N2.1.3 Aluminium casting alloys, non-hardened, > 12 % Si, 130 HB									
N3.1.1 Copper and copper alloys: Free-machining alloy, Pb > 1 %	120	0.125	0.155	0.210	0.260	0.305	0.355	0.395	0.440
N3.1.2 Copper and copper alloys: CuZn, CuSnZn	100	0.105	0.130	0.175	0.220	0.260	0.300	0.335	0.375
N3.1.3 Copper and copper alloys: CuSn, lead-free copper and copper electrolyte	95	0.100	0.120	0.165	0.205	0.245	0.280	0.315	0.350
N4.1.1 Non-metallic materials: Duroplastics, fibre-reinforced plastics									
N4.1.2 Non-metallic materials: Hard rubber, wood, etc.									
N4.1.3 Non-metallic materials: Graphite									
S1.1.1 Heat-resistant alloys, Fe-based, annealed, 200 HB	40	0.040	0.050	0.065	0.080	0.095	0.110	0.125	0.135
S1.1.2 Heat-resistant alloys, Fe-based, hardened, 280 HB	30	0.030	0.040	0.050	0.065	0.075	0.090	0.100	0.110
S1.1.3 Heat-resistant alloys, Ni- or Co-based, annealed, 250 HB	35	0.040	0.050	0.065	0.080	0.095	0.110	0.125	0.135
S1.1.4 Heat-resistant alloys, Ni- or Co-based, hardened, 350 HB	20	0.025	0.035	0.045	0.055	0.065	0.075	0.085	0.095
S1.1.5 Heat-resistant alloys, Ni- or Co-based, cast, 320 HB	25	0.025	0.035	0.045	0.055	0.065	0.075	0.085	0.095
S2.1.1 Titanium alloys, pure titanium, Rm 400 N/mm ²									
S2.1.2 Titanium alloys, Alpha and Beta alloys, hardened, Rm 1050 N/mm ²									
H1.1.1 Hardened steel, hardened and tempered, < 55 HRC	50	0.050	0.060	0.080	0.100	0.120	0.140	0.155	0.175
H1.1.2 Hardened steel, hardened and tempered, < 60 HRC									
H1.1.3 Hardened steel, hardened and tempered, > 60 HRC									
H2.1.1 Chilled cast iron, 400 HB									
H2.1.2 Chilled cast iron, hardened and tempered, < 55 HRC									



Ratio drills with coolant ducts, RT 100 T, 20xD



Machining group		f (mm/rev) with nom. Ø							
		v _c (m/min)	3	4	6	8	10	12	14
	A								
P1.1.1 Unalloyed steel, annealed, 0.15 % C, Rm 420 N/mm ² , 125 HB	120	0.155	0.190	0.260	0.325	0.385	0.440	0.495	0.550
P1.1.2 Unalloyed steel, heat-treated, 0.15 % C, Rm 420 N/mm ² , 125 HB	110	0.140	0.170	0.235	0.290	0.345	0.395	0.445	0.495
P1.1.3 Unalloyed steel, annealed, 0.45 % C, Rm 640 N/mm ² , 190 HB	110	0.140	0.170	0.235	0.290	0.345	0.395	0.445	0.495
P1.1.4 Unalloyed steel, heat-treated, 0.45 % C, Rm 640 N/mm ² , 190 HB	100	0.130	0.165	0.220	0.275	0.325	0.375	0.420	0.465
P1.1.5 Unalloyed steel, heat-treated, 0.45 % C, Rm 850 N/mm ² , 250 HB	100	0.130	0.165	0.220	0.275	0.325	0.375	0.420	0.465
P1.1.6 Unalloyed steel, annealed, 0.75 % C, Rm 915 N/mm ² , 270 HB	95	0.125	0.155	0.210	0.260	0.305	0.355	0.395	0.440
P1.1.7 Unalloyed steel, heat-treated, 0.75 % C, Rm 1020 N/mm ² , 300 HB	90	0.115	0.145	0.195	0.245	0.290	0.330	0.370	0.410
P2.1.1 Low-alloy steel, annealed, Rm 610 N/mm ² , 180 HB	110	0.125	0.155	0.210	0.260	0.305	0.355	0.395	0.440
P2.1.2 Low-alloy steel, heat-treated, Rm 930 N/mm ² , 275 HB	110	0.125	0.155	0.210	0.260	0.305	0.355	0.395	0.440
P2.1.3 Low-alloy steel, heat-treated, Rm 1020 N/mm ² , 300 HB	95	0.105	0.130	0.175	0.220	0.260	0.300	0.335	0.375
P2.1.4 Low-alloy steel, heat-treated, Rm 1190 N/mm ² , 350 HB	85	0.090	0.115	0.155	0.195	0.230	0.265	0.295	0.330
P3.1.1 High-alloy steel and tool steel, annealed, Rm 680 N/mm ² , 200 HB	100	0.095	0.120	0.165	0.205	0.240	0.275	0.310	0.345
P3.1.2 High-alloy steel and tool steel, hardened and tempered, Rm 1100 N/mm ² , 325 HB	85	0.080	0.100	0.140	0.170	0.205	0.235	0.265	0.290
M1.1.1 Stainless steel, ferritic/martensitic, with machining additives	100	0.075	0.095	0.130	0.160	0.190	0.220	0.250	0.275
M1.1.2 Stainless steel, ferritic/martensitic, annealed, Rm 680 N/mm ² , 200 HB	90	0.070	0.085	0.115	0.145	0.175	0.200	0.225	0.245
M1.1.3 Stainless steel, ferritic/martensitic, heat-treated, Rm 810 N/mm ² , 240 HB	85	0.065	0.080	0.110	0.140	0.165	0.185	0.210	0.235
M2.1.1 Stainless steel, austenitic, quenched, 180 HB	60	0.050	0.060	0.080	0.100	0.120	0.140	0.155	0.175
M2.2.1 Duplex steel, high-strength stainless steels	50	0.040	0.050	0.070	0.085	0.105	0.120	0.135	0.145
K1.1.1 Grey cast iron, pearlitic/ferritic, 180 HB	120	0.155	0.190	0.260	0.325	0.385	0.440	0.495	0.550
K1.1.2 Grey cast iron, pearlitic/martensitic, 260 HB	100	0.130	0.165	0.220	0.275	0.325	0.375	0.420	0.465
K1.2.1 Cast iron with spheroidal graphite, ferritic, 160 HB	100	0.130	0.165	0.220	0.275	0.325	0.375	0.420	0.465
K1.2.2 Cast iron with spheroidal graphite, pearlitic, 250 HB	95	0.125	0.155	0.210	0.260	0.305	0.355	0.395	0.440
K1.3.1 Malleable cast iron, ferritic, 130 HB	95	0.125	0.155	0.210	0.260	0.305	0.355	0.395	0.440
K1.3.2 Malleable cast iron, pearlitic, 230 HB	85	0.110	0.135	0.180	0.225	0.270	0.310	0.345	0.385
K2.1.1 Vermicular graphite cast iron (GJV)	100	0.095	0.120	0.165	0.205	0.240	0.275	0.310	0.345
K2.2.1 Austenitic-ferritic spheroidal graphite cast iron (ADI)	75	0.070	0.090	0.120	0.150	0.180	0.205	0.230	0.255
N1.1.1 Wrought aluminium alloys, non-hardened, 60 HB									
N1.1.2 Wrought aluminium alloys, hardened, 100 HB									
N2.1.1 Aluminium casting alloys, non-hardened, ≤ 12 % Si, 75 HB									
N2.1.2 Aluminium casting alloys, hardened, ≤ 12 % Si, 90 HB									
N2.1.3 Aluminium casting alloys, non-hardened, > 12 % Si, 130 HB									
N3.1.1 Copper and copper alloys: Free-machining alloy, Pb > 1 %	120	0.125	0.155	0.210	0.260	0.305	0.355	0.395	0.440
N3.1.2 Copper and copper alloys: CuZn, CuSnZn	100	0.105	0.130	0.175	0.220	0.260	0.300	0.335	0.375
N3.1.3 Copper and copper alloys: CuSn, lead-free copper and copper electrolyte	95	0.100	0.120	0.165	0.205	0.245	0.280	0.315	0.350
N4.1.1 Non-metallic materials: Duroplastics, fibre-reinforced plastics									
N4.1.2 Non-metallic materials: Hard rubber, wood, etc.									
N4.1.3 Non-metallic materials: Graphite									
S1.1.1 Heat-resistant alloys, Fe-based, annealed, 200 HB	40	0.040	0.050	0.065	0.080	0.095	0.110	0.125	0.135
S1.1.2 Heat-resistant alloys, Fe-based, hardened, 280 HB	30	0.030	0.040	0.050	0.065	0.075	0.090	0.100	0.110
S1.1.3 Heat-resistant alloys, Ni- or Co-based, annealed, 250 HB	35	0.040	0.050	0.065	0.080	0.095	0.110	0.125	0.135
S1.1.4 Heat-resistant alloys, Ni- or Co-based, hardened, 350 HB	20	0.025	0.035	0.045	0.055	0.065	0.075	0.085	0.095
S1.1.5 Heat-resistant alloys, Ni- or Co-based, cast, 320 HB	25	0.025	0.035	0.045	0.055	0.065	0.075	0.085	0.095
S2.1.1 Titanium alloys, pure titanium, Rm 400 N/mm ²									
S2.1.2 Titanium alloys, Alpha and Beta alloys, hardened, Rm 1050 N/mm ²									
H1.1.1 Hardened steel, hardened and tempered, < 55 HRC	50	0.050	0.060	0.080	0.100	0.120	0.140	0.155	0.175
H1.1.2 Hardened steel, hardened and tempered, < 60 HRC									
H1.1.3 Hardened steel, hardened and tempered, > 60 HRC									
H2.1.1 Chilled cast iron, 400 HB									
H2.1.2 Chilled cast iron, hardened and tempered, < 55 HRC									



Ratio drills with coolant ducts, RT 100 T, 25xD





Machining group	 	f (mm/rev) with nom. Ø								
		v _c (m/min)	3	4	6	8	10	12	14	16
P1.1.1 Unalloyed steel, annealed, 0.15 % C, Rm 420 N/mm ² , 125 HB	120	0.155	0.190	0.260	0.325	0.385	0.440	0.495	0.550	
P1.1.2 Unalloyed steel, heat-treated, 0.15 % C, Rm 420 N/mm ² , 125 HB	110	0.140	0.170	0.235	0.290	0.345	0.395	0.445	0.495	
P1.1.3 Unalloyed steel, annealed, 0.45 % C, Rm 640 N/mm ² , 190 HB	110	0.140	0.170	0.235	0.290	0.345	0.395	0.445	0.495	
P1.1.4 Unalloyed steel, heat-treated, 0.45 % C, Rm 640 N/mm ² , 190 HB	100	0.130	0.165	0.220	0.275	0.325	0.375	0.420	0.465	
P1.1.5 Unalloyed steel, heat-treated, 0.45 % C, Rm 850 N/mm ² , 250 HB	100	0.130	0.165	0.220	0.275	0.325	0.375	0.420	0.465	
P1.1.6 Unalloyed steel, annealed, 0.75 % C, Rm 915 N/mm ² , 270 HB	95	0.125	0.155	0.210	0.260	0.305	0.355	0.395	0.440	
P1.1.7 Unalloyed steel, heat-treated, 0.75 % C, Rm 1020 N/mm ² , 300 HB	90	0.115	0.145	0.195	0.245	0.290	0.330	0.370	0.410	
P2.1.1 Low-alloy steel, annealed, Rm 610 N/mm ² , 180 HB	100	0.125	0.155	0.210	0.260	0.305	0.355	0.395	0.440	
P2.1.2 Low-alloy steel, heat-treated, Rm 930 N/mm ² , 275 HB	100	0.125	0.155	0.210	0.260	0.305	0.355	0.395	0.440	
P2.1.3 Low-alloy steel, heat-treated, Rm 1020 N/mm ² , 300 HB	85	0.105	0.130	0.175	0.220	0.260	0.300	0.335	0.375	
P2.1.4 Low-alloy steel, heat-treated, Rm 1190 N/mm ² , 350 HB	75	0.090	0.115	0.155	0.195	0.230	0.265	0.295	0.330	
P3.1.1 High-alloy steel and tool steel, annealed, Rm 680 N/mm ² , 200 HB	90	0.095	0.120	0.165	0.205	0.240	0.275	0.310	0.345	
P3.1.2 High-alloy steel and tool steel, hardened and tempered, Rm 1100 N/mm ² , 325 HB	75	0.080	0.100	0.140	0.170	0.205	0.235	0.265	0.290	
M1.1.1 Stainless steel, ferritic/martensitic, with machining additives	100	0.075	0.095	0.130	0.160	0.190	0.220	0.250	0.275	
M1.1.2 Stainless steel, ferritic/martensitic, annealed, Rm 680 N/mm ² , 200 HB	90	0.070	0.085	0.115	0.145	0.175	0.200	0.225	0.245	
M1.1.3 Stainless steel, ferritic/martensitic, heat-treated, Rm 810 N/mm ² , 240 HB	85	0.065	0.080	0.110	0.140	0.165	0.185	0.210	0.235	
M2.1.1 Stainless steel, austenitic, quenched, 180 HB	60	0.050	0.060	0.080	0.100	0.120	0.140	0.155	0.175	
M2.2.1 Duplex steel, high-strength stainless steels	50	0.040	0.050	0.070	0.085	0.105	0.120	0.135	0.145	
K1.1.1 Grey cast iron, pearlitic/ferritic, 180 HB	110	0.155	0.190	0.260	0.325	0.385	0.440	0.495	0.550	
K1.1.2 Grey cast iron, pearlitic/martensitic, 260 HB	95	0.130	0.165	0.220	0.275	0.325	0.375	0.420	0.465	
K1.2.1 Cast iron with spheroidal graphite, ferritic, 160 HB	95	0.130	0.165	0.220	0.275	0.325	0.375	0.420	0.465	
K1.2.2 Cast iron with spheroidal graphite, pearlitic, 250 HB	90	0.125	0.155	0.210	0.260	0.305	0.355	0.395	0.440	
K1.3.1 Malleable cast iron, ferritic, 130 HB	90	0.125	0.155	0.210	0.260	0.305	0.355	0.395	0.440	
K1.3.2 Malleable cast iron, pearlitic, 230 HB	75	0.110	0.135	0.180	0.225	0.270	0.310	0.345	0.385	
K2.1.1 Vermicular graphite cast iron (GJV)	90	0.095	0.120	0.165	0.205	0.240	0.275	0.310	0.345	
K2.2.1 Austenitic-ferritic spheroidal graphite cast iron (ADI)	70	0.070	0.090	0.120	0.150	0.180	0.205	0.230	0.255	
N1.1.1 Wrought aluminium alloys, non-hardened, 60 HB										
N1.1.2 Wrought aluminium alloys, hardened, 100 HB										
N2.1.1 Aluminium casting alloys, non-hardened, ≤ 12 % Si, 75 HB										
N2.1.2 Aluminium casting alloys, hardened, ≤ 12 % Si, 90 HB										
N2.1.3 Aluminium casting alloys, non-hardened, > 12 % Si, 130 HB										
N3.1.1 Copper and copper alloys: Free-machining alloy, Pb > 1 %	120	0.125	0.155	0.210	0.260	0.305	0.355	0.395	0.440	
N3.1.2 Copper and copper alloys: CuZn, CuSnZn	100	0.105	0.130	0.175	0.220	0.260	0.300	0.335	0.375	
N3.1.3 Copper and copper alloys: CuSn, lead-free copper and copper electrolyte	95	0.100	0.120	0.165	0.205	0.245	0.280	0.315	0.350	
N4.1.1 Non-metallic materials: Duroplastics, fibre-reinforced plastics										
N4.1.2 Non-metallic materials: Hard rubber, wood, etc.										
N4.1.3 Non-metallic materials: Graphite										
S1.1.1 Heat-resistant alloys, Fe-based, annealed, 200 HB	40	0.040	0.050	0.065	0.080	0.095	0.110	0.125	0.135	
S1.1.2 Heat-resistant alloys, Fe-based, hardened, 280 HB	30	0.030	0.040	0.050	0.065	0.075	0.090	0.100	0.110	
S1.1.3 Heat-resistant alloys, Ni- or Co-based, annealed, 250 HB	35	0.040	0.050	0.065	0.080	0.095	0.110	0.125	0.135	
S1.1.4 Heat-resistant alloys, Ni- or Co-based, hardened, 350 HB	20	0.025	0.035	0.045	0.055	0.065	0.075	0.085	0.095	
S1.1.5 Heat-resistant alloys, Ni- or Co-based, cast, 320 HB	25	0.025	0.035	0.045	0.055	0.065	0.075	0.085	0.095	
S2.1.1 Titanium alloys, pure titanium, Rm 400 N/mm ²										
S2.1.2 Titanium alloys, Alpha and Beta alloys, hardened, Rm 1050 N/mm ²										
H1.1.1 Hardened steel, hardened and tempered, < 55 HRC	50	0.050	0.060	0.080	0.100	0.120	0.140	0.155	0.175	
H1.1.2 Hardened steel, hardened and tempered, < 60 HRC										
H1.1.3 Hardened steel, hardened and tempered, > 60 HRC										
H2.1.1 Chilled cast iron, 400 HB										
H2.1.2 Chilled cast iron, hardened and tempered, < 55 HRC										



Ratio drills with coolant ducts, RT 100 T, 30xD



Machining group	 	f (mm/rev) with nom. Ø							
		v _c (m/min)	3	4	5	6	8	10	12
	P1.1.1 Unalloyed steel, annealed, 0.15 % C, Rm 420 N/mm ² , 125 HB	100	0.155	0.190	0.225	0.260	0.325	0.385	0.440
P1.1.2 Unalloyed steel, heat-treated, 0.15 % C, Rm 420 N/mm ² , 125 HB	90	0.140	0.170	0.205	0.235	0.290	0.345	0.395	0.445
P1.1.3 Unalloyed steel, annealed, 0.45 % C, Rm 640 N/mm ² , 190 HB	90	0.140	0.170	0.205	0.235	0.290	0.345	0.395	0.445
P1.1.4 Unalloyed steel, heat-treated, 0.45 % C, Rm 640 N/mm ² , 190 HB	85	0.130	0.165	0.195	0.220	0.275	0.325	0.375	0.420
P1.1.5 Unalloyed steel, heat-treated, 0.45 % C, Rm 850 N/mm ² , 250 HB	85	0.130	0.165	0.195	0.220	0.275	0.325	0.375	0.420
P1.1.6 Unalloyed steel, annealed, 0.75 % C, Rm 915 N/mm ² , 270 HB	80	0.125	0.155	0.180	0.210	0.260	0.305	0.355	0.395
P1.1.7 Unalloyed steel, heat-treated, 0.75 % C, Rm 1020 N/mm ² , 300 HB	75	0.115	0.145	0.170	0.195	0.245	0.290	0.330	0.370
P2.1.1 Low-alloy steel, annealed, Rm 610 N/mm ² , 180 HB	90	0.125	0.155	0.180	0.210	0.260	0.305	0.355	0.395
P2.1.2 Low-alloy steel, heat-treated, Rm 930 N/mm ² , 275 HB	90	0.125	0.155	0.180	0.210	0.260	0.305	0.355	0.395
P2.1.3 Low-alloy steel, heat-treated, Rm 1020 N/mm ² , 300 HB	75	0.105	0.130	0.155	0.175	0.220	0.260	0.300	0.335
P2.1.4 Low-alloy steel, heat-treated, Rm 1190 N/mm ² , 350 HB	70	0.090	0.115	0.135	0.155	0.195	0.230	0.265	0.295
P3.1.1 High-alloy steel and tool steel, annealed, Rm 680 N/mm ² , 200 HB	80	0.095	0.120	0.140	0.165	0.205	0.240	0.275	0.310
P3.1.2 High-alloy steel and tool steel, hardened and tempered, Rm 1100 N/mm ² , 325 HB	70	0.080	0.100	0.120	0.140	0.170	0.205	0.235	0.265
M1.1.1 Stainless steel, ferritic/martensitic, with machining additives	80	0.075	0.095	0.115	0.130	0.160	0.190	0.220	0.250
M1.1.2 Stainless steel, ferritic/martensitic, annealed, Rm 680 N/mm ² , 200 HB	70	0.070	0.085	0.100	0.115	0.145	0.175	0.200	0.225
M1.1.3 Stainless steel, ferritic/martensitic, heat-treated, Rm 810 N/mm ² , 240 HB	70	0.065	0.080	0.095	0.110	0.140	0.165	0.185	0.210
M2.1.1 Stainless steel, austenitic, quenched, 180 HB	60	0.050	0.060	0.070	0.080	0.100	0.120	0.140	0.155
M2.2.1 Duplex steel, high-strength stainless steels	50	0.040	0.050	0.060	0.070	0.085	0.105	0.120	0.135
K1.1.1 Grey cast iron, pearlitic/ferritic, 180 HB	105	0.155	0.190	0.225	0.260	0.325	0.385	0.440	0.495
K1.1.2 Grey cast iron, pearlitic/martensitic, 260 HB	90	0.130	0.165	0.195	0.220	0.275	0.325	0.375	0.420
K1.2.1 Cast iron with spheroidal graphite, ferritic, 160 HB	90	0.130	0.165	0.195	0.220	0.275	0.325	0.375	0.420
K1.2.2 Cast iron with spheroidal graphite, pearlitic, 250 HB	85	0.125	0.155	0.180	0.210	0.260	0.305	0.355	0.395
K1.3.1 Malleable cast iron, ferritic, 130 HB	85	0.125	0.155	0.180	0.210	0.260	0.305	0.355	0.395
K1.3.2 Malleable cast iron, pearlitic, 230 HB	75	0.110	0.135	0.160	0.180	0.225	0.270	0.310	0.345
K2.1.1 Vermicular graphite cast iron (GJV)	80	0.095	0.120	0.140	0.165	0.205	0.240	0.275	0.310
K2.2.1 Austenitic-ferritic spheroidal graphite cast iron (ADI)	60	0.070	0.090	0.105	0.120	0.150	0.180	0.205	0.230
N1.1.1 Wrought aluminium alloys, non-hardened, 60 HB									
N1.1.2 Wrought aluminium alloys, hardened, 100 HB									
N2.1.1 Aluminium casting alloys, non-hardened, ≤ 12 % Si, 75 HB									
N2.1.2 Aluminium casting alloys, hardened, ≤ 12 % Si, 90 HB									
N2.1.3 Aluminium casting alloys, non-hardened, > 12 % Si, 130 HB									
N3.1.1 Copper and copper alloys: Free-machining alloy, Pb > 1 %	120	0.125	0.155	0.180	0.210	0.260	0.305	0.355	0.395
N3.1.2 Copper and copper alloys: CuZn, CuSnZn	100	0.105	0.130	0.155	0.175	0.220	0.260	0.300	0.335
N3.1.3 Copper and copper alloys: CuSn, lead-free copper and copper electrolyte	95	0.100	0.120	0.145	0.165	0.205	0.245	0.280	0.315
N4.1.1 Non-metallic materials: Duroplastics, fibre-reinforced plastics									
N4.1.2 Non-metallic materials: Hard rubber, wood, etc.									
N4.1.3 Non-metallic materials: Graphite									
S1.1.1 Heat-resistant alloys, Fe-based, annealed, 200 HB	40	0.040	0.050	0.055	0.065	0.080	0.095	0.110	0.125
S1.1.2 Heat-resistant alloys, Fe-based, hardened, 280 HB	30	0.030	0.040	0.045	0.050	0.065	0.075	0.090	0.100
S1.1.3 Heat-resistant alloys, Ni- or Co-based, annealed, 250 HB	35	0.040	0.050	0.055	0.065	0.080	0.095	0.110	0.125
S1.1.4 Heat-resistant alloys, Ni- or Co-based, hardened, 350 HB	20	0.025	0.035	0.040	0.045	0.055	0.065	0.075	0.085
S1.1.5 Heat-resistant alloys, Ni- or Co-based, cast, 320 HB	25	0.025	0.035	0.040	0.045	0.055	0.065	0.075	0.085
S2.1.1 Titanium alloys, pure titanium, Rm 400 N/mm ²									
S2.1.2 Titanium alloys, Alpha and Beta alloys, hardened, Rm 1050 N/mm ²									
H1.1.1 Hardened steel, hardened and tempered, < 55 HRC	50	0.050	0.060	0.070	0.080	0.100	0.120	0.140	0.155
H1.1.2 Hardened steel, hardened and tempered, < 60 HRC									
H1.1.3 Hardened steel, hardened and tempered, > 60 HRC									
H2.1.1 Chilled cast iron, 400 HB									
H2.1.2 Chilled cast iron, hardened and tempered, < 55 HRC									



Ratio drills with coolant ducts, RT 100 T, 40xD



Machining group	 v_c (m/min)	f (mm/rev) with nom. \emptyset							
		3	4	5	6	7	8	9	10
		P1.1.1 Unalloyed steel, annealed, 0.15 % C, Rm 420 N/mm ² , 125 HB	100	0.155	0.190	0.225	0.260	0.295	0.325
P1.1.2 Unalloyed steel, heat-treated, 0.15 % C, Rm 420 N/mm ² , 125 HB	90	0.140	0.170	0.205	0.235	0.265	0.290	0.320	0.345
P1.1.3 Unalloyed steel, annealed, 0.45 % C, Rm 640 N/mm ² , 190 HB	90	0.140	0.170	0.205	0.235	0.265	0.290	0.320	0.345
P1.1.4 Unalloyed steel, heat-treated, 0.45 % C, Rm 640 N/mm ² , 190 HB	85	0.130	0.165	0.195	0.220	0.250	0.275	0.300	0.325
P1.1.5 Unalloyed steel, heat-treated, 0.45 % C, Rm 850 N/mm ² , 250 HB	85	0.130	0.165	0.195	0.220	0.250	0.275	0.300	0.325
P1.1.6 Unalloyed steel, annealed, 0.75 % C, Rm 915 N/mm ² , 270 HB	80	0.125	0.155	0.180	0.210	0.235	0.260	0.285	0.305
P1.1.7 Unalloyed steel, heat-treated, 0.75 % C, Rm 1020 N/mm ² , 300 HB	75	0.115	0.145	0.170	0.195	0.220	0.245	0.265	0.290
P2.1.1 Low-alloy steel, annealed, Rm 610 N/mm ² , 180 HB	90	0.125	0.155	0.180	0.210	0.235	0.260	0.285	0.305
P2.1.2 Low-alloy steel, heat-treated, Rm 930 N/mm ² , 275 HB	90	0.125	0.155	0.180	0.210	0.235	0.260	0.285	0.305
P2.1.3 Low-alloy steel, heat-treated, Rm 1020 N/mm ² , 300 HB	75	0.105	0.130	0.155	0.175	0.200	0.220	0.240	0.260
P2.1.4 Low-alloy steel, heat-treated, Rm 1190 N/mm ² , 350 HB	70	0.090	0.115	0.135	0.155	0.175	0.195	0.215	0.230
P3.1.1 High-alloy steel and tool steel, annealed, Rm 680 N/mm ² , 200 HB	80	0.095	0.120	0.140	0.165	0.185	0.205	0.220	0.240
P3.1.2 High-alloy steel and tool steel, hardened and tempered, Rm 1100 N/mm ² , 325 HB	70	0.080	0.100	0.120	0.140	0.155	0.170	0.190	0.205
M1.1.1 Stainless steel, ferritic/martensitic, with machining additives	80	0.075	0.095	0.115	0.130	0.145	0.160	0.175	0.190
M1.1.2 Stainless steel, ferritic/martensitic, annealed, Rm 680 N/mm ² , 200 HB	70	0.070	0.085	0.100	0.115	0.130	0.145	0.160	0.175
M1.1.3 Stainless steel, ferritic/martensitic, heat-treated, Rm 810 N/mm ² , 240 HB	70	0.065	0.080	0.095	0.110	0.125	0.140	0.150	0.165
M2.1.1 Stainless steel, austenitic, quenched, 180 HB	60	0.040	0.050	0.055	0.065	0.075	0.080	0.090	0.095
M2.2.1 Duplex steel, high-strength stainless steels	50	0.035	0.040	0.050	0.055	0.060	0.070	0.075	0.080
K1.1.1 Grey cast iron, pearlitic/ferritic, 180 HB	105	0.155	0.190	0.225	0.260	0.295	0.325	0.355	0.385
K1.1.2 Grey cast iron, pearlitic/martensitic, 260 HB	90	0.130	0.165	0.195	0.220	0.250	0.275	0.300	0.325
K1.2.1 Cast iron with spheroidal graphite, ferritic, 160 HB	90	0.130	0.165	0.195	0.220	0.250	0.275	0.300	0.325
K1.2.2 Cast iron with spheroidal graphite, pearlitic, 250 HB	85	0.125	0.155	0.180	0.210	0.235	0.260	0.285	0.305
K1.3.1 Malleable cast iron, ferritic, 130 HB	85	0.125	0.155	0.180	0.210	0.235	0.260	0.285	0.305
K1.3.2 Malleable cast iron, pearlitic, 230 HB	75	0.110	0.135	0.160	0.180	0.205	0.225	0.250	0.270
K2.1.1 Vermicular graphite cast iron (GJV)	80	0.095	0.120	0.140	0.165	0.185	0.205	0.220	0.240
K2.2.1 Austenitic-ferritic spheroidal graphite cast iron (ADI)	60	0.070	0.090	0.105	0.120	0.135	0.150	0.165	0.180
N1.1.1 Wrought aluminium alloys, non-hardened, 60 HB									
N1.1.2 Wrought aluminium alloys, hardened, 100 HB									
N2.1.1 Aluminium casting alloys, non-hardened, ≤ 12 % Si, 75 HB									
N2.1.2 Aluminium casting alloys, hardened, ≤ 12 % Si, 90 HB									
N2.1.3 Aluminium casting alloys, non-hardened, > 12 % Si, 130 HB									
N3.1.1 Copper and copper alloys: Free-machining alloy, Pb > 1 %	120	0.125	0.155	0.180	0.210	0.235	0.260	0.285	0.305
N3.1.2 Copper and copper alloys: CuZn, CuSnZn	100	0.105	0.130	0.155	0.175	0.200	0.220	0.240	0.260
N3.1.3 Copper and copper alloys: CuSn, lead-free copper and copper electrolyte	95	0.100	0.120	0.145	0.165	0.185	0.205	0.225	0.245
N4.1.1 Non-metallic materials: Duroplastics, fibre-reinforced plastics									
N4.1.2 Non-metallic materials: Hard rubber, wood, etc.									
N4.1.3 Non-metallic materials: Graphite									
S1.1.1 Heat-resistant alloys, Fe-based, annealed, 200 HB	40	0.040	0.050	0.055	0.065	0.075	0.080	0.090	0.095
S1.1.2 Heat-resistant alloys, Fe-based, hardened, 280 HB	30	0.030	0.040	0.045	0.050	0.060	0.065	0.070	0.075
S1.1.3 Heat-resistant alloys, Ni- or Co-based, annealed, 250 HB	35	0.040	0.050	0.055	0.065	0.075	0.080	0.090	0.095
S1.1.4 Heat-resistant alloys, Ni- or Co-based, hardened, 350 HB	20	0.025	0.035	0.040	0.045	0.050	0.055	0.060	0.065
S1.1.5 Heat-resistant alloys, Ni- or Co-based, cast, 320 HB	25	0.025	0.035	0.040	0.045	0.050	0.055	0.060	0.065
S2.1.1 Titanium alloys, pure titanium, Rm 400 N/mm ²									
S2.1.2 Titanium alloys, Alpha and Beta alloys, hardened, Rm 1050 N/mm ²									
H1.1.1 Hardened steel, hardened and tempered, < 55 HRC	50	0.050	0.060	0.070	0.080	0.090	0.100	0.110	0.120
H1.1.2 Hardened steel, hardened and tempered, < 60 HRC									
H1.1.3 Hardened steel, hardened and tempered, > 60 HRC									
H2.1.1 Chilled cast iron, 400 HB									
H2.1.2 Chilled cast iron, hardened and tempered, < 55 HRC									



Ratio drills without coolant ducts, 3-fluted, bright





Machining group		f (mm/rev) with nom. Ø							
			3	6	8	10	12	14	16
	v _c (m/min)								
P1.1.1 Unalloyed steel, annealed, 0.15 % C, Rm 420 N/mm ² , 125 HB									
P1.1.2 Unalloyed steel, heat-treated, 0.15 % C, Rm 420 N/mm ² , 125 HB									
P1.1.3 Unalloyed steel, annealed, 0.45 % C, Rm 640 N/mm ² , 190 HB									
P1.1.4 Unalloyed steel, heat-treated, 0.45 % C, Rm 640 N/mm ² , 190 HB									
P1.1.5 Unalloyed steel, heat-treated, 0.45 % C, Rm 850 N/mm ² , 250 HB									
P1.1.6 Unalloyed steel, annealed, 0.75 % C, Rm 915 N/mm ² , 270 HB									
P1.1.7 Unalloyed steel, heat-treated, 0.75 % C, Rm 1020 N/mm ² , 300 HB									
P2.1.1 Low-alloy steel, annealed, Rm 610 N/mm ² , 180 HB									
P2.1.2 Low-alloy steel, heat-treated, Rm 930 N/mm ² , 275 HB									
P2.1.3 Low-alloy steel, heat-treated, Rm 1020 N/mm ² , 300 HB									
P2.1.4 Low-alloy steel, heat-treated, Rm 1190 N/mm ² , 350 HB									
P3.1.1 High-alloy steel and tool steel, annealed, Rm 680 N/mm ² , 200 HB									
P3.1.2 High-alloy steel and tool steel, hardened and tempered, Rm 1100 N/mm ² , 325 HB									
M1.1.1 Stainless steel, ferritic/martensitic, with machining additives									
M1.1.2 Stainless steel, ferritic/martensitic, annealed, Rm 680 N/mm ² , 200 HB									
M1.1.3 Stainless steel, ferritic/martensitic, heat-treated, Rm 810 N/mm ² , 240 HB									
M2.1.1 Stainless steel, austenitic, quenched, 180 HB									
M2.2.1 Duplex steel, high-strength stainless steels									
K1.1.1 Grey cast iron, pearlitic/ferritic, 180 HB	80	0.075	0.130	0.160	0.190	0.220	0.250	0.275	0.325
K1.1.2 Grey cast iron, pearlitic/martensitic, 260 HB	70	0.065	0.110	0.140	0.165	0.185	0.210	0.235	0.275
K1.2.1 Cast iron with spheroidal graphite, ferritic, 160 HB	70	0.065	0.110	0.140	0.165	0.185	0.210	0.235	0.275
K1.2.2 Cast iron with spheroidal graphite, pearlitic, 250 HB	65	0.060	0.105	0.130	0.155	0.175	0.200	0.220	0.260
K1.3.1 Malleable cast iron, ferritic, 130 HB	65	0.060	0.105	0.130	0.155	0.175	0.200	0.220	0.260
K1.3.2 Malleable cast iron, pearlitic, 230 HB	55	0.055	0.090	0.115	0.135	0.155	0.175	0.190	0.230
K2.1.1 Vermicular graphite cast iron (GJV)									
K2.2.1 Austenitic-ferritic spheroidal graphite cast iron (ADI)									
N1.1.1 Wrought aluminium alloys, non-hardened, 60 HB	160	0.155	0.260	0.325	0.385	0.440	0.495	0.550	0.650
N1.1.2 Wrought aluminium alloys, hardened, 100 HB	160	0.155	0.260	0.325	0.385	0.440	0.495	0.550	0.650
N2.1.1 Aluminium casting alloys, non-hardened, ≤ 12 % Si, 75 HB	140	0.155	0.260	0.325	0.385	0.440	0.495	0.550	0.650
N2.1.2 Aluminium casting alloys, hardened, ≤ 12 % Si, 90 HB	140	0.155	0.260	0.325	0.385	0.440	0.495	0.550	0.650
N2.1.3 Aluminium casting alloys, non-hardened, > 12 % Si, 130 HB	120	0.130	0.220	0.275	0.325	0.375	0.420	0.465	0.555
N3.1.1 Copper and copper alloys: Free-machining alloy, Pb > 1 %									
N3.1.2 Copper and copper alloys: CuZn, CuSnZn									
N3.1.3 Copper and copper alloys: CuSn, lead-free copper and copper electrolyte									
N4.1.1 Non-metallic materials: Duroplastics, fibre-reinforced plastics									
N4.1.2 Non-metallic materials: Hard rubber, wood, etc.									
N4.1.3 Non-metallic materials: Graphite									
S1.1.1 Heat-resistant alloys, Fe-based, annealed, 200 HB									
S1.1.2 Heat-resistant alloys, Fe-based, hardened, 280 HB									
S1.1.3 Heat-resistant alloys, Ni- or Co-based, annealed, 250 HB									
S1.1.4 Heat-resistant alloys, Ni- or Co-based, hardened, 350 HB									
S1.1.5 Heat-resistant alloys, Ni- or Co-based, cast, 320 HB									
S2.1.1 Titanium alloys, pure titanium, Rm 400 N/mm ²									
S2.1.2 Titanium alloys, Alpha and Beta alloys, hardened, Rm 1050 N/mm ²									
H1.1.1 Hardened steel, hardened and tempered, < 55 HRC									
H1.1.2 Hardened steel, hardened and tempered, < 60 HRC									
H1.1.3 Hardened steel, hardened and tempered, > 60 HRC									
H2.1.1 Chilled cast iron, 400 HB									
H2.1.2 Chilled cast iron, hardened and tempered, < 55 HRC									



Ratio drills without coolant ducts, 3-fluted, TiN



Machining group		f (mm/rev) with nom. Ø							
			3	6	8	10	12	14	16
	v _c (m/min)								
P1.1.1 Unalloyed steel, annealed, 0.15 % C, Rm 420 N/mm ² , 125 HB	100	0.095	0.165	0.205	0.240	0.275	0.310	0.345	0.405
P1.1.2 Unalloyed steel, heat-treated, 0.15 % C, Rm 420 N/mm ² , 125 HB	90	0.085	0.145	0.180	0.215	0.250	0.280	0.310	0.365
P1.1.3 Unalloyed steel, annealed, 0.45 % C, Rm 640 N/mm ² , 190 HB	90	0.085	0.145	0.180	0.215	0.250	0.280	0.310	0.365
P1.1.4 Unalloyed steel, heat-treated, 0.45 % C, Rm 640 N/mm ² , 190 HB	85	0.080	0.140	0.170	0.205	0.235	0.265	0.290	0.345
P1.1.5 Unalloyed steel, heat-treated, 0.45 % C, Rm 850 N/mm ² , 250 HB	85	0.080	0.140	0.170	0.205	0.235	0.265	0.290	0.345
P1.1.6 Unalloyed steel, annealed, 0.75 % C, Rm 915 N/mm ² , 270 HB	80	0.075	0.130	0.160	0.190	0.220	0.250	0.275	0.325
P1.1.7 Unalloyed steel, heat-treated, 0.75 % C, Rm 1020 N/mm ² , 300 HB	75	0.070	0.120	0.150	0.180	0.205	0.230	0.255	0.305
P2.1.1 Low-alloy steel, annealed, Rm 610 N/mm ² , 180 HB	80	0.075	0.130	0.160	0.190	0.220	0.250	0.275	0.325
P2.1.2 Low-alloy steel, heat-treated, Rm 930 N/mm ² , 275 HB	80	0.075	0.130	0.160	0.190	0.220	0.250	0.275	0.325
P2.1.3 Low-alloy steel, heat-treated, Rm 1020 N/mm ² , 300 HB	70	0.065	0.110	0.140	0.165	0.185	0.210	0.235	0.275
P2.1.4 Low-alloy steel, heat-treated, Rm 1190 N/mm ² , 350 HB	60	0.060	0.100	0.120	0.145	0.165	0.185	0.205	0.245
P3.1.1 High-alloy steel and tool steel, annealed, Rm 680 N/mm ² , 200 HB	50	0.060	0.105	0.130	0.155	0.175	0.200	0.220	0.260
P3.1.2 High-alloy steel and tool steel, hardened and tempered, Rm 1100 N/mm ² , 325 HB	45	0.050	0.090	0.110	0.130	0.150	0.170	0.185	0.220
M1.1.1 Stainless steel, ferritic/martensitic, with machining additives									
M1.1.2 Stainless steel, ferritic/martensitic, annealed, Rm 680 N/mm ² , 200 HB									
M1.1.3 Stainless steel, ferritic/martensitic, heat-treated, Rm 810 N/mm ² , 240 HB									
M2.1.1 Stainless steel, austenitic, quenched, 180 HB									
M2.2.1 Duplex steel, high-strength stainless steels									
K1.1.1 Grey cast iron, pearlitic/ferritic, 180 HB	100	0.125	0.210	0.260	0.305	0.355	0.395	0.440	0.520
K1.1.2 Grey cast iron, pearlitic/martensitic, 260 HB	85	0.105	0.175	0.220	0.260	0.300	0.335	0.375	0.440
K1.2.1 Cast iron with spheroidal graphite, ferritic, 160 HB	85	0.105	0.175	0.220	0.260	0.300	0.335	0.375	0.440
K1.2.2 Cast iron with spheroidal graphite, pearlitic, 250 HB	80	0.100	0.165	0.205	0.245	0.280	0.315	0.350	0.415
K1.3.1 Malleable cast iron, ferritic, 130 HB	80	0.100	0.165	0.205	0.245	0.280	0.315	0.350	0.415
K1.3.2 Malleable cast iron, pearlitic, 230 HB	70	0.085	0.145	0.180	0.215	0.245	0.280	0.305	0.365
K2.1.1 Vermicular graphite cast iron (GJV)									
K2.2.1 Austenitic-ferritic spheroidal graphite cast iron (ADI)									
N1.1.1 Wrought aluminium alloys, non-hardened, 60 HB	180	0.155	0.260	0.325	0.385	0.440	0.495	0.550	0.650
N1.1.2 Wrought aluminium alloys, hardened, 100 HB	180	0.155	0.260	0.325	0.385	0.440	0.495	0.550	0.650
N2.1.1 Aluminium casting alloys, non-hardened, ≤ 12 % Si, 75 HB	160	0.155	0.260	0.325	0.385	0.440	0.495	0.550	0.650
N2.1.2 Aluminium casting alloys, hardened, ≤ 12 % Si, 90 HB	160	0.155	0.260	0.325	0.385	0.440	0.495	0.550	0.650
N2.1.3 Aluminium casting alloys, non-hardened, > 12 % Si, 130 HB	135	0.130	0.220	0.275	0.325	0.375	0.420	0.465	0.555
N3.1.1 Copper and copper alloys: Free-machining alloy, Pb > 1 %									
N3.1.2 Copper and copper alloys: CuZn, CuSnZn									
N3.1.3 Copper and copper alloys: CuSn, lead-free copper and copper electrolyte									
N4.1.1 Non-metallic materials: Duroplastics, fibre-reinforced plastics									
N4.1.2 Non-metallic materials: Hard rubber, wood, etc.									
N4.1.3 Non-metallic materials: Graphite									
S1.1.1 Heat-resistant alloys, Fe-based, annealed, 200 HB									
S1.1.2 Heat-resistant alloys, Fe-based, hardened, 280 HB									
S1.1.3 Heat-resistant alloys, Ni- or Co-based, annealed, 250 HB									
S1.1.4 Heat-resistant alloys, Ni- or Co-based, hardened, 350 HB									
S1.1.5 Heat-resistant alloys, Ni- or Co-based, cast, 320 HB									
S2.1.1 Titanium alloys, pure titanium, Rm 400 N/mm ²									
S2.1.2 Titanium alloys, Alpha and Beta alloys, hardened, Rm 1050 N/mm ²									
H1.1.1 Hardened steel, hardened and tempered, < 55 HRC									
H1.1.2 Hardened steel, hardened and tempered, < 60 HRC									
H1.1.3 Hardened steel, hardened and tempered, > 60 HRC									
H2.1.1 Chilled cast iron, 400 HB									
H2.1.2 Chilled cast iron, hardened and tempered, < 55 HRC									



Ratio drills with coolant ducts, 3-fluted



Machining group		f (mm/rev) with nom. Ø							
		v_c (m/min)	3	6	8	10	12	14	16
	P1.1.1 Unalloyed steel, annealed, 0.15 % C, Rm 420 N/mm ² , 125 HB	180	0.245	0.410	0.510	0.605	0.695	0.785	0.865
P1.1.2 Unalloyed steel, heat-treated, 0.15 % C, Rm 420 N/mm ² , 125 HB	160	0.220	0.370	0.460	0.545	0.625	0.705	0.780	0.925
P1.1.3 Unalloyed steel, annealed, 0.45 % C, Rm 640 N/mm ² , 190 HB	160	0.220	0.370	0.460	0.545	0.625	0.705	0.780	0.925
P1.1.4 Unalloyed steel, heat-treated, 0.45 % C, Rm 640 N/mm ² , 190 HB	155	0.205	0.350	0.435	0.515	0.590	0.665	0.735	0.870
P1.1.5 Unalloyed steel, heat-treated, 0.45 % C, Rm 850 N/mm ² , 250 HB	155	0.205	0.350	0.435	0.515	0.590	0.665	0.735	0.870
P1.1.6 Unalloyed steel, annealed, 0.75 % C, Rm 915 N/mm ² , 270 HB	145	0.195	0.330	0.410	0.485	0.555	0.625	0.695	0.820
P1.1.7 Unalloyed steel, heat-treated, 0.75 % C, Rm 1020 N/mm ² , 300 HB	135	0.180	0.310	0.385	0.455	0.520	0.585	0.650	0.770
P2.1.1 Low-alloy steel, annealed, Rm 610 N/mm ² , 180 HB	130	0.190	0.325	0.405	0.480	0.550	0.620	0.685	0.815
P2.1.2 Low-alloy steel, heat-treated, Rm 930 N/mm ² , 275 HB	130	0.190	0.325	0.405	0.480	0.550	0.620	0.685	0.815
P2.1.3 Low-alloy steel, heat-treated, Rm 1020 N/mm ² , 300 HB	110	0.165	0.275	0.345	0.410	0.470	0.525	0.585	0.690
P2.1.4 Low-alloy steel, heat-treated, Rm 1190 N/mm ² , 350 HB	100	0.145	0.245	0.305	0.360	0.415	0.465	0.515	0.610
P3.1.1 High-alloy steel and tool steel, annealed, Rm 680 N/mm ² , 200 HB	90	0.155	0.260	0.325	0.385	0.440	0.495	0.550	0.650
P3.1.2 High-alloy steel and tool steel, hardened and tempered, Rm 1100 N/mm ² , 325 HB	75	0.130	0.220	0.275	0.325	0.375	0.420	0.465	0.555
M1.1.1 Stainless steel, ferritic/martensitic, with machining additives	60	0.075	0.130	0.160	0.190	0.220	0.250	0.275	0.325
M1.1.2 Stainless steel, ferritic/martensitic, annealed, Rm 680 N/mm ² , 200 HB	55	0.070	0.115	0.145	0.175	0.200	0.225	0.245	0.295
M1.1.3 Stainless steel, ferritic/martensitic, heat-treated, Rm 810 N/mm ² , 240 HB	50	0.065	0.110	0.140	0.165	0.185	0.210	0.235	0.275
M2.1.1 Stainless steel, austenitic, quenched, 180 HB									
M2.2.1 Duplex steel, high-strength stainless steels									
K1.1.1 Grey cast iron, pearlitic/ferritic, 180 HB	130	0.190	0.325	0.405	0.480	0.550	0.620	0.685	0.815
K1.1.2 Grey cast iron, pearlitic/martensitic, 260 HB	110	0.165	0.275	0.345	0.410	0.470	0.525	0.585	0.690
K1.2.1 Cast iron with spheroidal graphite, ferritic, 160 HB	110	0.165	0.275	0.345	0.410	0.470	0.525	0.585	0.690
K1.2.2 Cast iron with spheroidal graphite, pearlitic, 250 HB	105	0.155	0.260	0.325	0.385	0.440	0.495	0.550	0.650
K1.3.1 Malleable cast iron, ferritic, 130 HB	105	0.155	0.260	0.325	0.385	0.440	0.495	0.550	0.650
K1.3.2 Malleable cast iron, pearlitic, 230 HB	90	0.135	0.230	0.285	0.335	0.385	0.435	0.480	0.570
K2.1.1 Vermicular graphite cast iron (GJV)	100	0.190	0.325	0.405	0.480	0.550	0.620	0.685	0.815
K2.2.1 Austenitic-ferritic spheroidal graphite cast iron (ADI)	75	0.145	0.245	0.305	0.360	0.415	0.465	0.515	0.610
N1.1.1 Wrought aluminium alloys, non-hardened, 60 HB	200	0.190	0.325	0.405	0.480	0.550	0.620	0.685	0.815
N1.1.2 Wrought aluminium alloys, hardened, 100 HB	200	0.190	0.325	0.405	0.480	0.550	0.620	0.685	0.815
N2.1.1 Aluminium casting alloys, non-hardened, ≤ 12 % Si, 75 HB	180	0.190	0.325	0.405	0.480	0.550	0.620	0.685	0.815
N2.1.2 Aluminium casting alloys, hardened, ≤ 12 % Si, 90 HB	180	0.190	0.325	0.405	0.480	0.550	0.620	0.685	0.815
N2.1.3 Aluminium casting alloys, non-hardened, > 12 % Si, 130 HB	155	0.165	0.275	0.345	0.410	0.470	0.525	0.585	0.690
N3.1.1 Copper and copper alloys: Free-machining alloy, Pb > 1 %									
N3.1.2 Copper and copper alloys: CuZn, CuSnZn									
N3.1.3 Copper and copper alloys: CuSn, lead-free copper and copper electrolyte									
N4.1.1 Non-metallic materials: Duroplastics, fibre-reinforced plastics									
N4.1.2 Non-metallic materials: Hard rubber, wood, etc.									
N4.1.3 Non-metallic materials: Graphite									
S1.1.1 Heat-resistant alloys, Fe-based, annealed, 200 HB	40	0.060	0.105	0.130	0.155	0.175	0.200	0.220	0.260
S1.1.2 Heat-resistant alloys, Fe-based, hardened, 280 HB	30	0.050	0.085	0.105	0.120	0.140	0.160	0.175	0.205
S1.1.3 Heat-resistant alloys, Ni- or Co-based, annealed, 250 HB	35	0.060	0.105	0.130	0.155	0.175	0.200	0.220	0.260
S1.1.4 Heat-resistant alloys, Ni- or Co-based, hardened, 350 HB	20	0.045	0.075	0.090	0.105	0.125	0.140	0.155	0.180
S1.1.5 Heat-resistant alloys, Ni- or Co-based, cast, 320 HB	25	0.045	0.075	0.090	0.105	0.125	0.140	0.155	0.180
S2.1.1 Titanium alloys, pure titanium, Rm 400 N/mm ²	40	0.060	0.105	0.130	0.155	0.175	0.200	0.220	0.260
S2.1.2 Titanium alloys, Alpha and Beta alloys, hardened, Rm 1050 N/mm ²	30	0.050	0.085	0.105	0.120	0.140	0.160	0.175	0.205
H1.1.1 Hardened steel, hardened and tempered, < 55 HRC	40	0.060	0.105	0.130	0.155	0.175	0.200	0.220	0.260
H1.1.2 Hardened steel, hardened and tempered, < 60 HRC									
H1.1.3 Hardened steel, hardened and tempered, > 60 HRC									
H2.1.1 Chilled cast iron, 400 HB									
H2.1.2 Chilled cast iron, hardened and tempered, < 55 HRC									



Twist drills with reinforced straight shank



Machining group		f (mm/rev) with nom. Ø								
			3	6	8	10	12	14	16	20
	v _c (m/min)									
P1.1.1 Unalloyed steel, annealed, 0.15 % C, Rm 420 N/mm ² , 125 HB										
P1.1.2 Unalloyed steel, heat-treated, 0.15 % C, Rm 420 N/mm ² , 125 HB										
P1.1.3 Unalloyed steel, annealed, 0.45 % C, Rm 640 N/mm ² , 190 HB										
P1.1.4 Unalloyed steel, heat-treated, 0.45 % C, Rm 640 N/mm ² , 190 HB										
P1.1.5 Unalloyed steel, heat-treated, 0.45 % C, Rm 850 N/mm ² , 250 HB										
P1.1.6 Unalloyed steel, annealed, 0.75 % C, Rm 915 N/mm ² , 270 HB										
P1.1.7 Unalloyed steel, heat-treated, 0.75 % C, Rm 1020 N/mm ² , 300 HB										
P2.1.1 Low-alloy steel, annealed, Rm 610 N/mm ² , 180 HB	80	0.095	0.165	0.205	0.24	0.275	0.31	0.345	0.405	
P2.1.2 Low-alloy steel, heat-treated, Rm 930 N/mm ² , 275 HB	80	0.095	0.165	0.205	0.24	0.275	0.31	0.345	0.405	
P2.1.3 Low-alloy steel, heat-treated, Rm 1020 N/mm ² , 300 HB	70	0.08	0.14	0.17	0.205	0.235	0.265	0.29	0.345	
P2.1.4 Low-alloy steel, heat-treated, Rm 1190 N/mm ² , 350 HB	60	0.07	0.12	0.15	0.18	0.205	0.23	0.255	0.305	
P3.1.1 High-alloy steel and tool steel, annealed, Rm 680 N/mm ² , 200 HB										
P3.1.2 High-alloy steel and tool steel, hardened and tempered, Rm 1100 N/mm ² , 325 HB										
M1.1.1 Stainless steel, ferritic/martensitic, with machining additives										
M1.1.2 Stainless steel, ferritic/martensitic, annealed, Rm 680 N/mm ² , 200 HB										
M1.1.3 Stainless steel, ferritic/martensitic, heat-treated, Rm 810 N/mm ² , 240 HB										
M2.1.1 Stainless steel, austenitic, quenched, 180 HB										
M2.2.1 Duplex steel, high-strength stainless steels										
K1.1.1 Grey cast iron, pearlitic/ferritic, 180 HB	90	0.125	0.210	0.260	0.305	0.355	0.395	0.440	0.520	
K1.1.2 Grey cast iron, pearlitic/martensitic, 260 HB	75	0.105	0.175	0.220	0.260	0.300	0.335	0.375	0.440	
K1.2.1 Cast iron with spheroidal graphite, ferritic, 160 HB	75	0.105	0.175	0.220	0.260	0.300	0.335	0.375	0.440	
K1.2.2 Cast iron with spheroidal graphite, pearlitic, 250 HB	70	0.100	0.165	0.205	0.245	0.280	0.315	0.350	0.415	
K1.3.1 Malleable cast iron, ferritic, 130 HB	70	0.100	0.165	0.205	0.245	0.280	0.315	0.350	0.415	
K1.3.2 Malleable cast iron, pearlitic, 230 HB	65	0.085	0.145	0.180	0.215	0.245	0.280	0.305	0.365	
K2.1.1 Vermicular graphite cast iron (GJV)										
K2.2.1 Austenitic-ferritic spheroidal graphite cast iron (ADI)										
N1.1.1 Wrought aluminium alloys, non-hardened, 60 HB										
N1.1.2 Wrought aluminium alloys, hardened, 100 HB										
N2.1.1 Aluminium casting alloys, non-hardened, ≤ 12 % Si, 75 HB										
N2.1.2 Aluminium casting alloys, hardened, ≤ 12 % Si, 90 HB										
N2.1.3 Aluminium casting alloys, non-hardened, > 12 % Si, 130 HB										
N3.1.1 Copper and copper alloys: Free-machining alloy, Pb > 1 %										
N3.1.2 Copper and copper alloys: CuZn, CuSnZn										
N3.1.3 Copper and copper alloys: CuSn, lead-free copper and copper electrolyte										
N4.1.1 Non-metallic materials: Duroplastics, fibre-reinforced plastics										
N4.1.2 Non-metallic materials: Hard rubber, wood, etc.										
N4.1.3 Non-metallic materials: Graphite										
S1.1.1 Heat-resistant alloys, Fe-based, annealed, 200 HB										
S1.1.2 Heat-resistant alloys, Fe-based, hardened, 280 HB										
S1.1.3 Heat-resistant alloys, Ni- or Co-based, annealed, 250 HB										
S1.1.4 Heat-resistant alloys, Ni- or Co-based, hardened, 350 HB										
S1.1.5 Heat-resistant alloys, Ni- or Co-based, cast, 320 HB										
S2.1.1 Titanium alloys, pure titanium, Rm 400 N/mm ²										
S2.1.2 Titanium alloys, Alpha and Beta alloys, hardened, Rm 1050 N/mm ²										
H1.1.1 Hardened steel, hardened and tempered, < 55 HRC	40	0.030	0.050	0.065	0.075	0.090	0.100	0.110	0.130	
H1.1.2 Hardened steel, hardened and tempered, < 60 HRC	25	0.025	0.040	0.050	0.060	0.070	0.080	0.090	0.105	
H1.1.3 Hardened steel, hardened and tempered, > 60 HRC	25	0.025	0.040	0.050	0.060	0.065	0.075	0.085	0.100	
H2.1.1 Chilled cast iron, 400 HB	30	0.040	0.065	0.080	0.095	0.110	0.125	0.135	0.165	
H2.1.2 Chilled cast iron, hardened and tempered, < 55 HRC	20	0.025	0.045	0.055	0.065	0.075	0.085	0.095	0.115	



Carbide-tipped twist drills





Machining group		f (mm/rev) with nom. Ø								
		v _c (m/min)	1	5	10	15	20	25	30	35
P1.1.1 Unalloyed steel, annealed, 0.15 % C, Rm 420 N/mm ² , 125 HB	80	0.020	0.090	0.155	0.210	0.260	0.305	0.355	0.395	0.440
P1.1.2 Unalloyed steel, heat-treated, 0.15 % C, Rm 420 N/mm ² , 125 HB	70	0.020	0.080	0.140	0.185	0.235	0.275	0.315	0.355	0.395
P1.1.3 Unalloyed steel, annealed, 0.45 % C, Rm 640 N/mm ² , 190 HB	70	0.020	0.080	0.140	0.185	0.235	0.275	0.315	0.355	0.395
P1.1.4 Unalloyed steel, heat-treated, 0.45 % C, Rm 640 N/mm ² , 190 HB	70	0.015	0.075	0.130	0.175	0.220	0.260	0.300	0.335	0.375
P1.1.5 Unalloyed steel, heat-treated, 0.45 % C, Rm 850 N/mm ² , 250 HB										
P1.1.6 Unalloyed steel, annealed, 0.75 % C, Rm 915 N/mm ² , 270 HB										
P1.1.7 Unalloyed steel, heat-treated, 0.75 % C, Rm 1020 N/mm ² , 300 HB										
P2.1.1 Low-alloy steel, annealed, Rm 610 N/mm ² , 180 HB										
P2.1.2 Low-alloy steel, heat-treated, Rm 930 N/mm ² , 275 HB										
P2.1.3 Low-alloy steel, heat-treated, Rm 1020 N/mm ² , 300 HB										
P2.1.4 Low-alloy steel, heat-treated, Rm 1190 N/mm ² , 350 HB										
P3.1.1 High-alloy steel and tool steel, annealed, Rm 680 N/mm ² , 200 HB										
P3.1.2 High-alloy steel and tool steel, hardened and tempered, Rm 1100 N/mm ² , 325 HB										
M1.1.1 Stainless steel, ferritic/martensitic, with machining additives										
M1.1.2 Stainless steel, ferritic/martensitic, annealed, Rm 680 N/mm ² , 200 HB										
M1.1.3 Stainless steel, ferritic/martensitic, heat-treated, Rm 810 N/mm ² , 240 HB										
M2.1.1 Stainless steel, austenitic, quenched, 180 HB										
M2.2.1 Duplex steel, high-strength stainless steels										
K1.1.1 Grey cast iron, pearlitic/ferritic, 180 HB	80	0.025	0.115	0.190	0.260	0.325	0.385	0.445	0.495	0.550
K1.1.2 Grey cast iron, pearlitic/martensitic, 260 HB	70	0.020	0.095	0.165	0.220	0.275	0.325	0.375	0.425	0.470
K1.2.1 Cast iron with spheroidal graphite, ferritic, 160 HB	70	0.020	0.095	0.165	0.220	0.275	0.325	0.375	0.425	0.470
K1.2.2 Cast iron with spheroidal graphite, pearlitic, 250 HB	65	0.020	0.090	0.155	0.210	0.260	0.310	0.355	0.400	0.440
K1.3.1 Malleable cast iron, ferritic, 130 HB	65	0.020	0.090	0.155	0.210	0.260	0.310	0.355	0.400	0.440
K1.3.2 Malleable cast iron, pearlitic, 230 HB	55	0.020	0.080	0.135	0.185	0.230	0.270	0.310	0.350	0.385
K2.1.1 Vermicular graphite cast iron (GJV)										
K2.2.1 Austenitic-ferritic spheroidal graphite cast iron (ADI)										
N1.1.1 Wrought aluminium alloys, non-hardened, 60 HB										
N1.1.2 Wrought aluminium alloys, hardened, 100 HB										
N2.1.1 Aluminium casting alloys, non-hardened, ≤ 12 % Si, 75 HB										
N2.1.2 Aluminium casting alloys, hardened, ≤ 12 % Si, 90 HB										
N2.1.3 Aluminium casting alloys, non-hardened, > 12 % Si, 130 HB										
N3.1.1 Copper and copper alloys: Free-machining alloy, Pb > 1 %	80	0.030	0.140	0.240	0.325	0.405	0.480	0.555	0.620	0.690
N3.1.2 Copper and copper alloys: CuZn, CuSnZn	70	0.025	0.120	0.205	0.280	0.345	0.410	0.470	0.530	0.585
N3.1.3 Copper and copper alloys: CuSn, lead-free copper and copper electrolyte	65	0.025	0.115	0.190	0.260	0.325	0.385	0.445	0.495	0.550
N4.1.1 Non-metallic materials: Duroplastics, fibre-reinforced plastics										
N4.1.2 Non-metallic materials: Hard rubber, wood, etc.										
N4.1.3 Non-metallic materials: Graphite										
S1.1.1 Heat-resistant alloys, Fe-based, annealed, 200 HB										
S1.1.2 Heat-resistant alloys, Fe-based, hardened, 280 HB										
S1.1.3 Heat-resistant alloys, Ni- or Co-based, annealed, 250 HB										
S1.1.4 Heat-resistant alloys, Ni- or Co-based, hardened, 350 HB										
S1.1.5 Heat-resistant alloys, Ni- or Co-based, cast, 320 HB										
S2.1.1 Titanium alloys, pure titanium, Rm 400 N/mm ²										
S2.1.2 Titanium alloys, Alpha and Beta alloys, hardened, Rm 1050 N/mm ²										
H1.1.1 Hardened steel, hardened and tempered, < 55 HRC	20	0.015	0.055	0.095	0.130	0.165	0.195	0.220	0.250	0.275
H1.1.2 Hardened steel, hardened and tempered, < 60 HRC	15	0.010	0.045	0.075	0.105	0.130	0.155	0.175	0.200	0.220
H1.1.3 Hardened steel, hardened and tempered, > 60 HRC	10	0.010	0.045	0.070	0.100	0.120	0.145	0.165	0.185	0.205
H2.1.1 Chilled cast iron, 400 HB	10	0.010	0.045	0.075	0.105	0.130	0.155	0.175	0.200	0.220
H2.1.2 Chilled cast iron, hardened and tempered, < 55 HRC	5	0.005	0.030	0.055	0.075	0.090	0.110	0.125	0.140	0.155



Stub drills/Jobber drills, bright



Machining group		f (mm/rev) with nom. Ø							
									
	v _c (m/min)	1	3	6	8	10	12	16	20
P1.1.1 Unalloyed steel, annealed, 0.15 % C, Rm 420 N/mm ² , 125 HB	80	0.025	0.075	0.130	0.160	0.190	0.220	0.275	0.325
P1.1.2 Unalloyed steel, heat-treated, 0.15 % C, Rm 420 N/mm ² , 125 HB	70	0.025	0.070	0.115	0.145	0.175	0.200	0.245	0.295
P1.1.3 Unalloyed steel, annealed, 0.45 % C, Rm 640 N/mm ² , 190 HB	70	0.025	0.070	0.115	0.145	0.175	0.200	0.245	0.295
P1.1.4 Unalloyed steel, heat-treated, 0.45 % C, Rm 640 N/mm ² , 190 HB	70	0.020	0.065	0.110	0.140	0.165	0.185	0.235	0.275
P1.1.5 Unalloyed steel, heat-treated, 0.45 % C, Rm 850 N/mm ² , 250 HB	70	0.020	0.065	0.110	0.140	0.165	0.185	0.235	0.275
P1.1.6 Unalloyed steel, annealed, 0.75 % C, Rm 915 N/mm ² , 270 HB	65	0.020	0.060	0.105	0.130	0.155	0.175	0.220	0.260
P1.1.7 Unalloyed steel, heat-treated, 0.75 % C, Rm 1020 N/mm ² , 300 HB	60	0.020	0.060	0.100	0.120	0.145	0.165	0.205	0.245
P2.1.1 Low-alloy steel, annealed, Rm 610 N/mm ² , 180 HB	60	0.020	0.060	0.105	0.130	0.155	0.175	0.220	0.260
P2.1.2 Low-alloy steel, heat-treated, Rm 930 N/mm ² , 275 HB	60	0.020	0.060	0.105	0.130	0.155	0.175	0.220	0.260
P2.1.3 Low-alloy steel, heat-treated, Rm 1020 N/mm ² , 300 HB									
P2.1.4 Low-alloy steel, heat-treated, Rm 1190 N/mm ² , 350 HB									
P3.1.1 High-alloy steel and tool steel, annealed, Rm 680 N/mm ² , 200 HB	50	0.015	0.050	0.080	0.100	0.120	0.140	0.175	0.205
P3.1.2 High-alloy steel and tool steel, hardened and tempered, Rm 1100 N/mm ² , 325 HB									
M1.1.1 Stainless steel, ferritic/martensitic, with machining additives	25	0.015	0.040	0.065	0.080	0.095	0.110	0.135	0.165
M1.1.2 Stainless steel, ferritic/martensitic, annealed, Rm 680 N/mm ² , 200 HB	25	0.010	0.035	0.060	0.075	0.085	0.100	0.125	0.145
M1.1.3 Stainless steel, ferritic/martensitic, heat-treated, Rm 810 N/mm ² , 240 HB	20	0.010	0.035	0.055	0.070	0.080	0.095	0.115	0.140
M2.1.1 Stainless steel, austenitic, quenched, 180 HB	20	0.010	0.030	0.050	0.065	0.075	0.090	0.110	0.130
M2.2.1 Duplex steel, high-strength stainless steels	15	0.010	0.025	0.045	0.055	0.065	0.075	0.095	0.110
K1.1.1 Grey cast iron, pearlitic/ferritic, 180 HB	80	0.025	0.075	0.130	0.160	0.190	0.220	0.275	0.325
K1.1.2 Grey cast iron, pearlitic/martensitic, 260 HB	70	0.020	0.065	0.110	0.140	0.165	0.185	0.235	0.275
K1.2.1 Cast iron with spheroidal graphite, ferritic, 160 HB	70	0.020	0.065	0.110	0.140	0.165	0.185	0.235	0.275
K1.2.2 Cast iron with spheroidal graphite, pearlitic, 250 HB	65	0.020	0.060	0.105	0.130	0.155	0.175	0.220	0.260
K1.3.1 Malleable cast iron, ferritic, 130 HB	65	0.020	0.060	0.105	0.130	0.155	0.175	0.220	0.260
K1.3.2 Malleable cast iron, pearlitic, 230 HB	55	0.020	0.055	0.090	0.115	0.135	0.155	0.190	0.230
K2.1.1 Vermicular graphite cast iron (GJV)									
K2.2.1 Austenitic-ferritic spheroidal graphite cast iron (ADI)									
N1.1.1 Wrought aluminium alloys, non-hardened, 60 HB	160	0.040	0.125	0.210	0.260	0.305	0.355	0.440	0.520
N1.1.2 Wrought aluminium alloys, hardened, 100 HB	160	0.040	0.125	0.210	0.260	0.305	0.355	0.440	0.520
N2.1.1 Aluminium casting alloys, non-hardened, ≤ 12 % Si, 75 HB	140	0.040	0.125	0.210	0.260	0.305	0.355	0.440	0.520
N2.1.2 Aluminium casting alloys, hardened, ≤ 12 % Si, 90 HB	140	0.040	0.125	0.210	0.260	0.305	0.355	0.440	0.520
N2.1.3 Aluminium casting alloys, non-hardened, > 12 % Si, 130 HB	120	0.035	0.105	0.175	0.220	0.260	0.300	0.375	0.440
N3.1.1 Copper and copper alloys: Free-machining alloy, Pb > 1 %	80	0.030	0.095	0.165	0.205	0.240	0.275	0.345	0.405
N3.1.2 Copper and copper alloys: CuZn, CuSnZn	70	0.025	0.080	0.140	0.170	0.205	0.235	0.290	0.345
N3.1.3 Copper and copper alloys: CuSn, lead-free copper and copper electrolyte	65	0.025	0.075	0.130	0.160	0.190	0.220	0.275	0.325
N4.1.1 Non-metallic materials: Duroplastics, fibre-reinforced plastics	80	0.020	0.060	0.105	0.130	0.192	0.175	0.220	0.260
N4.1.2 Non-metallic materials: Hard rubber, wood, etc.	50	0.020	0.060	0.105	0.130	0.155	0.175	0.220	0.260
N4.1.3 Non-metallic materials: Graphite									
S1.1.1 Heat-resistant alloys, Fe-based, annealed, 200 HB	25	0.015	0.040	0.065	0.080	0.095	0.110	0.135	0.165
S1.1.2 Heat-resistant alloys, Fe-based, hardened, 280 HB	20	0.010	0.030	0.050	0.065	0.075	0.090	0.110	0.130
S1.1.3 Heat-resistant alloys, Ni- or Co-based, annealed, 250 HB	20	0.015	0.040	0.065	0.080	0.095	0.110	0.135	0.165
S1.1.4 Heat-resistant alloys, Ni- or Co-based, hardened, 350 HB	15	0.010	0.025	0.045	0.055	0.065	0.075	0.095	0.115
S1.1.5 Heat-resistant alloys, Ni- or Co-based, cast, 320 HB	15	0.010	0.025	0.045	0.055	0.065	0.075	0.095	0.115
S2.1.1 Titanium alloys, pure titanium, Rm 400 N/mm ²	15	0.010	0.030	0.050	0.065	0.075	0.090	0.110	0.130
S2.1.2 Titanium alloys, Alpha and Beta alloys, hardened, Rm 1050 N/mm ²	10	0.010	0.025	0.040	0.050	0.060	0.070	0.090	0.105
H1.1.1 Hardened steel, hardened and tempered, < 55 HRC	20	0.015	0.040	0.065	0.080	0.095	0.110	0.135	0.165
H1.1.2 Hardened steel, hardened and tempered, < 60 HRC									
H1.1.3 Hardened steel, hardened and tempered, > 60 HRC									
H2.1.1 Chilled cast iron, 400 HB									
H2.1.2 Chilled cast iron, hardened and tempered, < 55 HRC									



Stub drills/Jobber drills, nanoFIRE





Machining group		f (mm/rev) with nom. Ø							
		v _c (m/min)	1	3	6	8	10	12	16
	F								
P1.1.1 Unalloyed steel, annealed, 0.15 % C, Rm 420 N/mm ² , 125 HB	100	0.030	0.095	0.165	0.205	0.240	0.275	0.345	0.405
P1.1.2 Unalloyed steel, heat-treated, 0.15 % C, Rm 420 N/mm ² , 125 HB	90	0.030	0.085	0.145	0.180	0.215	0.250	0.310	0.365
P1.1.3 Unalloyed steel, annealed, 0.45 % C, Rm 640 N/mm ² , 190 HB	90	0.030	0.085	0.145	0.180	0.215	0.250	0.310	0.365
P1.1.4 Unalloyed steel, heat-treated, 0.45 % C, Rm 640 N/mm ² , 190 HB	85	0.025	0.080	0.140	0.170	0.205	0.235	0.290	0.345
P1.1.5 Unalloyed steel, heat-treated, 0.45 % C, Rm 850 N/mm ² , 250 HB	85	0.025	0.080	0.140	0.170	0.205	0.235	0.290	0.345
P1.1.6 Unalloyed steel, annealed, 0.75 % C, Rm 915 N/mm ² , 270 HB	80	0.025	0.075	0.130	0.160	0.190	0.220	0.275	0.325
P1.1.7 Unalloyed steel, heat-treated, 0.75 % C, Rm 1020 N/mm ² , 300 HB	75	0.025	0.070	0.120	0.150	0.180	0.205	0.255	0.305
P2.1.1 Low-alloy steel, annealed, Rm 610 N/mm ² , 180 HB	80	0.025	0.075	0.130	0.160	0.190	0.220	0.275	0.325
P2.1.2 Low-alloy steel, heat-treated, Rm 930 N/mm ² , 275 HB	80	0.025	0.075	0.130	0.160	0.190	0.220	0.275	0.325
P2.1.3 Low-alloy steel, heat-treated, Rm 1020 N/mm ² , 300 HB	65	0.020	0.065	0.110	0.140	0.165	0.185	0.235	0.275
P2.1.4 Low-alloy steel, heat-treated, Rm 1190 N/mm ² , 350 HB	60	0.020	0.060	0.100	0.120	0.145	0.165	0.205	0.245
P3.1.1 High-alloy steel and tool steel, annealed, Rm 680 N/mm ² , 200 HB	65	0.020	0.060	0.105	0.130	0.155	0.175	0.220	0.260
P3.1.2 High-alloy steel and tool steel, hardened and tempered, Rm 1100 N/mm ² , 325 HB									
M1.1.1 Stainless steel, ferritic/martensitic, with machining additives	30	0.015	0.040	0.065	0.080	0.095	0.110	0.135	0.165
M1.1.2 Stainless steel, ferritic/martensitic, annealed, Rm 680 N/mm ² , 200 HB	30	0.010	0.035	0.060	0.075	0.085	0.100	0.125	0.145
M1.1.3 Stainless steel, ferritic/martensitic, heat-treated, Rm 810 N/mm ² , 240 HB	25	0.010	0.035	0.055	0.070	0.080	0.095	0.115	0.140
M2.1.1 Stainless steel, austenitic, quenched, 180 HB	20	0.010	0.030	0.050	0.065	0.075	0.090	0.110	0.130
M2.2.1 Duplex steel, high-strength stainless steels	15	0.010	0.025	0.045	0.055	0.065	0.075	0.095	0.110
K1.1.1 Grey cast iron, pearlitic/ferritic, 180 HB	90	0.040	0.125	0.210	0.260	0.305	0.355	0.440	0.520
K1.1.2 Grey cast iron, pearlitic/martensitic, 260 HB	75	0.035	0.105	0.175	0.220	0.260	0.300	0.375	0.440
K1.2.1 Cast iron with spheroidal graphite, ferritic, 160 HB	75	0.035	0.105	0.175	0.220	0.260	0.300	0.375	0.440
K1.2.2 Cast iron with spheroidal graphite, pearlitic, 250 HB	70	0.035	0.100	0.165	0.205	0.245	0.280	0.350	0.415
K1.3.1 Malleable cast iron, ferritic, 130 HB	70	0.035	0.100	0.165	0.205	0.245	0.280	0.350	0.415
K1.3.2 Malleable cast iron, pearlitic, 230 HB	65	0.030	0.085	0.145	0.180	0.215	0.245	0.305	0.365
K2.1.1 Vermicular graphite cast iron (GJV)									
K2.2.1 Austenitic-ferritic spheroidal graphite cast iron (ADI)									
N1.1.1 Wrought aluminium alloys, non-hardened, 60 HB	165	0.040	0.125	0.210	0.260	0.305	0.355	0.440	0.520
N1.1.2 Wrought aluminium alloys, hardened, 100 HB	165	0.040	0.125	0.210	0.260	0.305	0.355	0.440	0.520
N2.1.1 Aluminium casting alloys, non-hardened, ≤ 12 % Si, 75 HB	150	0.040	0.125	0.210	0.260	0.305	0.355	0.440	0.520
N2.1.2 Aluminium casting alloys, hardened, ≤ 12 % Si, 90 HB	150	0.040	0.125	0.210	0.260	0.305	0.355	0.440	0.520
N2.1.3 Aluminium casting alloys, non-hardened, > 12 % Si, 130 HB	130	0.035	0.105	0.175	0.220	0.260	0.300	0.375	0.440
N3.1.1 Copper and copper alloys: Free-machining alloy, Pb > 1 %	110	0.030	0.095	0.165	0.205	0.240	0.275	0.345	0.405
N3.1.2 Copper and copper alloys: CuZn, CuSnZn	95	0.025	0.080	0.140	0.170	0.205	0.235	0.290	0.345
N3.1.3 Copper and copper alloys: CuSn, lead-free copper and copper electrolyte	90	0.025	0.075	0.130	0.160	0.190	0.220	0.275	0.325
N4.1.1 Non-metallic materials: Duroplastics, fibre-reinforced plastics	55	0.015	0.040	0.065	0.080	0.095	0.110	0.135	0.165
N4.1.2 Non-metallic materials: Hard rubber, wood, etc.	55	0.015	0.040	0.065	0.080	0.095	0.110	0.135	0.165
N4.1.3 Non-metallic materials: Graphite									
S1.1.1 Heat-resistant alloys, Fe-based, annealed, 200 HB	30	0.015	0.040	0.065	0.080	0.095	0.110	0.135	0.165
S1.1.2 Heat-resistant alloys, Fe-based, hardened, 280 HB	25	0.010	0.030	0.050	0.065	0.075	0.090	0.110	0.130
S1.1.3 Heat-resistant alloys, Ni- or Co-based, annealed, 250 HB	25	0.015	0.040	0.065	0.080	0.095	0.110	0.135	0.165
S1.1.4 Heat-resistant alloys, Ni- or Co-based, hardened, 350 HB	15	0.010	0.025	0.045	0.055	0.065	0.075	0.095	0.115
S1.1.5 Heat-resistant alloys, Ni- or Co-based, cast, 320 HB	20	0.010	0.025	0.045	0.055	0.065	0.075	0.095	0.115
S2.1.1 Titanium alloys, pure titanium, Rm 400 N/mm ²	20	0.010	0.030	0.050	0.065	0.075	0.090	0.110	0.130
S2.1.2 Titanium alloys, Alpha and Beta alloys, hardened, Rm 1050 N/mm ²	15	0.010	0.025	0.040	0.050	0.060	0.070	0.090	0.105
H1.1.1 Hardened steel, hardened and tempered, < 55 HRC	25	0.015	0.040	0.065	0.080	0.095	0.110	0.135	0.165
H1.1.2 Hardened steel, hardened and tempered, < 60 HRC									
H1.1.3 Hardened steel, hardened and tempered, > 60 HRC									
H2.1.1 Chilled cast iron, 400 HB									
H2.1.2 Chilled cast iron, hardened and tempered, < 55 HRC									



Jobber drills, bright



Machining group		f (mm/rev) with nom. Ø							
									
	v _c (m/min)	3	6	8	10	12	14	16	20
P1.1.1 Unalloyed steel, annealed, 0.15 % C, Rm 420 N/mm ² , 125 HB	55	0.075	0.130	0.160	0.190	0.220	0.250	0.275	0.325
P1.1.2 Unalloyed steel, heat-treated, 0.15 % C, Rm 420 N/mm ² , 125 HB	50	0.070	0.115	0.145	0.175	0.200	0.225	0.245	0.295
P1.1.3 Unalloyed steel, annealed, 0.45 % C, Rm 640 N/mm ² , 190 HB	50	0.070	0.115	0.145	0.175	0.200	0.225	0.245	0.295
P1.1.4 Unalloyed steel, heat-treated, 0.45 % C, Rm 640 N/mm ² , 190 HB	50	0.065	0.110	0.140	0.165	0.185	0.210	0.235	0.275
P1.1.5 Unalloyed steel, heat-treated, 0.45 % C, Rm 850 N/mm ² , 250 HB	50	0.065	0.110	0.140	0.165	0.185	0.210	0.235	0.275
P1.1.6 Unalloyed steel, annealed, 0.75 % C, Rm 915 N/mm ² , 270 HB	45	0.060	0.105	0.130	0.155	0.175	0.200	0.220	0.260
P1.1.7 Unalloyed steel, heat-treated, 0.75 % C, Rm 1020 N/mm ² , 300 HB	40	0.060	0.100	0.120	0.145	0.165	0.185	0.205	0.245
P2.1.1 Low-alloy steel, annealed, Rm 610 N/mm ² , 180 HB	35	0.060	0.105	0.130	0.155	0.175	0.200	0.220	0.260
P2.1.2 Low-alloy steel, heat-treated, Rm 930 N/mm ² , 275 HB	35	0.060	0.105	0.130	0.155	0.175	0.200	0.220	0.260
P2.1.3 Low-alloy steel, heat-treated, Rm 1020 N/mm ² , 300 HB	30	0.050	0.090	0.110	0.130	0.150	0.170	0.185	0.220
P2.1.4 Low-alloy steel, heat-treated, Rm 1190 N/mm ² , 350 HB	30	0.045	0.080	0.095	0.115	0.130	0.150	0.165	0.195
P3.1.1 High-alloy steel and tool steel, annealed, Rm 680 N/mm ² , 200 HB	35	0.060	0.105	0.130	0.155	0.175	0.200	0.220	0.260
P3.1.2 High-alloy steel and tool steel, hardened and tempered, Rm 1100 N/mm ² , 325 HB	30	0.050	0.090	0.110	0.130	0.150	0.170	0.185	0.220
M1.1.1 Stainless steel, ferritic/martensitic, with machining additives	25	0.040	0.065	0.080	0.095	0.110	0.125	0.135	0.165
M1.1.2 Stainless steel, ferritic/martensitic, annealed, Rm 680 N/mm ² , 200 HB	25	0.035	0.060	0.075	0.085	0.100	0.110	0.125	0.145
M1.1.3 Stainless steel, ferritic/martensitic, heat-treated, Rm 810 N/mm ² , 240 HB	25	0.035	0.055	0.070	0.080	0.095	0.105	0.115	0.140
M2.1.1 Stainless steel, austenitic, quenched, 180 HB									
M2.2.1 Duplex steel, high-strength stainless steels									
K1.1.1 Grey cast iron, pearlitic/ferritic, 180 HB	80	0.075	0.130	0.160	0.190	0.220	0.250	0.275	0.325
K1.1.2 Grey cast iron, pearlitic/martensitic, 260 HB	70	0.065	0.110	0.140	0.165	0.185	0.210	0.235	0.275
K1.2.1 Cast iron with spheroidal graphite, ferritic, 160 HB	70	0.065	0.110	0.140	0.165	0.185	0.210	0.235	0.275
K1.2.2 Cast iron with spheroidal graphite, pearlitic, 250 HB	65	0.060	0.105	0.130	0.155	0.175	0.200	0.220	0.260
K1.3.1 Malleable cast iron, ferritic, 130 HB	65	0.060	0.105	0.130	0.155	0.175	0.200	0.220	0.260
K1.3.2 Malleable cast iron, pearlitic, 230 HB	55	0.055	0.090	0.115	0.135	0.155	0.175	0.190	0.230
K2.1.1 Vermicular graphite cast iron (GJV)									
K2.2.1 Austenitic-ferritic spheroidal graphite cast iron (ADI)									
N1.1.1 Wrought aluminium alloys, non-hardened, 60 HB									
N1.1.2 Wrought aluminium alloys, hardened, 100 HB									
N2.1.1 Aluminium casting alloys, non-hardened, ≤ 12 % Si, 75 HB	140	0.125	0.210	0.260	0.305	0.355	0.395	0.440	0.520
N2.1.2 Aluminium casting alloys, hardened, ≤ 12 % Si, 90 HB	140	0.125	0.210	0.260	0.305	0.355	0.395	0.440	0.520
N2.1.3 Aluminium casting alloys, non-hardened, > 12 % Si, 130 HB	120	0.105	0.175	0.220	0.260	0.300	0.335	0.375	0.440
N3.1.1 Copper and copper alloys: Free-machining alloy, Pb > 1 %	80	0.095	0.165	0.205	0.240	0.275	0.310	0.345	0.405
N3.1.2 Copper and copper alloys: CuZn, CuSnZn	70	0.080	0.140	0.170	0.205	0.235	0.265	0.290	0.345
N3.1.3 Copper and copper alloys: CuSn, lead-free copper and copper electrolyte	65	0.075	0.130	0.160	0.190	0.220	0.250	0.275	0.325
N4.1.1 Non-metallic materials: Duroplastics, fibre-reinforced plastics	50	0.040	0.065	0.080	0.095	0.110	0.125	0.135	0.165
N4.1.2 Non-metallic materials: Hard rubber, wood, etc.	50	0.040	0.065	0.080	0.095	0.110	0.125	0.135	0.165
N4.1.3 Non-metallic materials: Graphite									
S1.1.1 Heat-resistant alloys, Fe-based, annealed, 200 HB									
S1.1.2 Heat-resistant alloys, Fe-based, hardened, 280 HB									
S1.1.3 Heat-resistant alloys, Ni- or Co-based, annealed, 250 HB									
S1.1.4 Heat-resistant alloys, Ni- or Co-based, hardened, 350 HB									
S1.1.5 Heat-resistant alloys, Ni- or Co-based, cast, 320 HB									
S2.1.1 Titanium alloys, pure titanium, Rm 400 N/mm ²									
S2.1.2 Titanium alloys, Alpha and Beta alloys, hardened, Rm 1050 N/mm ²									
H1.1.1 Hardened steel, hardened and tempered, < 55 HRC									
H1.1.2 Hardened steel, hardened and tempered, < 60 HRC									
H1.1.3 Hardened steel, hardened and tempered, > 60 HRC									
H2.1.1 Chilled cast iron, 400 HB	15	0.050	0.080	0.100	0.120	0.140	0.155	0.175	0.205
H2.1.2 Chilled cast iron, hardened and tempered, < 55 HRC	10	0.035	0.055	0.070	0.085	0.095	0.110	0.120	0.145



Interchangeable inserts HT 800 Pilot, with tool holder ≤ 5xD



Machining group		f (mm/rev) with nom. Ø							
		v _c (m/min)	11	14	16	20	24	28	32
P1.1.1 Unalloyed steel, annealed, 0.15 % C, Rm 420 N/mm ² , 125 HB	130	0.260	0.310	0.345	0.405	0.465	0.525	0.580	0.690
P1.1.2 Unalloyed steel, heat-treated, 0.15 % C, Rm 420 N/mm ² , 125 HB	115	0.230	0.280	0.310	0.365	0.420	0.470	0.525	0.620
P1.1.3 Unalloyed steel, annealed, 0.45 % C, Rm 640 N/mm ² , 190 HB	115	0.230	0.280	0.310	0.365	0.420	0.470	0.525	0.620
P1.1.4 Unalloyed steel, heat-treated, 0.45 % C, Rm 640 N/mm ² , 190 HB	110	0.220	0.265	0.290	0.345	0.395	0.445	0.495	0.585
P1.1.5 Unalloyed steel, heat-treated, 0.45 % C, Rm 850 N/mm ² , 250 HB	110	0.220	0.265	0.290	0.345	0.395	0.445	0.495	0.585
P1.1.6 Unalloyed steel, annealed, 0.75 % C, Rm 915 N/mm ² , 270 HB	105	0.205	0.250	0.275	0.325	0.375	0.420	0.465	0.550
P1.1.7 Unalloyed steel, heat-treated, 0.75 % C, Rm 1020 N/mm ² , 300 HB	100	0.195	0.230	0.255	0.305	0.350	0.395	0.435	0.515
P2.1.1 Low-alloy steel, annealed, Rm 610 N/mm ² , 180 HB	110	0.260	0.310	0.345	0.405	0.465	0.525	0.580	0.690
P2.1.2 Low-alloy steel, heat-treated, Rm 930 N/mm ² , 275 HB	110	0.260	0.310	0.345	0.405	0.465	0.525	0.580	0.690
P2.1.3 Low-alloy steel, heat-treated, Rm 1020 N/mm ² , 300 HB	95	0.220	0.265	0.290	0.345	0.395	0.445	0.495	0.585
P2.1.4 Low-alloy steel, heat-treated, Rm 1190 N/mm ² , 350 HB	85	0.195	0.230	0.255	0.305	0.350	0.395	0.435	0.515
P3.1.1 High-alloy steel and tool steel, annealed, Rm 680 N/mm ² , 200 HB	60	0.205	0.250	0.275	0.325	0.375	0.420	0.465	0.550
P3.1.2 High-alloy steel and tool steel, hardened and tempered, Rm 1100 N/mm ² , 325 HB	50	0.175	0.210	0.235	0.275	0.315	0.355	0.395	0.470
M1.1.1 Stainless steel, ferritic/martensitic, with machining additives	55	0.130	0.155	0.175	0.205	0.235	0.265	0.295	0.345
M1.1.2 Stainless steel, ferritic/martensitic, annealed, Rm 680 N/mm ² , 200 HB	50	0.115	0.140	0.155	0.185	0.210	0.240	0.265	0.310
M1.1.3 Stainless steel, ferritic/martensitic, heat-treated, Rm 810 N/mm ² , 240 HB	45	0.110	0.135	0.145	0.175	0.200	0.225	0.250	0.295
M2.1.1 Stainless steel, austenitic, quenched, 180 HB	40	0.130	0.155	0.175	0.205	0.235	0.265	0.295	0.345
M2.2.1 Duplex steel, high-strength stainless steels									
K1.1.1 Grey cast iron, pearlitic/ferritic, 180 HB	100	0.260	0.310	0.345	0.405	0.465	0.525	0.580	0.690
K1.1.2 Grey cast iron, pearlitic/martensitic, 260 HB	85	0.220	0.265	0.290	0.345	0.395	0.445	0.495	0.585
K1.2.1 Cast iron with spheroidal graphite, ferritic, 160 HB									
K1.2.2 Cast iron with spheroidal graphite, pearlitic, 250 HB	85	0.220	0.265	0.290	0.345	0.395	0.445	0.495	0.585
K1.3.1 Malleable cast iron, ferritic, 130 HB									
K1.3.2 Malleable cast iron, pearlitic, 230 HB	80	0.205	0.250	0.275	0.325	0.375	0.420	0.465	0.550
K2.1.1 Vermicular graphite cast iron (GJV)	80	0.205	0.250	0.275	0.325	0.375	0.420	0.465	0.550
K2.2.1 Austenitic-ferritic spheroidal graphite cast iron (ADI)									
N1.1.1 Wrought aluminium alloys, non-hardened, 60 HB	200	0.330	0.395	0.440	0.520	0.595	0.670	0.745	0.880
N1.1.2 Wrought aluminium alloys, hardened, 100 HB	200	0.330	0.395	0.440	0.520	0.595	0.670	0.745	0.880
N2.1.1 Aluminium casting alloys, non-hardened, ≤ 12 % Si, 75 HB	180	0.330	0.395	0.440	0.520	0.595	0.670	0.745	0.880
N2.1.2 Aluminium casting alloys, hardened, ≤ 12 % Si, 90 HB	180	0.330	0.395	0.440	0.520	0.595	0.670	0.745	0.880
N2.1.3 Aluminium casting alloys, non-hardened, > 12 % Si, 130 HB	155	0.280	0.335	0.375	0.440	0.510	0.570	0.630	0.750
N3.1.1 Copper and copper alloys: Free-machining alloy, Pb > 1 %	140	0.260	0.310	0.345	0.405	0.465	0.525	0.580	0.690
N3.1.2 Copper and copper alloys: CuZn, CuSnZn	120	0.220	0.265	0.290	0.345	0.395	0.445	0.495	0.585
N3.1.3 Copper and copper alloys: CuSn, lead-free copper and copper electrolyte	110	0.205	0.250	0.275	0.325	0.375	0.420	0.465	0.550
N4.1.1 Non-metallic materials: Duroplastics, fibre-reinforced plastics									
N4.1.2 Non-metallic materials: Hard rubber, wood, etc.									
N4.1.3 Non-metallic materials: Graphite									
S1.1.1 Heat-resistant alloys, Fe-based, annealed, 200 HB	35	0.105	0.125	0.135	0.165	0.185	0.210	0.230	0.275
S1.1.2 Heat-resistant alloys, Fe-based, hardened, 280 HB	30	0.085	0.100	0.110	0.130	0.150	0.170	0.185	0.220
S1.1.3 Heat-resistant alloys, Ni- or Co-based, annealed, 250 HB	30	0.105	0.125	0.135	0.165	0.185	0.210	0.230	0.275
S1.1.4 Heat-resistant alloys, Ni- or Co-based, hardened, 350 HB	20	0.070	0.085	0.095	0.115	0.130	0.145	0.165	0.195
S1.1.5 Heat-resistant alloys, Ni- or Co-based, cast, 320 HB	20	0.070	0.085	0.095	0.115	0.130	0.145	0.165	0.195
S2.1.1 Titanium alloys, pure titanium, Rm 400 N/mm ²	40	0.130	0.155	0.175	0.205	0.235	0.265	0.295	0.345
S2.1.2 Titanium alloys, Alpha and Beta alloys, hardened, Rm 1050 N/mm ²	30	0.105	0.125	0.140	0.165	0.190	0.210	0.235	0.280
H1.1.1 Hardened steel, hardened and tempered, < 55 HRC	25	0.105	0.125	0.135	0.165	0.185	0.210	0.230	0.275
H1.1.2 Hardened steel, hardened and tempered, < 60 HRC									
H1.1.3 Hardened steel, hardened and tempered, > 60 HRC									
H2.1.1 Chilled cast iron, 400 HB	90	0.260	0.310	0.345	0.405	0.465	0.525	0.580	0.690
H2.1.2 Chilled cast iron, hardened and tempered, < 55 HRC	65	0.180	0.215	0.240	0.285	0.325	0.365	0.405	0.480



Interchangeable inserts HT 800, with tool holder ≤ 5xD



Machining group	Art. no.		f (mm/rev) with nom. Ø								
			v _c (m/min)	11	14	16	20	24	28	32	40
P1.1.1 Unalloyed steel, annealed, 0.15 % C, Rm 420 N/mm ² , 125 HB	4112	130	0.260	0.310	0.345	0.405	0.465	0.525	0.580	0.690	
P1.1.2 Unalloyed steel, heat-treated, 0.15 % C, Rm 420 N/mm ² , 125 HB	4112	115	0.230	0.280	0.310	0.365	0.420	0.470	0.525	0.620	
P1.1.3 Unalloyed steel, annealed, 0.45 % C, Rm 640 N/mm ² , 190 HB	4112	115	0.230	0.280	0.310	0.365	0.420	0.470	0.525	0.620	
P1.1.4 Unalloyed steel, heat-treated, 0.45 % C, Rm 640 N/mm ² , 190 HB	4112	110	0.220	0.265	0.290	0.345	0.395	0.445	0.495	0.585	
P1.1.5 Unalloyed steel, heat-treated, 0.45 % C, Rm 850 N/mm ² , 250 HB	4112	110	0.220	0.265	0.290	0.345	0.395	0.445	0.495	0.585	
P1.1.6 Unalloyed steel, annealed, 0.75 % C, Rm 915 N/mm ² , 270 HB	4112	105	0.205	0.250	0.275	0.325	0.375	0.420	0.465	0.550	
P1.1.7 Unalloyed steel, heat-treated, 0.75 % C, Rm 1020 N/mm ² , 300 HB	4112	100	0.195	0.230	0.255	0.305	0.350	0.395	0.435	0.515	
P2.1.1 Low-alloy steel, annealed, Rm 610 N/mm ² , 180 HB	4112	110	0.260	0.310	0.345	0.405	0.465	0.525	0.580	0.690	
P2.1.2 Low-alloy steel, heat-treated, Rm 930 N/mm ² , 275 HB	4112	110	0.260	0.310	0.345	0.405	0.465	0.525	0.580	0.690	
P2.1.3 Low-alloy steel, heat-treated, Rm 1020 N/mm ² , 300 HB	4112	95	0.220	0.265	0.290	0.345	0.395	0.445	0.495	0.585	
P2.1.4 Low-alloy steel, heat-treated, Rm 1190 N/mm ² , 350 HB	4112	85	0.195	0.230	0.255	0.305	0.350	0.395	0.435	0.515	
P3.1.1 High-alloy steel and tool steel, annealed, Rm 680 N/mm ² , 200 HB	4112	60	0.205	0.250	0.275	0.325	0.375	0.420	0.465	0.550	
P3.1.2 High-alloy steel and tool steel, hardened and tempered, Rm 1100 N/mm ² , 325 HB	4112	50	0.175	0.210	0.235	0.275	0.315	0.355	0.395	0.470	
M1.1.1 Stainless steel, ferritic/martensitic, with machining additives	4115	55	0.130	0.155	0.175	0.205	0.235	0.265	0.295	0.345	
M1.1.2 Stainless steel, ferritic/martensitic, annealed, Rm 680 N/mm ² , 200 HB	4115	50	0.115	0.140	0.155	0.185	0.210	0.240	0.265	0.310	
M1.1.3 Stainless steel, ferritic/martensitic, heat-treated, Rm 810 N/mm ² , 240 HB	4115	45	0.110	0.135	0.145	0.175	0.200	0.225	0.250	0.295	
M2.1.1 Stainless steel, austenitic, quenched, 180 HB	4115	40	0.130	0.155	0.175	0.205	0.235	0.265	0.295	0.345	
M2.2.1 Duplex steel, high-strength stainless steels											
K1.1.1 Grey cast iron, pearlitic/ferritic, 180 HB	4113	100	0.260	0.310	0.345	0.405	0.465	0.525	0.580	0.690	
K1.1.2 Grey cast iron, pearlitic/martensitic, 260 HB	4113	85	0.220	0.265	0.290	0.345	0.395	0.445	0.495	0.585	
K1.2.1 Cast iron with spheroidal graphite, ferritic, 160 HB											
K1.2.2 Cast iron with spheroidal graphite, pearlitic, 250 HB	4113	85	0.220	0.265	0.290	0.345	0.395	0.445	0.495	0.585	
K1.3.1 Malleable cast iron, ferritic, 130 HB											
K1.3.2 Malleable cast iron, pearlitic, 230 HB	4113	80	0.205	0.250	0.275	0.325	0.375	0.420	0.465	0.550	
K2.1.1 Vermicular graphite cast iron (GJV)	4113	80	0.205	0.250	0.275	0.325	0.375	0.420	0.465	0.550	
K2.2.1 Austenitic-ferritic spheroidal graphite cast iron (ADI)											
N1.1.1 Wrought aluminium alloys, non-hardened, 60 HB	4114	200	0.330	0.395	0.440	0.520	0.595	0.670	0.745	0.880	
N1.1.2 Wrought aluminium alloys, hardened, 100 HB	4114	200	0.330	0.395	0.440	0.520	0.595	0.670	0.745	0.880	
N2.1.1 Aluminium casting alloys, non-hardened, ≤ 12 % Si, 75 HB	4114	180	0.330	0.395	0.440	0.520	0.595	0.670	0.745	0.880	
N2.1.2 Aluminium casting alloys, hardened, ≤ 12 % Si, 90 HB	4114	180	0.330	0.395	0.440	0.520	0.595	0.670	0.745	0.880	
N2.1.3 Aluminium casting alloys, non-hardened, > 12 % Si, 130 HB	4114	155	0.280	0.335	0.375	0.440	0.510	0.570	0.630	0.750	
N3.1.1 Copper and copper alloys: Free-machining alloy, Pb > 1 %	4114	140	0.260	0.310	0.345	0.405	0.465	0.525	0.580	0.690	
N3.1.2 Copper and copper alloys: CuZn, CuSnZn	4114	120	0.220	0.265	0.290	0.345	0.395	0.445	0.495	0.585	
N3.1.3 Copper and copper alloys: CuSn, lead-free copper and copper electrolyte	4114	110	0.205	0.250	0.275	0.325	0.375	0.420	0.465	0.550	
N4.1.1 Non-metallic materials: Duroplastics, fibre-reinforced plastics											
N4.1.2 Non-metallic materials: Hard rubber, wood, etc.											
N4.1.3 Non-metallic materials: Graphite											
S1.1.1 Heat-resistant alloys, Fe-based, annealed, 200 HB	4115	35	0.105	0.125	0.135	0.165	0.185	0.210	0.230	0.275	
S1.1.2 Heat-resistant alloys, Fe-based, hardened, 280 HB	4115	30	0.085	0.100	0.110	0.130	0.150	0.170	0.185	0.220	
S1.1.3 Heat-resistant alloys, Ni- or Co-based, annealed, 250 HB	4115	30	0.105	0.125	0.135	0.165	0.185	0.210	0.230	0.275	
S1.1.4 Heat-resistant alloys, Ni- or Co-based, hardened, 350 HB	4115	20	0.070	0.085	0.095	0.115	0.130	0.145	0.165	0.195	
S1.1.5 Heat-resistant alloys, Ni- or Co-based, cast, 320 HB	4115	20	0.070	0.085	0.095	0.115	0.130	0.145	0.165	0.195	
S2.1.1 Titanium alloys, pure titanium, Rm 400 N/mm ²	4115	40	0.130	0.155	0.175	0.205	0.235	0.265	0.295	0.345	
S2.1.2 Titanium alloys, Alpha and Beta alloys, hardened, Rm 1050 N/mm ²	4115	30	0.105	0.125	0.140	0.165	0.190	0.210	0.235	0.280	
H1.1.1 Hardened steel, hardened and tempered, < 55 HRC	4115	25	0.105	0.125	0.135	0.165	0.185	0.210	0.230	0.275	
H1.1.2 Hardened steel, hardened and tempered, < 60 HRC											
H1.1.3 Hardened steel, hardened and tempered, > 60 HRC											
H2.1.1 Chilled cast iron, 400 HB	4115	90	0.260	0.310	0.345	0.405	0.465	0.525	0.580	0.690	
H2.1.2 Chilled cast iron, hardened and tempered, < 55 HRC	4115	65	0.180	0.215	0.240	0.285	0.325	0.365	0.405	0.480	



Interchangeable inserts HT 800, with tool holder 7xD



Machining group	Art. no.		f (mm/rev) with nom. Ø							
			v _c (m/min)	11	14	16	20	24	28	32
P1.1.1 Unalloyed steel, annealed, 0.15 % C, Rm 420 N/mm ² , 125 HB	4112	115	0.225	0.275	0.300	0.360	0.410	0.460	0.510	0.605
P1.1.2 Unalloyed steel, heat-treated, 0.15 % C, Rm 420 N/mm ² , 125 HB	4112	105	0.205	0.245	0.270	0.320	0.370	0.415	0.460	0.545
P1.1.3 Unalloyed steel, annealed, 0.45 % C, Rm 640 N/mm ² , 190 HB	4112	105	0.205	0.245	0.270	0.320	0.370	0.415	0.460	0.545
P1.1.4 Unalloyed steel, heat-treated, 0.45 % C, Rm 640 N/mm ² , 190 HB	4112	100	0.195	0.230	0.255	0.305	0.350	0.395	0.435	0.515
P1.1.5 Unalloyed steel, heat-treated, 0.45 % C, Rm 850 N/mm ² , 250 HB	4112	100	0.195	0.230	0.255	0.305	0.350	0.395	0.435	0.515
P1.1.6 Unalloyed steel, annealed, 0.75 % C, Rm 915 N/mm ² , 270 HB	4112	95	0.180	0.220	0.240	0.285	0.330	0.370	0.410	0.485
P1.1.7 Unalloyed steel, heat-treated, 0.75 % C, Rm 1020 N/mm ² , 300 HB	4112	90	0.170	0.205	0.225	0.270	0.310	0.345	0.385	0.455
P2.1.1 Low-alloy steel, annealed, Rm 610 N/mm ² , 180 HB	4112	100	0.225	0.275	0.300	0.360	0.410	0.460	0.510	0.605
P2.1.2 Low-alloy steel, heat-treated, Rm 930 N/mm ² , 275 HB	4112	100	0.225	0.275	0.300	0.360	0.410	0.460	0.510	0.605
P2.1.3 Low-alloy steel, heat-treated, Rm 1020 N/mm ² , 300 HB	4112	85	0.195	0.230	0.255	0.305	0.350	0.395	0.435	0.515
P2.1.4 Low-alloy steel, heat-treated, Rm 1190 N/mm ² , 350 HB	4112	75	0.170	0.205	0.225	0.270	0.310	0.345	0.385	0.455
P3.1.1 High-alloy steel and tool steel, annealed, Rm 680 N/mm ² , 200 HB	4112	55	0.180	0.220	0.240	0.285	0.330	0.370	0.410	0.485
P3.1.2 High-alloy steel and tool steel, hardened and tempered, Rm 1100 N/mm ² , 325 HB	4112	45	0.155	0.185	0.205	0.245	0.280	0.315	0.350	0.410
M1.1.1 Stainless steel, ferritic/martensitic, with machining additives	4115	50	0.115	0.140	0.150	0.180	0.205	0.235	0.260	0.305
M1.1.2 Stainless steel, ferritic/martensitic, annealed, Rm 680 N/mm ² , 200 HB	4115	45	0.105	0.125	0.135	0.160	0.185	0.210	0.230	0.275
M1.1.3 Stainless steel, ferritic/martensitic, heat-treated, Rm 810 N/mm ² , 240 HB	4115	40	0.095	0.115	0.130	0.155	0.175	0.200	0.220	0.260
M2.1.1 Stainless steel, austenitic, quenched, 180 HB	4115	35	0.115	0.140	0.150	0.180	0.205	0.235	0.260	0.305
M2.2.1 Duplex steel, high-strength stainless steels										
K1.1.1 Grey cast iron, pearlitic/ferritic, 180 HB	4113	90	0.225	0.275	0.300	0.360	0.410	0.460	0.510	0.605
K1.1.2 Grey cast iron, pearlitic/martensitic, 260 HB	4113	75	0.195	0.230	0.255	0.305	0.350	0.395	0.435	0.515
K1.2.1 Cast iron with spheroidal graphite, ferritic, 160 HB										
K1.2.2 Cast iron with spheroidal graphite, pearlitic, 250 HB	4113	75	0.195	0.230	0.255	0.305	0.350	0.395	0.435	0.515
K1.3.1 Malleable cast iron, ferritic, 130 HB										
K1.3.2 Malleable cast iron, pearlitic, 230 HB	4113	70	0.180	0.220	0.240	0.285	0.330	0.370	0.410	0.485
K2.1.1 Vermicular graphite cast iron (GJV)	4113	70	0.180	0.220	0.240	0.285	0.330	0.370	0.410	0.485
K2.2.1 Austenitic-ferritic spheroidal graphite cast iron (ADI)										
N1.1.1 Wrought aluminium alloys, non-hardened, 60 HB	4114	180	0.290	0.350	0.385	0.460	0.525	0.590	0.655	0.775
N1.1.2 Wrought aluminium alloys, hardened, 100 HB	4114	180	0.290	0.350	0.385	0.460	0.525	0.590	0.655	0.775
N2.1.1 Aluminium casting alloys, non-hardened, ≤ 12 % Si, 75 HB	4114	160	0.290	0.350	0.385	0.460	0.525	0.590	0.655	0.775
N2.1.2 Aluminium casting alloys, hardened, ≤ 12 % Si, 90 HB	4114	160	0.290	0.350	0.385	0.460	0.525	0.590	0.655	0.775
N2.1.3 Aluminium casting alloys, non-hardened, > 12 % Si, 130 HB	4114	140	0.245	0.295	0.330	0.390	0.445	0.500	0.555	0.660
N3.1.1 Copper and copper alloys: Free-machining alloy, Pb > 1 %	4114	125	0.225	0.275	0.300	0.360	0.410	0.460	0.510	0.605
N3.1.2 Copper and copper alloys: CuZn, CuSnZn	4114	105	0.195	0.230	0.255	0.305	0.350	0.395	0.435	0.515
N3.1.3 Copper and copper alloys: CuSn, lead-free copper and copper electrolyte	4114	100	0.180	0.220	0.240	0.285	0.330	0.370	0.410	0.485
N4.1.1 Non-metallic materials: Duroplastics, fibre-reinforced plastics										
N4.1.2 Non-metallic materials: Hard rubber, wood, etc.										
N4.1.3 Non-metallic materials: Graphite										
S1.1.1 Heat-resistant alloys, Fe-based, annealed, 200 HB	4115	30	0.090	0.110	0.120	0.145	0.165	0.185	0.205	0.240
S1.1.2 Heat-resistant alloys, Fe-based, hardened, 280 HB	4115	25	0.075	0.085	0.095	0.115	0.130	0.150	0.165	0.195
S1.1.3 Heat-resistant alloys, Ni- or Co-based, annealed, 250 HB	4115	25	0.090	0.110	0.120	0.145	0.165	0.185	0.205	0.240
S1.1.4 Heat-resistant alloys, Ni- or Co-based, hardened, 350 HB	4115	15	0.065	0.075	0.085	0.100	0.115	0.130	0.145	0.170
S1.1.5 Heat-resistant alloys, Ni- or Co-based, cast, 320 HB	4115	20	0.065	0.075	0.085	0.100	0.115	0.130	0.145	0.170
S2.1.1 Titanium alloys, pure titanium, Rm 400 N/mm ²	4115	35	0.115	0.140	0.150	0.180	0.205	0.235	0.260	0.305
S2.1.2 Titanium alloys, Alpha and Beta alloys, hardened, Rm 1050 N/mm ²	4115	25	0.090	0.110	0.120	0.145	0.165	0.185	0.205	0.245
H1.1.1 Hardened steel, hardened and tempered, < 55 HRC	4115	25	0.090	0.110	0.120	0.145	0.165	0.185	0.205	0.240
H1.1.2 Hardened steel, hardened and tempered, < 60 HRC										
H1.1.3 Hardened steel, hardened and tempered, > 60 HRC										
H2.1.1 Chilled cast iron, 400 HB	4115	80	0.225	0.275	0.300	0.360	0.410	0.460	0.510	0.605
H2.1.2 Chilled cast iron, hardened and tempered, < 55 HRC	4115	55	0.160	0.190	0.210	0.250	0.290	0.325	0.360	0.425



Interchangeable inserts HT 800, with tool holder 10xD



Machining group	Art. no.		f (mm/rev) with nom. Ø								
			v _c (m/min)	11	14	16	20	24	28	32	40
P1.1.1 Unalloyed steel, annealed, 0.15 % C, Rm 420 N/mm ² , 125 HB	4112	110	0.215	0.260	0.290	0.340	0.390	0.440	0.490	0.580	
P1.1.2 Unalloyed steel, heat-treated, 0.15 % C, Rm 420 N/mm ² , 125 HB	4112	100	0.195	0.235	0.260	0.305	0.355	0.395	0.440	0.520	
P1.1.3 Unalloyed steel, annealed, 0.45 % C, Rm 640 N/mm ² , 190 HB	4112	100	0.195	0.235	0.260	0.305	0.355	0.395	0.440	0.520	
P1.1.4 Unalloyed steel, heat-treated, 0.45 % C, Rm 640 N/mm ² , 190 HB	4112	95	0.185	0.220	0.245	0.290	0.335	0.375	0.415	0.490	
P1.1.5 Unalloyed steel, heat-treated, 0.45 % C, Rm 850 N/mm ² , 250 HB	4112	95	0.185	0.220	0.245	0.290	0.335	0.375	0.415	0.490	
P1.1.6 Unalloyed steel, annealed, 0.75 % C, Rm 915 N/mm ² , 270 HB	4112	90	0.175	0.210	0.230	0.275	0.315	0.355	0.390	0.465	
P1.1.7 Unalloyed steel, heat-treated, 0.75 % C, Rm 1020 N/mm ² , 300 HB	4112	85	0.165	0.195	0.215	0.255	0.295	0.330	0.365	0.435	
P2.1.1 Low-alloy steel, annealed, Rm 610 N/mm ² , 180 HB	4112	95	0.215	0.260	0.290	0.340	0.390	0.440	0.490	0.580	
P2.1.2 Low-alloy steel, heat-treated, Rm 930 N/mm ² , 275 HB	4112	95	0.215	0.260	0.290	0.340	0.390	0.440	0.490	0.580	
P2.1.3 Low-alloy steel, heat-treated, Rm 1020 N/mm ² , 300 HB	4112	80	0.185	0.220	0.245	0.290	0.335	0.375	0.415	0.490	
P2.1.4 Low-alloy steel, heat-treated, Rm 1190 N/mm ² , 350 HB	4112	70	0.165	0.195	0.215	0.255	0.295	0.330	0.365	0.435	
P3.1.1 High-alloy steel and tool steel, annealed, Rm 680 N/mm ² , 200 HB	4112	50	0.175	0.210	0.230	0.275	0.315	0.355	0.390	0.465	
P3.1.2 High-alloy steel and tool steel, hardened and tempered, Rm 1100 N/mm ² , 325 HB	4112	45	0.145	0.175	0.195	0.230	0.265	0.300	0.330	0.395	
M1.1.1 Stainless steel, ferritic/martensitic, with machining additives	4115	45	0.110	0.130	0.145	0.170	0.200	0.220	0.245	0.290	
M1.1.2 Stainless steel, ferritic/martensitic, annealed, Rm 680 N/mm ² , 200 HB	4115	45	0.100	0.120	0.130	0.155	0.180	0.200	0.220	0.260	
M1.1.3 Stainless steel, ferritic/martensitic, heat-treated, Rm 810 N/mm ² , 240 HB	4115	40	0.095	0.110	0.125	0.145	0.170	0.190	0.210	0.250	
M2.1.1 Stainless steel, austenitic, quenched, 180 HB	4115	35	0.110	0.130	0.145	0.170	0.200	0.220	0.245	0.290	
M2.2.1 Duplex steel, high-strength stainless steels											
K1.1.1 Grey cast iron, pearlitic/ferritic, 180 HB	4113	85	0.215	0.260	0.290	0.340	0.390	0.440	0.490	0.580	
K1.1.2 Grey cast iron, pearlitic/martensitic, 260 HB	4113	75	0.185	0.220	0.245	0.290	0.335	0.375	0.415	0.490	
K1.2.1 Cast iron with spheroidal graphite, ferritic, 160 HB											
K1.2.2 Cast iron with spheroidal graphite, pearlitic, 250 HB	4113	75	0.185	0.220	0.245	0.290	0.335	0.375	0.415	0.490	
K1.3.1 Malleable cast iron, ferritic, 130 HB											
K1.3.2 Malleable cast iron, pearlitic, 230 HB	4113	70	0.175	0.210	0.230	0.275	0.315	0.355	0.390	0.465	
K2.1.1 Vermicular graphite cast iron (GJV)	4113	70	0.175	0.210	0.230	0.275	0.315	0.355	0.390	0.465	
K2.2.1 Austenitic-ferritic spheroidal graphite cast iron (ADI)											
N1.1.1 Wrought aluminium alloys, non-hardened, 60 HB	4114	170	0.275	0.335	0.370	0.435	0.500	0.565	0.625	0.740	
N1.1.2 Wrought aluminium alloys, hardened, 100 HB	4114	170	0.275	0.335	0.370	0.435	0.500	0.565	0.625	0.740	
N2.1.1 Aluminium casting alloys, non-hardened, ≤ 12 % Si, 75 HB	4114	155	0.275	0.335	0.370	0.435	0.500	0.565	0.625	0.740	
N2.1.2 Aluminium casting alloys, hardened, ≤ 12 % Si, 90 HB	4114	155	0.275	0.335	0.370	0.435	0.500	0.565	0.625	0.740	
N2.1.3 Aluminium casting alloys, non-hardened, > 12 % Si, 130 HB	4114	130	0.235	0.285	0.315	0.370	0.425	0.480	0.530	0.630	
N3.1.1 Copper and copper alloys: Free-machining alloy, Pb > 1 %	4114	120	0.215	0.260	0.290	0.340	0.390	0.440	0.490	0.580	
N3.1.2 Copper and copper alloys: CuZn, CuSnZn	4114	100	0.185	0.220	0.245	0.290	0.335	0.375	0.415	0.490	
N3.1.3 Copper and copper alloys: CuSn, lead-free copper and copper electrolyte	4114	95	0.175	0.210	0.230	0.275	0.315	0.355	0.390	0.465	
N4.1.1 Non-metallic materials: Duroplastics, fibre-reinforced plastics											
N4.1.2 Non-metallic materials: Hard rubber, wood, etc.											
N4.1.3 Non-metallic materials: Graphite											
S1.1.1 Heat-resistant alloys, Fe-based, annealed, 200 HB	4115	30	0.085	0.105	0.115	0.135	0.155	0.175	0.195	0.230	
S1.1.2 Heat-resistant alloys, Fe-based, hardened, 280 HB	4115	25	0.070	0.085	0.090	0.110	0.125	0.140	0.155	0.185	
S1.1.3 Heat-resistant alloys, Ni- or Co-based, annealed, 250 HB	4115	25	0.085	0.105	0.115	0.135	0.155	0.175	0.195	0.230	
S1.1.4 Heat-resistant alloys, Ni- or Co-based, hardened, 350 HB	4115	15	0.060	0.075	0.080	0.095	0.110	0.125	0.135	0.160	
S1.1.5 Heat-resistant alloys, Ni- or Co-based, cast, 320 HB	4115	20	0.060	0.075	0.080	0.095	0.110	0.125	0.135	0.160	
S2.1.1 Titanium alloys, pure titanium, Rm 400 N/mm ²	4115	35	0.110	0.130	0.145	0.170	0.200	0.220	0.245	0.290	
S2.1.2 Titanium alloys, Alpha and Beta alloys, hardened, Rm 1050 N/mm ²	4115	25	0.085	0.105	0.115	0.140	0.160	0.180	0.195	0.235	
H1.1.1 Hardened steel, hardened and tempered, < 55 HRC	4115	20	0.085	0.105	0.115	0.135	0.155	0.175	0.195	0.230	
H1.1.2 Hardened steel, hardened and tempered, < 60 HRC											
H1.1.3 Hardened steel, hardened and tempered, > 60 HRC											
H2.1.1 Chilled cast iron, 400 HB	4115	75	0.215	0.260	0.290	0.340	0.390	0.440	0.490	0.580	
H2.1.2 Chilled cast iron, hardened and tempered, < 55 HRC	4115	55	0.150	0.180	0.200	0.240	0.275	0.310	0.340	0.405	



Interchangeable inserts HT 800 steel beams, with tool holder ≤10xD





With tool holders for interchangeable inserts HT 800, 1xD, art. no. 4105 / 1.5xD, art. no. 4106 / 3xD, art. no. 4107 / 5xD, art. no. 4108



Machining group		f (mm/rev) with nom. Ø							
		v _c (m/min)	11	14	16	20	24	28	32
P1.1.1 Unalloyed steel, annealed, 0.15 % C, Rm 420 N/mm ² , 125 HB	100	0.205	0.250	0.275	0.325	0.375	0.420	0.465	0.550
P1.1.2 Unalloyed steel, heat-treated, 0.15 % C, Rm 420 N/mm ² , 125 HB	90	0.185	0.225	0.245	0.295	0.335	0.380	0.420	0.495
P1.1.3 Unalloyed steel, annealed, 0.45 % C, Rm 640 N/mm ² , 190 HB	90	0.185	0.225	0.245	0.295	0.335	0.380	0.420	0.495
P1.1.4 Unalloyed steel, heat-treated, 0.45 % C, Rm 640 N/mm ² , 190 HB	85	0.175	0.210	0.235	0.275	0.315	0.355	0.395	0.470
P1.1.5 Unalloyed steel, heat-treated, 0.45 % C, Rm 850 N/mm ² , 250 HB	85	0.175	0.210	0.235	0.275	0.315	0.355	0.395	0.470
P1.1.6 Unalloyed steel, annealed, 0.75 % C, Rm 915 N/mm ² , 270 HB	80	0.165	0.200	0.220	0.260	0.300	0.335	0.370	0.440
P1.1.7 Unalloyed steel, heat-treated, 0.75 % C, Rm 1020 N/mm ² , 300 HB	75	0.155	0.185	0.205	0.245	0.280	0.315	0.350	0.415

With tool holder for interchangeable inserts HT 800, 7xD, art. no. 4109



Machining group		f (mm/rev) with nom. Ø							
		v _c (m/min)	11	14	16	20	24	28	32
P1.1.1 Unalloyed steel, annealed, 0.15 % C, Rm 420 N/mm ² , 125 HB	90	0.180	0.220	0.240	0.285	0.330	0.370	0.410	0.485
P1.1.2 Unalloyed steel, heat-treated, 0.15 % C, Rm 420 N/mm ² , 125 HB	80	0.165	0.195	0.215	0.260	0.295	0.335	0.370	0.435
P1.1.3 Unalloyed steel, annealed, 0.45 % C, Rm 640 N/mm ² , 190 HB	80	0.165	0.195	0.215	0.260	0.295	0.335	0.370	0.435
P1.1.4 Unalloyed steel, heat-treated, 0.45 % C, Rm 640 N/mm ² , 190 HB	75	0.155	0.185	0.205	0.245	0.280	0.315	0.350	0.410
P1.1.5 Unalloyed steel, heat-treated, 0.45 % C, Rm 850 N/mm ² , 250 HB	75	0.155	0.185	0.205	0.245	0.280	0.315	0.350	0.410
P1.1.6 Unalloyed steel, annealed, 0.75 % C, Rm 915 N/mm ² , 270 HB	70	0.145	0.175	0.195	0.230	0.265	0.295	0.325	0.390
P1.1.7 Unalloyed steel, heat-treated, 0.75 % C, Rm 1020 N/mm ² , 300 HB	70	0.135	0.165	0.180	0.215	0.245	0.275	0.305	0.365

With tool holder for interchangeable inserts HT 800, 10xD, art. no. 4110



Machining group		f (mm/rev) with nom. Ø							
		v _c (m/min)	11	14	16	20	24	28	32
P1.1.1 Unalloyed steel, annealed, 0.15 % C, Rm 420 N/mm ² , 125 HB	85	0.175	0.210	0.230	0.275	0.315	0.355	0.390	0.465
P1.1.2 Unalloyed steel, heat-treated, 0.15 % C, Rm 420 N/mm ² , 125 HB	75	0.155	0.185	0.205	0.245	0.280	0.315	0.350	0.415
P1.1.3 Unalloyed steel, annealed, 0.45 % C, Rm 640 N/mm ² , 190 HB	75	0.155	0.185	0.205	0.245	0.280	0.315	0.350	0.415
P1.1.4 Unalloyed steel, heat-treated, 0.45 % C, Rm 640 N/mm ² , 190 HB	75	0.145	0.175	0.195	0.230	0.265	0.300	0.330	0.395
P1.1.5 Unalloyed steel, heat-treated, 0.45 % C, Rm 850 N/mm ² , 250 HB	75	0.145	0.175	0.195	0.230	0.265	0.300	0.330	0.395
P1.1.6 Unalloyed steel, annealed, 0.75 % C, Rm 915 N/mm ² , 270 HB	70	0.140	0.165	0.185	0.220	0.250	0.280	0.310	0.370
P1.1.7 Unalloyed steel, heat-treated, 0.75 % C, Rm 1020 N/mm ² , 300 HB	65	0.130	0.155	0.175	0.205	0.235	0.265	0.295	0.345



Single-fluted gun drills EB 100 M, EB 100

Correction of length diameter ratio:

< 25xD	100 %	< 45xD	90 %	< 65xD	75 %
< 80xD	60 %	< 150xD	50 %		



Machining group	v _c (m/min)	f (mm/rev) with nom. Ø													
		1	2	3	4	5	6	7	8	10	12	14	16		
P1.1.1 Unalloyed steel, annealed, 0.15 % C, Rm 420 N/mm ² , 125 HB	90	95	0.004	0.010	0.020	0.025	0.030	0.035	0.040	0.040	0.050	0.060	0.065	0.075	
P1.1.2 Unalloyed steel, heat-treated, 0.15 % C, Rm 420 N/mm ² , 125 HB	80	85	0.003	0.009	0.015	0.020	0.025	0.030	0.035	0.040	0.045	0.050	0.060	0.065	
P1.1.3 Unalloyed steel, annealed, 0.45 % C, Rm 640 N/mm ² , 190 HB	80	85	0.003	0.009	0.015	0.020	0.025	0.030	0.035	0.040	0.045	0.050	0.060	0.065	
P1.1.4 Unalloyed steel, heat-treated, 0.45 % C, Rm 640 N/mm ² , 190 HB	75	80	0.003	0.009	0.015	0.020	0.025	0.030	0.030	0.035	0.045	0.050	0.055	0.060	
P1.1.5 Unalloyed steel, heat-treated, 0.45 % C, Rm 850 N/mm ² , 250 HB	75	80	0.003	0.009	0.015	0.020	0.025	0.030	0.030	0.035	0.045	0.050	0.055	0.060	
P1.1.6 Unalloyed steel, annealed, 0.75 % C, Rm 915 N/mm ² , 270 HB	70	75	0.003	0.008	0.015	0.020	0.025	0.025	0.030	0.035	0.040	0.045	0.050	0.060	
P1.1.7 Unalloyed steel, heat-treated, 0.75 % C, Rm 1020 N/mm ² , 300 HB	70	70	0.003	0.008	0.015	0.020	0.020	0.025	0.030	0.030	0.040	0.045	0.050	0.055	
P2.1.1 Low-alloy steel, annealed, Rm 610 N/mm ² , 180 HB	75	80	0.003	0.009	0.015	0.020	0.025	0.030	0.035	0.035	0.045	0.050	0.060	0.065	
P2.1.2 Low-alloy steel, heat-treated, Rm 930 N/mm ² , 275 HB	75	80	0.003	0.009	0.015	0.020	0.025	0.030	0.035	0.035	0.045	0.050	0.060	0.065	
P2.1.3 Low-alloy steel, heat-treated, Rm 1020 N/mm ² , 300 HB	65	65	0.003	0.008	0.015	0.020	0.020	0.025	0.030	0.030	0.035	0.045	0.050	0.055	
P2.1.4 Low-alloy steel, heat-treated, Rm 1190 N/mm ² , 350 HB	55	60	0.002	0.007	0.015	0.015	0.020	0.020	0.025	0.030	0.035	0.040	0.045	0.050	
P3.1.1 High-alloy steel and tool steel, annealed, Rm 680 N/mm ² , 200 HB	60	65	0.003	0.009	0.015	0.020	0.025	0.030	0.035	0.035	0.045	0.050	0.060	0.065	
P3.1.2 High-alloy steel and tool steel, hardened and tempered, Rm 1100 N/mm ² , 325 HB	50	55	0.003	0.008	0.015	0.020	0.020	0.025	0.030	0.030	0.035	0.045	0.050	0.055	
M1.1.1 Stainless steel, ferritic/martensitic, with machining additives	50	55	0.003	0.008	0.015	0.020	0.025	0.025	0.030	0.035	0.040	0.045	0.050	0.060	
M1.1.2 Stainless steel, ferritic/martensitic, annealed, Rm 680 N/mm ² , 200 HB	45	45	0.003	0.007	0.015	0.015	0.020	0.025	0.025	0.030	0.035	0.040	0.045	0.050	
M1.1.3 Stainless steel, ferritic/martensitic, heat-treated, Rm 810 N/mm ² , 240 HB	45	45	0.002	0.007	0.015	0.015	0.020	0.025	0.025	0.030	0.035	0.040	0.045	0.050	
M2.1.1 Stainless steel, austenitic, quenched, 180 HB	40	40	0.002	0.006	0.011	0.015	0.015	0.020	0.025	0.025	0.030	0.035	0.040	0.045	
M2.2.1 Duplex steel, high-strength stainless steels	35	35	0.002	0.005	0.010	0.012	0.015	0.015	0.020	0.020	0.025	0.030	0.035	0.035	
K1.1.1 Grey cast iron, pearlitic/ferritic, 180 HB	80	85	0.006	0.015	0.030	0.040	0.045	0.055	0.060	0.065	0.080	0.095	0.105	0.115	
K1.1.2 Grey cast iron, pearlitic/martensitic, 260 HB	70	70	0.005	0.015	0.025	0.035	0.040	0.045	0.050	0.055	0.070	0.080	0.090	0.100	
K1.2.1 Cast iron with spheroidal graphite, ferritic, 160 HB	70	70	0.005	0.015	0.025	0.035	0.040	0.045	0.050	0.055	0.070	0.080	0.090	0.100	
K1.2.2 Cast iron with spheroidal graphite, pearlitic, 250 HB	65	65	0.005	0.015	0.025	0.030	0.035	0.045	0.050	0.055	0.065	0.075	0.085	0.095	
K1.3.1 Malleable cast iron, ferritic, 130 HB	65	65	0.005	0.015	0.025	0.030	0.035	0.045	0.050	0.055	0.065	0.075	0.085	0.095	
K1.3.2 Malleable cast iron, pearlitic, 230 HB	55	60	0.004	0.012	0.020	0.025	0.030	0.035	0.040	0.045	0.055	0.065	0.075	0.080	
K2.1.1 Vermicular graphite cast iron (GJV)	65	70	0.004	0.012	0.025	0.030	0.035	0.040	0.045	0.050	0.060	0.070	0.080	0.085	
K2.2.1 Austenitic-ferritic spheroidal graphite cast iron (ADI)	50	50	0.003	0.009	0.015	0.020	0.025	0.030	0.035	0.040	0.045	0.050	0.060	0.065	
N1.1.1 Wrought aluminium alloys, non-hardened, 60 HB	100	105	0.006	0.015	0.030	0.040	0.045	0.055	0.060	0.065	0.080	0.095	0.105	0.115	
N1.1.2 Wrought aluminium alloys, hardened, 100 HB	100	105	0.006	0.015	0.030	0.040	0.045	0.055	0.060	0.065	0.080	0.095	0.105	0.115	
N2.1.1 Aluminium casting alloys, non-hardened, ≤ 12 % Si, 75 HB	160	170	0.025	0.075	0.135	0.170	0.200	0.235	0.265	0.295	0.350	0.405	0.460	0.510	
N2.1.2 Aluminium casting alloys, hardened, ≤ 12 % Si, 90 HB	160	170	0.025	0.075	0.135	0.170	0.200	0.235	0.265	0.295	0.350	0.405	0.460	0.510	
N2.1.3 Aluminium casting alloys, non-hardened, > 12 % Si, 130 HB	135	145	0.020	0.060	0.115	0.145	0.170	0.200	0.225	0.250	0.295	0.345	0.390	0.435	
N3.1.1 Copper and copper alloys: Free-machining alloy, Pb > 1 %	80	85	0.008	0.025	0.045	0.055	0.065	0.075	0.085	0.095	0.115	0.135	0.150	0.165	
N3.1.2 Copper and copper alloys: CuZn, CuSnZn	70	70	0.007	0.020	0.035	0.045	0.055	0.065	0.075	0.080	0.100	0.115	0.130	0.140	
N3.1.3 Copper and copper alloys: CuSn, lead-free copper and copper electrolyte	65	65	0.007	0.020	0.035	0.045	0.055	0.060	0.070	0.075	0.090	0.105	0.120	0.135	
N4.1.1 Non-metallic materials: Duroplastics, fibre-reinforced plastics	60	65	0.006	0.015	0.030	0.040	0.045	0.055	0.060	0.065	0.080	0.095	0.105	0.115	
N4.1.2 Non-metallic materials: Hard rubber, wood, etc.	60	65	0.006	0.015	0.030	0.040	0.045	0.055	0.060	0.065	0.080	0.095	0.105	0.115	
N4.1.3 Non-metallic materials: Graphite	60	65	0.006	0.015	0.030	0.040	0.045	0.055	0.060	0.065	0.080	0.095	0.105	0.115	
S1.1.1 Heat-resistant alloys, Fe-based, annealed, 200 HB	40	40	0.002	0.005	0.010	0.012	0.015	0.015	0.020	0.020	0.025	0.030	0.035	0.035	
S1.1.2 Heat-resistant alloys, Fe-based, hardened, 280 HB	30	35	0.002	0.004	0.008	0.010	0.012	0.015	0.015	0.020	0.020	0.025	0.030	0.030	
S1.1.3 Heat-resistant alloys, Ni- or Co-based, annealed, 250 HB	25	25	0.001	0.004	0.007	0.009	0.011	0.012	0.015	0.015	0.020	0.020	0.025	0.025	
S1.1.4 Heat-resistant alloys, Ni- or Co-based, hardened, 350 HB	20	25	0.001	0.004	0.007	0.008	0.010	0.012	0.015	0.015	0.020	0.020	0.025	0.025	
S1.1.5 Heat-resistant alloys, Ni- or Co-based, cast, 320 HB	20	20	0.001	0.003	0.006	0.008	0.009	0.011	0.012	0.015	0.015	0.020	0.020	0.025	
S2.1.1 Titanium alloys, pure titanium, Rm 400 N/mm ²	30	30	0.001	0.004	0.008	0.010	0.011	0.015	0.015	0.015	0.020	0.025	0.025	0.030	
S2.1.2 Titanium alloys, Alpha and Beta alloys, hardened, Rm 1050 N/mm ²	25	30	0.001	0.004	0.007	0.009	0.010	0.012	0.015	0.015	0.020	0.020	0.025	0.025	
H1.1.1 Hardened steel, hardened and tempered, < 55 HRC	30	30	0.002	0.005	0.010	0.012	0.015	0.015	0.020	0.020	0.025	0.030	0.035	0.035	
H1.1.2 Hardened steel, hardened and tempered, < 60 HRC	20	20	0.001	0.004	0.008	0.010	0.011	0.015	0.015	0.015	0.020	0.025	0.025	0.030	
H1.1.3 Hardened steel, hardened and tempered, > 60 HRC	20	20	0.001	0.004	0.007	0.009	0.011	0.012	0.015	0.015	0.020	0.020	0.025	0.025	
H2.1.1 Chilled cast iron, 400 HB	20	20	0.001	0.004	0.008	0.010	0.011	0.015	0.015	0.015	0.020	0.025	0.025	0.030	
H2.1.2 Chilled cast iron, hardened and tempered, < 55 HRC	15	15	0.001	0.003	0.005	0.007	0.008	0.009	0.011	0.012	0.015	0.015	0.020	0.020	



Single-fluted gun drills EB 80, EB 80 XXL



Machining group	○	Ⓢ ⓐ	f (mm/rev) with nom. Ø								
	v _c (m/min)		4	8	10	12	14	16	20	25	32
P1.1.1 Unalloyed steel, annealed, 0.15 % C, Rm 420 N/mm ² , 125 HB	80	85	0.020	0.040	0.045	0.050	0.060	0.065	0.080	0.095	0.110
P1.1.2 Unalloyed steel, heat-treated, 0.15 % C, Rm 420 N/mm ² , 125 HB	70	75	0.020	0.035	0.040	0.045	0.055	0.060	0.070	0.085	0.100
P1.1.3 Unalloyed steel, annealed, 0.45 % C, Rm 640 N/mm ² , 190 HB	70	75	0.020	0.035	0.040	0.045	0.055	0.060	0.070	0.085	0.100
P1.1.4 Unalloyed steel, heat-treated, 0.45 % C, Rm 640 N/mm ² , 190 HB	70	70	0.020	0.030	0.040	0.045	0.050	0.055	0.065	0.080	0.095
P1.1.5 Unalloyed steel, heat-treated, 0.45 % C, Rm 850 N/mm ² , 250 HB	70	70	0.020	0.030	0.040	0.045	0.050	0.055	0.065	0.080	0.095
P1.1.6 Unalloyed steel, annealed, 0.75 % C, Rm 915 N/mm ² , 270 HB	65	65	0.015	0.030	0.035	0.040	0.045	0.050	0.065	0.075	0.090
P1.1.7 Unalloyed steel, heat-treated, 0.75 % C, Rm 1020 N/mm ² , 300 HB	60	65	0.015	0.030	0.035	0.040	0.045	0.050	0.060	0.070	0.085
P2.1.1 Low-alloy steel, annealed, Rm 610 N/mm ² , 180 HB	70	75	0.020	0.035	0.040	0.045	0.050	0.060	0.070	0.085	0.100
P2.1.2 Low-alloy steel, heat-treated, Rm 930 N/mm ² , 275 HB	70	75	0.020	0.035	0.040	0.045	0.050	0.060	0.070	0.085	0.100
P2.1.3 Low-alloy steel, heat-treated, Rm 1020 N/mm ² , 300 HB	60	60	0.015	0.030	0.035	0.040	0.045	0.050	0.060	0.070	0.085
P2.1.4 Low-alloy steel, heat-treated, Rm 1190 N/mm ² , 350 HB	55	55	0.015	0.025	0.030	0.035	0.040	0.045	0.050	0.060	0.075
P3.1.1 High-alloy steel and tool steel, annealed, Rm 680 N/mm ² , 200 HB	60	65	0.020	0.035	0.040	0.045	0.050	0.060	0.070	0.085	0.100
P3.1.2 High-alloy steel and tool steel, hardened and tempered, Rm 1100 N/mm ² , 325 HB	50	55	0.015	0.030	0.035	0.040	0.045	0.050	0.060	0.070	0.085
M1.1.1 Stainless steel, ferritic/martensitic, with machining additives	50	55	0.015	0.025	0.030	0.035	0.040	0.045	0.050	0.060	0.075
M1.1.2 Stainless steel, ferritic/martensitic, annealed, Rm 680 N/mm ² , 200 HB	45	45	0.015	0.025	0.025	0.030	0.035	0.040	0.045	0.055	0.065
M1.1.3 Stainless steel, ferritic/martensitic, heat-treated, Rm 810 N/mm ² , 240 HB	45	45	0.012	0.020	0.025	0.030	0.035	0.035	0.045	0.055	0.060
M2.1.1 Stainless steel, austenitic, quenched, 180 HB	40	40	0.012	0.020	0.025	0.030	0.035	0.035	0.045	0.050	0.060
M2.2.1 Duplex steel, high-strength stainless steels	35	35	0.010	0.020	0.020	0.025	0.030	0.030	0.035	0.045	0.050
K1.1.1 Grey cast iron, pearlitic/ferritic, 180 HB	80	85	0.030	0.050	0.060	0.070	0.080	0.085	0.105	0.125	0.145
K1.1.2 Grey cast iron, pearlitic/martensitic, 260 HB	70	70	0.025	0.045	0.050	0.060	0.065	0.075	0.090	0.105	0.125
K1.2.1 Cast iron with spheroidal graphite, ferritic, 160 HB	70	70	0.025	0.045	0.050	0.060	0.065	0.075	0.090	0.105	0.125
K1.2.2 Cast iron with spheroidal graphite, pearlitic, 250 HB	65	65	0.025	0.040	0.050	0.055	0.065	0.070	0.085	0.100	0.115
K1.3.1 Malleable cast iron, ferritic, 130 HB	65	65	0.025	0.040	0.050	0.055	0.065	0.070	0.085	0.100	0.115
K1.3.2 Malleable cast iron, pearlitic, 230 HB	55	60	0.020	0.035	0.040	0.050	0.055	0.060	0.075	0.085	0.105
K2.1.1 Vermicular graphite cast iron (GJV)	65	70	0.025	0.040	0.050	0.060	0.065	0.075	0.085	0.105	0.120
K2.2.1 Austenitic-ferritic spheroidal graphite cast iron (ADI)	50	50	0.020	0.030	0.040	0.045	0.050	0.055	0.065	0.080	0.090
N1.1.1 Wrought aluminium alloys, non-hardened, 60 HB	80	85	0.035	0.060	0.070	0.080	0.090	0.100	0.120	0.145	0.170
N1.1.2 Wrought aluminium alloys, hardened, 100 HB	80	85	0.035	0.060	0.070	0.080	0.090	0.100	0.120	0.145	0.170
N2.1.1 Aluminium casting alloys, non-hardened, ≤ 12 % Si, 75 HB	120	125	0.095	0.165	0.200	0.230	0.260	0.290	0.350	0.415	0.490
N2.1.2 Aluminium casting alloys, hardened, ≤ 12 % Si, 90 HB	120	125	0.095	0.165	0.200	0.230	0.260	0.290	0.350	0.415	0.490
N2.1.3 Aluminium casting alloys, non-hardened, > 12 % Si, 130 HB	100	105	0.080	0.140	0.170	0.195	0.225	0.250	0.295	0.355	0.415
N3.1.1 Copper and copper alloys: Free-machining alloy, Pb > 1 %	70	75	0.040	0.065	0.080	0.095	0.105	0.115	0.140	0.165	0.195
N3.1.2 Copper and copper alloys: CuZn, CuSnZn	60	60	0.035	0.055	0.070	0.080	0.090	0.100	0.120	0.140	0.165
N3.1.3 Copper and copper alloys: CuSn, lead-free copper and copper electrolyte	55	60	0.030	0.055	0.065	0.075	0.085	0.095	0.110	0.135	0.155
N4.1.1 Non-metallic materials: Duroplastics, fibre-reinforced plastics	60	65	0.025	0.040	0.050	0.060	0.065	0.075	0.085	0.105	0.120
N4.1.2 Non-metallic materials: Hard rubber, wood, etc.	60	65	0.025	0.040	0.050	0.060	0.065	0.075	0.085	0.105	0.120
N4.1.3 Non-metallic materials: Graphite	60	65	0.025	0.040	0.050	0.060	0.065	0.075	0.085	0.105	0.120
S1.1.1 Heat-resistant alloys, Fe-based, annealed, 200 HB	40	40	0.010	0.015	0.020	0.025	0.025	0.030	0.035	0.040	0.050
S1.1.2 Heat-resistant alloys, Fe-based, hardened, 280 HB	30	35	0.008	0.015	0.015	0.020	0.020	0.025	0.030	0.035	0.040
S1.1.3 Heat-resistant alloys, Ni- or Co-based, annealed, 250 HB	25	25	0.007	0.015	0.015	0.015	0.020	0.020	0.025	0.030	0.035
S1.1.4 Heat-resistant alloys, Ni- or Co-based, hardened, 350 HB	20	25	0.007	0.012	0.015	0.015	0.020	0.020	0.025	0.030	0.035
S1.1.5 Heat-resistant alloys, Ni- or Co-based, cast, 320 HB	20	20	0.006	0.011	0.015	0.015	0.015	0.020	0.025	0.025	0.030
S2.1.1 Titanium alloys, pure titanium, Rm 400 N/mm ²	30	30	0.007	0.015	0.015	0.015	0.020	0.020	0.025	0.030	0.035
S2.1.2 Titanium alloys, Alpha and Beta alloys, hardened, Rm 1050 N/mm ²	25	30	0.006	0.011	0.015	0.015	0.020	0.020	0.025	0.030	0.035
H1.1.1 Hardened steel, hardened and tempered, < 55 HRC	30	30	0.007	0.015	0.015	0.015	0.020	0.020	0.025	0.030	0.035
H1.1.2 Hardened steel, hardened and tempered, < 60 HRC	20	20	0.006	0.010	0.012	0.015	0.015	0.015	0.020	0.025	0.030
H1.1.3 Hardened steel, hardened and tempered, > 60 HRC	20	20	0.005	0.009	0.011	0.015	0.015	0.015	0.020	0.025	0.030
H2.1.1 Chilled cast iron, 400 HB	20	20	0.007	0.015	0.015	0.015	0.020	0.020	0.025	0.030	0.035
H2.1.2 Chilled cast iron, hardened and tempered, < 55 HRC	15	15	0.005	0.009	0.011	0.012	0.015	0.015	0.020	0.020	0.025



EB 800 single-fluted gun drills with indexable inserts



Machining group	S Y F A				f (mm/rev) with nom. Ø			
	v _c (m/min)	12	14	16	18	20	25	32
P1.1.1 Unalloyed steel, annealed, 0.15 % C, Rm 420 N/mm ² , 125 HB	80	0.065	0.070	0.080	0.090	0.095	0.115	0.135
P1.1.2 Unalloyed steel, heat-treated, 0.15 % C, Rm 420 N/mm ² , 125 HB	70	0.055	0.065	0.070	0.080	0.085	0.105	0.120
P1.1.3 Unalloyed steel, annealed, 0.45 % C, Rm 640 N/mm ² , 190 HB	70	0.055	0.065	0.070	0.080	0.085	0.105	0.120
P1.1.4 Unalloyed steel, heat-treated, 0.45 % C, Rm 640 N/mm ² , 190 HB	70	0.055	0.060	0.070	0.075	0.080	0.095	0.115
P1.1.5 Unalloyed steel, heat-treated, 0.45 % C, Rm 850 N/mm ² , 250 HB	70	0.055	0.060	0.070	0.075	0.080	0.095	0.115
P1.1.6 Unalloyed steel, annealed, 0.75 % C, Rm 915 N/mm ² , 270 HB	65	0.050	0.060	0.065	0.070	0.075	0.090	0.110
P1.1.7 Unalloyed steel, heat-treated, 0.75 % C, Rm 1020 N/mm ² , 300 HB	60	0.050	0.055	0.060	0.065	0.070	0.085	0.100
P2.1.1 Low-alloy steel, annealed, Rm 610 N/mm ² , 180 HB	70	0.580	0.655	0.730	0.800	0.870	1.040	1.225
P2.1.2 Low-alloy steel, heat-treated, Rm 930 N/mm ² , 275 HB	70	0.580	0.655	0.730	0.800	0.870	1.040	1.225
P2.1.3 Low-alloy steel, heat-treated, Rm 1020 N/mm ² , 300 HB	60	0.490	0.555	0.620	0.680	0.740	0.885	1.040
P2.1.4 Low-alloy steel, heat-treated, Rm 1190 N/mm ² , 350 HB	55	0.435	0.490	0.545	0.600	0.655	0.780	0.915
P3.1.1 High-alloy steel and tool steel, annealed, Rm 680 N/mm ² , 200 HB	60	0.050	0.060	0.065	0.070	0.080	0.095	0.110
P3.1.2 High-alloy steel and tool steel, hardened and tempered, Rm 1100 N/mm ² , 325 HB	50	0.045	0.050	0.055	0.060	0.065	0.080	0.095
M1.1.1 Stainless steel, ferritic/martensitic, with machining additives	50	0.045	0.050	0.060	0.065	0.070	0.085	0.100
M1.1.2 Stainless steel, ferritic/martensitic, annealed, Rm 680 N/mm ² , 200 HB	45	0.040	0.045	0.050	0.060	0.065	0.075	0.090
M1.1.3 Stainless steel, ferritic/martensitic, heat-treated, Rm 810 N/mm ² , 240 HB	45	0.040	0.045	0.050	0.055	0.060	0.070	0.085
M2.1.1 Stainless steel, austenitic, quenched, 180 HB	40	0.040	0.045	0.050	0.055	0.060	0.075	0.085
M2.2.1 Duplex steel, high-strength stainless steels	35	0.035	0.040	0.045	0.050	0.050	0.060	0.075
K1.1.1 Grey cast iron, pearlitic/ferritic, 180 HB	80	0.080	0.090	0.100	0.110	0.120	0.145	0.170
K1.1.2 Grey cast iron, pearlitic/martensitic, 260 HB	70	0.070	0.080	0.085	0.095	0.105	0.125	0.145
K1.2.1 Cast iron with spheroidal graphite, ferritic, 160 HB	70	0.070	0.080	0.085	0.095	0.105	0.125	0.145
K1.2.2 Cast iron with spheroidal graphite, pearlitic, 250 HB	65	0.065	0.075	0.080	0.090	0.100	0.115	0.135
K1.3.1 Malleable cast iron, ferritic, 130 HB	65	0.065	0.075	0.080	0.090	0.100	0.115	0.135
K1.3.2 Malleable cast iron, pearlitic, 230 HB	55	0.055	0.065	0.070	0.080	0.085	0.100	0.120
K2.1.1 Vermicular graphite cast iron (GJV)	65	0.070	0.080	0.085	0.095	0.105	0.125	0.145
K2.2.1 Austenitic-ferritic spheroidal graphite cast iron (ADI)	50	0.050	0.060	0.065	0.070	0.080	0.095	0.110
N1.1.1 Wrought aluminium alloys, non-hardened, 60 HB	80	0.100	0.110	0.125	0.135	0.150	0.175	0.210
N1.1.2 Wrought aluminium alloys, hardened, 100 HB	80	0.100	0.110	0.125	0.135	0.150	0.175	0.210
N2.1.1 Aluminium casting alloys, non-hardened, ≤ 12 % Si, 75 HB	120	0.175	0.195	0.220	0.240	0.260	0.310	0.365
N2.1.2 Aluminium casting alloys, hardened, ≤ 12 % Si, 90 HB	120	0.175	0.195	0.220	0.240	0.260	0.310	0.365
N2.1.3 Aluminium casting alloys, non-hardened, > 12 % Si, 130 HB	100	0.150	0.165	0.185	0.205	0.220	0.265	0.310
N3.1.1 Copper and copper alloys: Free-machining alloy, Pb > 1 %	70	0.095	0.105	0.115	0.130	0.140	0.165	0.195
N3.1.2 Copper and copper alloys: CuZn, CuSnZn	60	0.080	0.090	0.100	0.110	0.120	0.140	0.165
N3.1.3 Copper and copper alloys: CuSn, lead-free copper and copper electrolyte	55	0.075	0.085	0.095	0.100	0.110	0.135	0.155
N4.1.1 Non-metallic materials: Duroplastics, fibre-reinforced plastics	60	0.070	0.080	0.085	0.095	0.105	0.125	0.145
N4.1.2 Non-metallic materials: Hard rubber, wood, etc.	60	0.070	0.080	0.085	0.095	0.105	0.125	0.145
N4.1.3 Non-metallic materials: Graphite	60	0.070	0.080	0.085	0.095	0.105	0.125	0.145
S1.1.1 Heat-resistant alloys, Fe-based, annealed, 200 HB	40	0.035	0.040	0.045	0.050	0.050	0.060	0.075
S1.1.2 Heat-resistant alloys, Fe-based, hardened, 280 HB	30	0.030	0.035	0.035	0.040	0.045	0.055	0.060
S1.1.3 Heat-resistant alloys, Ni- or Co-based, annealed, 250 HB	25	0.025	0.030	0.035	0.035	0.040	0.045	0.055
S1.1.4 Heat-resistant alloys, Ni- or Co-based, hardened, 350 HB	20	0.025	0.025	0.030	0.035	0.035	0.045	0.050
S1.1.5 Heat-resistant alloys, Ni- or Co-based, cast, 320 HB	20	0.025	0.025	0.030	0.030	0.035	0.040	0.050
S2.1.1 Titanium alloys, pure titanium, Rm 400 N/mm ²	30	0.030	0.035	0.035	0.040	0.045	0.050	0.060
S2.1.2 Titanium alloys, Alpha and Beta alloys, hardened, Rm 1050 N/mm ²	25	0.025	0.030	0.035	0.035	0.040	0.045	0.055
H1.1.1 Hardened steel, hardened and tempered, < 55 HRC	30	0.030	0.035	0.035	0.040	0.045	0.050	0.060
H1.1.2 Hardened steel, hardened and tempered, < 60 HRC	20	0.025	0.025	0.030	0.030	0.035	0.040	0.050
H1.1.3 Hardened steel, hardened and tempered, > 60 HRC	20	0.020	0.025	0.025	0.030	0.035	0.040	0.045
H2.1.1 Chilled cast iron, 400 HB	20	0.030	0.035	0.035	0.040	0.045	0.050	0.060
H2.1.2 Chilled cast iron, hardened and tempered, < 55 HRC	15	0.020	0.025	0.025	0.030	0.030	0.035	0.045



Twist drills with standard shank, GU 500 PM



Machining group	HSS-E-PM	f (mm/rev) with nom. Ø									
	F										
	v _c (m/min)	1	3	5	8	10	12	14	16	20	
P1.1.1 Unalloyed steel, annealed, 0.15 % C, Rm 420 N/mm ² , 125 HB	51	0.040	0.120	0.175	0.255	0.300	0.345	0.385	0.430	0.510	
P1.1.2 Unalloyed steel, heat-treated, 0.15 % C, Rm 420 N/mm ² , 125 HB	44	0.032	0.096	0.140	0.200	0.240	0.275	0.310	0.345	0.405	
P1.1.3 Unalloyed steel, annealed, 0.45 % C, Rm 640 N/mm ² , 190 HB	44	0.032	0.096	0.140	0.200	0.240	0.275	0.310	0.345	0.405	
P1.1.4 Unalloyed steel, heat-treated, 0.45 % C, Rm 640 N/mm ² , 190 HB	44	0.032	0.096	0.140	0.200	0.240	0.275	0.310	0.345	0.405	
P1.1.5 Unalloyed steel, heat-treated, 0.45 % C, Rm 850 N/mm ² , 250 HB	38	0.032	0.096	0.140	0.200	0.240	0.275	0.310	0.345	0.405	
P1.1.6 Unalloyed steel, annealed, 0.75 % C, Rm 915 N/mm ² , 270 HB	36	0.032	0.096	0.140	0.200	0.240	0.275	0.310	0.345	0.405	
P1.1.7 Unalloyed steel, heat-treated, 0.75 % C, Rm 1020 N/mm ² , 300 HB	31	0.032	0.096	0.140	0.200	0.240	0.275	0.310	0.345	0.405	
P2.1.1 Low-alloy steel, annealed, Rm 610 N/mm ² , 180 HB	38	0.032	0.096	0.140	0.200	0.240	0.275	0.310	0.345	0.405	
P2.1.2 Low-alloy steel, heat-treated, Rm 930 N/mm ² , 275 HB	27	0.026	0.077	0.115	0.160	0.190	0.220	0.250	0.275	0.325	
P2.1.3 Low-alloy steel, heat-treated, Rm 1020 N/mm ² , 300 HB	23	0.026	0.077	0.115	0.160	0.190	0.220	0.250	0.275	0.325	
P2.1.4 Low-alloy steel, heat-treated, Rm 1190 N/mm ² , 350 HB	21	0.020	0.060	0.090	0.125	0.150	0.175	0.195	0.215	0.255	
P3.1.1 High-alloy steel and tool steel, annealed, Rm 680 N/mm ² , 200 HB	19	0.026	0.077	0.115	0.160	0.190	0.220	0.250	0.275	0.325	
P3.1.2 High-alloy steel and tool steel, hardened and tempered, Rm 1100 N/mm ² , 325 HB	14	0.020	0.061	0.090	0.130	0.155	0.175	0.200	0.220	0.260	
M1.1.1 Stainless steel, ferritic/martensitic, with machining additives	22	0.020	0.061	0.090	0.130	0.150	0.175	0.195	0.215	0.255	
M1.1.2 Stainless steel, ferritic/martensitic, annealed, Rm 680 N/mm ² , 200 HB	20	0.020	0.061	0.090	0.130	0.150	0.175	0.195	0.215	0.255	
M1.1.3 Stainless steel, ferritic/martensitic, heat-treated, Rm 810 N/mm ² , 240 HB	19	0.016	0.048	0.070	0.100	0.120	0.140	0.155	0.175	0.205	
M2.1.1 Stainless steel, austenitic, quenched, 180 HB	16	0.020	0.061	0.090	0.130	0.150	0.175	0.195	0.215	0.255	
M2.2.1 Duplex steel, high-strength stainless steels	11	0.016	0.048	0.070	0.100	0.120	0.140	0.155	0.175	0.205	
K1.1.1 Grey cast iron, pearlitic/ferritic, 180 HB	45	0.040	0.120	0.175	0.255	0.300	0.345	0.385	0.430	0.510	
K1.1.2 Grey cast iron, pearlitic/martensitic, 260 HB	36	0.040	0.120	0.175	0.255	0.300	0.345	0.385	0.430	0.510	
K1.2.1 Cast iron with spheroidal graphite, ferritic, 160 HB	39	0.040	0.120	0.175	0.255	0.300	0.345	0.385	0.430	0.510	
K1.2.2 Cast iron with spheroidal graphite, pearlitic, 250 HB	29	0.032	0.096	0.140	0.200	0.240	0.275	0.310	0.345	0.405	
K1.3.1 Malleable cast iron, ferritic, 130 HB	39	0.040	0.120	0.175	0.255	0.300	0.345	0.385	0.430	0.510	
K1.3.2 Malleable cast iron, pearlitic, 230 HB	29	0.032	0.096	0.140	0.200	0.240	0.275	0.310	0.345	0.405	
K2.1.1 Vermicular graphite cast iron (GJV)	32	0.032	0.096	0.140	0.200	0.240	0.275	0.310	0.345	0.405	
K2.2.1 Austenitic-ferritic spheroidal graphite cast iron (ADI)	16	0.016	0.048	0.070	0.100	0.120	0.140	0.155	0.170	0.205	
N1.1.1 Wrought aluminium alloys, non-hardened, 60 HB											
N1.1.2 Wrought aluminium alloys, hardened, 100 HB											
N2.1.1 Aluminium casting alloys, non-hardened, ≤ 12 % Si, 75 HB	83	0.040	0.120	0.175	0.255	0.300	0.345	0.385	0.430	0.510	
N2.1.2 Aluminium casting alloys, hardened, ≤ 12 % Si, 90 HB	67	0.032	0.096	0.140	0.200	0.240	0.275	0.310	0.345	0.405	
N2.1.3 Aluminium casting alloys, non-hardened, > 12 % Si, 130 HB	58	0.032	0.096	0.140	0.200	0.240	0.275	0.310	0.345	0.405	
N3.1.1 Copper and copper alloys: Free-machining alloy, Pb > 1 %	76	0.032	0.096	0.140	0.200	0.240	0.275	0.310	0.345	0.405	
N3.1.2 Copper and copper alloys: CuZn, CuSnZn	46	0.026	0.077	0.115	0.160	0.190	0.220	0.250	0.275	0.325	
N3.1.3 Copper and copper alloys: CuSn, lead-free copper and copper electrolyte	61	0.026	0.077	0.115	0.160	0.190	0.220	0.250	0.275	0.325	
N4.1.1 Non-metallic materials: Duroplastics, fibre-reinforced plastics	32	0.026	0.077	0.115	0.160	0.190	0.220	0.250	0.275	0.325	
N4.1.2 Non-metallic materials: Hard rubber, wood, etc.	32	0.026	0.077	0.115	0.160	0.190	0.220	0.250	0.275	0.325	
N4.1.3 Non-metallic materials: Graphite											
S1.1.1 Heat-resistant alloys, Fe-based, annealed, 200 HB											
S1.1.2 Heat-resistant alloys, Fe-based, hardened, 280 HB											
S1.1.3 Heat-resistant alloys, Ni- or Co-based, annealed, 250 HB											
S1.1.4 Heat-resistant alloys, Ni- or Co-based, hardened, 350 HB											
S1.1.5 Heat-resistant alloys, Ni- or Co-based, cast, 320 HB											
S2.1.1 Titanium alloys, pure titanium, Rm 400 N/mm ²	10	0.016	0.048	0.070	0.100	0.120	0.140	0.155	0.170	0.205	
S2.1.2 Titanium alloys, Alpha and Beta alloys, hardened, Rm 1050 N/mm ²	7	0.013	0.038	0.055	0.080	0.095	0.110	0.125	0.135	0.160	
H1.1.1 Hardened steel, hardened and tempered, < 55 HRC											
H1.1.2 Hardened steel, hardened and tempered, < 60 HRC											
H1.1.3 Hardened steel, hardened and tempered, > 60 HRC											
H2.1.1 Chilled cast iron, 400 HB											
H2.1.2 Chilled cast iron, hardened and tempered, < 55 HRC											



Stub drills/Jobber drills, type N, bright/steam tempered and TiN



Machining group	HSS		HSCO		M42	f (mm/rev) with nom. Ø														
	○	Ⓢ	○	Ⓢ	○	v _c (m/min)					0.5	3	5	8	12	20	30	40	50	
P1.1.1 Unalloyed steel, annealed, 0.15 % C, Rm 420 N/mm ² , 125 HB	28	32	32	37	32	0.016	0.096	0.140	0.200	0.275	0.405	0.555	0.690	0.815						
P1.1.2 Unalloyed steel, heat-treated, 0.15 % C, Rm 420 N/mm ² , 125 HB	24	27	27	31	27	0.013	0.077	0.115	0.160	0.220	0.325	0.440	0.550	0.650						
P1.1.3 Unalloyed steel, annealed, 0.45 % C, Rm 640 N/mm ² , 190 HB	24	27	27	31	27	0.013	0.077	0.115	0.160	0.220	0.325	0.440	0.550	0.650						
P1.1.4 Unalloyed steel, heat-treated, 0.45 % C, Rm 640 N/mm ² , 190 HB	24	27	27	31	27	0.013	0.077	0.115	0.160	0.220	0.325	0.440	0.550	0.650						
P1.1.5 Unalloyed steel, heat-treated, 0.45 % C, Rm 850 N/mm ² , 250 HB	21	24	24	28	24	0.013	0.077	0.115	0.160	0.220	0.325	0.440	0.550	0.650						
P1.1.6 Unalloyed steel, annealed, 0.75 % C, Rm 915 N/mm ² , 270 HB	20	23	23	26	23	0.013	0.077	0.115	0.160	0.220	0.325	0.440	0.550	0.650						
P1.1.7 Unalloyed steel, heat-treated, 0.75 % C, Rm 1020 N/mm ² , 300 HB	17	19	19	22	19	0.013	0.077	0.115	0.160	0.220	0.325	0.440	0.550	0.650						
P2.1.1 Low-alloy steel, annealed, Rm 610 N/mm ² , 180 HB	17	20	20	22	20	0.010	0.061	0.090	0.130	0.175	0.260	0.355	0.440	0.520						
P2.1.2 Low-alloy steel, heat-treated, Rm 930 N/mm ² , 275 HB	12	14	14	16	14	0.008	0.049	0.070	0.105	0.140	0.210	0.285	0.350	0.415						
P2.1.3 Low-alloy steel, heat-treated, Rm 1020 N/mm ² , 300 HB	10	12	12	13	12	0.008	0.049	0.070	0.105	0.140	0.210	0.285	0.350	0.415						
P2.1.4 Low-alloy steel, heat-treated, Rm 1190 N/mm ² , 350 HB	9	11	11	12	11	0.006	0.039	0.055	0.080	0.110	0.165	0.225	0.275	0.330						
P3.1.1 High-alloy steel and tool steel, annealed, Rm 680 N/mm ² , 200 HB	13	15	15	17	15	0.010	0.061	0.090	0.130	0.175	0.260	0.355	0.440	0.520						
P3.1.2 High-alloy steel and tool steel, hardened and tempered, Rm 1100 N/mm ² , 325 HB			11	13	11	0.008	0.049	0.070	0.105	0.140	0.210	0.285	0.350	0.415						
M1.1.1 Stainless steel, ferritic/martensitic, with machining additives			12	13	12	0.008	0.048	0.070	0.100	0.140	0.205	0.280	0.345	0.410						
M1.1.2 Stainless steel, ferritic/martensitic, annealed, Rm 680 N/mm ² , 200 HB			10	12	10	0.008	0.048	0.070	0.100	0.140	0.205	0.280	0.345	0.410						
M1.1.3 Stainless steel, ferritic/martensitic, heat-treated, Rm 810 N/mm ² , 240 HB			10	11	10	0.006	0.039	0.055	0.080	0.110	0.165	0.225	0.275	0.330						
M2.1.1 Stainless steel, austenitic, quenched, 180 HB			9	11	9	0.008	0.048	0.070	0.100	0.140	0.205	0.280	0.345	0.410						
M2.2.1 Duplex steel, high-strength stainless steels			7	6	6	0.006	0.039	0.055	0.080	0.110	0.165	0.225	0.275	0.330						
K1.1.1 Grey cast iron, pearlitic/ferritic, 180 HB	30	35	35	40	35	0.016	0.096	0.140	0.200	0.275	0.405	0.555	0.690	0.815						
K1.1.2 Grey cast iron, pearlitic/martensitic, 260 HB	24	28	28	32	28	0.016	0.096	0.140	0.200	0.275	0.405	0.555	0.690	0.815						
K1.2.1 Cast iron with spheroidal graphite, ferritic, 160 HB	26	29	29	34	29	0.016	0.096	0.140	0.200	0.275	0.405	0.555	0.690	0.815						
K1.2.2 Cast iron with spheroidal graphite, pearlitic, 250 HB	20	22	22	26	22	0.013	0.077	0.115	0.160	0.220	0.325	0.440	0.550	0.650						
K1.3.1 Malleable cast iron, ferritic, 130 HB	26	29	29	34	29	0.016	0.096	0.140	0.200	0.275	0.405	0.555	0.690	0.815						
K1.3.2 Malleable cast iron, pearlitic, 230 HB	20	22	22	26	22	0.013	0.077	0.115	0.160	0.220	0.325	0.440	0.550	0.650						
K2.1.1 Vermicular graphite cast iron (GJV)	25	29	29	33	29	0.013	0.077	0.115	0.160	0.220	0.325	0.440	0.550	0.650						
K2.2.1 Austenitic-ferritic spheroidal graphite cast iron (ADI)			17			0.006	0.038	0.055	0.080	0.110	0.160	0.220	0.275	0.325						
N1.1.1 Wrought aluminium alloys, non-hardened, 60 HB					69	0.020	0.123	0.180	0.260	0.355	0.520	0.705	0.880	1.045						
N1.1.2 Wrought aluminium alloys, hardened, 100 HB					69	0.020	0.123	0.180	0.260	0.355	0.520	0.705	0.880	1.045						
N2.1.1 Aluminium casting alloys, non-hardened, ≤ 12 % Si, 75 HB	50	58	58	66	58	0.016	0.096	0.140	0.200	0.275	0.405	0.555	0.690	0.815						
N2.1.2 Aluminium casting alloys, hardened, ≤ 12 % Si, 90 HB	40	46	46	53	46	0.013	0.077	0.115	0.160	0.220	0.325	0.440	0.550	0.650						
N2.1.3 Aluminium casting alloys, non-hardened, > 12 % Si, 130 HB	35	40	40	46	40	0.013	0.077	0.115	0.160	0.220	0.325	0.440	0.550	0.650						
N3.1.1 Copper and copper alloys: Free-machining alloy, Pb > 1 %	60	69	69	79	69	0.013	0.077	0.115	0.160	0.220	0.325	0.440	0.550	0.650						
N3.1.2 Copper and copper alloys: CuZn, CuSnZn	36	41	41	48	41	0.010	0.061	0.090	0.130	0.175	0.260	0.355	0.440	0.520						
N3.1.3 Copper and copper alloys: CuSn, lead-free copper and copper electrolyte	48	55	55	63	55	0.010	0.061	0.090	0.130	0.175	0.260	0.355	0.440	0.520						
N4.1.1 Non-metallic materials: Duroplastics, fibre-reinforced plastics	20	23	23	26	23	0.013	0.077	0.115	0.160	0.220	0.325	0.440	0.550	0.650						
N4.1.2 Non-metallic materials: Hard rubber, wood, etc.	20	23	23	26	23	0.013	0.077	0.115	0.160	0.220	0.325	0.440	0.550	0.650						
N4.1.3 Non-metallic materials: Graphite																				
S1.1.1 Heat-resistant alloys, Fe-based, annealed, 200 HB					7	0.006	0.038	0.055	0.080	0.110	0.160	0.220	0.275	0.325						
S1.1.2 Heat-resistant alloys, Fe-based, hardened, 280 HB					6	0.005	0.031	0.045	0.065	0.090	0.130	0.175	0.220	0.260						
S1.1.3 Heat-resistant alloys, Ni- or Co-based, annealed, 250 HB					6	0.006	0.038	0.055	0.080	0.110	0.160	0.220	0.275	0.325						
S1.1.4 Heat-resistant alloys, Ni- or Co-based, hardened, 350 HB					3	0.005	0.031	0.045	0.065	0.090	0.130	0.175	0.220	0.260						
S1.1.5 Heat-resistant alloys, Ni- or Co-based, cast, 320 HB					4	0.005	0.031	0.045	0.065	0.090	0.130	0.175	0.220	0.260						
S2.1.1 Titanium alloys, pure titanium, Rm 400 N/mm ²					6	0.006	0.038	0.055	0.080	0.110	0.160	0.220	0.275	0.325						
S2.1.2 Titanium alloys, Alpha and Beta alloys, hardened, Rm 1050 N/mm ²					4	0.005	0.031	0.045	0.065	0.090	0.130	0.175	0.220	0.260						
H1.1.1 Hardened steel, hardened and tempered, < 55 HRC																				
H1.1.2 Hardened steel, hardened and tempered, < 60 HRC																				
H1.1.3 Hardened steel, hardened and tempered, > 60 HRC																				
H2.1.1 Chilled cast iron, 400 HB																				
H2.1.2 Chilled cast iron, hardened and tempered, < 55 HRC																				



Jobber drills, type N, nanoFIRE



Machining group	M42	f (mm/rev) with nom. Ø									
	F										
	v _c (m/min)	1	2	3	4	5	8	10	12	16	
P1.1.1 Unalloyed steel, annealed, 0.15 % C, Rm 420 N/mm ² , 125 HB	40	0.040	0.080	0.120	0.149	0.175	0.255	0.300	0.345	0.430	
P1.1.2 Unalloyed steel, heat-treated, 0.15 % C, Rm 420 N/mm ² , 125 HB	34	0.032	0.064	0.096	0.119	0.140	0.200	0.240	0.275	0.345	
P1.1.3 Unalloyed steel, annealed, 0.45 % C, Rm 640 N/mm ² , 190 HB	34	0.032	0.064	0.096	0.119	0.140	0.200	0.240	0.275	0.345	
P1.1.4 Unalloyed steel, heat-treated, 0.45 % C, Rm 640 N/mm ² , 190 HB	34	0.032	0.064	0.096	0.119	0.140	0.200	0.240	0.275	0.345	
P1.1.5 Unalloyed steel, heat-treated, 0.45 % C, Rm 850 N/mm ² , 250 HB	30	0.032	0.064	0.096	0.119	0.140	0.200	0.240	0.275	0.345	
P1.1.6 Unalloyed steel, annealed, 0.75 % C, Rm 915 N/mm ² , 270 HB	28	0.032	0.064	0.096	0.119	0.140	0.200	0.240	0.275	0.345	
P1.1.7 Unalloyed steel, heat-treated, 0.75 % C, Rm 1020 N/mm ² , 300 HB	24	0.032	0.064	0.096	0.119	0.140	0.200	0.240	0.275	0.345	
P2.1.1 Low-alloy steel, annealed, Rm 610 N/mm ² , 180 HB	24	0.026	0.051	0.077	0.096	0.115	0.160	0.190	0.220	0.275	
P2.1.2 Low-alloy steel, heat-treated, Rm 930 N/mm ² , 275 HB	17	0.020	0.041	0.061	0.076	0.090	0.130	0.155	0.175	0.220	
P2.1.3 Low-alloy steel, heat-treated, Rm 1020 N/mm ² , 300 HB	15	0.020	0.041	0.061	0.076	0.090	0.130	0.155	0.175	0.220	
P2.1.4 Low-alloy steel, heat-treated, Rm 1190 N/mm ² , 350 HB	13	0.016	0.032	0.048	0.060	0.070	0.100	0.120	0.140	0.175	
P3.1.1 High-alloy steel and tool steel, annealed, Rm 680 N/mm ² , 200 HB	19	0.026	0.051	0.077	0.096	0.115	0.160	0.190	0.220	0.275	
P3.1.2 High-alloy steel and tool steel, hardened and tempered, Rm 1100 N/mm ² , 325 HB	14	0.020	0.041	0.061	0.076	0.090	0.130	0.155	0.175	0.220	
M1.1.1 Stainless steel, ferritic/martensitic, with machining additives	14	0.020	0.040	0.060	0.075	0.090	0.125	0.150	0.175	0.215	
M1.1.2 Stainless steel, ferritic/martensitic, annealed, Rm 680 N/mm ² , 200 HB	13	0.020	0.040	0.060	0.075	0.090	0.125	0.150	0.175	0.215	
M1.1.3 Stainless steel, ferritic/martensitic, heat-treated, Rm 810 N/mm ² , 240 HB	12	0.016	0.032	0.048	0.060	0.070	0.100	0.120	0.140	0.175	
M2.1.1 Stainless steel, austenitic, quenched, 180 HB	12	0.020	0.040	0.060	0.075	0.090	0.125	0.150	0.175	0.215	
M2.2.1 Duplex steel, high-strength stainless steels	8	0.016	0.032	0.048	0.060	0.070	0.100	0.120	0.140	0.175	
K1.1.1 Grey cast iron, pearlitic/ferritic, 180 HB	43	0.040	0.080	0.120	0.149	0.175	0.255	0.300	0.345	0.430	
K1.1.2 Grey cast iron, pearlitic/martensitic, 260 HB	35	0.040	0.080	0.120	0.149	0.175	0.255	0.300	0.345	0.430	
K1.2.1 Cast iron with spheroidal graphite, ferritic, 160 HB	37	0.040	0.080	0.120	0.149	0.175	0.255	0.300	0.345	0.430	
K1.2.2 Cast iron with spheroidal graphite, pearlitic, 250 HB	28	0.032	0.064	0.096	0.119	0.140	0.200	0.240	0.275	0.345	
K1.3.1 Malleable cast iron, ferritic, 130 HB	37	0.040	0.080	0.120	0.149	0.175	0.255	0.300	0.345	0.430	
K1.3.2 Malleable cast iron, pearlitic, 230 HB	28	0.032	0.064	0.096	0.119	0.140	0.200	0.240	0.275	0.345	
K2.1.1 Vermicular graphite cast iron (GJV)	36	0.032	0.064	0.096	0.119	0.140	0.200	0.240	0.275	0.345	
K2.2.1 Austenitic-ferritic spheroidal graphite cast iron (ADI)											
N1.1.1 Wrought aluminium alloys, non-hardened, 60 HB	86	0.051	0.102	0.154	0.191	0.225	0.325	0.385	0.440	0.550	
N1.1.2 Wrought aluminium alloys, hardened, 100 HB	86	0.051	0.102	0.154	0.191	0.225	0.325	0.385	0.440	0.550	
N2.1.1 Aluminium casting alloys, non-hardened, ≤ 12 % Si, 75 HB	72	0.040	0.080	0.120	0.149	0.175	0.255	0.300	0.345	0.430	
N2.1.2 Aluminium casting alloys, hardened, ≤ 12 % Si, 90 HB	58	0.032	0.064	0.096	0.119	0.140	0.200	0.240	0.275	0.345	
N2.1.3 Aluminium casting alloys, non-hardened, > 12 % Si, 130 HB	50	0.032	0.064	0.096	0.119	0.140	0.200	0.240	0.275	0.345	
N3.1.1 Copper and copper alloys: Free-machining alloy, Pb > 1 %	86	0.032	0.064	0.096	0.119	0.140	0.200	0.240	0.275	0.345	
N3.1.2 Copper and copper alloys: CuZn, CuSnZn	52	0.026	0.051	0.077	0.096	0.115	0.160	0.190	0.220	0.275	
N3.1.3 Copper and copper alloys: CuSn, lead-free copper and copper electrolyte	69	0.026	0.051	0.077	0.096	0.115	0.160	0.190	0.220	0.275	
N4.1.1 Non-metallic materials: Duroplastics, fibre-reinforced plastics	29	0.032	0.064	0.096	0.119	0.140	0.200	0.240	0.275	0.345	
N4.1.2 Non-metallic materials: Hard rubber, wood, etc.	29	0.032	0.064	0.096	0.119	0.140	0.200	0.240	0.275	0.345	
N4.1.3 Non-metallic materials: Graphite											
S1.1.1 Heat-resistant alloys, Fe-based, annealed, 200 HB	9	0.016	0.032	0.048	0.060	0.070	0.100	0.120	0.140	0.170	
S1.1.2 Heat-resistant alloys, Fe-based, hardened, 280 HB	7	0.013	0.026	0.038	0.048	0.055	0.080	0.095	0.110	0.135	
S1.1.3 Heat-resistant alloys, Ni- or Co-based, annealed, 250 HB	7	0.016	0.032	0.048	0.060	0.070	0.100	0.120	0.140	0.170	
S1.1.4 Heat-resistant alloys, Ni- or Co-based, hardened, 350 HB	4	0.013	0.026	0.038	0.048	0.055	0.080	0.095	0.110	0.135	
S1.1.5 Heat-resistant alloys, Ni- or Co-based, cast, 320 HB	5	0.013	0.026	0.038	0.048	0.055	0.080	0.095	0.110	0.135	
S2.1.1 Titanium alloys, pure titanium, Rm 400 N/mm ²	7	0.016	0.032	0.048	0.060	0.070	0.100	0.120	0.140	0.170	
S2.1.2 Titanium alloys, Alpha and Beta alloys, hardened, Rm 1050 N/mm ²	5	0.013	0.026	0.038	0.048	0.055	0.080	0.095	0.110	0.135	
H1.1.1 Hardened steel, hardened and tempered, < 55 HRC	6	0.013	0.026	0.038	0.048	0.055	0.080	0.095	0.110	0.135	
H1.1.2 Hardened steel, hardened and tempered, < 60 HRC											
H1.1.3 Hardened steel, hardened and tempered, > 60 HRC											
H2.1.1 Chilled cast iron, 400 HB	9	0.020	0.040	0.060	0.075	0.090	0.125	0.150	0.175	0.215	
H2.1.2 Chilled cast iron, hardened and tempered, < 55 HRC											



Stub drills, GT 80, bright/steam tempered/nitrided lands and TiN



Machining group	HSS	HSCO	f (mm/rev) with nom. Ø								
	v_c (m/min)		1	3	5	8	10	12	14	16	20
P1.1.1 Unalloyed steel, annealed, 0.15 % C, Rm 420 N/mm ² , 125 HB	28	37	0.032	0.096	0.140	0.200	0.240	0.275	0.310	0.345	0.405
P1.1.2 Unalloyed steel, heat-treated, 0.15 % C, Rm 420 N/mm ² , 125 HB	24	31	0.026	0.077	0.115	0.160	0.190	0.220	0.250	0.275	0.325
P1.1.3 Unalloyed steel, annealed, 0.45 % C, Rm 640 N/mm ² , 190 HB	24	31	0.026	0.077	0.115	0.160	0.190	0.220	0.250	0.275	0.325
P1.1.4 Unalloyed steel, heat-treated, 0.45 % C, Rm 640 N/mm ² , 190 HB	24	31	0.026	0.077	0.115	0.160	0.190	0.220	0.250	0.275	0.325
P1.1.5 Unalloyed steel, heat-treated, 0.45 % C, Rm 850 N/mm ² , 250 HB	21	28	0.026	0.077	0.115	0.160	0.190	0.220	0.250	0.275	0.325
P1.1.6 Unalloyed steel, annealed, 0.75 % C, Rm 915 N/mm ² , 270 HB	20	26	0.026	0.077	0.115	0.160	0.190	0.220	0.250	0.275	0.325
P1.1.7 Unalloyed steel, heat-treated, 0.75 % C, Rm 1020 N/mm ² , 300 HB	17	22	0.026	0.077	0.115	0.160	0.190	0.220	0.250	0.275	0.325
P2.1.1 Low-alloy steel, annealed, Rm 610 N/mm ² , 180 HB	17	22	0.020	0.061	0.090	0.130	0.155	0.175	0.200	0.220	0.260
P2.1.2 Low-alloy steel, heat-treated, Rm 930 N/mm ² , 275 HB	12	16	0.016	0.049	0.070	0.105	0.125	0.140	0.160	0.175	0.210
P2.1.3 Low-alloy steel, heat-treated, Rm 1020 N/mm ² , 300 HB	10	13	0.016	0.049	0.070	0.105	0.125	0.140	0.160	0.175	0.210
P2.1.4 Low-alloy steel, heat-treated, Rm 1190 N/mm ² , 350 HB	9	12	0.013	0.039	0.055	0.080	0.095	0.110	0.125	0.140	0.165
P3.1.1 High-alloy steel and tool steel, annealed, Rm 680 N/mm ² , 200 HB	13	17	0.020	0.061	0.090	0.130	0.155	0.175	0.200	0.220	0.260
P3.1.2 High-alloy steel and tool steel, hardened and tempered, Rm 1100 N/mm ² , 325 HB		13	0.016	0.049	0.070	0.105	0.125	0.140	0.160	0.175	0.210
M1.1.1 Stainless steel, ferritic/martensitic, with machining additives		13	0.016	0.048	0.070	0.100	0.120	0.140	0.155	0.175	0.205
M1.1.2 Stainless steel, ferritic/martensitic, annealed, Rm 680 N/mm ² , 200 HB		12	0.016	0.048	0.070	0.100	0.120	0.140	0.155	0.175	0.205
M1.1.3 Stainless steel, ferritic/martensitic, heat-treated, Rm 810 N/mm ² , 240 HB		11	0.013	0.039	0.055	0.080	0.095	0.110	0.125	0.140	0.165
M2.1.1 Stainless steel, austenitic, quenched, 180 HB											
M2.2.1 Duplex steel, high-strength stainless steels											
K1.1.1 Grey cast iron, pearlitic/ferritic, 180 HB	30	40	0.032	0.096	0.140	0.200	0.240	0.275	0.310	0.345	0.405
K1.1.2 Grey cast iron, pearlitic/martensitic, 260 HB	24	32	0.032	0.096	0.140	0.200	0.240	0.275	0.310	0.345	0.405
K1.2.1 Cast iron with spheroidal graphite, ferritic, 160 HB	26	34	0.032	0.096	0.140	0.200	0.240	0.275	0.310	0.345	0.405
K1.2.2 Cast iron with spheroidal graphite, pearlitic, 250 HB	20	26	0.026	0.077	0.115	0.160	0.190	0.220	0.250	0.275	0.325
K1.3.1 Malleable cast iron, ferritic, 130 HB	26	34	0.032	0.096	0.140	0.200	0.240	0.275	0.310	0.345	0.405
K1.3.2 Malleable cast iron, pearlitic, 230 HB	20	26	0.026	0.077	0.115	0.160	0.190	0.220	0.250	0.275	0.325
K2.1.1 Vermicular graphite cast iron (GJV)	25	33	0.026	0.077	0.115	0.160	0.190	0.220	0.250	0.275	0.325
K2.2.1 Austenitic-ferritic spheroidal graphite cast iron (ADI)											
N1.1.1 Wrought aluminium alloys, non-hardened, 60 HB	60		0.041	0.123	0.180	0.260	0.305	0.355	0.395	0.440	0.520
N1.1.2 Wrought aluminium alloys, hardened, 100 HB	60		0.041	0.123	0.180	0.260	0.305	0.355	0.395	0.440	0.520
N2.1.1 Aluminium casting alloys, non-hardened, ≤ 12 % Si, 75 HB	50	66	0.032	0.096	0.140	0.200	0.240	0.275	0.310	0.345	0.405
N2.1.2 Aluminium casting alloys, hardened, ≤ 12 % Si, 90 HB	40	53	0.026	0.077	0.115	0.160	0.190	0.220	0.250	0.275	0.325
N2.1.3 Aluminium casting alloys, non-hardened, > 12 % Si, 130 HB	35	46	0.026	0.077	0.115	0.160	0.190	0.220	0.250	0.275	0.325
N3.1.1 Copper and copper alloys: Free-machining alloy, Pb > 1 %	60	79	0.026	0.077	0.115	0.160	0.190	0.220	0.250	0.275	0.325
N3.1.2 Copper and copper alloys: CuZn, CuSnZn	36	48	0.020	0.061	0.090	0.130	0.155	0.175	0.200	0.220	0.260
N3.1.3 Copper and copper alloys: CuSn, lead-free copper and copper electrolyte	48	63	0.020	0.061	0.090	0.130	0.155	0.175	0.200	0.220	0.260
N4.1.1 Non-metallic materials: Duroplastics, fibre-reinforced plastics	20	26	0.020	0.061	0.090	0.130	0.155	0.175	0.200	0.220	0.260
N4.1.2 Non-metallic materials: Hard rubber, wood, etc.											
N4.1.3 Non-metallic materials: Graphite											
S1.1.1 Heat-resistant alloys, Fe-based, annealed, 200 HB											
S1.1.2 Heat-resistant alloys, Fe-based, hardened, 280 HB											
S1.1.3 Heat-resistant alloys, Ni- or Co-based, annealed, 250 HB											
S1.1.4 Heat-resistant alloys, Ni- or Co-based, hardened, 350 HB											
S1.1.5 Heat-resistant alloys, Ni- or Co-based, cast, 320 HB											
S2.1.1 Titanium alloys, pure titanium, Rm 400 N/mm ²											
S2.1.2 Titanium alloys, Alpha and Beta alloys, hardened, Rm 1050 N/mm ²											
H1.1.1 Hardened steel, hardened and tempered, < 55 HRC											
H1.1.2 Hardened steel, hardened and tempered, < 60 HRC											
H1.1.3 Hardened steel, hardened and tempered, > 60 HRC											
H2.1.1 Chilled cast iron, 400 HB											
H2.1.2 Chilled cast iron, hardened and tempered, < 55 HRC											



Stub drills, GT 80, nanoFIRE



Machining group	HSS-E-PM	f (mm/rev) with nom. Ø									
	F										
	v _c (m/min)	1	2	3	4	5	8	10	12	16	
P1.1.1 Unalloyed steel, annealed, 0.15 % C, Rm 420 N/mm ² , 125 HB	41	0.040	0.080	0.120	0.149	0.175	0.255	0.300	0.345	0.430	
P1.1.2 Unalloyed steel, heat-treated, 0.15 % C, Rm 420 N/mm ² , 125 HB	35	0.032	0.064	0.096	0.119	0.140	0.200	0.240	0.275	0.345	
P1.1.3 Unalloyed steel, annealed, 0.45 % C, Rm 640 N/mm ² , 190 HB	35	0.032	0.064	0.096	0.119	0.140	0.200	0.240	0.275	0.345	
P1.1.4 Unalloyed steel, heat-treated, 0.45 % C, Rm 640 N/mm ² , 190 HB	35	0.032	0.064	0.096	0.119	0.140	0.200	0.240	0.275	0.345	
P1.1.5 Unalloyed steel, heat-treated, 0.45 % C, Rm 850 N/mm ² , 250 HB	31	0.032	0.064	0.096	0.119	0.140	0.200	0.240	0.275	0.345	
P1.1.6 Unalloyed steel, annealed, 0.75 % C, Rm 915 N/mm ² , 270 HB	29	0.032	0.064	0.096	0.119	0.140	0.200	0.240	0.275	0.345	
P1.1.7 Unalloyed steel, heat-treated, 0.75 % C, Rm 1020 N/mm ² , 300 HB	25	0.032	0.064	0.096	0.119	0.140	0.200	0.240	0.275	0.345	
P2.1.1 Low-alloy steel, annealed, Rm 610 N/mm ² , 180 HB	25	0.026	0.051	0.077	0.096	0.115	0.160	0.190	0.220	0.275	
P2.1.2 Low-alloy steel, heat-treated, Rm 930 N/mm ² , 275 HB	17	0.020	0.041	0.061	0.076	0.090	0.130	0.155	0.175	0.220	
P2.1.3 Low-alloy steel, heat-treated, Rm 1020 N/mm ² , 300 HB	15	0.020	0.041	0.061	0.076	0.090	0.130	0.155	0.175	0.220	
P2.1.4 Low-alloy steel, heat-treated, Rm 1190 N/mm ² , 350 HB	14	0.016	0.032	0.048	0.060	0.070	0.100	0.120	0.140	0.175	
P3.1.1 High-alloy steel and tool steel, annealed, Rm 680 N/mm ² , 200 HB	19	0.026	0.051	0.077	0.096	0.115	0.160	0.190	0.220	0.275	
P3.1.2 High-alloy steel and tool steel, hardened and tempered, Rm 1100 N/mm ² , 325 HB	14	0.020	0.041	0.061	0.076	0.090	0.130	0.155	0.175	0.220	
M1.1.1 Stainless steel, ferritic/martensitic, with machining additives	15	0.020	0.040	0.060	0.075	0.090	0.125	0.150	0.175	0.215	
M1.1.2 Stainless steel, ferritic/martensitic, annealed, Rm 680 N/mm ² , 200 HB	13	0.020	0.040	0.060	0.075	0.090	0.125	0.150	0.175	0.215	
M1.1.3 Stainless steel, ferritic/martensitic, heat-treated, Rm 810 N/mm ² , 240 HB	12	0.016	0.032	0.048	0.060	0.070	0.100	0.120	0.140	0.175	
M2.1.1 Stainless steel, austenitic, quenched, 180 HB											
M2.2.1 Duplex steel, high-strength stainless steels											
K1.1.1 Grey cast iron, pearlitic/ferritic, 180 HB	44	0.040	0.080	0.120	0.149	0.175	0.255	0.300	0.345	0.430	
K1.1.2 Grey cast iron, pearlitic/martensitic, 260 HB	35	0.040	0.080	0.120	0.149	0.175	0.255	0.300	0.345	0.430	
K1.2.1 Cast iron with spheroidal graphite, ferritic, 160 HB	37	0.040	0.080	0.120	0.149	0.175	0.255	0.300	0.345	0.430	
K1.2.2 Cast iron with spheroidal graphite, pearlitic, 250 HB	29	0.032	0.064	0.096	0.119	0.140	0.200	0.240	0.275	0.345	
K1.3.1 Malleable cast iron, ferritic, 130 HB	37	0.040	0.080	0.120	0.149	0.175	0.255	0.300	0.345	0.430	
K1.3.2 Malleable cast iron, pearlitic, 230 HB	29	0.032	0.064	0.096	0.119	0.140	0.200	0.240	0.275	0.345	
K2.1.1 Vermicular graphite cast iron (GJV)	37	0.032	0.064	0.096	0.119	0.140	0.200	0.240	0.275	0.345	
K2.2.1 Austenitic-ferritic spheroidal graphite cast iron (ADI)											
N1.1.1 Wrought aluminium alloys, non-hardened, 60 HB											
N1.1.2 Wrought aluminium alloys, hardened, 100 HB											
N2.1.1 Aluminium casting alloys, non-hardened, ≤ 12 % Si, 75 HB	73	0.040	0.080	0.120	0.149	0.175	0.255	0.300	0.345	0.430	
N2.1.2 Aluminium casting alloys, hardened, ≤ 12 % Si, 90 HB	59	0.032	0.064	0.096	0.119	0.140	0.200	0.240	0.275	0.345	
N2.1.3 Aluminium casting alloys, non-hardened, > 12 % Si, 130 HB	51	0.032	0.064	0.096	0.119	0.140	0.200	0.240	0.275	0.345	
N3.1.1 Copper and copper alloys: Free-machining alloy, Pb > 1 %	88	0.032	0.064	0.096	0.119	0.140	0.200	0.240	0.275	0.345	
N3.1.2 Copper and copper alloys: CuZn, CuSnZn	53	0.026	0.051	0.077	0.096	0.115	0.160	0.190	0.220	0.275	
N3.1.3 Copper and copper alloys: CuSn, lead-free copper and copper electrolyte	70	0.026	0.051	0.077	0.096	0.115	0.160	0.190	0.220	0.275	
N4.1.1 Non-metallic materials: Duroplastics, fibre-reinforced plastics	29	0.026	0.051	0.077	0.096	0.115	0.160	0.190	0.220	0.275	
N4.1.2 Non-metallic materials: Hard rubber, wood, etc.											
N4.1.3 Non-metallic materials: Graphite											
S1.1.1 Heat-resistant alloys, Fe-based, annealed, 200 HB											
S1.1.2 Heat-resistant alloys, Fe-based, hardened, 280 HB											
S1.1.3 Heat-resistant alloys, Ni- or Co-based, annealed, 250 HB											
S1.1.4 Heat-resistant alloys, Ni- or Co-based, hardened, 350 HB											
S1.1.5 Heat-resistant alloys, Ni- or Co-based, cast, 320 HB											
S2.1.1 Titanium alloys, pure titanium, Rm 400 N/mm ²											
S2.1.2 Titanium alloys, Alpha and Beta alloys, hardened, Rm 1050 N/mm ²											
H1.1.1 Hardened steel, hardened and tempered, < 55 HRC											
H1.1.2 Hardened steel, hardened and tempered, < 60 HRC											
H1.1.3 Hardened steel, hardened and tempered, > 60 HRC											
H2.1.1 Chilled cast iron, 400 HB											
H2.1.2 Chilled cast iron, hardened and tempered, < 55 HRC											



Stub drills/Jobber drills, GV 120, bright/steam tempered and TiN



Machining group	HSCO		f (mm/rev) with nom. Ø								
	v _c (m/min)		0.5	3	5	8	12	16	20	30	50
P1.1.1 Unalloyed steel, annealed, 0.15 % C, Rm 420 N/mm ² , 125 HB	38	44	0.016	0.096	0.140	0.200	0.275	0.345	0.405	0.555	0.815
P1.1.2 Unalloyed steel, heat-treated, 0.15 % C, Rm 420 N/mm ² , 125 HB	32	37	0.013	0.077	0.115	0.160	0.220	0.275	0.325	0.440	0.650
P1.1.3 Unalloyed steel, annealed, 0.45 % C, Rm 640 N/mm ² , 190 HB	32	37	0.013	0.077	0.115	0.160	0.220	0.275	0.325	0.440	0.650
P1.1.4 Unalloyed steel, heat-treated, 0.45 % C, Rm 640 N/mm ² , 190 HB	32	37	0.013	0.077	0.115	0.160	0.220	0.275	0.325	0.440	0.650
P1.1.5 Unalloyed steel, heat-treated, 0.45 % C, Rm 850 N/mm ² , 250 HB	28	33	0.013	0.077	0.115	0.160	0.220	0.275	0.325	0.440	0.650
P1.1.6 Unalloyed steel, annealed, 0.75 % C, Rm 915 N/mm ² , 270 HB	27	31	0.013	0.077	0.115	0.160	0.220	0.275	0.325	0.440	0.650
P1.1.7 Unalloyed steel, heat-treated, 0.75 % C, Rm 1020 N/mm ² , 300 HB	23	26	0.013	0.077	0.115	0.160	0.220	0.275	0.325	0.440	0.650
P2.1.1 Low-alloy steel, annealed, Rm 610 N/mm ² , 180 HB	25	29	0.013	0.077	0.115	0.160	0.220	0.275	0.325	0.440	0.650
P2.1.2 Low-alloy steel, heat-treated, Rm 930 N/mm ² , 275 HB	18	20	0.010	0.061	0.090	0.130	0.175	0.220	0.260	0.355	0.520
P2.1.3 Low-alloy steel, heat-treated, Rm 1020 N/mm ² , 300 HB	15	17	0.010	0.061	0.090	0.130	0.175	0.220	0.260	0.355	0.520
P2.1.4 Low-alloy steel, heat-treated, Rm 1190 N/mm ² , 350 HB	14	16	0.008	0.048	0.070	0.100	0.140	0.175	0.205	0.280	0.410
P3.1.1 High-alloy steel and tool steel, annealed, Rm 680 N/mm ² , 200 HB	16	19	0.010	0.061	0.090	0.130	0.175	0.220	0.260	0.355	0.520
P3.1.2 High-alloy steel and tool steel, hardened and tempered, Rm 1100 N/mm ² , 325 HB	12	14	0.008	0.049	0.070	0.105	0.140	0.175	0.210	0.285	0.415
M1.1.1 Stainless steel, ferritic/martensitic, with machining additives	16	19	0.008	0.048	0.070	0.100	0.140	0.175	0.205	0.280	0.410
M1.1.2 Stainless steel, ferritic/martensitic, annealed, Rm 680 N/mm ² , 200 HB	14	17	0.008	0.048	0.070	0.100	0.140	0.175	0.205	0.280	0.410
M1.1.3 Stainless steel, ferritic/martensitic, heat-treated, Rm 810 N/mm ² , 240 HB	14	16	0.006	0.039	0.055	0.080	0.110	0.140	0.165	0.225	0.330
M2.1.1 Stainless steel, austenitic, quenched, 180 HB	12	13	0.008	0.048	0.070	0.100	0.140	0.175	0.205	0.280	0.410
M2.2.1 Duplex steel, high-strength stainless steels	8	9	0.006	0.039	0.055	0.080	0.110	0.140	0.165	0.225	0.330
K1.1.1 Grey cast iron, pearlitic/ferritic, 180 HB	35	40	0.016	0.096	0.140	0.200	0.275	0.345	0.405	0.555	0.815
K1.1.2 Grey cast iron, pearlitic/martensitic, 260 HB	28	32	0.016	0.096	0.140	0.200	0.275	0.345	0.405	0.555	0.815
K1.2.1 Cast iron with spheroidal graphite, ferritic, 160 HB	29	34	0.016	0.096	0.140	0.200	0.275	0.345	0.405	0.555	0.815
K1.2.2 Cast iron with spheroidal graphite, pearlitic, 250 HB	22	26	0.013	0.077	0.115	0.160	0.220	0.275	0.325	0.440	0.650
K1.3.1 Malleable cast iron, ferritic, 130 HB	29	34	0.016	0.096	0.140	0.200	0.275	0.345	0.405	0.555	0.815
K1.3.2 Malleable cast iron, pearlitic, 230 HB	22	26	0.013	0.077	0.115	0.160	0.220	0.275	0.325	0.440	0.650
K2.1.1 Vermicular graphite cast iron (GJV)	30	34	0.013	0.077	0.115	0.160	0.220	0.275	0.325	0.440	0.650
K2.2.1 Austenitic-ferritic spheroidal graphite cast iron (ADI)		17	0.006	0.038	0.055	0.080	0.110	0.135	0.160	0.220	0.325
N1.1.1 Wrought aluminium alloys, non-hardened, 60 HB											
N1.1.2 Wrought aluminium alloys, hardened, 100 HB											
N2.1.1 Aluminium casting alloys, non-hardened, ≤ 12 % Si, 75 HB											
N2.1.2 Aluminium casting alloys, hardened, ≤ 12 % Si, 90 HB											
N2.1.3 Aluminium casting alloys, non-hardened, > 12 % Si, 130 HB											
N3.1.1 Copper and copper alloys: Free-machining alloy, Pb > 1 %	62	71	0.013	0.077	0.115	0.160	0.220	0.275	0.325	0.440	0.650
N3.1.2 Copper and copper alloys: CuZn, CuSnZn	37	43	0.010	0.061	0.090	0.130	0.175	0.220	0.260	0.355	0.520
N3.1.3 Copper and copper alloys: CuSn, lead-free copper and copper electrolyte											
N4.1.1 Non-metallic materials: Duroplastics, fibre-reinforced plastics											
N4.1.2 Non-metallic materials: Hard rubber, wood, etc.											
N4.1.3 Non-metallic materials: Graphite											
S1.1.1 Heat-resistant alloys, Fe-based, annealed, 200 HB	8	9	0.005	0.031	0.045	0.065	0.090	0.110	0.130	0.175	0.260
S1.1.2 Heat-resistant alloys, Fe-based, hardened, 280 HB	6	7	0.004	0.025	0.035	0.050	0.070	0.090	0.105	0.140	0.210
S1.1.3 Heat-resistant alloys, Ni- or Co-based, annealed, 250 HB	7	8	0.005	0.031	0.045	0.065	0.090	0.110	0.130	0.175	0.260
S1.1.4 Heat-resistant alloys, Ni- or Co-based, hardened, 350 HB		5	0.004	0.025	0.035	0.050	0.070	0.090	0.105	0.140	0.210
S1.1.5 Heat-resistant alloys, Ni- or Co-based, cast, 320 HB		6	0.004	0.025	0.035	0.050	0.070	0.090	0.105	0.140	0.210
S2.1.1 Titanium alloys, pure titanium, Rm 400 N/mm ²	10	12	0.006	0.038	0.055	0.080	0.110	0.135	0.160	0.220	0.325
S2.1.2 Titanium alloys, Alpha and Beta alloys, hardened, Rm 1050 N/mm ²	7	8	0.005	0.031	0.045	0.065	0.090	0.110	0.130	0.175	0.260
H1.1.1 Hardened steel, hardened and tempered, < 55 HRC	3	4	0.005	0.031	0.045	0.065	0.090	0.110	0.130	0.175	0.260
H1.1.2 Hardened steel, hardened and tempered, < 60 HRC											
H1.1.3 Hardened steel, hardened and tempered, > 60 HRC											
H2.1.1 Chilled cast iron, 400 HB	8	9	0.008	0.048	0.070	0.100	0.140	0.175	0.205	0.280	0.410
H2.1.2 Chilled cast iron, hardened and tempered, < 55 HRC											



Stub drills, GV 120, nanoFIRE



Machining group	HSCO	f (mm/rev) with nom. Ø									
	F										
	v _c (m/min)	1	2	3	4	5	8	10	12	15	
P1.1.1 Unalloyed steel, annealed, 0.15 % C, Rm 420 N/mm ² , 125 HB	47	0.040	0.080	0.120	0.149	0.175	0.255	0.300	0.345	0.410	
P1.1.2 Unalloyed steel, heat-treated, 0.15 % C, Rm 420 N/mm ² , 125 HB	40	0.032	0.064	0.096	0.119	0.140	0.200	0.240	0.275	0.325	
P1.1.3 Unalloyed steel, annealed, 0.45 % C, Rm 640 N/mm ² , 190 HB	40	0.032	0.064	0.096	0.119	0.140	0.200	0.240	0.275	0.325	
P1.1.4 Unalloyed steel, heat-treated, 0.45 % C, Rm 640 N/mm ² , 190 HB	40	0.032	0.064	0.096	0.119	0.140	0.200	0.240	0.275	0.325	
P1.1.5 Unalloyed steel, heat-treated, 0.45 % C, Rm 850 N/mm ² , 250 HB	36	0.032	0.064	0.096	0.119	0.140	0.200	0.240	0.275	0.325	
P1.1.6 Unalloyed steel, annealed, 0.75 % C, Rm 915 N/mm ² , 270 HB	33	0.032	0.064	0.096	0.119	0.140	0.200	0.240	0.275	0.325	
P1.1.7 Unalloyed steel, heat-treated, 0.75 % C, Rm 1020 N/mm ² , 300 HB	28	0.032	0.064	0.096	0.119	0.140	0.200	0.240	0.275	0.325	
P2.1.1 Low-alloy steel, annealed, Rm 610 N/mm ² , 180 HB	32	0.032	0.064	0.096	0.119	0.140	0.200	0.240	0.275	0.325	
P2.1.2 Low-alloy steel, heat-treated, Rm 930 N/mm ² , 275 HB	22	0.026	0.051	0.077	0.096	0.115	0.160	0.190	0.220	0.260	
P2.1.3 Low-alloy steel, heat-treated, Rm 1020 N/mm ² , 300 HB	19	0.026	0.051	0.077	0.096	0.115	0.160	0.190	0.220	0.260	
P2.1.4 Low-alloy steel, heat-treated, Rm 1190 N/mm ² , 350 HB	17	0.020	0.040	0.060	0.075	0.090	0.125	0.150	0.175	0.205	
P3.1.1 High-alloy steel and tool steel, annealed, Rm 680 N/mm ² , 200 HB	20	0.026	0.051	0.077	0.096	0.115	0.160	0.190	0.220	0.260	
P3.1.2 High-alloy steel and tool steel, hardened and tempered, Rm 1100 N/mm ² , 325 HB	15	0.020	0.041	0.061	0.076	0.090	0.130	0.155	0.175	0.210	
M1.1.1 Stainless steel, ferritic/martensitic, with machining additives	20	0.020	0.040	0.060	0.075	0.090	0.125	0.150	0.175	0.205	
M1.1.2 Stainless steel, ferritic/martensitic, annealed, Rm 680 N/mm ² , 200 HB	18	0.020	0.040	0.060	0.075	0.090	0.125	0.150	0.175	0.205	
M1.1.3 Stainless steel, ferritic/martensitic, heat-treated, Rm 810 N/mm ² , 240 HB	17	0.016	0.032	0.048	0.060	0.070	0.100	0.120	0.140	0.165	
M2.1.1 Stainless steel, austenitic, quenched, 180 HB	14	0.020	0.040	0.060	0.075	0.090	0.125	0.150	0.175	0.205	
M2.2.1 Duplex steel, high-strength stainless steels	10	0.016	0.032	0.048	0.060	0.070	0.100	0.120	0.140	0.165	
K1.1.1 Grey cast iron, pearlitic/ferritic, 180 HB	43	0.040	0.080	0.120	0.149	0.175	0.255	0.300	0.345	0.410	
K1.1.2 Grey cast iron, pearlitic/martensitic, 260 HB	35	0.040	0.080	0.120	0.149	0.175	0.255	0.300	0.345	0.410	
K1.2.1 Cast iron with spheroidal graphite, ferritic, 160 HB	37	0.040	0.080	0.120	0.149	0.175	0.255	0.300	0.345	0.410	
K1.2.2 Cast iron with spheroidal graphite, pearlitic, 250 HB	28	0.032	0.064	0.096	0.119	0.140	0.200	0.240	0.275	0.325	
K1.3.1 Malleable cast iron, ferritic, 130 HB	37	0.040	0.080	0.120	0.149	0.175	0.255	0.300	0.345	0.410	
K1.3.2 Malleable cast iron, pearlitic, 230 HB	28	0.032	0.064	0.096	0.119	0.140	0.200	0.240	0.275	0.325	
K2.1.1 Vermicular graphite cast iron (GJV)	37	0.032	0.064	0.096	0.119	0.140	0.200	0.240	0.275	0.325	
K2.2.1 Austenitic-ferritic spheroidal graphite cast iron (ADI)	19	0.016	0.032	0.048	0.060	0.070	0.100	0.120	0.140	0.165	
N1.1.1 Wrought aluminium alloys, non-hardened, 60 HB											
N1.1.2 Wrought aluminium alloys, hardened, 100 HB											
N2.1.1 Aluminium casting alloys, non-hardened, ≤ 12 % Si, 75 HB											
N2.1.2 Aluminium casting alloys, hardened, ≤ 12 % Si, 90 HB											
N2.1.3 Aluminium casting alloys, non-hardened, > 12 % Si, 130 HB											
N3.1.1 Copper and copper alloys: Free-machining alloy, Pb > 1 %	78	0.032	0.064	0.096	0.119	0.140	0.200	0.240	0.275	0.325	
N3.1.2 Copper and copper alloys: CuZn, CuSnZn	47	0.026	0.051	0.077	0.096	0.115	0.160	0.190	0.220	0.260	
N3.1.3 Copper and copper alloys: CuSn, lead-free copper and copper electrolyte											
N4.1.1 Non-metallic materials: Duroplastics, fibre-reinforced plastics											
N4.1.2 Non-metallic materials: Hard rubber, wood, etc.											
N4.1.3 Non-metallic materials: Graphite											
S1.1.1 Heat-resistant alloys, Fe-based, annealed, 200 HB	10	0.013	0.026	0.038	0.048	0.055	0.080	0.095	0.110	0.130	
S1.1.2 Heat-resistant alloys, Fe-based, hardened, 280 HB	8	0.010	0.020	0.031	0.038	0.045	0.065	0.075	0.090	0.105	
S1.1.3 Heat-resistant alloys, Ni- or Co-based, annealed, 250 HB	9	0.013	0.026	0.038	0.048	0.055	0.080	0.095	0.110	0.130	
S1.1.4 Heat-resistant alloys, Ni- or Co-based, hardened, 350 HB	5	0.010	0.020	0.031	0.038	0.045	0.065	0.075	0.090	0.105	
S1.1.5 Heat-resistant alloys, Ni- or Co-based, cast, 320 HB	6	0.010	0.020	0.031	0.038	0.045	0.065	0.075	0.090	0.105	
S2.1.1 Titanium alloys, pure titanium, Rm 400 N/mm ²	13	0.016	0.032	0.048	0.060	0.070	0.100	0.120	0.140	0.165	
S2.1.2 Titanium alloys, Alpha and Beta alloys, hardened, Rm 1050 N/mm ²	8	0.013	0.026	0.038	0.048	0.055	0.080	0.095	0.110	0.130	
H1.1.1 Hardened steel, hardened and tempered, < 55 HRC	4	0.013	0.026	0.038	0.048	0.055	0.080	0.095	0.110	0.130	
H1.1.2 Hardened steel, hardened and tempered, < 60 HRC											
H1.1.3 Hardened steel, hardened and tempered, > 60 HRC											
H2.1.1 Chilled cast iron, 400 HB	10	0.020	0.040	0.060	0.075	0.090	0.125	0.150	0.175	0.205	
H2.1.2 Chilled cast iron, hardened and tempered, < 55 HRC											



Stub drills/Jobber drills, type H, bright



Machining group	HSS	f (mm/rev) with nom. Ø									
	○										
	v _c (m/min)	0.5	1	3	5	8	10	14	18	20	
P1.1.1 Unalloyed steel, annealed, 0.15 % C, Rm 420 N/mm ² , 125 HB											
P1.1.2 Unalloyed steel, heat-treated, 0.15 % C, Rm 420 N/mm ² , 125 HB											
P1.1.3 Unalloyed steel, annealed, 0.45 % C, Rm 640 N/mm ² , 190 HB											
P1.1.4 Unalloyed steel, heat-treated, 0.45 % C, Rm 640 N/mm ² , 190 HB											
P1.1.5 Unalloyed steel, heat-treated, 0.45 % C, Rm 850 N/mm ² , 250 HB											
P1.1.6 Unalloyed steel, annealed, 0.75 % C, Rm 915 N/mm ² , 270 HB											
P1.1.7 Unalloyed steel, heat-treated, 0.75 % C, Rm 1020 N/mm ² , 300 HB											
P2.1.1 Low-alloy steel, annealed, Rm 610 N/mm ² , 180 HB											
P2.1.2 Low-alloy steel, heat-treated, Rm 930 N/mm ² , 275 HB											
P2.1.3 Low-alloy steel, heat-treated, Rm 1020 N/mm ² , 300 HB											
P2.1.4 Low-alloy steel, heat-treated, Rm 1190 N/mm ² , 350 HB											
P3.1.1 High-alloy steel and tool steel, annealed, Rm 680 N/mm ² , 200 HB											
P3.1.2 High-alloy steel and tool steel, hardened and tempered, Rm 1100 N/mm ² , 325 HB											
M1.1.1 Stainless steel, ferritic/martensitic, with machining additives											
M1.1.2 Stainless steel, ferritic/martensitic, annealed, Rm 680 N/mm ² , 200 HB											
M1.1.3 Stainless steel, ferritic/martensitic, heat-treated, Rm 810 N/mm ² , 240 HB											
M2.1.1 Stainless steel, austenitic, quenched, 180 HB											
M2.2.1 Duplex steel, high-strength stainless steels											
K1.1.1 Grey cast iron, pearlitic/ferritic, 180 HB											
K1.1.2 Grey cast iron, pearlitic/martensitic, 260 HB											
K1.2.1 Cast iron with spheroidal graphite, ferritic, 160 HB											
K1.2.2 Cast iron with spheroidal graphite, pearlitic, 250 HB											
K1.3.1 Malleable cast iron, ferritic, 130 HB											
K1.3.2 Malleable cast iron, pearlitic, 230 HB											
K2.1.1 Vermicular graphite cast iron (GJV)											
K2.2.1 Austenitic-ferritic spheroidal graphite cast iron (ADI)											
N1.1.1 Wrought aluminium alloys, non-hardened, 60 HB											
N1.1.2 Wrought aluminium alloys, hardened, 100 HB											
N2.1.1 Aluminium casting alloys, non-hardened, ≤ 12 % Si, 75 HB											
N2.1.2 Aluminium casting alloys, hardened, ≤ 12 % Si, 90 HB											
N2.1.3 Aluminium casting alloys, non-hardened, > 12 % Si, 130 HB											
N3.1.1 Copper and copper alloys: Free-machining alloy, Pb > 1 %	70	0.013	0.026	0.077	0.115	0.160	0.190	0.250	0.300	0.325	
N3.1.2 Copper and copper alloys: CuZn, CuSnZn	42	0.010	0.020	0.061	0.090	0.130	0.155	0.200	0.240	0.260	
N3.1.3 Copper and copper alloys: CuSn, lead-free copper and copper electrolyte											
N4.1.1 Non-metallic materials: Duroplastics, fibre-reinforced plastics	20	0.013	0.026	0.077	0.115	0.160	0.190	0.250	0.300	0.325	
N4.1.2 Non-metallic materials: Hard rubber, wood, etc.	20	0.013	0.026	0.077	0.115	0.160	0.190	0.250	0.300	0.325	
N4.1.3 Non-metallic materials: Graphite											
S1.1.1 Heat-resistant alloys, Fe-based, annealed, 200 HB											
S1.1.2 Heat-resistant alloys, Fe-based, hardened, 280 HB											
S1.1.3 Heat-resistant alloys, Ni- or Co-based, annealed, 250 HB											
S1.1.4 Heat-resistant alloys, Ni- or Co-based, hardened, 350 HB											
S1.1.5 Heat-resistant alloys, Ni- or Co-based, cast, 320 HB											
S2.1.1 Titanium alloys, pure titanium, Rm 400 N/mm ²											
S2.1.2 Titanium alloys, Alpha and Beta alloys, hardened, Rm 1050 N/mm ²											
H1.1.1 Hardened steel, hardened and tempered, < 55 HRC											
H1.1.2 Hardened steel, hardened and tempered, < 60 HRC											
H1.1.3 Hardened steel, hardened and tempered, > 60 HRC											
H2.1.1 Chilled cast iron, 400 HB											
H2.1.2 Chilled cast iron, hardened and tempered, < 55 HRC											



Stub drills/Jobber drills, type VA, Sirius



Machining group	HSCO	f (mm/rev) with nom. Ø									
	S										
	v _c (m/min)	1	2	3	4	5	8	10	12	15	
P1.1.1 Unalloyed steel, annealed, 0.15 % C, Rm 420 N/mm ² , 125 HB	44	0.032	0.064	0.096	0.119	0.140	0.200	0.240	0.275	0.325	
P1.1.2 Unalloyed steel, heat-treated, 0.15 % C, Rm 420 N/mm ² , 125 HB	37	0.026	0.051	0.077	0.096	0.115	0.160	0.190	0.220	0.260	
P1.1.3 Unalloyed steel, annealed, 0.45 % C, Rm 640 N/mm ² , 190 HB	37	0.026	0.051	0.077	0.096	0.115	0.160	0.190	0.220	0.260	
P1.1.4 Unalloyed steel, heat-treated, 0.45 % C, Rm 640 N/mm ² , 190 HB	37	0.026	0.051	0.077	0.096	0.115	0.160	0.190	0.220	0.260	
P1.1.5 Unalloyed steel, heat-treated, 0.45 % C, Rm 850 N/mm ² , 250 HB	33	0.026	0.051	0.077	0.096	0.115	0.160	0.190	0.220	0.260	
P1.1.6 Unalloyed steel, annealed, 0.75 % C, Rm 915 N/mm ² , 270 HB	31	0.026	0.051	0.077	0.096	0.115	0.160	0.190	0.220	0.260	
P1.1.7 Unalloyed steel, heat-treated, 0.75 % C, Rm 1020 N/mm ² , 300 HB											
P2.1.1 Low-alloy steel, annealed, Rm 610 N/mm ² , 180 HB	29	0.032	0.064	0.096	0.119	0.140	0.200	0.240	0.275	0.325	
P2.1.2 Low-alloy steel, heat-treated, Rm 930 N/mm ² , 275 HB	20	0.026	0.051	0.077	0.096	0.115	0.160	0.190	0.220	0.260	
P2.1.3 Low-alloy steel, heat-treated, Rm 1020 N/mm ² , 300 HB											
P2.1.4 Low-alloy steel, heat-treated, Rm 1190 N/mm ² , 350 HB											
P3.1.1 High-alloy steel and tool steel, annealed, Rm 680 N/mm ² , 200 HB											
P3.1.2 High-alloy steel and tool steel, hardened and tempered, Rm 1100 N/mm ² , 325 HB											
M1.1.1 Stainless steel, ferritic/martensitic, with machining additives	20	0.020	0.040	0.060	0.075	0.090	0.125	0.150	0.175	0.205	
M1.1.2 Stainless steel, ferritic/martensitic, annealed, Rm 680 N/mm ² , 200 HB	18	0.020	0.040	0.060	0.075	0.090	0.125	0.150	0.175	0.205	
M1.1.3 Stainless steel, ferritic/martensitic, heat-treated, Rm 810 N/mm ² , 240 HB	17	0.016	0.032	0.048	0.060	0.070	0.100	0.120	0.140	0.165	
M2.1.1 Stainless steel, austenitic, quenched, 180 HB	15	0.020	0.040	0.060	0.075	0.090	0.125	0.150	0.175	0.205	
M2.2.1 Duplex steel, high-strength stainless steels	10	0.016	0.032	0.048	0.060	0.070	0.100	0.120	0.140	0.165	
K1.1.1 Grey cast iron, pearlitic/ferritic, 180 HB	40	0.040	0.080	0.120	0.149	0.175	0.255	0.300	0.345	0.410	
K1.1.2 Grey cast iron, pearlitic/martensitic, 260 HB	32	0.040	0.080	0.120	0.149	0.175	0.255	0.300	0.345	0.410	
K1.2.1 Cast iron with spheroidal graphite, ferritic, 160 HB											
K1.2.2 Cast iron with spheroidal graphite, pearlitic, 250 HB											
K1.3.1 Malleable cast iron, ferritic, 130 HB											
K1.3.2 Malleable cast iron, pearlitic, 230 HB											
K2.1.1 Vermicular graphite cast iron (GJV)											
K2.2.1 Austenitic-ferritic spheroidal graphite cast iron (ADI)											
N1.1.1 Wrought aluminium alloys, non-hardened, 60 HB											
N1.1.2 Wrought aluminium alloys, hardened, 100 HB											
N2.1.1 Aluminium casting alloys, non-hardened, ≤ 12 % Si, 75 HB	75	0.040	0.080	0.120	0.149	0.175	0.255	0.300	0.345	0.410	
N2.1.2 Aluminium casting alloys, hardened, ≤ 12 % Si, 90 HB	60	0.032	0.064	0.096	0.119	0.140	0.200	0.240	0.275	0.325	
N2.1.3 Aluminium casting alloys, non-hardened, > 12 % Si, 130 HB	53	0.032	0.064	0.096	0.119	0.140	0.200	0.240	0.275	0.325	
N3.1.1 Copper and copper alloys: Free-machining alloy, Pb > 1 %	69	0.032	0.064	0.096	0.119	0.140	0.200	0.240	0.275	0.325	
N3.1.2 Copper and copper alloys: CuZn, CuSnZn	41	0.026	0.051	0.077	0.096	0.115	0.160	0.190	0.220	0.260	
N3.1.3 Copper and copper alloys: CuSn, lead-free copper and copper electrolyte	55	0.026	0.051	0.077	0.096	0.115	0.160	0.190	0.220	0.260	
N4.1.1 Non-metallic materials: Duroplastics, fibre-reinforced plastics											
N4.1.2 Non-metallic materials: Hard rubber, wood, etc.											
N4.1.3 Non-metallic materials: Graphite											
S1.1.1 Heat-resistant alloys, Fe-based, annealed, 200 HB	9	0.013	0.026	0.038	0.048	0.055	0.080	0.095	0.110	0.130	
S1.1.2 Heat-resistant alloys, Fe-based, hardened, 280 HB	7	0.010	0.020	0.031	0.038	0.045	0.065	0.075	0.090	0.105	
S1.1.3 Heat-resistant alloys, Ni- or Co-based, annealed, 250 HB	8	0.013	0.026	0.038	0.048	0.055	0.080	0.095	0.110	0.130	
S1.1.4 Heat-resistant alloys, Ni- or Co-based, hardened, 350 HB	5	0.010	0.020	0.031	0.038	0.045	0.065	0.075	0.090	0.105	
S1.1.5 Heat-resistant alloys, Ni- or Co-based, cast, 320 HB	6	0.010	0.020	0.031	0.038	0.045	0.065	0.075	0.090	0.105	
S2.1.1 Titanium alloys, pure titanium, Rm 400 N/mm ²	12	0.016	0.032	0.048	0.060	0.070	0.100	0.120	0.140	0.165	
S2.1.2 Titanium alloys, Alpha and Beta alloys, hardened, Rm 1050 N/mm ²	8	0.013	0.026	0.038	0.048	0.055	0.080	0.095	0.110	0.130	
H1.1.1 Hardened steel, hardened and tempered, < 55 HRC											
H1.1.2 Hardened steel, hardened and tempered, < 60 HRC											
H1.1.3 Hardened steel, hardened and tempered, > 60 HRC											
H2.1.1 Chilled cast iron, 400 HB											
H2.1.2 Chilled cast iron, hardened and tempered, < 55 HRC											



Stub drills, GT 500 DZ



Machining group	HSS-E-PM	f (mm/rev) with nom. Ø									
	F										
	v _c (m/min)	0.5	1	3	5	8	10	14	18	20	
P1.1.1 Unalloyed steel, annealed, 0.15 % C, Rm 420 N/mm ² , 125 HB	47	0.040	0.080	0.120	0.149	0.175	0.205	0.255	0.300	0.385	
P1.1.2 Unalloyed steel, heat-treated, 0.15 % C, Rm 420 N/mm ² , 125 HB	40	0.032	0.064	0.096	0.119	0.140	0.165	0.200	0.240	0.310	
P1.1.3 Unalloyed steel, annealed, 0.45 % C, Rm 640 N/mm ² , 190 HB	40	0.032	0.064	0.096	0.119	0.140	0.165	0.200	0.240	0.310	
P1.1.4 Unalloyed steel, heat-treated, 0.45 % C, Rm 640 N/mm ² , 190 HB	40	0.032	0.064	0.096	0.119	0.140	0.165	0.200	0.240	0.310	
P1.1.5 Unalloyed steel, heat-treated, 0.45 % C, Rm 850 N/mm ² , 250 HB	35	0.032	0.064	0.096	0.119	0.140	0.165	0.200	0.240	0.310	
P1.1.6 Unalloyed steel, annealed, 0.75 % C, Rm 915 N/mm ² , 270 HB	33	0.032	0.064	0.096	0.119	0.140	0.165	0.200	0.240	0.310	
P1.1.7 Unalloyed steel, heat-treated, 0.75 % C, Rm 1020 N/mm ² , 300 HB	28	0.032	0.064	0.096	0.119	0.140	0.165	0.200	0.240	0.310	
P2.1.1 Low-alloy steel, annealed, Rm 610 N/mm ² , 180 HB	35	0.040	0.080	0.120	0.149	0.175	0.205	0.255	0.300	0.385	
P2.1.2 Low-alloy steel, heat-treated, Rm 930 N/mm ² , 275 HB	25	0.032	0.064	0.096	0.119	0.140	0.165	0.200	0.240	0.310	
P2.1.3 Low-alloy steel, heat-treated, Rm 1020 N/mm ² , 300 HB	21	0.032	0.064	0.096	0.119	0.140	0.165	0.200	0.240	0.310	
P2.1.4 Low-alloy steel, heat-treated, Rm 1190 N/mm ² , 350 HB	19	0.025	0.050	0.076	0.094	0.110	0.130	0.160	0.190	0.245	
P3.1.1 High-alloy steel and tool steel, annealed, Rm 680 N/mm ² , 200 HB	22	0.026	0.051	0.077	0.096	0.115	0.130	0.160	0.190	0.250	
P3.1.2 High-alloy steel and tool steel, hardened and tempered, Rm 1100 N/mm ² , 325 HB	16	0.020	0.041	0.061	0.076	0.090	0.105	0.130	0.155	0.200	
M1.1.1 Stainless steel, ferritic/martensitic, with machining additives	18	0.020	0.040	0.060	0.075	0.090	0.100	0.125	0.150	0.195	
M1.1.2 Stainless steel, ferritic/martensitic, annealed, Rm 680 N/mm ² , 200 HB	16	0.020	0.040	0.060	0.075	0.090	0.100	0.125	0.150	0.195	
M1.1.3 Stainless steel, ferritic/martensitic, heat-treated, Rm 810 N/mm ² , 240 HB	15	0.016	0.032	0.048	0.060	0.070	0.080	0.100	0.120	0.155	
M2.1.1 Stainless steel, austenitic, quenched, 180 HB											
M2.2.1 Duplex steel, high-strength stainless steels											
K1.1.1 Grey cast iron, pearlitic/ferritic, 180 HB	50	0.040	0.080	0.120	0.149	0.175	0.205	0.255	0.300	0.385	
K1.1.2 Grey cast iron, pearlitic/martensitic, 260 HB	40	0.040	0.080	0.120	0.149	0.175	0.205	0.255	0.300	0.385	
K1.2.1 Cast iron with spheroidal graphite, ferritic, 160 HB	42	0.040	0.080	0.120	0.149	0.175	0.205	0.255	0.300	0.385	
K1.2.2 Cast iron with spheroidal graphite, pearlitic, 250 HB	32	0.032	0.064	0.096	0.119	0.140	0.165	0.200	0.240	0.310	
K1.3.1 Malleable cast iron, ferritic, 130 HB	42	0.040	0.080	0.120	0.149	0.175	0.205	0.255	0.300	0.385	
K1.3.2 Malleable cast iron, pearlitic, 230 HB	32	0.032	0.064	0.096	0.119	0.140	0.165	0.200	0.240	0.310	
K2.1.1 Vermicular graphite cast iron (GJV)	35	0.032	0.064	0.096	0.119	0.140	0.165	0.200	0.240	0.310	
K2.2.1 Austenitic-ferritic spheroidal graphite cast iron (ADI)											
N1.1.1 Wrought aluminium alloys, non-hardened, 60 HB											
N1.1.2 Wrought aluminium alloys, hardened, 100 HB											
N2.1.1 Aluminium casting alloys, non-hardened, ≤ 12 % Si, 75 HB	75	0.040	0.080	0.120	0.149	0.175	0.205	0.255	0.300	0.385	
N2.1.2 Aluminium casting alloys, hardened, ≤ 12 % Si, 90 HB	60	0.032	0.064	0.096	0.119	0.140	0.165	0.200	0.240	0.310	
N2.1.3 Aluminium casting alloys, non-hardened, > 12 % Si, 130 HB	52	0.032	0.064	0.096	0.119	0.140	0.165	0.200	0.240	0.310	
N3.1.1 Copper and copper alloys: Free-machining alloy, Pb > 1 %	70	0.032	0.064	0.096	0.119	0.140	0.165	0.200	0.240	0.310	
N3.1.2 Copper and copper alloys: CuZn, CuSnZn	42	0.026	0.051	0.077	0.096	0.115	0.130	0.160	0.190	0.250	
N3.1.3 Copper and copper alloys: CuSn, lead-free copper and copper electrolyte	56	0.026	0.051	0.077	0.096	0.115	0.130	0.160	0.190	0.250	
N4.1.1 Non-metallic materials: Duroplastics, fibre-reinforced plastics	25	0.026	0.051	0.077	0.096	0.115	0.130	0.160	0.190	0.250	
N4.1.2 Non-metallic materials: Hard rubber, wood, etc.											
N4.1.3 Non-metallic materials: Graphite											
S1.1.1 Heat-resistant alloys, Fe-based, annealed, 200 HB	7	0.016	0.032	0.048	0.060	0.070	0.080	0.100	0.120	0.155	
S1.1.2 Heat-resistant alloys, Fe-based, hardened, 280 HB	6	0.013	0.026	0.038	0.048	0.055	0.065	0.080	0.095	0.125	
S1.1.3 Heat-resistant alloys, Ni- or Co-based, annealed, 250 HB	6	0.016	0.032	0.048	0.060	0.070	0.080	0.100	0.120	0.155	
S1.1.4 Heat-resistant alloys, Ni- or Co-based, hardened, 350 HB											
S1.1.5 Heat-resistant alloys, Ni- or Co-based, cast, 320 HB											
S2.1.1 Titanium alloys, pure titanium, Rm 400 N/mm ²											
S2.1.2 Titanium alloys, Alpha and Beta alloys, hardened, Rm 1050 N/mm ²											
H1.1.1 Hardened steel, hardened and tempered, < 55 HRC	6	0.013	0.026	0.038	0.048	0.055	0.065	0.080	0.095	0.125	
H1.1.2 Hardened steel, hardened and tempered, < 60 HRC											
H1.1.3 Hardened steel, hardened and tempered, > 60 HRC											
H2.1.1 Chilled cast iron, 400 HB	12	0.020	0.040	0.060	0.075	0.090	0.100	0.125	0.150	0.195	
H2.1.2 Chilled cast iron, hardened and tempered, < 55 HRC											



Stub drills/Jobber drills, type W



Machining group	HSS	f (mm/rev) with nom. Ø									
	○										
	v _c (m/min)	0.5	1	3	5	8	10	12	16	20	
P1.1.1 Unalloyed steel, annealed, 0.15 % C, Rm 420 N/mm ² , 125 HB											
P1.1.2 Unalloyed steel, heat-treated, 0.15 % C, Rm 420 N/mm ² , 125 HB											
P1.1.3 Unalloyed steel, annealed, 0.45 % C, Rm 640 N/mm ² , 190 HB											
P1.1.4 Unalloyed steel, heat-treated, 0.45 % C, Rm 640 N/mm ² , 190 HB											
P1.1.5 Unalloyed steel, heat-treated, 0.45 % C, Rm 850 N/mm ² , 250 HB											
P1.1.6 Unalloyed steel, annealed, 0.75 % C, Rm 915 N/mm ² , 270 HB											
P1.1.7 Unalloyed steel, heat-treated, 0.75 % C, Rm 1020 N/mm ² , 300 HB											
P2.1.1 Low-alloy steel, annealed, Rm 610 N/mm ² , 180 HB											
P2.1.2 Low-alloy steel, heat-treated, Rm 930 N/mm ² , 275 HB											
P2.1.3 Low-alloy steel, heat-treated, Rm 1020 N/mm ² , 300 HB											
P2.1.4 Low-alloy steel, heat-treated, Rm 1190 N/mm ² , 350 HB											
P3.1.1 High-alloy steel and tool steel, annealed, Rm 680 N/mm ² , 200 HB											
P3.1.2 High-alloy steel and tool steel, hardened and tempered, Rm 1100 N/mm ² , 325 HB											
M1.1.1 Stainless steel, ferritic/martensitic, with machining additives											
M1.1.2 Stainless steel, ferritic/martensitic, annealed, Rm 680 N/mm ² , 200 HB											
M1.1.3 Stainless steel, ferritic/martensitic, heat-treated, Rm 810 N/mm ² , 240 HB											
M2.1.1 Stainless steel, austenitic, quenched, 180 HB											
M2.2.1 Duplex steel, high-strength stainless steels											
K1.1.1 Grey cast iron, pearlitic/ferritic, 180 HB											
K1.1.2 Grey cast iron, pearlitic/martensitic, 260 HB											
K1.2.1 Cast iron with spheroidal graphite, ferritic, 160 HB											
K1.2.2 Cast iron with spheroidal graphite, pearlitic, 250 HB											
K1.3.1 Malleable cast iron, ferritic, 130 HB											
K1.3.2 Malleable cast iron, pearlitic, 230 HB											
K2.1.1 Vermicular graphite cast iron (GJV)											
K2.2.1 Austenitic-ferritic spheroidal graphite cast iron (ADI)											
N1.1.1 Wrought aluminium alloys, non-hardened, 60 HB	70	0.020	0.041	0.123	0.180	0.260	0.305	0.355	0.440	0.520	
N1.1.2 Wrought aluminium alloys, hardened, 100 HB	70	0.020	0.041	0.123	0.180	0.260	0.305	0.355	0.440	0.520	
N2.1.1 Aluminium casting alloys, non-hardened, ≤ 12 % Si, 75 HB	60	0.016	0.032	0.096	0.140	0.200	0.240	0.275	0.345	0.405	
N2.1.2 Aluminium casting alloys, hardened, ≤ 12 % Si, 90 HB											
N2.1.3 Aluminium casting alloys, non-hardened, > 12 % Si, 130 HB											
N3.1.1 Copper and copper alloys: Free-machining alloy, Pb > 1 %											
N3.1.2 Copper and copper alloys: CuZn, CuSnZn											
N3.1.3 Copper and copper alloys: CuSn, lead-free copper and copper electrolyte											
N4.1.1 Non-metallic materials: Duroplastics, fibre-reinforced plastics											
N4.1.2 Non-metallic materials: Hard rubber, wood, etc.											
N4.1.3 Non-metallic materials: Graphite											
S1.1.1 Heat-resistant alloys, Fe-based, annealed, 200 HB											
S1.1.2 Heat-resistant alloys, Fe-based, hardened, 280 HB											
S1.1.3 Heat-resistant alloys, Ni- or Co-based, annealed, 250 HB											
S1.1.4 Heat-resistant alloys, Ni- or Co-based, hardened, 350 HB											
S1.1.5 Heat-resistant alloys, Ni- or Co-based, cast, 320 HB											
S2.1.1 Titanium alloys, pure titanium, Rm 400 N/mm ²											
S2.1.2 Titanium alloys, Alpha and Beta alloys, hardened, Rm 1050 N/mm ²											
H1.1.1 Hardened steel, hardened and tempered, < 55 HRC											
H1.1.2 Hardened steel, hardened and tempered, < 60 HRC											
H1.1.3 Hardened steel, hardened and tempered, > 60 HRC											
H2.1.1 Chilled cast iron, 400 HB											
H2.1.2 Chilled cast iron, hardened and tempered, < 55 HRC											



Jobber drills, GT 100, bright/nitrided lands and TiN



Machining group	HSS		HSCO		f (mm/rev) with nom. Ø									
	v _c (m/min)				1	3	5	8	12	16	20	30	40	
P1.1.1 Unalloyed steel, annealed, 0.15 % C, Rm 420 N/mm ² , 125 HB	28	32	32	37	0.032	0.096	0.140	0.200	0.275	0.345	0.405	0.555	0.690	
P1.1.2 Unalloyed steel, heat-treated, 0.15 % C, Rm 420 N/mm ² , 125 HB	24	27	27	31	0.026	0.077	0.115	0.160	0.220	0.275	0.325	0.440	0.550	
P1.1.3 Unalloyed steel, annealed, 0.45 % C, Rm 640 N/mm ² , 190 HB	24	27	27	31	0.026	0.077	0.115	0.160	0.220	0.275	0.325	0.440	0.550	
P1.1.4 Unalloyed steel, heat-treated, 0.45 % C, Rm 640 N/mm ² , 190 HB	24	27	27	31	0.026	0.077	0.115	0.160	0.220	0.275	0.325	0.440	0.550	
P1.1.5 Unalloyed steel, heat-treated, 0.45 % C, Rm 850 N/mm ² , 250 HB	21	24	24	28	0.026	0.077	0.115	0.160	0.220	0.275	0.325	0.440	0.550	
P1.1.6 Unalloyed steel, annealed, 0.75 % C, Rm 915 N/mm ² , 270 HB	20	23	23	26	0.026	0.077	0.115	0.160	0.220	0.275	0.325	0.440	0.550	
P1.1.7 Unalloyed steel, heat-treated, 0.75 % C, Rm 1020 N/mm ² , 300 HB	17	19	19	22	0.026	0.077	0.115	0.160	0.220	0.275	0.325	0.440	0.550	
P2.1.1 Low-alloy steel, annealed, Rm 610 N/mm ² , 180 HB	17	20	20	22	0.026	0.077	0.115	0.160	0.220	0.275	0.325	0.440	0.550	
P2.1.2 Low-alloy steel, heat-treated, Rm 930 N/mm ² , 275 HB	12	14	14	16	0.020	0.061	0.090	0.130	0.175	0.220	0.260	0.355	0.440	
P2.1.3 Low-alloy steel, heat-treated, Rm 1020 N/mm ² , 300 HB	10	12	12	13	0.020	0.061	0.090	0.130	0.175	0.220	0.260	0.355	0.440	
P2.1.4 Low-alloy steel, heat-treated, Rm 1190 N/mm ² , 350 HB	9	11	11	12	0.016	0.048	0.070	0.100	0.140	0.175	0.205	0.280	0.345	
P3.1.1 High-alloy steel and tool steel, annealed, Rm 680 N/mm ² , 200 HB	13	15	15	17	0.020	0.061	0.090	0.130	0.175	0.220	0.260	0.355	0.440	
P3.1.2 High-alloy steel and tool steel, hardened and tempered, Rm 1100 N/mm ² , 325 HB	10	11	11	13	0.016	0.049	0.070	0.105	0.140	0.175	0.210	0.285	0.350	
M1.1.1 Stainless steel, ferritic/martensitic, with machining additives			12	13	0.016	0.048	0.070	0.100	0.140	0.175	0.205	0.280	0.345	
M1.1.2 Stainless steel, ferritic/martensitic, annealed, Rm 680 N/mm ² , 200 HB			10	12	0.016	0.048	0.070	0.100	0.140	0.175	0.205	0.280	0.345	
M1.1.3 Stainless steel, ferritic/martensitic, heat-treated, Rm 810 N/mm ² , 240 HB			10	11	0.013	0.039	0.055	0.080	0.110	0.140	0.165	0.225	0.275	
M2.1.1 Stainless steel, austenitic, quenched, 180 HB			9	11	0.016	0.048	0.070	0.100	0.140	0.175	0.205	0.280	0.345	
M2.2.1 Duplex steel, high-strength stainless steels														
K1.1.1 Grey cast iron, pearlitic/ferritic, 180 HB	30	35	35	40	0.032	0.096	0.140	0.200	0.275	0.345	0.405	0.555	0.690	
K1.1.2 Grey cast iron, pearlitic/martensitic, 260 HB	24	28	28	32	0.032	0.096	0.140	0.200	0.275	0.345	0.405	0.555	0.690	
K1.2.1 Cast iron with spheroidal graphite, ferritic, 160 HB	26	29	29	34	0.032	0.096	0.140	0.200	0.275	0.345	0.405	0.555	0.690	
K1.2.2 Cast iron with spheroidal graphite, pearlitic, 250 HB	20	22	22	26	0.026	0.077	0.115	0.160	0.220	0.275	0.325	0.440	0.550	
K1.3.1 Malleable cast iron, ferritic, 130 HB	26	29	29	34	0.032	0.096	0.140	0.200	0.275	0.345	0.405	0.555	0.690	
K1.3.2 Malleable cast iron, pearlitic, 230 HB	20	22	22	26	0.026	0.077	0.115	0.160	0.220	0.275	0.325	0.440	0.550	
K2.1.1 Vermicular graphite cast iron (GJV)	25	29	29	33	0.026	0.077	0.115	0.160	0.220	0.275	0.325	0.440	0.550	
K2.2.1 Austenitic-ferritic spheroidal graphite cast iron (ADI)		14		17	0.013	0.038	0.055	0.080	0.110	0.135	0.160	0.220	0.275	
N1.1.1 Wrought aluminium alloys, non-hardened, 60 HB	60		69		0.041	0.123	0.180	0.260	0.355	0.440	0.520	0.705	0.880	
N1.1.2 Wrought aluminium alloys, hardened, 100 HB	60		69		0.041	0.123	0.180	0.260	0.355	0.440	0.520	0.705	0.880	
N2.1.1 Aluminium casting alloys, non-hardened, ≤ 12 % Si, 75 HB	50	58	58	66	0.032	0.096	0.140	0.200	0.275	0.345	0.405	0.555	0.690	
N2.1.2 Aluminium casting alloys, hardened, ≤ 12 % Si, 90 HB	40	46	46	53	0.026	0.077	0.115	0.160	0.220	0.275	0.325	0.440	0.550	
N2.1.3 Aluminium casting alloys, non-hardened, > 12 % Si, 130 HB	35	40	40	46	0.026	0.077	0.115	0.160	0.220	0.275	0.325	0.440	0.550	
N3.1.1 Copper and copper alloys: Free-machining alloy, Pb > 1 %	60	69	69	79	0.026	0.077	0.115	0.160	0.220	0.275	0.325	0.440	0.550	
N3.1.2 Copper and copper alloys: CuZn, CuSnZn	36	41	41	48	0.020	0.061	0.090	0.130	0.175	0.220	0.260	0.355	0.440	
N3.1.3 Copper and copper alloys: CuSn, lead-free copper and copper electrolyte	48	55	55	63	0.020	0.061	0.090	0.130	0.175	0.220	0.260	0.355	0.440	
N4.1.1 Non-metallic materials: Duroplastics, fibre-reinforced plastics	20	23	23	26	0.020	0.061	0.090	0.130	0.175	0.220	0.260	0.355	0.440	
N4.1.2 Non-metallic materials: Hard rubber, wood, etc.	20	23	23	26	0.020	0.061	0.090	0.130	0.175	0.220	0.260	0.355	0.440	
N4.1.3 Non-metallic materials: Graphite														
S1.1.1 Heat-resistant alloys, Fe-based, annealed, 200 HB			7	8	0.013	0.038	0.055	0.080	0.110	0.135	0.160	0.220	0.275	
S1.1.2 Heat-resistant alloys, Fe-based, hardened, 280 HB			6	6	0.010	0.031	0.045	0.065	0.090	0.110	0.130	0.175	0.220	
S1.1.3 Heat-resistant alloys, Ni- or Co-based, annealed, 250 HB			6	7	0.013	0.038	0.055	0.080	0.110	0.135	0.160	0.220	0.275	
S1.1.4 Heat-resistant alloys, Ni- or Co-based, hardened, 350 HB			3	4	0.010	0.031	0.045	0.065	0.090	0.110	0.130	0.175	0.220	
S1.1.5 Heat-resistant alloys, Ni- or Co-based, cast, 320 HB			4	5	0.010	0.031	0.045	0.065	0.090	0.110	0.130	0.175	0.220	
S2.1.1 Titanium alloys, pure titanium, Rm 400 N/mm ²			6	7	0.013	0.038	0.055	0.080	0.110	0.135	0.160	0.220	0.275	
S2.1.2 Titanium alloys, Alpha and Beta alloys, hardened, Rm 1050 N/mm ²			4	4	0.010	0.031	0.045	0.065	0.090	0.110	0.130	0.175	0.220	
H1.1.1 Hardened steel, hardened and tempered, < 55 HRC			5	5	0.010	0.031	0.045	0.065	0.090	0.110	0.130	0.175	0.220	
H1.1.2 Hardened steel, hardened and tempered, < 60 HRC														
H1.1.3 Hardened steel, hardened and tempered, > 60 HRC														
H2.1.1 Chilled cast iron, 400 HB			9	11	0.016	0.048	0.070	0.100	0.140	0.175	0.205	0.280	0.345	
H2.1.2 Chilled cast iron, hardened and tempered, < 55 HRC														



Jobber drills, GT 100, nanoFIRE



Machining group	HSCO	f (mm/rev) with nom. Ø									
	F										
	v _c (m/min)	1	2	3	4	5	8	10	12	15	
P1.1.1 Unalloyed steel, annealed, 0.15 % C, Rm 420 N/mm ² , 125 HB	40	0.040	0.080	0.120	0.149	0.175	0.255	0.300	0.345	0.410	
P1.1.2 Unalloyed steel, heat-treated, 0.15 % C, Rm 420 N/mm ² , 125 HB	34	0.032	0.064	0.096	0.119	0.140	0.200	0.240	0.275	0.325	
P1.1.3 Unalloyed steel, annealed, 0.45 % C, Rm 640 N/mm ² , 190 HB	34	0.032	0.064	0.096	0.119	0.140	0.200	0.240	0.275	0.325	
P1.1.4 Unalloyed steel, heat-treated, 0.45 % C, Rm 640 N/mm ² , 190 HB	34	0.032	0.064	0.096	0.119	0.140	0.200	0.240	0.275	0.325	
P1.1.5 Unalloyed steel, heat-treated, 0.45 % C, Rm 850 N/mm ² , 250 HB	30	0.032	0.064	0.096	0.119	0.140	0.200	0.240	0.275	0.325	
P1.1.6 Unalloyed steel, annealed, 0.75 % C, Rm 915 N/mm ² , 270 HB	28	0.032	0.064	0.096	0.119	0.140	0.200	0.240	0.275	0.325	
P1.1.7 Unalloyed steel, heat-treated, 0.75 % C, Rm 1020 N/mm ² , 300 HB	24	0.032	0.064	0.096	0.119	0.140	0.200	0.240	0.275	0.325	
P2.1.1 Low-alloy steel, annealed, Rm 610 N/mm ² , 180 HB	24	0.032	0.064	0.096	0.119	0.140	0.200	0.240	0.275	0.325	
P2.1.2 Low-alloy steel, heat-treated, Rm 930 N/mm ² , 275 HB	17	0.026	0.051	0.077	0.096	0.115	0.160	0.190	0.220	0.260	
P2.1.3 Low-alloy steel, heat-treated, Rm 1020 N/mm ² , 300 HB	15	0.026	0.051	0.077	0.096	0.115	0.160	0.190	0.220	0.260	
P2.1.4 Low-alloy steel, heat-treated, Rm 1190 N/mm ² , 350 HB	13	0.020	0.040	0.060	0.075	0.090	0.125	0.150	0.175	0.205	
P3.1.1 High-alloy steel and tool steel, annealed, Rm 680 N/mm ² , 200 HB	19	0.026	0.051	0.077	0.096	0.115	0.160	0.190	0.220	0.260	
P3.1.2 High-alloy steel and tool steel, hardened and tempered, Rm 1100 N/mm ² , 325 HB	14	0.020	0.041	0.061	0.076	0.090	0.130	0.155	0.175	0.210	
M1.1.1 Stainless steel, ferritic/martensitic, with machining additives	14	0.020	0.040	0.060	0.075	0.090	0.125	0.150	0.175	0.205	
M1.1.2 Stainless steel, ferritic/martensitic, annealed, Rm 680 N/mm ² , 200 HB	13	0.020	0.040	0.060	0.075	0.090	0.125	0.150	0.175	0.205	
M1.1.3 Stainless steel, ferritic/martensitic, heat-treated, Rm 810 N/mm ² , 240 HB	12	0.016	0.032	0.048	0.060	0.070	0.100	0.120	0.140	0.165	
M2.1.1 Stainless steel, austenitic, quenched, 180 HB	12	0.020	0.040	0.060	0.075	0.090	0.125	0.150	0.175	0.205	
M2.2.1 Duplex steel, high-strength stainless steels											
K1.1.1 Grey cast iron, pearlitic/ferritic, 180 HB	43	0.040	0.080	0.120	0.149	0.175	0.255	0.300	0.345	0.410	
K1.1.2 Grey cast iron, pearlitic/martensitic, 260 HB	35	0.040	0.080	0.120	0.149	0.175	0.255	0.300	0.345	0.410	
K1.2.1 Cast iron with spheroidal graphite, ferritic, 160 HB	37	0.040	0.080	0.120	0.149	0.175	0.255	0.300	0.345	0.410	
K1.2.2 Cast iron with spheroidal graphite, pearlitic, 250 HB	28	0.032	0.064	0.096	0.119	0.140	0.200	0.240	0.275	0.325	
K1.3.1 Malleable cast iron, ferritic, 130 HB	37	0.040	0.080	0.120	0.149	0.175	0.255	0.300	0.345	0.410	
K1.3.2 Malleable cast iron, pearlitic, 230 HB	28	0.032	0.064	0.096	0.119	0.140	0.200	0.240	0.275	0.325	
K2.1.1 Vermicular graphite cast iron (GJV)	36	0.032	0.064	0.096	0.119	0.140	0.200	0.240	0.275	0.325	
K2.2.1 Austenitic-ferritic spheroidal graphite cast iron (ADI)	18	0.016	0.032	0.048	0.060	0.070	0.100	0.120	0.140	0.165	
N1.1.1 Wrought aluminium alloys, non-hardened, 60 HB											
N1.1.2 Wrought aluminium alloys, hardened, 100 HB											
N2.1.1 Aluminium casting alloys, non-hardened, ≤ 12 % Si, 75 HB	72	0.040	0.080	0.120	0.149	0.175	0.255	0.300	0.345	0.410	
N2.1.2 Aluminium casting alloys, hardened, ≤ 12 % Si, 90 HB	58	0.032	0.064	0.096	0.119	0.140	0.200	0.240	0.275	0.325	
N2.1.3 Aluminium casting alloys, non-hardened, > 12 % Si, 130 HB	50	0.032	0.064	0.096	0.119	0.140	0.200	0.240	0.275	0.325	
N3.1.1 Copper and copper alloys: Free-machining alloy, Pb > 1 %	86	0.032	0.064	0.096	0.119	0.140	0.200	0.240	0.275	0.325	
N3.1.2 Copper and copper alloys: CuZn, CuSnZn	52	0.026	0.051	0.077	0.096	0.115	0.160	0.190	0.220	0.260	
N3.1.3 Copper and copper alloys: CuSn, lead-free copper and copper electrolyte	69	0.026	0.051	0.077	0.096	0.115	0.160	0.190	0.220	0.260	
N4.1.1 Non-metallic materials: Duroplastics, fibre-reinforced plastics	29	0.026	0.051	0.077	0.096	0.115	0.160	0.190	0.220	0.260	
N4.1.2 Non-metallic materials: Hard rubber, wood, etc.	29	0.026	0.051	0.077	0.096	0.115	0.160	0.190	0.220	0.260	
N4.1.3 Non-metallic materials: Graphite											
S1.1.1 Heat-resistant alloys, Fe-based, annealed, 200 HB	9	0.016	0.032	0.048	0.060	0.070	0.100	0.120	0.140	0.165	
S1.1.2 Heat-resistant alloys, Fe-based, hardened, 280 HB	7	0.013	0.026	0.038	0.048	0.055	0.080	0.095	0.110	0.130	
S1.1.3 Heat-resistant alloys, Ni- or Co-based, annealed, 250 HB	7	0.016	0.032	0.048	0.060	0.070	0.100	0.120	0.140	0.165	
S1.1.4 Heat-resistant alloys, Ni- or Co-based, hardened, 350 HB	4	0.013	0.026	0.038	0.048	0.055	0.080	0.095	0.110	0.130	
S1.1.5 Heat-resistant alloys, Ni- or Co-based, cast, 320 HB	5	0.013	0.026	0.038	0.048	0.055	0.080	0.095	0.110	0.130	
S2.1.1 Titanium alloys, pure titanium, Rm 400 N/mm ²	7	0.016	0.032	0.048	0.060	0.070	0.100	0.120	0.140	0.165	
S2.1.2 Titanium alloys, Alpha and Beta alloys, hardened, Rm 1050 N/mm ²	5	0.013	0.026	0.038	0.048	0.055	0.080	0.095	0.110	0.130	
H1.1.1 Hardened steel, hardened and tempered, < 55 HRC	6	0.013	0.026	0.038	0.048	0.055	0.080	0.095	0.110	0.130	
H1.1.2 Hardened steel, hardened and tempered, < 60 HRC											
H1.1.3 Hardened steel, hardened and tempered, > 60 HRC											
H2.1.1 Chilled cast iron, 400 HB	12	0.020	0.040	0.060	0.075	0.090	0.125	0.150	0.175	0.205	
H2.1.2 Chilled cast iron, hardened and tempered, < 55 HRC											



Jobber drills, type Ti, bright and TiN



Machining group	HSCO		f (mm/rev) with nom. Ø									
	○	Ⓢ										
	v _c (m/min)		0.5	1	3	5	8	10	12	16	20	
P1.1.1 Unalloyed steel, annealed, 0.15 % C, Rm 420 N/mm ² , 125 HB	38	44	0.013	0.026	0.077	0.115	0.160	0.190	0.220	0.275	0.325	
P1.1.2 Unalloyed steel, heat-treated, 0.15 % C, Rm 420 N/mm ² , 125 HB	32	37	0.010	0.020	0.061	0.090	0.130	0.155	0.175	0.220	0.260	
P1.1.3 Unalloyed steel, annealed, 0.45 % C, Rm 640 N/mm ² , 190 HB	32	37	0.010	0.020	0.061	0.090	0.130	0.155	0.175	0.220	0.260	
P1.1.4 Unalloyed steel, heat-treated, 0.45 % C, Rm 640 N/mm ² , 190 HB	32	37	0.010	0.020	0.061	0.090	0.130	0.155	0.175	0.220	0.260	
P1.1.5 Unalloyed steel, heat-treated, 0.45 % C, Rm 850 N/mm ² , 250 HB	28	33	0.010	0.020	0.061	0.090	0.130	0.155	0.175	0.220	0.260	
P1.1.6 Unalloyed steel, annealed, 0.75 % C, Rm 915 N/mm ² , 270 HB	27	31	0.010	0.020	0.061	0.090	0.130	0.155	0.175	0.220	0.260	
P1.1.7 Unalloyed steel, heat-treated, 0.75 % C, Rm 1020 N/mm ² , 300 HB	23	26	0.010	0.020	0.061	0.090	0.130	0.155	0.175	0.220	0.260	
P2.1.1 Low-alloy steel, annealed, Rm 610 N/mm ² , 180 HB	25	29	0.013	0.026	0.077	0.115	0.160	0.190	0.220	0.275	0.325	
P2.1.2 Low-alloy steel, heat-treated, Rm 930 N/mm ² , 275 HB	18	20	0.010	0.020	0.061	0.090	0.130	0.155	0.175	0.220	0.260	
P2.1.3 Low-alloy steel, heat-treated, Rm 1020 N/mm ² , 300 HB	15	17	0.010	0.020	0.061	0.090	0.130	0.155	0.175	0.220	0.260	
P2.1.4 Low-alloy steel, heat-treated, Rm 1190 N/mm ² , 350 HB	14	16	0.008	0.016	0.048	0.070	0.100	0.120	0.140	0.175	0.205	
P3.1.1 High-alloy steel and tool steel, annealed, Rm 680 N/mm ² , 200 HB	15	17	0.010	0.020	0.061	0.090	0.130	0.155	0.175	0.220	0.260	
P3.1.2 High-alloy steel and tool steel, hardened and tempered, Rm 1100 N/mm ² , 325 HB	11	13	0.008	0.016	0.049	0.070	0.105	0.125	0.140	0.175	0.210	
M1.1.1 Stainless steel, ferritic/martensitic, with machining additives	17	20	0.008	0.016	0.048	0.070	0.100	0.120	0.140	0.175	0.205	
M1.1.2 Stainless steel, ferritic/martensitic, annealed, Rm 680 N/mm ² , 200 HB	16	18	0.008	0.016	0.048	0.070	0.100	0.120	0.140	0.175	0.205	
M1.1.3 Stainless steel, ferritic/martensitic, heat-treated, Rm 810 N/mm ² , 240 HB	15	17	0.006	0.013	0.039	0.055	0.080	0.095	0.110	0.140	0.165	
M2.1.1 Stainless steel, austenitic, quenched, 180 HB	13	15	0.008	0.016	0.048	0.070	0.100	0.120	0.140	0.175	0.205	
M2.2.1 Duplex steel, high-strength stainless steels	9	10	0.006	0.013	0.039	0.055	0.080	0.095	0.110	0.140	0.165	
K1.1.1 Grey cast iron, pearlitic/ferritic, 180 HB												
K1.1.2 Grey cast iron, pearlitic/martensitic, 260 HB												
K1.2.1 Cast iron with spheroidal graphite, ferritic, 160 HB												
K1.2.2 Cast iron with spheroidal graphite, pearlitic, 250 HB												
K1.3.1 Malleable cast iron, ferritic, 130 HB												
K1.3.2 Malleable cast iron, pearlitic, 230 HB												
K2.1.1 Vermicular graphite cast iron (GJV)												
K2.2.1 Austenitic-ferritic spheroidal graphite cast iron (ADI)												
N1.1.1 Wrought aluminium alloys, non-hardened, 60 HB												
N1.1.2 Wrought aluminium alloys, hardened, 100 HB												
N2.1.1 Aluminium casting alloys, non-hardened, ≤ 12 % Si, 75 HB												
N2.1.2 Aluminium casting alloys, hardened, ≤ 12 % Si, 90 HB												
N2.1.3 Aluminium casting alloys, non-hardened, > 12 % Si, 130 HB												
N3.1.1 Copper and copper alloys: Free-machining alloy, Pb > 1 %												
N3.1.2 Copper and copper alloys: CuZn, CuSnZn												
N3.1.3 Copper and copper alloys: CuSn, lead-free copper and copper electrolyte												
N4.1.1 Non-metallic materials: Duroplastics, fibre-reinforced plastics												
N4.1.2 Non-metallic materials: Hard rubber, wood, etc.												
N4.1.3 Non-metallic materials: Graphite												
S1.1.1 Heat-resistant alloys, Fe-based, annealed, 200 HB	8	9	0.005	0.010	0.031	0.045	0.065	0.075	0.090	0.110	0.130	
S1.1.2 Heat-resistant alloys, Fe-based, hardened, 280 HB	6	7	0.004	0.008	0.025	0.035	0.050	0.060	0.070	0.090	0.105	
S1.1.3 Heat-resistant alloys, Ni- or Co-based, annealed, 250 HB	7	8	0.005	0.010	0.031	0.045	0.065	0.075	0.090	0.110	0.130	
S1.1.4 Heat-resistant alloys, Ni- or Co-based, hardened, 350 HB	4	5	0.004	0.008	0.025	0.035	0.050	0.060	0.070	0.090	0.105	
S1.1.5 Heat-resistant alloys, Ni- or Co-based, cast, 320 HB	5	6	0.004	0.008	0.025	0.035	0.050	0.060	0.070	0.090	0.105	
S2.1.1 Titanium alloys, pure titanium, Rm 400 N/mm ²	10	12	0.006	0.013	0.038	0.055	0.080	0.095	0.110	0.135	0.160	
S2.1.2 Titanium alloys, Alpha and Beta alloys, hardened, Rm 1050 N/mm ²	7	8	0.005	0.010	0.031	0.045	0.065	0.075	0.090	0.110	0.130	
H1.1.1 Hardened steel, hardened and tempered, < 55 HRC	5	5	0.005	0.010	0.031	0.045	0.065	0.075	0.090	0.110	0.130	
H1.1.2 Hardened steel, hardened and tempered, < 60 HRC												
H1.1.3 Hardened steel, hardened and tempered, > 60 HRC												
H2.1.1 Chilled cast iron, 400 HB	9	11	0.008	0.016	0.048	0.070	0.100	0.120	0.140	0.175	0.205	
H2.1.2 Chilled cast iron, hardened and tempered, < 55 HRC												



Jobber drills, type Ti, nanoFIRE



Cutting data

Machining group	HSCO	f (mm/rev) with nom. Ø									
	F										
	v _c (m/min)	0.5	2	3	4	5	8	10	12	15	
P1.1.1 Unalloyed steel, annealed, 0.15 % C, Rm 420 N/mm ² , 125 HB	47	0.016	0.064	0.096	0.119	0.140	0.200	0.240	0.275	0.325	
P1.1.2 Unalloyed steel, heat-treated, 0.15 % C, Rm 420 N/mm ² , 125 HB	40	0.013	0.051	0.077	0.096	0.115	0.160	0.190	0.220	0.260	
P1.1.3 Unalloyed steel, annealed, 0.45 % C, Rm 640 N/mm ² , 190 HB	40	0.013	0.051	0.077	0.096	0.115	0.160	0.190	0.220	0.260	
P1.1.4 Unalloyed steel, heat-treated, 0.45 % C, Rm 640 N/mm ² , 190 HB	40	0.013	0.051	0.077	0.096	0.115	0.160	0.190	0.220	0.260	
P1.1.5 Unalloyed steel, heat-treated, 0.45 % C, Rm 850 N/mm ² , 250 HB	36	0.013	0.051	0.077	0.096	0.115	0.160	0.190	0.220	0.260	
P1.1.6 Unalloyed steel, annealed, 0.75 % C, Rm 915 N/mm ² , 270 HB	33	0.013	0.051	0.077	0.096	0.115	0.160	0.190	0.220	0.260	
P1.1.7 Unalloyed steel, heat-treated, 0.75 % C, Rm 1020 N/mm ² , 300 HB	28	0.013	0.051	0.077	0.096	0.115	0.160	0.190	0.220	0.260	
P2.1.1 Low-alloy steel, annealed, Rm 610 N/mm ² , 180 HB	32	0.016	0.064	0.096	0.119	0.140	0.200	0.240	0.275	0.325	
P2.1.2 Low-alloy steel, heat-treated, Rm 930 N/mm ² , 275 HB	22	0.013	0.051	0.077	0.096	0.115	0.160	0.190	0.220	0.260	
P2.1.3 Low-alloy steel, heat-treated, Rm 1020 N/mm ² , 300 HB	19	0.013	0.051	0.077	0.096	0.115	0.160	0.190	0.220	0.260	
P2.1.4 Low-alloy steel, heat-treated, Rm 1190 N/mm ² , 350 HB	17	0.010	0.040	0.060	0.075	0.090	0.125	0.150	0.175	0.205	
P3.1.1 High-alloy steel and tool steel, annealed, Rm 680 N/mm ² , 200 HB	19	0.013	0.051	0.077	0.096	0.115	0.160	0.190	0.220	0.260	
P3.1.2 High-alloy steel and tool steel, hardened and tempered, Rm 1100 N/mm ² , 325 HB	14	0.010	0.041	0.061	0.076	0.090	0.130	0.155	0.175	0.210	
M1.1.1 Stainless steel, ferritic/martensitic, with machining additives	22	0.010	0.040	0.060	0.075	0.090	0.125	0.150	0.175	0.205	
M1.1.2 Stainless steel, ferritic/martensitic, annealed, Rm 680 N/mm ² , 200 HB	19	0.010	0.040	0.060	0.075	0.090	0.125	0.150	0.175	0.205	
M1.1.3 Stainless steel, ferritic/martensitic, heat-treated, Rm 810 N/mm ² , 240 HB	18	0.008	0.032	0.048	0.060	0.070	0.100	0.120	0.140	0.165	
M2.1.1 Stainless steel, austenitic, quenched, 180 HB	16	0.010	0.040	0.060	0.075	0.090	0.125	0.150	0.175	0.205	
M2.2.1 Duplex steel, high-strength stainless steels	11	0.008	0.032	0.048	0.060	0.070	0.100	0.120	0.140	0.165	
K1.1.1 Grey cast iron, pearlitic/ferritic, 180 HB											
K1.1.2 Grey cast iron, pearlitic/martensitic, 260 HB											
K1.2.1 Cast iron with spheroidal graphite, ferritic, 160 HB											
K1.2.2 Cast iron with spheroidal graphite, pearlitic, 250 HB											
K1.3.1 Malleable cast iron, ferritic, 130 HB											
K1.3.2 Malleable cast iron, pearlitic, 230 HB											
K2.1.1 Vermicular graphite cast iron (GJV)											
K2.2.1 Austenitic-ferritic spheroidal graphite cast iron (ADI)											
N1.1.1 Wrought aluminium alloys, non-hardened, 60 HB											
N1.1.2 Wrought aluminium alloys, hardened, 100 HB											
N2.1.1 Aluminium casting alloys, non-hardened, ≤ 12 % Si, 75 HB											
N2.1.2 Aluminium casting alloys, hardened, ≤ 12 % Si, 90 HB											
N2.1.3 Aluminium casting alloys, non-hardened, > 12 % Si, 130 HB											
N3.1.1 Copper and copper alloys: Free-machining alloy, Pb > 1 %											
N3.1.2 Copper and copper alloys: CuZn, CuSnZn											
N3.1.3 Copper and copper alloys: CuSn, lead-free copper and copper electrolyte											
N4.1.1 Non-metallic materials: Duroplastics, fibre-reinforced plastics											
N4.1.2 Non-metallic materials: Hard rubber, wood, etc.											
N4.1.3 Non-metallic materials: Graphite											
S1.1.1 Heat-resistant alloys, Fe-based, annealed, 200 HB	10	0.006	0.026	0.038	0.048	0.055	0.080	0.095	0.110	0.130	
S1.1.2 Heat-resistant alloys, Fe-based, hardened, 280 HB	8	0.005	0.020	0.031	0.038	0.045	0.065	0.075	0.090	0.105	
S1.1.3 Heat-resistant alloys, Ni- or Co-based, annealed, 250 HB	9	0.006	0.026	0.038	0.048	0.055	0.080	0.095	0.110	0.130	
S1.1.4 Heat-resistant alloys, Ni- or Co-based, hardened, 350 HB	5	0.005	0.020	0.031	0.038	0.045	0.065	0.075	0.090	0.105	
S1.1.5 Heat-resistant alloys, Ni- or Co-based, cast, 320 HB	6	0.005	0.020	0.031	0.038	0.045	0.065	0.075	0.090	0.105	
S2.1.1 Titanium alloys, pure titanium, Rm 400 N/mm ²	13	0.008	0.032	0.048	0.060	0.070	0.100	0.120	0.140	0.165	
S2.1.2 Titanium alloys, Alpha and Beta alloys, hardened, Rm 1050 N/mm ²	8	0.006	0.026	0.038	0.048	0.055	0.080	0.095	0.110	0.130	
H1.1.1 Hardened steel, hardened and tempered, < 55 HRC	6	0.006	0.026	0.038	0.048	0.055	0.080	0.095	0.110	0.130	
H1.1.2 Hardened steel, hardened and tempered, < 60 HRC											
H1.1.3 Hardened steel, hardened and tempered, > 60 HRC											
H2.1.1 Chilled cast iron, 400 HB	12	0.010	0.040	0.060	0.075	0.090	0.125	0.150	0.175	0.205	
H2.1.2 Chilled cast iron, hardened and tempered, < 55 HRC											



Jobber drills, GU 3FS



Machining group	HSCO	f (mm/rev) with nom. Ø									
		1	2	3	4	5	6	8	10	13	
	v _c (m/min)										
P1.1.1 Unalloyed steel, annealed, 0.15 % C, Rm 420 N/mm ² , 125 HB	40	0.032	0.064	0.096	0.119	0.140	0.165	0.200	0.240	0.295	
P1.1.2 Unalloyed steel, heat-treated, 0.15 % C, Rm 420 N/mm ² , 125 HB	34	0.026	0.051	0.077	0.096	0.115	0.130	0.160	0.190	0.235	
P1.1.3 Unalloyed steel, annealed, 0.45 % C, Rm 640 N/mm ² , 190 HB	34	0.026	0.051	0.077	0.096	0.115	0.130	0.160	0.190	0.235	
P1.1.4 Unalloyed steel, heat-treated, 0.45 % C, Rm 640 N/mm ² , 190 HB	34	0.026	0.051	0.077	0.096	0.115	0.130	0.160	0.190	0.235	
P1.1.5 Unalloyed steel, heat-treated, 0.45 % C, Rm 850 N/mm ² , 250 HB	30	0.026	0.051	0.077	0.096	0.115	0.130	0.160	0.190	0.235	
P1.1.6 Unalloyed steel, annealed, 0.75 % C, Rm 915 N/mm ² , 270 HB	28	0.026	0.051	0.077	0.096	0.115	0.130	0.160	0.190	0.235	
P1.1.7 Unalloyed steel, heat-treated, 0.75 % C, Rm 1020 N/mm ² , 300 HB	24	0.026	0.051	0.077	0.096	0.115	0.130	0.160	0.190	0.235	
P2.1.1 Low-alloy steel, annealed, Rm 610 N/mm ² , 180 HB	30	0.026	0.051	0.077	0.096	0.115	0.130	0.160	0.190	0.235	
P2.1.2 Low-alloy steel, heat-treated, Rm 930 N/mm ² , 275 HB	21	0.020	0.041	0.061	0.076	0.090	0.105	0.130	0.155	0.185	
P2.1.3 Low-alloy steel, heat-treated, Rm 1020 N/mm ² , 300 HB	18	0.020	0.041	0.061	0.076	0.090	0.105	0.130	0.155	0.185	
P2.1.4 Low-alloy steel, heat-treated, Rm 1190 N/mm ² , 350 HB	16	0.016	0.032	0.048	0.060	0.070	0.080	0.100	0.120	0.150	
P3.1.1 High-alloy steel and tool steel, annealed, Rm 680 N/mm ² , 200 HB	15	0.020	0.041	0.061	0.076	0.090	0.105	0.130	0.155	0.185	
P3.1.2 High-alloy steel and tool steel, hardened and tempered, Rm 1100 N/mm ² , 325 HB	11	0.016	0.033	0.049	0.061	0.070	0.085	0.105	0.125	0.150	
M1.1.1 Stainless steel, ferritic/martensitic, with machining additives	17	0.016	0.032	0.048	0.060	0.070	0.080	0.100	0.120	0.150	
M1.1.2 Stainless steel, ferritic/martensitic, annealed, Rm 680 N/mm ² , 200 HB	16	0.016	0.032	0.048	0.060	0.070	0.080	0.100	0.120	0.150	
M1.1.3 Stainless steel, ferritic/martensitic, heat-treated, Rm 810 N/mm ² , 240 HB	15	0.013	0.026	0.039	0.048	0.055	0.065	0.080	0.095	0.120	
M2.1.1 Stainless steel, austenitic, quenched, 180 HB	13	0.016	0.032	0.048	0.060	0.070	0.080	0.100	0.120	0.150	
M2.2.1 Duplex steel, high-strength stainless steels	9	0.013	0.026	0.039	0.048	0.055	0.065	0.080	0.095	0.120	
K1.1.1 Grey cast iron, pearlitic/ferritic, 180 HB	36	0.032	0.064	0.096	0.119	0.140	0.165	0.200	0.240	0.295	
K1.1.2 Grey cast iron, pearlitic/martensitic, 260 HB	29	0.032	0.064	0.096	0.119	0.140	0.165	0.200	0.240	0.295	
K1.2.1 Cast iron with spheroidal graphite, ferritic, 160 HB	30	0.032	0.064	0.096	0.119	0.140	0.165	0.200	0.240	0.295	
K1.2.2 Cast iron with spheroidal graphite, pearlitic, 250 HB	23	0.026	0.051	0.077	0.096	0.115	0.130	0.160	0.190	0.235	
K1.3.1 Malleable cast iron, ferritic, 130 HB	30	0.032	0.064	0.096	0.119	0.140	0.165	0.200	0.240	0.295	
K1.3.2 Malleable cast iron, pearlitic, 230 HB	23	0.026	0.051	0.077	0.096	0.115	0.130	0.160	0.190	0.235	
K2.1.1 Vermicular graphite cast iron (GJV)											
K2.2.1 Austenitic-ferritic spheroidal graphite cast iron (ADI)											
N1.1.1 Wrought aluminium alloys, non-hardened, 60 HB	60	0.041	0.082	0.123	0.153	0.180	0.210	0.260	0.305	0.375	
N1.1.2 Wrought aluminium alloys, hardened, 100 HB	60	0.041	0.082	0.123	0.153	0.180	0.210	0.260	0.305	0.375	
N2.1.1 Aluminium casting alloys, non-hardened, ≤ 12 % Si, 75 HB	66	0.032	0.064	0.096	0.119	0.140	0.165	0.200	0.240	0.295	
N2.1.2 Aluminium casting alloys, hardened, ≤ 12 % Si, 90 HB	52	0.026	0.051	0.077	0.096	0.115	0.130	0.160	0.190	0.235	
N2.1.3 Aluminium casting alloys, non-hardened, > 12 % Si, 130 HB	46	0.026	0.051	0.077	0.096	0.115	0.130	0.160	0.190	0.235	
N3.1.1 Copper and copper alloys: Free-machining alloy, Pb > 1 %	60	0.026	0.051	0.077	0.096	0.115	0.130	0.160	0.190	0.235	
N3.1.2 Copper and copper alloys: CuZn, CuSnZn	36	0.020	0.041	0.061	0.076	0.090	0.105	0.130	0.155	0.185	
N3.1.3 Copper and copper alloys: CuSn, lead-free copper and copper electrolyte	48	0.020	0.041	0.061	0.076	0.090	0.105	0.130	0.155	0.185	
N4.1.1 Non-metallic materials: Duroplastics, fibre-reinforced plastics	25	0.020	0.041	0.061	0.076	0.090	0.105	0.130	0.155	0.185	
N4.1.2 Non-metallic materials: Hard rubber, wood, etc.	25	0.020	0.041	0.061	0.076	0.090	0.105	0.130	0.155	0.185	
N4.1.3 Non-metallic materials: Graphite											
S1.1.1 Heat-resistant alloys, Fe-based, annealed, 200 HB											
S1.1.2 Heat-resistant alloys, Fe-based, hardened, 280 HB											
S1.1.3 Heat-resistant alloys, Ni- or Co-based, annealed, 250 HB											
S1.1.4 Heat-resistant alloys, Ni- or Co-based, hardened, 350 HB											
S1.1.5 Heat-resistant alloys, Ni- or Co-based, cast, 320 HB											
S2.1.1 Titanium alloys, pure titanium, Rm 400 N/mm ²	8	0.013	0.026	0.038	0.048	0.055	0.065	0.080	0.095	0.115	
S2.1.2 Titanium alloys, Alpha and Beta alloys, hardened, Rm 1050 N/mm ²	5	0.010	0.020	0.031	0.038	0.045	0.050	0.065	0.075	0.095	
H1.1.1 Hardened steel, hardened and tempered, < 55 HRC											
H1.1.2 Hardened steel, hardened and tempered, < 60 HRC											
H1.1.3 Hardened steel, hardened and tempered, > 60 HRC											
H2.1.1 Chilled cast iron, 400 HB											
H2.1.2 Chilled cast iron, hardened and tempered, < 55 HRC											



Jobber drills, AeroX



Machining group	M42	f (mm/rev) with nom. Ø									
	v _c (m/min)	1	2	3	4	5	6	8	10	13	
P1.1.1 Unalloyed steel, annealed, 0.15 % C, Rm 420 N/mm ² , 125 HB	38	0.026	0.051	0.077	0.096	0.115	0.130	0.160	0.190	0.235	
P1.1.2 Unalloyed steel, heat-treated, 0.15 % C, Rm 420 N/mm ² , 125 HB	32	0.020	0.041	0.061	0.076	0.090	0.105	0.130	0.155	0.185	
P1.1.3 Unalloyed steel, annealed, 0.45 % C, Rm 640 N/mm ² , 190 HB	32	0.020	0.041	0.061	0.076	0.090	0.105	0.130	0.155	0.185	
P1.1.4 Unalloyed steel, heat-treated, 0.45 % C, Rm 640 N/mm ² , 190 HB	32	0.020	0.041	0.061	0.076	0.090	0.105	0.130	0.155	0.185	
P1.1.5 Unalloyed steel, heat-treated, 0.45 % C, Rm 850 N/mm ² , 250 HB	28	0.020	0.041	0.061	0.076	0.090	0.105	0.130	0.155	0.185	
P1.1.6 Unalloyed steel, annealed, 0.75 % C, Rm 915 N/mm ² , 270 HB	27	0.020	0.041	0.061	0.076	0.090	0.105	0.130	0.155	0.185	
P1.1.7 Unalloyed steel, heat-treated, 0.75 % C, Rm 1020 N/mm ² , 300 HB	23	0.020	0.041	0.061	0.076	0.090	0.105	0.130	0.155	0.185	
P2.1.1 Low-alloy steel, annealed, Rm 610 N/mm ² , 180 HB	25	0.026	0.051	0.077	0.096	0.115	0.130	0.160	0.190	0.235	
P2.1.2 Low-alloy steel, heat-treated, Rm 930 N/mm ² , 275 HB	18	0.020	0.041	0.061	0.076	0.090	0.105	0.130	0.155	0.185	
P2.1.3 Low-alloy steel, heat-treated, Rm 1020 N/mm ² , 300 HB	15	0.020	0.041	0.061	0.076	0.090	0.105	0.130	0.155	0.185	
P2.1.4 Low-alloy steel, heat-treated, Rm 1190 N/mm ² , 350 HB	14	0.016	0.032	0.048	0.060	0.070	0.080	0.100	0.120	0.150	
P3.1.1 High-alloy steel and tool steel, annealed, Rm 680 N/mm ² , 200 HB	15	0.016	0.032	0.048	0.060	0.070	0.080	0.100	0.120	0.150	
P3.1.2 High-alloy steel and tool steel, hardened and tempered, Rm 1100 N/mm ² , 325 HB	11	0.013	0.026	0.039	0.048	0.055	0.065	0.080	0.095	0.120	
M1.1.1 Stainless steel, ferritic/martensitic, with machining additives	17	0.016	0.032	0.048	0.060	0.070	0.080	0.100	0.120	0.150	
M1.1.2 Stainless steel, ferritic/martensitic, annealed, Rm 680 N/mm ² , 200 HB	16	0.016	0.032	0.048	0.060	0.070	0.080	0.100	0.120	0.150	
M1.1.3 Stainless steel, ferritic/martensitic, heat-treated, Rm 810 N/mm ² , 240 HB	15	0.013	0.026	0.039	0.048	0.055	0.065	0.080	0.095	0.120	
M2.1.1 Stainless steel, austenitic, quenched, 180 HB	13	0.016	0.032	0.048	0.060	0.070	0.080	0.100	0.120	0.150	
M2.2.1 Duplex steel, high-strength stainless steels	9	0.013	0.026	0.039	0.048	0.055	0.065	0.080	0.095	0.120	
K1.1.1 Grey cast iron, pearlitic/ferritic, 180 HB	35	0.032	0.064	0.096	0.119	0.140	0.165	0.200	0.240	0.295	
K1.1.2 Grey cast iron, pearlitic/martensitic, 260 HB	28	0.032	0.064	0.096	0.119	0.140	0.165	0.200	0.240	0.295	
K1.2.1 Cast iron with spheroidal graphite, ferritic, 160 HB	29	0.032	0.064	0.096	0.119	0.140	0.165	0.200	0.240	0.295	
K1.2.2 Cast iron with spheroidal graphite, pearlitic, 250 HB	22	0.026	0.051	0.077	0.096	0.115	0.130	0.160	0.190	0.235	
K1.3.1 Malleable cast iron, ferritic, 130 HB	29	0.032	0.064	0.096	0.119	0.140	0.165	0.200	0.240	0.295	
K1.3.2 Malleable cast iron, pearlitic, 230 HB	22	0.026	0.051	0.077	0.096	0.115	0.130	0.160	0.190	0.235	
K2.1.1 Vermicular graphite cast iron (GJV)	29	0.026	0.051	0.077	0.096	0.115	0.130	0.160	0.190	0.235	
K2.2.1 Austenitic-ferritic spheroidal graphite cast iron (ADI)											
N1.1.1 Wrought aluminium alloys, non-hardened, 60 HB	81	0.041	0.082	0.123	0.153	0.180	0.210	0.260	0.305	0.375	
N1.1.2 Wrought aluminium alloys, hardened, 100 HB	81	0.041	0.082	0.123	0.153	0.180	0.210	0.260	0.305	0.375	
N2.1.1 Aluminium casting alloys, non-hardened, ≤ 12 % Si, 75 HB	66	0.032	0.064	0.096	0.119	0.140	0.165	0.200	0.240	0.295	
N2.1.2 Aluminium casting alloys, hardened, ≤ 12 % Si, 90 HB	52	0.026	0.051	0.077	0.096	0.115	0.130	0.160	0.190	0.235	
N2.1.3 Aluminium casting alloys, non-hardened, > 12 % Si, 130 HB	46	0.026	0.051	0.077	0.096	0.115	0.130	0.160	0.190	0.235	
N3.1.1 Copper and copper alloys: Free-machining alloy, Pb > 1 %	60	0.026	0.051	0.077	0.096	0.115	0.130	0.160	0.190	0.235	
N3.1.2 Copper and copper alloys: CuZn, CuSnZn	36	0.020	0.041	0.061	0.076	0.090	0.105	0.130	0.155	0.185	
N3.1.3 Copper and copper alloys: CuSn, lead-free copper and copper electrolyte	48	0.020	0.041	0.061	0.076	0.090	0.105	0.130	0.155	0.185	
N4.1.1 Non-metallic materials: Duroplastics, fibre-reinforced plastics	20	0.020	0.041	0.061	0.076	0.090	0.105	0.130	0.155	0.185	
N4.1.2 Non-metallic materials: Hard rubber, wood, etc.	20	0.020	0.041	0.061	0.076	0.090	0.105	0.130	0.155	0.185	
N4.1.3 Non-metallic materials: Graphite											
S1.1.1 Heat-resistant alloys, Fe-based, annealed, 200 HB	8	0.010	0.020	0.031	0.038	0.045	0.050	0.065	0.075	0.095	
S1.1.2 Heat-resistant alloys, Fe-based, hardened, 280 HB	6	0.008	0.016	0.025	0.031	0.035	0.040	0.050	0.060	0.075	
S1.1.3 Heat-resistant alloys, Ni- or Co-based, annealed, 250 HB	7	0.010	0.020	0.031	0.038	0.045	0.050	0.065	0.075	0.095	
S1.1.4 Heat-resistant alloys, Ni- or Co-based, hardened, 350 HB	4	0.008	0.016	0.025	0.031	0.035	0.040	0.050	0.060	0.075	
S1.1.5 Heat-resistant alloys, Ni- or Co-based, cast, 320 HB	5	0.008	0.016	0.025	0.031	0.035	0.040	0.050	0.060	0.075	
S2.1.1 Titanium alloys, pure titanium, Rm 400 N/mm ²	10	0.013	0.026	0.038	0.048	0.055	0.065	0.080	0.095	0.115	
S2.1.2 Titanium alloys, Alpha and Beta alloys, hardened, Rm 1050 N/mm ²	7	0.010	0.020	0.031	0.038	0.045	0.050	0.065	0.075	0.095	
H1.1.1 Hardened steel, hardened and tempered, < 55 HRC	5	0.010	0.020	0.031	0.038	0.045	0.050	0.065	0.075	0.095	
H1.1.2 Hardened steel, hardened and tempered, < 60 HRC											
H1.1.3 Hardened steel, hardened and tempered, > 60 HRC											
H2.1.1 Chilled cast iron, 400 HB	7	0.016	0.032	0.048	0.060	0.070	0.080	0.100	0.120	0.150	
H2.1.2 Chilled cast iron, hardened and tempered, < 55 HRC											



Jobber drills, type H



Machining group	M42	f (mm/rev) with nom. Ø									
	v _c (m/min)	1	2	3	4	5	6	8	10	13	
P1.1.1 Unalloyed steel, annealed, 0.15 % C, Rm 420 N/mm ² , 125 HB	47	0.040	0.080	0.120	0.149	0.175	0.205	0.255	0.300	0.365	
P1.1.2 Unalloyed steel, heat-treated, 0.15 % C, Rm 420 N/mm ² , 125 HB	40	0.032	0.064	0.096	0.119	0.140	0.165	0.200	0.240	0.295	
P1.1.3 Unalloyed steel, annealed, 0.45 % C, Rm 640 N/mm ² , 190 HB	40	0.032	0.064	0.096	0.119	0.140	0.165	0.200	0.240	0.295	
P1.1.4 Unalloyed steel, heat-treated, 0.45 % C, Rm 640 N/mm ² , 190 HB	40	0.032	0.064	0.096	0.119	0.140	0.165	0.200	0.240	0.295	
P1.1.5 Unalloyed steel, heat-treated, 0.45 % C, Rm 850 N/mm ² , 250 HB	36	0.032	0.064	0.096	0.119	0.140	0.165	0.200	0.240	0.295	
P1.1.6 Unalloyed steel, annealed, 0.75 % C, Rm 915 N/mm ² , 270 HB	33	0.032	0.064	0.096	0.119	0.140	0.165	0.200	0.240	0.295	
P1.1.7 Unalloyed steel, heat-treated, 0.75 % C, Rm 1020 N/mm ² , 300 HB	28	0.032	0.064	0.096	0.119	0.140	0.165	0.200	0.240	0.295	
P2.1.1 Low-alloy steel, annealed, Rm 610 N/mm ² , 180 HB	32	0.032	0.064	0.096	0.119	0.140	0.165	0.200	0.240	0.295	
P2.1.2 Low-alloy steel, heat-treated, Rm 930 N/mm ² , 275 HB	22	0.026	0.051	0.077	0.096	0.115	0.130	0.160	0.190	0.235	
P2.1.3 Low-alloy steel, heat-treated, Rm 1020 N/mm ² , 300 HB	19	0.026	0.051	0.077	0.096	0.115	0.130	0.160	0.190	0.235	
P2.1.4 Low-alloy steel, heat-treated, Rm 1190 N/mm ² , 350 HB	17	0.020	0.040	0.060	0.075	0.090	0.100	0.125	0.150	0.185	
P3.1.1 High-alloy steel and tool steel, annealed, Rm 680 N/mm ² , 200 HB	20	0.026	0.051	0.077	0.096	0.115	0.130	0.160	0.190	0.235	
P3.1.2 High-alloy steel and tool steel, hardened and tempered, Rm 1100 N/mm ² , 325 HB	15	0.020	0.041	0.061	0.076	0.090	0.105	0.130	0.155	0.185	
M1.1.1 Stainless steel, ferritic/martensitic, with machining additives	20	0.020	0.040	0.060	0.075	0.090	0.100	0.125	0.150	0.185	
M1.1.2 Stainless steel, ferritic/martensitic, annealed, Rm 680 N/mm ² , 200 HB	18	0.020	0.040	0.060	0.075	0.090	0.100	0.125	0.150	0.185	
M1.1.3 Stainless steel, ferritic/martensitic, heat-treated, Rm 810 N/mm ² , 240 HB	17	0.016	0.032	0.048	0.060	0.070	0.080	0.100	0.120	0.150	
M2.1.1 Stainless steel, austenitic, quenched, 180 HB	14	0.020	0.040	0.060	0.075	0.090	0.100	0.125	0.150	0.185	
M2.2.1 Duplex steel, high-strength stainless steels	10	0.016	0.032	0.048	0.060	0.070	0.080	0.100	0.120	0.150	
K1.1.1 Grey cast iron, pearlitic/ferritic, 180 HB	43	0.040	0.080	0.120	0.149	0.175	0.205	0.255	0.300	0.365	
K1.1.2 Grey cast iron, pearlitic/martensitic, 260 HB	35	0.040	0.080	0.120	0.149	0.175	0.205	0.255	0.300	0.365	
K1.2.1 Cast iron with spheroidal graphite, ferritic, 160 HB	37	0.040	0.080	0.120	0.149	0.175	0.205	0.255	0.300	0.365	
K1.2.2 Cast iron with spheroidal graphite, pearlitic, 250 HB	28	0.032	0.064	0.096	0.119	0.140	0.165	0.200	0.240	0.295	
K1.3.1 Malleable cast iron, ferritic, 130 HB	37	0.040	0.080	0.120	0.149	0.175	0.205	0.255	0.300	0.365	
K1.3.2 Malleable cast iron, pearlitic, 230 HB	28	0.032	0.064	0.096	0.119	0.140	0.165	0.200	0.240	0.295	
K2.1.1 Vermicular graphite cast iron (GJV)	37	0.032	0.064	0.096	0.119	0.140	0.165	0.200	0.240	0.295	
K2.2.1 Austenitic-ferritic spheroidal graphite cast iron (ADI)											
N1.1.1 Wrought aluminium alloys, non-hardened, 60 HB											
N1.1.2 Wrought aluminium alloys, hardened, 100 HB											
N2.1.1 Aluminium casting alloys, non-hardened, ≤ 12 % Si, 75 HB											
N2.1.2 Aluminium casting alloys, hardened, ≤ 12 % Si, 90 HB											
N2.1.3 Aluminium casting alloys, non-hardened, > 12 % Si, 130 HB											
N3.1.1 Copper and copper alloys: Free-machining alloy, Pb > 1 %	78	0.032	0.064	0.096	0.119	0.140	0.165	0.200	0.240	0.295	
N3.1.2 Copper and copper alloys: CuZn, CuSnZn	47	0.026	0.051	0.077	0.096	0.115	0.130	0.160	0.190	0.235	
N3.1.3 Copper and copper alloys: CuSn, lead-free copper and copper electrolyte	62	0.026	0.051	0.077	0.096	0.115	0.130	0.160	0.190	0.235	
N4.1.1 Non-metallic materials: Duroplastics, fibre-reinforced plastics	24	0.032	0.064	0.096	0.119	0.140	0.165	0.200	0.240	0.295	
N4.1.2 Non-metallic materials: Hard rubber, wood, etc.	24	0.032	0.064	0.096	0.119	0.140	0.165	0.200	0.240	0.295	
N4.1.3 Non-metallic materials: Graphite											
S1.1.1 Heat-resistant alloys, Fe-based, annealed, 200 HB	10	0.013	0.026	0.038	0.048	0.055	0.065	0.080	0.095	0.115	
S1.1.2 Heat-resistant alloys, Fe-based, hardened, 280 HB	8	0.010	0.020	0.031	0.038	0.045	0.050	0.065	0.075	0.095	
S1.1.3 Heat-resistant alloys, Ni- or Co-based, annealed, 250 HB	9	0.013	0.026	0.038	0.048	0.055	0.065	0.080	0.095	0.115	
S1.1.4 Heat-resistant alloys, Ni- or Co-based, hardened, 350 HB	5	0.010	0.020	0.031	0.038	0.045	0.050	0.065	0.075	0.095	
S1.1.5 Heat-resistant alloys, Ni- or Co-based, cast, 320 HB	6	0.010	0.020	0.031	0.038	0.045	0.050	0.065	0.075	0.095	
S2.1.1 Titanium alloys, pure titanium, Rm 400 N/mm ²	13	0.016	0.032	0.048	0.060	0.070	0.080	0.100	0.120	0.145	
S2.1.2 Titanium alloys, Alpha and Beta alloys, hardened, Rm 1050 N/mm ²	8	0.013	0.026	0.038	0.048	0.055	0.065	0.080	0.095	0.115	
H1.1.1 Hardened steel, hardened and tempered, < 55 HRC	4	0.013	0.026	0.038	0.048	0.055	0.065	0.080	0.095	0.115	
H1.1.2 Hardened steel, hardened and tempered, < 60 HRC											
H1.1.3 Hardened steel, hardened and tempered, > 60 HRC											
H2.1.1 Chilled cast iron, 400 HB	10	0.020	0.040	0.060	0.075	0.090	0.100	0.125	0.150	0.185	
H2.1.2 Chilled cast iron, hardened and tempered, < 55 HRC											



Long series twist drills, type N



Cutting data

Machining group	HSS		HSCO	f (mm/rev) with nom. Ø									
	v _c (m/min)			0,5	3	5	8	12	16	20	30	50	
P1.1.1 Unalloyed steel, annealed, 0.15 % C, Rm 420 N/mm ² , 125 HB	25	29	29	0.016	0.096	0.140	0.200	0.275	0.345	0.405	0.555	0.815	
P1.1.2 Unalloyed steel, heat-treated, 0.15 % C, Rm 420 N/mm ² , 125 HB	21	25	25	0.013	0.077	0.115	0.160	0.220	0.275	0.325	0.440	0.650	
P1.1.3 Unalloyed steel, annealed, 0.45 % C, Rm 640 N/mm ² , 190 HB	21	25	25	0.013	0.077	0.115	0.160	0.220	0.275	0.325	0.440	0.650	
P1.1.4 Unalloyed steel, heat-treated, 0.45 % C, Rm 640 N/mm ² , 190 HB	21	25	25	0.013	0.077	0.115	0.160	0.220	0.275	0.325	0.440	0.650	
P1.1.5 Unalloyed steel, heat-treated, 0.45 % C, Rm 850 N/mm ² , 250 HB	19	22	22	0.013	0.077	0.115	0.160	0.220	0.275	0.325	0.440	0.650	
P1.1.6 Unalloyed steel, annealed, 0.75 % C, Rm 915 N/mm ² , 270 HB	18	20	20	0.013	0.077	0.115	0.160	0.220	0.275	0.325	0.440	0.650	
P1.1.7 Unalloyed steel, heat-treated, 0.75 % C, Rm 1020 N/mm ² , 300 HB	15	17	17	0.013	0.077	0.115	0.160	0.220	0.275	0.325	0.440	0.650	
P2.1.1 Low-alloy steel, annealed, Rm 610 N/mm ² , 180 HB	15	18	18	0.010	0.061	0.090	0.130	0.175	0.220	0.260	0.355	0.520	
P2.1.2 Low-alloy steel, heat-treated, Rm 930 N/mm ² , 275 HB	11	12	12	0.008	0.049	0.070	0.105	0.140	0.175	0.210	0.285	0.415	
P2.1.3 Low-alloy steel, heat-treated, Rm 1020 N/mm ² , 300 HB	9	11	11	0.008	0.049	0.070	0.105	0.140	0.175	0.210	0.285	0.415	
P2.1.4 Low-alloy steel, heat-treated, Rm 1190 N/mm ² , 350 HB	8	10	10	0.006	0.039	0.055	0.080	0.110	0.140	0.165	0.225	0.330	
P3.1.1 High-alloy steel and tool steel, annealed, Rm 680 N/mm ² , 200 HB	12	13	13	0.010	0.061	0.090	0.130	0.175	0.220	0.260	0.355	0.520	
P3.1.2 High-alloy steel and tool steel, hardened and tempered, Rm 1100 N/mm ² , 325 HB			10	0.008	0.049	0.070	0.105	0.140	0.175	0.210	0.285	0.415	
M1.1.1 Stainless steel, ferritic/martensitic, with machining additives			10	0.008	0.048	0.070	0.100	0.140	0.175	0.205	0.280	0.410	
M1.1.2 Stainless steel, ferritic/martensitic, annealed, Rm 680 N/mm ² , 200 HB			9	0.008	0.048	0.070	0.100	0.140	0.175	0.205	0.280	0.410	
M1.1.3 Stainless steel, ferritic/martensitic, heat-treated, Rm 810 N/mm ² , 240 HB			9	0.006	0.039	0.055	0.080	0.110	0.140	0.165	0.225	0.330	
M2.1.1 Stainless steel, austenitic, quenched, 180 HB			8	0.008	0.048	0.070	0.100	0.140	0.175	0.205	0.280	0.410	
M2.2.1 Duplex steel, high-strength stainless steels													
K1.1.1 Grey cast iron, pearlitic/ferritic, 180 HB	27	31	31	0.016	0.096	0.140	0.200	0.275	0.345	0.405	0.555	0.815	
K1.1.2 Grey cast iron, pearlitic/martensitic, 260 HB	22	25	25	0.016	0.096	0.140	0.200	0.275	0.345	0.405	0.555	0.815	
K1.2.1 Cast iron with spheroidal graphite, ferritic, 160 HB	23	26	26	0.016	0.096	0.140	0.200	0.275	0.345	0.405	0.555	0.815	
K1.2.2 Cast iron with spheroidal graphite, pearlitic, 250 HB	18	20	20	0.013	0.077	0.115	0.160	0.220	0.275	0.325	0.440	0.650	
K1.3.1 Malleable cast iron, ferritic, 130 HB	23	26	26	0.016	0.096	0.140	0.200	0.275	0.345	0.405	0.555	0.815	
K1.3.2 Malleable cast iron, pearlitic, 230 HB	18	20	20	0.013	0.077	0.115	0.160	0.220	0.275	0.325	0.440	0.650	
K2.1.1 Vermicular graphite cast iron (GJV)	23	26	26	0.013	0.077	0.115	0.160	0.220	0.275	0.325	0.440	0.650	
K2.2.1 Austenitic-ferritic spheroidal graphite cast iron (ADI)													
N1.1.1 Wrought aluminium alloys, non-hardened, 60 HB													
N1.1.2 Wrought aluminium alloys, hardened, 100 HB													
N2.1.1 Aluminium casting alloys, non-hardened, ≤ 12 % Si, 75 HB	45	52	52	0.016	0.096	0.140	0.200	0.275	0.345	0.405	0.555	0.815	
N2.1.2 Aluminium casting alloys, hardened, ≤ 12 % Si, 90 HB	36	41	41	0.013	0.077	0.115	0.160	0.220	0.275	0.325	0.440	0.650	
N2.1.3 Aluminium casting alloys, non-hardened, > 12 % Si, 130 HB	32	36	36	0.013	0.077	0.115	0.160	0.220	0.275	0.325	0.440	0.650	
N3.1.1 Copper and copper alloys: Free-machining alloy, Pb > 1 %	54	62	62	0.013	0.077	0.115	0.160	0.220	0.275	0.325	0.440	0.650	
N3.1.2 Copper and copper alloys: CuZn, CuSnZn	32	37	37	0.010	0.061	0.090	0.130	0.175	0.220	0.260	0.355	0.520	
N3.1.3 Copper and copper alloys: CuSn, lead-free copper and copper electrolyte	43	50	50	0.010	0.061	0.090	0.130	0.175	0.220	0.260	0.355	0.520	
N4.1.1 Non-metallic materials: Duroplastics, fibre-reinforced plastics	18	21	21	0.013	0.077	0.115	0.160	0.220	0.275	0.325	0.440	0.650	
N4.1.2 Non-metallic materials: Hard rubber, wood, etc.	18	21	21	0.013	0.077	0.115	0.160	0.220	0.275	0.325	0.440	0.650	
N4.1.3 Non-metallic materials: Graphite													
S1.1.1 Heat-resistant alloys, Fe-based, annealed, 200 HB													
S1.1.2 Heat-resistant alloys, Fe-based, hardened, 280 HB													
S1.1.3 Heat-resistant alloys, Ni- or Co-based, annealed, 250 HB													
S1.1.4 Heat-resistant alloys, Ni- or Co-based, hardened, 350 HB													
S1.1.5 Heat-resistant alloys, Ni- or Co-based, cast, 320 HB													
S2.1.1 Titanium alloys, pure titanium, Rm 400 N/mm ²													
S2.1.2 Titanium alloys, Alpha and Beta alloys, hardened, Rm 1050 N/mm ²													
H1.1.1 Hardened steel, hardened and tempered, < 55 HRC													
H1.1.2 Hardened steel, hardened and tempered, < 60 HRC													
H1.1.3 Hardened steel, hardened and tempered, > 60 HRC													
H2.1.1 Chilled cast iron, 400 HB													
H2.1.2 Chilled cast iron, hardened and tempered, < 55 HRC													



Long series twist drills, type H



Machining group	HSS	f (mm/rev) with nom. Ø									
	○										
	v _c (m/min)	0,5	2	3	4	5	8	10	12	16	
P1.1.1 Unalloyed steel, annealed, 0.15 % C, Rm 420 N/mm ² , 125 HB											
P1.1.2 Unalloyed steel, heat-treated, 0.15 % C, Rm 420 N/mm ² , 125 HB											
P1.1.3 Unalloyed steel, annealed, 0.45 % C, Rm 640 N/mm ² , 190 HB											
P1.1.4 Unalloyed steel, heat-treated, 0.45 % C, Rm 640 N/mm ² , 190 HB											
P1.1.5 Unalloyed steel, heat-treated, 0.45 % C, Rm 850 N/mm ² , 250 HB											
P1.1.6 Unalloyed steel, annealed, 0.75 % C, Rm 915 N/mm ² , 270 HB											
P1.1.7 Unalloyed steel, heat-treated, 0.75 % C, Rm 1020 N/mm ² , 300 HB											
P2.1.1 Low-alloy steel, annealed, Rm 610 N/mm ² , 180 HB											
P2.1.2 Low-alloy steel, heat-treated, Rm 930 N/mm ² , 275 HB											
P2.1.3 Low-alloy steel, heat-treated, Rm 1020 N/mm ² , 300 HB											
P2.1.4 Low-alloy steel, heat-treated, Rm 1190 N/mm ² , 350 HB											
P3.1.1 High-alloy steel and tool steel, annealed, Rm 680 N/mm ² , 200 HB											
P3.1.2 High-alloy steel and tool steel, hardened and tempered, Rm 1100 N/mm ² , 325 HB											
M1.1.1 Stainless steel, ferritic/martensitic, with machining additives											
M1.1.2 Stainless steel, ferritic/martensitic, annealed, Rm 680 N/mm ² , 200 HB											
M1.1.3 Stainless steel, ferritic/martensitic, heat-treated, Rm 810 N/mm ² , 240 HB											
M2.1.1 Stainless steel, austenitic, quenched, 180 HB											
M2.2.1 Duplex steel, high-strength stainless steels											
K1.1.1 Grey cast iron, pearlitic/ferritic, 180 HB											
K1.1.2 Grey cast iron, pearlitic/martensitic, 260 HB											
K1.2.1 Cast iron with spheroidal graphite, ferritic, 160 HB											
K1.2.2 Cast iron with spheroidal graphite, pearlitic, 250 HB											
K1.3.1 Malleable cast iron, ferritic, 130 HB											
K1.3.2 Malleable cast iron, pearlitic, 230 HB											
K2.1.1 Vermicular graphite cast iron (GJV)											
K2.2.1 Austenitic-ferritic spheroidal graphite cast iron (ADI)											
N1.1.1 Wrought aluminium alloys, non-hardened, 60 HB											
N1.1.2 Wrought aluminium alloys, hardened, 100 HB											
N2.1.1 Aluminium casting alloys, non-hardened, ≤ 12 % Si, 75 HB											
N2.1.2 Aluminium casting alloys, hardened, ≤ 12 % Si, 90 HB											
N2.1.3 Aluminium casting alloys, non-hardened, > 12 % Si, 130 HB											
N3.1.1 Copper and copper alloys: Free-machining alloy, Pb > 1 %	63	0.013	0.051	0.077	0.096	0.115	0.160	0.190	0.220	0.275	
N3.1.2 Copper and copper alloys: CuZn, CuSnZn	38	0.010	0.041	0.061	0.076	0.090	0.130	0.155	0.175	0.220	
N3.1.3 Copper and copper alloys: CuSn, lead-free copper and copper electrolyte											
N4.1.1 Non-metallic materials: Duroplastics, fibre-reinforced plastics	18	0.013	0.051	0.077	0.096	0.115	0.160	0.190	0.220	0.275	
N4.1.2 Non-metallic materials: Hard rubber, wood, etc.	18	0.013	0.051	0.077	0.096	0.115	0.160	0.190	0.220	0.275	
N4.1.3 Non-metallic materials: Graphite											
S1.1.1 Heat-resistant alloys, Fe-based, annealed, 200 HB											
S1.1.2 Heat-resistant alloys, Fe-based, hardened, 280 HB											
S1.1.3 Heat-resistant alloys, Ni- or Co-based, annealed, 250 HB											
S1.1.4 Heat-resistant alloys, Ni- or Co-based, hardened, 350 HB											
S1.1.5 Heat-resistant alloys, Ni- or Co-based, cast, 320 HB											
S2.1.1 Titanium alloys, pure titanium, Rm 400 N/mm ²											
S2.1.2 Titanium alloys, Alpha and Beta alloys, hardened, Rm 1050 N/mm ²											
H1.1.1 Hardened steel, hardened and tempered, < 55 HRC											
H1.1.2 Hardened steel, hardened and tempered, < 60 HRC											
H1.1.3 Hardened steel, hardened and tempered, > 60 HRC											
H2.1.1 Chilled cast iron, 400 HB											
H2.1.2 Chilled cast iron, hardened and tempered, < 55 HRC											



Long series twist drills, type W



Machining group	HSS	f (mm/rev) with nom. Ø									
	○										
	v _c (m/min)	0,5	3	5	8	10	12	14	16	20	
P1.1.1 Unalloyed steel, annealed, 0.15 % C, Rm 420 N/mm ² , 125 HB											
P1.1.2 Unalloyed steel, heat-treated, 0.15 % C, Rm 420 N/mm ² , 125 HB											
P1.1.3 Unalloyed steel, annealed, 0.45 % C, Rm 640 N/mm ² , 190 HB											
P1.1.4 Unalloyed steel, heat-treated, 0.45 % C, Rm 640 N/mm ² , 190 HB											
P1.1.5 Unalloyed steel, heat-treated, 0.45 % C, Rm 850 N/mm ² , 250 HB											
P1.1.6 Unalloyed steel, annealed, 0.75 % C, Rm 915 N/mm ² , 270 HB											
P1.1.7 Unalloyed steel, heat-treated, 0.75 % C, Rm 1020 N/mm ² , 300 HB											
P2.1.1 Low-alloy steel, annealed, Rm 610 N/mm ² , 180 HB											
P2.1.2 Low-alloy steel, heat-treated, Rm 930 N/mm ² , 275 HB											
P2.1.3 Low-alloy steel, heat-treated, Rm 1020 N/mm ² , 300 HB											
P2.1.4 Low-alloy steel, heat-treated, Rm 1190 N/mm ² , 350 HB											
P3.1.1 High-alloy steel and tool steel, annealed, Rm 680 N/mm ² , 200 HB											
P3.1.2 High-alloy steel and tool steel, hardened and tempered, Rm 1100 N/mm ² , 325 HB											
M1.1.1 Stainless steel, ferritic/martensitic, with machining additives											
M1.1.2 Stainless steel, ferritic/martensitic, annealed, Rm 680 N/mm ² , 200 HB											
M1.1.3 Stainless steel, ferritic/martensitic, heat-treated, Rm 810 N/mm ² , 240 HB											
M2.1.1 Stainless steel, austenitic, quenched, 180 HB											
M2.2.1 Duplex steel, high-strength stainless steels											
K1.1.1 Grey cast iron, pearlitic/ferritic, 180 HB											
K1.1.2 Grey cast iron, pearlitic/martensitic, 260 HB											
K1.2.1 Cast iron with spheroidal graphite, ferritic, 160 HB											
K1.2.2 Cast iron with spheroidal graphite, pearlitic, 250 HB											
K1.3.1 Malleable cast iron, ferritic, 130 HB											
K1.3.2 Malleable cast iron, pearlitic, 230 HB											
K2.1.1 Vermicular graphite cast iron (GJV)											
K2.2.1 Austenitic-ferritic spheroidal graphite cast iron (ADI)											
N1.1.1 Wrought aluminium alloys, non-hardened, 60 HB	63	0.020	0.123	0.180	0.260	0.305	0.355	0.395	0.440	0.520	
N1.1.2 Wrought aluminium alloys, hardened, 100 HB	63	0.020	0.123	0.180	0.260	0.305	0.355	0.395	0.440	0.520	
N2.1.1 Aluminium casting alloys, non-hardened, ≤ 12 % Si, 75 HB	54	0.016	0.096	0.140	0.200	0.240	0.275	0.310	0.345	0.405	
N2.1.2 Aluminium casting alloys, hardened, ≤ 12 % Si, 90 HB											
N2.1.3 Aluminium casting alloys, non-hardened, > 12 % Si, 130 HB											
N3.1.1 Copper and copper alloys: Free-machining alloy, Pb > 1 %											
N3.1.2 Copper and copper alloys: CuZn, CuSnZn											
N3.1.3 Copper and copper alloys: CuSn, lead-free copper and copper electrolyte											
N4.1.1 Non-metallic materials: Duroplastics, fibre-reinforced plastics											
N4.1.2 Non-metallic materials: Hard rubber, wood, etc.											
N4.1.3 Non-metallic materials: Graphite											
S1.1.1 Heat-resistant alloys, Fe-based, annealed, 200 HB											
S1.1.2 Heat-resistant alloys, Fe-based, hardened, 280 HB											
S1.1.3 Heat-resistant alloys, Ni- or Co-based, annealed, 250 HB											
S1.1.4 Heat-resistant alloys, Ni- or Co-based, hardened, 350 HB											
S1.1.5 Heat-resistant alloys, Ni- or Co-based, cast, 320 HB											
S2.1.1 Titanium alloys, pure titanium, Rm 400 N/mm ²											
S2.1.2 Titanium alloys, Alpha and Beta alloys, hardened, Rm 1050 N/mm ²											
H1.1.1 Hardened steel, hardened and tempered, < 55 HRC											
H1.1.2 Hardened steel, hardened and tempered, < 60 HRC											
H1.1.3 Hardened steel, hardened and tempered, > 60 HRC											
H2.1.1 Chilled cast iron, 400 HB											
H2.1.2 Chilled cast iron, hardened and tempered, < 55 HRC											



Long series twist drills, GT 100, bright/nitrided lands and TiN



Machining group	HSS		HSCO	f (mm/rev) with nom. Ø									
	v _c (m/min)			1	3	5	8	10	12	16	20	32	
P1.1.1 Unalloyed steel, annealed, 0.15 % C, Rm 420 N/mm ² , 125 HB	25	29	29	0.032	0.096	0.140	0.200	0.240	0.275	0.345	0.405	0.580	
P1.1.2 Unalloyed steel, heat-treated, 0.15 % C, Rm 420 N/mm ² , 125 HB	21	25	25	0.026	0.077	0.115	0.160	0.190	0.220	0.275	0.325	0.465	
P1.1.3 Unalloyed steel, annealed, 0.45 % C, Rm 640 N/mm ² , 190 HB	21	25	25	0.026	0.077	0.115	0.160	0.190	0.220	0.275	0.325	0.465	
P1.1.4 Unalloyed steel, heat-treated, 0.45 % C, Rm 640 N/mm ² , 190 HB	21	25	25	0.026	0.077	0.115	0.160	0.190	0.220	0.275	0.325	0.465	
P1.1.5 Unalloyed steel, heat-treated, 0.45 % C, Rm 850 N/mm ² , 250 HB	19	22	22	0.026	0.077	0.115	0.160	0.190	0.220	0.275	0.325	0.465	
P1.1.6 Unalloyed steel, annealed, 0.75 % C, Rm 915 N/mm ² , 270 HB	18	20	20	0.026	0.077	0.115	0.160	0.190	0.220	0.275	0.325	0.465	
P1.1.7 Unalloyed steel, heat-treated, 0.75 % C, Rm 1020 N/mm ² , 300 HB	15	17	17	0.026	0.077	0.115	0.160	0.190	0.220	0.275	0.325	0.465	
P2.1.1 Low-alloy steel, annealed, Rm 610 N/mm ² , 180 HB	15	18	18	0.026	0.077	0.115	0.160	0.190	0.220	0.275	0.325	0.465	
P2.1.2 Low-alloy steel, heat-treated, Rm 930 N/mm ² , 275 HB	11	12	12	0.020	0.061	0.090	0.130	0.155	0.175	0.220	0.260	0.370	
P2.1.3 Low-alloy steel, heat-treated, Rm 1020 N/mm ² , 300 HB	9	11	11	0.020	0.061	0.090	0.130	0.155	0.175	0.220	0.260	0.370	
P2.1.4 Low-alloy steel, heat-treated, Rm 1190 N/mm ² , 350 HB	8	10	10	0.016	0.048	0.070	0.100	0.120	0.140	0.175	0.205	0.295	
P3.1.1 High-alloy steel and tool steel, annealed, Rm 680 N/mm ² , 200 HB	12	13	13	0.020	0.061	0.090	0.130	0.155	0.175	0.220	0.260	0.370	
P3.1.2 High-alloy steel and tool steel, hardened and tempered, Rm 1100 N/mm ² , 325 HB	9	10	10	0.016	0.049	0.070	0.105	0.125	0.140	0.175	0.210	0.295	
M1.1.1 Stainless steel, ferritic/martensitic, with machining additives			10	0.016	0.048	0.070	0.100	0.120	0.140	0.175	0.205	0.295	
M1.1.2 Stainless steel, ferritic/martensitic, annealed, Rm 680 N/mm ² , 200 HB			9	0.016	0.048	0.070	0.100	0.120	0.140	0.175	0.205	0.295	
M1.1.3 Stainless steel, ferritic/martensitic, heat-treated, Rm 810 N/mm ² , 240 HB			9	0.013	0.039	0.055	0.080	0.095	0.110	0.140	0.165	0.235	
M2.1.1 Stainless steel, austenitic, quenched, 180 HB			8	0.016	0.048	0.070	0.100	0.120	0.140	0.175	0.205	0.295	
M2.2.1 Duplex steel, high-strength stainless steels													
K1.1.1 Grey cast iron, pearlitic/ferritic, 180 HB	27	31	31	0.032	0.096	0.140	0.200	0.240	0.275	0.345	0.405	0.580	
K1.1.2 Grey cast iron, pearlitic/martensitic, 260 HB	22	25	25	0.032	0.096	0.140	0.200	0.240	0.275	0.345	0.405	0.580	
K1.2.1 Cast iron with spheroidal graphite, ferritic, 160 HB	23	26	26	0.032	0.096	0.140	0.200	0.240	0.275	0.345	0.405	0.580	
K1.2.2 Cast iron with spheroidal graphite, pearlitic, 250 HB	18	20	20	0.026	0.077	0.115	0.160	0.190	0.220	0.275	0.325	0.465	
K1.3.1 Malleable cast iron, ferritic, 130 HB	23	26	26	0.032	0.096	0.140	0.200	0.240	0.275	0.345	0.405	0.580	
K1.3.2 Malleable cast iron, pearlitic, 230 HB	18	20	20	0.026	0.077	0.115	0.160	0.190	0.220	0.275	0.325	0.465	
K2.1.1 Vermicular graphite cast iron (GJV)	23	26	26	0.026	0.077	0.115	0.160	0.190	0.220	0.275	0.325	0.465	
K2.2.1 Austenitic-ferritic spheroidal graphite cast iron (ADI)		13		0.013	0.038	0.055	0.080	0.095	0.110	0.135	0.160	0.230	
N1.1.1 Wrought aluminium alloys, non-hardened, 60 HB	54		62	0.041	0.123	0.180	0.260	0.305	0.355	0.440	0.520	0.745	
N1.1.2 Wrought aluminium alloys, hardened, 100 HB	54		62	0.041	0.123	0.180	0.260	0.305	0.355	0.440	0.520	0.745	
N2.1.1 Aluminium casting alloys, non-hardened, ≤ 12 % Si, 75 HB	45	52	52	0.032	0.096	0.140	0.200	0.240	0.275	0.345	0.405	0.580	
N2.1.2 Aluminium casting alloys, hardened, ≤ 12 % Si, 90 HB	36	41	41	0.026	0.077	0.115	0.160	0.190	0.220	0.275	0.325	0.465	
N2.1.3 Aluminium casting alloys, non-hardened, > 12 % Si, 130 HB	32	36	36	0.026	0.077	0.115	0.160	0.190	0.220	0.275	0.325	0.465	
N3.1.1 Copper and copper alloys: Free-machining alloy, Pb > 1 %	54	62	62	0.026	0.077	0.115	0.160	0.190	0.220	0.275	0.325	0.465	
N3.1.2 Copper and copper alloys: CuZn, CuSnZn	32	37	37	0.020	0.061	0.090	0.130	0.155	0.175	0.220	0.260	0.370	
N3.1.3 Copper and copper alloys: CuSn, lead-free copper and copper electrolyte	43	50	50	0.020	0.061	0.090	0.130	0.155	0.175	0.220	0.260	0.370	
N4.1.1 Non-metallic materials: Duroplastics, fibre-reinforced plastics	18	21	21	0.020	0.061	0.090	0.130	0.155	0.175	0.220	0.260	0.370	
N4.1.2 Non-metallic materials: Hard rubber, wood, etc.	18	21	21	0.020	0.061	0.090	0.130	0.155	0.175	0.220	0.260	0.370	
N4.1.3 Non-metallic materials: Graphite													
S1.1.1 Heat-resistant alloys, Fe-based, annealed, 200 HB			6	0.013	0.038	0.055	0.080	0.095	0.110	0.135	0.160	0.230	
S1.1.2 Heat-resistant alloys, Fe-based, hardened, 280 HB			5	0.010	0.031	0.045	0.065	0.075	0.090	0.110	0.130	0.185	
S1.1.3 Heat-resistant alloys, Ni- or Co-based, annealed, 250 HB			5	0.013	0.038	0.055	0.080	0.095	0.110	0.135	0.160	0.230	
S1.1.4 Heat-resistant alloys, Ni- or Co-based, hardened, 350 HB			3	0.010	0.031	0.045	0.065	0.075	0.090	0.110	0.130	0.185	
S1.1.5 Heat-resistant alloys, Ni- or Co-based, cast, 320 HB			4	0.010	0.031	0.045	0.065	0.075	0.090	0.110	0.130	0.185	
S2.1.1 Titanium alloys, pure titanium, Rm 400 N/mm ²			5	0.013	0.038	0.055	0.080	0.095	0.110	0.135	0.160	0.230	
S2.1.2 Titanium alloys, Alpha and Beta alloys, hardened, Rm 1050 N/mm ²			3	0.010	0.031	0.045	0.065	0.075	0.090	0.110	0.130	0.185	
H1.1.1 Hardened steel, hardened and tempered, < 55 HRC			4	0.010	0.031	0.045	0.065	0.075	0.090	0.110	0.130	0.185	
H1.1.2 Hardened steel, hardened and tempered, < 60 HRC													
H1.1.3 Hardened steel, hardened and tempered, > 60 HRC													
H2.1.1 Chilled cast iron, 400 HB			8	0.016	0.048	0.070	0.100	0.120	0.140	0.175	0.205	0.295	
H2.1.2 Chilled cast iron, hardened and tempered, < 55 HRC													



Long series twist drills, GT 100, nanoFIRE



Machining group	HSCO	f (mm/rev) with nom. Ø									
	F										
	v _c (m/min)	1	2	3	4	5	6	8	10	12	
P1.1.1 Unalloyed steel, annealed, 0.15 % C, Rm 420 N/mm ² , 125 HB	36	0.040	0.080	0.120	0.149	0.175	0.205	0.255	0.300	0.345	
P1.1.2 Unalloyed steel, heat-treated, 0.15 % C, Rm 420 N/mm ² , 125 HB	31	0.032	0.064	0.096	0.119	0.140	0.165	0.200	0.240	0.275	
P1.1.3 Unalloyed steel, annealed, 0.45 % C, Rm 640 N/mm ² , 190 HB	31	0.032	0.064	0.096	0.119	0.140	0.165	0.200	0.240	0.275	
P1.1.4 Unalloyed steel, heat-treated, 0.45 % C, Rm 640 N/mm ² , 190 HB	31	0.032	0.064	0.096	0.119	0.140	0.165	0.200	0.240	0.275	
P1.1.5 Unalloyed steel, heat-treated, 0.45 % C, Rm 850 N/mm ² , 250 HB	27	0.032	0.064	0.096	0.119	0.140	0.165	0.200	0.240	0.275	
P1.1.6 Unalloyed steel, annealed, 0.75 % C, Rm 915 N/mm ² , 270 HB	25	0.032	0.064	0.096	0.119	0.140	0.165	0.200	0.240	0.275	
P1.1.7 Unalloyed steel, heat-treated, 0.75 % C, Rm 1020 N/mm ² , 300 HB	22	0.032	0.064	0.096	0.119	0.140	0.165	0.200	0.240	0.275	
P2.1.1 Low-alloy steel, annealed, Rm 610 N/mm ² , 180 HB	22	0.032	0.064	0.096	0.119	0.140	0.165	0.200	0.240	0.275	
P2.1.2 Low-alloy steel, heat-treated, Rm 930 N/mm ² , 275 HB	15	0.026	0.051	0.077	0.096	0.115	0.130	0.160	0.190	0.220	
P2.1.3 Low-alloy steel, heat-treated, Rm 1020 N/mm ² , 300 HB	13	0.026	0.051	0.077	0.096	0.115	0.130	0.160	0.190	0.220	
P2.1.4 Low-alloy steel, heat-treated, Rm 1190 N/mm ² , 350 HB	12	0.020	0.040	0.060	0.075	0.090	0.100	0.125	0.150	0.175	
P3.1.1 High-alloy steel and tool steel, annealed, Rm 680 N/mm ² , 200 HB	17	0.026	0.051	0.077	0.096	0.115	0.130	0.160	0.190	0.220	
P3.1.2 High-alloy steel and tool steel, hardened and tempered, Rm 1100 N/mm ² , 325 HB	13	0.020	0.041	0.061	0.076	0.090	0.105	0.130	0.155	0.175	
M1.1.1 Stainless steel, ferritic/martensitic, with machining additives	13	0.020	0.040	0.060	0.075	0.090	0.100	0.125	0.150	0.175	
M1.1.2 Stainless steel, ferritic/martensitic, annealed, Rm 680 N/mm ² , 200 HB	12	0.020	0.040	0.060	0.075	0.090	0.100	0.125	0.150	0.175	
M1.1.3 Stainless steel, ferritic/martensitic, heat-treated, Rm 810 N/mm ² , 240 HB	11	0.016	0.032	0.048	0.060	0.070	0.080	0.100	0.120	0.140	
M2.1.1 Stainless steel, austenitic, quenched, 180 HB	10	0.020	0.040	0.060	0.075	0.090	0.100	0.125	0.150	0.175	
M2.2.1 Duplex steel, high-strength stainless steels											
K1.1.1 Grey cast iron, pearlitic/ferritic, 180 HB	39	0.040	0.080	0.120	0.149	0.175	0.205	0.255	0.300	0.345	
K1.1.2 Grey cast iron, pearlitic/martensitic, 260 HB	31	0.040	0.080	0.120	0.149	0.175	0.205	0.255	0.300	0.345	
K1.2.1 Cast iron with spheroidal graphite, ferritic, 160 HB	33	0.040	0.080	0.120	0.149	0.175	0.205	0.255	0.300	0.345	
K1.2.2 Cast iron with spheroidal graphite, pearlitic, 250 HB	25	0.032	0.064	0.096	0.119	0.140	0.165	0.200	0.240	0.275	
K1.3.1 Malleable cast iron, ferritic, 130 HB	33	0.040	0.080	0.120	0.149	0.175	0.205	0.255	0.300	0.345	
K1.3.2 Malleable cast iron, pearlitic, 230 HB	25	0.032	0.064	0.096	0.119	0.140	0.165	0.200	0.240	0.275	
K2.1.1 Vermicular graphite cast iron (GJV)	32	0.032	0.064	0.096	0.119	0.140	0.165	0.200	0.240	0.275	
K2.2.1 Austenitic-ferritic spheroidal graphite cast iron (ADI)	16	0.016	0.032	0.048	0.060	0.070	0.080	0.100	0.120	0.140	
N1.1.1 Wrought aluminium alloys, non-hardened, 60 HB											
N1.1.2 Wrought aluminium alloys, hardened, 100 HB											
N2.1.1 Aluminium casting alloys, non-hardened, ≤ 12 % Si, 75 HB	65	0.040	0.080	0.120	0.149	0.175	0.205	0.255	0.300	0.345	
N2.1.2 Aluminium casting alloys, hardened, ≤ 12 % Si, 90 HB	52	0.032	0.064	0.096	0.119	0.140	0.165	0.200	0.240	0.275	
N2.1.3 Aluminium casting alloys, non-hardened, > 12 % Si, 130 HB	45	0.032	0.064	0.096	0.119	0.140	0.165	0.200	0.240	0.275	
N3.1.1 Copper and copper alloys: Free-machining alloy, Pb > 1 %	78	0.032	0.064	0.096	0.119	0.140	0.165	0.200	0.240	0.275	
N3.1.2 Copper and copper alloys: CuZn, CuSnZn	47	0.026	0.051	0.077	0.096	0.115	0.130	0.160	0.190	0.220	
N3.1.3 Copper and copper alloys: CuSn, lead-free copper and copper electrolyte	62	0.026	0.051	0.077	0.096	0.115	0.130	0.160	0.190	0.220	
N4.1.1 Non-metallic materials: Duroplastics, fibre-reinforced plastics	26	0.026	0.051	0.077	0.096	0.115	0.130	0.160	0.190	0.220	
N4.1.2 Non-metallic materials: Hard rubber, wood, etc.	26	0.026	0.051	0.077	0.096	0.115	0.130	0.160	0.190	0.220	
N4.1.3 Non-metallic materials: Graphite											
S1.1.1 Heat-resistant alloys, Fe-based, annealed, 200 HB	8	0.016	0.032	0.048	0.060	0.070	0.080	0.100	0.120	0.140	
S1.1.2 Heat-resistant alloys, Fe-based, hardened, 280 HB	6	0.013	0.026	0.038	0.048	0.055	0.065	0.080	0.095	0.110	
S1.1.3 Heat-resistant alloys, Ni- or Co-based, annealed, 250 HB	7	0.016	0.032	0.048	0.060	0.070	0.080	0.100	0.120	0.140	
S1.1.4 Heat-resistant alloys, Ni- or Co-based, hardened, 350 HB	4	0.013	0.026	0.038	0.048	0.055	0.065	0.080	0.095	0.110	
S1.1.5 Heat-resistant alloys, Ni- or Co-based, cast, 320 HB	5	0.013	0.026	0.038	0.048	0.055	0.065	0.080	0.095	0.110	
S2.1.1 Titanium alloys, pure titanium, Rm 400 N/mm ²	6	0.016	0.032	0.048	0.060	0.070	0.080	0.100	0.120	0.140	
S2.1.2 Titanium alloys, Alpha and Beta alloys, hardened, Rm 1050 N/mm ²	4	0.013	0.026	0.038	0.048	0.055	0.065	0.080	0.095	0.110	
H1.1.1 Hardened steel, hardened and tempered, < 55 HRC	5	0.013	0.026	0.038	0.048	0.055	0.065	0.080	0.095	0.110	
H1.1.2 Hardened steel, hardened and tempered, < 60 HRC											
H1.1.3 Hardened steel, hardened and tempered, > 60 HRC											
H2.1.1 Chilled cast iron, 400 HB	10	0.020	0.040	0.060	0.075	0.090	0.100	0.125	0.150	0.175	
H2.1.2 Chilled cast iron, hardened and tempered, < 55 HRC											



Long series twist drills, GT 50



Machining group	HSS	f (mm/rev) with nom. Ø									
	○										
	v _c (m/min)	1	2	3	4	5	6	8	10	14	
P1.1.1 Unalloyed steel, annealed, 0.15 % C, Rm 420 N/mm ² , 125 HB	25	0.032	0.064	0.096	0.119	0.140	0.165	0.200	0.240	0.310	
P1.1.2 Unalloyed steel, heat-treated, 0.15 % C, Rm 420 N/mm ² , 125 HB	21	0.026	0.051	0.077	0.096	0.115	0.130	0.160	0.190	0.250	
P1.1.3 Unalloyed steel, annealed, 0.45 % C, Rm 640 N/mm ² , 190 HB	21	0.026	0.051	0.077	0.096	0.115	0.130	0.160	0.190	0.250	
P1.1.4 Unalloyed steel, heat-treated, 0.45 % C, Rm 640 N/mm ² , 190 HB	21	0.026	0.051	0.077	0.096	0.115	0.130	0.160	0.190	0.250	
P1.1.5 Unalloyed steel, heat-treated, 0.45 % C, Rm 850 N/mm ² , 250 HB	19	0.026	0.051	0.077	0.096	0.115	0.130	0.160	0.190	0.250	
P1.1.6 Unalloyed steel, annealed, 0.75 % C, Rm 915 N/mm ² , 270 HB	18	0.026	0.051	0.077	0.096	0.115	0.130	0.160	0.190	0.250	
P1.1.7 Unalloyed steel, heat-treated, 0.75 % C, Rm 1020 N/mm ² , 300 HB											
P2.1.1 Low-alloy steel, annealed, Rm 610 N/mm ² , 180 HB	15	0.020	0.041	0.061	0.076	0.090	0.105	0.130	0.155	0.200	
P2.1.2 Low-alloy steel, heat-treated, Rm 930 N/mm ² , 275 HB	11	0.016	0.033	0.049	0.061	0.070	0.085	0.105	0.125	0.160	
P2.1.3 Low-alloy steel, heat-treated, Rm 1020 N/mm ² , 300 HB											
P2.1.4 Low-alloy steel, heat-treated, Rm 1190 N/mm ² , 350 HB											
P3.1.1 High-alloy steel and tool steel, annealed, Rm 680 N/mm ² , 200 HB											
P3.1.2 High-alloy steel and tool steel, hardened and tempered, Rm 1100 N/mm ² , 325 HB											
M1.1.1 Stainless steel, ferritic/martensitic, with machining additives											
M1.1.2 Stainless steel, ferritic/martensitic, annealed, Rm 680 N/mm ² , 200 HB											
M1.1.3 Stainless steel, ferritic/martensitic, heat-treated, Rm 810 N/mm ² , 240 HB											
M2.1.1 Stainless steel, austenitic, quenched, 180 HB											
M2.2.1 Duplex steel, high-strength stainless steels											
K1.1.1 Grey cast iron, pearlitic/ferritic, 180 HB											
K1.1.2 Grey cast iron, pearlitic/martensitic, 260 HB											
K1.2.1 Cast iron with spheroidal graphite, ferritic, 160 HB											
K1.2.2 Cast iron with spheroidal graphite, pearlitic, 250 HB											
K1.3.1 Malleable cast iron, ferritic, 130 HB											
K1.3.2 Malleable cast iron, pearlitic, 230 HB											
K2.1.1 Vermicular graphite cast iron (GJV)											
K2.2.1 Austenitic-ferritic spheroidal graphite cast iron (ADI)											
N1.1.1 Wrought aluminium alloys, non-hardened, 60 HB	72	0.041	0.082	0.123	0.153	0.180	0.210	0.260	0.305	0.395	
N1.1.2 Wrought aluminium alloys, hardened, 100 HB	72	0.041	0.082	0.123	0.153	0.180	0.210	0.260	0.305	0.395	
N2.1.1 Aluminium casting alloys, non-hardened, ≤ 12 % Si, 75 HB											
N2.1.2 Aluminium casting alloys, hardened, ≤ 12 % Si, 90 HB											
N2.1.3 Aluminium casting alloys, non-hardened, > 12 % Si, 130 HB											
N3.1.1 Copper and copper alloys: Free-machining alloy, Pb > 1 %											
N3.1.2 Copper and copper alloys: CuZn, CuSnZn											
N3.1.3 Copper and copper alloys: CuSn, lead-free copper and copper electrolyte											
N4.1.1 Non-metallic materials: Duroplastics, fibre-reinforced plastics											
N4.1.2 Non-metallic materials: Hard rubber, wood, etc.											
N4.1.3 Non-metallic materials: Graphite											
S1.1.1 Heat-resistant alloys, Fe-based, annealed, 200 HB											
S1.1.2 Heat-resistant alloys, Fe-based, hardened, 280 HB											
S1.1.3 Heat-resistant alloys, Ni- or Co-based, annealed, 250 HB											
S1.1.4 Heat-resistant alloys, Ni- or Co-based, hardened, 350 HB											
S1.1.5 Heat-resistant alloys, Ni- or Co-based, cast, 320 HB											
S2.1.1 Titanium alloys, pure titanium, Rm 400 N/mm ²											
S2.1.2 Titanium alloys, Alpha and Beta alloys, hardened, Rm 1050 N/mm ²											
H1.1.1 Hardened steel, hardened and tempered, < 55 HRC											
H1.1.2 Hardened steel, hardened and tempered, < 60 HRC											
H1.1.3 Hardened steel, hardened and tempered, > 60 HRC											
H2.1.1 Chilled cast iron, 400 HB											
H2.1.2 Chilled cast iron, hardened and tempered, < 55 HRC											



Long series twist drills, type Ti



Cutting data

Machining group	HSCO		f (mm/rev) with nom. Ø									
	○	Ⓢ										
	v _c (m/min)		1	2	3	4	5	8	10	12	15	
P1.1.1 Unalloyed steel, annealed, 0.15 % C, Rm 420 N/mm ² , 125 HB	34	39	0.026	0.051	0.077	0.096	0.115	0.160	0.190	0.220	0.260	
P1.1.2 Unalloyed steel, heat-treated, 0.15 % C, Rm 420 N/mm ² , 125 HB	29	33	0.020	0.041	0.061	0.076	0.090	0.130	0.155	0.175	0.210	
P1.1.3 Unalloyed steel, annealed, 0.45 % C, Rm 640 N/mm ² , 190 HB	29	33	0.020	0.041	0.061	0.076	0.090	0.130	0.155	0.175	0.210	
P1.1.4 Unalloyed steel, heat-treated, 0.45 % C, Rm 640 N/mm ² , 190 HB	29	33	0.020	0.041	0.061	0.076	0.090	0.130	0.155	0.175	0.210	
P1.1.5 Unalloyed steel, heat-treated, 0.45 % C, Rm 850 N/mm ² , 250 HB	26	29	0.020	0.041	0.061	0.076	0.090	0.130	0.155	0.175	0.210	
P1.1.6 Unalloyed steel, annealed, 0.75 % C, Rm 915 N/mm ² , 270 HB	24	27	0.020	0.041	0.061	0.076	0.090	0.130	0.155	0.175	0.210	
P1.1.7 Unalloyed steel, heat-treated, 0.75 % C, Rm 1020 N/mm ² , 300 HB	20	24	0.020	0.041	0.061	0.076	0.090	0.130	0.155	0.175	0.210	
P2.1.1 Low-alloy steel, annealed, Rm 610 N/mm ² , 180 HB	23	26	0.026	0.051	0.077	0.096	0.115	0.160	0.190	0.220	0.260	
P2.1.2 Low-alloy steel, heat-treated, Rm 930 N/mm ² , 275 HB	16	18	0.020	0.041	0.061	0.076	0.090	0.130	0.155	0.175	0.210	
P2.1.3 Low-alloy steel, heat-treated, Rm 1020 N/mm ² , 300 HB	14	16	0.020	0.041	0.061	0.076	0.090	0.130	0.155	0.175	0.210	
P2.1.4 Low-alloy steel, heat-treated, Rm 1190 N/mm ² , 350 HB	13	14	0.016	0.032	0.048	0.060	0.070	0.100	0.120	0.140	0.165	
P3.1.1 High-alloy steel and tool steel, annealed, Rm 680 N/mm ² , 200 HB	13	15	0.020	0.041	0.061	0.076	0.090	0.130	0.155	0.175	0.210	
P3.1.2 High-alloy steel and tool steel, hardened and tempered, Rm 1100 N/mm ² , 325 HB	10	12	0.016	0.033	0.049	0.061	0.070	0.105	0.125	0.140	0.165	
M1.1.1 Stainless steel, ferritic/martensitic, with machining additives	16	18	0.016	0.032	0.048	0.060	0.070	0.100	0.120	0.140	0.165	
M1.1.2 Stainless steel, ferritic/martensitic, annealed, Rm 680 N/mm ² , 200 HB	14	16	0.016	0.032	0.048	0.060	0.070	0.100	0.120	0.140	0.165	
M1.1.3 Stainless steel, ferritic/martensitic, heat-treated, Rm 810 N/mm ² , 240 HB	13	15	0.013	0.026	0.039	0.048	0.055	0.080	0.095	0.110	0.130	
M2.1.1 Stainless steel, austenitic, quenched, 180 HB	11	13	0.016	0.032	0.048	0.060	0.070	0.100	0.120	0.140	0.165	
M2.2.1 Duplex steel, high-strength stainless steels	8	9	0.013	0.026	0.039	0.048	0.055	0.080	0.095	0.110	0.130	
K1.1.1 Grey cast iron, pearlitic/ferritic, 180 HB												
K1.1.2 Grey cast iron, pearlitic/martensitic, 260 HB												
K1.2.1 Cast iron with spheroidal graphite, ferritic, 160 HB												
K1.2.2 Cast iron with spheroidal graphite, pearlitic, 250 HB												
K1.3.1 Malleable cast iron, ferritic, 130 HB												
K1.3.2 Malleable cast iron, pearlitic, 230 HB												
K2.1.1 Vermicular graphite cast iron (GJV)												
K2.2.1 Austenitic-ferritic spheroidal graphite cast iron (ADI)												
N1.1.1 Wrought aluminium alloys, non-hardened, 60 HB												
N1.1.2 Wrought aluminium alloys, hardened, 100 HB												
N2.1.1 Aluminium casting alloys, non-hardened, ≤ 12 % Si, 75 HB												
N2.1.2 Aluminium casting alloys, hardened, ≤ 12 % Si, 90 HB												
N2.1.3 Aluminium casting alloys, non-hardened, > 12 % Si, 130 HB												
N3.1.1 Copper and copper alloys: Free-machining alloy, Pb > 1 %												
N3.1.2 Copper and copper alloys: CuZn, CuSnZn												
N3.1.3 Copper and copper alloys: CuSn, lead-free copper and copper electrolyte												
N4.1.1 Non-metallic materials: Duroplastics, fibre-reinforced plastics												
N4.1.2 Non-metallic materials: Hard rubber, wood, etc.												
N4.1.3 Non-metallic materials: Graphite												
S1.1.1 Heat-resistant alloys, Fe-based, annealed, 200 HB	7	8	0.010	0.020	0.031	0.038	0.045	0.065	0.075	0.090	0.105	
S1.1.2 Heat-resistant alloys, Fe-based, hardened, 280 HB	6	7	0.008	0.016	0.025	0.031	0.035	0.050	0.060	0.070	0.085	
S1.1.3 Heat-resistant alloys, Ni- or Co-based, annealed, 250 HB	6	7	0.010	0.020	0.031	0.038	0.045	0.065	0.075	0.090	0.105	
S1.1.4 Heat-resistant alloys, Ni- or Co-based, hardened, 350 HB	4	4	0.008	0.016	0.025	0.031	0.035	0.050	0.060	0.070	0.085	
S1.1.5 Heat-resistant alloys, Ni- or Co-based, cast, 320 HB	4	5	0.008	0.016	0.025	0.031	0.035	0.050	0.060	0.070	0.085	
S2.1.1 Titanium alloys, pure titanium, Rm 400 N/mm ²	9	11	0.013	0.026	0.038	0.048	0.055	0.080	0.095	0.110	0.130	
S2.1.2 Titanium alloys, Alpha and Beta alloys, hardened, Rm 1050 N/mm ²	6	7	0.010	0.020	0.031	0.038	0.045	0.065	0.075	0.090	0.105	
H1.1.1 Hardened steel, hardened and tempered, < 55 HRC	4	5	0.010	0.020	0.031	0.038	0.045	0.065	0.075	0.090	0.105	
H1.1.2 Hardened steel, hardened and tempered, < 60 HRC												
H1.1.3 Hardened steel, hardened and tempered, > 60 HRC												
H2.1.1 Chilled cast iron, 400 HB	8	10	0.016	0.032	0.048	0.060	0.070	0.100	0.120	0.140	0.165	
H2.1.2 Chilled cast iron, hardened and tempered, < 55 HRC												



Extra length twist drills, type N



Machining group	HSS	f (mm/rev) with nom. Ø									
	v _c (m/min)	1.5	3	4	5	6	8	10	12	15	
P1.1.1 Unalloyed steel, annealed, 0.15 % C, Rm 420 N/mm ² , 125 HB	21	0.038	0.077	0.096	0.115	0.130	0.160	0.190	0.220	0.260	
P1.1.2 Unalloyed steel, heat-treated, 0.15 % C, Rm 420 N/mm ² , 125 HB	18	0.031	0.061	0.076	0.090	0.105	0.130	0.155	0.175	0.210	
P1.1.3 Unalloyed steel, annealed, 0.45 % C, Rm 640 N/mm ² , 190 HB	18	0.031	0.061	0.076	0.090	0.105	0.130	0.155	0.175	0.210	
P1.1.4 Unalloyed steel, heat-treated, 0.45 % C, Rm 640 N/mm ² , 190 HB	18	0.031	0.061	0.076	0.090	0.105	0.130	0.155	0.175	0.210	
P1.1.5 Unalloyed steel, heat-treated, 0.45 % C, Rm 850 N/mm ² , 250 HB	16	0.031	0.061	0.076	0.090	0.105	0.130	0.155	0.175	0.210	
P1.1.6 Unalloyed steel, annealed, 0.75 % C, Rm 915 N/mm ² , 270 HB	15	0.031	0.061	0.076	0.090	0.105	0.130	0.155	0.175	0.210	
P1.1.7 Unalloyed steel, heat-treated, 0.75 % C, Rm 1020 N/mm ² , 300 HB	13	0.031	0.061	0.076	0.090	0.105	0.130	0.155	0.175	0.210	
P2.1.1 Low-alloy steel, annealed, Rm 610 N/mm ² , 180 HB	13	0.025	0.049	0.061	0.070	0.085	0.105	0.125	0.140	0.165	
P2.1.2 Low-alloy steel, heat-treated, Rm 930 N/mm ² , 275 HB	9	0.020	0.039	0.049	0.060	0.065	0.085	0.100	0.115	0.135	
P2.1.3 Low-alloy steel, heat-treated, Rm 1020 N/mm ² , 300 HB	8	0.020	0.039	0.049	0.060	0.065	0.085	0.100	0.115	0.135	
P2.1.4 Low-alloy steel, heat-treated, Rm 1190 N/mm ² , 350 HB	7	0.015	0.031	0.039	0.045	0.050	0.065	0.075	0.090	0.105	
P3.1.1 High-alloy steel and tool steel, annealed, Rm 680 N/mm ² , 200 HB	10	0.025	0.049	0.061	0.070	0.085	0.105	0.125	0.140	0.165	
P3.1.2 High-alloy steel and tool steel, hardened and tempered, Rm 1100 N/mm ² , 325 HB											
M1.1.1 Stainless steel, ferritic/martensitic, with machining additives											
M1.1.2 Stainless steel, ferritic/martensitic, annealed, Rm 680 N/mm ² , 200 HB											
M1.1.3 Stainless steel, ferritic/martensitic, heat-treated, Rm 810 N/mm ² , 240 HB											
M2.1.1 Stainless steel, austenitic, quenched, 180 HB											
M2.2.1 Duplex steel, high-strength stainless steels											
K1.1.1 Grey cast iron, pearlitic/ferritic, 180 HB	23	0.038	0.077	0.096	0.115	0.130	0.160	0.190	0.220	0.260	
K1.1.2 Grey cast iron, pearlitic/martensitic, 260 HB	18	0.038	0.077	0.096	0.115	0.130	0.160	0.190	0.220	0.260	
K1.2.1 Cast iron with spheroidal graphite, ferritic, 160 HB	19	0.038	0.077	0.096	0.115	0.130	0.160	0.190	0.220	0.260	
K1.2.2 Cast iron with spheroidal graphite, pearlitic, 250 HB	15	0.031	0.061	0.076	0.090	0.105	0.130	0.155	0.175	0.210	
K1.3.1 Malleable cast iron, ferritic, 130 HB	19	0.038	0.077	0.096	0.115	0.130	0.160	0.190	0.220	0.260	
K1.3.2 Malleable cast iron, pearlitic, 230 HB	15	0.031	0.061	0.076	0.090	0.105	0.130	0.155	0.175	0.210	
K2.1.1 Vermicular graphite cast iron (GJV)	19	0.031	0.061	0.076	0.090	0.105	0.130	0.155	0.175	0.210	
K2.2.1 Austenitic-ferritic spheroidal graphite cast iron (ADI)											
N1.1.1 Wrought aluminium alloys, non-hardened, 60 HB											
N1.1.2 Wrought aluminium alloys, hardened, 100 HB											
N2.1.1 Aluminium casting alloys, non-hardened, ≤ 12 % Si, 75 HB	38	0.038	0.077	0.096	0.115	0.130	0.160	0.190	0.220	0.260	
N2.1.2 Aluminium casting alloys, hardened, ≤ 12 % Si, 90 HB	30	0.031	0.061	0.076	0.090	0.105	0.130	0.155	0.175	0.210	
N2.1.3 Aluminium casting alloys, non-hardened, > 12 % Si, 130 HB	26	0.031	0.061	0.076	0.090	0.105	0.130	0.155	0.175	0.210	
N3.1.1 Copper and copper alloys: Free-machining alloy, Pb > 1 %	45	0.031	0.061	0.076	0.090	0.105	0.130	0.155	0.175	0.210	
N3.1.2 Copper and copper alloys: CuZn, CuSnZn	27	0.025	0.049	0.061	0.070	0.085	0.105	0.125	0.140	0.165	
N3.1.3 Copper and copper alloys: CuSn, lead-free copper and copper electrolyte	36	0.025	0.049	0.061	0.070	0.085	0.105	0.125	0.140	0.165	
N4.1.1 Non-metallic materials: Duroplastics, fibre-reinforced plastics	15	0.031	0.061	0.076	0.090	0.105	0.130	0.155	0.175	0.210	
N4.1.2 Non-metallic materials: Hard rubber, wood, etc.	15	0.031	0.061	0.076	0.090	0.105	0.130	0.155	0.175	0.210	
N4.1.3 Non-metallic materials: Graphite											
S1.1.1 Heat-resistant alloys, Fe-based, annealed, 200 HB											
S1.1.2 Heat-resistant alloys, Fe-based, hardened, 280 HB											
S1.1.3 Heat-resistant alloys, Ni- or Co-based, annealed, 250 HB											
S1.1.4 Heat-resistant alloys, Ni- or Co-based, hardened, 350 HB											
S1.1.5 Heat-resistant alloys, Ni- or Co-based, cast, 320 HB											
S2.1.1 Titanium alloys, pure titanium, Rm 400 N/mm ²											
S2.1.2 Titanium alloys, Alpha and Beta alloys, hardened, Rm 1050 N/mm ²											
H1.1.1 Hardened steel, hardened and tempered, < 55 HRC											
H1.1.2 Hardened steel, hardened and tempered, < 60 HRC											
H1.1.3 Hardened steel, hardened and tempered, > 60 HRC											
H2.1.1 Chilled cast iron, 400 HB											
H2.1.2 Chilled cast iron, hardened and tempered, < 55 HRC											



Extra length twist drills, GT 50



Machining group	HSS	f (mm/rev) with nom. Ø							
	○								
	v _c (m/min)	2	3	4	5	6	8	10	12
P1.1.1 Unalloyed steel, annealed, 0.15 % C, Rm 420 N/mm ² , 125 HB	21	0.051	0.077	0.096	0.115	0.130	0.160	0.190	0.220
P1.1.2 Unalloyed steel, heat-treated, 0.15 % C, Rm 420 N/mm ² , 125 HB	18	0.041	0.061	0.076	0.090	0.105	0.130	0.155	0.175
P1.1.3 Unalloyed steel, annealed, 0.45 % C, Rm 640 N/mm ² , 190 HB	18	0.041	0.061	0.076	0.090	0.105	0.130	0.155	0.175
P1.1.4 Unalloyed steel, heat-treated, 0.45 % C, Rm 640 N/mm ² , 190 HB	18	0.041	0.061	0.076	0.090	0.105	0.130	0.155	0.175
P1.1.5 Unalloyed steel, heat-treated, 0.45 % C, Rm 850 N/mm ² , 250 HB	16	0.041	0.061	0.076	0.090	0.105	0.130	0.155	0.175
P1.1.6 Unalloyed steel, annealed, 0.75 % C, Rm 915 N/mm ² , 270 HB	15	0.041	0.061	0.076	0.090	0.105	0.130	0.155	0.175
P1.1.7 Unalloyed steel, heat-treated, 0.75 % C, Rm 1020 N/mm ² , 300 HB									
P2.1.1 Low-alloy steel, annealed, Rm 610 N/mm ² , 180 HB	13	0.033	0.049	0.061	0.070	0.085	0.105	0.125	0.140
P2.1.2 Low-alloy steel, heat-treated, Rm 930 N/mm ² , 275 HB	9	0.026	0.039	0.049	0.060	0.065	0.085	0.100	0.115
P2.1.3 Low-alloy steel, heat-treated, Rm 1020 N/mm ² , 300 HB									
P2.1.4 Low-alloy steel, heat-treated, Rm 1190 N/mm ² , 350 HB									
P3.1.1 High-alloy steel and tool steel, annealed, Rm 680 N/mm ² , 200 HB									
P3.1.2 High-alloy steel and tool steel, hardened and tempered, Rm 1100 N/mm ² , 325 HB									
M1.1.1 Stainless steel, ferritic/martensitic, with machining additives									
M1.1.2 Stainless steel, ferritic/martensitic, annealed, Rm 680 N/mm ² , 200 HB									
M1.1.3 Stainless steel, ferritic/martensitic, heat-treated, Rm 810 N/mm ² , 240 HB									
M2.1.1 Stainless steel, austenitic, quenched, 180 HB									
M2.2.1 Duplex steel, high-strength stainless steels									
K1.1.1 Grey cast iron, pearlitic/ferritic, 180 HB									
K1.1.2 Grey cast iron, pearlitic/martensitic, 260 HB									
K1.2.1 Cast iron with spheroidal graphite, ferritic, 160 HB									
K1.2.2 Cast iron with spheroidal graphite, pearlitic, 250 HB									
K1.3.1 Malleable cast iron, ferritic, 130 HB									
K1.3.2 Malleable cast iron, pearlitic, 230 HB									
K2.1.1 Vermicular graphite cast iron (GJV)									
K2.2.1 Austenitic-ferritic spheroidal graphite cast iron (ADI)									
N1.1.1 Wrought aluminium alloys, non-hardened, 60 HB	60	0.066	0.098	0.122	0.145	0.165	0.205	0.245	0.280
N1.1.2 Wrought aluminium alloys, hardened, 100 HB	60	0.066	0.098	0.122	0.145	0.165	0.205	0.245	0.280
N2.1.1 Aluminium casting alloys, non-hardened, ≤ 12 % Si, 75 HB									
N2.1.2 Aluminium casting alloys, hardened, ≤ 12 % Si, 90 HB									
N2.1.3 Aluminium casting alloys, non-hardened, > 12 % Si, 130 HB									
N3.1.1 Copper and copper alloys: Free-machining alloy, Pb > 1 %									
N3.1.2 Copper and copper alloys: CuZn, CuSnZn									
N3.1.3 Copper and copper alloys: CuSn, lead-free copper and copper electrolyte									
N4.1.1 Non-metallic materials: Duroplastics, fibre-reinforced plastics									
N4.1.2 Non-metallic materials: Hard rubber, wood, etc.									
N4.1.3 Non-metallic materials: Graphite									
S1.1.1 Heat-resistant alloys, Fe-based, annealed, 200 HB									
S1.1.2 Heat-resistant alloys, Fe-based, hardened, 280 HB									
S1.1.3 Heat-resistant alloys, Ni- or Co-based, annealed, 250 HB									
S1.1.4 Heat-resistant alloys, Ni- or Co-based, hardened, 350 HB									
S1.1.5 Heat-resistant alloys, Ni- or Co-based, cast, 320 HB									
S2.1.1 Titanium alloys, pure titanium, Rm 400 N/mm ²									
S2.1.2 Titanium alloys, Alpha and Beta alloys, hardened, Rm 1050 N/mm ²									
H1.1.1 Hardened steel, hardened and tempered, < 55 HRC									
H1.1.2 Hardened steel, hardened and tempered, < 60 HRC									
H1.1.3 Hardened steel, hardened and tempered, > 60 HRC									
H2.1.1 Chilled cast iron, 400 HB									
H2.1.2 Chilled cast iron, hardened and tempered, < 55 HRC									



Extra length twist drills, GT 100, bright/nitrided lands



Machining group	HSS	HSCo	f (mm/rev) with nom. Ø								
	v_c (m/min)		2	3	5	8	12	16	20	30	40
P1.1.1 Unalloyed steel, annealed, 0.15 % C, Rm 420 N/mm ² , 125 HB	21	24	0.051	0.077	0.115	0.160	0.220	0.275	0.325	0.440	0.550
P1.1.2 Unalloyed steel, heat-treated, 0.15 % C, Rm 420 N/mm ² , 125 HB	18	21	0.041	0.061	0.090	0.130	0.175	0.220	0.260	0.355	0.440
P1.1.3 Unalloyed steel, annealed, 0.45 % C, Rm 640 N/mm ² , 190 HB	18	21	0.041	0.061	0.090	0.130	0.175	0.220	0.260	0.355	0.440
P1.1.4 Unalloyed steel, heat-treated, 0.45 % C, Rm 640 N/mm ² , 190 HB	18	21	0.041	0.061	0.090	0.130	0.175	0.220	0.260	0.355	0.440
P1.1.5 Unalloyed steel, heat-treated, 0.45 % C, Rm 850 N/mm ² , 250 HB	16	18	0.041	0.061	0.090	0.130	0.175	0.220	0.260	0.355	0.440
P1.1.6 Unalloyed steel, annealed, 0.75 % C, Rm 915 N/mm ² , 270 HB	15	17	0.041	0.061	0.090	0.130	0.175	0.220	0.260	0.355	0.440
P1.1.7 Unalloyed steel, heat-treated, 0.75 % C, Rm 1020 N/mm ² , 300 HB	13	14	0.041	0.061	0.090	0.130	0.175	0.220	0.260	0.355	0.440
P2.1.1 Low-alloy steel, annealed, Rm 610 N/mm ² , 180 HB	13	15	0.041	0.061	0.090	0.130	0.175	0.220	0.260	0.355	0.440
P2.1.2 Low-alloy steel, heat-treated, Rm 930 N/mm ² , 275 HB	9	10	0.033	0.049	0.070	0.105	0.140	0.175	0.210	0.285	0.350
P2.1.3 Low-alloy steel, heat-treated, Rm 1020 N/mm ² , 300 HB	8	9	0.033	0.049	0.070	0.105	0.140	0.175	0.210	0.285	0.350
P2.1.4 Low-alloy steel, heat-treated, Rm 1190 N/mm ² , 350 HB	7	8	0.026	0.039	0.055	0.080	0.110	0.140	0.165	0.225	0.275
P3.1.1 High-alloy steel and tool steel, annealed, Rm 680 N/mm ² , 200 HB	10	11	0.033	0.049	0.070	0.105	0.140	0.175	0.210	0.285	0.350
P3.1.2 High-alloy steel and tool steel, hardened and tempered, Rm 1100 N/mm ² , 325 HB	7	8	0.026	0.039	0.060	0.085	0.115	0.140	0.165	0.225	0.280
M1.1.1 Stainless steel, ferritic/martensitic, with machining additives		9	0.026	0.039	0.055	0.080	0.110	0.140	0.165	0.225	0.275
M1.1.2 Stainless steel, ferritic/martensitic, annealed, Rm 680 N/mm ² , 200 HB		8	0.026	0.039	0.055	0.080	0.110	0.140	0.165	0.225	0.275
M1.1.3 Stainless steel, ferritic/martensitic, heat-treated, Rm 810 N/mm ² , 240 HB		7	0.021	0.031	0.045	0.065	0.090	0.110	0.130	0.180	0.220
M2.1.1 Stainless steel, austenitic, quenched, 180 HB		7	0.026	0.039	0.055	0.080	0.110	0.140	0.165	0.225	0.275
M2.2.1 Duplex steel, high-strength stainless steels											
K1.1.1 Grey cast iron, pearlitic/ferritic, 180 HB	23	26	0.051	0.077	0.115	0.160	0.220	0.275	0.325	0.440	0.550
K1.1.2 Grey cast iron, pearlitic/martensitic, 260 HB	18	21	0.051	0.077	0.115	0.160	0.220	0.275	0.325	0.440	0.550
K1.2.1 Cast iron with spheroidal graphite, ferritic, 160 HB	19	22	0.051	0.077	0.115	0.160	0.220	0.275	0.325	0.440	0.550
K1.2.2 Cast iron with spheroidal graphite, pearlitic, 250 HB	15	17	0.041	0.061	0.090	0.130	0.175	0.220	0.260	0.355	0.440
K1.3.1 Malleable cast iron, ferritic, 130 HB	19	22	0.051	0.077	0.115	0.160	0.220	0.275	0.325	0.440	0.550
K1.3.2 Malleable cast iron, pearlitic, 230 HB	15	17	0.041	0.061	0.090	0.130	0.175	0.220	0.260	0.355	0.440
K2.1.1 Vermicular graphite cast iron (GJV)	19	22	0.041	0.061	0.090	0.130	0.175	0.220	0.260	0.355	0.440
K2.2.1 Austenitic-ferritic spheroidal graphite cast iron (ADI)											
N1.1.1 Wrought aluminium alloys, non-hardened, 60 HB	45	52	0.066	0.098	0.145	0.205	0.280	0.350	0.415	0.565	0.705
N1.1.2 Wrought aluminium alloys, hardened, 100 HB	45	52	0.066	0.098	0.145	0.205	0.280	0.350	0.415	0.565	0.705
N2.1.1 Aluminium casting alloys, non-hardened, ≤ 12 % Si, 75 HB	38	43	0.051	0.077	0.115	0.160	0.220	0.275	0.325	0.440	0.550
N2.1.2 Aluminium casting alloys, hardened, ≤ 12 % Si, 90 HB	30	35	0.041	0.061	0.090	0.130	0.175	0.220	0.260	0.355	0.440
N2.1.3 Aluminium casting alloys, non-hardened, > 12 % Si, 130 HB	26	30	0.041	0.061	0.090	0.130	0.175	0.220	0.260	0.355	0.440
N3.1.1 Copper and copper alloys: Free-machining alloy, Pb > 1 %	45	52	0.041	0.061	0.090	0.130	0.175	0.220	0.260	0.355	0.440
N3.1.2 Copper and copper alloys: CuZn, CuSnZn	27	31	0.033	0.049	0.070	0.105	0.140	0.175	0.210	0.285	0.350
N3.1.3 Copper and copper alloys: CuSn, lead-free copper and copper electrolyte	36	41	0.033	0.049	0.070	0.105	0.140	0.175	0.210	0.285	0.350
N4.1.1 Non-metallic materials: Duroplastics, fibre-reinforced plastics	15	17	0.033	0.049	0.070	0.105	0.140	0.175	0.210	0.285	0.350
N4.1.2 Non-metallic materials: Hard rubber, wood, etc.	15	17	0.033	0.049	0.070	0.105	0.140	0.175	0.210	0.285	0.350
N4.1.3 Non-metallic materials: Graphite											
S1.1.1 Heat-resistant alloys, Fe-based, annealed, 200 HB		5	0.020	0.031	0.045	0.065	0.090	0.110	0.130	0.175	0.220
S1.1.2 Heat-resistant alloys, Fe-based, hardened, 280 HB		4	0.016	0.025	0.035	0.050	0.070	0.090	0.105	0.140	0.175
S1.1.3 Heat-resistant alloys, Ni- or Co-based, annealed, 250 HB		4	0.020	0.031	0.045	0.065	0.090	0.110	0.130	0.175	0.220
S1.1.4 Heat-resistant alloys, Ni- or Co-based, hardened, 350 HB		3	0.016	0.025	0.035	0.050	0.070	0.090	0.105	0.140	0.175
S1.1.5 Heat-resistant alloys, Ni- or Co-based, cast, 320 HB		3	0.016	0.025	0.035	0.050	0.070	0.090	0.105	0.140	0.175
S2.1.1 Titanium alloys, pure titanium, Rm 400 N/mm ²		4	0.020	0.031	0.045	0.065	0.090	0.110	0.130	0.175	0.220
S2.1.2 Titanium alloys, Alpha and Beta alloys, hardened, Rm 1050 N/mm ²		3	0.016	0.025	0.035	0.050	0.070	0.090	0.105	0.140	0.175
H1.1.1 Hardened steel, hardened and tempered, < 55 HRC		3	0.016	0.025	0.035	0.050	0.070	0.090	0.105	0.140	0.175
H1.1.2 Hardened steel, hardened and tempered, < 60 HRC											
H1.1.3 Hardened steel, hardened and tempered, > 60 HRC											
H2.1.1 Chilled cast iron, 400 HB		7	0.026	0.039	0.055	0.080	0.110	0.140	0.165	0.225	0.275
H2.1.2 Chilled cast iron, hardened and tempered, < 55 HRC											



Extra length twist drills, GT 100, TiAlN



Machining group	HSCO	f (mm/rev) with nom. Ø									
	A										
	v _c (m/min)	2	3	4	5	6	8	10	12	13	
P1.1.1 Unalloyed steel, annealed, 0.15 % C, Rm 420 N/mm ² , 125 HB	28	0.051	0.077	0.096	0.115	0.130	0.160	0.190	0.220	0.235	
P1.1.2 Unalloyed steel, heat-treated, 0.15 % C, Rm 420 N/mm ² , 125 HB	24	0.041	0.061	0.076	0.090	0.105	0.130	0.155	0.175	0.185	
P1.1.3 Unalloyed steel, annealed, 0.45 % C, Rm 640 N/mm ² , 190 HB	24	0.041	0.061	0.076	0.090	0.105	0.130	0.155	0.175	0.185	
P1.1.4 Unalloyed steel, heat-treated, 0.45 % C, Rm 640 N/mm ² , 190 HB	24	0.041	0.061	0.076	0.090	0.105	0.130	0.155	0.175	0.185	
P1.1.5 Unalloyed steel, heat-treated, 0.45 % C, Rm 850 N/mm ² , 250 HB	21	0.041	0.061	0.076	0.090	0.105	0.130	0.155	0.175	0.185	
P1.1.6 Unalloyed steel, annealed, 0.75 % C, Rm 915 N/mm ² , 270 HB	19	0.041	0.061	0.076	0.090	0.105	0.130	0.155	0.175	0.185	
P1.1.7 Unalloyed steel, heat-treated, 0.75 % C, Rm 1020 N/mm ² , 300 HB	17	0.041	0.061	0.076	0.090	0.105	0.130	0.155	0.175	0.185	
P2.1.1 Low-alloy steel, annealed, Rm 610 N/mm ² , 180 HB	17	0.041	0.061	0.076	0.090	0.105	0.130	0.155	0.175	0.185	
P2.1.2 Low-alloy steel, heat-treated, Rm 930 N/mm ² , 275 HB	12	0.033	0.049	0.061	0.070	0.085	0.105	0.125	0.140	0.150	
P2.1.3 Low-alloy steel, heat-treated, Rm 1020 N/mm ² , 300 HB	10	0.033	0.049	0.061	0.070	0.085	0.105	0.125	0.140	0.150	
P2.1.4 Low-alloy steel, heat-treated, Rm 1190 N/mm ² , 350 HB	9	0.026	0.039	0.048	0.055	0.065	0.080	0.095	0.110	0.120	
P3.1.1 High-alloy steel and tool steel, annealed, Rm 680 N/mm ² , 200 HB	13	0.033	0.049	0.061	0.070	0.085	0.105	0.125	0.140	0.150	
P3.1.2 High-alloy steel and tool steel, hardened and tempered, Rm 1100 N/mm ² , 325 HB	10	0.026	0.039	0.049	0.060	0.065	0.085	0.100	0.115	0.120	
M1.1.1 Stainless steel, ferritic/martensitic, with machining additives	10	0.026	0.039	0.048	0.055	0.065	0.080	0.095	0.110	0.120	
M1.1.2 Stainless steel, ferritic/martensitic, annealed, Rm 680 N/mm ² , 200 HB	9	0.026	0.039	0.048	0.055	0.065	0.080	0.095	0.110	0.120	
M1.1.3 Stainless steel, ferritic/martensitic, heat-treated, Rm 810 N/mm ² , 240 HB	8	0.021	0.031	0.039	0.045	0.050	0.065	0.075	0.090	0.095	
M2.1.1 Stainless steel, austenitic, quenched, 180 HB	8	0.026	0.039	0.048	0.055	0.065	0.080	0.095	0.110	0.120	
M2.2.1 Duplex steel, high-strength stainless steels											
K1.1.1 Grey cast iron, pearlitic/ferritic, 180 HB	30	0.051	0.077	0.096	0.115	0.130	0.160	0.190	0.220	0.235	
K1.1.2 Grey cast iron, pearlitic/martensitic, 260 HB	24	0.051	0.077	0.096	0.115	0.130	0.160	0.190	0.220	0.235	
K1.2.1 Cast iron with spheroidal graphite, ferritic, 160 HB	25	0.051	0.077	0.096	0.115	0.130	0.160	0.190	0.220	0.235	
K1.2.2 Cast iron with spheroidal graphite, pearlitic, 250 HB	19	0.041	0.061	0.076	0.090	0.105	0.130	0.155	0.175	0.185	
K1.3.1 Malleable cast iron, ferritic, 130 HB	25	0.051	0.077	0.096	0.115	0.130	0.160	0.190	0.220	0.235	
K1.3.2 Malleable cast iron, pearlitic, 230 HB	19	0.041	0.061	0.076	0.090	0.105	0.130	0.155	0.175	0.185	
K2.1.1 Vermicular graphite cast iron (GJV)	25	0.041	0.061	0.076	0.090	0.105	0.130	0.155	0.175	0.185	
K2.2.1 Austenitic-ferritic spheroidal graphite cast iron (ADI)	12	0.020	0.031	0.038	0.045	0.050	0.065	0.075	0.090	0.095	
N1.1.1 Wrought aluminium alloys, non-hardened, 60 HB											
N1.1.2 Wrought aluminium alloys, hardened, 100 HB											
N2.1.1 Aluminium casting alloys, non-hardened, ≤ 12 % Si, 75 HB	50	0.051	0.077	0.096	0.115	0.130	0.160	0.190	0.220	0.235	
N2.1.2 Aluminium casting alloys, hardened, ≤ 12 % Si, 90 HB	40	0.041	0.061	0.076	0.090	0.105	0.130	0.155	0.175	0.185	
N2.1.3 Aluminium casting alloys, non-hardened, > 12 % Si, 130 HB	35	0.041	0.061	0.076	0.090	0.105	0.130	0.155	0.175	0.185	
N3.1.1 Copper and copper alloys: Free-machining alloy, Pb > 1 %	60	0.041	0.061	0.076	0.090	0.105	0.130	0.155	0.175	0.185	
N3.1.2 Copper and copper alloys: CuZn, CuSnZn	36	0.033	0.049	0.061	0.070	0.085	0.105	0.125	0.140	0.150	
N3.1.3 Copper and copper alloys: CuSn, lead-free copper and copper electrolyte	48	0.033	0.049	0.061	0.070	0.085	0.105	0.125	0.140	0.150	
N4.1.1 Non-metallic materials: Duroplastics, fibre-reinforced plastics	20	0.033	0.049	0.061	0.070	0.085	0.105	0.125	0.140	0.150	
N4.1.2 Non-metallic materials: Hard rubber, wood, etc.	20	0.033	0.049	0.061	0.070	0.085	0.105	0.125	0.140	0.150	
N4.1.3 Non-metallic materials: Graphite											
S1.1.1 Heat-resistant alloys, Fe-based, annealed, 200 HB	6	0.020	0.031	0.038	0.045	0.050	0.065	0.075	0.090	0.095	
S1.1.2 Heat-resistant alloys, Fe-based, hardened, 280 HB	5	0.016	0.025	0.031	0.035	0.040	0.050	0.060	0.070	0.075	
S1.1.3 Heat-resistant alloys, Ni- or Co-based, annealed, 250 HB	5	0.020	0.031	0.038	0.045	0.050	0.065	0.075	0.090	0.095	
S1.1.4 Heat-resistant alloys, Ni- or Co-based, hardened, 350 HB	3	0.016	0.025	0.031	0.035	0.040	0.050	0.060	0.070	0.075	
S1.1.5 Heat-resistant alloys, Ni- or Co-based, cast, 320 HB	4	0.016	0.025	0.031	0.035	0.040	0.050	0.060	0.070	0.075	
S2.1.1 Titanium alloys, pure titanium, Rm 400 N/mm ²	5	0.020	0.031	0.038	0.045	0.050	0.065	0.075	0.090	0.095	
S2.1.2 Titanium alloys, Alpha and Beta alloys, hardened, Rm 1050 N/mm ²	3	0.016	0.025	0.031	0.035	0.040	0.050	0.060	0.070	0.075	
H1.1.1 Hardened steel, hardened and tempered, < 55 HRC	4	0.016	0.025	0.031	0.035	0.040	0.050	0.060	0.070	0.075	
H1.1.2 Hardened steel, hardened and tempered, < 60 HRC											
H1.1.3 Hardened steel, hardened and tempered, > 60 HRC											
H2.1.1 Chilled cast iron, 400 HB	8	0.026	0.039	0.048	0.055	0.065	0.080	0.095	0.110	0.120	
H2.1.2 Chilled cast iron, hardened and tempered, < 55 HRC											



Twist drills, type VA, bright



Machining group	HSCO	f (mm/rev) with nom. Ø									
	○										
	v _c (m/min)	10	12	14	16	18	20	24	28	32	
P1.1.1 Unalloyed steel, annealed, 0.15 % C, Rm 420 N/mm ² , 125 HB	38	0.190	0.220	0.250	0.275	0.300	0.325	0.375	0.420	0.465	
P1.1.2 Unalloyed steel, heat-treated, 0.15 % C, Rm 420 N/mm ² , 125 HB	32	0.155	0.175	0.200	0.220	0.240	0.260	0.300	0.335	0.370	
P1.1.3 Unalloyed steel, annealed, 0.45 % C, Rm 640 N/mm ² , 190 HB	32	0.155	0.175	0.200	0.220	0.240	0.260	0.300	0.335	0.370	
P1.1.4 Unalloyed steel, heat-treated, 0.45 % C, Rm 640 N/mm ² , 190 HB	32	0.155	0.175	0.200	0.220	0.240	0.260	0.300	0.335	0.370	
P1.1.5 Unalloyed steel, heat-treated, 0.45 % C, Rm 850 N/mm ² , 250 HB	28	0.155	0.175	0.200	0.220	0.240	0.260	0.300	0.335	0.370	
P1.1.6 Unalloyed steel, annealed, 0.75 % C, Rm 915 N/mm ² , 270 HB	27	0.155	0.175	0.200	0.220	0.240	0.260	0.300	0.335	0.370	
P1.1.7 Unalloyed steel, heat-treated, 0.75 % C, Rm 1020 N/mm ² , 300 HB											
P2.1.1 Low-alloy steel, annealed, Rm 610 N/mm ² , 180 HB	25	0.190	0.220	0.250	0.275	0.300	0.325	0.375	0.420	0.465	
P2.1.2 Low-alloy steel, heat-treated, Rm 930 N/mm ² , 275 HB	18	0.155	0.175	0.200	0.220	0.240	0.260	0.300	0.335	0.370	
P2.1.3 Low-alloy steel, heat-treated, Rm 1020 N/mm ² , 300 HB											
P2.1.4 Low-alloy steel, heat-treated, Rm 1190 N/mm ² , 350 HB											
P3.1.1 High-alloy steel and tool steel, annealed, Rm 680 N/mm ² , 200 HB											
P3.1.2 High-alloy steel and tool steel, hardened and tempered, Rm 1100 N/mm ² , 325 HB											
M1.1.1 Stainless steel, ferritic/martensitic, with machining additives	17	0.120	0.140	0.155	0.175	0.190	0.205	0.235	0.265	0.295	
M1.1.2 Stainless steel, ferritic/martensitic, annealed, Rm 680 N/mm ² , 200 HB	16	0.120	0.140	0.155	0.175	0.190	0.205	0.235	0.265	0.295	
M1.1.3 Stainless steel, ferritic/martensitic, heat-treated, Rm 810 N/mm ² , 240 HB	15	0.095	0.110	0.125	0.140	0.150	0.165	0.190	0.210	0.235	
M2.1.1 Stainless steel, austenitic, quenched, 180 HB	13	0.120	0.140	0.155	0.175	0.190	0.205	0.235	0.265	0.295	
M2.2.1 Duplex steel, high-strength stainless steels	9	0.095	0.110	0.125	0.140	0.150	0.165	0.190	0.210	0.235	
K1.1.1 Grey cast iron, pearlitic/ferritic, 180 HB	35	0.240	0.275	0.310	0.345	0.375	0.405	0.465	0.525	0.580	
K1.1.2 Grey cast iron, pearlitic/martensitic, 260 HB	28	0.240	0.275	0.310	0.345	0.375	0.405	0.465	0.525	0.580	
K1.2.1 Cast iron with spheroidal graphite, ferritic, 160 HB											
K1.2.2 Cast iron with spheroidal graphite, pearlitic, 250 HB											
K1.3.1 Malleable cast iron, ferritic, 130 HB											
K1.3.2 Malleable cast iron, pearlitic, 230 HB											
K2.1.1 Vermicular graphite cast iron (GJV)											
K2.2.1 Austenitic-ferritic spheroidal graphite cast iron (ADI)											
N1.1.1 Wrought aluminium alloys, non-hardened, 60 HB	81	0.305	0.355	0.395	0.440	0.480	0.520	0.595	0.670	0.745	
N1.1.2 Wrought aluminium alloys, hardened, 100 HB	81	0.305	0.355	0.395	0.440	0.480	0.520	0.595	0.670	0.745	
N2.1.1 Aluminium casting alloys, non-hardened, ≤ 12 % Si, 75 HB	66	0.240	0.275	0.310	0.345	0.375	0.405	0.465	0.525	0.580	
N2.1.2 Aluminium casting alloys, hardened, ≤ 12 % Si, 90 HB	52	0.190	0.220	0.250	0.275	0.300	0.325	0.375	0.420	0.465	
N2.1.3 Aluminium casting alloys, non-hardened, > 12 % Si, 130 HB	46	0.190	0.220	0.250	0.275	0.300	0.325	0.375	0.420	0.465	
N3.1.1 Copper and copper alloys: Free-machining alloy, Pb > 1 %	60	0.190	0.220	0.250	0.275	0.300	0.325	0.375	0.420	0.465	
N3.1.2 Copper and copper alloys: CuZn, CuSnZn	36	0.155	0.175	0.200	0.220	0.240	0.260	0.300	0.335	0.370	
N3.1.3 Copper and copper alloys: CuSn, lead-free copper and copper electrolyte	48	0.155	0.175	0.200	0.220	0.240	0.260	0.300	0.335	0.370	
N4.1.1 Non-metallic materials: Duroplastics, fibre-reinforced plastics											
N4.1.2 Non-metallic materials: Hard rubber, wood, etc.											
N4.1.3 Non-metallic materials: Graphite											
S1.1.1 Heat-resistant alloys, Fe-based, annealed, 200 HB	8	0.075	0.090	0.100	0.110	0.120	0.130	0.150	0.170	0.185	
S1.1.2 Heat-resistant alloys, Fe-based, hardened, 280 HB	6	0.060	0.070	0.080	0.090	0.095	0.105	0.120	0.135	0.150	
S1.1.3 Heat-resistant alloys, Ni- or Co-based, annealed, 250 HB	7	0.075	0.090	0.100	0.110	0.120	0.130	0.150	0.170	0.185	
S1.1.4 Heat-resistant alloys, Ni- or Co-based, hardened, 350 HB											
S1.1.5 Heat-resistant alloys, Ni- or Co-based, cast, 320 HB											
S2.1.1 Titanium alloys, pure titanium, Rm 400 N/mm ²	10	0.095	0.110	0.125	0.135	0.150	0.160	0.185	0.210	0.230	
S2.1.2 Titanium alloys, Alpha and Beta alloys, hardened, Rm 1050 N/mm ²	7	0.075	0.090	0.100	0.110	0.120	0.130	0.150	0.170	0.185	
H1.1.1 Hardened steel, hardened and tempered, < 55 HRC											
H1.1.2 Hardened steel, hardened and tempered, < 60 HRC											
H1.1.3 Hardened steel, hardened and tempered, > 60 HRC											
H2.1.1 Chilled cast iron, 400 HB											
H2.1.2 Chilled cast iron, hardened and tempered, < 55 HRC											



Twist drills with coolant ducts, GT 80



Machining group	HSCO	f (mm/rev) with nom. Ø									
	Ⓢ										
	v _c (m/min)	5	6	8	10	12	14	16	18	20	
P1.1.1 Unalloyed steel, annealed, 0.15 % C, Rm 420 N/mm ² , 125 HB	52	0.175	0.205	0.255	0.300	0.345	0.385	0.430	0.470	0.510	
P1.1.2 Unalloyed steel, heat-treated, 0.15 % C, Rm 420 N/mm ² , 125 HB	44	0.140	0.165	0.200	0.240	0.275	0.310	0.345	0.375	0.405	
P1.1.3 Unalloyed steel, annealed, 0.45 % C, Rm 640 N/mm ² , 190 HB	44	0.140	0.165	0.200	0.240	0.275	0.310	0.345	0.375	0.405	
P1.1.4 Unalloyed steel, heat-treated, 0.45 % C, Rm 640 N/mm ² , 190 HB	44	0.140	0.165	0.200	0.240	0.275	0.310	0.345	0.375	0.405	
P1.1.5 Unalloyed steel, heat-treated, 0.45 % C, Rm 850 N/mm ² , 250 HB	39	0.140	0.165	0.200	0.240	0.275	0.310	0.345	0.375	0.405	
P1.1.6 Unalloyed steel, annealed, 0.75 % C, Rm 915 N/mm ² , 270 HB	36	0.140	0.165	0.200	0.240	0.275	0.310	0.345	0.375	0.405	
P1.1.7 Unalloyed steel, heat-treated, 0.75 % C, Rm 1020 N/mm ² , 300 HB	31	0.140	0.165	0.200	0.240	0.275	0.310	0.345	0.375	0.405	
P2.1.1 Low-alloy steel, annealed, Rm 610 N/mm ² , 180 HB	31	0.115	0.130	0.160	0.190	0.220	0.250	0.275	0.300	0.325	
P2.1.2 Low-alloy steel, heat-treated, Rm 930 N/mm ² , 275 HB	22	0.090	0.105	0.130	0.155	0.175	0.200	0.220	0.240	0.260	
P2.1.3 Low-alloy steel, heat-treated, Rm 1020 N/mm ² , 300 HB	19	0.090	0.105	0.130	0.155	0.175	0.200	0.220	0.240	0.260	
P2.1.4 Low-alloy steel, heat-treated, Rm 1190 N/mm ² , 350 HB	17	0.070	0.080	0.100	0.120	0.140	0.155	0.175	0.190	0.205	
P3.1.1 High-alloy steel and tool steel, annealed, Rm 680 N/mm ² , 200 HB	24	0.115	0.130	0.160	0.190	0.220	0.250	0.275	0.300	0.325	
P3.1.2 High-alloy steel and tool steel, hardened and tempered, Rm 1100 N/mm ² , 325 HB	18	0.090	0.105	0.130	0.155	0.175	0.200	0.220	0.240	0.260	
M1.1.1 Stainless steel, ferritic/martensitic, with machining additives	19	0.090	0.100	0.125	0.150	0.175	0.195	0.215	0.235	0.255	
M1.1.2 Stainless steel, ferritic/martensitic, annealed, Rm 680 N/mm ² , 200 HB	17	0.090	0.100	0.125	0.150	0.175	0.195	0.215	0.235	0.255	
M1.1.3 Stainless steel, ferritic/martensitic, heat-treated, Rm 810 N/mm ² , 240 HB	16	0.070	0.080	0.100	0.120	0.140	0.155	0.175	0.190	0.205	
M2.1.1 Stainless steel, austenitic, quenched, 180 HB											
M2.2.1 Duplex steel, high-strength stainless steels											
K1.1.1 Grey cast iron, pearlitic/ferritic, 180 HB	56	0.175	0.205	0.255	0.300	0.345	0.385	0.430	0.470	0.510	
K1.1.2 Grey cast iron, pearlitic/martensitic, 260 HB	44	0.175	0.205	0.255	0.300	0.345	0.385	0.430	0.470	0.510	
K1.2.1 Cast iron with spheroidal graphite, ferritic, 160 HB	47	0.175	0.205	0.255	0.300	0.345	0.385	0.430	0.470	0.510	
K1.2.2 Cast iron with spheroidal graphite, pearlitic, 250 HB	36	0.140	0.165	0.200	0.240	0.275	0.310	0.345	0.375	0.405	
K1.3.1 Malleable cast iron, ferritic, 130 HB	47	0.175	0.205	0.255	0.300	0.345	0.385	0.430	0.470	0.510	
K1.3.2 Malleable cast iron, pearlitic, 230 HB	36	0.140	0.165	0.200	0.240	0.275	0.310	0.345	0.375	0.405	
K2.1.1 Vermicular graphite cast iron (GJV)	46	0.140	0.165	0.200	0.240	0.275	0.310	0.345	0.375	0.405	
K2.2.1 Austenitic-ferritic spheroidal graphite cast iron (ADI)											
N1.1.1 Wrought aluminium alloys, non-hardened, 60 HB											
N1.1.2 Wrought aluminium alloys, hardened, 100 HB											
N2.1.1 Aluminium casting alloys, non-hardened, ≤ 12 % Si, 75 HB	93	0.175	0.205	0.255	0.300	0.345	0.385	0.430	0.470	0.510	
N2.1.2 Aluminium casting alloys, hardened, ≤ 12 % Si, 90 HB	74	0.140	0.165	0.200	0.240	0.275	0.310	0.345	0.375	0.405	
N2.1.3 Aluminium casting alloys, non-hardened, > 12 % Si, 130 HB	65	0.140	0.165	0.200	0.240	0.275	0.310	0.345	0.375	0.405	
N3.1.1 Copper and copper alloys: Free-machining alloy, Pb > 1 %	111	0.140	0.165	0.200	0.240	0.275	0.310	0.345	0.375	0.405	
N3.1.2 Copper and copper alloys: CuZn, CuSnZn	67	0.115	0.130	0.160	0.190	0.220	0.250	0.275	0.300	0.325	
N3.1.3 Copper and copper alloys: CuSn, lead-free copper and copper electrolyte	89	0.115	0.130	0.160	0.190	0.220	0.250	0.275	0.300	0.325	
N4.1.1 Non-metallic materials: Duroplastics, fibre-reinforced plastics	37	0.115	0.130	0.160	0.190	0.220	0.250	0.275	0.300	0.325	
N4.1.2 Non-metallic materials: Hard rubber, wood, etc.											
N4.1.3 Non-metallic materials: Graphite											
S1.1.1 Heat-resistant alloys, Fe-based, annealed, 200 HB	11	0.070	0.080	0.100	0.120	0.140	0.155	0.170	0.185	0.205	
S1.1.2 Heat-resistant alloys, Fe-based, hardened, 280 HB	9	0.055	0.065	0.080	0.095	0.110	0.125	0.135	0.150	0.160	
S1.1.3 Heat-resistant alloys, Ni- or Co-based, annealed, 250 HB	9	0.070	0.080	0.100	0.120	0.140	0.155	0.170	0.185	0.205	
S1.1.4 Heat-resistant alloys, Ni- or Co-based, hardened, 350 HB	6	0.055	0.065	0.080	0.095	0.110	0.125	0.135	0.150	0.160	
S1.1.5 Heat-resistant alloys, Ni- or Co-based, cast, 320 HB	7	0.055	0.065	0.080	0.095	0.110	0.125	0.135	0.150	0.160	
S2.1.1 Titanium alloys, pure titanium, Rm 400 N/mm ²	9	0.070	0.080	0.100	0.120	0.140	0.155	0.170	0.185	0.205	
S2.1.2 Titanium alloys, Alpha and Beta alloys, hardened, Rm 1050 N/mm ²	6	0.055	0.065	0.080	0.095	0.110	0.125	0.135	0.150	0.160	
H1.1.1 Hardened steel, hardened and tempered, < 55 HRC	7	0.055	0.065	0.080	0.095	0.110	0.125	0.135	0.150	0.160	
H1.1.2 Hardened steel, hardened and tempered, < 60 HRC											
H1.1.3 Hardened steel, hardened and tempered, > 60 HRC											
H2.1.1 Chilled cast iron, 400 HB	11	0.090	0.100	0.125	0.150	0.175	0.195	0.215	0.235	0.255	
H2.1.2 Chilled cast iron, hardened and tempered, < 55 HRC											



Twist drills with coolant ducts, long/flute length to DIN 341, type N



Machining group	HSS		f (mm/rev) with nom. Ø								
	v _c (m/min)		3	5	8	10	12	16	20	30	40
P1.1.1 Unalloyed steel, annealed, 0.15 % C, Rm 420 N/mm ² , 125 HB	35		0.120	0.175	0.255	0.300	0.345	0.430	0.510	0.690	0.860
P1.1.2 Unalloyed steel, heat-treated, 0.15 % C, Rm 420 N/mm ² , 125 HB	30		0.096	0.140	0.200	0.240	0.275	0.345	0.405	0.555	0.690
P1.1.3 Unalloyed steel, annealed, 0.45 % C, Rm 640 N/mm ² , 190 HB	30		0.096	0.140	0.200	0.240	0.275	0.345	0.405	0.555	0.690
P1.1.4 Unalloyed steel, heat-treated, 0.45 % C, Rm 640 N/mm ² , 190 HB	30		0.096	0.140	0.200	0.240	0.275	0.345	0.405	0.555	0.690
P1.1.5 Unalloyed steel, heat-treated, 0.45 % C, Rm 850 N/mm ² , 250 HB	26		0.096	0.140	0.200	0.240	0.275	0.345	0.405	0.555	0.690
P1.1.6 Unalloyed steel, annealed, 0.75 % C, Rm 915 N/mm ² , 270 HB	25		0.096	0.140	0.200	0.240	0.275	0.345	0.405	0.555	0.690
P1.1.7 Unalloyed steel, heat-treated, 0.75 % C, Rm 1020 N/mm ² , 300 HB	21		0.096	0.140	0.200	1.000	0.275	0.345	0.405	0.555	0.690
P2.1.1 Low-alloy steel, annealed, Rm 610 N/mm ² , 180 HB	21		0.077	0.115	0.160	0.190	0.220	0.275	0.325	0.440	0.550
P2.1.2 Low-alloy steel, heat-treated, Rm 930 N/mm ² , 275 HB	15		0.061	0.090	0.130	0.155	0.175	0.220	0.260	0.355	0.440
P2.1.3 Low-alloy steel, heat-treated, Rm 1020 N/mm ² , 300 HB	13		0.061	0.090	0.130	0.155	0.175	0.220	0.260	0.355	0.440
P2.1.4 Low-alloy steel, heat-treated, Rm 1190 N/mm ² , 350 HB	12		0.048	0.070	0.100	0.120	0.140	0.175	0.205	0.280	0.345
P3.1.1 High-alloy steel and tool steel, annealed, Rm 680 N/mm ² , 200 HB	16		0.077	0.115	0.160	0.190	0.220	0.275	0.325	0.440	0.550
P3.1.2 High-alloy steel and tool steel, hardened and tempered, Rm 1100 N/mm ² , 325 HB											
M1.1.1 Stainless steel, ferritic/martensitic, with machining additives	13		0.060	0.090	0.125	0.150	0.175	0.215	0.255	0.350	0.435
M1.1.2 Stainless steel, ferritic/martensitic, annealed, Rm 680 N/mm ² , 200 HB	11		0.060	0.090	0.125	0.150	0.175	0.215	0.255	0.350	0.435
M1.1.3 Stainless steel, ferritic/martensitic, heat-treated, Rm 810 N/mm ² , 240 HB	11		0.048	0.070	0.100	0.120	0.140	0.175	0.205	0.280	0.345
M2.1.1 Stainless steel, austenitic, quenched, 180 HB											
M2.2.1 Duplex steel, high-strength stainless steels											
K1.1.1 Grey cast iron, pearlitic/ferritic, 180 HB	38		0.120	0.175	0.255	0.300	0.345	0.430	0.510	0.690	0.860
K1.1.2 Grey cast iron, pearlitic/martensitic, 260 HB	30		0.120	0.175	0.255	0.300	0.345	0.430	0.510	0.690	0.860
K1.2.1 Cast iron with spheroidal graphite, ferritic, 160 HB	32		0.120	0.175	0.255	0.300	0.345	0.430	0.510	0.690	0.860
K1.2.2 Cast iron with spheroidal graphite, pearlitic, 250 HB	25		0.096	0.140	0.200	0.240	0.275	0.345	0.405	0.555	0.690
K1.3.1 Malleable cast iron, ferritic, 130 HB	32		0.120	0.175	0.255	0.300	0.345	0.430	0.510	0.690	0.860
K1.3.2 Malleable cast iron, pearlitic, 230 HB	25		0.096	0.140	0.200	0.240	0.275	0.345	0.405	0.555	0.690
K2.1.1 Vermicular graphite cast iron (GJV)	32		0.096	0.140	0.200	0.240	0.275	0.345	0.405	0.555	0.690
K2.2.1 Austenitic-ferritic spheroidal graphite cast iron (ADI)											
N1.1.1 Wrought aluminium alloys, non-hardened, 60 HB											
N1.1.2 Wrought aluminium alloys, hardened, 100 HB											
N2.1.1 Aluminium casting alloys, non-hardened, ≤ 12 % Si, 75 HB	63		0.120	0.175	0.255	0.300	0.345	0.430	0.510	0.690	0.860
N2.1.2 Aluminium casting alloys, hardened, ≤ 12 % Si, 90 HB	50		0.096	0.140	0.200	0.240	0.275	0.345	0.405	0.555	0.690
N2.1.3 Aluminium casting alloys, non-hardened, > 12 % Si, 130 HB	44		0.096	0.140	0.200	0.240	0.275	0.345	0.405	0.555	0.690
N3.1.1 Copper and copper alloys: Free-machining alloy, Pb > 1 %	76		0.096	0.140	0.200	0.240	0.275	0.345	0.405	0.555	0.690
N3.1.2 Copper and copper alloys: CuZn, CuSnZn	45		0.077	0.115	0.160	0.190	0.220	0.275	0.325	0.440	0.550
N3.1.3 Copper and copper alloys: CuSn, lead-free copper and copper electrolyte	60		0.077	0.115	0.160	0.190	0.220	0.275	0.325	0.440	0.550
N4.1.1 Non-metallic materials: Duroplastics, fibre-reinforced plastics	25		0.096	0.140	0.200	0.240	0.275	0.345	0.405	0.555	0.690
N4.1.2 Non-metallic materials: Hard rubber, wood, etc.	25		0.096	0.140	0.200	0.240	0.275	0.345	0.405	0.555	0.690
N4.1.3 Non-metallic materials: Graphite											
S1.1.1 Heat-resistant alloys, Fe-based, annealed, 200 HB											
S1.1.2 Heat-resistant alloys, Fe-based, hardened, 280 HB											
S1.1.3 Heat-resistant alloys, Ni- or Co-based, annealed, 250 HB											
S1.1.4 Heat-resistant alloys, Ni- or Co-based, hardened, 350 HB											
S1.1.5 Heat-resistant alloys, Ni- or Co-based, cast, 320 HB											
S2.1.1 Titanium alloys, pure titanium, Rm 400 N/mm ²											
S2.1.2 Titanium alloys, Alpha and Beta alloys, hardened, Rm 1050 N/mm ²											
H1.1.1 Hardened steel, hardened and tempered, < 55 HRC											
H1.1.2 Hardened steel, hardened and tempered, < 60 HRC											
H1.1.3 Hardened steel, hardened and tempered, > 60 HRC											
H2.1.1 Chilled cast iron, 400 HB											
H2.1.2 Chilled cast iron, hardened and tempered, < 55 HRC											



Twist drills with internal coolant, flute length to DIN 341, GT 100



Machining group	HSCO	f (mm/rev) with nom. Ø									
	●										
	v _c (m/min)	11	12	14	16	18	20	24	28	33	
P1.1.1 Unalloyed steel, annealed, 0.15 % C, Rm 420 N/mm ² , 125 HB	41	0.320	0.345	0.385	0.430	0.470	0.510	0.585	0.655	0.745	
P1.1.2 Unalloyed steel, heat-treated, 0.15 % C, Rm 420 N/mm ² , 125 HB	34	0.260	0.275	0.310	0.345	0.375	0.405	0.465	0.525	0.595	
P1.1.3 Unalloyed steel, annealed, 0.45 % C, Rm 640 N/mm ² , 190 HB	34	0.260	0.275	0.310	0.345	0.375	0.405	0.465	0.525	0.595	
P1.1.4 Unalloyed steel, heat-treated, 0.45 % C, Rm 640 N/mm ² , 190 HB	34	0.260	0.275	0.310	0.345	0.375	0.405	0.465	0.525	0.595	
P1.1.5 Unalloyed steel, heat-treated, 0.45 % C, Rm 850 N/mm ² , 250 HB	30	0.260	0.275	0.310	0.345	0.375	0.405	0.465	0.525	0.595	
P1.1.6 Unalloyed steel, annealed, 0.75 % C, Rm 915 N/mm ² , 270 HB	28	0.260	0.275	0.310	0.345	0.375	0.405	0.465	0.525	0.595	
P1.1.7 Unalloyed steel, heat-treated, 0.75 % C, Rm 1020 N/mm ² , 300 HB	24	0.260	0.275	0.310	0.345	0.375	0.405	0.465	0.525	0.595	
P2.1.1 Low-alloy steel, annealed, Rm 610 N/mm ² , 180 HB	25	0.260	0.275	0.310	0.345	0.375	0.405	0.465	0.525	0.595	
P2.1.2 Low-alloy steel, heat-treated, Rm 930 N/mm ² , 275 HB	17	0.205	0.220	0.250	0.275	0.300	0.325	0.375	0.420	0.475	
P2.1.3 Low-alloy steel, heat-treated, Rm 1020 N/mm ² , 300 HB	15	0.205	0.220	0.250	0.275	0.300	0.325	0.375	0.420	0.475	
P2.1.4 Low-alloy steel, heat-treated, Rm 1190 N/mm ² , 350 HB	14	0.160	0.175	0.195	0.215	0.235	0.255	0.295	0.330	0.375	
P3.1.1 High-alloy steel and tool steel, annealed, Rm 680 N/mm ² , 200 HB	19	0.205	0.220	0.250	0.275	0.300	0.325	0.375	0.420	0.475	
P3.1.2 High-alloy steel and tool steel, hardened and tempered, Rm 1100 N/mm ² , 325 HB	14	0.165	0.175	0.200	0.220	0.240	0.260	0.300	0.335	0.380	
M1.1.1 Stainless steel, ferritic/martensitic, with machining additives	14	0.160	0.175	0.195	0.215	0.235	0.255	0.295	0.330	0.375	
M1.1.2 Stainless steel, ferritic/martensitic, annealed, Rm 680 N/mm ² , 200 HB	13	0.160	0.175	0.195	0.215	0.235	0.255	0.295	0.330	0.375	
M1.1.3 Stainless steel, ferritic/martensitic, heat-treated, Rm 810 N/mm ² , 240 HB	12	0.130	0.140	0.155	0.175	0.190	0.205	0.235	0.265	0.300	
M2.1.1 Stainless steel, austenitic, quenched, 180 HB	12	0.160	0.175	0.195	0.215	0.235	0.255	0.295	0.330	0.375	
M2.2.1 Duplex steel, high-strength stainless steels											
K1.1.1 Grey cast iron, pearlitic/ferritic, 180 HB	43	0.320	0.345	0.385	0.430	0.470	0.510	0.585	0.655	0.745	
K1.1.2 Grey cast iron, pearlitic/martensitic, 260 HB	35	0.320	0.345	0.385	0.430	0.470	0.510	0.585	0.655	0.745	
K1.2.1 Cast iron with spheroidal graphite, ferritic, 160 HB	37	0.320	0.345	0.385	0.430	0.470	0.510	0.585	0.655	0.745	
K1.2.2 Cast iron with spheroidal graphite, pearlitic, 250 HB	28	0.260	0.275	0.310	0.345	0.375	0.405	0.465	0.525	0.595	
K1.3.1 Malleable cast iron, ferritic, 130 HB	37	0.320	0.345	0.385	0.430	0.470	0.510	0.585	0.655	0.745	
K1.3.2 Malleable cast iron, pearlitic, 230 HB	28	0.260	0.275	0.310	0.345	0.375	0.405	0.465	0.525	0.595	
K2.1.1 Vermicular graphite cast iron (GJV)	36	0.260	0.275	0.310	0.345	0.375	0.405	0.465	0.525	0.595	
K2.2.1 Austenitic-ferritic spheroidal graphite cast iron (ADI)											
N1.1.1 Wrought aluminium alloys, non-hardened, 60 HB	87	0.410	0.440	0.495	0.550	0.600	0.650	0.745	0.840	0.950	
N1.1.2 Wrought aluminium alloys, hardened, 100 HB	87	0.410	0.440	0.495	0.550	0.600	0.650	0.745	0.840	0.950	
N2.1.1 Aluminium casting alloys, non-hardened, ≤ 12 % Si, 75 HB	72	0.320	0.345	0.385	0.430	0.470	0.510	0.585	0.655	0.745	
N2.1.2 Aluminium casting alloys, hardened, ≤ 12 % Si, 90 HB	58	0.260	0.275	0.310	0.345	0.375	0.405	0.465	0.525	0.595	
N2.1.3 Aluminium casting alloys, non-hardened, > 12 % Si, 130 HB	51	0.260	0.275	0.310	0.345	0.375	0.405	0.465	0.525	0.595	
N3.1.1 Copper and copper alloys: Free-machining alloy, Pb > 1 %	87	0.260	0.275	0.310	0.345	0.375	0.405	0.465	0.525	0.595	
N3.1.2 Copper and copper alloys: CuZn, CuSnZn	52	0.205	0.220	0.250	0.275	0.300	0.325	0.375	0.420	0.475	
N3.1.3 Copper and copper alloys: CuSn, lead-free copper and copper electrolyte	70	0.205	0.220	0.250	0.275	0.300	0.325	0.375	0.420	0.475	
N4.1.1 Non-metallic materials: Duroplastics, fibre-reinforced plastics	29	0.205	0.220	0.250	0.275	0.300	0.325	0.375	0.420	0.475	
N4.1.2 Non-metallic materials: Hard rubber, wood, etc.	29	0.205	0.220	0.250	0.275	0.300	0.325	0.375	0.420	0.475	
N4.1.3 Non-metallic materials: Graphite											
S1.1.1 Heat-resistant alloys, Fe-based, annealed, 200 HB	9	0.130	0.140	0.155	0.170	0.185	0.205	0.235	0.260	0.295	
S1.1.2 Heat-resistant alloys, Fe-based, hardened, 280 HB	7	0.105	0.110	0.125	0.135	0.150	0.160	0.185	0.210	0.240	
S1.1.3 Heat-resistant alloys, Ni- or Co-based, annealed, 250 HB	7	0.130	0.140	0.155	0.170	0.185	0.205	0.235	0.260	0.295	
S1.1.4 Heat-resistant alloys, Ni- or Co-based, hardened, 350 HB	4	0.105	0.110	0.125	0.135	0.150	0.160	0.185	0.210	0.240	
S1.1.5 Heat-resistant alloys, Ni- or Co-based, cast, 320 HB	5	0.105	0.110	0.125	0.135	0.150	0.160	0.185	0.210	0.240	
S2.1.1 Titanium alloys, pure titanium, Rm 400 N/mm ²	7	0.130	0.140	0.155	0.170	0.185	0.205	0.235	0.260	0.295	
S2.1.2 Titanium alloys, Alpha and Beta alloys, hardened, Rm 1050 N/mm ²	5	0.105	0.110	0.125	0.135	0.150	0.160	0.185	0.210	0.240	
H1.1.1 Hardened steel, hardened and tempered, < 55 HRC	6	0.105	0.110	0.125	0.135	0.150	0.160	0.185	0.210	0.240	
H1.1.2 Hardened steel, hardened and tempered, < 60 HRC											
H1.1.3 Hardened steel, hardened and tempered, > 60 HRC											
H2.1.1 Chilled cast iron, 400 HB	12	0.160	0.175	0.195	0.215	0.235	0.255	0.295	0.330	0.375	
H2.1.2 Chilled cast iron, hardened and tempered, < 55 HRC											



Twist drills with internal coolant, flute length to company standard, type N



Machining group	HSS	f (mm/rev) with nom. Ø									
	●										
	v _c (m/min)	8	10	12	14	16	20	30	40	50	
P1.1.1 Unalloyed steel, annealed, 0.15 % C, Rm 420 N/mm ² , 125 HB	39	0.255	0.300	0.345	0.385	0.430	0.510	0.690	0.860	1.020	
P1.1.2 Unalloyed steel, heat-treated, 0.15 % C, Rm 420 N/mm ² , 125 HB	33	0.200	0.240	0.275	0.310	0.345	0.405	0.555	0.690	0.815	
P1.1.3 Unalloyed steel, annealed, 0.45 % C, Rm 640 N/mm ² , 190 HB	33	0.200	0.240	0.275	0.310	0.345	0.405	0.555	0.690	0.815	
P1.1.4 Unalloyed steel, heat-treated, 0.45 % C, Rm 640 N/mm ² , 190 HB	33	0.200	0.240	0.275	0.310	0.345	0.405	0.555	0.690	0.815	
P1.1.5 Unalloyed steel, heat-treated, 0.45 % C, Rm 850 N/mm ² , 250 HB	29	0.200	0.240	0.275	0.310	0.345	0.405	0.555	0.690	0.815	
P1.1.6 Unalloyed steel, annealed, 0.75 % C, Rm 915 N/mm ² , 270 HB	27	0.200	0.240	0.275	0.310	0.345	0.405	0.555	0.690	0.815	
P1.1.7 Unalloyed steel, heat-treated, 0.75 % C, Rm 1020 N/mm ² , 300 HB	24	0.200	0.240	0.275	0.310	0.345	0.405	0.555	0.690	0.815	
P2.1.1 Low-alloy steel, annealed, Rm 610 N/mm ² , 180 HB	24	0.160	0.190	0.220	0.250	0.275	0.325	0.440	0.550	0.650	
P2.1.2 Low-alloy steel, heat-treated, Rm 930 N/mm ² , 275 HB	17	0.130	0.155	0.175	0.200	0.220	0.260	0.355	0.440	0.520	
P2.1.3 Low-alloy steel, heat-treated, Rm 1020 N/mm ² , 300 HB	14	0.130	0.155	0.175	0.200	0.220	0.260	0.355	0.440	0.520	
P2.1.4 Low-alloy steel, heat-treated, Rm 1190 N/mm ² , 350 HB	13	0.100	0.120	0.140	0.155	0.175	0.205	0.280	0.345	0.410	
P3.1.1 High-alloy steel and tool steel, annealed, Rm 680 N/mm ² , 200 HB	18	0.160	0.190	0.220	0.250	0.275	0.325	0.440	0.550	0.650	
P3.1.2 High-alloy steel and tool steel, hardened and tempered, Rm 1100 N/mm ² , 325 HB											
M1.1.1 Stainless steel, ferritic/martensitic, with machining additives	14	0.125	0.150	0.175	0.195	0.215	0.255	0.350	0.435	0.515	
M1.1.2 Stainless steel, ferritic/martensitic, annealed, Rm 680 N/mm ² , 200 HB	13	0.125	0.150	0.175	0.195	0.215	0.255	0.350	0.435	0.515	
M1.1.3 Stainless steel, ferritic/martensitic, heat-treated, Rm 810 N/mm ² , 240 HB	12	0.100	0.120	0.140	0.155	0.175	0.205	0.280	0.345	0.410	
M2.1.1 Stainless steel, austenitic, quenched, 180 HB											
M2.2.1 Duplex steel, high-strength stainless steels											
K1.1.1 Grey cast iron, pearlitic/ferritic, 180 HB	42	0.255	0.300	0.345	0.385	0.430	0.510	0.690	0.860	1.020	
K1.1.2 Grey cast iron, pearlitic/martensitic, 260 HB	34	0.255	0.300	0.345	0.385	0.430	0.510	0.690	0.860	1.020	
K1.2.1 Cast iron with spheroidal graphite, ferritic, 160 HB	36	0.255	0.300	0.345	0.385	0.430	0.510	0.690	0.860	1.020	
K1.2.2 Cast iron with spheroidal graphite, pearlitic, 250 HB	27	0.200	0.240	0.275	0.310	0.345	0.405	0.555	0.690	0.815	
K1.3.1 Malleable cast iron, ferritic, 130 HB	36	0.255	0.300	0.345	0.385	0.430	0.510	0.690	0.860	1.020	
K1.3.2 Malleable cast iron, pearlitic, 230 HB	27	0.200	0.240	0.275	0.310	0.345	0.405	0.555	0.690	0.815	
K2.1.1 Vermicular graphite cast iron (GJV)	35	0.200	0.240	0.275	0.310	0.345	0.405	0.555	0.690	0.815	
K2.2.1 Austenitic-ferritic spheroidal graphite cast iron (ADI)											
N1.1.1 Wrought aluminium alloys, non-hardened, 60 HB											
N1.1.2 Wrought aluminium alloys, hardened, 100 HB											
N2.1.1 Aluminium casting alloys, non-hardened, ≤ 12 % Si, 75 HB	70	0.255	0.300	0.345	0.385	0.430	0.510	0.690	0.860	1.020	
N2.1.2 Aluminium casting alloys, hardened, ≤ 12 % Si, 90 HB	56	0.200	0.240	0.275	0.310	0.345	0.405	0.555	0.690	0.815	
N2.1.3 Aluminium casting alloys, non-hardened, > 12 % Si, 130 HB	49	0.200	0.240	0.275	0.310	0.345	0.405	0.555	0.690	0.815	
N3.1.1 Copper and copper alloys: Free-machining alloy, Pb > 1 %	84	0.200	0.240	0.275	0.310	0.345	0.405	0.555	0.690	0.815	
N3.1.2 Copper and copper alloys: CuZn, CuSnZn	50	0.160	0.190	0.220	0.250	0.275	0.325	0.440	0.550	0.650	
N3.1.3 Copper and copper alloys: CuSn, lead-free copper and copper electrolyte	67	0.160	0.190	0.220	0.250	0.275	0.325	0.440	0.550	0.650	
N4.1.1 Non-metallic materials: Duroplastics, fibre-reinforced plastics	28	0.200	0.240	0.275	0.310	0.345	0.405	0.555	0.690	0.815	
N4.1.2 Non-metallic materials: Hard rubber, wood, etc.	28	0.200	0.240	0.275	0.310	0.345	0.405	0.555	0.690	0.815	
N4.1.3 Non-metallic materials: Graphite											
S1.1.1 Heat-resistant alloys, Fe-based, annealed, 200 HB											
S1.1.2 Heat-resistant alloys, Fe-based, hardened, 280 HB											
S1.1.3 Heat-resistant alloys, Ni- or Co-based, annealed, 250 HB											
S1.1.4 Heat-resistant alloys, Ni- or Co-based, hardened, 350 HB											
S1.1.5 Heat-resistant alloys, Ni- or Co-based, cast, 320 HB											
S2.1.1 Titanium alloys, pure titanium, Rm 400 N/mm ²											
S2.1.2 Titanium alloys, Alpha and Beta alloys, hardened, Rm 1050 N/mm ²											
H1.1.1 Hardened steel, hardened and tempered, < 55 HRC											
H1.1.2 Hardened steel, hardened and tempered, < 60 HRC											
H1.1.3 Hardened steel, hardened and tempered, > 60 HRC											
H2.1.1 Chilled cast iron, 400 HB											
H2.1.2 Chilled cast iron, hardened and tempered, < 55 HRC											



Twist drills with internal coolant, flute length to DIN 1870, GT 100



Machining group	HSCO	f (mm/rev) with nom. Ø									
	●										
	v _c (m/min)	11	12	14	16	18	20	24	28	34	
P1.1.1 Unalloyed steel, annealed, 0.15 % C, Rm 420 N/mm ² , 125 HB	34	0.260	0.275	0.310	0.345	0.375	0.405	0.465	0.525	0.610	
P1.1.2 Unalloyed steel, heat-treated, 0.15 % C, Rm 420 N/mm ² , 125 HB	29	0.205	0.220	0.250	0.275	0.300	0.325	0.375	0.420	0.485	
P1.1.3 Unalloyed steel, annealed, 0.45 % C, Rm 640 N/mm ² , 190 HB	29	0.205	0.220	0.250	0.275	0.300	0.325	0.375	0.420	0.485	
P1.1.4 Unalloyed steel, heat-treated, 0.45 % C, Rm 640 N/mm ² , 190 HB	29	0.205	0.220	0.250	0.275	0.300	0.325	0.375	0.420	0.485	
P1.1.5 Unalloyed steel, heat-treated, 0.45 % C, Rm 850 N/mm ² , 250 HB	25	0.205	0.220	0.250	0.275	0.300	0.325	0.375	0.420	0.485	
P1.1.6 Unalloyed steel, annealed, 0.75 % C, Rm 915 N/mm ² , 270 HB	24	0.205	0.220	0.250	0.275	0.300	0.325	0.375	0.420	0.485	
P1.1.7 Unalloyed steel, heat-treated, 0.75 % C, Rm 1020 N/mm ² , 300 HB	20	0.205	0.220	0.250	0.275	0.300	0.325	0.375	0.420	0.485	
P2.1.1 Low-alloy steel, annealed, Rm 610 N/mm ² , 180 HB	21	0.205	0.220	0.250	0.275	0.300	0.325	0.375	0.420	0.485	
P2.1.2 Low-alloy steel, heat-treated, Rm 930 N/mm ² , 275 HB	14	0.165	0.175	0.200	0.220	0.240	0.260	0.300	0.335	0.390	
P2.1.3 Low-alloy steel, heat-treated, Rm 1020 N/mm ² , 300 HB	12	0.165	0.175	0.200	0.220	0.240	0.260	0.300	0.335	0.390	
P2.1.4 Low-alloy steel, heat-treated, Rm 1190 N/mm ² , 350 HB	11	0.130	0.140	0.155	0.175	0.190	0.205	0.235	0.265	0.305	
P3.1.1 High-alloy steel and tool steel, annealed, Rm 680 N/mm ² , 200 HB	16	0.165	0.175	0.200	0.220	0.240	0.260	0.300	0.335	0.390	
P3.1.2 High-alloy steel and tool steel, hardened and tempered, Rm 1100 N/mm ² , 325 HB	12	0.130	0.140	0.160	0.175	0.190	0.210	0.240	0.270	0.310	
M1.1.1 Stainless steel, ferritic/martensitic, with machining additives	12	0.130	0.140	0.155	0.175	0.190	0.205	0.235	0.265	0.305	
M1.1.2 Stainless steel, ferritic/martensitic, annealed, Rm 680 N/mm ² , 200 HB	11	0.130	0.140	0.155	0.175	0.190	0.205	0.235	0.265	0.305	
M1.1.3 Stainless steel, ferritic/martensitic, heat-treated, Rm 810 N/mm ² , 240 HB	10	0.105	0.110	0.125	0.140	0.150	0.165	0.190	0.210	0.245	
M2.1.1 Stainless steel, austenitic, quenched, 180 HB	10	0.130	0.140	0.155	0.175	0.190	0.205	0.235	0.265	0.305	
M2.2.1 Duplex steel, high-strength stainless steels											
K1.1.1 Grey cast iron, pearlitic/ferritic, 180 HB	36	0.260	0.275	0.310	0.345	0.375	0.405	0.465	0.525	0.610	
K1.1.2 Grey cast iron, pearlitic/martensitic, 260 HB	29	0.260	0.275	0.310	0.345	0.375	0.405	0.465	0.525	0.610	
K1.2.1 Cast iron with spheroidal graphite, ferritic, 160 HB	31	0.260	0.275	0.310	0.345	0.375	0.405	0.465	0.525	0.610	
K1.2.2 Cast iron with spheroidal graphite, pearlitic, 250 HB	24	0.205	0.220	0.250	0.275	0.300	0.325	0.375	0.420	0.485	
K1.3.1 Malleable cast iron, ferritic, 130 HB	31	0.260	0.275	0.310	0.345	0.375	0.405	0.465	0.525	0.610	
K1.3.2 Malleable cast iron, pearlitic, 230 HB	24	0.205	0.220	0.250	0.275	0.300	0.325	0.375	0.420	0.485	
K2.1.1 Vermicular graphite cast iron (GJV)	30	0.205	0.220	0.250	0.275	0.300	0.325	0.375	0.420	0.485	
K2.2.1 Austenitic-ferritic spheroidal graphite cast iron (ADI)											
N1.1.1 Wrought aluminium alloys, non-hardened, 60 HB	72	0.330	0.355	0.395	0.440	0.480	0.520	0.595	0.670	0.780	
N1.1.2 Wrought aluminium alloys, hardened, 100 HB	72	0.330	0.355	0.395	0.440	0.480	0.520	0.595	0.670	0.780	
N2.1.1 Aluminium casting alloys, non-hardened, ≤ 12 % Si, 75 HB	60	0.260	0.275	0.310	0.345	0.375	0.405	0.465	0.525	0.610	
N2.1.2 Aluminium casting alloys, hardened, ≤ 12 % Si, 90 HB	48	0.205	0.220	0.250	0.275	0.300	0.325	0.375	0.420	0.485	
N2.1.3 Aluminium casting alloys, non-hardened, > 12 % Si, 130 HB	42	0.205	0.220	0.250	0.275	0.300	0.325	0.375	0.420	0.485	
N3.1.1 Copper and copper alloys: Free-machining alloy, Pb > 1 %	72	0.205	0.220	0.250	0.275	0.300	0.325	0.375	0.420	0.485	
N3.1.2 Copper and copper alloys: CuZn, CuSnZn	43	0.165	0.175	0.200	0.220	0.240	0.260	0.300	0.335	0.390	
N3.1.3 Copper and copper alloys: CuSn, lead-free copper and copper electrolyte	58	0.165	0.175	0.200	0.220	0.240	0.260	0.300	0.335	0.390	
N4.1.1 Non-metallic materials: Duroplastics, fibre-reinforced plastics	24	0.165	0.175	0.200	0.220	0.240	0.260	0.300	0.335	0.390	
N4.1.2 Non-metallic materials: Hard rubber, wood, etc.	24	0.165	0.175	0.200	0.220	0.240	0.260	0.300	0.335	0.390	
N4.1.3 Non-metallic materials: Graphite											
S1.1.1 Heat-resistant alloys, Fe-based, annealed, 200 HB	7	0.105	0.110	0.125	0.135	0.150	0.160	0.185	0.210	0.245	
S1.1.2 Heat-resistant alloys, Fe-based, hardened, 280 HB	6	0.080	0.090	0.100	0.110	0.120	0.130	0.150	0.170	0.195	
S1.1.3 Heat-resistant alloys, Ni- or Co-based, annealed, 250 HB	6	0.105	0.110	0.125	0.135	0.150	0.160	0.185	0.210	0.245	
S1.1.4 Heat-resistant alloys, Ni- or Co-based, hardened, 350 HB	4	0.080	0.090	0.100	0.110	0.120	0.130	0.150	0.170	0.195	
S1.1.5 Heat-resistant alloys, Ni- or Co-based, cast, 320 HB	4	0.080	0.090	0.100	0.110	0.120	0.130	0.150	0.170	0.195	
S2.1.1 Titanium alloys, pure titanium, Rm 400 N/mm ²	6	0.105	0.110	0.125	0.135	0.150	0.160	0.185	0.210	0.245	
S2.1.2 Titanium alloys, Alpha and Beta alloys, hardened, Rm 1050 N/mm ²	4	0.080	0.090	0.100	0.110	0.120	0.130	0.150	0.170	0.195	
H1.1.1 Hardened steel, hardened and tempered, < 55 HRC	5	0.080	0.090	0.100	0.110	0.120	0.130	0.150	0.170	0.195	
H1.1.2 Hardened steel, hardened and tempered, < 60 HRC											
H1.1.3 Hardened steel, hardened and tempered, > 60 HRC											
H2.1.1 Chilled cast iron, 400 HB	10	0.130	0.140	0.155	0.175	0.190	0.205	0.235	0.265	0.305	
H2.1.2 Chilled cast iron, hardened and tempered, < 55 HRC											



Centre drills, solid carbide



Machining group	VHM	f (mm/rev) with nom. Ø							
	○								
	v _c (m/min)	0.5	0.8	1	2	4	5	6	8
P1.1.1 Unalloyed steel, annealed, 0.15 % C, Rm 420 N/mm ² , 125 HB	75	0.010	0.015	0.020	0.040	0.075	0.090	0.105	0.130
P1.1.2 Unalloyed steel, heat-treated, 0.15 % C, Rm 420 N/mm ² , 125 HB	70	0.010	0.015	0.020	0.035	0.070	0.080	0.095	0.115
P1.1.3 Unalloyed steel, annealed, 0.45 % C, Rm 640 N/mm ² , 190 HB	70	0.010	0.015	0.020	0.035	0.070	0.080	0.095	0.115
P1.1.4 Unalloyed steel, heat-treated, 0.45 % C, Rm 640 N/mm ² , 190 HB	65	0.010	0.015	0.015	0.035	0.065	0.075	0.090	0.110
P1.1.5 Unalloyed steel, heat-treated, 0.45 % C, Rm 850 N/mm ² , 250 HB	65	0.010	0.015	0.015	0.035	0.065	0.075	0.090	0.110
P1.1.6 Unalloyed steel, annealed, 0.75 % C, Rm 915 N/mm ² , 270 HB	60	0.010	0.015	0.015	0.035	0.060	0.070	0.085	0.105
P1.1.7 Unalloyed steel, heat-treated, 0.75 % C, Rm 1020 N/mm ² , 300 HB	55	0.010	0.010	0.015	0.030	0.055	0.070	0.080	0.095
P2.1.1 Low-alloy steel, annealed, Rm 610 N/mm ² , 180 HB	40	0.010	0.015	0.020	0.040	0.075	0.090	0.105	0.130
P2.1.2 Low-alloy steel, heat-treated, Rm 930 N/mm ² , 275 HB	40	0.010	0.015	0.020	0.040	0.075	0.090	0.105	0.130
P2.1.3 Low-alloy steel, heat-treated, Rm 1020 N/mm ² , 300 HB	30	0.010	0.015	0.015	0.035	0.065	0.075	0.090	0.110
P2.1.4 Low-alloy steel, heat-treated, Rm 1190 N/mm ² , 350 HB	30	0.010	0.010	0.015	0.030	0.055	0.070	0.080	0.095
P3.1.1 High-alloy steel and tool steel, annealed, Rm 680 N/mm ² , 200 HB	25	0.010	0.015	0.015	0.030	0.060	0.070	0.080	0.100
P3.1.2 High-alloy steel and tool steel, hardened and tempered, Rm 1100 N/mm ² , 325 HB	20	0.005	0.010	0.015	0.025	0.050	0.060	0.070	0.085
M1.1.1 Stainless steel, ferritic/martensitic, with machining additives	25	0.005	0.010	0.015	0.025	0.050	0.055	0.065	0.080
M1.1.2 Stainless steel, ferritic/martensitic, annealed, Rm 680 N/mm ² , 200 HB	25	0.005	0.010	0.010	0.025	0.045	0.050	0.060	0.075
M1.1.3 Stainless steel, ferritic/martensitic, heat-treated, Rm 810 N/mm ² , 240 HB	20	0.005	0.010	0.010	0.020	0.040	0.050	0.055	0.070
M2.1.1 Stainless steel, austenitic, quenched, 180 HB	20	0.005	0.010	0.015	0.025	0.050	0.055	0.065	0.080
M2.2.1 Duplex steel, high-strength stainless steels	15	0.005	0.010	0.010	0.020	0.040	0.050	0.055	0.070
K1.1.1 Grey cast iron, pearlitic/ferritic, 180 HB	50	0.015	0.025	0.030	0.065	0.120	0.140	0.165	0.205
K1.1.2 Grey cast iron, pearlitic/martensitic, 260 HB	45	0.015	0.020	0.025	0.055	0.100	0.120	0.140	0.170
K1.2.1 Cast iron with spheroidal graphite, ferritic, 160 HB	45	0.015	0.020	0.025	0.055	0.100	0.120	0.140	0.170
K1.2.2 Cast iron with spheroidal graphite, pearlitic, 250 HB	40	0.015	0.020	0.025	0.050	0.095	0.115	0.130	0.160
K1.3.1 Malleable cast iron, ferritic, 130 HB	40	0.015	0.020	0.025	0.050	0.095	0.115	0.130	0.160
K1.3.2 Malleable cast iron, pearlitic, 230 HB	35	0.010	0.020	0.020	0.045	0.085	0.100	0.115	0.140
K2.1.1 Vermicular graphite cast iron (GJV)									
K2.2.1 Austenitic-ferritic spheroidal graphite cast iron (ADI)									
N1.1.1 Wrought aluminium alloys, non-hardened, 60 HB	160	0.020	0.035	0.040	0.080	0.155	0.180	0.210	0.260
N1.1.2 Wrought aluminium alloys, hardened, 100 HB	160	0.020	0.035	0.040	0.080	0.155	0.180	0.210	0.260
N2.1.1 Aluminium casting alloys, non-hardened, ≤ 12 % Si, 75 HB	140	0.020	0.035	0.040	0.080	0.155	0.180	0.210	0.260
N2.1.2 Aluminium casting alloys, hardened, ≤ 12 % Si, 90 HB	140	0.020	0.035	0.040	0.080	0.155	0.180	0.210	0.260
N2.1.3 Aluminium casting alloys, non-hardened, > 12 % Si, 130 HB	120	0.015	0.030	0.035	0.070	0.130	0.155	0.175	0.220
N3.1.1 Copper and copper alloys: Free-machining alloy, Pb > 1 %	80	0.015	0.025	0.030	0.065	0.120	0.140	0.165	0.205
N3.1.2 Copper and copper alloys: CuZn, CuSnZn	70	0.015	0.020	0.025	0.055	0.100	0.120	0.140	0.170
N3.1.3 Copper and copper alloys: CuSn, lead-free copper and copper electrolyte	65	0.015	0.020	0.025	0.050	0.095	0.115	0.130	0.160
N4.1.1 Non-metallic materials: Duroplastics, fibre-reinforced plastics	50	0.005	0.010	0.015	0.025	0.050	0.055	0.065	0.080
N4.1.2 Non-metallic materials: Hard rubber, wood, etc.	50	0.005	0.010	0.015	0.025	0.050	0.055	0.065	0.080
N4.1.3 Non-metallic materials: Graphite									
S1.1.1 Heat-resistant alloys, Fe-based, annealed, 200 HB	20	0.005	0.010	0.010	0.020	0.040	0.045	0.050	0.065
S1.1.2 Heat-resistant alloys, Fe-based, hardened, 280 HB	15	0.005	0.005	0.010	0.015	0.030	0.035	0.040	0.050
S1.1.3 Heat-resistant alloys, Ni- or Co-based, annealed, 250 HB	15	0.005	0.010	0.010	0.020	0.040	0.045	0.050	0.065
S1.1.4 Heat-resistant alloys, Ni- or Co-based, hardened, 350 HB	10	0.005	0.005	0.005	0.015	0.025	0.030	0.035	0.045
S1.1.5 Heat-resistant alloys, Ni- or Co-based, cast, 320 HB	10	0.005	0.005	0.005	0.015	0.025	0.030	0.035	0.045
S2.1.1 Titanium alloys, pure titanium, Rm 400 N/mm ²	15	0.005	0.010	0.015	0.025	0.050	0.055	0.065	0.080
S2.1.2 Titanium alloys, Alpha and Beta alloys, hardened, Rm 1050 N/mm ²	10	0.005	0.010	0.010	0.020	0.040	0.045	0.050	0.065
H1.1.1 Hardened steel, hardened and tempered, < 55 HRC	15	0.005	0.010	0.010	0.020	0.040	0.045	0.050	0.065
H1.1.2 Hardened steel, hardened and tempered, < 60 HRC									
H1.1.3 Hardened steel, hardened and tempered, > 60 HRC									
H2.1.1 Chilled cast iron, 400 HB									
H2.1.2 Chilled cast iron, hardened and tempered, < 55 HRC									



Centre drills, HSCO

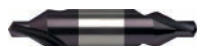

Machining group	HSCO		f (mm/rev) with nom. Ø							
	○	●								
	v _c (m/min)		0.5	1	1.25	1.6	2	2.5	3.15	4
P1.1.1 Unalloyed steel, annealed, 0.15 % C, Rm 420 N/mm ² , 125 HB	32	40	0.013	0.026	0.032	0.041	0.051	0.064	0.080	0.096
P1.1.2 Unalloyed steel, heat-treated, 0.15 % C, Rm 420 N/mm ² , 125 HB	27	34	0.010	0.020	0.026	0.033	0.041	0.051	0.064	0.076
P1.1.3 Unalloyed steel, annealed, 0.45 % C, Rm 640 N/mm ² , 190 HB	27	34	0.010	0.020	0.026	0.033	0.041	0.051	0.064	0.076
P1.1.4 Unalloyed steel, heat-treated, 0.45 % C, Rm 640 N/mm ² , 190 HB	27	34	0.010	0.020	0.026	0.033	0.041	0.051	0.064	0.076
P1.1.5 Unalloyed steel, heat-treated, 0.45 % C, Rm 850 N/mm ² , 250 HB	24	30	0.010	0.020	0.026	0.033	0.041	0.051	0.064	0.076
P1.1.6 Unalloyed steel, annealed, 0.75 % C, Rm 915 N/mm ² , 270 HB	23	28	0.010	0.020	0.026	0.033	0.041	0.051	0.064	0.076
P1.1.7 Unalloyed steel, heat-treated, 0.75 % C, Rm 1020 N/mm ² , 300 HB	19	24	0.010	0.020	0.026	0.033	0.041	0.051	0.064	0.076
P2.1.1 Low-alloy steel, annealed, Rm 610 N/mm ² , 180 HB	20	24	0.008	0.016	0.020	0.026	0.033	0.041	0.051	0.061
P2.1.2 Low-alloy steel, heat-treated, Rm 930 N/mm ² , 275 HB	14	17	0.007	0.013	0.016	0.021	0.026	0.033	0.041	0.049
P2.1.3 Low-alloy steel, heat-treated, Rm 1020 N/mm ² , 300 HB	12	15	0.007	0.013	0.016	0.021	0.026	0.033	0.041	0.049
P2.1.4 Low-alloy steel, heat-treated, Rm 1190 N/mm ² , 350 HB	11	13	0.005	0.010	0.013	0.017	0.021	0.026	0.032	0.039
P3.1.1 High-alloy steel and tool steel, annealed, Rm 680 N/mm ² , 200 HB	15	19	0.008	0.016	0.020	0.026	0.033	0.041	0.051	0.061
P3.1.2 High-alloy steel and tool steel, hardened and tempered, Rm 1100 N/mm ² , 325 HB	11	14	0.007	0.013	0.016	0.021	0.026	0.033	0.041	0.049
M1.1.1 Stainless steel, ferritic/martensitic, with machining additives	12	14	0.006	0.013	0.016	0.021	0.026	0.032	0.040	0.048
M1.1.2 Stainless steel, ferritic/martensitic, annealed, Rm 680 N/mm ² , 200 HB	10	13	0.006	0.013	0.016	0.021	0.026	0.032	0.040	0.048
M1.1.3 Stainless steel, ferritic/martensitic, heat-treated, Rm 810 N/mm ² , 240 HB	10	12	0.005	0.010	0.013	0.017	0.021	0.026	0.032	0.039
M2.1.1 Stainless steel, austenitic, quenched, 180 HB	9	12	0.006	0.013	0.016	0.021	0.026	0.032	0.040	0.048
M2.2.1 Duplex steel, high-strength stainless steels		8	0.005	0.010	0.013	0.017	0.021	0.026	0.032	0.039
K1.1.1 Grey cast iron, pearlitic/ferritic, 180 HB	35	43	0.013	0.026	0.032	0.041	0.051	0.064	0.080	0.096
K1.1.2 Grey cast iron, pearlitic/martensitic, 260 HB	28	35	0.013	0.026	0.032	0.041	0.051	0.064	0.080	0.096
K1.2.1 Cast iron with spheroidal graphite, ferritic, 160 HB	29	37	0.013	0.026	0.032	0.041	0.051	0.064	0.080	0.096
K1.2.2 Cast iron with spheroidal graphite, pearlitic, 250 HB	22	28	0.010	0.020	0.026	0.033	0.041	0.051	0.064	0.076
K1.3.1 Malleable cast iron, ferritic, 130 HB	29	37	0.013	0.026	0.032	0.041	0.051	0.064	0.080	0.096
K1.3.2 Malleable cast iron, pearlitic, 230 HB	22	28	0.010	0.020	0.026	0.033	0.041	0.051	0.064	0.076
K2.1.1 Vermicular graphite cast iron (GJV)	29	36	0.010	0.020	0.026	0.033	0.041	0.051	0.064	0.076
K2.2.1 Austenitic-ferritic spheroidal graphite cast iron (ADI)		18	0.005	0.010	0.013	0.016	0.020	0.026	0.032	0.038
N1.1.1 Wrought aluminium alloys, non-hardened, 60 HB	69		0.016	0.033	0.041	0.052	0.066	0.082	0.102	0.122
N1.1.2 Wrought aluminium alloys, hardened, 100 HB	69		0.016	0.033	0.041	0.052	0.066	0.082	0.102	0.122
N2.1.1 Aluminium casting alloys, non-hardened, ≤ 12 % Si, 75 HB	58	72	0.013	0.026	0.032	0.041	0.051	0.064	0.080	0.096
N2.1.2 Aluminium casting alloys, hardened, ≤ 12 % Si, 90 HB	46	58	0.010	0.020	0.026	0.033	0.041	0.051	0.064	0.076
N2.1.3 Aluminium casting alloys, non-hardened, > 12 % Si, 130 HB	40	50	0.010	0.020	0.026	0.033	0.041	0.051	0.064	0.076
N3.1.1 Copper and copper alloys: Free-machining alloy, Pb > 1 %	69	86	0.010	0.020	0.026	0.033	0.041	0.051	0.064	0.076
N3.1.2 Copper and copper alloys: CuZn, CuSnZn	41	52	0.008	0.016	0.020	0.026	0.033	0.041	0.051	0.061
N3.1.3 Copper and copper alloys: CuSn, lead-free copper and copper electrolyte	55	69	0.008	0.016	0.020	0.026	0.033	0.041	0.051	0.061
N4.1.1 Non-metallic materials: Duroplastics, fibre-reinforced plastics	23	29	0.010	0.020	0.026	0.033	0.041	0.051	0.064	0.076
N4.1.2 Non-metallic materials: Hard rubber, wood, etc.	23	29	0.010	0.020	0.026	0.033	0.041	0.051	0.064	0.076
N4.1.3 Non-metallic materials: Graphite										
S1.1.1 Heat-resistant alloys, Fe-based, annealed, 200 HB	7	9	0.005	0.010	0.013	0.016	0.020	0.026	0.032	0.038
S1.1.2 Heat-resistant alloys, Fe-based, hardened, 280 HB	6	7	0.004	0.008	0.010	0.013	0.016	0.020	0.026	0.031
S1.1.3 Heat-resistant alloys, Ni- or Co-based, annealed, 250 HB	6	7	0.005	0.010	0.013	0.016	0.020	0.026	0.032	0.038
S1.1.4 Heat-resistant alloys, Ni- or Co-based, hardened, 350 HB	3	4	0.004	0.008	0.010	0.013	0.016	0.020	0.026	0.031
S1.1.5 Heat-resistant alloys, Ni- or Co-based, cast, 320 HB	4	5	0.004	0.008	0.010	0.013	0.016	0.020	0.026	0.031
S2.1.1 Titanium alloys, pure titanium, Rm 400 N/mm ²	6	7	0.005	0.010	0.013	0.016	0.020	0.026	0.032	0.038
S2.1.2 Titanium alloys, Alpha and Beta alloys, hardened, Rm 1050 N/mm ²	4	5	0.004	0.008	0.010	0.013	0.016	0.020	0.026	0.031
H1.1.1 Hardened steel, hardened and tempered, < 55 HRC										
H1.1.2 Hardened steel, hardened and tempered, < 60 HRC										
H1.1.3 Hardened steel, hardened and tempered, > 60 HRC										
H2.1.1 Chilled cast iron, 400 HB										
H2.1.2 Chilled cast iron, hardened and tempered, < 55 HRC										



Centre drills, HSS



Machining group	HSS			f (mm/rev) with nom. Ø									
	○	Ⓢ	Ⓣ										
	v _c (m/min)			0.5	1	2	3.15	4	6.3	8	10	12.5	
P1.1.1 Unalloyed steel, annealed, 0.15 % C, Rm 420 N/mm ² , 125 HB	28	32	35	0.013	0.026	0.051	0.080	0.096	0.135	0.160	0.190	0.225	
P1.1.2 Unalloyed steel, heat-treated, 0.15 % C, Rm 420 N/mm ² , 125 HB	24	27	30	0.010	0.020	0.041	0.064	0.076	0.110	0.130	0.155	0.180	
P1.1.3 Unalloyed steel, annealed, 0.45 % C, Rm 640 N/mm ² , 190 HB	24	27	30	0.010	0.020	0.041	0.064	0.076	0.110	0.130	0.155	0.180	
P1.1.4 Unalloyed steel, heat-treated, 0.45 % C, Rm 640 N/mm ² , 190 HB	24	27	30	0.010	0.020	0.041	0.064	0.076	0.110	0.130	0.155	0.180	
P1.1.5 Unalloyed steel, heat-treated, 0.45 % C, Rm 850 N/mm ² , 250 HB	21	24	26	0.010	0.020	0.041	0.064	0.076	0.110	0.130	0.155	0.180	
P1.1.6 Unalloyed steel, annealed, 0.75 % C, Rm 915 N/mm ² , 270 HB	20	23	25	0.010	0.020	0.041	0.064	0.076	0.110	0.130	0.155	0.180	
P1.1.7 Unalloyed steel, heat-treated, 0.75 % C, Rm 1020 N/mm ² , 300 HB	17	19	21	0.010	0.020	0.041	0.064	0.076	0.110	0.130	0.155	0.180	
P2.1.1 Low-alloy steel, annealed, Rm 610 N/mm ² , 180 HB	17	20	21	0.008	0.016	0.033	0.051	0.061	0.085	0.105	0.125	0.145	
P2.1.2 Low-alloy steel, heat-treated, Rm 930 N/mm ² , 275 HB	12	14	15	0.007	0.013	0.026	0.041	0.049	0.070	0.085	0.100	0.115	
P2.1.3 Low-alloy steel, heat-treated, Rm 1020 N/mm ² , 300 HB	10	12	13	0.007	0.013	0.026	0.041	0.049	0.070	0.085	0.100	0.115	
P2.1.4 Low-alloy steel, heat-treated, Rm 1190 N/mm ² , 350 HB	9	11	12	0.005	0.010	0.021	0.032	0.039	0.055	0.065	0.075	0.090	
P3.1.1 High-alloy steel and tool steel, annealed, Rm 680 N/mm ² , 200 HB	13	15	16	0.008	0.016	0.033	0.051	0.061	0.085	0.105	0.125	0.145	
P3.1.2 High-alloy steel and tool steel, hardened and tempered, Rm 1100 N/mm ² , 325 HB	10	11	12	0.007	0.013	0.026	0.041	0.049	0.070	0.085	0.100	0.115	
M1.1.1 Stainless steel, ferritic/martensitic, with machining additives	10	12	13	0.006	0.013	0.026	0.040	0.048	0.070	0.080	0.095	0.115	
M1.1.2 Stainless steel, ferritic/martensitic, annealed, Rm 680 N/mm ² , 200 HB	9	10	11	0.006	0.013	0.026	0.040	0.048	0.070	0.080	0.095	0.115	
M1.1.3 Stainless steel, ferritic/martensitic, heat-treated, Rm 810 N/mm ² , 240 HB	9	10	11	0.005	0.010	0.021	0.032	0.039	0.055	0.065	0.075	0.090	
M2.1.1 Stainless steel, austenitic, quenched, 180 HB	8	9	10	0.006	0.013	0.026	0.040	0.048	0.070	0.080	0.095	0.115	
M2.2.1 Duplex steel, high-strength stainless steels		6	7	0.005	0.010	0.021	0.032	0.039	0.055	0.065	0.075	0.090	
K1.1.1 Grey cast iron, pearlitic/ferritic, 180 HB	30	35	38	0.013	0.026	0.051	0.080	0.096	0.135	0.160	0.190	0.225	
K1.1.2 Grey cast iron, pearlitic/martensitic, 260 HB	24	28	30	0.013	0.026	0.051	0.080	0.096	0.135	0.160	0.190	0.225	
K1.2.1 Cast iron with spheroidal graphite, ferritic, 160 HB	26	29	32	0.013	0.026	0.051	0.080	0.096	0.135	0.160	0.190	0.225	
K1.2.2 Cast iron with spheroidal graphite, pearlitic, 250 HB	20	22	24	0.010	0.020	0.041	0.064	0.076	0.110	0.130	0.155	0.180	
K1.3.1 Malleable cast iron, ferritic, 130 HB	26	29	32	0.013	0.026	0.051	0.080	0.096	0.135	0.160	0.190	0.225	
K1.3.2 Malleable cast iron, pearlitic, 230 HB	20	22	24	0.010	0.020	0.041	0.064	0.076	0.110	0.130	0.155	0.180	
K2.1.1 Vermicular graphite cast iron (GJV)	25	29	31	0.010	0.020	0.041	0.064	0.076	0.110	0.130	0.155	0.180	
K2.2.1 Austenitic-ferritic spheroidal graphite cast iron (ADI)		14	16	0.005	0.010	0.020	0.032	0.038	0.055	0.065	0.075	0.090	
N1.1.1 Wrought aluminium alloys, non-hardened, 60 HB	60			0.016	0.033	0.066	0.102	0.122	0.175	0.205	0.245	0.290	
N1.1.2 Wrought aluminium alloys, hardened, 100 HB	60			0.016	0.033	0.066	0.102	0.122	0.175	0.205	0.245	0.290	
N2.1.1 Aluminium casting alloys, non-hardened, ≤ 12 % Si, 75 HB	50	58	63	0.013	0.026	0.051	0.080	0.096	0.135	0.160	0.190	0.225	
N2.1.2 Aluminium casting alloys, hardened, ≤ 12 % Si, 90 HB	40	46	50	0.010	0.020	0.041	0.064	0.076	0.110	0.130	0.155	0.180	
N2.1.3 Aluminium casting alloys, non-hardened, > 12 % Si, 130 HB	35	40	44	0.010	0.020	0.041	0.064	0.076	0.110	0.130	0.155	0.180	
N3.1.1 Copper and copper alloys: Free-machining alloy, Pb > 1 %	60	69	75	0.010	0.020	0.041	0.064	0.076	0.110	0.130	0.155	0.180	
N3.1.2 Copper and copper alloys: CuZn, CuSnZn	36	41	45	0.008	0.016	0.033	0.051	0.061	0.085	0.105	0.125	0.145	
N3.1.3 Copper and copper alloys: CuSn, lead-free copper and copper electrolyte	48	55	60	0.008	0.016	0.033	0.051	0.061	0.085	0.105	0.125	0.145	
N4.1.1 Non-metallic materials: Duroplastics, fibre-reinforced plastics	20	23	25	0.010	0.020	0.041	0.064	0.076	0.110	0.130	0.155	0.180	
N4.1.2 Non-metallic materials: Hard rubber, wood, etc.	20	23	25	0.010	0.020	0.041	0.064	0.076	0.110	0.130	0.155	0.180	
N4.1.3 Non-metallic materials: Graphite													
S1.1.1 Heat-resistant alloys, Fe-based, annealed, 200 HB	6	7	8	0.005	0.010	0.020	0.032	0.038	0.055	0.065	0.075	0.090	
S1.1.2 Heat-resistant alloys, Fe-based, hardened, 280 HB	5	6	6	0.004	0.008	0.016	0.026	0.031	0.045	0.050	0.060	0.075	
S1.1.3 Heat-resistant alloys, Ni- or Co-based, annealed, 250 HB	5	6	6	0.005	0.010	0.020	0.032	0.038	0.055	0.065	0.075	0.090	
S1.1.4 Heat-resistant alloys, Ni- or Co-based, hardened, 350 HB	3	3	4	0.004	0.008	0.016	0.026	0.031	0.045	0.050	0.060	0.075	
S1.1.5 Heat-resistant alloys, Ni- or Co-based, cast, 320 HB	4	4	5	0.004	0.008	0.016	0.026	0.031	0.045	0.050	0.060	0.075	
S2.1.1 Titanium alloys, pure titanium, Rm 400 N/mm ²	5	6	6	0.005	0.010	0.020	0.032	0.038	0.055	0.065	0.075	0.090	
S2.1.2 Titanium alloys, Alpha and Beta alloys, hardened, Rm 1050 N/mm ²	3	4	4	0.004	0.008	0.016	0.026	0.031	0.045	0.050	0.060	0.075	
H1.1.1 Hardened steel, hardened and tempered, < 55 HRC													
H1.1.2 Hardened steel, hardened and tempered, < 60 HRC													
H1.1.3 Hardened steel, hardened and tempered, > 60 HRC													
H2.1.1 Chilled cast iron, 400 HB													
H2.1.2 Chilled cast iron, hardened and tempered, < 55 HRC													



NC spotting drills, solid carbide



Cutting data

Machining group	VHM		f (mm/rev) with nom. Ø							
	○	●								
	v _c (m/min)		1	3	6	8	10	12	16	20
P1.1.1 Unalloyed steel, annealed, 0.15 % C, Rm 420 N/mm ² , 125 HB	75	100	0.030	0.095	0.165	0.205	0.240	0.275	0.345	0.405
P1.1.2 Unalloyed steel, heat-treated, 0.15 % C, Rm 420 N/mm ² , 125 HB	70	90	0.030	0.085	0.145	0.180	0.215	0.250	0.310	0.365
P1.1.3 Unalloyed steel, annealed, 0.45 % C, Rm 640 N/mm ² , 190 HB	70	90	0.030	0.085	0.145	0.180	0.215	0.250	0.310	0.365
P1.1.4 Unalloyed steel, heat-treated, 0.45 % C, Rm 640 N/mm ² , 190 HB	65	85	0.025	0.080	0.140	0.170	0.205	0.235	0.290	0.345
P1.1.5 Unalloyed steel, heat-treated, 0.45 % C, Rm 850 N/mm ² , 250 HB	65	85	0.025	0.080	0.140	0.170	0.205	0.235	0.290	0.345
P1.1.6 Unalloyed steel, annealed, 0.75 % C, Rm 915 N/mm ² , 270 HB	60	80	0.025	0.075	0.130	0.160	0.190	0.220	0.275	0.325
P1.1.7 Unalloyed steel, heat-treated, 0.75 % C, Rm 1020 N/mm ² , 300 HB	55	75	0.025	0.070	0.120	0.150	0.180	0.205	0.255	0.305
P2.1.1 Low-alloy steel, annealed, Rm 610 N/mm ² , 180 HB	40	55	0.020	0.060	0.105	0.130	0.155	0.175	0.220	0.260
P2.1.2 Low-alloy steel, heat-treated, Rm 930 N/mm ² , 275 HB	40	55	0.020	0.060	0.105	0.130	0.155	0.175	0.220	0.260
P2.1.3 Low-alloy steel, heat-treated, Rm 1020 N/mm ² , 300 HB	30	45	0.015	0.050	0.090	0.110	0.130	0.150	0.185	0.220
P2.1.4 Low-alloy steel, heat-treated, Rm 1190 N/mm ² , 350 HB	30	40	0.015	0.045	0.080	0.095	0.115	0.130	0.165	0.195
P3.1.1 High-alloy steel and tool steel, annealed, Rm 680 N/mm ² , 200 HB	40	55	0.020	0.060	0.105	0.130	0.155	0.175	0.220	0.260
P3.1.2 High-alloy steel and tool steel, hardened and tempered, Rm 1100 N/mm ² , 325 HB	35	45	0.015	0.050	0.090	0.110	0.130	0.150	0.185	0.220
M1.1.1 Stainless steel, ferritic/martensitic, with machining additives	25	35	0.015	0.050	0.080	0.100	0.120	0.140	0.175	0.205
M1.1.2 Stainless steel, ferritic/martensitic, annealed, Rm 680 N/mm ² , 200 HB	25	30	0.015	0.045	0.075	0.090	0.110	0.125	0.155	0.185
M1.1.3 Stainless steel, ferritic/martensitic, heat-treated, Rm 810 N/mm ² , 240 HB	20	30	0.015	0.040	0.070	0.085	0.105	0.120	0.145	0.175
M2.1.1 Stainless steel, austenitic, quenched, 180 HB	20	25	0.015	0.050	0.080	0.100	0.120	0.140	0.175	0.205
M2.2.1 Duplex steel, high-strength stainless steels	15	20	0.015	0.040	0.070	0.085	0.105	0.120	0.145	0.175
K1.1.1 Grey cast iron, pearlitic/ferritic, 180 HB	80	90	0.040	0.125	0.210	0.260	0.305	0.355	0.440	0.520
K1.1.2 Grey cast iron, pearlitic/martensitic, 260 HB	70	75	0.035	0.105	0.175	0.220	0.260	0.300	0.375	0.440
K1.2.1 Cast iron with spheroidal graphite, ferritic, 160 HB	70	75	0.035	0.105	0.175	0.220	0.260	0.300	0.375	0.440
K1.2.2 Cast iron with spheroidal graphite, pearlitic, 250 HB	65	70	0.035	0.100	0.165	0.205	0.245	0.280	0.350	0.415
K1.3.1 Malleable cast iron, ferritic, 130 HB	65	70	0.035	0.100	0.165	0.205	0.245	0.280	0.350	0.415
K1.3.2 Malleable cast iron, pearlitic, 230 HB	55	65	0.030	0.085	0.145	0.180	0.215	0.245	0.305	0.365
K2.1.1 Vermicular graphite cast iron (GJV)		70	0.040	0.125	0.210	0.260	0.305	0.355	0.440	0.520
K2.2.1 Austenitic-ferritic spheroidal graphite cast iron (ADI)		55	0.030	0.090	0.155	0.195	0.230	0.265	0.330	0.390
N1.1.1 Wrought aluminium alloys, non-hardened, 60 HB	160	165	0.040	0.125	0.210	0.260	0.305	0.355	0.440	0.520
N1.1.2 Wrought aluminium alloys, hardened, 100 HB	160	165	0.040	0.125	0.210	0.260	0.305	0.355	0.440	0.520
N2.1.1 Aluminium casting alloys, non-hardened, ≤ 12 % Si, 75 HB	140	150	0.040	0.125	0.210	0.260	0.305	0.355	0.440	0.520
N2.1.2 Aluminium casting alloys, hardened, ≤ 12 % Si, 90 HB	140	150	0.040	0.125	0.210	0.260	0.305	0.355	0.440	0.520
N2.1.3 Aluminium casting alloys, non-hardened, > 12 % Si, 130 HB	120	130	0.035	0.105	0.175	0.220	0.260	0.300	0.375	0.440
N3.1.1 Copper and copper alloys: Free-machining alloy, Pb > 1 %	80	110	0.030	0.095	0.165	0.205	0.240	0.275	0.345	0.405
N3.1.2 Copper and copper alloys: CuZn, CuSnZn	70	95	0.025	0.080	0.140	0.170	0.205	0.235	0.290	0.345
N3.1.3 Copper and copper alloys: CuSn, lead-free copper and copper electrolyte	65	90	0.025	0.075	0.130	0.160	0.190	0.220	0.275	0.325
N4.1.1 Non-metallic materials: Duroplastics, fibre-reinforced plastics	50	55	0.015	0.040	0.065	0.080	0.095	0.110	0.135	0.165
N4.1.2 Non-metallic materials: Hard rubber, wood, etc.	50	55	0.015	0.040	0.065	0.080	0.095	0.110	0.135	0.165
N4.1.3 Non-metallic materials: Graphite										
S1.1.1 Heat-resistant alloys, Fe-based, annealed, 200 HB	25	35	0.015	0.040	0.065	0.080	0.095	0.110	0.135	0.165
S1.1.2 Heat-resistant alloys, Fe-based, hardened, 280 HB	20	30	0.010	0.030	0.050	0.065	0.075	0.090	0.110	0.130
S1.1.3 Heat-resistant alloys, Ni- or Co-based, annealed, 250 HB	20	30	0.015	0.040	0.065	0.080	0.095	0.110	0.135	0.165
S1.1.4 Heat-resistant alloys, Ni- or Co-based, hardened, 350 HB	15	20	0.010	0.025	0.045	0.055	0.065	0.075	0.095	0.115
S1.1.5 Heat-resistant alloys, Ni- or Co-based, cast, 320 HB	15	20	0.010	0.025	0.045	0.055	0.065	0.075	0.095	0.115
S2.1.1 Titanium alloys, pure titanium, Rm 400 N/mm ²	15	25	0.010	0.030	0.050	0.065	0.075	0.090	0.110	0.130
S2.1.2 Titanium alloys, Alpha and Beta alloys, hardened, Rm 1050 N/mm ²	10	20	0.010	0.025	0.040	0.050	0.060	0.070	0.090	0.105
H1.1.1 Hardened steel, hardened and tempered, < 55 HRC	20	25	0.015	0.040	0.065	0.080	0.095	0.110	0.135	0.165
H1.1.2 Hardened steel, hardened and tempered, < 60 HRC										
H1.1.3 Hardened steel, hardened and tempered, > 60 HRC										
H2.1.1 Chilled cast iron, 400 HB										
H2.1.2 Chilled cast iron, hardened and tempered, < 55 HRC										



NC spotting drills and spot weld drills, HSCO



Machining group	HSCO		f (mm/rev) with nom. Ø								
	○	●									
	v _c (m/min)		3	4	5	6	8	10	12	16	20
P1.1.1 Unalloyed steel, annealed, 0.15 % C, Rm 420 N/mm ² , 125 HB	40	32	0.120	0.149	0.175	0.205	0.255	0.300	0.345	0.430	0.510
P1.1.2 Unalloyed steel, heat-treated, 0.15 % C, Rm 420 N/mm ² , 125 HB	34	27	0.096	0.119	0.140	0.165	0.200	0.240	0.275	0.345	0.405
P1.1.3 Unalloyed steel, annealed, 0.45 % C, Rm 640 N/mm ² , 190 HB	34	27	0.096	0.119	0.140	0.165	0.200	0.240	0.275	0.345	0.405
P1.1.4 Unalloyed steel, heat-treated, 0.45 % C, Rm 640 N/mm ² , 190 HB	34	27	0.096	0.119	0.140	0.165	0.200	0.240	0.275	0.345	0.405
P1.1.5 Unalloyed steel, heat-treated, 0.45 % C, Rm 850 N/mm ² , 250 HB	30	24	0.096	0.119	0.140	0.165	0.200	0.240	0.275	0.345	0.405
P1.1.6 Unalloyed steel, annealed, 0.75 % C, Rm 915 N/mm ² , 270 HB	28	23	0.096	0.119	0.140	0.165	0.200	0.240	0.275	0.345	0.405
P1.1.7 Unalloyed steel, heat-treated, 0.75 % C, Rm 1020 N/mm ² , 300 HB	24	19	0.096	0.119	0.140	0.165	0.200	0.240	0.275	0.345	0.405
P2.1.1 Low-alloy steel, annealed, Rm 610 N/mm ² , 180 HB	24	20	0.077	0.096	0.115	0.130	0.160	0.190	0.220	0.275	0.325
P2.1.2 Low-alloy steel, heat-treated, Rm 930 N/mm ² , 275 HB	17	14	0.061	0.076	0.090	0.105	0.130	0.155	0.175	0.220	0.260
P2.1.3 Low-alloy steel, heat-treated, Rm 1020 N/mm ² , 300 HB	15	12	0.061	0.076	0.090	0.105	0.130	0.155	0.175	0.220	0.260
P2.1.4 Low-alloy steel, heat-treated, Rm 1190 N/mm ² , 350 HB	13	11	0.048	0.060	0.070	0.080	0.100	0.120	0.140	0.175	0.205
P3.1.1 High-alloy steel and tool steel, annealed, Rm 680 N/mm ² , 200 HB	19	15	0.077	0.096	0.115	0.130	0.160	0.190	0.220	0.275	0.325
P3.1.2 High-alloy steel and tool steel, hardened and tempered, Rm 1100 N/mm ² , 325 HB	14	11	0.061	0.076	0.090	0.105	0.130	0.155	0.175	0.220	0.260
M1.1.1 Stainless steel, ferritic/martensitic, with machining additives	14	12	0.060	0.075	0.090	0.100	0.125	0.150	0.175	0.215	0.255
M1.1.2 Stainless steel, ferritic/martensitic, annealed, Rm 680 N/mm ² , 200 HB	13	10	0.060	0.075	0.090	0.100	0.125	0.150	0.175	0.215	0.255
M1.1.3 Stainless steel, ferritic/martensitic, heat-treated, Rm 810 N/mm ² , 240 HB	12	10	0.048	0.060	0.070	0.080	0.100	0.120	0.140	0.175	0.205
M2.1.1 Stainless steel, austenitic, quenched, 180 HB	12	9	0.060	0.075	0.090	0.100	0.125	0.150	0.175	0.215	0.255
M2.2.1 Duplex steel, high-strength stainless steels	8	6	0.048	0.060	0.070	0.080	0.100	0.120	0.140	0.175	0.205
K1.1.1 Grey cast iron, pearlitic/ferritic, 180 HB	43	35	0.120	0.149	0.175	0.205	0.255	0.300	0.345	0.430	0.510
K1.1.2 Grey cast iron, pearlitic/martensitic, 260 HB	35	28	0.120	0.149	0.175	0.205	0.255	0.300	0.345	0.430	0.510
K1.2.1 Cast iron with spheroidal graphite, ferritic, 160 HB	37	29	0.120	0.149	0.175	0.205	0.255	0.300	0.345	0.430	0.510
K1.2.2 Cast iron with spheroidal graphite, pearlitic, 250 HB	28	22	0.096	0.119	0.140	0.165	0.200	0.240	0.275	0.345	0.405
K1.3.1 Malleable cast iron, ferritic, 130 HB	37	29	0.120	0.149	0.175	0.205	0.255	0.300	0.345	0.430	0.510
K1.3.2 Malleable cast iron, pearlitic, 230 HB	28	22	0.096	0.119	0.140	0.165	0.200	0.240	0.275	0.345	0.405
K2.1.1 Vermicular graphite cast iron (GJV)	36	29	0.096	0.119	0.140	0.165	0.200	0.240	0.275	0.345	0.405
K2.2.1 Austenitic-ferritic spheroidal graphite cast iron (ADI)	18	14	0.048	0.060	0.070	0.080	0.100	0.120	0.140	0.170	0.205
N1.1.1 Wrought aluminium alloys, non-hardened, 60 HB											
N1.1.2 Wrought aluminium alloys, hardened, 100 HB											
N2.1.1 Aluminium casting alloys, non-hardened, ≤ 12 % Si, 75 HB	72	58	0.120	0.149	0.175	0.205	0.255	0.300	0.345	0.430	0.510
N2.1.2 Aluminium casting alloys, hardened, ≤ 12 % Si, 90 HB	58	46	0.096	0.119	0.140	0.165	0.200	0.240	0.275	0.345	0.405
N2.1.3 Aluminium casting alloys, non-hardened, > 12 % Si, 130 HB	50	40	0.096	0.119	0.140	0.165	0.200	0.240	0.275	0.345	0.405
N3.1.1 Copper and copper alloys: Free-machining alloy, Pb > 1 %	86	69	0.096	0.119	0.140	0.165	0.200	0.240	0.275	0.345	0.405
N3.1.2 Copper and copper alloys: CuZn, CuSnZn	52	41	0.077	0.096	0.115	0.130	0.160	0.190	0.220	0.275	0.325
N3.1.3 Copper and copper alloys: CuSn, lead-free copper and copper electrolyte	69	55	0.077	0.096	0.115	0.130	0.160	0.190	0.220	0.275	0.325
N4.1.1 Non-metallic materials: Duroplastics, fibre-reinforced plastics	29	23	0.096	0.119	0.140	0.165	0.200	0.240	0.275	0.345	0.405
N4.1.2 Non-metallic materials: Hard rubber, wood, etc.	29	23	0.096	0.119	0.140	0.165	0.200	0.240	0.275	0.345	0.405
N4.1.3 Non-metallic materials: Graphite											
S1.1.1 Heat-resistant alloys, Fe-based, annealed, 200 HB	9	7	0.048	0.060	0.070	0.080	0.100	0.120	0.140	0.170	0.205
S1.1.2 Heat-resistant alloys, Fe-based, hardened, 280 HB	7	6	0.038	0.048	0.055	0.065	0.080	0.095	0.110	0.135	0.160
S1.1.3 Heat-resistant alloys, Ni- or Co-based, annealed, 250 HB	7	6	0.048	0.060	0.070	0.080	0.100	0.120	0.140	0.170	0.205
S1.1.4 Heat-resistant alloys, Ni- or Co-based, hardened, 350 HB	4	3	0.038	0.048	0.055	0.065	0.080	0.095	0.110	0.135	0.160
S1.1.5 Heat-resistant alloys, Ni- or Co-based, cast, 320 HB	5	4	0.038	0.048	0.055	0.065	0.080	0.095	0.110	0.135	0.160
S2.1.1 Titanium alloys, pure titanium, Rm 400 N/mm ²	7	6	0.048	0.060	0.070	0.080	0.100	0.120	0.140	0.170	0.205
S2.1.2 Titanium alloys, Alpha and Beta alloys, hardened, Rm 1050 N/mm ²	5	4	0.038	0.048	0.055	0.065	0.080	0.095	0.110	0.135	0.160
H1.1.1 Hardened steel, hardened and tempered, < 55 HRC											
H1.1.2 Hardened steel, hardened and tempered, < 60 HRC											
H1.1.3 Hardened steel, hardened and tempered, > 60 HRC											
H2.1.1 Chilled cast iron, 400 HB											
H2.1.2 Chilled cast iron, hardened and tempered, < 55 HRC											



NC spotting drills, HSS



Cutting data

Machining group	HSS		f (mm/rev) with nom. Ø								
	○	Ⓢ									
	v _c (m/min)		3	4	6	8	10	12	16	20	25
P1.1.1 Unalloyed steel, annealed, 0.15 % C, Rm 420 N/mm ² , 125 HB	28	32	0.096	0.119	0.165	0.200	0.240	0.275	0.345	0.405	0.480
P1.1.2 Unalloyed steel, heat-treated, 0.15 % C, Rm 420 N/mm ² , 125 HB	24	27	0.077	0.096	0.130	0.160	0.190	0.220	0.275	0.325	0.385
P1.1.3 Unalloyed steel, annealed, 0.45 % C, Rm 640 N/mm ² , 190 HB	24	27	0.077	0.096	0.130	0.160	0.190	0.220	0.275	0.325	0.385
P1.1.4 Unalloyed steel, heat-treated, 0.45 % C, Rm 640 N/mm ² , 190 HB	24	27	0.077	0.096	0.130	0.160	0.190	0.220	0.275	0.325	0.385
P1.1.5 Unalloyed steel, heat-treated, 0.45 % C, Rm 850 N/mm ² , 250 HB	21	24	0.077	0.096	0.130	0.160	0.190	0.220	0.275	0.325	0.385
P1.1.6 Unalloyed steel, annealed, 0.75 % C, Rm 915 N/mm ² , 270 HB	20	23	0.077	0.096	0.130	0.160	0.190	0.220	0.275	0.325	0.385
P1.1.7 Unalloyed steel, heat-treated, 0.75 % C, Rm 1020 N/mm ² , 300 HB	17	19	0.077	0.096	0.130	0.160	0.190	0.220	0.275	0.325	0.385
P2.1.1 Low-alloy steel, annealed, Rm 610 N/mm ² , 180 HB	17	20	0.061	0.076	0.105	0.130	0.155	0.175	0.220	0.260	0.310
P2.1.2 Low-alloy steel, heat-treated, Rm 930 N/mm ² , 275 HB	12	14	0.049	0.061	0.085	0.105	0.125	0.140	0.175	0.210	0.245
P2.1.3 Low-alloy steel, heat-treated, Rm 1020 N/mm ² , 300 HB	10	12	0.049	0.061	0.085	0.105	0.125	0.140	0.175	0.210	0.245
P2.1.4 Low-alloy steel, heat-treated, Rm 1190 N/mm ² , 350 HB	9	11	0.039	0.048	0.065	0.080	0.095	0.110	0.140	0.165	0.195
P3.1.1 High-alloy steel and tool steel, annealed, Rm 680 N/mm ² , 200 HB	13	15	0.061	0.076	0.105	0.130	0.155	0.175	0.220	0.260	0.310
P3.1.2 High-alloy steel and tool steel, hardened and tempered, Rm 1100 N/mm ² , 325 HB											
M1.1.1 Stainless steel, ferritic/martensitic, with machining additives	10	12	0.048	0.060	0.080	0.100	0.120	0.140	0.175	0.205	0.240
M1.1.2 Stainless steel, ferritic/martensitic, annealed, Rm 680 N/mm ² , 200 HB	9	10	0.048	0.060	0.080	0.100	0.120	0.140	0.175	0.205	0.240
M1.1.3 Stainless steel, ferritic/martensitic, heat-treated, Rm 810 N/mm ² , 240 HB	9	10	0.039	0.048	0.065	0.080	0.095	0.110	0.140	0.165	0.195
M2.1.1 Stainless steel, austenitic, quenched, 180 HB	8	9	0.048	0.060	0.080	0.100	0.120	0.140	0.175	0.205	0.240
M2.2.1 Duplex steel, high-strength stainless steels											
K1.1.1 Grey cast iron, pearlitic/ferritic, 180 HB	30	35	0.096	0.119	0.165	0.200	0.240	0.275	0.345	0.405	0.480
K1.1.2 Grey cast iron, pearlitic/martensitic, 260 HB	24	28	0.096	0.119	0.165	0.200	0.240	0.275	0.345	0.405	0.480
K1.2.1 Cast iron with spheroidal graphite, ferritic, 160 HB	26	29	0.096	0.119	0.165	0.200	0.240	0.275	0.345	0.405	0.480
K1.2.2 Cast iron with spheroidal graphite, pearlitic, 250 HB	20	22	0.077	0.096	0.130	0.160	0.190	0.220	0.275	0.325	0.385
K1.3.1 Malleable cast iron, ferritic, 130 HB	26	29	0.096	0.119	0.165	0.200	0.240	0.275	0.345	0.405	0.480
K1.3.2 Malleable cast iron, pearlitic, 230 HB	20	22	0.077	0.096	0.130	0.160	0.190	0.220	0.275	0.325	0.385
K2.1.1 Vermicular graphite cast iron (GJV)	25	29	0.077	0.096	0.130	0.160	0.190	0.220	0.275	0.325	0.385
K2.2.1 Austenitic-ferritic spheroidal graphite cast iron (ADI)											
N1.1.1 Wrought aluminium alloys, non-hardened, 60 HB											
N1.1.2 Wrought aluminium alloys, hardened, 100 HB											
N2.1.1 Aluminium casting alloys, non-hardened, ≤ 12 % Si, 75 HB	50	58	0.096	0.119	0.165	0.200	0.240	0.275	0.345	0.405	0.480
N2.1.2 Aluminium casting alloys, hardened, ≤ 12 % Si, 90 HB	40	46	0.077	0.096	0.130	0.160	0.190	0.220	0.275	0.325	0.385
N2.1.3 Aluminium casting alloys, non-hardened, > 12 % Si, 130 HB	35	40	0.077	0.096	0.130	0.160	0.190	0.220	0.275	0.325	0.385
N3.1.1 Copper and copper alloys: Free-machining alloy, Pb > 1 %	60	69	0.077	0.096	0.130	0.160	0.190	0.220	0.275	0.325	0.385
N3.1.2 Copper and copper alloys: CuZn, CuSnZn	36	41	0.061	0.076	0.105	0.130	0.155	0.175	0.220	0.260	0.310
N3.1.3 Copper and copper alloys: CuSn, lead-free copper and copper electrolyte	48	55	0.061	0.076	0.105	0.130	0.155	0.175	0.220	0.260	0.310
N4.1.1 Non-metallic materials: Duroplastics, fibre-reinforced plastics	20	23	0.077	0.096	0.130	0.160	0.190	0.220	0.275	0.325	0.385
N4.1.2 Non-metallic materials: Hard rubber, wood, etc.	20	23	0.077	0.096	0.130	0.160	0.190	0.220	0.275	0.325	0.385
N4.1.3 Non-metallic materials: Graphite											
S1.1.1 Heat-resistant alloys, Fe-based, annealed, 200 HB	6	7	0.038	0.048	0.065	0.080	0.095	0.110	0.135	0.160	0.190
S1.1.2 Heat-resistant alloys, Fe-based, hardened, 280 HB	5	6	0.031	0.038	0.050	0.065	0.075	0.090	0.110	0.130	0.155
S1.1.3 Heat-resistant alloys, Ni- or Co-based, annealed, 250 HB	5	6	0.038	0.048	0.065	0.080	0.095	0.110	0.135	0.160	0.190
S1.1.4 Heat-resistant alloys, Ni- or Co-based, hardened, 350 HB	3	3	0.031	0.038	0.050	0.065	0.075	0.090	0.110	0.130	0.155
S1.1.5 Heat-resistant alloys, Ni- or Co-based, cast, 320 HB	4	4	0.031	0.038	0.050	0.065	0.075	0.090	0.110	0.130	0.155
S2.1.1 Titanium alloys, pure titanium, Rm 400 N/mm ²	5	6	0.038	0.048	0.065	0.080	0.095	0.110	0.135	0.160	0.190
S2.1.2 Titanium alloys, Alpha and Beta alloys, hardened, Rm 1050 N/mm ²	3	4	0.031	0.038	0.050	0.065	0.075	0.090	0.110	0.130	0.155
H1.1.1 Hardened steel, hardened and tempered, < 55 HRC											
H1.1.2 Hardened steel, hardened and tempered, < 60 HRC											
H1.1.3 Hardened steel, hardened and tempered, > 60 HRC											
H2.1.1 Chilled cast iron, 400 HB											
H2.1.2 Chilled cast iron, hardened and tempered, < 55 HRC											



Step drills



Machining group	HSS		f (mm/rev) with nom. Ø								
	v _c (m/min)		3.4	4.5	6	9	11	14	20	31.5	40
P1.1.1 Unalloyed steel, annealed, 0.15 % C, Rm 420 N/mm ² , 125 HB	28	32	0.106	0.130	0.165	0.220	0.260	0.310	0.405	0.575	0.690
P1.1.2 Unalloyed steel, heat-treated, 0.15 % C, Rm 420 N/mm ² , 125 HB	24	27	0.084	0.105	0.130	0.175	0.205	0.250	0.325	0.460	0.550
P1.1.3 Unalloyed steel, annealed, 0.45 % C, Rm 640 N/mm ² , 190 HB	24	27	0.084	0.105	0.130	0.175	0.205	0.250	0.325	0.460	0.550
P1.1.4 Unalloyed steel, heat-treated, 0.45 % C, Rm 640 N/mm ² , 190 HB	24	27	0.084	0.105	0.130	0.175	0.205	0.250	0.325	0.460	0.550
P1.1.5 Unalloyed steel, heat-treated, 0.45 % C, Rm 850 N/mm ² , 250 HB	21	24	0.084	0.105	0.130	0.175	0.205	0.250	0.325	0.460	0.550
P1.1.6 Unalloyed steel, annealed, 0.75 % C, Rm 915 N/mm ² , 270 HB	20	23	0.084	0.105	0.130	0.175	0.205	0.250	0.325	0.460	0.550
P1.1.7 Unalloyed steel, heat-treated, 0.75 % C, Rm 1020 N/mm ² , 300 HB	17	19	0.084	0.105	0.130	0.175	0.205	0.250	0.325	0.460	0.550
P2.1.1 Low-alloy steel, annealed, Rm 610 N/mm ² , 180 HB	17	20	0.068	0.085	0.105	0.140	0.165	0.200	0.260	0.365	0.440
P2.1.2 Low-alloy steel, heat-treated, Rm 930 N/mm ² , 275 HB	12	14	0.054	0.065	0.085	0.115	0.130	0.160	0.210	0.295	0.350
P2.1.3 Low-alloy steel, heat-treated, Rm 1020 N/mm ² , 300 HB	10	12	0.054	0.065	0.085	0.115	0.130	0.160	0.210	0.295	0.350
P2.1.4 Low-alloy steel, heat-treated, Rm 1190 N/mm ² , 350 HB	9	11	0.043	0.055	0.065	0.090	0.105	0.125	0.165	0.230	0.275
P3.1.1 High-alloy steel and tool steel, annealed, Rm 680 N/mm ² , 200 HB	13	15	0.068	0.085	0.105	0.140	0.165	0.200	0.260	0.365	0.440
P3.1.2 High-alloy steel and tool steel, hardened and tempered, Rm 1100 N/mm ² , 325 HB	10	11	0.054	0.065	0.085	0.115	0.130	0.160	0.210	0.295	0.350
M1.1.1 Stainless steel, ferritic/martensitic, with machining additives	10	12	0.053	0.065	0.080	0.110	0.130	0.155	0.205	0.290	0.345
M1.1.2 Stainless steel, ferritic/martensitic, annealed, Rm 680 N/mm ² , 200 HB	9	10	0.053	0.065	0.080	0.110	0.130	0.155	0.205	0.290	0.345
M1.1.3 Stainless steel, ferritic/martensitic, heat-treated, Rm 810 N/mm ² , 240 HB	9	10	0.043	0.055	0.065	0.090	0.105	0.125	0.165	0.230	0.275
M2.1.1 Stainless steel, austenitic, quenched, 180 HB	8	9	0.053	0.065	0.080	0.110	0.130	0.155	0.205	0.290	0.345
M2.2.1 Duplex steel, high-strength stainless steels											
K1.1.1 Grey cast iron, pearlitic/ferritic, 180 HB	30	35	0.106	0.130	0.165	0.220	0.260	0.310	0.405	0.575	0.690
K1.1.2 Grey cast iron, pearlitic/martensitic, 260 HB	24	28	0.106	0.130	0.165	0.220	0.260	0.310	0.405	0.575	0.690
K1.2.1 Cast iron with spheroidal graphite, ferritic, 160 HB	26	29	0.106	0.130	0.165	0.220	0.260	0.310	0.405	0.575	0.690
K1.2.2 Cast iron with spheroidal graphite, pearlitic, 250 HB	20	22	0.084	0.105	0.130	0.175	0.205	0.250	0.325	0.460	0.550
K1.3.1 Malleable cast iron, ferritic, 130 HB	26	29	0.106	0.130	0.165	0.220	0.260	0.310	0.405	0.575	0.690
K1.3.2 Malleable cast iron, pearlitic, 230 HB	20	22	0.084	0.105	0.130	0.175	0.205	0.250	0.325	0.460	0.550
K2.1.1 Vermicular graphite cast iron (GJV)	25	29	0.084	0.105	0.130	0.175	0.205	0.250	0.325	0.460	0.550
K2.2.1 Austenitic-ferritic spheroidal graphite cast iron (ADI)											
N1.1.1 Wrought aluminium alloys, non-hardened, 60 HB	60	69	0.135	0.165	0.210	0.285	0.330	0.395	0.520	0.735	0.880
N1.1.2 Wrought aluminium alloys, hardened, 100 HB	60	69	0.135	0.165	0.210	0.285	0.330	0.395	0.520	0.735	0.880
N2.1.1 Aluminium casting alloys, non-hardened, ≤ 12 % Si, 75 HB	50	58	0.106	0.130	0.165	0.220	0.260	0.310	0.405	0.575	0.690
N2.1.2 Aluminium casting alloys, hardened, ≤ 12 % Si, 90 HB	40	46	0.084	0.105	0.130	0.175	0.205	0.250	0.325	0.460	0.550
N2.1.3 Aluminium casting alloys, non-hardened, > 12 % Si, 130 HB	35	40	0.084	0.105	0.130	0.175	0.205	0.250	0.325	0.460	0.550
N3.1.1 Copper and copper alloys: Free-machining alloy, Pb > 1 %	60	69	0.084	0.105	0.130	0.175	0.205	0.250	0.325	0.460	0.550
N3.1.2 Copper and copper alloys: CuZn, CuSnZn	36	41	0.068	0.085	0.105	0.140	0.165	0.200	0.260	0.365	0.440
N3.1.3 Copper and copper alloys: CuSn, lead-free copper and copper electrolyte	48	55	0.068	0.085	0.105	0.140	0.165	0.200	0.260	0.365	0.440
N4.1.1 Non-metallic materials: Duroplastics, fibre-reinforced plastics	20	23	0.084	0.105	0.130	0.175	0.205	0.250	0.325	0.460	0.550
N4.1.2 Non-metallic materials: Hard rubber, wood, etc.	20	23	0.084	0.105	0.130	0.175	0.205	0.250	0.325	0.460	0.550
N4.1.3 Non-metallic materials: Graphite											
S1.1.1 Heat-resistant alloys, Fe-based, annealed, 200 HB	6	7	0.042	0.050	0.065	0.090	0.105	0.125	0.160	0.230	0.275
S1.1.2 Heat-resistant alloys, Fe-based, hardened, 280 HB	5	6	0.034	0.040	0.050	0.070	0.080	0.100	0.130	0.185	0.220
S1.1.3 Heat-resistant alloys, Ni- or Co-based, annealed, 250 HB	5	6	0.042	0.050	0.065	0.090	0.105	0.125	0.160	0.230	0.275
S1.1.4 Heat-resistant alloys, Ni- or Co-based, hardened, 350 HB	3	3	0.034	0.040	0.050	0.070	0.080	0.100	0.130	0.185	0.220
S1.1.5 Heat-resistant alloys, Ni- or Co-based, cast, 320 HB	4	4	0.034	0.040	0.050	0.070	0.080	0.100	0.130	0.185	0.220
S2.1.1 Titanium alloys, pure titanium, Rm 400 N/mm ²	5	6	0.042	0.050	0.065	0.090	0.105	0.125	0.160	0.230	0.275
S2.1.2 Titanium alloys, Alpha and Beta alloys, hardened, Rm 1050 N/mm ²	3	4	0.034	0.040	0.050	0.070	0.080	0.100	0.130	0.185	0.220
H1.1.1 Hardened steel, hardened and tempered, < 55 HRC											
H1.1.2 Hardened steel, hardened and tempered, < 60 HRC											
H1.1.3 Hardened steel, hardened and tempered, > 60 HRC											
H2.1.1 Chilled cast iron, 400 HB											
H2.1.2 Chilled cast iron, hardened and tempered, < 55 HRC											



Core drills



Machining group	HSS	f (mm/rev) with nom. Ø									
	●										
	v _c (m/min)	4	6	8	10	16	20	30	40	50	
P1.1.1 Unalloyed steel, annealed, 0.15 % C, Rm 420 N/mm ² , 125 HB	28	0.119	0.165	0.200	0.240	0.345	0.405	0.555	0.690	0.815	
P1.1.2 Unalloyed steel, heat-treated, 0.15 % C, Rm 420 N/mm ² , 125 HB	24	0.096	0.130	0.160	0.190	0.275	0.325	0.440	0.550	0.650	
P1.1.3 Unalloyed steel, annealed, 0.45 % C, Rm 640 N/mm ² , 190 HB	24	0.096	0.130	0.160	0.190	0.275	0.325	0.440	0.550	0.650	
P1.1.4 Unalloyed steel, heat-treated, 0.45 % C, Rm 640 N/mm ² , 190 HB	24	0.096	0.130	0.160	0.190	0.275	0.325	0.440	0.550	0.650	
P1.1.5 Unalloyed steel, heat-treated, 0.45 % C, Rm 850 N/mm ² , 250 HB	21	0.096	0.130	0.160	0.190	0.275	0.325	0.440	0.550	0.650	
P1.1.6 Unalloyed steel, annealed, 0.75 % C, Rm 915 N/mm ² , 270 HB	20	0.096	0.130	0.160	0.190	0.275	0.325	0.440	0.550	0.650	
P1.1.7 Unalloyed steel, heat-treated, 0.75 % C, Rm 1020 N/mm ² , 300 HB	17	0.096	0.130	0.160	0.190	0.275	0.325	0.440	0.550	0.650	
P2.1.1 Low-alloy steel, annealed, Rm 610 N/mm ² , 180 HB	17	0.076	0.105	0.130	0.155	0.220	0.260	0.355	0.440	0.520	
P2.1.2 Low-alloy steel, heat-treated, Rm 930 N/mm ² , 275 HB	12	0.061	0.085	0.105	0.125	0.175	0.210	0.285	0.350	0.415	
P2.1.3 Low-alloy steel, heat-treated, Rm 1020 N/mm ² , 300 HB	10	0.061	0.085	0.105	0.125	0.175	0.210	0.285	0.350	0.415	
P2.1.4 Low-alloy steel, heat-treated, Rm 1190 N/mm ² , 350 HB	9	0.048	0.065	0.080	0.095	0.140	0.165	0.225	0.275	0.330	
P3.1.1 High-alloy steel and tool steel, annealed, Rm 680 N/mm ² , 200 HB	13	0.076	0.105	0.130	0.155	0.220	0.260	0.355	0.440	0.520	
P3.1.2 High-alloy steel and tool steel, hardened and tempered, Rm 1100 N/mm ² , 325 HB	10	0.061	0.085	0.105	0.125	0.175	0.210	0.285	0.350	0.415	
M1.1.1 Stainless steel, ferritic/martensitic, with machining additives	10	0.060	0.080	0.100	0.120	0.175	0.205	0.280	0.345	0.410	
M1.1.2 Stainless steel, ferritic/martensitic, annealed, Rm 680 N/mm ² , 200 HB	9	0.060	0.080	0.100	0.120	0.175	0.205	0.280	0.345	0.410	
M1.1.3 Stainless steel, ferritic/martensitic, heat-treated, Rm 810 N/mm ² , 240 HB	9	0.048	0.065	0.080	0.095	0.140	0.165	0.225	0.275	0.330	
M2.1.1 Stainless steel, austenitic, quenched, 180 HB	8	0.060	0.080	0.100	0.120	0.175	0.205	0.280	0.345	0.410	
M2.2.1 Duplex steel, high-strength stainless steels											
K1.1.1 Grey cast iron, pearlitic/ferritic, 180 HB	30	0.119	0.165	0.200	0.240	0.345	0.405	0.555	0.690	0.815	
K1.1.2 Grey cast iron, pearlitic/martensitic, 260 HB	24	0.119	0.165	0.200	0.240	0.345	0.405	0.555	0.690	0.815	
K1.2.1 Cast iron with spheroidal graphite, ferritic, 160 HB	26	0.119	0.165	0.200	0.240	0.345	0.405	0.555	0.690	0.815	
K1.2.2 Cast iron with spheroidal graphite, pearlitic, 250 HB	20	0.096	0.130	0.160	0.190	0.275	0.325	0.440	0.550	0.650	
K1.3.1 Malleable cast iron, ferritic, 130 HB	26	0.119	0.165	0.200	0.240	0.345	0.405	0.555	0.690	0.815	
K1.3.2 Malleable cast iron, pearlitic, 230 HB	20	0.096	0.130	0.160	0.190	0.275	0.325	0.440	0.550	0.650	
K2.1.1 Vermicular graphite cast iron (GJV)	25	0.096	0.130	0.160	0.190	0.275	0.325	0.440	0.550	0.650	
K2.2.1 Austenitic-ferritic spheroidal graphite cast iron (ADI)											
N1.1.1 Wrought aluminium alloys, non-hardened, 60 HB	60	0.153	0.210	0.260	0.305	0.440	0.520	0.705	0.880	1.045	
N1.1.2 Wrought aluminium alloys, hardened, 100 HB	60	0.153	0.210	0.260	0.305	0.440	0.520	0.705	0.880	1.045	
N2.1.1 Aluminium casting alloys, non-hardened, ≤ 12 % Si, 75 HB	50	0.119	0.165	0.200	0.240	0.345	0.405	0.555	0.690	0.815	
N2.1.2 Aluminium casting alloys, hardened, ≤ 12 % Si, 90 HB	40	0.096	0.130	0.160	0.190	0.275	0.325	0.440	0.550	0.650	
N2.1.3 Aluminium casting alloys, non-hardened, > 12 % Si, 130 HB	35	0.096	0.130	0.160	0.190	0.275	0.325	0.440	0.550	0.650	
N3.1.1 Copper and copper alloys: Free-machining alloy, Pb > 1 %	60	0.096	0.130	0.160	0.190	0.275	0.325	0.440	0.550	0.650	
N3.1.2 Copper and copper alloys: CuZn, CuSnZn	36	0.076	0.105	0.130	0.155	0.220	0.260	0.355	0.440	0.520	
N3.1.3 Copper and copper alloys: CuSn, lead-free copper and copper electrolyte	48	0.076	0.105	0.130	0.155	0.220	0.260	0.355	0.440	0.520	
N4.1.1 Non-metallic materials: Duroplastics, fibre-reinforced plastics	20	0.096	0.130	0.160	0.190	0.275	0.325	0.440	0.550	0.650	
N4.1.2 Non-metallic materials: Hard rubber, wood, etc.	20	0.096	0.130	0.160	0.190	0.275	0.325	0.440	0.550	0.650	
N4.1.3 Non-metallic materials: Graphite											
S1.1.1 Heat-resistant alloys, Fe-based, annealed, 200 HB	6	0.048	0.065	0.080	0.095	0.135	0.160	0.220	0.275	0.325	
S1.1.2 Heat-resistant alloys, Fe-based, hardened, 280 HB	5	0.038	0.050	0.065	0.075	0.110	0.130	0.175	0.220	0.260	
S1.1.3 Heat-resistant alloys, Ni- or Co-based, annealed, 250 HB	5	0.048	0.065	0.080	0.095	0.135	0.160	0.220	0.275	0.325	
S1.1.4 Heat-resistant alloys, Ni- or Co-based, hardened, 350 HB	3	0.038	0.050	0.065	0.075	0.110	0.130	0.175	0.220	0.260	
S1.1.5 Heat-resistant alloys, Ni- or Co-based, cast, 320 HB	4	0.038	0.050	0.065	0.075	0.110	0.130	0.175	0.220	0.260	
S2.1.1 Titanium alloys, pure titanium, Rm 400 N/mm ²	5	0.048	0.065	0.080	0.095	0.135	0.160	0.220	0.275	0.325	
S2.1.2 Titanium alloys, Alpha and Beta alloys, hardened, Rm 1050 N/mm ²	3	0.038	0.050	0.065	0.075	0.110	0.130	0.175	0.220	0.260	
H1.1.1 Hardened steel, hardened and tempered, < 55 HRC											
H1.1.2 Hardened steel, hardened and tempered, < 60 HRC											
H1.1.3 Hardened steel, hardened and tempered, > 60 HRC											
H2.1.1 Chilled cast iron, 400 HB											
H2.1.2 Chilled cast iron, hardened and tempered, < 55 HRC											



Taper pin drills



Machining group	HSS	f (mm/rev) with nom. Ø									
		1.5	3	4	6	8	10	16	20	25	
	v _c (m/min)										
P1.1.1 Unalloyed steel, annealed, 0.15 % C, Rm 420 N/mm ² , 125 HB	28	0.048	0.096	0.119	0.165	0.200	0.240	0.345	0.405	0.480	
P1.1.2 Unalloyed steel, heat-treated, 0.15 % C, Rm 420 N/mm ² , 125 HB	24	0.038	0.077	0.096	0.130	0.160	0.190	0.275	0.325	0.385	
P1.1.3 Unalloyed steel, annealed, 0.45 % C, Rm 640 N/mm ² , 190 HB	24	0.038	0.077	0.096	0.130	0.160	0.190	0.275	0.325	0.385	
P1.1.4 Unalloyed steel, heat-treated, 0.45 % C, Rm 640 N/mm ² , 190 HB	24	0.038	0.077	0.096	0.130	0.160	0.190	0.275	0.325	0.385	
P1.1.5 Unalloyed steel, heat-treated, 0.45 % C, Rm 850 N/mm ² , 250 HB	21	0.038	0.077	0.096	0.130	0.160	0.190	0.275	0.325	0.385	
P1.1.6 Unalloyed steel, annealed, 0.75 % C, Rm 915 N/mm ² , 270 HB	20	0.038	0.077	0.096	0.130	0.160	0.190	0.275	0.325	0.385	
P1.1.7 Unalloyed steel, heat-treated, 0.75 % C, Rm 1020 N/mm ² , 300 HB	17	0.038	0.077	0.096	0.130	0.160	0.190	0.275	0.325	0.385	
P2.1.1 Low-alloy steel, annealed, Rm 610 N/mm ² , 180 HB	17	0.031	0.061	0.076	0.105	0.130	0.155	0.220	0.260	0.310	
P2.1.2 Low-alloy steel, heat-treated, Rm 930 N/mm ² , 275 HB	12	0.025	0.049	0.061	0.085	0.105	0.125	0.175	0.210	0.245	
P2.1.3 Low-alloy steel, heat-treated, Rm 1020 N/mm ² , 300 HB	10	0.025	0.049	0.061	0.085	0.105	0.125	0.175	0.210	0.245	
P2.1.4 Low-alloy steel, heat-treated, Rm 1190 N/mm ² , 350 HB	9	0.019	0.039	0.048	0.065	0.080	0.095	0.140	0.165	0.195	
P3.1.1 High-alloy steel and tool steel, annealed, Rm 680 N/mm ² , 200 HB	13	0.031	0.061	0.076	0.105	0.130	0.155	0.220	0.260	0.310	
P3.1.2 High-alloy steel and tool steel, hardened and tempered, Rm 1100 N/mm ² , 325 HB											
M1.1.1 Stainless steel, ferritic/martensitic, with machining additives	10	0.024	0.048	0.060	0.080	0.100	0.120	0.175	0.205	0.240	
M1.1.2 Stainless steel, ferritic/martensitic, annealed, Rm 680 N/mm ² , 200 HB	9	0.024	0.048	0.060	0.080	0.100	0.120	0.175	0.205	0.240	
M1.1.3 Stainless steel, ferritic/martensitic, heat-treated, Rm 810 N/mm ² , 240 HB	9	0.019	0.039	0.048	0.065	0.080	0.095	0.140	0.165	0.195	
M2.1.1 Stainless steel, austenitic, quenched, 180 HB	8	0.024	0.048	0.060	0.080	0.100	0.120	0.175	0.205	0.240	
M2.2.1 Duplex steel, high-strength stainless steels											
K1.1.1 Grey cast iron, pearlitic/ferritic, 180 HB	30	0.048	0.096	0.119	0.165	0.200	0.240	0.345	0.405	0.480	
K1.1.2 Grey cast iron, pearlitic/martensitic, 260 HB	24	0.048	0.096	0.119	0.165	0.200	0.240	0.345	0.405	0.480	
K1.2.1 Cast iron with spheroidal graphite, ferritic, 160 HB	26	0.048	0.096	0.119	0.165	0.200	0.240	0.345	0.405	0.480	
K1.2.2 Cast iron with spheroidal graphite, pearlitic, 250 HB	20	0.038	0.077	0.096	0.130	0.160	0.190	0.275	0.325	0.385	
K1.3.1 Malleable cast iron, ferritic, 130 HB	26	0.048	0.096	0.119	0.165	0.200	0.240	0.345	0.405	0.480	
K1.3.2 Malleable cast iron, pearlitic, 230 HB	20	0.038	0.077	0.096	0.130	0.160	0.190	0.275	0.325	0.385	
K2.1.1 Vermicular graphite cast iron (GJV)	25	0.038	0.077	0.096	0.130	0.160	0.190	0.275	0.325	0.385	
K2.2.1 Austenitic-ferritic spheroidal graphite cast iron (ADI)											
N1.1.1 Wrought aluminium alloys, non-hardened, 60 HB											
N1.1.2 Wrought aluminium alloys, hardened, 100 HB											
N2.1.1 Aluminium casting alloys, non-hardened, ≤ 12 % Si, 75 HB	50	0.048	0.096	0.119	0.165	0.200	0.240	0.345	0.405	0.480	
N2.1.2 Aluminium casting alloys, hardened, ≤ 12 % Si, 90 HB	40	0.038	0.077	0.096	0.130	0.160	0.190	0.275	0.325	0.385	
N2.1.3 Aluminium casting alloys, non-hardened, > 12 % Si, 130 HB	35	0.038	0.077	0.096	0.130	0.160	0.190	0.275	0.325	0.385	
N3.1.1 Copper and copper alloys: Free-machining alloy, Pb > 1 %	60	0.038	0.077	0.096	0.130	0.160	0.190	0.275	0.325	0.385	
N3.1.2 Copper and copper alloys: CuZn, CuSnZn	36	0.031	0.061	0.076	0.105	0.130	0.155	0.220	0.260	0.310	
N3.1.3 Copper and copper alloys: CuSn, lead-free copper and copper electrolyte	48	0.031	0.061	0.076	0.105	0.130	0.155	0.220	0.260	0.310	
N4.1.1 Non-metallic materials: Duroplastics, fibre-reinforced plastics	20	0.038	0.077	0.096	0.130	0.160	0.190	0.275	0.325	0.385	
N4.1.2 Non-metallic materials: Hard rubber, wood, etc.	20	0.038	0.077	0.096	0.130	0.160	0.190	0.275	0.325	0.385	
N4.1.3 Non-metallic materials: Graphite											
S1.1.1 Heat-resistant alloys, Fe-based, annealed, 200 HB											
S1.1.2 Heat-resistant alloys, Fe-based, hardened, 280 HB											
S1.1.3 Heat-resistant alloys, Ni- or Co-based, annealed, 250 HB											
S1.1.4 Heat-resistant alloys, Ni- or Co-based, hardened, 350 HB											
S1.1.5 Heat-resistant alloys, Ni- or Co-based, cast, 320 HB											
S2.1.1 Titanium alloys, pure titanium, Rm 400 N/mm ²											
S2.1.2 Titanium alloys, Alpha and Beta alloys, hardened, Rm 1050 N/mm ²											
H1.1.1 Hardened steel, hardened and tempered, < 55 HRC											
H1.1.2 Hardened steel, hardened and tempered, < 60 HRC											
H1.1.3 Hardened steel, hardened and tempered, > 60 HRC											
H2.1.1 Chilled cast iron, 400 HB											
H2.1.2 Chilled cast iron, hardened and tempered, < 55 HRC											

GU 500

HIGH PERFORMANCE AND LONG TOOL LIFE

IN ALMOST ALL MATERIALS

With the GU 500 range, Gühring presents a comprehensive portfolio of high-performance HSS drilling tools that promise efficient machining and a long tool life in universal applications.

- Excellent self-centring for particularly dimensionally stable holes
- High performance and wear resistance thanks to powder metallurgical steel and multi-layer coating
- Low feed forces and torques thanks to precise drill point





Milling tools

From incredible metal removal rates to precision in the micro range

With milling cutters from Gühring,
the chips fly exactly the way
you want them to

GÜHRING

Page

509	Solid carbide milling cutters
559	Solid carbide milling cutters for aluminium and plastics
573	Diamond/PCD milling cutters
583	Solid carbide deburring milling cutters
588	Solid carbide hard milling and profile cutters
626	Modular milling cutters
629	Solid carbide universal milling cutters
646	HSS-E-PM end mills
651	HSS end mills



ALL-ROUNDER
High degree of material flexibility

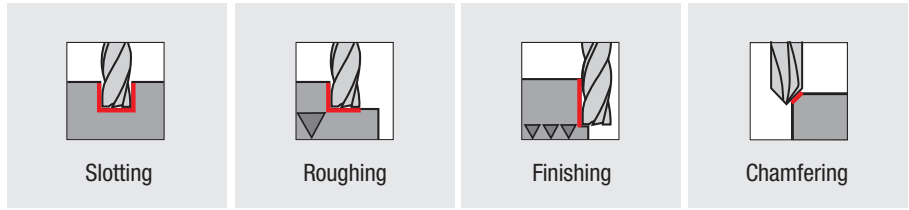

Milling tools

P Steel, high-alloy steel

RF 100 Diver e.g. # 6737 p. 520	RF 100 Sharp e.g. # 6478 p. 524	GH 100 U e.g. # 3689 p. 529	SpyroTec e.g. # 6992 p. 583

M Stainless steel

RF 100 Diver e.g. # 6737 p. 520	RF 100 Sharp e.g. # 6478 p. 524	GH 100 U e.g. # 3689 p. 529	SpyroTec e.g. # 6992 p. 583

K Grey cast iron, spheroidal graphite iron and malleable cast iron

RF 100 U e.g. # 3736 p. 520	RF 100 U e.g. # 3736 p. 520	GH 100 U e.g. # 3689 p. 529	Chamfering milling cutters e.g. # 6786 p. 583

N Aluminium, magnesium, non-ferrous metals

RF 100 Diver e.g. # 6737 p. 520	RF 100 Sharp e.g. # 6478 p. 524	GH 100 U e.g. # 3689 p. 529	SpyroTec e.g. # 6992 p. 583

S Special, super and titanium alloy

RF 100 Diver e.g. # 6737 p. 520	RF 100 Sharp e.g. # 6478 p. 524	GH 100 U e.g. # 3689 p. 529	SpyroTec e.g. # 6992 p. 583

H Chilled cast iron, hardened steel

RF 100 U e.g. # 3736 p. 529	Chamfering milling cutters e.g. # 6784 p. 584

O Non-metallic materials

Didn't find what you were looking for?

Enter very specific requirements into our online Gühring Navigator and you will receive precise tool recommendations – cutting values included.



SPECIALIST

Maximum tool life, minimum cycle time

Slotting	Roughing	Roughing Dynamic	Finishing	Copying full radius	Copying Torus
					
RF 100 U e.g. # 6706 p. 528	RF 100 U e.g. # 3736 p. 529	RF 100 Speed P e.g. # 6958 p. 550	RF 100 SF e.g. # 3631 p. 554	G-Mold 55 B e.g. # 6848 p. 598	G-Mold 55 T e.g. # 6854 p. 612
					
RF 100 VA e.g. # 3804 p. 540	RF 100 VA e.g. # 3800 p. 541	RF 100 Speed M e.g. # 6765 p. 548	RF 100 SF e.g. # 6727 p. 554	G-Mold 55 B e.g. # 6844 p. 596	G-Mold 55 T e.g. # 6854 p. 612
					
RF 100 U e.g. # 6881 p. 535	RF 100 U e.g. # 3736 p. 529	RF 100 Speed P e.g. # 6958 p. 550	RF 100 SF e.g. # 3631 p. 554	G-Mold 55 B e.g. # 6848 p. 598	G-Mold 55 T e.g. # 6854 p. 612
					
RF 100 A e.g. # 6978 p. 560	RF 100 A e.g. # 3472 p. 561	RF 100 A e.g. # 6730 p. 564	RF 100 A e.g. # 3202 p. 566	GA 200 A e.g. # 6984 p. 571	RF 100 A e.g. # 3599 p. 563
					
RF 100 U e.g. # 6728 p. 511	RF 100 Ti e.g. # 6966 p. 545	GH 100 U e.g. # 6969 p. 623	RF 100 SF e.g. # 6727 p. 554	G-Mold 55 B e.g. # 6844 p. 596	G-Mold 55 T e.g. # 6854 p. 612
					
G-Mold 65 U e.g. # 6943 p. 616	G-Mold 65 U e.g. # 6943 p. 616	G-Mold 65 F e.g. # 6945 p. 619	G-Mold μ 65 F e.g. # 6827 p. 618	G-Mold μ 65 B e.g. # 6815 p. 588	G-Mold μ 65 T e.g. # 6820 p. 602
					
FR 100 e.g. # 6769 p. 576	FR 100 e.g. # 6769 p. 576	PCD e.g. # 5492 p. 579	PCD e.g. # 5495 p. 580	Type N e.g. # 6724 p. 575	Type N e.g. # 6723 p. 574
					

Milling tools



Milling tools

P	M	K	N	S	H	Tool illustration	Z	Hardness	Cutting edge profile	Length	Helix angle °	Tool material	Surface	d1/mm	Article no.	Page
Standard Ratio end mills RF 100 U (3-fluted)																
•	•	•	•	•	•		3		45°		41° 43° 45°	VHM	F	3.000 - 16.000	3893	509
•	•	•	•	•	•		3		45°		41° 43° 45°	VHM	F	3.000 - 16.000	3894	509
•	•	•	•	•	•		3		45°		41° 43° 45°	VHM	F	3.000 - 20.000	3891	510
•	•	•	•	•	•		3		45°		41° 43° 45°	VHM	F	3.000 - 20.000	3892	510
•	•	•	•	•	•		3		45°		41° 43° 45°	VHM	R	3.000 - 20.000	6728	511
Slot drills GH 100 U (3-fluted)																
•	•	•	•	•	•		3		45°		45°	VHM	F	2.000 - 20.000	3540	512
•	•	•	•	•	•		3		45°		45°	VHM	F	3.000 - 20.000	3729	512
•	•	•	•	•	•		3		45°		45°	VHM	F	1.000 - 20.000	3636	513
•	•	•	•	•	•		3		45°		45°	VHM	F	3.000 - 20.000	3730	513
•	•	•	•	•	•		3		45°		45°	VHM	F	2.000 - 20.000	3741	514
Micro-precision milling cutter MicroMill μ 55 U																
•	•	•	•	•	•		3-4	55 HRC	45°		30°	VHM	X	0.200 - 3.000	6829	515
Ratio end mills RF 100 Micro Diver																
•	•	•	•	•	•		3	48 HRC	45°	2,5xD	40°	VHM	X	0.790 - 3.175	6808	516
•	•	•	•	•	•		3	48 HRC	45°	5xD	40°	VHM	X	1.000 - 3.175	6809	516
Ratio end mills RF 100 Diver (3-fluted)																
•	•	•	•	•	•		3		45°		41° 43° 45°	VHM	Y	3.000 - 20.000	6797	517
•	•	•	•	•	•		3		45°		41° 43° 45°	VHM	Y	3.000 - 20.000	6798	517
•	•	•	•	•	•		3		45°		41° 43° 45°	VHM	Y	6.000 - 16.000	6799	518
•	•	•	•	•	•		3		45°		41° 43° 45°	VHM	Y	6.000 - 16.000	6800	518
Ratio end mills RF 100 Diver																
•	•	•	•	•	•		4	48 HRC	45°		36° 38° 37°	VHM	Y	3.000 - 20.000	6803	519
•	•	•	•	•	•		4	48 HRC	45°		36° 38° 37°	VHM	Y	3.000 - 20.000	6804	519
•	•	•	•	•	•		4	48 HRC	45°		36° 38° 37°	VHM	Y	4.000 - 20.000	6737	520
•	•	•	•	•	•		4	48 HRC	45°		36° 38° 37°	VHM	Y	4.000 - 20.000	6736	520
•	•	•	•	•	•		4	48 HRC	45°		36° 38° 37°	VHM	Y	6.000 - 25.000	6801	521
•	•	•	•	•	•		4	48 HRC	45°		36° 38° 37°	VHM	Y	6.000 - 25.000	6802	521



P	M	K	N	S	H	Tool illustration	Z	Hardness	Cutting edge profile	Length	Helix angle °	Tool material	Surface	d1/mm	Article no.	Page
Ratio end mill sets RF 100 Diver																
•	•	•	•	•			4	48 HRC	45°		36° 38° 37°	VHM	Y		6755	522
•	•	•	•	•			4	48 HRC	45°		36° 38° 37°	VHM	Y		6754	522
Pilot end mills RF 100 P																
•	○	•	•	○	○		4	48 HRC	45°		30°	VHM	A	1.400 - 12.000	6716	523
Ratio end mills RF 100 Sharp																
•	•	•	•	•			4		45°		38° 40°	VHM	P	1.000 - 20.000	6478	524
•	•	•	•	•			4		45°		38° 40°	VHM	P	4.000 - 20.000	6479	524
•	•	•	•	•			4		45°		38° 40°	VHM	P	1.000 - 20.000	6480	525
•	•	•	•	•			4		45°		38° 40°	VHM	P	4.000 - 20.000	6481	525
•	•	•	•	•			4		R=0,05		38° 40°	VHM	P	3.000 - 20.000	6962	526
•	•	•	•	•			4		R=0,05		38° 40°	VHM	P	3.000 - 20.000	6963	526
Ratio end mills RF 100 iMill																
○	•	○	•				4		R=0,05		38° 40°	VHM	Y	3.000 - 20.000	6964	527
○	•	○	•				4		R=0,05		38° 40°	VHM	Y	3.000 - 20.000	6965	527
Standard Ratio end mills RF 100 U																
•	•	○					4	48 HRC	45°		35° 38°	VHM	F	3.000 - 20.000	6706	528
•	•	○					4	48 HRC	45°		35° 38°	VHM	F	3.000 - 20.000	3731	528
•	•	○					4	48 HRC	45°		35° 38°	VHM	F	3.000 - 25.000	3736	529
•	•	○					4	48 HRC	45°		35° 38°	VHM	F	3.000 - 25.000	3732	529
•	○	•	○				4	48 HRC	45°		35° 38°	VHM	R	6.000 - 20.000	6726	530
•	•	○					4	48 HRC	R=0,05		35° 38°	VHM	F	6.000 - 25.000	3872	531
•	•	○					4	48 HRC	R=0,05		35° 38°	VHM	F	6.000 - 25.000	3873	531
•	•	○					4	48 HRC	45°		35° 38°	VHM	F	6.000 - 20.000	3837	532
•	•	○					4	48 HRC	45°		35° 38°	VHM	F	6.000 - 20.000	3838	532
•	•	○					4	48 HRC	45°	3xD	35° 38°	VHM	F	6.000 - 20.000	3839	532
•	•	○					4	48 HRC	45°	3xD	35° 38°	VHM	F	6.000 - 20.000	3871	532
•	•	○					4	48 HRC	45°		35° 38°	VHM	F	10.000 - 25.000	3627	533
•	•	○					4	48 HRC	45°	4xD	38°	VHM	F	6.000 - 25.000	6767	533

Milling tools



P	M	K	N	S	H	Tool illustration	Z	Hardness	Cutting edge profile	Length	Helix angle °	Tool material	Surface	d1/mm	Article no.	Page
Standard Ratio end mills RF 100 U																
•	•	•	•	•	•		4	48 HRC	45°	4xD	38°	VHM	F	6.000 - 25.000	6768	533
Ratio roughing end mills RF 100 U																
•	•	•	•	•	•		4	48 HRC	45°		36°/38°	VHM	Y	6.000 - 20.000	6970	534
•	•	•	•	•	•		4	48 HRC	45°		36°/38°	VHM	Y	6.000 - 20.000	6971	534
•	•	•	•	•	•		4	48 HRC	45°		36°/38°	VHM	Y	6.000 - 20.000	6972	534
•	•	•	•	•	•		4	48 HRC	45°		36°/38°	VHM	Y	6.000 - 20.000	6973	534
•	•	•	•	•	•		4		45°		30°/32°	VHM	F	6.000 - 25.000	6881	535
•	•	•	•	•	•		4		45°		30°/32°	VHM	F	6.000 - 25.000	6882	535
•	•	•	•	•	•		4		45°	3xD	30°/32°	VHM	F	6.000 - 20.000	6883	535
•	•	•	•	•	•		4		45°	3xD	30°/32°	VHM	F	6.000 - 20.000	6884	535
•	•	•	•	•	•		4		45°		30°/32°	VHM	F	6.000 - 20.000	6885	536
•	•	•	•	•	•		4		45°		30°/32°	VHM	F	6.000 - 20.000	6886	536
High-performance roughing end mills RS 100 U																
•	•	•	•	•	•		4-5		45°		30°	VHM	F	6.000 - 25.000	6887	537
•	•	•	•	•	•		4-5		45°		30°	VHM	F	6.000 - 25.000	6888	537
High-performance roughing end mills RS 100 F																
•	•	•	•	•	•		5-6	48 HRC	45°		45°	VHM	F	6.000 - 25.000	6889	538
•	•	•	•	•	•		5-6	48 HRC	45°		45°	VHM	F	6.000 - 25.000	6890	538
Roughing end mills GS 100 U (fine teeth)																
•	•	•	•	•	•		4-5		45°		30°	VHM	F	6.000 - 25.000	3723	539
•	•	•	•	•	•		4		45°		30°	VHM	F	6.000 - 20.000	3365	539
Ratio end mills RF 100 VA																
•	•	•	•	•	•		4		45°		36°/38°	VHM	a	4.000 - 20.000	3804	540
•	•	•	•	•	•		4		45°		36°/38°	VHM	a	4.000 - 20.000	3805	540
•	•	•	•	•	•		4		45°		36°/38°	VHM	a	3.000 - 25.000	3800	541
•	•	•	•	•	•		4		45°		36°/38°	VHM	a	3.000 - 25.000	3803	541
•	•	•	•	•	•		4		45°		36°/38°	VHM	a	6.000 - 20.000	3806	542
•	•	•	•	•	•		4		45°		36°/38°	VHM	a	6.000 - 20.000	3807	542
•	•	•	•	•	•		4	48 HRC	R±0,05		36°/38°	VHM	a	4.000 - 25.000	6707	542
•	•	•	•	•	•		4	48 HRC	R±0,05		36°/38°	VHM	a	4.000 - 25.000	6708	542

Milling tools



P	M	K	N	S	H	Tool illustration	Z	Hardness	Cutting edge profile	Length	Helix angle °	Tool material	Surface	d1/mm	Article no.	Page
Ratio roughing end mills RF 100 VA																
•	•	•	○	○					45°			VHM	a	5.000 - 25.000	6877	543
•	•	•	○	○					45°			VHM	a	5.000 - 25.000	6878	543
•	•	•	○	○					45°			VHM	a	6.000 - 20.000	6879	543
•	•	•	○	○					45°			VHM	a	6.000 - 20.000	6880	543
Ratio end mills RF 100 Ti																
•	•	•	•	○				48 HRC	$R_{\pm 0,05}$			VHM	A	6.000 - 25.000	3498	544
•	•	•	•	○				48 HRC	$R_{\pm 0,05}$			VHM	A	6.000 - 25.000	3499	544
•	•	•	•	○				48 HRC	$R_{\pm 0,05}$			VHM	Z	6.000 - 25.000	6966	545
•	•	•	•	○				48 HRC	$R_{\pm 0,05}$			VHM	Z	6.000 - 25.000	6967	545
Ratio end mills RF 100 F																
•	•	•	○	•					45°			VHM	F	4.000 - 20.000	3629	546
•	•	•	○	•					45°			VHM	F	4.000 - 20.000	3630	546
•	•	•	○	•					45°			VHM	R	4.000 - 20.000	6968	546
•	•	•	○	•					45°			VHM	F	6.000 - 20.000	3366	547
•	•	•	○	•					90°			VHM	a	3.000 - 20.000	6764	547
Ratio end mills RF 100 Speed M																
•	•	•	•	•					45°			VHM	A	3.000 - 20.000	6765	548
•	•	•	•	•					45°			VHM	A	3.000 - 20.000	6760	548
•	•	•	•	•					45°			VHM	A	3.000 - 20.000	6766	548
•	•	•	•	•					45°			VHM	A	3.000 - 20.000	6761	548
Ratio end mill sets RF 100 Speed M																
•	•	•	•	•					45°			VHM	A		6778	549
•	•	•	•	•					45°			VHM	A		6780	549
Ratio end mills RF 100 Speed P																
•	•	•	•	○				48 HRC	45°			VHM	A	6.000 - 25.000	6958	550
•	•	•	•	○				48 HRC	45°			VHM	A	6.000 - 25.000	6959	550
•	•	•	•	○				48 HRC	45°			VHM	A	6.000 - 25.000	6960	550
•	•	•	•	○				48 HRC	45°			VHM	A	6.000 - 25.000	6961	550

Milling tools



Milling tools

P	M	K	N	S	H	Tool illustration	Z	Hardness	Cutting edge profile	Length	Helix angle °	Tool material	Surface	d1/mm	Article no.	Page
Ratio end mills RF 100 5 Speed																
●	●	●	○	●					45°		38°	VHM	A	6.000 - 20.000	6856	551
●	●	●	○	●					45°		38°	VHM	A	6.000 - 20.000	6857	551
●	●	●	○	●					45°		38°	VHM	A	6.000 - 20.000	6858	551
●	●	●	○	●					45°		38°	VHM	A	6.000 - 20.000	6859	551
●	●	●	○	●					R±0.05		38°	VHM	A	6.000 - 20.000	6860	552
●	●	●	○	●					R±0.05		38°	VHM	A	6.000 - 20.000	6861	552
Ratio end mills RF 100 7 Speed																
●	●	●	○	●					45°		32°	VHM	A	6.000 - 20.000	6864	553
●	●	●	○	●					45°		32°	VHM	A	6.000 - 20.000	6865	553
Ratio end mills Superfinish RF 100 SF																
●	●	●	○	●				48 HRC	45°		44° 45° 46°	VHM	R	8.000 - 20.000	6727	554
●	●	●	○	●				48 HRC	45°		44° 45° 46°	VHM	F	8.000 - 25.000	3631	554
●	●	●	○	●				48 HRC	45°		44° 45° 46°	VHM	F	8.000 - 25.000	3632	554
●	●	●	○	●				48 HRC	45°		45°	VHM	F	4.000 - 25.000	6709	555
●	●	●	○	●				48 HRC	45°		45°	VHM	F	4.000 - 25.000	6710	555
●	●	●	○	●				48 HRC	45°		45°	VHM	F	4.000 - 20.000	3897	555
●	●	●	○	●				48 HRC	45°		45°	VHM	F	4.000 - 20.000	3898	555
●	●	●	○	●				48 HRC	90°		45°	VHM	a	4.000 - 20.000	6763	556
Multi-tooth end mills GH 100 U																
●	●	●	○	●				48 HRC	45°		45°	VHM	F	3.000 - 25.000	3689	557
●	●	●	○	●				48 HRC	45°		45°	VHM	F	6.000 - 32.000	3047	557
●	●	●	○	●				48 HRC	45°		45°	VHM	F	6.000 - 25.000	3691	558
●	●	●	○	●				48 HRC	45°		45°	VHM	F	4.000 - 32.000	3693	558



P	M	K	N	S	H	O	Tool illustration	Z	Cutting edge profile	Length	Helix angle °	Tool material	Surface	d1/mm	Article no.	Page
			•			○		3	45°		39° 40° 41°	VHM	Cb	5.000 - 20.000	6980	559
			•			○		3	45°		39° 40° 41°	VHM	Cb	5.000 - 20.000	6981	559
			•			○		3	45°		39° 40° 41°	VHM	Cb	3.000 - 20.000	6978	560
			•			○		3	45°		39° 40° 41°	VHM	Cb	3.000 - 20.000	6979	560
			•					3	45°		39° 40° 41°	VHM	○	3.000 - 20.000	3472	561
			•					3	45°		39° 40° 41°	VHM	○	3.000 - 20.000	6702	561
			•			○		3	R±0,05		39° 40° 41°	VHM	Cb	6.000 - 20.000	6982	562
			•			○		3	R±0,05		39° 40° 41°	VHM	Cb	6.000 - 20.000	6983	562
			•					3	R±0,05		39° 40° 41°	VHM	○	6.000 - 25.000	3599	563
			•					3	R±0,05		39° 40° 41°	VHM	○	6.000 - 25.000	6729	563
			•					3	45°		39° 40° 41°	VHM	○	6.000 - 20.000	3473	564
			•					3	45°		39° 40° 41°	VHM	○	6.000 - 20.000	6703	564
			•					3	45°	3xD	39° 40° 41°	VHM	○	5.000 - 20.000	6730	564
			•					3	45°	3xD	39° 40° 41°	VHM	○	5.000 - 20.000	6731	564
			•					3	45°	4xD	39° 40° 41°	VHM	○	6.000 - 20.000	6732	565
			•					3	45°	4xD	39° 40° 41°	VHM	○	6.000 - 20.000	6733	565
			•					3	45°	5xD	39° 40° 41°	VHM	○	6.000 - 20.000	6734	565
			•					3	45°	5xD	39° 40° 41°	VHM	○	6.000 - 20.000	6735	565
	○		•		○			4	45°		40° 42°	VHM	○	4.000 - 20.000	3202	566
	○		•		○			4	45°		40° 42°	VHM	○	4.000 - 20.000	3319	566
			•					4	90°		40° 42°	VHM	○	3.000 - 20.000	6762	566

Milling tools

Ratio roughing end mills Alu RF 100 A																
			•			○		3	45°		30° 29° 31°	VHM	Cb	6.000 - 20.000	6974	567
			•			○		3	45°		30° 29° 31°	VHM	Cb	6.000 - 20.000	6975	567
			•			○		3	45°		30° 29° 31°	VHM	Cb	6.000 - 20.000	6976	568
			•			○		3	45°		30° 29° 31°	VHM	Cb	6.000 - 20.000	6977	568



Milling tools



P	M	K	N	S	H	O	Tool illustration	Z	Cutting edge profile	Length	Helix angle °	Tool material	Surface	d1/mm	Article no.	Page
Ratio roughing end mills Alu RF 100 A																
			•			○		3	45°	5xD	30° 29° 31°	VHM	Cb	10.000 - 25.000	6866	568
			•					3	45°		30° 29° 31°	VHM	○	6.000 - 25.000	6868	569
			•					3	45°		30° 29° 31°	VHM	○	6.000 - 25.000	6869	569
			•					3	45°		30° 29° 31°	VHM	○	6.000 - 20.000	6870	570
			•					3	45°		30° 29° 31°	VHM	○	6.000 - 20.000	6871	570
Ball nose end mills GA 200 A																
			•			○		2	R=0,02		35°	VHM	Cb	3.000 - 16.000	6984	571
End mills (single-fluted)																
			•					1	90°		30°	VHM	○	2.000 - 16.000	6793	571
Al slot drills (2-fluted)																
			•					2	45°		45°	VHM	○	3.000 - 20.000	3309	572
Al slot drills XL (2-fluted)																
			•					2	45°		45°	VHM	○	5.000 - 16.000	3358	572



P	M	K	N	S	H	O	Tool illustration	Z	Cutting edge profile	Length	Helix angle °	Tool material	Surface	d1/mm	Article no.	Page
Slot drills XL (3-fluted)								3	45°		30°	VHM	⊙	3.000 - 16.000	6721	573
Slot drills with corner radius (2-fluted)								2	R±0,05		30°	VHM	⊙	6.000 - 12.000	6722	574
End mills with corner radius (4-fluted)								4	R±0,05		30°	VHM	⊙	6.000 - 12.000	6723	574
Ball nose slot drills (2-fluted)								2	R±0,05		30°	VHM	⊙	3.000 - 12.000	6724	575
Ball nose end mills (4-fluted)								4	R±0,05		30°	VHM	⊙	3.000 - 12.000	6725	575
Kevlar end mills FR 100								4-8			0°	VHM	⊙	4.000 - 12.700	6769	576
							4-8			0°	VHM	○	4.000 - 12.700	6805	576	
							4-8			0°	VHM	⊙	4.000 - 12.700	6770	577	
							4-8			0°	VHM	○	4.000 - 12.700	6806	577	
Kevlar end mills CR 100								6+			0°	VHM	⊙	4.000 - 16.000	6720	578
							6+	45°		0°	VHM	⊙	4.000 - 16.000	6717	578	
							6+	45°		0°	VHM	⊙	4.000 - 16.000	6719	578	
PCD slot drills (2-fluted)								2	R±0,05		2-4°	PKD	○	4.000 - 20.000	5492	579
							2	R±0,05		2-4°	PKD	○	4.000 - 20.000	5493	579	
PCD slot drills (3-fluted)								3	R±0,05		4°	PKD	○	14.000 - 20.000	5495	580
							3	R±0,05		4°	PKD	○	14.000 - 20.000	5496	580	
HSC face milling cutters								6+	45°		4°	PKD	○	32.000 - 125.000	3016	581
							8-36			2-4°			63.000 - 250.000	4201	581	

Milling tools



P	M	K	N	S	H	O	Tool illustration	Z	Cutting edge profile	Length	Helix angle °	Tool material	Surface	d1/mm	Article no.	Page
PCD cartridges HSC																
												PKD	Ⓟ	30.000 - 30.300	4204	582
Coolant distributor																
													Ⓟ		4203	582

Milling tools



P	M	K	N	S	H	Tool illustration	Z	Hardness	Cutting edge profile	Length	Helix angle °	Tool material	Surface	d1/mm	Article no.	Page
90° Chamfering milling cutters SpyroTec																
•	•	○	•	•			5				20°-24°	VHM	A	6.000 - 20.000	6992	583
•	•	○	•	•			5				20°-24°	VHM	A	6.000 - 20.000	6993	583
90° Chamfering milling cutters																
•	•	•	○	○			6	55 HRC			7°	VHM	A	6.000 - 20.000	6786	583
•	•	•	○	○			6	55 HRC			7°	VHM	A	6.000 - 20.000	6787	583
•	•	•	•	○			4	55 HRC			7°	VHM	A	4.000 - 12.000	6713	584
•	•	•	•	○			4	55 HRC			7°	VHM	A	6.000 - 12.000	3396	584
•	•	•	•	•			4	65 HRC			7°	VHM	Y	4.000 - 12.000	6784	584
•	•	•	•	•			4	65 HRC			7°	VHM	Y	6.000 - 12.000	6785	584
60° Chamfering milling cutters SpyroTec																
•	•	○	•	•			5				13°-15°	VHM	A	6.000 - 20.000	6810	585
•	•	○	•	•			5				13°-15°	VHM	A	6.000 - 20.000	6811	585
60° Chamfering milling cutters																
•	•	•	•	○			4	55 HRC			7°	VHM	A	4.000 - 12.000	6711	585
•	•	•	•	○			4	55 HRC			7°	VHM	A	6.000 - 12.000	6712	585
120° Chamfering milling cutters SpyroTec																
•	•	○	•	•			5				20°-24°	VHM	A	6.000 - 20.000	6812	586
•	•	○	•	•			5				20°-24°	VHM	A	6.000 - 20.000	6813	586
120° Chamfering milling cutters																
•	•	•	•	○			4	55 HRC			7°	VHM	A	4.000 - 12.000	6714	586
•	•	•	•	○			4	55 HRC			7°	VHM	A	6.000 - 12.000	6715	586
90° Front/back deburrers																
•	•	○	•	•			4	55 HRC			0°	VHM	a	3.000 - 12.000	495	587
Quadrant milling cutters																
•	•	•	○	•			4	55 HRC			7°	VHM	F	6.000 - 20.000	6788	587

Milling tools



Milling tools

P	M	K	N	S	H	Tool illustration	Z	Hardness	Cutting edge profile	Length	Helix angle °	Tool material	Surface	d1/mm	Article no.	Page
Ball nose end mills G-Mold μ 65 B																
○	●	●	●	●	●		2	65 HRC			25°	VHM	⊗	0.200 - 12.000	6815	588
○	●	●	●	●	●		2	65 HRC			25°	VHM	⊗	0.200 - 12.000	6816	589
○	●	●	●	●	●		2	65 HRC			25°	VHM	⊗	0.200 - 12.000	6817	590
○	●	●	●	●	●		2	65 HRC			25°	VHM	⊗	0.200 - 12.000	6818	591
○	●	●	●	●	●		2	65 HRC			25°	VHM	⊗	0.200 - 8.000	6819	592
Ball nose end mills G-Mold 65 B																
○	●	●	●	●	●		2	65 HRC			30°	VHM	⊗	0.500 - 12.000	6832	593
○	●	●	●	●	●		2	65 HRC			30°	VHM	⊗	0.500 - 12.000	6833	593
○	●	●	●	●	●		2	65 HRC			30°	VHM	⊗	0.500 - 10.000	6834	594
○	●	●	●	●	●		4	65 HRC			30°	VHM	⊗	1.000 - 12.000	6835	594
○	●	●	●	●	●		4	65 HRC			30°	VHM	⊗	1.000 - 12.000	6836	595
Ball nose end mills G-Mold 55 B																
●	●	●	○	●	●		2	55 HRC			30°	VHM	⊗	0.500 - 12.000	6844	596
●	●	●	○	●	●		2	55 HRC			42°	VHM	⊗	0.500 - 12.000	6845	596
●	●	●	○	●	●		2	55 HRC			30°	VHM	⊗	0.500 - 10.000	6846	597
●	●	●	○	●	●		2	55 HRC			30°	VHM	⊗	0.500 - 8.000	6847	597
●	●	●	○	●	●		4	55 HRC			30°	VHM	⊗	1.000 - 12.000	6848	598
●	●	●	○	●	●		4	55 HRC			30°	VHM	⊗	1.000 - 12.000	6849	598
Ball nose slot drills (2-fluted)																
●	●	●	●	○	○		2	48 HRC			30°	VHM	⊗	0.500 - 20.000	3679	599
●	●	●	●	○	○		2	48 HRC			30°	VHM	⊗	2.000 - 20.000	3049	599
Ball nose end mills (4-fluted)																
●	○	●	○	●	○		4	48 HRC			30°	VHM	⊗	4.000 - 20.000	3727	600
●	○	●	○	●	○		4	48 HRC			30°	VHM	⊗	3.000 - 20.000	3050	600
Ball nose slot drills XL (2-fluted)																
●	●	●	●	○	○		2				30°	VHM	⊗	3.000 - 12.000	3030	601
●	●	○	○	●	○		4				30°	VHM	⊗	3.000 - 12.000	3043	601
Torus end mills G-Mold μ 65 T																
○	●	●	●	●	●		2-4	65 HRC			36°	VHM	⊗	0.300 - 12.000	6820	602
○	●	●	●	●	●		2-4	65 HRC			36°	VHM	⊗	0.300 - 12.000	6821	603
○	●	●	●	●	●		2-4	65 HRC			36°	VHM	⊗	0.300 - 12.000	6822	604
○	●	●	●	●	●		2-4	65 HRC			36°	VHM	⊗	0.300 - 12.000	6823	605



P	M	K	N	S	H	Tool illustration	Z	Hardness	Cutting edge profile	Length	Helix angle °	Tool material	Surface	d1/mm	Article no.	Page
Torus end mills G-Mold μ 65 T																
○	●	●	●	●	●		2-4	65 HRC	$R_{\pm 0,005}$		36°	VHM	⊗	0.300 - 8.000	6824	606
Torus end mills G-Mold 65 T																
○	●	●	●	●	●		4	65 HRC	$R_{\pm 0,01}$		30°	VHM	⊗	1.000 - 12.000	6837	607
○	●	●	●	●	●		4	65 HRC	$R_{\pm 0,01}$		30°	VHM	⊗	1.000 - 12.000	6838	608
Torus end mills G-Mold 55 T																
●	●	●	○	●	●		2	55 HRC	$R_{\pm 0,01}$		30°	VHM	⊗	0.500 - 12.000	6850	609
●	●	●	○	●	●		2	55 HRC	$R_{\pm 0,01}$		30°	VHM	⊗	0.500 - 12.000	6851	610
●	●	●	○	●	●		2	55 HRC	$R_{\pm 0,01}$		30°	VHM	⊗	1.000 - 10.000	6852	611
●	●	●	○	●	●		2	55 HRC	$R_{\pm 0,01}$		30°	VHM	⊗	1.000 - 8.000	6853	611
●	●	●	○	●	●		4	55 HRC	$R_{\pm 0,01}$		30°	VHM	⊗	1.000 - 12.000	6854	612
●	●	●	○	●	●		4	55 HRC	$R_{\pm 0,01}$		30°	VHM	⊗	1.000 - 12.000	6855	613
High-feed end mills G-Mold 65 HF																
●	●	●	●	●	●		4	65 HRC			30°	VHM	⊗	1.000 - 16.000	6830	614
●	●	●	●	●	●		4	65 HRC			30°	VHM	⊗	1.000 - 16.000	6814	614
●	●	●	●	●	●		4	65 HRC			30°	VHM	⊗	1.000 - 16.000	6831	615
Ratio end mills G-Mold 65 U																
○	●	●	●	●	●		4	65 HRC	45°		40°/42°	VHM	⊙	3.000 - 20.000	6943	616
○	●	●	●	●	●		4	65 HRC	45°		40°/42°	VHM	⊙	3.000 - 20.000	6944	616
Hard roughing end mills GS 100 H (fine teeth)																
●	●	●	●	●	●		4	55 HRC	45°		20°	VHM	⊙	6.000 - 20.000	3682	617
Finishing end mills G-Mold μ 65 F																
○	●	●	●	●	●		4-6	65 HRC	45°		42°	VHM	⊗	3.000 - 20.000	6827	618
○	●	●	●	●	●		4-6	65 HRC	45°	3xD	42°	VHM	⊗	3.000 - 20.000	6828	618
Finishing end mills G-Mold 65 F																
○	●	●	●	●	●		6	65 HRC	45°		42°	VHM	⊙	3.000 - 20.000	6945	619
○	●	●	●	●	●		6	65 HRC	45°		42°	VHM	⊙	3.000 - 20.000	6946	619
Finishing end mills with corner radius G-Mold 65 FR																
○	●	●	●	●	●		6	65 HRC	$R_{\pm 0,02}$		42°	VHM	⊙	3.000 - 16.000	6947	620
○	●	●	●	●	●		6	65 HRC	$R_{\pm 0,02}$		42°	VHM	⊙	3.000 - 16.000	6948	621
Finishing end mills G-Mold μ 48 F																
●	●	●	●	●	○		4-6	48 HRC	45°		40°	VHM	⊗	3.000 - 20.000	6825	622
●	●	●	●	●	○		4-6	48 HRC	45°	3xD	40°	VHM	⊗	3.000 - 20.000	6826	622

Milling tools



P	M	K	N	S	H	Tool illustration	Z	Hardness	Cutting edge profile	Length	Helix angle °	Tool material	Surface	d1/mm	Article no.	Page
Multi-tooth end mills with corner radius GH 100 U																
•	•	•	•	•	○		6+	55 HRC	R±0,02		45°	VHM	F	3.000 - 20.000	3563	623
•	•	•	•	•	○		6	55 HRC	R±0,02		45°	VHM	R	6.000 - 20.000	6969	623
End mills with corner radius (4-fluted)																
•	•	•	•	○	○		4	48 HRC	R±0,05		30°	VHM	F	1.000 - 20.000	3562	624
Slot drills with corner radius (2-fluted)																
•	•	•	•	○	○		2	48 HRC	R±0,05		30°	VHM	F	1.000 - 20.000	3561	625

Milling tools



P	M	K	N	S	H	Tool illustration	Z	Hard-ness	Cutting edge profile	Length	Helix angle °	Tool material	Sur-face	d1/mm	Article no.	Page
Die sinking cutter holders GF 200 WP																
•	•	•	○	•	•							Ni		10.000 - 32.000	1941	626
•	•	•	○	•	•							Ni		10.000 - 25.000	1942	626
Indexable inserts round																
•	•	•	○	•	•			55 HRC				Cermet	○	10.000 - 25.000	1947	627
•	•	•	○	•	•			55 HRC				VHM	Ⓡ	10.000 - 32.000	2520	627
Torx screwdrivers																
															1612	628
Clamping screws for die sinking cutter holders																
															1691	628

Milling tools



Milling tools

P	M	K	N	S	H	Tool illustration	Z	Hardness	Cutting edge profile	Length	Helix angle °	Tool material	Surface	d1/mm	Article no.	Page
Slot drills (2-fluted)																
•	•	•	•				2		45°		30°	VHM	F	2.000 - 20.000	3633	629
•	•	•	•				2		45°		30°	VHM	F	2.000 - 20.000	3634	629
•	•	•	•				2		45°		30°	VHM	F	1.000 - 20.000	3635	630
•	•	•	•				2		45°		30°	VHM	F	3.000 - 20.000	3154	630
•	•	•	•				2		45°		30°	VHM	F	2.000 - 20.000	3709	631
•	•	•	•				2		45°		30°	VHM	F	2.000 - 20.000	3676	632
Slot drills XL (2-fluted)																
•	•	•	•				2		45°		30°	VHM	F	3.000 - 20.000	3021	633
Mini slot drills (3-fluted)																
•	•	○	•	•			3		45°		30°	VHM	F	0.300 - 20.000	3684	634
•	•	○	•	○			3		45°		45°	VHM	F	1.000 - 10.000	3686	635
Slot drills (3-fluted)																
•	•	•	•				3		45°		30°	VHM	F	2.000 - 20.000	3558	636
•	•	•	•				3		45°		30°	VHM	F	2.000 - 20.000	3719	636
•	•	•	•				3		45°		30°	VHM	F	2.000 - 20.000	3560	637
•	•	•	•				3		45°		30°	VHM	F	2.000 - 20.000	3720	637
•	•	•	•				3		45°		30°	VHM	F	2.000 - 20.000	3677	638
•	•	•	•				3		45°		30°	VHM	F	2.000 - 20.000	3711	639
Slot drills XL (3-fluted)																
•	•	•	•				3		45°		30°	VHM	○	3.000 - 20.000	3314	640
•	•	•	•				3		45°		30°	VHM	F	3.000 - 20.000	3680	640
End mills (4-fluted)																
•	•	•	•				4		45°		30°	VHM	F	2.000 - 20.000	3637	641
•	•	•	•				4		45°		30°	VHM	F	2.000 - 20.000	3721	641
•	•	•	•				4		45°		30°	VHM	F	2.000 - 20.000	3649	642
•	•	•	•				4		45°		30°	VHM	F	2.000 - 20.000	3722	642
•	•	•	•				4		45°		30°	VHM	F	2.000 - 20.000	3678	643
•	•	•	•				4		45°		30°	VHM	F	4.500 - 20.000	3713	644
End mills XL (4-fluted)																
•	•	•	•				4		45°		30°	VHM	F	3.000 - 20.000	3023	645



P	M	K	N	S	H	Tool illustration	Z	Hardness	Cutting edge profile	Length	Helix angle °	Tool material	Surface	d1/mm	Article no.	Page
Ratio end mills RF 40																
•	•	•	•	•	○		4-6				35° 38°	HSS-E-PM	○	8.000 - 25.000	3429	646
•	•	•	•	•	○		4				35° 38°	HSS-E-PM	Ⓢ	8.000 - 25.000	3705	646
•	•	•	•	•	○		4-6				30° 32°	HSS-E-PM	○	16.000 - 30.000	3432	647
•	•	•	•	•	○		4-6				30° 32°	HSS-E-PM	Ⓢ	16.000 - 30.000	3706	647
Roughing end mills GS 40 (fine teeth)																
•	•	•	•	•	○		3				30°	HSS-E-PM	○	6.000 - 20.000	3322	648
•	•	•	•	•	○		3				30°	HSS-E-PM	Ⓢ	6.000 - 20.000	3668	648
•	•	•	•	•	○		4-6				30°	HSS-E-PM	○	6.000 - 32.000	3340	649
•	•	•	•	•	○		4-6				30°	HSS-E-PM	Ⓢ	6.000 - 32.000	3660	649
Roughing end mills GS 80 (fine teeth)																
•	•	•	•	•	○		3-6				45°	HSS-E-PM	Ⓢ	4.000 - 25.000	6756	650

Milling tools



Milling tools

P	M	K	N	S	H	Tool illustration	Z	Hardness	Cutting edge profile	Length	Helix angle °	Tool material	Surface	d1/mm	Article no.	Page
Slot drills (2-fluted)																
●	○	●	●	●								M42	○	1.000 - 25.000	3451	651
●	○	●	●	●								M42	Ⓡ	1.000 - 25.000	3663	651
●	○	●	●	●								M42	○	3.000 - 20.000	3452	652
●	○	●	●	●								M42	Ⓡ	3.000 - 20.000	3694	652
●	○	●	●	●								M42	○	3.000 - 20.000	3453	653
●	○	●	●	●								M42	Ⓡ	3.000 - 20.000	3695	653
Ball nose slot drills (2-fluted)																
●	○	●	●	●								M42	○	2.000 - 28.000	3466	654
●	●	●	●	●								M42	Ⓡ	2.000 - 25.000	3703	654
●	○	●	●	●								M42	○	3.000 - 24.000	3467	655
●	●	●	●	●								M42	Ⓡ	3.000 - 18.000	3704	655
Mini slot drills (3-fluted)																
●	●	●	●	●								M42	○	3.000 - 10.000	3142	656
●	●	●	●	●								M42	Ⓡ	3.000 - 10.000	3144	656
●	●	●	●	●								M42	○	3.000 - 10.000	3143	656
●	●	●	●	●								M42	Ⓡ	3.000 - 10.000	3145	656
Slot drills (3-fluted)																
●	○	●	●	●								M42	○	2.800 - 30.000	3458	657
●	○	●	●	●								M42	Ⓡ	2.800 - 30.000	3651	657
●	○	●	●	●								M42	○	2.800 - 20.000	3459	658
●	○	●	●	●								M42	Ⓡ	2.800 - 20.000	3664	658
●	○	●	●	●								M42	○	3.000 - 20.000	3460	659
●	○	●	●	●								M42	Ⓡ	3.000 - 20.000	3836	659
End mills																
●	○	●	●	●								M42	○	2.000 - 32.000	3428	660
●	○	●	●	●								M42	Ⓡ	2.000 - 32.000	3670	660
●	○	●	●	●								M42	○	3.000 - 40.000	3431	661
●	○	●	●	●								M42	Ⓡ	3.000 - 32.000	3692	661
●	○	●	●	●								M42	○	6.000 - 20.000	3433	662
Roughing end mills																
●	○	●	●	●								M42	○	6.000 - 40.000	3346	663
●	○	●	●	●								M42	Ⓡ	6.000 - 40.000	3690	663



P	M	K	N	S	H	Tool illustration	Z	Hardness	Cutting edge profile	Length	Helix angle °	Tool material	Surface	d1/mm	Article no.	Page
Roughing end mills																
●	○	●	●	●	●		4-6				30°	M42	○	6.000 - 36.000	3347	664
●	○	●	●	●	●		4-6				30°	M42	Ⓡ	6.000 - 36.000	3650	664
Roughing/finishing end mills																
●	○	●	●	●	●		6+				30°	M42	○	6.000 - 40.000	3343	665
●	○	●	●	●	●		6+				30°	M42	Ⓡ	6.000 - 32.000	3669	665
●	○	●	●	●	●		4-6				30°	M42	○	6.000 - 32.000	3342	666
●	○	●	●	●	●		4				30°	M42	Ⓡ	6.000 - 32.000	3698	666
Morse taper end mills																
●	○	●	●	●	●		4-8				30°	HSCO	○	10.000 - 50.000	3117	667
●	○	●	●	●	●		4-8	48 HRC			30°	HSCO	○	14.000 - 45.000	3440	668
●	○	●	●	●	●		4-8				30°	HSCO	○	16.000 - 50.000	3121	668
●	○	●	●	●	●		4-8				30°	HSCO	○	16.000 - 63.000	3120	669
Side and face cutters																
●	○	●	●	●	●						15°	HSCO	○	50.000 - 200.000	3530	670
Shell end mills																
●	○	●	●	●	●		6+				30°	M42	○	40.000 - 125.000	3504	671
●	○	●	●	●	●		6+				30°	M42	Ⓡ	40.000 - 80.000	3654	671
●	○	●	●	●	●		6+				30°	M42	○	40.000 - 125.000	3185	672
●	○	●	●	●	●		6+				30°	M42	Ⓡ	40.000 - 100.000	3749	672
●	○	●	●	●	●		6+				30°	M42	○	40.000 - 125.000	3187	672
T-slot end mills																
●	○	●	●	●	●		6+				10°	HSCO	○	12.500 - 32.000	3570	673
Woodruff cutters																
●	○	●	●	●	●		6+				8°	HSCO	○	4.500 - 45.500	3580	673
Dovetail cutters																
●	○	●	●	●	●		6+				0°	HSCO	○	16.000 - 32.000	3572	674

Milling tools



	P	M	K	N	S	H	Tool illustration	Z	Hardness	Cutting edge profile	Length	Helix angle °	Tool material	Surface	d1/mm	Article no.	Page	
Dovetail cutters																		
Milling tools	•	○	•	•								0°	HSCO	○	16.000 - 32.000	3576	674	
	•	○	•	•								0°	HSCO	○	16.000 - 32.000	3574	674	
	•	○	•	•								0°	HSCO	○	16.000 - 32.000	3577	674	
	•	○	•	•								0°	HSCO	○	16.000 - 32.000	3576	674	
Quadrant milling cutters																		
•	○	•	•									5°	HSCO	○	10.000 - 56.000	3176	675	



Standard Ratio end mills RF 100 U (3-fluted)

Article no. 3893



neck clearance • centre cutting

Cutting data page 682

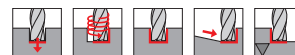
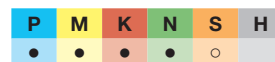

Standard Ratio end mills RF 100 U (3-fluted)

Article no. 3894



neck clearance • centre cutting

Cutting data page 682

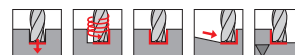

High-performance milling cutters

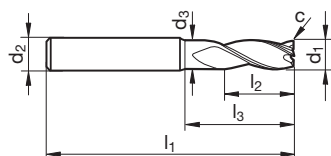

Article no.

3893

3894

d1 e8 mm	d2 h6 mm	d3 mm	l1 mm	l2 mm	l3 mm	c mm x 45°	Z	Order no.	
3.00	6.00	2.80	57	4.0	15.0	0.05	3	3893 3.000	3894 3.000
4.00	6.00	3.80	57	5.0	18.0	0.06	3	3893 4.000	3894 4.000
5.00	6.00	4.80	57	6.0	18.0	0.08	3	3893 5.000	3894 5.000
6.00	6.00	5.70	57	7.0	20.0	0.09	3	3893 6.000	3894 6.000
8.00	8.00	7.70	63	9.0	26.0	0.12	3	3893 8.000	3894 8.000
10.00	10.00	9.50	72	11.0	30.0	0.15	3	3893 10.000	3894 10.000
12.00	12.00	11.50	83	12.0	36.0	0.18	3	3893 12.000	3894 12.000
16.00	16.00	15.50	92	16.0	42.0	0.19	3	3893 16.000	3894 16.000



High-performance milling cutters

Standard Ratio end mills RF 100 U (3-fluted)

Article no. **3891**



neck clearance • centre cutting

Cutting data page 682

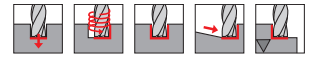

Standard Ratio end mills RF 100 U (3-fluted)

Article no. **3892**



neck clearance • centre cutting

Cutting data page 682

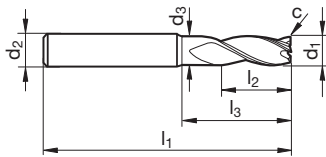
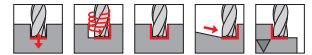
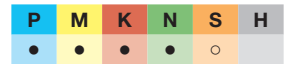

Article no.

3891

3892

d1 e8 mm	d2 h6 mm	d3 mm	l1 mm	l2 mm	l3 mm	c mm x 45°	Z	Order no.	
3.00	6.00	2.80	57	8.0	15.0	0.05	3	3891 3.000	3892 3.000
3.50	6.00	3.30	57	10.0	15.0	0.05	3	3891 3.500	3892 3.500
3.70	6.00	3.50	57	11.0	15.0	0.06	3	3891 3.700	3892 3.700
4.00	6.00	3.80	57	11.0	18.0	0.06	3	3891 4.000	3892 4.000
4.50	6.00	4.30	57	11.0	18.0	0.07	3	3891 4.500	3892 4.500
4.70	6.00	4.50	57	13.0	18.0	0.07	3	3891 4.700	3892 4.700
5.00	6.00	4.80	57	13.0	18.0	0.08	3	3891 5.000	3892 5.000
5.50	6.00	5.30	57	13.0	19.4	0.08	3	3891 5.500	3892 5.500
5.70	6.00	5.50	57	13.0	19.6	0.09	3	3891 5.700	3892 5.700
6.00	6.00	5.70	57	13.0	20.0	0.09	3	3891 6.000	3892 6.000
6.50	8.00	6.20	63	16.0	24.4	0.10	3	3891 6.500	3892 6.500
7.00	8.00	6.70	63	16.0	24.9	0.11	3	3891 7.000	3892 7.000
7.50	8.00	7.20	63	19.0	25.3	0.11	3	3891 7.500	3892 7.500
8.00	8.00	7.70	63	19.0	26.0	0.12	3	3891 8.000	3892 8.000
8.50	10.00	8.20	72	19.0	29.4	0.13	3	3891 8.500	3892 8.500
9.00	10.00	8.70	72	19.0	29.9	0.14	3	3891 9.000	3892 9.000
9.50	10.00	9.20	72	22.0	30.3	0.14	3	3891 9.500	3892 9.500
10.00	10.00	9.50	72	22.0	30.0	0.15	3	3891 10.000	3892 10.000
12.00	12.00	11.50	83	26.0	36.0	0.18	3	3891 12.000	3892 12.000
16.00	16.00	15.50	92	32.0	42.0	0.19	3	3891 16.000	3892 16.000
20.00	20.00	19.50	104	38.0	52.0	0.24	3	3891 20.000	3892 20.000



Standard Ratio end mills RF 100 U (3-fluted)

Article no. 6728



Cutting data page 682



neck clearance • centre cutting

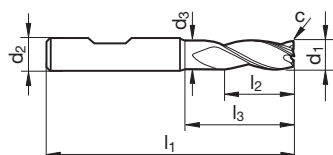
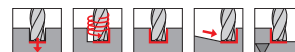
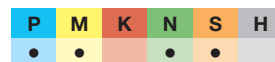

Article no. 6728

d1 e8 mm	d2 h6 mm	d3 mm	l1 mm	l2 mm	l3 mm	c mm x 45°	Z	Order no.
3.00	6.00	2.80	57	8.0	15.0	0.05	3	6728 3.000
4.00	6.00	3.80	57	11.0	18.0	0.06	3	6728 4.000
6.00	6.00	5.70	57	13.0	20.0	0.09	3	6728 6.000
8.00	8.00	7.70	63	19.0	26.0	0.12	3	6728 8.000
10.00	10.00	9.50	72	22.0	30.0	0.15	3	6728 10.000
12.00	12.00	11.50	83	26.0	36.0	0.18	3	6728 12.000
16.00	16.00	15.50	92	32.0	42.0	0.19	3	6728 16.000
20.00	20.00	19.50	104	38.0	52.0	0.24	3	6728 20.000

High-performance milling cutters



Slot drills GH 100 U (3-fluted)

Article no. **3540**



centre cutting

Cutting data page 686

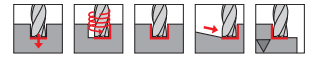

Slot drills GH 100 U (3-fluted)

Article no. **3729**



centre cutting

Cutting data page 686

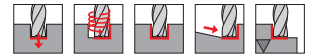

High-performance milling cutters

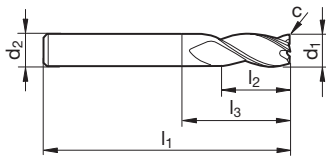

Article no.

3540

3729

d1 h10 mm	d2 h6 mm	l1 mm	l2 mm	l3 mm	c mm x 45°	Z	Order no.
2.00	6.00	50	3.0	5.9	0.03	3	3540 2.000
2.50	6.00	50	3.0	5.9	0.04	3	3540 2.500
3.00	6.00	50	4.0	7.9	0.05	3	3540 3.000 3729 3.000
4.00	6.00	54	5.0	8.9	0.06	3	3540 4.000 3729 4.000
5.00	6.00	54	6.0	11.4	0.08	3	3540 5.000 3729 5.000
6.00	6.00	54	7.0	18.0	0.09	3	3540 6.000 3729 6.000
7.00	8.00	58	8.0	16.4	0.11	3	3540 7.000 3729 7.000
8.00	8.00	58	9.0	22.0	0.12	3	3540 8.000 3729 8.000
9.00	10.00	66	10.0	19.4	0.14	3	3540 9.000 3729 9.000
10.00	10.00	66	11.0	26.0	0.15	3	3540 10.000 3729 10.000
12.00	12.00	73	12.0	28.0	0.18	3	3540 12.000 3729 12.000
14.00	14.00	75	14.0	30.0	0.21	3	3540 14.000 3729 14.000
16.00	16.00	82	16.0	34.0	0.19	3	3540 16.000 3729 16.000
18.00	18.00	84	18.0	36.0	0.22	3	3540 18.000 3729 18.000
20.00	20.00	92	20.0	42.0	0.24	3	3540 20.000 3729 20.000



Slot drills GH 100 U (3-fluted)

Article no. 3636



centre cutting

Cutting data page 686

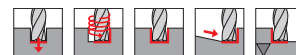
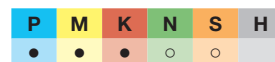

Slot drills GH 100 U (3-fluted)

Article no. 3730



centre cutting

Cutting data page 686

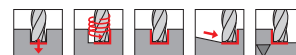

High-performance milling cutters

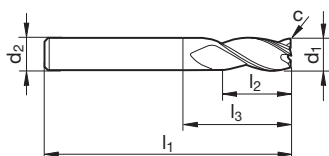

Article no. **3636** **3730**

d1 h10 mm	d2 h6 mm	l1 mm	l2 mm	l3 mm	c mm x 45°	Z	Order no.
1.00	3.00	38	2.0	3.4	0.02	3	3636 1.000
1.50	3.00	38	3.0	5.9	0.02	3	3636 1.500
2.00	6.00	57	6.0	8.9	0.03	3	3636 2.000
2.50	6.00	57	7.0	9.9	0.04	3	3636 2.500
3.00	6.00	57	7.0	10.9	0.05	3	3636 3.000 3730 3.000
3.50	6.00	57	7.0	10.9	0.05	3	3636 3.500 3730 3.500
4.00	6.00	57	8.0	11.9	0.06	3	3636 4.000 3730 4.000
4.50	6.00	57	8.0	13.4	0.07	3	3636 4.500 3730 4.500
5.00	6.00	57	10.0	15.4	0.08	3	3636 5.000 3730 5.000
6.00	6.00	57	10.0	21.0	0.09	3	3636 6.000 3730 6.000
7.00	8.00	63	13.0	21.4	0.11	3	3636 7.000 3730 7.000
8.00	8.00	63	16.0	27.0	0.12	3	3636 8.000 3730 8.000
9.00	10.00	72	16.0	25.4	0.14	3	3636 9.000 3730 9.000
10.00	10.00	72	19.0	32.0	0.15	3	3636 10.000 3730 10.000
12.00	12.00	83	22.0	38.0	0.18	3	3636 12.000 3730 12.000
14.00	14.00	83	22.0	38.0	0.21	3	3636 14.000 3730 14.000
14.00	16.00	92	26.0	37.4	0.21	3	3636 14.001
16.00	16.00	92	26.0	44.0	0.19	3	3636 16.000 3730 16.000
18.00	18.00	92	26.0	44.0	0.22	3	3636 18.000 3730 18.000
18.00	20.00	104	32.0	46.0	0.22	3	3636 18.001
20.00	20.00	104	32.0	54.0	0.24	3	3636 20.000 3730 20.000



Slot drills GH 100 U (3-fluted)

Article no. **3741**



Cutting data page 686



centre cutting

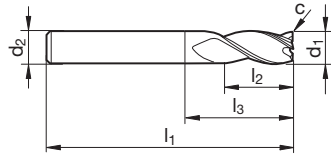
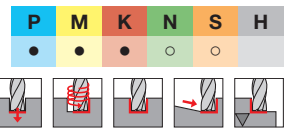

High-performance milling cutters

Article no. **3741**

d1 h10 mm	d2 h6 mm	l1 mm	l2 mm	l3 mm	c mm x 45°	Z	Order no.
2.00	2.00	32	6.0	8.0	0.03	3	3741 2.000
2.50	2.50	32	7.0	9.0	0.04	3	3741 2.500
3.00	3.00	38	7.0	10.0	0.05	3	3741 3.000
3.50	3.50	50	7.0	22.0	0.05	3	3741 3.500
4.00	4.00	50	8.0	22.0	0.06	3	3741 4.000
4.50	4.50	50	8.0	22.0	0.07	3	3741 4.500
5.00	5.00	50	10.0	22.0	0.08	3	3741 5.000
5.50	5.50	57	10.0	21.0	0.08	3	3741 5.500
6.00	6.00	57	10.0	21.0	0.09	3	3741 6.000
6.50	6.50	60	13.0	24.0	0.10	3	3741 6.500
7.00	7.00	60	13.0	24.0	0.11	3	3741 7.000
7.50	7.50	63	16.0	27.0	0.11	3	3741 7.500
8.00	8.00	63	16.0	27.0	0.12	3	3741 8.000
8.50	8.50	67	16.0	27.0	0.13	3	3741 8.500
9.00	9.00	67	16.0	27.0	0.14	3	3741 9.000
9.50	9.50	72	19.0	32.0	0.14	3	3741 9.500
10.00	10.00	72	19.0	32.0	0.15	3	3741 10.000
11.00	11.00	83	22.0	38.0	0.17	3	3741 11.000
12.00	12.00	83	22.0	38.0	0.18	3	3741 12.000
13.00	13.00	83	22.0	38.0	0.20	3	3741 13.000
14.00	14.00	83	22.0	38.0	0.21	3	3741 14.000
15.00	15.00	92	26.0	44.0	0.23	3	3741 15.000
16.00	16.00	92	26.0	44.0	0.19	3	3741 16.000
18.00	18.00	92	26.0	44.0	0.22	3	3741 18.000
20.00	20.00	104	32.0	54.0	0.24	3	3741 20.000



Micro-precision milling cutter MicroMill μ 55 U

Article no. 6829



Cutting data page 686



high-precision micro-precision milling cutters with 3 different ranges l3 • with internal cooling: GühroJet peripheral cooling with 6 or 4 exits • neck clearance • centre cutting

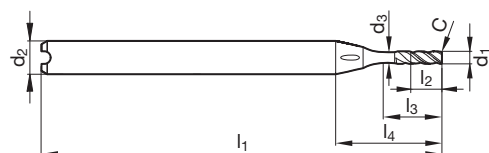
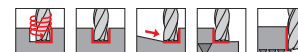

Article no. 6829

d1 -0,008 mm	d2 h5 mm	d3 mm	l1 mm	l2 mm	l3 mm	l4 mm	c mm x 45°	Z	Order no.
0.20	4.00	0.18	45	0.20	0.40	9.1	0.006	3	6829 0.201
0.20	4.00	0.18	45	0.20	0.75	9.5	0.006	3	6829 0.202
0.20	4.00	0.18	45	0.20	1.00	9.7	0.006	3	6829 0.203
0.25	4.00	0.23	45	0.25	0.50	9.0	0.007	3	6829 0.251
0.25	4.00	0.23	45	0.25	0.90	9.4	0.007	3	6829 0.252
0.25	4.00	0.23	45	0.25	1.25	9.7	0.007	3	6829 0.253
0.30	4.00	0.28	45	0.30	0.60	9.0	0.009	3	6829 0.301
0.30	4.00	0.28	45	0.30	1.10	9.5	0.009	3	6829 0.302
0.30	4.00	0.28	45	0.30	1.50	9.9	0.009	3	6829 0.303
0.40	4.00	0.38	45	0.40	0.80	8.9	0.012	4	6829 0.401
0.40	4.00	0.38	45	0.40	1.40	9.5	0.012	4	6829 0.402
0.40	4.00	0.38	45	0.40	2.00	10.1	0.012	4	6829 0.403
0.50	4.00	0.45	45	0.50	1.00	9.0	0.010	4	6829 0.501
0.50	4.00	0.45	45	0.50	1.80	9.8	0.010	4	6829 0.502
0.50	4.00	0.45	45	0.50	2.50	10.5	0.010	4	6829 0.503
0.60	4.00	0.55	45	0.60	1.20	8.9	0.012	4	6829 0.601
0.60	4.00	0.55	45	0.60	2.10	9.8	0.012	4	6829 0.602
0.60	4.00	0.55	45	0.60	3.00	10.7	0.012	4	6829 0.603
0.80	4.00	0.75	45	0.80	1.60	8.7	0.016	4	6829 0.801
0.80	4.00	0.75	45	0.80	2.80	9.9	0.016	4	6829 0.802
0.80	4.00	0.75	45	0.80	4.00	11.1	0.016	4	6829 0.803
1.00	4.00	0.92	45	1.00	2.00	8.7	0.020	4	6829 1.001
1.00	4.00	0.92	45	1.00	3.50	10.2	0.020	4	6829 1.002
1.00	4.00	0.92	45	1.00	5.00	11.7	0.020	4	6829 1.003
1.20	4.00	1.12	50	1.20	2.40	8.7	0.012	4	6829 1.201
1.20	4.00	1.12	50	1.20	4.20	10.5	0.012	4	6829 1.202
1.20	4.00	1.12	50	1.20	6.00	12.3	0.012	4	6829 1.203
1.50	4.00	1.40	50	1.50	3.00	8.6	0.015	4	6829 1.501
1.50	4.00	1.40	50	1.50	5.50	11.1	0.015	4	6829 1.502
1.50	4.00	1.40	50	1.50	7.50	13.1	0.015	4	6829 1.503
1.80	4.00	1.70	50	1.80	3.60	8.5	0.018	4	6829 1.801
1.80	4.00	1.70	50	1.80	6.50	11.4	0.018	4	6829 1.802
1.80	4.00	1.70	50	1.80	9.00	13.9	0.018	4	6829 1.803
2.00	6.00	1.85	50	2.00	4.00	13.2	0.020	4	6829 2.001
2.00	6.00	1.85	57	2.00	7.50	16.7	0.020	4	6829 2.002
2.00	6.00	1.85	57	2.00	10.00	19.2	0.020	4	6829 2.003
2.20	6.00	2.05	50	2.20	4.40	13.2	0.022	4	6829 2.201
2.20	6.00	2.05	57	2.20	8.00	16.8	0.022	4	6829 2.202
2.20	6.00	2.05	57	2.20	11.00	19.8	0.022	4	6829 2.203
2.50	6.00	2.35	50	2.50	5.00	13.1	0.025	4	6829 2.501
2.50	6.00	2.35	57	2.50	9.00	17.1	0.025	4	6829 2.502
2.50	6.00	2.35	57	2.50	12.50	20.6	0.025	4	6829 2.503
3.00	6.00	2.85	50	3.00	6.00	12.9	0.030	4	6829 3.001
3.00	6.00	2.85	57	3.00	11.00	17.9	0.030	4	6829 3.002
3.00	6.00	2.85	57	3.00	15.00	21.9	0.030	4	6829 3.003

High-performance milling cutters



Ratio end mills RF 100 Micro Diver

Article no. **6808**



Cutting data page 692



for extreme cutting values and cutting performance • with internal cooling: GühroJet peripheral cooling with 6 or 4 exits • centre cutting • with special drill face

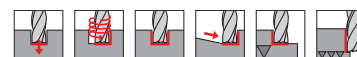
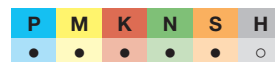

High-performance milling cutters



Article no. **6808**

d1 h8 mm	d2 h5 mm	l1 mm	l2 mm	l4 mm	c mm x 45°	Z	Order no.
0.79	4.00	38	1.9	9.3	0.016	3	6808 0.790
0.80	4.00	38	2.0	9.3	0.016	3	6808 0.800
1.00	4.00	38	2.5	9.3	0.020	3	6808 1.000
1.19	4.00	38	2.9	9.4	0.024	3	6808 1.190
1.20	4.00	38	3.0	9.4	0.024	3	6808 1.200
1.50	4.00	45	3.7	9.8	0.030	3	6808 1.500
1.59	4.00	44	3.9	9.9	0.032	3	6808 1.590
1.80	4.00	45	4.5	10.3	0.036	3	6808 1.800
1.98	6.00	50	4.9	14.7	0.040	3	6808 1.980
2.00	6.00	50	5.0	14.7	0.040	3	6808 2.000
2.20	6.00	50	5.5	14.9	0.044	3	6808 2.200
2.38	6.00	50	5.9	15.2	0.048	3	6808 2.380
2.50	6.00	50	6.2	15.3	0.050	3	6808 2.500
2.78	6.00	50	6.9	15.9	0.056	3	6808 2.780
2.80	6.00	50	7.0	15.9	0.056	3	6808 2.800
3.00	6.00	50	7.5	16.2	0.060	3	6808 3.000
3.17	6.00	50	7.9	16.6	0.064	3	6808 3.175

Ratio end mills RF 100 Micro Diver

Article no. **6809**



Cutting data page 694



for extreme cutting values and cutting performance • with internal cooling: GühroJet peripheral cooling with 6 or 4 exits • centre cutting • with special drill face

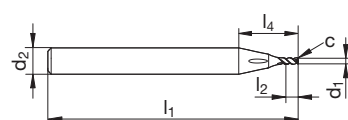
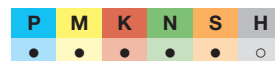

Article no. **6809**

d1 h8 mm	d2 h5 mm	l1 mm	l2 mm	l4 mm	c mm x 45°	Z	Order no.
1.00	4.00	45	5.0	11.8	0.020	3	6809 1.000
1.19	4.00	50	5.9	12.4	0.024	3	6809 1.190
1.50	4.00	50	7.5	13.5	0.030	3	6809 1.500
1.59	4.00	50	7.9	13.9	0.032	3	6809 1.590
1.98	6.00	57	9.9	19.6	0.040	3	6809 1.980
2.00	6.00	57	10.0	19.7	0.040	3	6809 2.000
2.38	6.00	57	11.9	21.1	0.048	3	6809 2.380
2.50	6.00	57	12.5	21.6	0.050	3	6809 2.500
2.78	6.00	57	13.9	22.8	0.056	3	6809 2.780
3.00	6.00	57	15.0	23.7	0.060	3	6809 3.000
3.17	6.00	57	15.8	24.6	0.064	3	6809 3.175



Ratio end mills RF 100 Diver (3-fluted)

Article no. 6797



neck clearance • centre cutting • with special drill face

Cutting data page 676

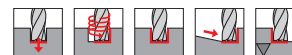

Ratio end mills RF 100 Diver (3-fluted)

Article no. 6798



neck clearance • centre cutting • with special drill face

Cutting data page 676

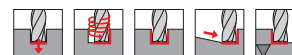

High-performance milling cutters

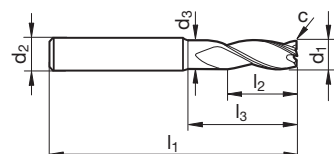

Article no.

6797

6798

d1 h10 mm	d2 h6 mm	d3 mm	l1 mm	l2 mm	l3 mm	c mm x 45°	Z	Order no.	
3.00	6.00	2.80	57	8.0	15.0	0.05	3	6797 3.000	6798 3.000
3.50	6.00	3.30	57	10.0	15.0	0.05	3	6797 3.500	6798 3.500
3.70	6.00	3.50	57	11.0	15.0	0.06	3	6797 3.700	6798 3.700
4.00	6.00	3.80	57	11.0	18.0	0.06	3	6797 4.000	6798 4.000
4.50	6.00	4.30	57	11.0	18.0	0.07	3	6797 4.500	6798 4.500
4.70	6.00	4.50	57	13.0	18.0	0.07	3	6797 4.700	6798 4.700
5.00	6.00	4.80	57	13.0	18.0	0.08	3	6797 5.000	6798 5.000
5.50	6.00	5.30	57	13.0	19.4	0.08	3	6797 5.500	6798 5.500
5.70	6.00	5.50	57	13.0	19.6	0.09	3	6797 5.700	6798 5.700
6.00	6.00	5.70	57	13.0	20.0	0.09	3	6797 6.000	6798 6.000
6.50	8.00	6.20	63	16.0	24.4	0.10	3	6797 6.500	6798 6.500
7.00	8.00	6.70	63	16.0	24.9	0.11	3	6797 7.000	6798 7.000
7.50	8.00	7.20	63	19.0	25.3	0.11	3	6797 7.500	6798 7.500
8.00	8.00	7.70	63	19.0	26.0	0.12	3	6797 8.000	6798 8.000
8.50	10.00	8.20	72	19.0	29.4	0.13	3	6797 8.500	6798 8.500
9.00	10.00	8.70	72	19.0	29.9	0.14	3	6797 9.000	6798 9.000
9.50	10.00	9.20	72	22.0	30.3	0.14	3	6797 9.500	6798 9.500
10.00	10.00	9.50	72	22.0	30.0	0.15	3	6797 10.000	6798 10.000
12.00	12.00	11.50	83	26.0	36.0	0.18	3	6797 12.000	6798 12.000
16.00	16.00	15.50	92	32.0	42.0	0.19	3	6797 16.000	6798 16.000
20.00	20.00	19.50	104	38.0	52.0	0.24	3	6797 20.000	6798 20.000



High-performance milling cutters

Ratio end mills RF 100 Diver (3-fluted)

Article no. **6799**



with internal cooling: radial and axial exits • neck clearance • centre cutting • with special drill face

Cutting data page 676

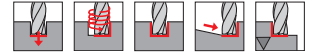

Ratio end mills RF 100 Diver (3-fluted)

Article no. **6800**



with internal cooling: radial and axial exits • neck clearance • centre cutting • with special drill face

Cutting data page 676

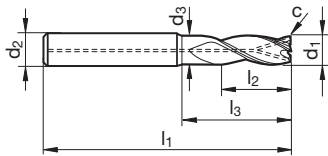

Article no.

6799

6800

d1 h10 mm	d2 h6 mm	d3 mm	l1 mm	l2 mm	l3 mm	c mm x 45°	Z
6.00	6.00	5.70	57	13.0	20.0	0.09	3
8.00	8.00	7.70	63	19.0	26.0	0.12	3
10.00	10.00	9.50	72	22.0	30.0	0.15	3
12.00	12.00	11.50	83	26.0	36.0	0.18	3
16.00	16.00	15.50	92	32.0	42.0	0.19	3

Order no.	
6799 6.000	6800 6.000
6799 8.000	6800 8.000
6799 10.000	6800 10.000
6799 12.000	6800 12.000
6799 16.000	6800 16.000



Ratio end mills RF 100 Diver

Article no. 6803



Cutting data page 676



neck clearance • centre cutting

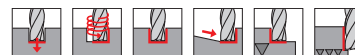
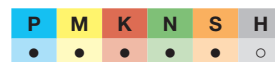

Ratio end mills RF 100 Diver

Article no. 6804



Cutting data page 676



neck clearance • centre cutting



High-performance milling cutters

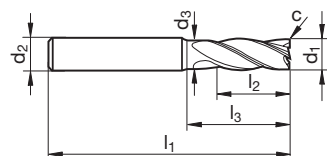

Article no. **6803** **6804**

d1 h10 mm	d2 h6 mm	d3 mm	l1 mm	l2 mm	l3 mm	c mm x 45°	Z	Order no.
3.00	6.00	2.80	50	5.0	12.0	0.03	4	6803 3.000 6804 3.000
3.70	6.00	3.50	54	8.0	12.0	0.04	4	6803 3.700 6804 3.700
4.00	6.00	3.80	54	8.0	15.0	0.04	4	6803 4.000 6804 4.000
4.70	6.00	4.50	54	9.0	15.0	0.05	4	6803 4.700 6804 4.700
5.00	6.00	4.80	54	9.0	15.0	0.05	4	6803 5.000 6804 5.000
5.70	6.00	5.50	54	10.0	16.6	0.06	4	6803 5.700 6804 5.700
6.00	6.00	5.70	54	10.0	17.0	0.06	4	6803 6.000 6804 6.000
7.00	8.00	6.70	58	11.0	19.9	0.07	4	6803 7.000 6804 7.000
7.70	8.00	7.40	58	12.0	20.5	0.08	4	6803 7.700 6804 7.700
8.00	8.00	7.70	58	12.0	21.0	0.08	4	6803 8.000 6804 8.000
9.00	10.00	8.70	66	13.0	23.9	0.09	4	6803 9.000 6804 9.000
9.70	10.00	9.40	66	14.0	24.5	0.10	4	6803 9.700 6804 9.700
10.00	10.00	9.50	66	14.0	24.0	0.10	4	6803 10.000 6804 10.000
11.70	12.00	11.20	73	16.0	25.3	0.12	4	6803 11.700 6804 11.700
12.00	12.00	11.50	73	16.0	26.0	0.12	4	6803 12.000 6804 12.000
15.60	16.00	15.10	82	22.0	31.2	0.16	4	6803 15.600 6804 15.600
16.00	16.00	15.50	82	22.0	32.0	0.16	4	6803 16.000 6804 16.000
19.00	20.00	18.50	92	26.0	38.7	0.19	4	6803 19.000 6804 19.000
20.00	20.00	19.50	92	26.0	40.0	0.20	4	6803 20.000 6804 20.000



Ratio end mills RF 100 Diver

Article no. **6737**



Cutting data page 676



neck clearance • centre cutting

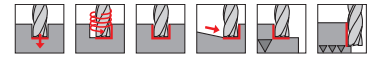

Ratio end mills RF 100 Diver

Article no. **6736**



Cutting data page 676



neck clearance • centre cutting

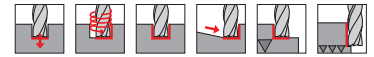

High-performance milling cutters

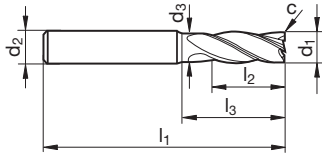

Article no.

6737

6736

d1 h10 mm	d2 h6 mm	d3 mm	l1 mm	l2 mm	l3 mm	c mm x 45°	Z	Order no.	
4.00	6.00	3.80	57	11.0	18.0	0.04	4	6737 4.000	6736 4.000
5.00	6.00	4.80	57	13.0	18.0	0.05	4	6737 5.000	6736 5.000
5.70	6.00	5.50	57	13.0	19.6	0.06	4	6737 5.700	6736 5.700
6.00	6.00	5.70	57	13.0	20.0	0.06	4	6737 6.000	6736 6.000
7.70	8.00	7.40	63	19.0	25.5	0.08	4	6737 7.700	6736 7.700
8.00	8.00	7.70	63	19.0	26.0	0.08	4	6737 8.000	6736 8.000
9.70	10.00	9.40	72	22.0	30.5	0.10	4	6737 9.700	6736 9.700
10.00	10.00	9.50	72	22.0	30.0	0.10	4	6737 10.000	6736 10.000
11.70	12.00	11.20	83	26.0	35.3	0.12	4	6737 11.700	6736 11.700
12.00	12.00	11.50	83	26.0	36.0	0.12	4	6737 12.000	6736 12.000
13.70	14.00	13.20	83	26.0	35.3	0.14	4	6737 13.700	6736 13.700
14.00	14.00	13.50	83	26.0	36.0	0.14	4	6737 14.000	6736 14.000
15.60	16.00	15.10	92	32.0	41.2	0.16	4	6737 15.600	6736 15.600
16.00	16.00	15.50	92	32.0	42.0	0.16	4	6737 16.000	6736 16.000
19.50	20.00	19.00	104	38.0	51.1	0.20	4	6737 19.500	6736 19.500
20.00	20.00	19.50	104	38.0	52.0	0.20	4	6737 20.000	6736 20.000



Ratio end mills RF 100 Diver

Article no. 6801



with internal cooling: radial and axial exits • neck clearance • centre cutting

Cutting data page 676

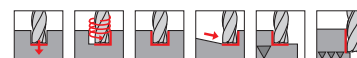

Ratio end mills RF 100 Diver

Article no. 6802



with internal cooling: radial and axial exits • neck clearance • centre cutting

Cutting data page 676

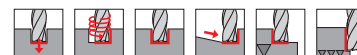
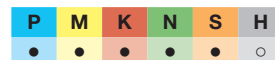

High-performance milling cutters

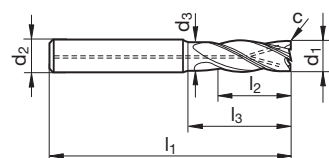

Article no. **6801** **6802**

d1 h10 mm	d2 h6 mm	d3 mm	l1 mm	l2 mm	l3 mm	c mm x 45°	Z	Order no.
6.00	6.00	5.70	57	13.0	20.0	0.06	4	6801 6.000 6802 6.000
8.00	8.00	7.70	63	19.0	26.0	0.08	4	6801 8.000 6802 8.000
10.00	10.00	9.50	72	22.0	30.0	0.10	4	6801 10.000 6802 10.000
12.00	12.00	11.50	83	26.0	36.0	0.12	4	6801 12.000 6802 12.000
16.00	16.00	15.50	92	32.0	42.0	0.16	4	6801 16.000 6802 16.000
20.00	20.00	19.50	104	38.0	52.0	0.20	4	6801 20.000 6802 20.000
25.00	25.00	24.00	121	45.0	63.0	0.25	4	6801 25.000 6802 25.000



Ratio end mill sets RF 100 Diver

Article no. **6755**



High-performance milling cutters



neck clearance • centre cutting • consisting of art. no. 6737

Cutting data page 676

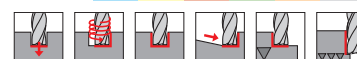

Article no. **6755**

Ø-range mm	Pieces/set	Order no.
5.7/7.7/9.7/11.7/15.6	5	6755 1.000
6/8/10/12/16	5	6755 2.000

Ratio end mill sets RF 100 Diver

Article no. **6754**



neck clearance • centre cutting • consisting of art. no. 6736

Cutting data page 676

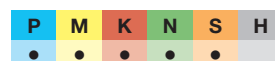

Article no. **6754**

Ø-range mm	Pieces/set	Order no.
5.7/7.7/9.7/11.7/15.6	5	6754 1.000
6/8/10/12/16	5	6754 2.000



Pilot end mills RF 100 P

Article no. 6716



Cutting data page 676



for piloting, drilling, finishing • adapted diameter tolerance m8 for solid carbide drills • special pilot geometry • centre cutting

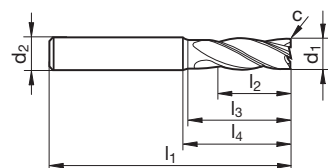
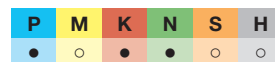

Article no. 6716

d1 m8 mm	d2 h6 mm	l1 mm	l2 mm	l3 mm	l4 mm	c mm x 45°	Z	Order no.
1.40	3.00	38	3.0	5.9	10.0	0.01	4	6716 1.400
1.50	3.00	38	4.0	6.9	10.0	0.02	4	6716 1.500
1.80	3.00	38	6.0	8.9	10.0	0.02	4	6716 1.800
2.00	3.00	38	6.5	9.4	10.0	0.02	4	6716 2.000
2.10	3.00	38	6.5	9.9	10.0	0.02	4	6716 2.100
2.30	3.00	38	6.5	9.9	10.0	0.02	4	6716 2.300
2.50	3.00	38	6.5	9.9	10.0	0.03	4	6716 2.500
2.80	3.00	38	6.5	10.0	10.0	0.03	4	6716 2.800
3.00	6.00	57	8.0	12.4	21.0	0.03	4	6716 3.000
3.50	6.00	57	10.0	14.9	21.0	0.04	4	6716 3.500
4.00	6.00	57	11.0	15.9	21.0	0.04	4	6716 4.000
4.50	6.00	57	11.0	17.4	21.0	0.05	4	6716 4.500
5.00	6.00	57	13.0	19.4	21.0	0.05	4	6716 5.000
5.50	6.00	57	13.0	20.4	21.0	0.06	4	6716 5.500
6.00	8.00	63	13.0	20.4	27.0	0.06	4	6716 6.000
6.50	8.00	63	13.0	20.9	27.0	0.07	4	6716 6.500
7.00	8.00	63	16.0	23.9	27.0	0.07	4	6716 7.000
7.50	8.00	63	16.0	23.9	27.0	0.08	4	6716 7.500
8.00	10.00	72	19.0	26.9	32.0	0.08	4	6716 8.000
8.50	10.00	72	19.0	28.4	32.0	0.09	4	6716 8.500
9.00	10.00	72	19.0	28.4	32.0	0.09	4	6716 9.000
10.00	12.00	83	22.0	31.4	38.0	0.10	4	6716 10.000
11.00	12.00	83	26.0	36.4	38.0	0.11	4	6716 11.000
12.00	14.00	83	26.0	37.4	38.0	0.12	4	6716 12.000

High-performance milling cutters



Ratio end mills RF 100 Sharp

Article no. **6478**



Cutting data page 680



especially for soft, tough and high-alloyed materials • longer cutting edge than DIN 6527 L • neck clearance • centre cutting

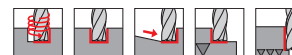
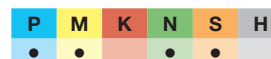

High-performance milling cutters

Ratio end mills RF 100 Sharp

Article no. **6479**



Cutting data page 680



especially for soft, tough and high-alloyed materials • longer cutting edge than DIN 6527 L • neck clearance • centre cutting

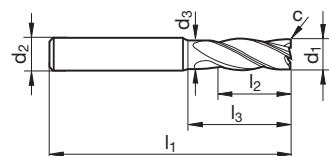
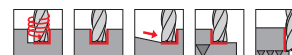
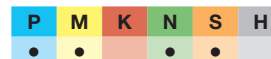

Article no.

6478

6479

d1 e8 mm	d2 h6 mm	d3 mm	l1 mm	l2 mm	l3 mm	c mm x 45°	Z	Order no.
1.00	4.00	0.92	50	3.0	4.0	0.02	4	6478 1.000
1.50	4.00	1.40	50	4.5	6.0	0.03	4	6478 1.500
2.00	6.00	1.85	50	6.0	8.0	0.04	4	6478 2.000
2.50	6.00	2.35	50	7.5	10.0	0.05	4	6478 2.500
3.00	6.00	2.85	57	10.0	15.0	0.06	4	6478 3.000
4.00	6.00	3.80	57	14.0	18.0	0.08	4	6478 4.000 6479 4.000
5.00	6.00	4.80	57	15.0	20.0	0.10	4	6478 5.000 6479 5.000
6.00	6.00	5.70	57	16.0	20.0	0.12	4	6478 6.000 6479 6.000
8.00	8.00	7.70	63	21.0	26.0	0.16	4	6478 8.000 6479 8.000
10.00	10.00	9.50	72	25.0	31.0	0.20	4	6478 10.000 6479 10.000
12.00	12.00	11.50	83	28.0	37.0	0.24	4	6478 12.000 6479 12.000
14.00	14.00	13.50	83	28.0	37.0	0.28	4	6478 14.000 6479 14.000
16.00	16.00	15.50	92	36.0	43.0	0.32	4	6478 16.000 6479 16.000
20.00	20.00	19.50	104	41.0	53.0	0.40	4	6478 20.000 6479 20.000



Ratio end mills RF 100 Sharp

Article no. 6480



especially for soft, tough and high-alloyed materials • medium length version • neck clearance • centre cutting

Cutting data page 680

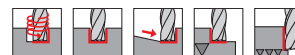
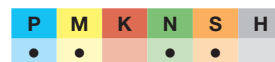

Ratio end mills RF 100 Sharp

Article no. 6481



especially for soft, tough and high-alloyed materials • medium length version • neck clearance • centre cutting

Cutting data page 680

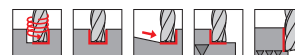
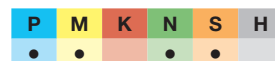

High-performance milling cutters

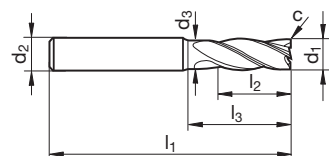

Article no. **6480** **6481**

d1 e8 mm	d2 h6 mm	d3 mm	l1 mm	l2 mm	l3 mm	c mm x 45°	Z	Order no.
1.00	4.00	0.92	50	3.0	5.5	0.02	4	6480 1.000
1.50	4.00	1.40	50	4.5	8.5	0.03	4	6480 1.500
2.00	6.00	1.85	57	6.0	11.5	0.04	4	6480 2.000
2.50	6.00	2.35	57	7.5	14.5	0.05	4	6480 2.500
3.00	6.00	2.85	65	10.0	20.0	0.06	4	6480 3.000
4.00	6.00	3.80	65	14.0	27.0	0.08	4	6480 4.000 6481 4.000
5.00	6.00	4.80	65	15.0	28.0	0.10	4	6480 5.000 6481 5.000
6.00	6.00	5.70	75	19.0	38.0	0.12	4	6480 6.000 6481 6.000
8.00	8.00	7.70	80	21.0	43.0	0.16	4	6480 8.000 6481 8.000
10.00	10.00	9.50	93	26.0	52.0	0.20	4	6480 10.000 6481 10.000
12.00	12.00	11.50	100	28.0	54.0	0.24	4	6480 12.000 6481 12.000
14.00	14.00	13.50	100	28.0	54.0	0.28	4	6480 14.000 6481 14.000
16.00	16.00	15.50	123	38.0	74.0	0.32	4	6480 16.000 6481 16.000
20.00	20.00	19.50	126	41.0	75.0	0.40	4	6480 20.000 6481 20.000



Ratio end mills RF 100 Sharp

Article no. 6962



especially for soft, tough and high-alloyed materials • neck clearance • centre cutting

Cutting data page 680

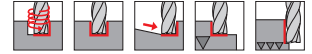

Ratio end mills RF 100 Sharp

Article no. 6963



especially for soft, tough and high-alloyed materials • neck clearance • centre cutting

Cutting data page 680

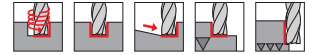

High-performance milling cutters

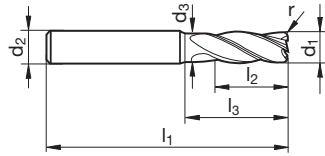

Article no.

6962

6963

d1 e8 mm	d2 h6 mm	d3 mm	l1 mm	l2 mm	l3 mm	r mm	Z	Order no.
3.00	6.00	2.85	57	8.0	15.0	0.20	4	6962 3.002 6963 3.002
3.00	6.00	2.85	57	8.0	15.0	0.50	4	6962 3.005 6963 3.005
4.00	6.00	3.80	57	11.0	18.0	0.20	4	6962 4.002 6963 4.002
4.00	6.00	3.80	57	11.0	18.0	0.50	4	6962 4.005 6963 4.005
4.00	6.00	3.80	57	11.0	18.0	1.00	4	6962 4.010 6963 4.010
5.00	6.00	4.80	57	13.0	18.0	0.20	4	6962 5.002 6963 5.002
5.00	6.00	4.80	57	13.0	18.0	0.50	4	6962 5.005 6963 5.005
5.00	6.00	4.80	57	13.0	18.0	1.00	4	6962 5.010 6963 5.010
6.00	6.00	5.70	57	13.0	20.0	0.20	4	6962 6.002 6963 6.002
6.00	6.00	5.70	57	13.0	20.0	0.50	4	6962 6.005 6963 6.005
6.00	6.00	5.70	57	13.0	20.0	1.00	4	6962 6.010 6963 6.010
6.00	6.00	5.70	57	13.0	20.0	1.50	4	6962 6.015 6963 6.015
8.00	8.00	7.70	63	19.0	26.0	0.30	4	6962 8.003 6963 8.003
8.00	8.00	7.70	63	19.0	26.0	0.50	4	6962 8.005 6963 8.005
8.00	8.00	7.70	63	19.0	26.0	1.00	4	6962 8.010 6963 8.010
8.00	8.00	7.70	63	19.0	26.0	1.50	4	6962 8.015 6963 8.015
8.00	8.00	7.70	63	19.0	26.0	2.00	4	6962 8.020 6963 8.020
10.00	10.00	9.50	72	22.0	31.0	0.30	4	6962 10.003 6963 10.003
10.00	10.00	9.50	72	22.0	31.0	0.50	4	6962 10.005 6963 10.005
10.00	10.00	9.50	72	22.0	31.0	1.00	4	6962 10.010 6963 10.010
10.00	10.00	9.50	72	22.0	31.0	1.50	4	6962 10.015 6963 10.015
10.00	10.00	9.50	72	22.0	31.0	2.00	4	6962 10.020 6963 10.020
10.00	10.00	9.50	72	22.0	31.0	2.50	4	6962 10.025 6963 10.025
12.00	12.00	11.50	83	26.0	37.0	0.30	4	6962 12.003 6963 12.003
12.00	12.00	11.50	83	26.0	37.0	0.50	4	6962 12.005 6963 12.005
12.00	12.00	11.50	83	26.0	37.0	1.00	4	6962 12.010 6963 12.010
12.00	12.00	11.50	83	26.0	37.0	1.50	4	6962 12.015 6963 12.015
12.00	12.00	11.50	83	26.0	37.0	2.00	4	6962 12.020 6963 12.020
12.00	12.00	11.50	83	26.0	37.0	2.50	4	6962 12.025 6963 12.025
12.00	12.00	11.50	83	26.0	37.0	3.00	4	6962 12.030 6963 12.030
16.00	16.00	15.50	92	32.0	43.0	0.50	4	6962 16.005 6963 16.005
16.00	16.00	15.50	92	32.0	43.0	1.00	4	6962 16.010 6963 16.010
16.00	16.00	15.50	92	32.0	43.0	1.50	4	6962 16.015 6963 16.015
16.00	16.00	15.50	92	32.0	43.0	2.00	4	6962 16.020 6963 16.020
16.00	16.00	15.50	92	32.0	43.0	2.50	4	6962 16.025 6963 16.025
16.00	16.00	15.50	92	32.0	43.0	3.00	4	6962 16.030 6963 16.030
16.00	16.00	15.50	92	32.0	43.0	4.00	4	6962 16.040 6963 16.040
20.00	20.00	19.50	104	38.0	53.0	0.50	4	6962 20.005 6963 20.005
20.00	20.00	19.50	104	38.0	53.0	1.00	4	6962 20.010 6963 20.010
20.00	20.00	19.50	104	38.0	53.0	1.50	4	6962 20.015 6963 20.015
20.00	20.00	19.50	104	38.0	53.0	2.00	4	6962 20.020 6963 20.020
20.00	20.00	19.50	104	38.0	53.0	2.50	4	6962 20.025 6963 20.025
20.00	20.00	19.50	104	38.0	53.0	3.00	4	6962 20.030 6963 20.030
20.00	20.00	19.50	104	38.0	53.0	4.00	4	6962 20.040 6963 20.040



Ratio end mills RF 100 iMill

Article no. 6964



especially suitable for difficult-to-machine special alloys • neck clearance • centre cutting • especially suitable for high-strength stainless materials and special alloys with increased cutting parameters

Cutting data page 682

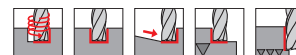
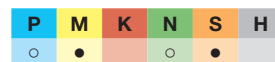

Ratio end mills RF 100 iMill

Article no. 6965



especially suitable for difficult-to-machine special alloys • neck clearance • centre cutting • especially suitable for high-strength stainless materials and special alloys with increased cutting parameters

Cutting data page 682

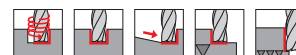
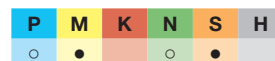

High-performance milling cutters

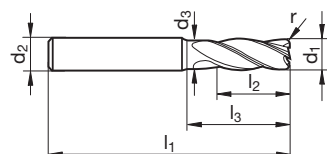

Article no.

6964

6965

d1 e8 mm	d2 h6 mm	d3 mm	l1 mm	l2 mm	l3 mm	r mm	Z	Order no.
3.00	6.00	2.85	57	8.0	15.0	0.20	4	6964 3.002 6965 3.002
3.00	6.00	2.85	57	8.0	15.0	0.50	4	6964 3.005 6965 3.005
4.00	6.00	3.80	57	11.0	18.0	0.20	4	6964 4.002 6965 4.002
4.00	6.00	3.80	57	11.0	18.0	0.50	4	6964 4.005 6965 4.005
4.00	6.00	3.80	57	11.0	18.0	1.00	4	6964 4.010 6965 4.010
5.00	6.00	4.80	57	13.0	18.0	0.20	4	6964 5.002 6965 5.002
5.00	6.00	4.80	57	13.0	18.0	0.50	4	6964 5.005 6965 5.005
5.00	6.00	4.80	57	13.0	18.0	1.00	4	6964 5.010 6965 5.010
6.00	6.00	5.70	57	13.0	20.0	0.20	4	6964 6.002 6965 6.002
6.00	6.00	5.70	57	13.0	20.0	0.50	4	6964 6.005 6965 6.005
6.00	6.00	5.70	57	13.0	20.0	1.00	4	6964 6.010 6965 6.010
6.00	6.00	5.70	57	13.0	20.0	1.50	4	6964 6.015 6965 6.015
8.00	8.00	7.70	63	19.0	26.0	0.30	4	6964 8.003 6965 8.003
8.00	8.00	7.70	63	19.0	26.0	0.50	4	6964 8.005 6965 8.005
8.00	8.00	7.70	63	19.0	26.0	1.00	4	6964 8.010 6965 8.010
8.00	8.00	7.70	63	19.0	26.0	1.50	4	6964 8.015 6965 8.015
8.00	8.00	7.70	63	19.0	26.0	2.00	4	6964 8.020 6965 8.020
10.00	10.00	9.50	72	22.0	31.0	0.30	4	6964 10.003 6965 10.003
10.00	10.00	9.50	72	22.0	31.0	0.50	4	6964 10.005 6965 10.005
10.00	10.00	9.50	72	22.0	31.0	1.00	4	6964 10.010 6965 10.010
10.00	10.00	9.50	72	22.0	31.0	1.50	4	6964 10.015 6965 10.015
10.00	10.00	9.50	72	22.0	31.0	2.00	4	6964 10.020 6965 10.020
10.00	10.00	9.50	72	22.0	31.0	2.50	4	6964 10.025 6965 10.025
12.00	12.00	11.50	83	26.0	37.0	0.30	4	6964 12.003 6965 12.003
12.00	12.00	11.50	83	26.0	37.0	0.50	4	6964 12.005 6965 12.005
12.00	12.00	11.50	83	26.0	37.0	1.00	4	6964 12.010 6965 12.010
12.00	12.00	11.50	83	26.0	37.0	1.50	4	6964 12.015 6965 12.015
12.00	12.00	11.50	83	26.0	37.0	2.00	4	6964 12.020 6965 12.020
12.00	12.00	11.50	83	26.0	37.0	2.50	4	6964 12.025 6965 12.025
12.00	12.00	11.50	83	26.0	37.0	3.00	4	6964 12.030 6965 12.030
16.00	16.00	15.50	92	32.0	43.0	0.50	4	6964 16.005 6965 16.005
16.00	16.00	15.50	92	32.0	43.0	1.00	4	6964 16.010 6965 16.010
16.00	16.00	15.50	92	32.0	43.0	1.50	4	6964 16.015 6965 16.015
16.00	16.00	15.50	92	32.0	43.0	2.00	4	6964 16.020 6965 16.020
16.00	16.00	15.50	92	32.0	43.0	2.50	4	6964 16.025 6965 16.025
16.00	16.00	15.50	92	32.0	43.0	3.00	4	6964 16.030 6965 16.030
16.00	16.00	15.50	92	32.0	43.0	4.00	4	6964 16.040 6965 16.040
20.00	20.00	19.50	104	38.0	53.0	0.50	4	6964 20.005 6965 20.005
20.00	20.00	19.50	104	38.0	53.0	1.00	4	6964 20.010 6965 20.010
20.00	20.00	19.50	104	38.0	53.0	1.50	4	6964 20.015 6965 20.015
20.00	20.00	19.50	104	38.0	53.0	2.00	4	6964 20.020 6965 20.020
20.00	20.00	19.50	104	38.0	53.0	2.50	4	6964 20.025 6965 20.025
20.00	20.00	19.50	104	38.0	53.0	3.00	4	6964 20.030 6965 20.030
20.00	20.00	19.50	104	38.0	53.0	4.00	4	6964 20.040 6965 20.040



High-performance milling cutters

Standard Ratio end mills RF 100 U

Article no. **6706**



neck clearance • centre cutting

Cutting data page 682

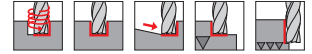
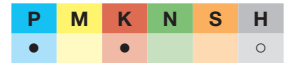

Standard Ratio end mills RF 100 U

Article no. **3731**

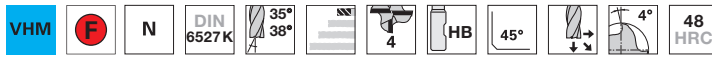

neck clearance • centre cutting

Cutting data page 682

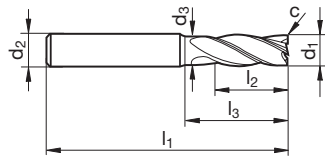
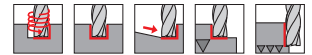
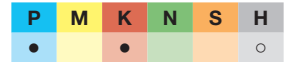

Article no.

6706

3731

d1 h10 mm	d2 h6 mm	d3 mm	l1 mm	l2 mm	l3 mm	c mm x 45°	Z	Order no.
3.00	6.00	2.80	50	5.0	12.0	0.10	4	6706 3.000 3731 3.000
4.00	6.00	3.80	54	8.0	15.0	0.10	4	6706 4.000 3731 4.000
5.00	6.00	4.80	54	9.0	15.0	0.10	4	6706 5.000 3731 5.000
6.00	6.00	5.70	54	10.0	17.0	0.10	4	6706 6.000 3731 6.000
8.00	8.00	7.70	58	12.0	21.0	0.15	4	6706 8.000 3731 8.000
10.00	10.00	9.50	66	14.0	24.0	0.20	4	6706 10.000 3731 10.000
12.00	12.00	11.50	73	16.0	26.0	0.20	4	6706 12.000 3731 12.000
14.00	14.00	13.50	75	18.0	28.0	0.25	4	6706 14.000 3731 14.000
16.00	16.00	15.50	82	22.0	32.0	0.35	4	6706 16.000 3731 16.000
18.00	18.00	17.50	84	24.0	34.0	0.40	4	6706 18.000 3731 18.000
20.00	20.00	19.50	92	26.0	40.0	0.45	4	6706 20.000 3731 20.000



Standard Ratio end mills RF 100 U

Article no. 3736



neck clearance • centre cutting

Cutting data page 682

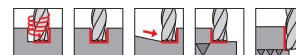
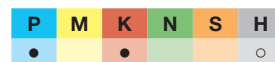

Standard Ratio end mills RF 100 U

Article no. 3732



neck clearance • centre cutting

Cutting data page 682

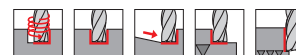

High-performance milling cutters

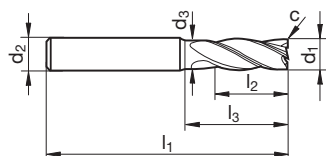

Article no.

3736

3732

d1 h10 mm	d2 h6 mm	d3 mm	l1 mm	l2 mm	l3 mm	c mm x 45°	Z	Order no.	
3.00	6.00	2.80	57	8.0	15.0	0.10	4	3736 3.000	3732 3.000
4.00	6.00	3.80	57	11.0	18.0	0.10	4	3736 4.000	3732 4.000
5.00	6.00	4.80	57	13.0	18.0	0.10	4	3736 5.000	3732 5.000
6.00	6.00	5.70	57	13.0	20.0	0.10	4	3736 6.000	3732 6.000
8.00	8.00	7.70	63	19.0	26.0	0.15	4	3736 8.000	3732 8.000
10.00	10.00	9.50	72	22.0	30.0	0.20	4	3736 10.000	3732 10.000
12.00	12.00	11.50	83	26.0	36.0	0.20	4	3736 12.000	3732 12.000
14.00	14.00	13.50	83	26.0	36.0	0.25	4	3736 14.000	3732 14.000
16.00	16.00	15.50	92	32.0	42.0	0.35	4	3736 16.000	3732 16.000
18.00	18.00	17.50	92	32.0	42.0	0.40	4	3736 18.000	3732 18.000
20.00	20.00	19.50	104	38.0	52.0	0.45	4	3736 20.000	3732 20.000
25.00	25.00	24.00	121	45.0	63.0	0.60	4	3736 25.000	3732 25.000



Standard Ratio end mills RF 100 U

Article no. **6726**



Cutting data page 682



neck clearance • centre cutting

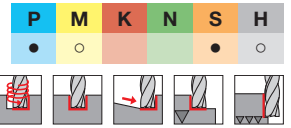

High-performance milling cutters

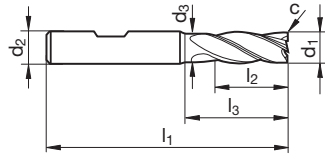

Article no. **6726**

d1 h10 mm	d2 h6 mm	d3 mm	l1 mm	l2 mm	l3 mm	c mm x 45°	Z	Order no.
6.00	6.00	5.70	57	13.0	20.0	0.10	4	6726 6.000
8.00	8.00	7.70	63	19.0	26.0	0.15	4	6726 8.000
10.00	10.00	9.50	72	22.0	30.0	0.20	4	6726 10.000
12.00	12.00	11.50	83	26.0	36.0	0.20	4	6726 12.000
16.00	16.00	15.50	92	32.0	42.0	0.35	4	6726 16.000
20.00	20.00	19.50	104	38.0	52.0	0.45	4	6726 20.000



Standard Ratio end mills RF 100 U

Article no. 3872



re-inforced core • neck clearance • centre cutting

Cutting data page 682

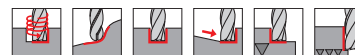
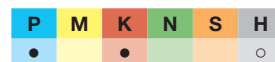

Standard Ratio end mills RF 100 U

Article no. 3873



re-inforced core • neck clearance • centre cutting

Cutting data page 682

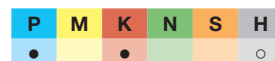

High-performance milling cutters

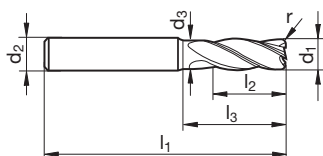

Article no. **3872** **3873**

d1 h10 mm	d2 h6 mm	d3 mm	l1 mm	l2 mm	l3 mm	r mm	Z	Order no.
6.00	6.00	5.70	57	13.0	20.0	0.50	4	3872 6.005 3873 6.005
6.00	6.00	5.70	57	13.0	20.0	1.00	4	3872 6.010 3873 6.010
6.00	6.00	5.70	57	13.0	20.0	2.00	4	3872 6.020 3873 6.020
8.00	8.00	7.70	63	19.0	26.0	0.50	4	3872 8.005 3873 8.005
8.00	8.00	7.70	63	19.0	26.0	1.00	4	3872 8.010 3873 8.010
8.00	8.00	7.70	63	19.0	26.0	2.00	4	3872 8.020 3873 8.020
10.00	10.00	9.50	72	22.0	30.0	0.50	4	3872 10.005 3873 10.005
10.00	10.00	9.50	72	22.0	30.0	1.00	4	3872 10.010 3873 10.010
10.00	10.00	9.50	72	22.0	30.0	2.00	4	3872 10.020 3873 10.020
12.00	12.00	11.50	83	26.0	36.0	0.50	4	3872 12.005 3873 12.005
12.00	12.00	11.50	83	26.0	36.0	1.00	4	3872 12.010 3873 12.010
12.00	12.00	11.50	83	26.0	36.0	2.00	4	3872 12.020 3873 12.020
16.00	16.00	15.50	92	32.0	42.0	0.50	4	3872 16.005 3873 16.005
16.00	16.00	15.50	92	32.0	42.0	1.00	4	3872 16.010 3873 16.010
16.00	16.00	15.50	92	32.0	42.0	2.00	4	3872 16.020 3873 16.020
16.00	16.00	15.50	92	32.0	42.0	3.00	4	3872 16.030 3873 16.030
20.00	20.00	19.50	104	38.0	52.0	0.50	4	3872 20.005 3873 20.005
20.00	20.00	19.50	104	38.0	52.0	1.00	4	3872 20.010 3873 20.010
20.00	20.00	19.50	104	38.0	52.0	2.00	4	3872 20.020 3873 20.020
20.00	20.00	19.50	104	38.0	52.0	3.00	4	3872 20.030 3873 20.030
25.00	25.00	24.00	121	45.0	63.0	2.00	4	3872 25.020 3873 25.020
25.00	25.00	24.00	121	45.0	63.0	3.00	4	3872 25.030 3873 25.030



High-performance milling cutters

Standard Ratio end mills RF 100 U

Article no. **3837**



neck clearance • centre cutting

Cutting data page 682

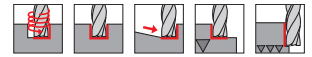

Standard Ratio end mills RF 100 U

Article no. **3838**



neck clearance • centre cutting

Cutting data page 682

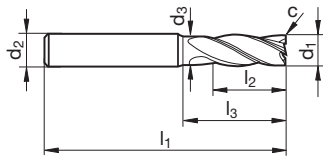
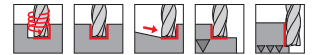
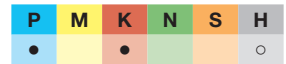

Article no. **3837** **3838**

d1 h10 mm	d2 h6 mm	d3 mm	l1 mm	l2 mm	l3 mm	c mm x 45°	Z	Order no.
6.00	6.00	5.70	65	13.0	28.0	0.10	4	3837 6.000 3838 6.000
8.00	8.00	7.70	75	19.0	38.0	0.15	4	3837 8.000 3838 8.000
10.00	10.00	9.50	80	22.0	38.0	0.20	4	3837 10.000 3838 10.000
12.00	12.00	11.50	93	26.0	46.0	0.20	4	3837 12.000 3838 12.000
16.00	16.00	15.50	108	32.0	58.0	0.35	4	3837 16.000 3838 16.000
20.00	20.00	19.50	126	38.0	74.0	0.45	4	3837 20.000 3838 20.000

Standard Ratio end mills RF 100 U

Article no. **3839**



neck clearance • centre cutting

Cutting data page 682

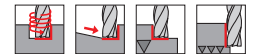

Standard Ratio end mills RF 100 U

Article no. **3871**



neck clearance • centre cutting

Cutting data page 682

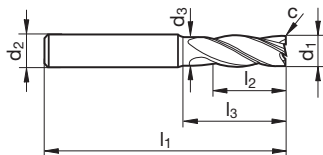
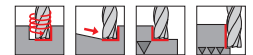

Article no. **3839** **3871**

d1 h10 mm	d2 h6 mm	d3 mm	l1 mm	l2 mm	l3 mm	c mm x 45°	Z	Order no.
6.00	6.00	5.70	65	18.0	28.0	0.10	4	3839 6.000 3871 6.000
8.00	8.00	7.70	75	24.0	38.0	0.15	4	3839 8.000 3871 8.000
10.00	10.00	9.50	80	30.0	38.0	0.20	4	3839 10.000 3871 10.000
12.00	12.00	11.50	93	36.0	46.0	0.20	4	3839 12.000 3871 12.000
16.00	16.00	15.50	108	48.0	58.0	0.35	4	3839 16.000 3871 16.000
20.00	20.00	19.50	126	60.0	74.0	0.45	4	3839 20.000 3871 20.000



Standard Ratio end mills RF 100 U

Article no. **3627**



neck clearance • centre cutting

Cutting data page 682

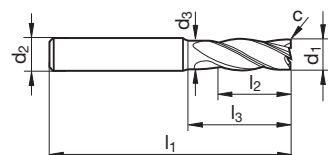
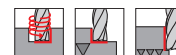
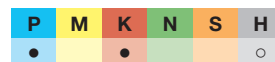

Article no. **3627**

d1 h10 mm	d2 h6 mm	d3 mm	l1 mm	l2 mm	l3 mm	c mm x 45°	Z	Order no.
10.00	10.00	9.50	100	40.0	48.0	0.20	4	3627 10.000
12.00	12.00	11.50	150	45.0	58.0	0.20	4	3627 12.000
14.00	14.00	13.50	150	45.0	58.0	0.25	4	3627 14.000
16.00	16.00	15.50	150	65.0	78.0	0.35	4	3627 16.000
18.00	18.00	17.50	150	65.0	78.0	0.40	4	3627 18.000
20.00	20.00	19.50	150	65.0	78.0	0.45	4	3627 20.000
25.00	25.00	24.00	150	75.0	92.0	0.60	4	3627 25.000

High-performance milling cutters

Standard Ratio end mills RF 100 U

Article no. **6767**



neck clearance • centre cutting

Cutting data page 682

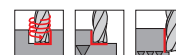
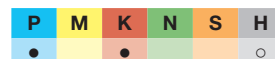

Standard Ratio end mills RF 100 U

Article no. **6768**



neck clearance • centre cutting

Cutting data page 682

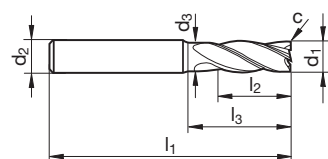
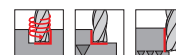
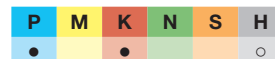

Article no. **6767** **6768**

d1 h10 mm	d2 h6 mm	d3 mm	l1 mm	l2 mm	l3 mm	c mm x 45°	Z	Order no.
6.00	6.00	5.70	65	24.0	28.0	0.12	4	6767 6.000 6768 6.000
8.00	8.00	7.70	75	32.0	38.0	0.16	4	6767 8.000 6768 8.000
10.00	10.00	9.50	100	40.0	58.0	0.20	4	6767 10.000 6768 10.000
12.00	12.00	11.50	100	48.0	53.0	0.24	4	6767 12.000 6768 12.000
16.00	16.00	15.50	125	64.0	75.0	0.32	4	6767 16.000 6768 16.000
20.00	20.00	19.50	150	80.0	98.0	0.40	4	6767 20.000 6768 20.000
25.00	25.00	24.00	175	100.0	117.0	0.50	4	6767 25.000 6768 25.000



High-performance milling cutters

Ratio roughing end mills RF 100 U

Article no. **6970**



Cutting data page 684

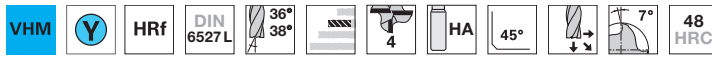

neck clearance • centre cutting

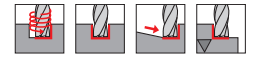

Ratio roughing end mills RF 100 U

Article no. **6971**



Cutting data page 684



neck clearance • centre cutting

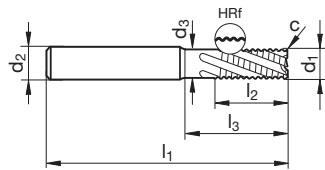
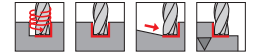
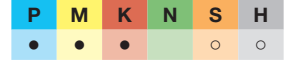

Article no.

6970

6971

d1 h10 mm	d2 h6 mm	d3 mm	l1 mm	l2 mm	l3 mm	c mm x 45°	Z
6.00	6.00	5.70	57	13.0	20.0	0.12	4
8.00	8.00	7.70	63	19.0	26.0	0.16	4
10.00	10.00	9.50	72	22.0	30.0	0.20	4
12.00	12.00	11.50	83	26.0	36.0	0.24	4
16.00	16.00	15.50	92	32.0	42.0	0.32	4
20.00	20.00	19.50	104	38.0	52.0	0.40	4

Order no.	
6970 6.000	6971 6.000
6970 8.000	6971 8.000
6970 10.000	6971 10.000
6970 12.000	6971 12.000
6970 16.000	6971 16.000
6970 20.000	6971 20.000

Ratio roughing end mills RF 100 U

Article no. **6972**



Cutting data page 684



neck clearance • centre cutting

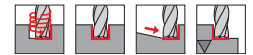
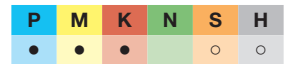

Ratio roughing end mills RF 100 U

Article no. **6973**



Cutting data page 684



neck clearance • centre cutting

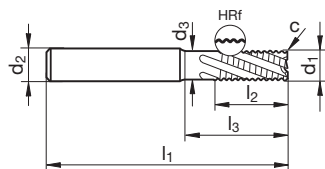
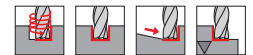
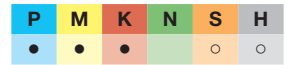

Article no.

6972

6973

d1 h10 mm	d2 h6 mm	d3 mm	l1 mm	l2 mm	l3 mm	c mm x 45°	Z
6.00	6.00	5.70	65	13.0	28.0	0.12	4
8.00	8.00	7.70	75	19.0	38.0	0.16	4
10.00	10.00	9.50	80	22.0	38.0	0.20	4
12.00	12.00	11.50	93	26.0	46.0	0.24	4
16.00	16.00	15.50	108	32.0	58.0	0.32	4
20.00	20.00	19.50	126	38.0	74.0	0.40	4

Order no.	
6972 6.000	6973 6.000
6972 8.000	6973 8.000
6972 10.000	6973 10.000
6972 12.000	6973 12.000
6972 16.000	6973 16.000
6972 20.000	6973 20.000



Ratio roughing end mills RF 100 U

Article no. 6881



neck clearance • centre cutting

Cutting data page 684

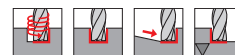
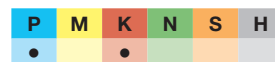

Ratio roughing end mills RF 100 U

Article no. 6882



neck clearance • centre cutting

Cutting data page 684

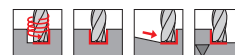
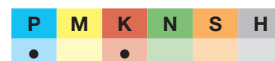

High-performance milling cutters

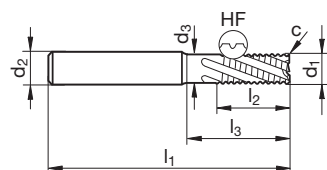

Article no. **6881** **6882**

d1 h10 mm	d2 h6 mm	d3 mm	l1 mm	l2 mm	l3 mm	c mm x 45°	Z	Order no.
6.00	6.00	5.70	57	13.0	20.0	0.12	4	6881 6.000 6882 6.000
8.00	8.00	7.70	63	19.0	26.0	0.16	4	6881 8.000 6882 8.000
10.00	10.00	9.50	72	22.0	30.0	0.20	4	6881 10.000 6882 10.000
12.00	12.00	11.50	83	26.0	36.0	0.24	4	6881 12.000 6882 12.000
16.00	16.00	15.50	92	32.0	42.0	0.32	4	6881 16.000 6882 16.000
20.00	20.00	19.50	104	38.0	52.0	0.40	4	6881 20.000 6882 20.000
25.00	25.00	24.00	121	45.0	63.0	0.50	4	6881 25.000 6882 25.000

Ratio roughing end mills RF 100 U

Article no. 6883



neck clearance • centre cutting

Cutting data page 684

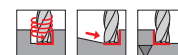
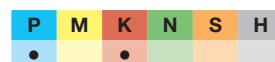

Ratio roughing end mills RF 100 U

Article no. 6884



neck clearance • centre cutting

Cutting data page 684

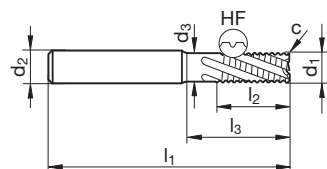
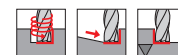
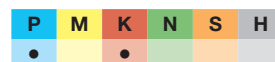

Article no. **6883** **6884**

d1 h10 mm	d2 h6 mm	d3 mm	l1 mm	l2 mm	l3 mm	c mm x 45°	Z	Order no.
6.00	6.00	5.70	65	18.0	28.0	0.12	4	6883 6.000 6884 6.000
8.00	8.00	7.70	75	24.0	38.0	0.16	4	6883 8.000 6884 8.000
10.00	10.00	9.50	80	30.0	38.0	0.20	4	6883 10.000 6884 10.000
12.00	12.00	11.50	93	36.0	46.0	0.24	4	6883 12.000 6884 12.000
16.00	16.00	15.50	108	48.0	58.0	0.32	4	6883 16.000 6884 16.000
20.00	20.00	19.50	126	60.0	74.0	0.40	4	6883 20.000 6884 20.000



Ratio roughing end mills RF 100 U

Article no. **6885**



Cutting data page 684



neck clearance • centre cutting

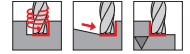
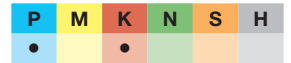

Ratio roughing end mills RF 100 U

Article no. **6886**



Cutting data page 684



neck clearance • centre cutting

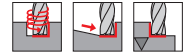
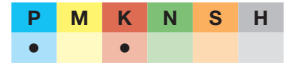

High-performance milling cutters

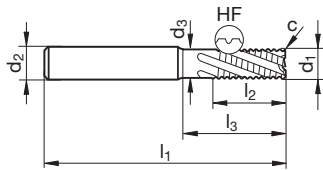

Article no.

6885

6886

d1 h10 mm	d2 h6 mm	d3 mm	l1 mm	l2 mm	l3 mm	c mm x 45°	Z	Order no.	
6.00	6.00	5.70	75	13.0	34.0	0.12	4	6885 6.000	6886 6.000
8.00	8.00	7.70	100	19.0	49.0	0.16	4	6885 8.000	6886 8.000
10.00	10.00	9.50	100	22.0	48.0	0.20	4	6885 10.000	6886 10.000
12.00	12.00	11.50	150	26.0	58.0	0.24	4	6885 12.000	6886 12.000
16.00	16.00	15.50	150	32.0	78.0	0.32	4	6885 16.000	6886 16.000
20.00	20.00	19.50	150	38.0	78.0	0.40	4	6885 20.000	6886 20.000



High-performance roughing end mills RS 100 U

Article no. 6887



neck clearance • centre cutting

Cutting data page 684

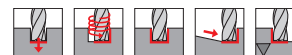

High-performance roughing end mills RS 100 U

Article no. 6888



neck clearance • centre cutting

Cutting data page 684

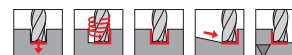

High-performance milling cutters

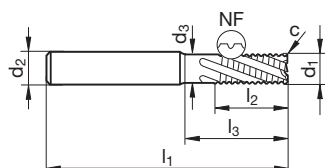

Article no.

6887

6888

d1 h10 mm	d2 h6 mm	d3 mm	l1 mm	l2 mm	l3 mm	c mm x 45°	Z	Order no.	
6.00	6.00	5.70	57	13.0	20.0	0.12	4	6887 6.000	6888 6.000
8.00	8.00	7.70	63	19.0	26.0	0.16	4	6887 8.000	6888 8.000
10.00	10.00	9.50	72	22.0	30.0	0.20	4	6887 10.000	6888 10.000
12.00	12.00	11.50	83	26.0	36.0	0.24	4	6887 12.000	6888 12.000
14.00	14.00	13.50	83	26.0	36.0	0.28	4	6887 14.000	6888 14.000
16.00	16.00	15.50	92	32.0	42.0	0.32	4	6887 16.000	6888 16.000
18.00	18.00	17.50	92	32.0	42.0	0.36	4	6887 18.000	6888 18.000
20.00	20.00	19.50	104	38.0	52.0	0.40	4	6887 20.000	6888 20.000
25.00	25.00	24.00	121	45.0	63.0	0.60	5	6887 25.000	6888 25.000



High-performance roughing end mills RS 100 F

Article no. **6889**



Cutting data page 684



neck clearance • centre cutting

P	M	K	N	S	H
•		•			○

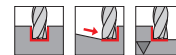

High-performance roughing end mills RS 100 F

Article no. **6890**



Cutting data page 684



neck clearance • centre cutting

P	M	K	N	S	H
•		•			○

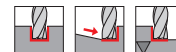

High-performance milling cutters

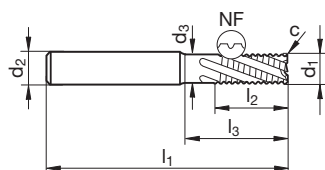

Article no.

6889

6890

d1 h10 mm	d2 h6 mm	d3 mm	l1 mm	l2 mm	l3 mm	c mm x 45°	Z
6.00	6.00	5.70	57	13.0	20.0	0.30	5
8.00	8.00	7.70	63	19.0	26.0	0.30	5
10.00	10.00	9.50	72	22.0	30.0	0.30	5
12.00	12.00	11.50	83	26.0	36.0	0.50	5
14.00	14.00	13.50	83	26.0	36.0	0.50	5
16.00	16.00	15.50	92	32.0	42.0	0.50	6
18.00	18.00	17.50	92	32.0	42.0	0.50	6
20.00	20.00	19.50	104	38.0	52.0	0.50	6
25.00	25.00	24.00	121	45.0	63.0	0.60	6

Order no.	
6889 6.000	6890 6.000
6889 8.000	6890 8.000
6889 10.000	6890 10.000
6889 12.000	6890 12.000
6889 14.000	6890 14.000
6889 16.000	6890 16.000
6889 18.000	6890 18.000
6889 20.000	6890 20.000
6889 25.000	6890 25.000



Roughing end mills GS 100 U (fine teeth)

Article no. 3723



centre cutting

Cutting data page 688

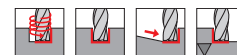

Roughing end mills GS 100 U (fine teeth)

Article no. 3365



with internal cooling • centre cutting

Cutting data page 688

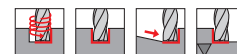
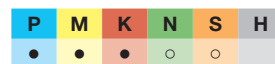

High-performance milling cutters

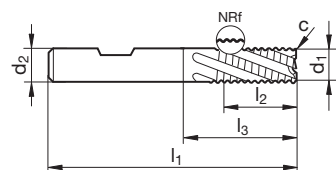

Article no. **3723** **3365**

d1 h10 mm	d2 h6 mm	l1 mm	l2 mm	l3 mm	c mm x 45°	Z	Order no.
6.00	6.00	57	13.0	21.0	0.30	4	3723 6.000 3365 6.000
8.00	8.00	63	19.0	27.0	0.30	4	3723 8.000 3365 8.000
10.00	10.00	72	22.0	32.0	0.30	4	3723 10.000 3365 10.000
12.00	12.00	83	26.0	38.0	0.50	4	3723 12.000 3365 12.000
14.00	14.00	83	26.0	38.0	0.50	4	3723 14.000
14.00	16.00	92	32.0	42.0	0.50	4	3723 14.001
16.00	16.00	92	32.0	44.0	0.50	4	3723 16.000 3365 16.000
18.00	18.00	92	32.0	44.0	0.50	4	3723 18.000
18.00	20.00	104	38.0	50.0	0.50	4	3723 18.001
20.00	20.00	104	38.0	54.0	0.50	4	3723 20.000 3365 20.000
25.00	25.00	121	45.0	65.0	0.60	5	3723 25.000



High-performance milling cutters

Ratio end mills RF 100 VA

Article no. **3804**



neck clearance • centre cutting

Cutting data page 682

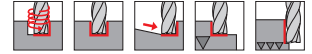

Ratio end mills RF 100 VA

Article no. **3805**



neck clearance • centre cutting

Cutting data page 682

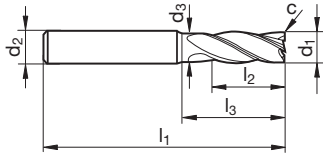
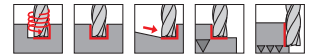

Article no.

3804

3805

d1 h10 mm	d2 h6 mm	d3 mm	l1 mm	l2 mm	l3 mm	c mm x 45°	Z	Order no.	
4.00	6.00	3.80	54	8.0	15.0	0.15	4	3804 4.000	3805 4.000
5.00	6.00	4.80	54	9.0	15.0	0.15	4	3804 5.000	3805 5.000
6.00	6.00	5.70	54	10.0	17.0	0.20	4	3804 6.000	3805 6.000
8.00	8.00	7.70	58	12.0	21.0	0.25	4	3804 8.000	3805 8.000
10.00	10.00	9.50	66	14.0	24.0	0.30	4	3804 10.000	3805 10.000
12.00	12.00	11.50	73	16.0	26.0	0.35	4	3804 12.000	3805 12.000
16.00	16.00	15.50	82	22.0	32.0	0.50	4	3804 16.000	3805 16.000
20.00	20.00	19.50	92	26.0	40.0	0.60	4	3804 20.000	3805 20.000



Ratio end mills RF 100 VA

Article no. 3800



neck clearance • centre cutting

Cutting data page 682

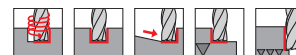
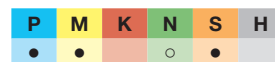

Ratio end mills RF 100 VA

Article no. 3803



neck clearance • centre cutting

Cutting data page 682

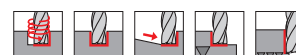
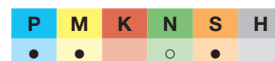

High-performance milling cutters

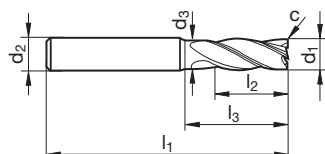

Article no.

3800

3803

d1 h10 mm	d2 h6 mm	d3 mm	l1 mm	l2 mm	l3 mm	c mm x 45°	Z	Order no.
3.00	6.00	2.80	57	8.0	15.0	0.10	4	3800 3.000 3803 3.000
3.50	6.00	3.30	57	10.0	15.0	0.10	4	3800 3.500 3803 3.500
4.00	6.00	3.80	57	11.0	18.0	0.15	4	3800 4.000 3803 4.000
4.50	6.00	4.30	57	11.0	18.0	0.15	4	3800 4.500 3803 4.500
5.00	6.00	4.80	57	13.0	18.0	0.15	4	3800 5.000 3803 5.000
5.50	6.00	5.30	57	13.0	19.4	0.20	4	3800 5.500 3803 5.500
6.00	6.00	5.70	57	13.0	20.0	0.20	4	3800 6.000 3803 6.000
6.50	8.00	6.20	63	16.0	24.4	0.25	4	3800 6.500 3803 6.500
7.00	8.00	6.70	63	16.0	24.9	0.25	4	3800 7.000 3803 7.000
7.50	8.00	7.20	63	19.0	25.3	0.25	4	3800 7.500 3803 7.500
8.00	8.00	7.70	63	19.0	26.0	0.25	4	3800 8.000 3803 8.000
8.50	10.00	8.20	72	19.0	29.4	0.30	4	3800 8.500 3803 8.500
9.00	10.00	8.70	72	19.0	29.9	0.30	4	3800 9.000 3803 9.000
9.50	10.00	9.20	72	22.0	30.3	0.30	4	3800 9.500 3803 9.500
10.00	10.00	9.50	72	22.0	30.0	0.30	4	3800 10.000 3803 10.000
11.00	12.00	10.50	83	26.0	34.7	0.35	4	3800 11.000 3803 11.000
12.00	12.00	11.50	83	26.0	36.0	0.35	4	3800 12.000 3803 12.000
14.00	14.00	13.50	83	26.0	36.0	0.40	4	3800 14.000 3803 14.000
16.00	16.00	15.50	92	32.0	42.0	0.50	4	3800 16.000 3803 16.000
18.00	18.00	17.50	92	32.0	42.0	0.60	4	3800 18.000 3803 18.000
20.00	20.00	19.50	104	38.0	52.0	0.60	4	3800 20.000 3803 20.000
25.00	25.00	24.00	121	45.0	63.0	0.75	4	3800 25.000 3803 25.000



High-performance milling cutters

Ratio end mills RF 100 VA

Article no. **3806**



neck clearance • centre cutting

Cutting data page 682

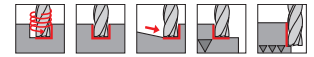

Ratio end mills RF 100 VA

Article no. **3807**



neck clearance • centre cutting

Cutting data page 682

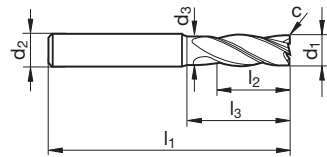
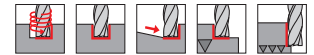

Article no. **3806** **3807**

d1 h10 mm	d2 h6 mm	d3 mm	l1 mm	l2 mm	l3 mm	c mm x 45°	Z	Order no.
6.00	6.00	5.70	65	10.0	28.0	0.20	4	3806 6.000 3807 6.000
8.00	8.00	7.70	75	12.0	38.0	0.25	4	3806 8.000 3807 8.000
10.00	10.00	9.50	80	14.0	38.0	0.30	4	3806 10.000 3807 10.000
12.00	12.00	11.50	93	16.0	46.0	0.35	4	3806 12.000 3807 12.000
16.00	16.00	15.50	108	22.0	58.0	0.50	4	3806 16.000 3807 16.000
20.00	20.00	19.50	126	26.0	74.0	0.60	4	3806 20.000 3807 20.000

Ratio end mills RF 100 VA

Article no. **6707**



2 face cutting edges up to the centre • neck clearance • centre cutting

Cutting data page 682

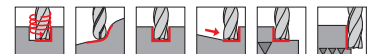

Ratio end mills RF 100 VA

Article no. **6708**



2 face cutting edges up to the centre • neck clearance • centre cutting

Cutting data page 682

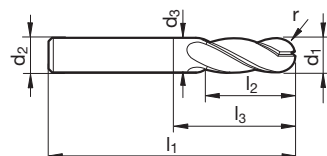
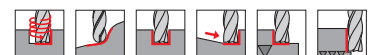

Article no. **6707** **6708**

d1 h10 mm	d2 h6 mm	d3 mm	l1 mm	l2 mm	l3 mm	r mm	Z	Order no.
4.00	6.00	3.80	57	11.0	18.0	2.00	4	6707 4.000 6708 4.000
5.00	6.00	4.80	57	13.0	18.0	2.50	4	6707 5.000 6708 5.000
6.00	6.00	5.70	57	13.0	20.0	3.00	4	6707 6.000 6708 6.000
8.00	8.00	7.70	63	19.0	26.0	4.00	4	6707 8.000 6708 8.000
10.00	10.00	9.50	72	22.0	30.0	5.00	4	6707 10.000 6708 10.000
12.00	12.00	11.50	83	26.0	36.0	6.00	4	6707 12.000 6708 12.000
16.00	16.00	15.50	92	32.0	42.0	8.00	4	6707 16.000 6708 16.000
20.00	20.00	19.50	104	38.0	52.0	10.00	4	6707 20.000 6708 20.000
25.00	25.00	24.00	121	45.0	63.0	12.50	4	6707 25.000 6708 25.000



Ratio roughing end mills RF 100 VA

Article no. 6877



neck clearance • centre cutting

Cutting data page 684

P	M	K	N	S	H
●	●	●	○	○	

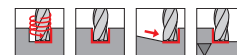

Ratio roughing end mills RF 100 VA

Article no. 6878



neck clearance • centre cutting

Cutting data page 684

P	M	K	N	S	H
●	●	●	○	○	

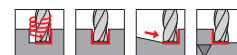

High-performance milling cutters

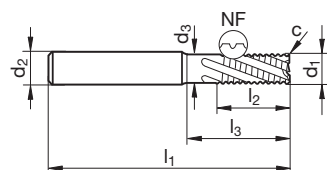

Article no. **6877** **6878**

d1 h10 mm	d2 h6 mm	d3 mm	l1 mm	l2 mm	l3 mm	c mm x 45°	Z	Order no.
5.00	6.00	4.80	57	13.0	18.0	0.10	4	6877 5.000 6878 5.000
6.00	6.00	5.70	57	13.0	20.0	0.12	4	6877 6.000 6878 6.000
7.00	8.00	6.70	63	16.0	24.9	0.14	4	6877 7.000 6878 7.000
8.00	8.00	7.70	63	19.0	26.0	0.16	4	6877 8.000 6878 8.000
9.00	10.00	8.70	72	19.0	29.9	0.18	4	6877 9.000 6878 9.000
10.00	10.00	9.50	72	22.0	30.0	0.20	4	6877 10.000 6878 10.000
12.00	12.00	11.50	83	26.0	36.0	0.24	4	6877 12.000 6878 12.000
14.00	14.00	13.50	83	26.0	36.0	0.28	4	6877 14.000 6878 14.000
16.00	16.00	15.50	92	32.0	42.0	0.32	4	6877 16.000 6878 16.000
18.00	18.00	17.50	92	32.0	42.0	0.36	4	6877 18.000 6878 18.000
20.00	20.00	19.50	104	38.0	52.0	0.40	4	6877 20.000 6878 20.000
25.00	25.00	24.00	121	45.0	63.0	0.50	4	6877 25.000 6878 25.000

Ratio roughing end mills RF 100 VA

Article no. 6879



neck clearance • centre cutting

Cutting data page 684

P	M	K	N	S	H
●	●	●	○	○	



Ratio roughing end mills RF 100 VA

Article no. 6880



neck clearance • centre cutting

Cutting data page 684

P	M	K	N	S	H
●	●	●	○	○	

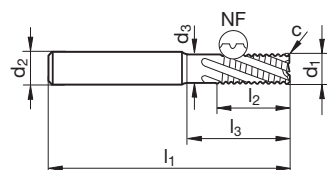
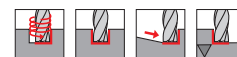

Article no. **6879** **6880**

d1 h10 mm	d2 h6 mm	d3 mm	l1 mm	l2 mm	l3 mm	c mm x 45°	Z	Order no.
6.00	6.00	5.70	65	10.0	28.0	0.12	4	6879 6.000 6880 6.000
8.00	8.00	7.70	75	12.0	38.0	0.16	4	6879 8.000 6880 8.000
10.00	10.00	9.50	80	14.0	38.0	0.20	4	6879 10.000 6880 10.000
12.00	12.00	11.50	93	16.0	46.0	0.24	4	6879 12.000 6880 12.000
16.00	16.00	15.50	108	22.0	58.0	0.32	4	6879 16.000 6880 16.000
20.00	20.00	19.50	126	26.0	74.0	0.40	4	6879 20.000 6880 20.000



Ratio end mills RF 100 Ti

Article no. 3498



Cutting data page 682



re-reinforced core • neck clearance • centre cutting

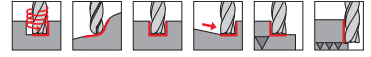
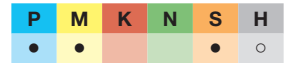

Ratio end mills RF 100 Ti

Article no. 3499



Cutting data page 682



re-reinforced core • neck clearance • centre cutting

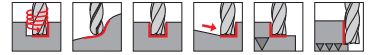
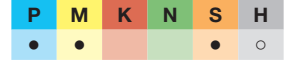

High-performance milling cutters

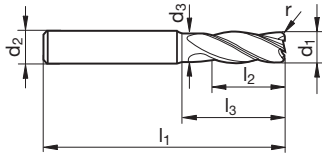

Article no. **3498** **3499**

d1 h10 mm	d2 h6 mm	d3 mm	l1 mm	l2 mm	l3 mm	r mm	Z	Order no.
6.00	6.00	5.70	57	13.0	20.0	0.50	4	3498 6.005 3499 6.005
6.00	6.00	5.70	57	13.0	20.0	0.80	4	3498 6.008 3499 6.008
6.00	6.00	5.70	57	13.0	20.0	1.00	4	3498 6.010 3499 6.010
6.00	6.00	5.70	57	13.0	20.0	1.50	4	3498 6.015 3499 6.015
6.00	6.00	5.70	57	13.0	20.0	2.00	4	3498 6.020 3499 6.020
8.00	8.00	7.70	63	19.0	26.0	0.50	4	3498 8.005 3499 8.005
8.00	8.00	7.70	63	19.0	26.0	0.80	4	3498 8.008 3499 8.008
8.00	8.00	7.70	63	19.0	26.0	1.00	4	3498 8.010 3499 8.010
8.00	8.00	7.70	63	19.0	26.0	1.50	4	3498 8.015 3499 8.015
8.00	8.00	7.70	63	19.0	26.0	2.00	4	3498 8.020 3499 8.020
10.00	10.00	9.50	72	22.0	30.0	0.50	4	3498 10.005 3499 10.005
10.00	10.00	9.50	72	22.0	30.0	0.80	4	3498 10.008 3499 10.008
10.00	10.00	9.50	72	22.0	30.0	1.00	4	3498 10.010 3499 10.010
10.00	10.00	9.50	72	22.0	30.0	1.50	4	3498 10.015 3499 10.015
10.00	10.00	9.50	72	22.0	30.0	2.00	4	3498 10.020 3499 10.020
12.00	12.00	11.50	83	26.0	36.0	0.50	4	3498 12.005 3499 12.005
12.00	12.00	11.50	83	26.0	36.0	0.80	4	3498 12.008 3499 12.008
12.00	12.00	11.50	83	26.0	36.0	1.00	4	3498 12.010 3499 12.010
12.00	12.00	11.50	83	26.0	36.0	1.50	4	3498 12.015 3499 12.015
12.00	12.00	11.50	83	26.0	36.0	2.00	4	3498 12.020 3499 12.020
12.00	12.00	11.50	83	26.0	36.0	2.50	4	3498 12.025 3499 12.025
12.00	12.00	11.50	83	26.0	36.0	3.00	4	3498 12.030 3499 12.030
12.00	12.00	11.50	83	26.0	36.0	3.17	4	3498 12.031 3499 12.031
12.00	12.00	11.50	83	26.0	36.0	4.00	4	3498 12.040 3499 12.040
16.00	16.00	15.50	92	32.0	42.0	0.50	4	3498 16.005 3499 16.005
16.00	16.00	15.50	92	32.0	42.0	0.80	4	3498 16.008 3499 16.008
16.00	16.00	15.50	92	32.0	42.0	1.00	4	3498 16.010 3499 16.010
16.00	16.00	15.50	92	32.0	42.0	1.50	4	3498 16.015 3499 16.015
16.00	16.00	15.50	92	32.0	42.0	2.00	4	3498 16.020 3499 16.020
16.00	16.00	15.50	92	32.0	42.0	2.50	4	3498 16.025 3499 16.025
16.00	16.00	15.50	92	32.0	42.0	3.00	4	3498 16.030 3499 16.030
16.00	16.00	15.50	92	32.0	42.0	3.17	4	3498 16.031 3499 16.031
16.00	16.00	15.50	92	32.0	42.0	4.00	4	3498 16.040 3499 16.040
20.00	20.00	19.50	104	38.0	52.0	0.50	4	3498 20.005 3499 20.005
20.00	20.00	19.50	104	38.0	52.0	1.00	4	3498 20.010 3499 20.010
20.00	20.00	19.50	104	38.0	52.0	1.50	4	3498 20.015 3499 20.015
20.00	20.00	19.50	104	38.0	52.0	2.00	4	3498 20.020 3499 20.020
20.00	20.00	19.50	104	38.0	52.0	2.50	4	3498 20.025 3499 20.025
20.00	20.00	19.50	104	38.0	52.0	3.00	4	3498 20.030 3499 20.030
20.00	20.00	19.50	104	38.0	52.0	3.17	4	3498 20.031 3499 20.031
20.00	20.00	19.50	104	38.0	52.0	4.00	4	3498 20.040 3499 20.040
25.00	25.00	24.00	121	45.0	63.0	1.50	4	3498 25.015 3499 25.015
25.00	25.00	24.00	121	45.0	63.0	2.00	4	3498 25.020 3499 25.020
25.00	25.00	24.00	121	45.0	63.0	2.50	4	3498 25.025 3499 25.025
25.00	25.00	24.00	121	45.0	63.0	3.00	4	3498 25.030 3499 25.030
25.00	25.00	24.00	121	45.0	63.0	3.17	4	3498 25.031 3499 25.031
25.00	25.00	24.00	121	45.0	63.0	4.00	4	3498 25.040 3499 25.040
25.00	25.00	24.00	121	45.0	63.0	5.00	4	3498 25.050 3499 25.050



Ratio end mills RF 100 Ti

Article no. 6966



re-reinforced core • neck clearance • centre cutting

Cutting data page 682

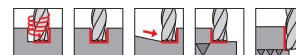
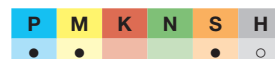

Ratio end mills RF 100 Ti

Article no. 6967



re-reinforced core • neck clearance • centre cutting

Cutting data page 682

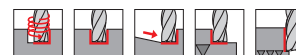
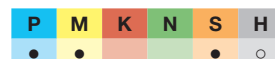

High-performance milling cutters

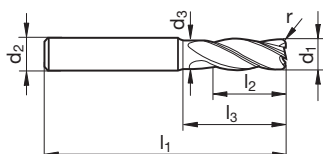

Article no. 6966 6967

d1 h10 mm	d2 h6 mm	d3 mm	l1 mm	l2 mm	l3 mm	r mm	Z	Order no.
6.00	6.00	5.70	57	13.0	20.0	0.50	4	6966 6.005 6967 6.005
6.00	6.00	5.70	57	13.0	20.0	0.80	4	6966 6.008 6967 6.008
6.00	6.00	5.70	57	13.0	20.0	1.00	4	6966 6.010 6967 6.010
6.00	6.00	5.70	57	13.0	20.0	1.50	4	6966 6.015 6967 6.015
6.00	6.00	5.70	57	13.0	20.0	2.00	4	6966 6.020 6967 6.020
8.00	8.00	7.70	63	19.0	26.0	0.50	4	6966 8.005 6967 8.005
8.00	8.00	7.70	63	19.0	26.0	0.80	4	6966 8.008 6967 8.008
8.00	8.00	7.70	63	19.0	26.0	1.00	4	6966 8.010 6967 8.010
8.00	8.00	7.70	63	19.0	26.0	1.50	4	6966 8.015 6967 8.015
8.00	8.00	7.70	63	19.0	26.0	2.00	4	6966 8.020 6967 8.020
10.00	10.00	9.50	72	22.0	30.0	0.50	4	6966 10.005 6967 10.005
10.00	10.00	9.50	72	22.0	30.0	0.80	4	6966 10.008 6967 10.008
10.00	10.00	9.50	72	22.0	30.0	1.00	4	6966 10.010 6967 10.010
10.00	10.00	9.50	72	22.0	30.0	1.50	4	6966 10.015 6967 10.015
10.00	10.00	9.50	72	22.0	30.0	2.00	4	6966 10.020 6967 10.020
12.00	12.00	11.50	83	26.0	36.0	0.50	4	6966 12.005 6967 12.005
12.00	12.00	11.50	83	26.0	36.0	0.80	4	6966 12.008 6967 12.008
12.00	12.00	11.50	83	26.0	36.0	1.00	4	6966 12.010 6967 12.010
12.00	12.00	11.50	83	26.0	36.0	1.50	4	6966 12.015 6967 12.015
12.00	12.00	11.50	83	26.0	36.0	2.00	4	6966 12.020 6967 12.020
12.00	12.00	11.50	83	26.0	36.0	2.50	4	6966 12.025 6967 12.025
12.00	12.00	11.50	83	26.0	36.0	3.00	4	6966 12.030 6967 12.030
12.00	12.00	11.50	83	26.0	36.0	3.17	4	6966 12.031 6967 12.031
12.00	12.00	11.50	83	26.0	36.0	4.00	4	6966 12.040 6967 12.040
16.00	16.00	15.50	92	32.0	42.0	0.50	4	6966 16.005 6967 16.005
16.00	16.00	15.50	92	32.0	42.0	0.80	4	6966 16.008 6967 16.008
16.00	16.00	15.50	92	32.0	42.0	1.00	4	6966 16.010 6967 16.010
16.00	16.00	15.50	92	32.0	42.0	1.50	4	6966 16.015 6967 16.015
16.00	16.00	15.50	92	32.0	42.0	2.00	4	6966 16.020 6967 16.020
16.00	16.00	15.50	92	32.0	42.0	2.50	4	6966 16.025 6967 16.025
16.00	16.00	15.50	92	32.0	42.0	3.00	4	6966 16.030 6967 16.030
16.00	16.00	15.50	92	32.0	42.0	3.17	4	6966 16.031 6967 16.031
16.00	16.00	15.50	92	32.0	42.0	4.00	4	6966 16.040 6967 16.040
20.00	20.00	19.50	104	38.0	52.0	0.50	4	6966 20.005 6967 20.005
20.00	20.00	19.50	104	38.0	52.0	1.00	4	6966 20.010 6967 20.010
20.00	20.00	19.50	104	38.0	52.0	1.50	4	6966 20.015 6967 20.015
20.00	20.00	19.50	104	38.0	52.0	2.00	4	6966 20.020 6967 20.020
20.00	20.00	19.50	104	38.0	52.0	2.50	4	6966 20.025 6967 20.025
20.00	20.00	19.50	104	38.0	52.0	3.00	4	6966 20.030 6967 20.030
20.00	20.00	19.50	104	38.0	52.0	3.17	4	6966 20.031 6967 20.031
20.00	20.00	19.50	104	38.0	52.0	4.00	4	6966 20.040 6967 20.040
25.00	25.00	24.00	121	45.0	63.0	1.50	4	6966 25.015 6967 25.015
25.00	25.00	24.00	121	45.0	63.0	2.00	4	6966 25.020 6967 25.020
25.00	25.00	24.00	121	45.0	63.0	2.50	4	6966 25.025 6967 25.025
25.00	25.00	24.00	121	45.0	63.0	3.00	4	6966 25.030 6967 25.030
25.00	25.00	24.00	121	45.0	63.0	3.17	4	6966 25.031 6967 25.031
25.00	25.00	24.00	121	45.0	63.0	4.00	4	6966 25.040 6967 25.040
25.00	25.00	24.00	121	45.0	63.0	5.00	4	6966 25.050 6967 25.050



High-performance milling cutters

Ratio end mills RF 100 F

Article no. **3629**



neck clearance • centre cutting

Cutting data page 682

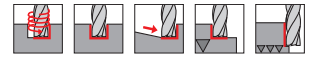

Ratio end mills RF 100 F

Article no. **3630**



neck clearance • centre cutting

Cutting data page 682

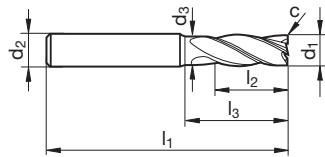
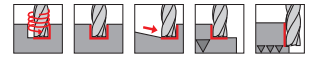

Article no. **3629** **3630**

d1 h10 mm	d2 h6 mm	d3 mm	l1 mm	l2 mm	l3 mm	c mm x 45°	Z	Order no.
4.00	6.00	3.80	57	11.0	18.0	0.10	4	3629 4.000 3630 4.000
5.00	6.00	4.80	57	13.0	18.0	0.10	4	3629 5.000 3630 5.000
6.00	6.00	5.70	57	13.0	20.0	0.15	4	3629 6.000 3630 6.000
8.00	8.00	7.70	63	19.0	26.0	0.15	4	3629 8.000 3630 8.000
10.00	10.00	9.50	72	22.0	30.0	0.20	4	3629 10.000 3630 10.000
12.00	12.00	11.50	83	26.0	36.0	0.20	4	3629 12.000 3630 12.000
16.00	16.00	15.50	92	32.0	42.0	0.35	4	3629 16.000 3630 16.000
20.00	20.00	19.50	104	38.0	52.0	0.45	4	3629 20.000 3630 20.000

Ratio end mills RF 100 F

Article no. **6968**



neck clearance • centre cutting

Cutting data page 682

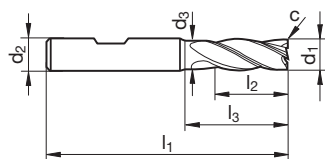
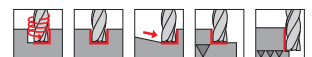
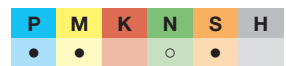

Article no. **6968**

d1 h10 mm	d2 h6 mm	d3 mm	l1 mm	l2 mm	l3 mm	c mm x 45°	Z	Order no.
4.00	6.00	3.80	57	11.0	18.0	0.10	4	6968 4.000
5.00	6.00	4.80	57	13.0	18.0	0.10	4	6968 5.000
6.00	6.00	5.70	57	13.0	20.0	0.15	4	6968 6.000
8.00	8.00	7.70	63	19.0	26.0	0.15	4	6968 8.000
10.00	10.00	9.50	72	22.0	30.0	0.20	4	6968 10.000
12.00	12.00	11.50	83	26.0	36.0	0.20	4	6968 12.000
16.00	16.00	15.50	92	32.0	42.0	0.35	4	6968 16.000
20.00	20.00	19.50	104	38.0	52.0	0.45	4	6968 20.000



Ratio end mills RF 100 F

Article no. 3366



with internal cooling • neck clearance • centre cutting

Cutting data page 682

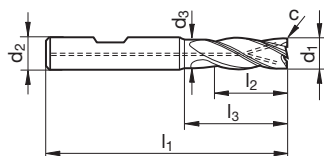
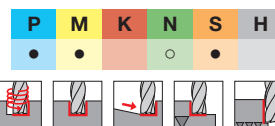

Article no. 3366

d1 h10 mm	d2 h6 mm	d3 mm	l1 mm	l2 mm	l3 mm	c mm x 45°	Z	Order no.
6.00	6.00	5.70	57	13.0	20.0	0.15	4	3366 6.000
8.00	8.00	7.70	63	19.0	26.0	0.15	4	3366 8.000
10.00	10.00	9.50	72	22.0	30.0	0.20	4	3366 10.000
12.00	12.00	11.50	83	26.0	36.0	0.20	4	3366 12.000
16.00	16.00	15.50	92	32.0	42.0	0.35	4	3366 16.000
20.00	20.00	19.50	104	38.0	52.0	0.45	4	3366 20.000

High-performance milling cutters

90° Ratio end mills RF 100 F

Article no. 6764



without corner protection chamfer • neck clearance • centre cutting

Cutting data page 682

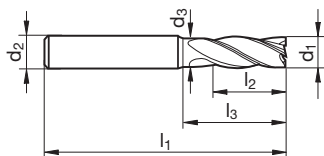
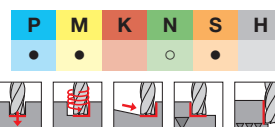

Article no. 6764

d1 h10 mm	d2 h6 mm	d3 mm	l1 mm	l2 mm	l3 mm	Z	Order no.
3.00	6.00	2.80	57	8.0	15.0	4	6764 3.000
4.00	6.00	3.80	57	11.0	18.0	4	6764 4.000
5.00	6.00	4.80	57	13.0	18.0	4	6764 5.000
6.00	6.00	5.70	57	13.0	20.0	4	6764 6.000
8.00	8.00	7.70	63	19.0	26.0	4	6764 8.000
10.00	10.00	9.50	72	22.0	30.0	4	6764 10.000
12.00	12.00	11.50	83	26.0	36.0	4	6764 12.000
16.00	16.00	15.50	92	32.0	42.0	4	6764 16.000
20.00	20.00	19.50	104	38.0	52.0	4	6764 20.000



High-performance milling cutters

Ratio end mills RF 100 Speed M

Article no. **6765**



slotting up to max. 0.8xD depth • re-inforced core from Ø 6 mm • centre cutting

Cutting data page 678

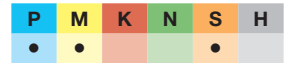

Ratio end mills RF 100 Speed M

Article no. **6760**



slotting up to max. 0.8xD depth • re-inforced core from Ø 6 mm • centre cutting

Cutting data page 678

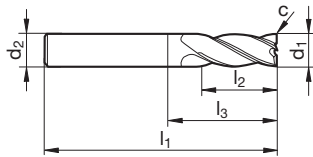
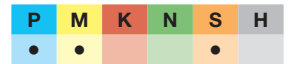

Article no.		6765	6760
		Order no.	
d1 h10 mm	d2 h6 mm		
3.00	6.00	6765 3.000	6760 3.000
4.00	6.00	6765 4.000	6760 4.000
5.00	6.00	6765 5.000	6760 5.000
6.00	6.00	6765 6.000	6760 6.000
8.00	8.00	6765 8.000	6760 8.000
10.00	10.00	6765 10.000	6760 10.000
12.00	12.00	6765 12.000	6760 12.000
16.00	16.00	6765 16.000	6760 16.000
20.00	20.00	6765 20.000	6760 20.000

Ratio end mills RF 100 Speed M

Article no. **6766**



with chip breaker • re-inforced core from Ø 6 mm • centre cutting

Cutting data page 678

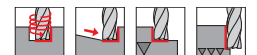
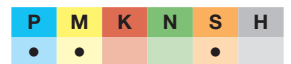

Ratio end mills RF 100 Speed M

Article no. **6761**



with chip breaker • re-inforced core from Ø 6 mm • centre cutting

Cutting data page 678

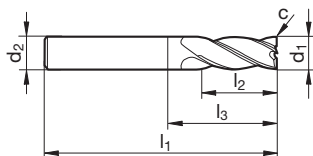
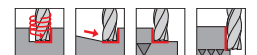
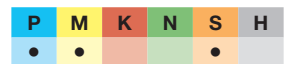

Article no.		6766	6761
		Order no.	
d1 h10 mm	d2 h6 mm		
3.00	6.00	6766 3.000	6761 3.000
4.00	6.00	6766 4.000	6761 4.000
5.00	6.00	6766 5.000	6761 5.000
6.00	6.00	6766 6.000	6761 6.000
8.00	8.00	6766 8.000	6761 8.000
10.00	10.00	6766 10.000	6761 10.000
12.00	12.00	6766 12.000	6761 12.000
16.00	16.00	6766 16.000	6761 16.000
20.00	20.00	6766 20.000	6761 20.000



Ratio end mill sets RF 100 Speed M

Article no. 6778



slotting up to max. 0.8xD depth • re-inforced core from Ø 6 mm • centre cutting • consisting of art. no. 6765

Cutting data page 678

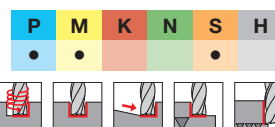

High-performance milling cutters

Article no. **6778**

Ø-range mm	Pieces/set	Order no.
6/8/10/12/16	5	6778 1.000
6/8/10/12	4	6778 2.000
6.0	5	6778 6.000
8.0	5	6778 8.000
10.0	3	6778 10.000
12.0	3	6778 12.000
16.0	3	6778 16.000

Ratio end mill sets RF 100 Speed M

Article no. 6780



slotting up to max. 0.8xD depth • re-inforced core from Ø 6 mm • centre cutting • consisting of art. no. 6760

Cutting data page 678

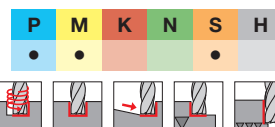

Article no. **6780**

Ø-range mm	Pieces/set	Order no.
6/8/10/12/16	5	6780 1.000
6/8/10/12	4	6780 2.000
6.0	5	6780 6.000
8.0	5	6780 8.000
10.0	3	6780 10.000
12.0	3	6780 12.000
16.0	3	6780 16.000



High-performance milling cutters

Ratio end mills RF 100 Speed P

Article no. **6958**



Cutting data page 678



with chip breaker • slotting up to max. 0.8xD depth • re-inforced core from Ø 6 mm • centre cutting

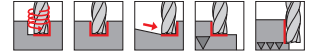
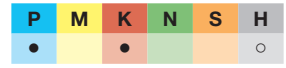

Ratio end mills RF 100 Speed P

Article no. **6959**



Cutting data page 678



with chip breaker • slotting up to max. 0.8xD depth • re-inforced core from Ø 6 mm • centre cutting

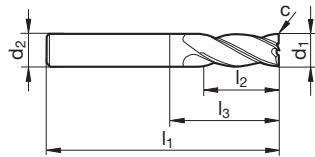
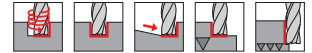
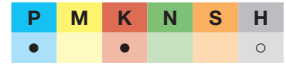

Article no.

6958

6959

d1 h10 mm	d2 h6 mm	l1 mm	l2 mm	l3 mm	c mm x 45°	Z
6.00	6.00	57	15.0	21.0	0.12	4
8.00	8.00	63	20.0	27.0	0.16	4
10.00	10.00	72	24.0	32.0	0.20	4
12.00	12.00	83	28.0	38.0	0.24	4
16.00	16.00	92	36.0	44.0	0.32	4
20.00	20.00	104	45.0	54.0	0.40	4
25.00	25.00	121	55.0	65.0	0.50	4

Order no.	
6958 6.000	6959 6.000
6958 8.000	6959 8.000
6958 10.000	6959 10.000
6958 12.000	6959 12.000
6958 16.000	6959 16.000
6958 20.000	6959 20.000
6958 25.000	6959 25.000

Ratio end mills RF 100 Speed P

Article no. **6960**



Cutting data page 678



with chip breaker • re-inforced core from Ø 6 mm • centre cutting

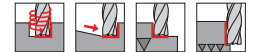
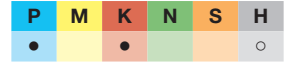

Ratio end mills RF 100 Speed P

Article no. **6961**



Cutting data page 678



with chip breaker • re-inforced core from Ø 6 mm • centre cutting

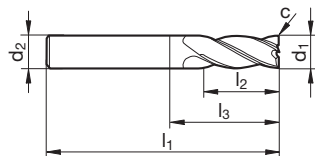
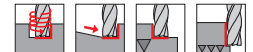
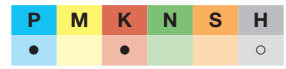

Article no.

6960

6961

d1 h10 mm	d2 h6 mm	l1 mm	l2 mm	l3 mm	c mm x 45°	Z
6.00	6.00	65	24.0	29.0	0.12	4
8.00	8.00	75	32.0	39.0	0.16	4
10.00	10.00	90	40.0	50.0	0.20	4
12.00	12.00	100	46.0	55.0	0.24	4
16.00	16.00	108	55.0	60.0	0.32	4
20.00	20.00	126	65.0	76.0	0.40	4
25.00	25.00	150	85.0	94.0	0.50	4

Order no.	
6960 6.000	6961 6.000
6960 8.000	6961 8.000
6960 10.000	6961 10.000
6960 12.000	6961 12.000
6960 16.000	6961 16.000
6960 20.000	6961 20.000
6960 25.000	6961 25.000



Ratio end mills RF 100 5 Speed

Article no. 6856



with chip breaker • neck clearance • without centre cutting

Cutting data page 678

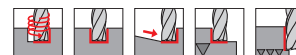

Ratio end mills RF 100 5 Speed

Article no. 6857



with chip breaker • neck clearance • without centre cutting

Cutting data page 678

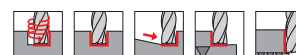

High-performance milling cutters

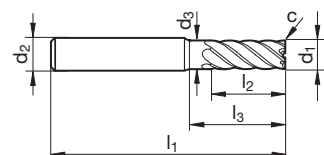

Article no. **6856** **6857**

d1 h10 mm	d2 h6 mm	d3 mm	l1 mm	l2 mm	l3 mm	c mm x 45°	Z	Order no.
6.00	6.00	5.70	57	13.0	20.0	0.12	5	6856 6.000 6857 6.000
8.00	8.00	7.70	63	19.0	26.0	0.16	5	6856 8.000 6857 8.000
10.00	10.00	9.50	72	22.0	30.0	0.20	5	6856 10.000 6857 10.000
12.00	12.00	11.50	83	26.0	36.0	0.24	5	6856 12.000 6857 12.000
16.00	16.00	15.50	92	32.0	42.0	0.32	5	6856 16.000 6857 16.000
20.00	20.00	19.50	104	38.0	52.0	0.40	5	6856 20.000 6857 20.000

Ratio end mills RF 100 5 Speed

Article no. 6858



with chip breaker • neck clearance • without centre cutting

Cutting data page 678

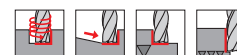
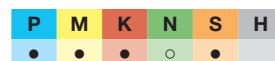

Ratio end mills RF 100 5 Speed

Article no. 6859



with chip breaker • neck clearance • without centre cutting

Cutting data page 678

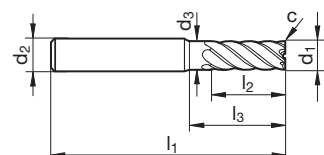
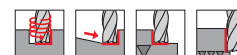

Article no. **6858** **6859**

d1 h10 mm	d2 h6 mm	d3 mm	l1 mm	l2 mm	l3 mm	c mm x 45°	Z	Order no.
6.00	6.00	5.70	65	20.0	28.0	0.12	5	6858 6.000 6859 6.000
8.00	8.00	7.70	75	26.0	38.0	0.16	5	6858 8.000 6859 8.000
10.00	10.00	9.50	80	32.0	38.0	0.20	5	6858 10.000 6859 10.000
12.00	12.00	11.50	93	40.0	46.0	0.24	5	6858 12.000 6859 12.000
16.00	16.00	15.50	108	50.0	58.0	0.32	5	6858 16.000 6859 16.000
20.00	20.00	19.50	126	62.0	74.0	0.40	5	6858 20.000 6859 20.000



Ratio end mills RF 100 5 Speed

Article no. **6860**



Cutting data page 678



with chip breaker • neck clearance • without centre cutting

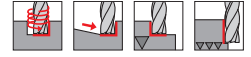

Ratio end mills RF 100 5 Speed

Article no. **6861**



Cutting data page 678



with chip breaker • neck clearance • without centre cutting

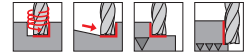

High-performance milling cutters

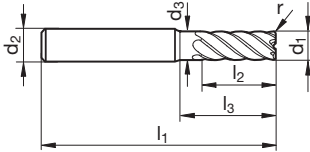

Article no.

6860

6861

d1 h10 mm	d2 h6 mm	d3 mm	l1 mm	l2 mm	l3 mm	r mm	Z	Order no.
6.00	6.00	5.70	65	20.0	28.0	0.20	5	6860 6.002 6861 6.002
6.00	6.00	5.70	65	20.0	28.0	0.50	5	6860 6.005 6861 6.005
6.00	6.00	5.70	65	20.0	28.0	1.00	5	6860 6.010 6861 6.010
8.00	8.00	7.70	75	26.0	38.0	0.30	5	6860 8.003 6861 8.003
8.00	8.00	7.70	75	26.0	38.0	0.50	5	6860 8.005 6861 8.005
8.00	8.00	7.70	75	26.0	38.0	1.00	5	6860 8.010 6861 8.010
8.00	8.00	7.70	75	26.0	38.0	1.50	5	6860 8.015 6861 8.015
10.00	10.00	9.50	80	32.0	38.0	0.50	5	6860 10.005 6861 10.005
10.00	10.00	9.50	80	32.0	38.0	1.00	5	6860 10.010 6861 10.010
10.00	10.00	9.50	80	32.0	38.0	1.50	5	6860 10.015 6861 10.015
10.00	10.00	9.50	80	32.0	38.0	2.00	5	6860 10.020 6861 10.020
12.00	12.00	11.50	93	40.0	46.0	0.50	5	6860 12.005 6861 12.005
12.00	12.00	11.50	93	40.0	46.0	1.00	5	6860 12.010 6861 12.010
12.00	12.00	11.50	93	40.0	46.0	1.50	5	6860 12.015 6861 12.015
12.00	12.00	11.50	93	40.0	46.0	2.00	5	6860 12.020 6861 12.020
16.00	16.00	15.50	108	50.0	58.0	0.50	5	6860 16.005 6861 16.005
16.00	16.00	15.50	108	50.0	58.0	1.00	5	6860 16.010 6861 16.010
16.00	16.00	15.50	108	50.0	58.0	1.50	5	6860 16.015 6861 16.015
16.00	16.00	15.50	108	50.0	58.0	2.00	5	6860 16.020 6861 16.020
16.00	16.00	15.50	108	50.0	58.0	3.00	5	6860 16.030 6861 16.030
20.00	20.00	19.50	126	62.0	74.0	1.00	5	6860 20.010 6861 20.010
20.00	20.00	19.50	126	62.0	74.0	1.50	5	6860 20.015 6861 20.015
20.00	20.00	19.50	126	62.0	74.0	2.00	5	6860 20.020 6861 20.020
20.00	20.00	19.50	126	62.0	74.0	3.00	5	6860 20.030 6861 20.030



Ratio end mills RF 100 7 Speed

Article no. **6864**



with chip breaker • neck clearance • without centre cutting

Cutting data page 678

P	M	K	N	S	H
●	●	●	○	●	

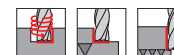

Ratio end mills RF 100 7 Speed

Article no. **6865**



with chip breaker • neck clearance • without centre cutting

Cutting data page 678

P	M	K	N	S	H
●	●	●	○	●	

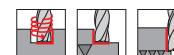

High-performance milling cutters

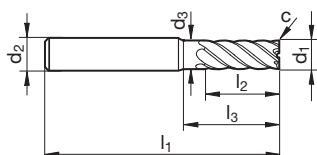

Article no.

6864

6865

d1 h10 mm	d2 h6 mm	d3 mm	l1 mm	l2 mm	l3 mm	c mm x 45°	Z	Order no.	
6.00	6.00	5.70	65	20.0	28.0	0.12	7	6864 6.000	6865 6.000
8.00	8.00	7.70	75	26.0	38.0	0.16	7	6864 8.000	6865 8.000
10.00	10.00	9.50	80	32.0	38.0	0.20	7	6864 10.000	6865 10.000
12.00	12.00	11.50	93	40.0	46.0	0.24	7	6864 12.000	6865 12.000
16.00	16.00	15.50	108	50.0	58.0	0.32	7	6864 16.000	6865 16.000
20.00	20.00	19.50	126	62.0	74.0	0.40	7	6864 20.000	6865 20.000



High-performance milling cutters

Ratio end mills Superfinish RF 100 SF

Article no. **6727**



Cutting data page 682



P	M	K	N	S	H
•	•	•	•	•	○

neck clearance • centre cutting

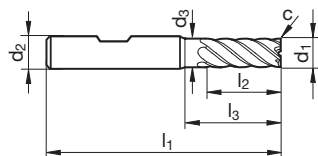

Article no. **6727**

d1 h10 mm	d2 h6 mm	d3 mm	l1 mm	l2 mm	l3 mm	c mm x 45°	Z	Order no.
8.00	8.00	7.70	63	19.0	26.0	0.10	6	6727 8.000
10.00	10.00	9.50	72	22.0	30.0	0.10	6	6727 10.000
12.00	12.00	11.50	83	26.0	36.0	0.10	6	6727 12.000
16.00	16.00	15.50	92	32.0	42.0	0.15	6	6727 16.000
20.00	20.00	19.50	104	38.0	52.0	0.15	6	6727 20.000

Ratio end mills Superfinish RF 100 SF

Article no. **3631**



Cutting data page 682



P	M	K	N	S	H
•	•	•	•	•	○

neck clearance • centre cutting



Ratio end mills Superfinish RF 100 SF

Article no. **3632**



Cutting data page 682



P	M	K	N	S	H
•	•	•	•	•	○

neck clearance • centre cutting

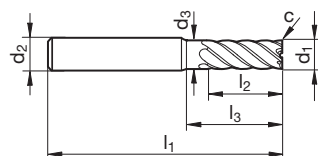

Article no. **3631** | **3632**

d1 h10 mm	d2 h6 mm	d3 mm	l1 mm	l2 mm	l3 mm	c mm x 45°	Z	Order no.
8.00	8.00	7.70	63	19.0	26.0	0.10	6	3631 8.000 3632 8.000
10.00	10.00	9.50	72	22.0	30.0	0.10	6	3631 10.000 3632 10.000
12.00	12.00	11.50	83	26.0	36.0	0.10	6	3631 12.000 3632 12.000
16.00	16.00	15.50	92	32.0	42.0	0.15	6	3631 16.000 3632 16.000
20.00	20.00	19.50	104	38.0	52.0	0.15	6	3631 20.000 3632 20.000
25.00	25.00	24.00	121	45.0	63.0	0.20	6	3631 25.000 3632 25.000



Ratio end mills Superfinish RF 100 SF

Article no. 6709



Cutting data page 682



neck clearance • centre cutting

P	M	K	N	S	H
•	•	•	•	•	○



Ratio end mills Superfinish RF 100 SF

Article no. 6710



Cutting data page 682



neck clearance • centre cutting

P	M	K	N	S	H
•	•	•	•	•	○



High-performance milling cutters

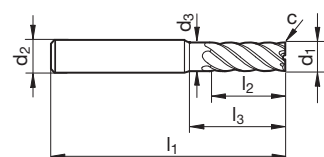

Article no. **6709** **6710**

d1 h10 mm	d2 h6 mm	d3 mm	l1 mm	l2 mm	l3 mm	c mm x 45°	Z	Order no.
4.00	6.00	3.80	57	11.0	18.0	0.05	5	6709 4.000 6710 4.000
5.00	6.00	4.80	57	13.0	18.0	0.05	5	6709 5.000 6710 5.000
6.00	6.00	5.70	57	13.0	20.0	0.05	5	6709 6.000 6710 6.000
8.00	8.00	7.70	63	19.0	26.0	0.10	5	6709 8.000 6710 8.000
10.00	10.00	9.50	72	22.0	30.0	0.10	5	6709 10.000 6710 10.000
12.00	12.00	11.50	83	26.0	36.0	0.10	5	6709 12.000 6710 12.000
16.00	16.00	15.50	92	32.0	42.0	0.15	5	6709 16.000 6710 16.000
20.00	20.00	19.50	104	38.0	52.0	0.15	5	6709 20.000 6710 20.000
25.00	25.00	24.00	121	45.0	63.0	0.20	5	6709 25.000 6710 25.000

Ratio end mills Superfinish RF 100 SF

Article no. 3897



Cutting data page 682



neck clearance • centre cutting

P	M	K	N	S	H
•	•	•	•	•	○



Ratio end mills Superfinish RF 100 SF

Article no. 3898



Cutting data page 682



neck clearance • centre cutting

P	M	K	N	S	H
•	•	•	•	•	○

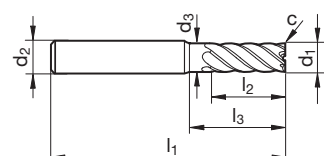

Article no. **3897** **3898**

d1 h10 mm	d2 h6 mm	d3 mm	l1 mm	l2 mm	l3 mm	c mm x 45°	Z	Order no.
4.00	6.00	3.80	65	12.0	26.0	0.05	5	3897 4.000 3898 4.000
5.00	6.00	4.80	65	15.0	26.0	0.05	5	3897 5.000 3898 5.000
6.00	6.00	5.70	65	18.0	28.0	0.05	5	3897 6.000 3898 6.000
8.00	8.00	7.70	75	24.0	38.0	0.10	5	3897 8.000 3898 8.000
10.00	10.00	9.50	80	30.0	38.0	0.10	5	3897 10.000 3898 10.000
12.00	12.00	11.50	93	36.0	46.0	0.10	5	3897 12.000 3898 12.000
16.00	16.00	15.50	108	48.0	58.0	0.15	5	3897 16.000 3898 16.000
20.00	20.00	19.50	126	60.0	74.0	0.15	5	3897 20.000 3898 20.000



90° Ratio end mills Superfinish RF 100 SF

Article no. **6763**



Cutting data page 682

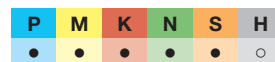

without corner protection chamfer • neck clearance • centre cutting



High-performance milling cutters

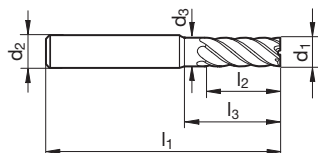

Article no.

6763

d1 h10 mm	d2 h6 mm	d3 mm	l1 mm	l2 mm	l3 mm	Z	Order no.
4.00	6.00	3.80	65	12.0	26.0	5	6763 4.000
5.00	6.00	4.80	65	15.0	26.0	5	6763 5.000
6.00	6.00	5.70	65	18.0	28.0	5	6763 6.000
8.00	8.00	7.70	75	24.0	38.0	5	6763 8.000
10.00	10.00	9.50	80	30.0	38.0	5	6763 10.000
12.00	12.00	11.50	93	36.0	46.0	5	6763 12.000
16.00	16.00	15.50	108	48.0	58.0	5	6763 16.000
20.00	20.00	19.50	126	60.0	74.0	5	6763 20.000



Multi-tooth end mills GH 100 U

Article no. 3689



Cutting data page 686

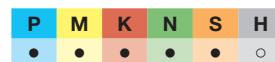

centre cutting



Multi-tooth end mills GH 100 U

Article no. 3047



Cutting data page 686



centre cutting



High-performance milling cutters

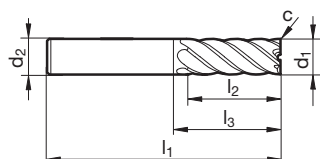

Article no.

3689

3047

d1 h10 mm	d2 h6 mm	l1 mm	l2 mm	l3 mm	c mm x 45°	Z	Order no.
3.00	6.00	57	8.0	10.1	0.05	6	3689 3.000
4.00	6.00	57	11.0	13.5	0.05	6	3689 4.000
5.00	6.00	57	13.0	15.9	0.05	6	3689 5.000
6.00	6.00	57	13.0	21.0	0.05	6	3689 6.000 3047 6.000
8.00	8.00	63	19.0	27.0	0.10	6	3689 8.000 3047 8.000
10.00	10.00	72	22.0	32.0	0.10	6	3689 10.000 3047 10.000
12.00	12.00	83	26.0	38.0	0.10	6	3689 12.000 3047 12.000
14.00	14.00	83	26.0	38.0	0.15	6	3689 14.000 3047 14.000
14.00	16.00	92	32.0	39.6	0.15	6	3689 14.001
16.00	16.00	92	32.0	44.0	0.15	6	3689 16.000 3047 16.000
18.00	18.00	92	32.0	44.0	0.15	8	3689 18.000 3047 18.000
18.00	20.00	104	38.0	46.4	0.15	8	3689 18.001
20.00	20.00	104	38.0	54.0	0.15	8	3689 20.000 3047 20.000
25.00	25.00	121	45.0	65.0	0.20	10	3689 25.000 3047 25.000
25.00	25.00	121	45.0	65.0	0.20	8	3047 25.001
32.00	32.00	133	53.0	73.0	0.30	8	3047 32.000



Multi-tooth end mills GH 100 U

Article no. **3691**



Cutting data page 686



centre cutting

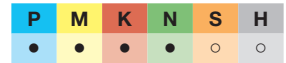

Multi-tooth end mills GH 100 U

Article no. **3693**



Cutting data page 686



centre cutting



High-performance milling cutters

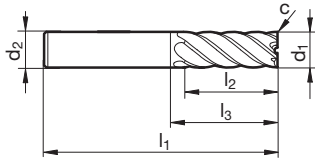

Article no.

3691

3693

d1 h10 mm	d2 h6 mm	l1 mm	l2 mm	l3 mm	c mm x 45°	Z
4.00	6.00	65	16.0	18.5	0.05	6
5.00	6.00	65	18.0	20.9	0.05	6
6.00	6.00	75	30.0	39.0	0.05	6
8.00	8.00	100	40.0	64.0	0.10	6
10.00	10.00	100	40.0	60.0	0.10	6
12.00	12.00	150	45.0	105.0	0.10	6
16.00	16.00	150	65.0	102.0	0.15	6
20.00	20.00	150	65.0	100.0	0.15	8
25.00	25.00	150	75.0	94.0	0.20	10
25.00	25.00	150	75.0	94.0	0.20	8
32.00	32.00	186	106.0	126.0	0.30	8

Order no.
3693 4.000
3693 5.000
3691 6.000
3693 6.000
3691 8.000
3693 8.000
3691 10.000
3693 10.000
3691 12.000
3693 12.000
3691 16.000
3693 16.000
3691 20.000
3693 20.000
3691 25.000
3693 25.000
3693 25.001
3693 32.000



Ratio end mills Alu RF 100 A

Article no. 6980



with internal cooling: radial and axial exits • nano polished cutting edges • neck clearance • centre cutting

Cutting data page 696

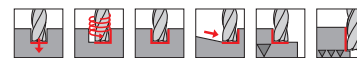
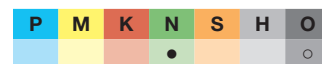

Ratio end mills Alu RF 100 A

Article no. 6981



with internal cooling: radial and axial exits • nano polished cutting edges • neck clearance • centre cutting

Cutting data page 696

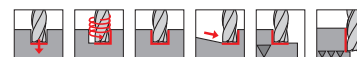

High-performance milling cutters

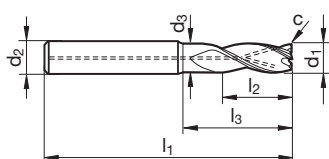

Article no. 6980 6981

d1 e8 mm	d2 h6 mm	d3 mm	l1 mm	l2 mm	l3 mm	c mm x 45°	Z	Order no.
5.00	6.00	4.80	57	13.0	18.0	0.05	3	6980 5.000 6981 5.000
6.00	6.00	5.70	57	13.0	20.0	0.06	3	6980 6.000 6981 6.000
8.00	8.00	7.70	63	19.0	26.0	0.08	3	6980 8.000 6981 8.000
10.00	10.00	9.50	72	22.0	30.0	0.10	3	6980 10.000 6981 10.000
12.00	12.00	11.50	83	26.0	36.0	0.12	3	6980 12.000 6981 12.000
16.00	16.00	15.50	92	32.0	42.0	0.16	3	6980 16.000 6981 16.000
20.00	20.00	19.50	104	38.0	52.0	0.20	3	6980 20.000 6981 20.000



Ratio end mills Alu RF 100 A

Article no. **6978**



Cutting data page 696



nano polished cutting edges • neck clearance • centre cutting

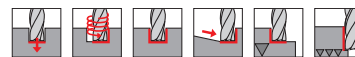

Ratio end mills Alu RF 100 A

Article no. **6979**



Cutting data page 696



nano polished cutting edges • neck clearance • centre cutting



High-performance milling cutters

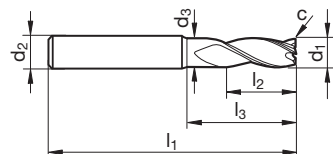

Article no. **6978** **6979**

d1 e8 mm	d2 h6 mm	d3 mm	l1 mm	l2 mm	l3 mm	c mm x 45°	Z	Order no.
3.00	6.00	2.80	57	8.0	15.0	0.06	3	6978 3.000 6979 3.000
4.00	6.00	3.80	57	11.0	18.0	0.04	3	6978 4.000 6979 4.000
5.00	6.00	4.80	57	13.0	18.0	0.05	3	6978 5.000 6979 5.000
6.00	6.00	5.70	57	13.0	20.0	0.06	3	6978 6.000 6979 6.000
8.00	8.00	7.70	63	19.0	26.0	0.08	3	6978 8.000 6979 8.000
10.00	10.00	9.50	72	22.0	30.0	0.10	3	6978 10.000 6979 10.000
12.00	12.00	11.50	83	26.0	36.0	0.12	3	6978 12.000 6979 12.000
16.00	16.00	15.50	92	32.0	42.0	0.16	3	6978 16.000 6979 16.000
20.00	20.00	19.50	104	38.0	52.0	0.20	3	6978 20.000 6979 20.000



Ratio end mills Alu RF 100 A

Article no. 3472



Cutting data page 696



nano polished cutting edges • neck clearance • centre cutting

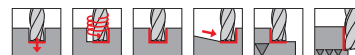
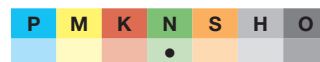

Ratio end mills Alu RF 100 A

Article no. 6702



Cutting data page 696



nano polished cutting edges • neck clearance • centre cutting



High-performance milling cutters

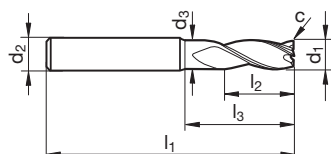

Article no. 3472 6702

d1 e8 mm	d2 h6 mm	d3 mm	l1 mm	l2 mm	l3 mm	c mm x 45°	Z	Order no.
3.00	6.00	2.80	57	8.0	15.0	0.03	3	3472 3.000 6702 3.000
4.00	6.00	3.80	57	11.0	18.0	0.04	3	3472 4.000 6702 4.000
5.00	6.00	4.80	57	13.0	18.0	0.05	3	3472 5.000 6702 5.000
6.00	6.00	5.70	57	13.0	20.0	0.06	3	3472 6.000 6702 6.000
8.00	8.00	7.70	63	19.0	26.0	0.08	3	3472 8.000 6702 8.000
10.00	10.00	9.50	72	22.0	30.0	0.10	3	3472 10.000 6702 10.000
12.00	12.00	11.50	83	26.0	36.0	0.12	3	3472 12.000 6702 12.000
16.00	16.00	15.50	92	32.0	42.0	0.16	3	3472 16.000 6702 16.000
20.00	20.00	19.50	104	38.0	52.0	0.20	3	3472 20.000 6702 20.000



Ratio end mills Alu RF 100 A

Article no. **6982**



Cutting data page 696



with internal cooling: radial and axial exits • nano polished cutting edges • neck clearance • centre cutting

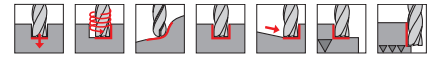

Ratio end mills Alu RF 100 A

Article no. **6983**



Cutting data page 696



with internal cooling: radial and axial exits • nano polished cutting edges • neck clearance • centre cutting

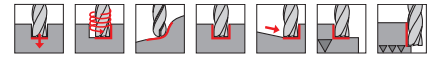

High-performance milling cutters

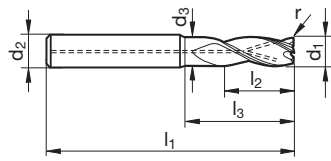

Article no.

6982

6983

d1 e8 mm	d2 h6 mm	d3 mm	l1 mm	l2 mm	l3 mm	r mm	Z	Order no.	
6.00	6.00	5.70	57	13.0	20.0	0.50	3	6982 6.005	6983 6.005
6.00	6.00	5.70	57	13.0	20.0	1.00	3	6982 6.010	6983 6.010
8.00	8.00	7.70	63	19.0	26.0	0.50	3	6982 8.005	6983 8.005
8.00	8.00	7.70	63	19.0	26.0	1.00	3	6982 8.010	6983 8.010
10.00	10.00	9.50	72	22.0	30.0	0.50	3	6982 10.005	6983 10.005
10.00	10.00	9.50	72	22.0	30.0	1.00	3	6982 10.010	6983 10.010
10.00	10.00	9.50	72	22.0	30.0	1.50	3	6982 10.015	6983 10.015
12.00	12.00	11.50	83	26.0	36.0	0.50	3	6982 12.005	6983 12.005
12.00	12.00	11.50	83	26.0	36.0	1.00	3	6982 12.010	6983 12.010
12.00	12.00	11.50	83	26.0	36.0	1.50	3	6982 12.015	6983 12.015
12.00	12.00	11.50	83	26.0	36.0	2.00	3	6982 12.020	6983 12.020
12.00	12.00	11.50	83	26.0	36.0	2.50	3	6982 12.025	6983 12.025
12.00	12.00	11.50	83	26.0	36.0	3.00	3	6982 12.030	6983 12.030
12.00	12.00	11.50	83	26.0	36.0	4.00	3	6982 12.040	6983 12.040
16.00	16.00	15.50	92	32.0	42.0	1.00	3	6982 16.010	6983 16.010
16.00	16.00	15.50	92	32.0	42.0	2.00	3	6982 16.020	6983 16.020
16.00	16.00	15.50	92	32.0	42.0	2.50	3	6982 16.025	6983 16.025
16.00	16.00	15.50	92	32.0	42.0	3.00	3	6982 16.030	6983 16.030
16.00	16.00	15.50	92	32.0	42.0	4.00	3	6982 16.040	6983 16.040
20.00	20.00	19.50	104	38.0	52.0	1.00	3	6982 20.010	6983 20.010
20.00	20.00	19.50	104	38.0	52.0	2.00	3	6982 20.020	6983 20.020
20.00	20.00	19.50	104	38.0	52.0	3.00	3	6982 20.030	6983 20.030
20.00	20.00	19.50	104	38.0	52.0	4.00	3	6982 20.040	6983 20.040



Ratio end mills Alu RF 100 A

Article no. 3599



Cutting data page 696



nano polished cutting edges • neck clearance • centre cutting

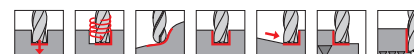
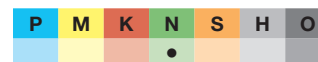

Ratio end mills Alu RF 100 A

Article no. 6729



Cutting data page 696



nano polished cutting edges • neck clearance • centre cutting

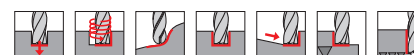

High-performance milling cutters

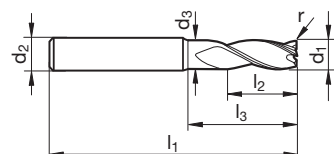

Article no.

3599

6729

d1 e8 mm	d2 h6 mm	d3 mm	l1 mm	l2 mm	l3 mm	r mm	Z	Order no.	
6.00	6.00	5.70	57	13.0	20.0	0.50	3	3599 6.005	6729 6.005
6.00	6.00	5.70	57	13.0	20.0	1.00	3	3599 6.010	6729 6.010
8.00	8.00	7.70	63	19.0	26.0	0.50	3	3599 8.005	6729 8.005
8.00	8.00	7.70	63	19.0	26.0	1.00	3	3599 8.010	6729 8.010
10.00	10.00	9.50	72	22.0	30.0	0.50	3	3599 10.005	6729 10.005
10.00	10.00	9.50	72	22.0	30.0	1.00	3	3599 10.010	6729 10.010
10.00	10.00	9.50	72	22.0	30.0	1.50	3	3599 10.015	6729 10.015
12.00	12.00	11.50	83	26.0	36.0	0.50	3	3599 12.005	6729 12.005
12.00	12.00	11.50	83	26.0	36.0	1.00	3	3599 12.010	6729 12.010
12.00	12.00	11.50	83	26.0	36.0	1.50	3	3599 12.015	6729 12.015
12.00	12.00	11.50	83	26.0	36.0	2.00	3	3599 12.020	6729 12.020
12.00	12.00	11.50	83	26.0	36.0	2.50	3	3599 12.025	6729 12.025
12.00	12.00	11.50	83	26.0	36.0	3.00	3	3599 12.030	6729 12.030
12.00	12.00	11.50	83	26.0	36.0	4.00	3	3599 12.040	6729 12.040
16.00	16.00	15.50	92	32.0	42.0	1.00	3	3599 16.010	6729 16.010
16.00	16.00	15.50	92	32.0	42.0	2.00	3	3599 16.020	6729 16.020
16.00	16.00	15.50	92	32.0	42.0	2.50	3	3599 16.025	6729 16.025
16.00	16.00	15.50	92	32.0	42.0	3.00	3	3599 16.030	6729 16.030
16.00	16.00	15.50	92	32.0	42.0	4.00	3	3599 16.040	6729 16.040
20.00	20.00	19.50	104	38.0	52.0	1.00	3	3599 20.010	6729 20.010
20.00	20.00	19.50	104	38.0	52.0	2.00	3	3599 20.020	6729 20.020
20.00	20.00	19.50	104	38.0	52.0	2.50	3	3599 20.025	6729 20.025
20.00	20.00	19.50	104	38.0	52.0	3.00	3	3599 20.030	6729 20.030
20.00	20.00	19.50	104	38.0	52.0	4.00	3	3599 20.040	6729 20.040
25.00	25.00	24.00	121	45.0	63.0	2.00	3	3599 25.020	6729 25.020
25.00	25.00	24.00	121	45.0	63.0	3.00	3	3599 25.030	6729 25.030
25.00	25.00	24.00	121	45.0	63.0	4.00	3	3599 25.040	6729 25.040



High-performance milling cutters

Ratio end mills Alu RF 100 A

Article no. **3473**



Cutting data page 696



nano polished cutting edges • neck clearance • centre cutting

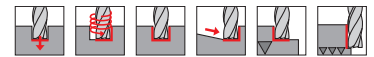

Ratio end mills Alu RF 100 A

Article no. **6703**



Cutting data page 696



nano polished cutting edges • neck clearance • centre cutting

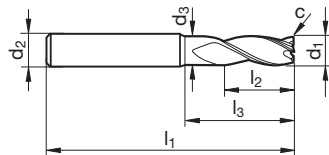
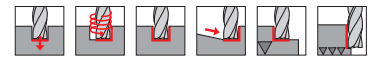

Article no. **3473** **6703**

d1 e8 mm	d2 h6 mm	d3 mm	l1 mm	l2 mm	l3 mm	c mm x 45°	Z	Order no.
6.00	6.00	5.50	65	13.0	28.0	0.06	3	3473 6.000 6703 6.000
8.00	8.00	7.50	75	19.0	38.0	0.08	3	3473 8.000 6703 8.000
10.00	10.00	9.20	80	22.0	38.0	0.10	3	3473 10.000 6703 10.000
12.00	12.00	11.20	93	26.0	46.0	0.12	3	3473 12.000 6703 12.000
16.00	16.00	15.00	108	32.0	58.0	0.16	3	3473 16.000 6703 16.000
20.00	20.00	19.00	126	38.0	74.0	0.20	3	3473 20.000 6703 20.000

Ratio end mills Alu RF 100 A

Article no. **6730**



Cutting data page 696



nano polished cutting edges • re-inforced core • neck clearance • centre cutting

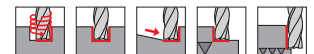

Ratio end mills Alu RF 100 A

Article no. **6731**



Cutting data page 696



nano polished cutting edges • re-inforced core • neck clearance • centre cutting

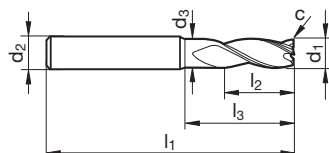
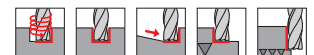

Article no. **6730** **6731**

d1 e8 mm	d2 h6 mm	d3 mm	l1 mm	l2 mm	l3 mm	c mm x 45°	Z	Order no.
5.00	6.00	4.80	57	15.0	19.4	0.05	3	6730 5.000 6731 5.000
6.00	6.00	5.70	65	18.0	28.0	0.06	3	6730 6.000 6731 6.000
8.00	8.00	7.70	75	24.0	38.0	0.08	3	6730 8.000 6731 8.000
10.00	10.00	9.50	80	30.0	38.0	0.10	3	6730 10.000 6731 10.000
12.00	12.00	11.50	93	36.0	46.0	0.12	3	6730 12.000 6731 12.000
16.00	16.00	15.50	108	48.0	58.0	0.16	3	6730 16.000 6731 16.000
20.00	20.00	19.50	126	60.0	74.0	0.20	3	6730 20.000 6731 20.000



Ratio end mills Alu RF 100 A

Article no. 6732



nano polished cutting edges • re-inforced core • centre cutting

Cutting data page 696

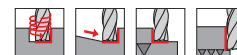
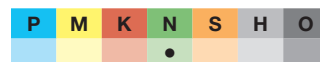

Ratio end mills Alu RF 100 A

Article no. 6733



nano polished cutting edges • re-inforced core • centre cutting

Cutting data page 696

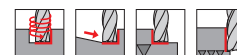

High-performance milling cutters

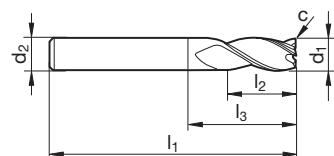

Article no. **6732** **6733**

d1 e8 mm	d2 h6 mm	l1 mm	l2 mm	l3 mm	c mm x 45°	Z	Order no.	
6.00	6.00	65	24.0	29.0	0.06	3	6732 6.000	6733 6.000
8.00	8.00	75	32.0	39.0	0.08	3	6732 8.000	6733 8.000
10.00	10.00	100	40.0	60.0	0.10	3	6732 10.000	6733 10.000
12.00	12.00	100	48.0	55.0	0.12	3	6732 12.000	6733 12.000
16.00	16.00	125	64.0	77.0	0.16	3	6732 16.000	6733 16.000
20.00	20.00	150	80.0	100.0	0.20	3	6732 20.000	6733 20.000

Ratio end mills Alu RF 100 A

Article no. 6734



nano polished cutting edges • re-inforced core • centre cutting

Cutting data page 696

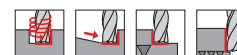
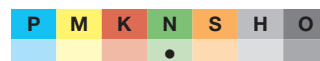

Ratio end mills Alu RF 100 A

Article no. 6735



nano polished cutting edges • re-inforced core • centre cutting

Cutting data page 696

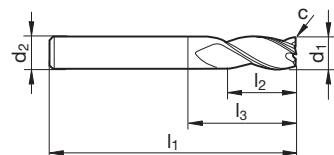
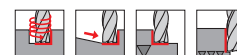

Article no. **6734** **6735**

d1 e8 mm	d2 h6 mm	l1 mm	l2 mm	l3 mm	c mm x 45°	Z	Order no.	
6.00	6.00	75	30.0	39.0	0.06	3	6734 6.000	6735 6.000
8.00	8.00	86	40.0	50.0	0.08	3	6734 8.000	6735 8.000
10.00	10.00	100	50.0	60.0	0.10	3	6734 10.000	6735 10.000
12.00	12.00	120	60.0	75.0	0.12	3	6734 12.000	6735 12.000
16.00	16.00	150	80.0	102.0	0.16	3	6734 16.000	6735 16.000
20.00	20.00	175	100.0	125.0	0.20	3	6734 20.000	6735 20.000



High-performance milling cutters

Ratio end mills Alu RF 100 A

Article no. **3202**



Cutting data page 696



neck clearance • centre cutting

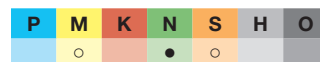

Ratio end mills Alu RF 100 A

Article no. **3319**



Cutting data page 696



neck clearance • centre cutting

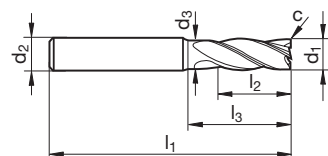

Article no.

3202

3319

d1 h10 mm	d2 h6 mm	d3 mm	l1 mm	l2 mm	l3 mm	c mm x 45°	Z	Order no.
4.00	6.00	3.80	57	11.0	18.0	0.10	4	3202 4.000 3319 4.000
5.00	6.00	4.80	57	13.0	18.0	0.10	4	3202 5.000 3319 5.000
6.00	6.00	5.70	57	13.0	20.0	0.15	4	3202 6.000 3319 6.000
8.00	8.00	7.70	63	19.0	26.0	0.15	4	3202 8.000 3319 8.000
10.00	10.00	9.50	72	22.0	30.0	0.20	4	3202 10.000 3319 10.000
12.00	12.00	11.50	83	26.0	36.0	0.20	4	3202 12.000 3319 12.000
16.00	16.00	15.50	92	32.0	42.0	0.35	4	3202 16.000 3319 16.000
20.00	20.00	19.50	104	38.0	52.0	0.45	4	3202 20.000 3319 20.000

90° Ratio end mills Alu RF 100 A

Article no. **6762**



Cutting data page 696



without corner protection chamfer • neck clearance • centre cutting

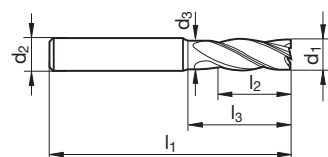
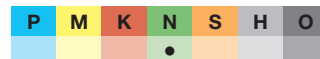

Article no.

6762

d1 h10 mm	d2 h6 mm	d3 mm	l1 mm	l2 mm	l3 mm	Z	Order no.
3.00	6.00	2.80	57	8.0	15.0	4	6762 3.000
4.00	6.00	3.80	57	11.0	18.0	4	6762 4.000
5.00	6.00	4.80	57	13.0	18.0	4	6762 5.000
6.00	6.00	5.70	57	13.0	20.0	4	6762 6.000
8.00	8.00	7.70	63	19.0	26.0	4	6762 8.000
10.00	10.00	9.50	72	22.0	30.0	4	6762 10.000
12.00	12.00	11.50	83	26.0	36.0	4	6762 12.000
16.00	16.00	15.50	92	32.0	42.0	4	6762 16.000
20.00	20.00	19.50	104	38.0	52.0	4	6762 20.000



Ratio roughing end mills Alu RF 100 A

Article no. 6974



with internal cooling: radial and axial exits • neck clearance • centre cutting

Cutting data page 697

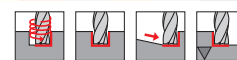
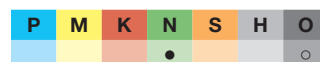

Ratio roughing end mills Alu RF 100 A

Article no. 6975



with internal cooling: radial and axial exits • neck clearance • centre cutting

Cutting data page 697

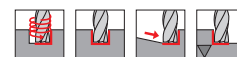
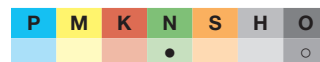

High-performance milling cutters

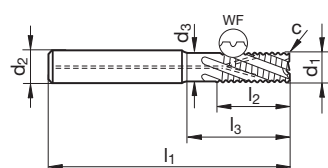

Article no.

6974

6975

d1 js9 mm	d2 h6 mm	d3 mm	l1 mm	l2 mm	l3 mm	c mm x 45°	Z	Order no.	
6.00	6.00	5.70	57	13.0	20.0	0.06	3	6974 6.000	6975 6.000
8.00	8.00	7.70	63	19.0	26.0	0.08	3	6974 8.000	6975 8.000
10.00	10.00	9.50	72	22.0	30.0	0.10	3	6974 10.000	6975 10.000
12.00	12.00	11.50	83	26.0	36.0	0.12	3	6974 12.000	6975 12.000
16.00	16.00	15.50	92	32.0	42.0	0.16	3	6974 16.000	6975 16.000
20.00	20.00	19.50	104	38.0	52.0	0.20	3	6974 20.000	6975 20.000



High-performance milling cutters

Ratio roughing end mills Alu RF 100 A

Article no. **6976**



with internal cooling: radial and axial exits • neck clearance • centre cutting

Cutting data page 697

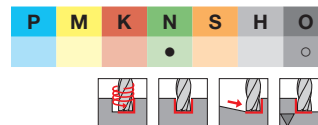

Ratio roughing end mills Alu RF 100 A

Article no. **6977**



with internal cooling: radial and axial exits • neck clearance • centre cutting

Cutting data page 697

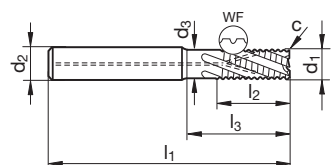
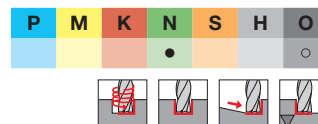

Article no. **6976** **6977**

d1 js9 mm	d2 h6 mm	d3 mm	l1 mm	l2 mm	l3 mm	c mm x 45°	Z	Order no.	
6.00	6.00	5.70	65	13.0	28.0	0.06	3	6976 6.000	6977 6.000
8.00	8.00	7.70	75	19.0	38.0	0.08	3	6976 8.000	6977 8.000
10.00	10.00	9.50	80	22.0	38.0	0.10	3	6976 10.000	6977 10.000
12.00	12.00	11.50	93	26.0	46.0	0.12	3	6976 12.000	6977 12.000
16.00	16.00	15.50	108	32.0	58.0	0.16	3	6976 16.000	6977 16.000
20.00	20.00	19.50	126	38.0	74.0	0.20	3	6976 20.000	6977 20.000

Ratio roughing end mills Alu RF 100 A

Article no. **6866**



with internal cooling: radial and axial exits • neck clearance • centre cutting

Cutting data page 697

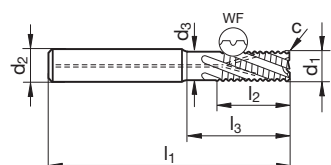
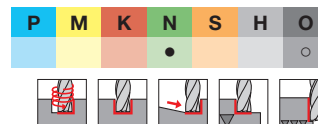

Article no. **6866**

d1 js9 mm	d2 h6 mm	d3 mm	l1 mm	l2 mm	l3 mm	c mm x 45°	Z	Order no.	
10.00	10.00	9.50	100	22.0	58.0	0.10	3	6866 10.000	
12.00	12.00	11.50	108	26.0	61.0	0.12	3	6866 12.000	
16.00	16.00	15.50	132	32.0	82.0	0.16	3	6866 16.000	
20.00	20.00	19.50	154	38.0	102.0	0.20	3	6866 20.000	
25.00	25.00	24.00	185	45.0	127.0	0.25	3	6866 25.000	



Ratio roughing end mills Alu RF 100 A

Article no. 6868



Cutting data page 697



neck clearance • centre cutting

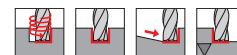
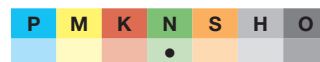

Ratio roughing end mills Alu RF 100 A

Article no. 6869



Cutting data page 697



neck clearance • centre cutting

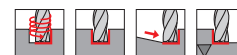

High-performance milling cutters

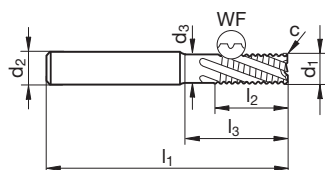

Article no.

6868

6869

d1 js9 mm	d2 h6 mm	d3 mm	l1 mm	l2 mm	l3 mm	c mm x 45°	Z	Order no.
6.00	6.00	5.70	57	13.0	20.0	0.06	3	6868 6.000 6869 6.000
8.00	8.00	7.70	63	19.0	26.0	0.08	3	6868 8.000 6869 8.000
10.00	10.00	9.50	72	22.0	30.0	0.10	3	6868 10.000 6869 10.000
12.00	12.00	11.50	83	26.0	36.0	0.12	3	6868 12.000 6869 12.000
16.00	16.00	15.50	92	32.0	42.0	0.16	3	6868 16.000 6869 16.000
20.00	20.00	19.50	104	38.0	52.0	0.20	3	6868 20.000 6869 20.000
25.00	25.00	24.00	121	45.0	63.0	0.25	3	6868 25.000 6869 25.000



Ratio roughing end mills Alu RF 100 A

Article no. **6870**



Cutting data page 697



neck clearance • centre cutting

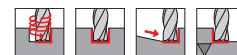
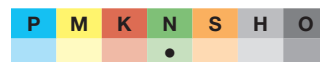

High-performance milling cutters

Ratio roughing end mills Alu RF 100 A

Article no. **6871**



Cutting data page 697



neck clearance • centre cutting

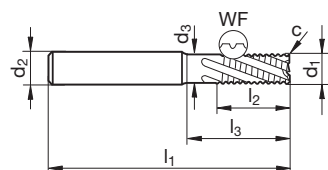
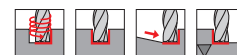
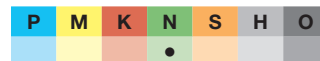

Article no.

6870

6871

d1 js9 mm	d2 h6 mm	d3 mm	l1 mm	l2 mm	l3 mm	c mm x 45°	Z	Order no.	
6.00	6.00	5.70	65	13.0	28.0	0.06	3	6870 6.000	6871 6.000
8.00	8.00	7.70	75	19.0	38.0	0.08	3	6870 8.000	6871 8.000
10.00	10.00	9.50	80	22.0	38.0	0.10	3	6870 10.000	6871 10.000
12.00	12.00	11.50	93	26.0	46.0	0.12	3	6870 12.000	6871 12.000
16.00	16.00	15.50	108	32.0	58.0	0.16	3	6870 16.000	6871 16.000
20.00	20.00	19.50	126	38.0	74.0	0.20	3	6870 20.000	6871 20.000



Ball nose end mills GA 200 A

Article no. **6984**



Cutting data page 700



neck clearance • centre cutting

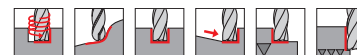
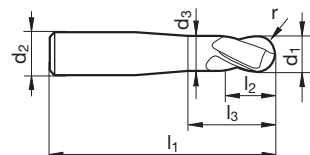

Article no. **6984**

d1 h10 mm	d2 h6 mm	d3 mm	l1 mm	l2 mm	l3 mm	r mm	Z	Order no.
3.00	6.00	2.85	57	4.0	15.0	1.50	2	6984 3.000
4.00	6.00	3.80	57	5.0	18.0	2.00	2	6984 4.000
5.00	6.00	4.80	57	6.0	18.0	2.50	2	6984 5.000
6.00	6.00	5.70	57	7.0	20.0	3.00	2	6984 6.000
8.00	8.00	7.70	63	9.0	26.0	4.00	2	6984 8.000
10.00	10.00	9.50	72	11.0	31.0	5.00	2	6984 10.000
12.00	12.00	11.50	83	12.0	37.0	6.00	2	6984 12.000
16.00	16.00	15.50	92	16.0	43.0	8.00	2	6984 16.000

High-performance milling cutters

End mills (single-fluted)

Article no. **6793**



Cutting data page 696



centre cutting • $\varnothing_{\text{cut}} \geq \varnothing_{\text{flute}}$

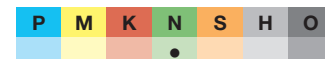
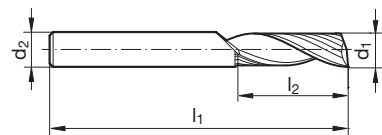

Article no. **6793**

d1 h10 mm	d2 h6 mm	l1 mm	l2 mm	Z	Order no.
2.00	2.00	38	10.0	1	6793 2.000
3.00	3.00	39	12.0	1	6793 3.000
4.00	4.00	40	15.0	1	6793 4.000
5.00	5.00	50	16.0	1	6793 5.000
6.00	6.00	57	20.0	1	6793 6.000
8.00	8.00	63	22.0	1	6793 8.000
10.00	10.00	73	25.0	1	6793 10.000
12.00	12.00	83	30.0	1	6793 12.000
16.00	16.00	92	35.0	1	6793 16.000



Al slot drills (2-fluted)

Article no. **3309**



Cutting data page 690



centre cutting

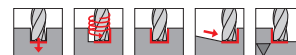
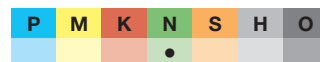

High-performance milling cutters

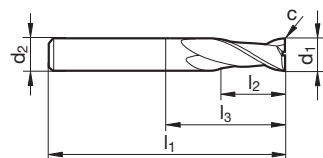

Article no. **3309**

d1 e8 mm	d2 h6 mm	l1 mm	l2 mm	l3 mm	c mm x 45°	Z	Order no.
3.00	6.00	57	7.0	10.9	0.03	2	3309 3.000
4.00	6.00	57	8.0	11.9	0.03	2	3309 4.000
5.00	6.00	57	10.0	15.4	0.03	2	3309 5.000
6.00	6.00	57	10.0	21.0	0.03	2	3309 6.000
8.00	8.00	63	16.0	27.0	0.05	2	3309 8.000
10.00	10.00	72	19.0	32.0	0.05	2	3309 10.000
12.00	12.00	83	22.0	38.0	0.10	2	3309 12.000
14.00	14.00	83	22.0	38.0	0.10	2	3309 14.000
14.00	16.00	92	26.0	37.4	0.10	2	3309 14.001
16.00	16.00	92	26.0	44.0	0.10	2	3309 16.000
18.00	18.00	92	26.0	44.0	0.10	2	3309 18.000
18.00	20.00	104	32.0	46.0	0.10	2	3309 18.001
20.00	20.00	104	32.0	54.0	0.10	2	3309 20.000

Al slot drills XL (2-fluted)

Article no. **3358**



Cutting data page 690



centre cutting

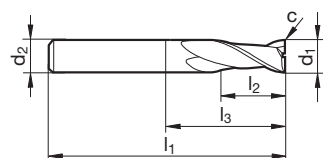
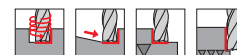

Article no. **3358**

d1 h10 mm	d2 h6 mm	l1 mm	l2 mm	l3 mm	c mm x 45°	Z	Order no.
5.00	5.00	75	30.0	47.0	0.03	2	3358 5.000
6.00	6.00	75	30.0	39.0	0.03	2	3358 6.000
8.00	8.00	100	40.0	64.0	0.05	2	3358 8.000
10.00	10.00	100	40.0	60.0	0.05	2	3358 10.000
12.00	12.00	150	45.0	105.0	0.10	2	3358 12.000
16.00	16.00	150	65.0	102.0	0.10	2	3358 16.000



Slot drills XL (3-fluted)

Article no. 6721



Cutting data page 698



for fibre-reinforced plastics (FRP) • for graphite • centre cutting

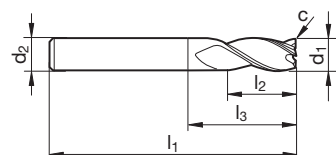
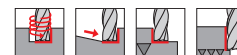
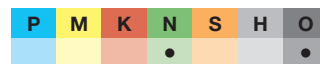

Article no. **6721**

d1 h10 mm	d2 h6 mm	l1 mm	l2 mm	l3 mm	c mm x 45°	Z	Order no.
3.00	3.00	75	20.0	47.0	0.05	3	6721 3.000
4.00	4.00	75	25.0	47.0	0.05	3	6721 4.000
5.00	5.00	75	30.0	47.0	0.05	3	6721 5.000
6.00	6.00	75	30.0	39.0	0.05	3	6721 6.000
8.00	8.00	100	40.0	64.0	0.10	3	6721 8.000
10.00	10.00	100	40.0	60.0	0.10	3	6721 10.000
12.00	12.00	150	45.0	105.0	0.10	3	6721 12.000
16.00	16.00	150	65.0	102.0	0.15	3	6721 16.000

High-performance milling cutters



Slot drills with corner radius (2-fluted)

Article no. **6722**



Cutting data page 698



for fibre-reinforced plastics (FRP) • for graphite • centre cutting

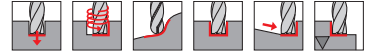

High-performance milling cutters

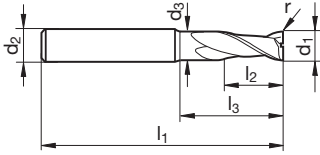

Article no. **6722**

d1 h10 mm	d2 h6 mm	d3 mm	l1 mm	l2 mm	l3 mm	r mm	Z	Order no.
6.00	6.00	5.70	57	10.0	20.0	0.50	2	6722 6.005
6.00	6.00	5.70	57	10.0	20.0	1.00	2	6722 6.010
8.00	8.00	7.70	63	16.0	26.0	0.50	2	6722 8.005
8.00	8.00	7.70	63	16.0	26.0	1.00	2	6722 8.010
10.00	10.00	9.50	72	19.0	30.0	0.50	2	6722 10.005
10.00	10.00	9.50	72	19.0	30.0	1.00	2	6722 10.010
12.00	12.00	11.50	83	22.0	36.0	0.50	2	6722 12.005
12.00	12.00	11.50	83	22.0	36.0	1.00	2	6722 12.010

End mills with corner radius (4-fluted)

Article no. **6723**



Cutting data page 698



for fibre-reinforced plastics (FRP) • for graphite • neck clearance • centre cutting

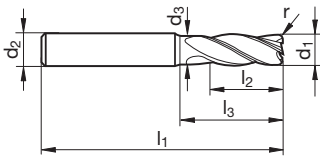
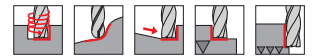

Article no. **6723**

d1 h10 mm	d2 h6 mm	d3 mm	l1 mm	l2 mm	l3 mm	r mm	Z	Order no.
6.00	6.00	5.70	57	13.0	20.0	0.50	4	6723 6.005
6.00	6.00	5.70	57	13.0	20.0	1.00	4	6723 6.010
8.00	8.00	7.70	63	19.0	26.0	0.50	4	6723 8.005
8.00	8.00	7.70	63	19.0	26.0	1.00	4	6723 8.010
10.00	10.00	9.50	72	22.0	30.0	0.50	4	6723 10.005
10.00	10.00	9.50	72	22.0	30.0	1.00	4	6723 10.010
12.00	12.00	11.50	83	26.0	36.0	0.50	4	6723 12.005
12.00	12.00	11.50	83	26.0	36.0	1.00	4	6723 12.010



Ball nose slot drills (2-fluted)

Article no. **6724**



Cutting data page 698



for fibre-reinforced plastics (FRP) • for graphite • centre cutting

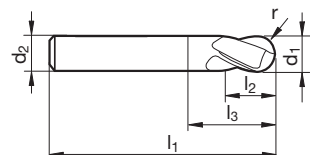
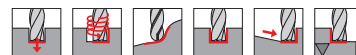
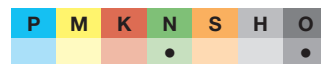

Article no. **6724**

d1 k12 mm	d2 h6 mm	l1 mm	l2 mm	l3 mm	r mm	Z	Order no.
3.00	6.00	57	7.0	11.9	1.50	2	6724 3.000
4.00	6.00	57	8.0	13.4	2.00	2	6724 4.000
5.00	6.00	57	10.0	16.9	2.50	2	6724 5.000
6.00	6.00	57	10.0	21.0	3.00	2	6724 6.000
8.00	8.00	63	16.0	27.0	4.00	2	6724 8.000
10.00	10.00	72	19.0	32.0	5.00	2	6724 10.000
12.00	12.00	83	22.0	38.0	6.00	2	6724 12.000

High-performance milling cutters

Ball nose end mills (4-fluted)

Article no. **6725**



Cutting data page 698



for fibre-reinforced plastics (FRP) • for graphite • centre cutting

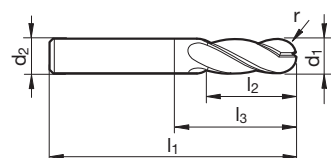
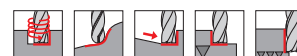
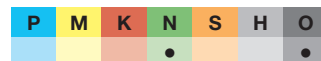

Article no. **6725**

d1 k12 mm	d2 h6 mm	l1 mm	l2 mm	l3 mm	r mm	Z	Order no.
3.00	3.00	75	20.0	47.0	1.50	4	6725 3.000
4.00	4.00	75	25.0	47.0	2.00	4	6725 4.000
5.00	5.00	75	30.0	47.0	2.50	4	6725 5.000
6.00	6.00	75	30.0	39.0	3.00	4	6725 6.000
8.00	8.00	100	40.0	64.0	4.00	4	6725 8.000
10.00	10.00	100	40.0	60.0	5.00	4	6725 10.000
12.00	12.00	150	45.0	105.0	6.00	4	6725 12.000



Kevlar end mills FR 100

Article no. **6769**



Cutting data page 698

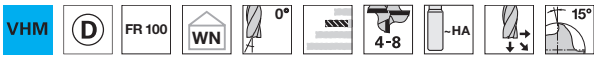

for fibre-reinforced plastics (FRP) • with face milling geometry

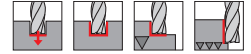
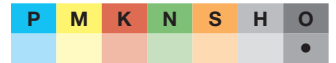

Kevlar end mills FR 100

Article no. **6805**



Cutting data page 698

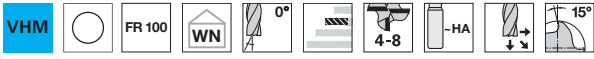

for fibre-reinforced plastics (FRP) • with face milling geometry

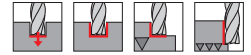
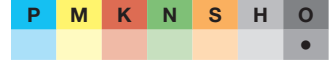

High-performance milling cutters

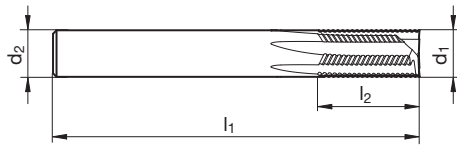

Article no.

6769

6805

d1 e10 mm	d2 h6 mm	l1 mm	l2 mm	Z
4.00	6.00	66	15.0	4
4.76	4.76	63	15.0	4
4.76	4.76	63	15.8	4
5.00	6.00	66	15.0	4
6.00	6.00	70	20.0	4
6.35	6.35	63	15.0	4
6.35	6.35	63	19.0	4
8.00	8.00	75	25.0	6
9.52	9.52	76	18.0	6
9.52	9.52	76	25.4	6
10.00	10.00	72	15.0	6
12.00	12.00	83	20.0	6
12.70	12.70	88	25.4	8
12.70	12.70	88	31.7	8

Order no.
6769 4.000
6769 4.762
6769 4.763
6769 5.000
6769 6.000
6769 6.350
6769 6.351
6769 8.000
6769 9.525
6769 9.526
6769 10.000
6769 12.000
6769 12.700
6769 12.701
6805 4.000
6805 4.762
6805 4.763
6805 5.000
6805 6.000
6805 6.350
6805 6.351
6805 8.000
6805 9.525
6805 9.526
6805 12.700
6805 12.701



Kevlar end mills FR 100

Article no. **6770**



Cutting data page 698

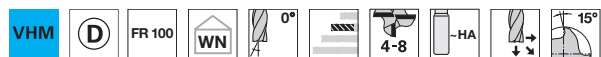

for fibre-reinforced plastics (FRP) • with drilling geometry

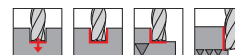
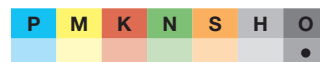

Kevlar end mills FR 100

Article no. **6806**



Cutting data page 698

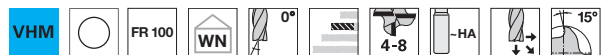

for fibre-reinforced plastics (FRP) • with drilling geometry

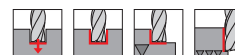
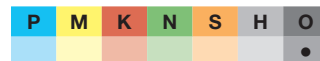

High-performance milling cutters

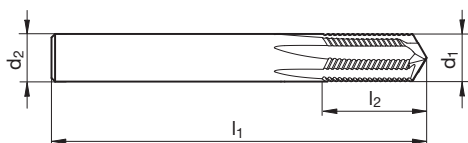

Article no. **6770** **6806**

d1 e10 mm	d2 h6 mm	l1 mm	l2 mm	Z	Order no.
4.00	6.00	66	15.0	4	6770 4.000 6806 4.000
4.76	4.76	63	15.0	4	6770 4.762 6806 4.762
4.76	4.76	63	15.8	4	6770 4.763 6806 4.763
5.00	6.00	66	15.0	4	6770 5.000 6806 5.000
6.00	6.00	70	20.0	4	6770 6.000 6806 6.000
6.35	6.35	63	15.0	4	6770 6.350 6806 6.350
6.35	6.35	63	19.0	4	6770 6.351 6806 6.351
8.00	8.00	75	25.0	6	6770 8.000 6806 8.000
9.52	9.52	76	18.0	6	6770 9.525 6806 9.525
9.52	9.52	76	25.4	6	6770 9.526 6806 9.526
10.00	10.00	72	15.0	6	6770 10.000
12.00	12.00	83	20.0	6	6770 12.000
12.70	12.70	88	25.4	8	6770 12.700 6806 12.700
12.70	12.70	88	31.7	8	6770 12.701 6806 12.701



Kevlar end mills CR 100

Article no. **6720**



Cutting data page 698

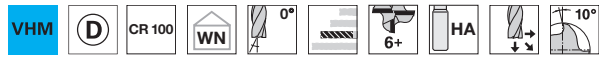

for fibre-reinforced plastics (FRP) • with drilling geometry

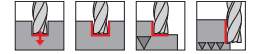
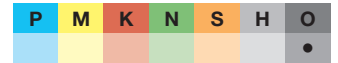

High-performance milling cutters

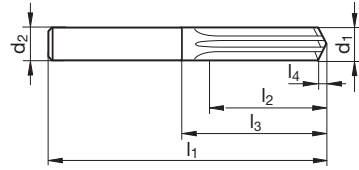

Article no. **6720**

d1 e10 mm	d2 h6 mm	l1 mm	l2 mm	l3 mm	l4 mm	Z	Order no.
4.00	4.00	55	12.0	55.0	1.3	6	6720 4.000
6.00	6.00	65	18.0	29.0	1.9	8	6720 6.000
8.00	8.00	75	24.0	39.0	2.5	10	6720 8.000
10.00	10.00	80	30.0	40.0	3.1	12	6720 10.000
12.00	12.00	93	36.0	48.0	3.7	14	6720 12.000
16.00	16.00	108	42.0	60.0	4.9	14	6720 16.000

Kevlar end mills CR 100

Article no. **6717**



Cutting data page 698



for fibre-reinforced plastics (FRP) • without centre cutting

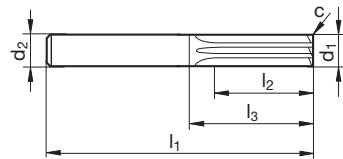
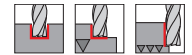
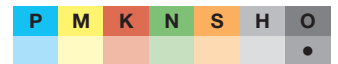

Article no. **6717**

d1 e10 mm	d2 h6 mm	l1 mm	l2 mm	l3 mm	c mm x 45°	Z	Order no.
4.00	6.00	57	10.0	19.4	0.10	6	6717 4.000
6.00	6.00	65	15.0	29.0	0.15	8	6717 6.000
8.00	8.00	75	20.0	39.0	0.15	10	6717 8.000
10.00	10.00	80	25.0	40.0	0.15	12	6717 10.000
12.00	12.00	93	32.0	48.0	0.15	14	6717 12.000
16.00	16.00	108	34.0	60.0	0.15	14	6717 16.000

Kevlar end mills CR 100

Article no. **6719**



Cutting data page 698



for fibre-reinforced plastics (FRP) • with face milling geometry

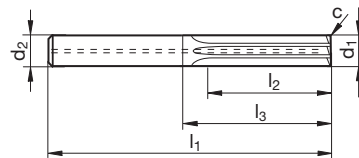
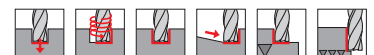
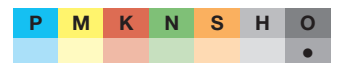

Article no. **6719**

d1 e10 mm	d2 h6 mm	l1 mm	l2 mm	l3 mm	c mm x 45°	Z	Order no.
4.00	6.00	57	10.0	19.4	0.32	6	6719 4.000
6.00	6.00	65	15.0	29.0	0.48	8	6719 6.000
8.00	8.00	75	20.0	39.0	0.64	10	6719 8.000
10.00	10.00	80	25.0	40.0	0.80	12	6719 10.000
12.00	12.00	93	32.0	48.0	0.96	14	6719 12.000
16.00	16.00	108	34.0	60.0	1.28	14	6719 16.000



PCD slot drills (2-fluted)

Article no. 5492



Cutting data page 698



for fibre-reinforced plastics (FRP) • for graphite • with internal cooling • neck clearance • centre cutting • other corner radii on request

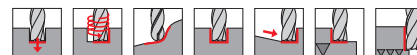
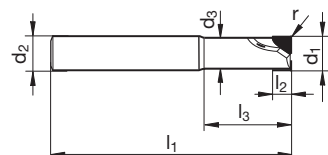

Article no. 5492

d1 mm	d1	d2 h6 mm	d3 mm	l1 mm	l2 mm	l3 mm	r mm	Z	Order no.
4.00	± 0,02	6.00	3.70	51	6.0	14.0	0.1	2	5492 4.000
5.00	± 0,02	6.00	4.70	51	8.0	14.5	0.1	2	5492 5.000
6.00	± 0,02	6.00	5.70	57	8.0	20.0	0.1	2	5492 6.000
8.00	± 0,02	8.00	7.40	63	8.0	26.0	0.1	2	5492 8.000
8.00	± 0,02	8.00	7.40	63	12.0	26.0	0.1	2	5492 8.001
10.00	± 0,02	10.00	9.40	72	8.0	30.0	0.1	2	5492 10.000
10.00	± 0,02	10.00	9.40	72	16.0	30.0	0.1	2	5492 10.001
12.00	± 0,02	12.00	11.20	83	8.0	36.0	0.1	2	5492 12.000
12.00	± 0,02	12.00	11.20	83	16.0	36.0	0.1	2	5492 12.001
14.00	± 0,02	14.00	13.00	83	8.0	36.0	0.1	2	5492 14.000
14.00	± 0,02	14.00	13.00	83	16.0	36.0	0.1	2	5492 14.001
16.00	± 0,02	16.00	15.00	100	12.0	50.0	0.1	2	5492 16.000
16.00	± 0,02	16.00	15.00	100	20.0	50.0	0.1	2	5492 16.001
18.00	± 0,02	18.00	17.00	100	12.0	50.0	0.1	2	5492 18.000
18.00	± 0,02	18.00	17.00	100	20.0	50.0	0.1	2	5492 18.001
20.00	± 0,02	20.00	19.00	100	12.0	48.0	0.1	2	5492 20.000
20.00	± 0,02	20.00	19.00	100	20.0	48.0	0.1	2	5492 20.001

High-performance milling cutters

PCD slot drills (2-fluted)

Article no. 5493



Cutting data page 698



for fibre-reinforced plastics (FRP) • for graphite • with internal cooling • neck clearance • centre cutting • other corner radii on request

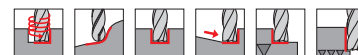
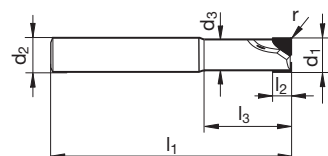

Article no. 5493

d1 mm	d1	d2 h6 mm	d3 mm	l1 mm	l2 mm	l3 mm	r mm	Z	Order no.
4.00	± 0,02	6.00	3.70	70	6.0	14.0	0.1	2	5493 4.000
5.00	± 0,02	6.00	4.70	70	8.0	14.5	0.1	2	5493 5.000
6.00	± 0,02	6.00	5.70	75	8.0	20.0	0.1	2	5493 6.000
8.00	± 0,02	8.00	7.40	100	8.0	26.0	0.1	2	5493 8.000
8.00	± 0,02	8.00	7.40	100	12.0	26.0	0.1	2	5493 8.001
10.00	± 0,02	10.00	9.40	100	8.0	30.0	0.1	2	5493 10.000
10.00	± 0,02	10.00	9.40	100	16.0	30.0	0.1	2	5493 10.001
12.00	± 0,02	12.00	11.20	100	8.0	36.0	0.1	2	5493 12.000
12.00	± 0,02	12.00	11.20	100	16.0	36.0	0.1	2	5493 12.001
14.00	± 0,02	14.00	13.00	100	8.0	36.0	0.1	2	5493 14.000
14.00	± 0,02	14.00	13.00	100	16.0	36.0	0.1	2	5493 14.001
16.00	± 0,02	16.00	15.00	150	12.0	50.0	0.1	2	5493 16.000
16.00	± 0,02	16.00	15.00	150	20.0	50.0	0.1	2	5493 16.001
18.00	± 0,02	18.00	17.00	125	12.0	50.0	0.1	2	5493 18.000
18.00	± 0,02	18.00	17.00	125	20.0	50.0	0.1	2	5493 18.001
18.00	± 0,02	18.00	17.00	150	12.0	50.0	0.1	2	5493 18.002
18.00	± 0,02	18.00	17.00	150	20.0	50.0	0.1	2	5493 18.003
20.00	± 0,02	20.00	19.00	150	12.0	48.0	0.1	2	5493 20.000
20.00	± 0,02	20.00	19.00	150	20.0	48.0	0.1	2	5493 20.001



PCD slot drills (3-fluted)

Article no. **5495**



Cutting data page 698



for fibre-reinforced plastics (FRP) • for graphite • with internal cooling • neck clearance • centre cutting • other corner radii on request

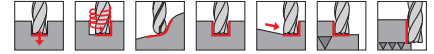

High-performance milling cutters

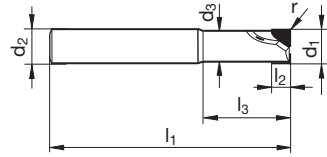

Article no. **5495**

d1 mm	d1	d2 h6 mm	d3 mm	l1 mm	l2 mm	l3 mm	r mm	Z	Order no.
14.00	± 0,02	14.00	13.00	83	8.0	38.0	0.1	3	5495 14.000
14.00	± 0,02	14.00	13.00	83	16.0	38.0	0.1	3	5495 14.001
16.00	± 0,02	16.00	15.00	100	12.0	52.0	0.1	3	5495 16.000
16.00	± 0,02	16.00	15.00	100	20.0	52.0	0.1	3	5495 16.001
18.00	± 0,02	18.00	17.00	100	12.0	52.0	0.1	3	5495 18.000
18.00	± 0,02	18.00	17.00	100	20.0	52.0	0.1	3	5495 18.001
20.00	± 0,02	20.00	19.00	100	12.0	50.0	0.1	3	5495 20.000
20.00	± 0,02	20.00	19.00	100	20.0	50.0	0.1	3	5495 20.001

PCD slot drills (3-fluted)

Article no. **5496**



Cutting data page 698



for fibre-reinforced plastics (FRP) • for graphite • with internal cooling • neck clearance • centre cutting • other corner radii on request

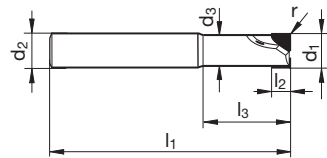
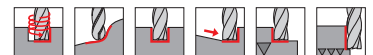

Article no. **5496**

d1 mm	d1	d2 h6 mm	d3 mm	l1 mm	l2 mm	l3 mm	r mm	Z	Order no.
14.00	± 0,02	14.00	13.00	100	8.0	38.0	0.1	3	5496 14.000
14.00	± 0,02	14.00	13.00	100	16.0	38.0	0.1	3	5496 14.001
16.00	± 0,02	16.00	15.00	150	12.0	52.0	0.1	3	5496 16.000
16.00	± 0,02	16.00	15.00	150	20.0	52.0	0.1	3	5496 16.001
18.00	± 0,02	18.00	17.00	150	12.0	52.0	0.1	3	5496 18.000
18.00	± 0,02	18.00	17.00	150	20.0	52.0	0.1	3	5496 18.001
20.00	± 0,02	20.00	19.00	150	12.0	50.0	0.1	3	5496 20.000
20.00	± 0,02	20.00	19.00	150	20.0	50.0	0.1	3	5496 20.001



HSC face milling cutters

Article no. 3016

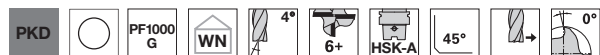
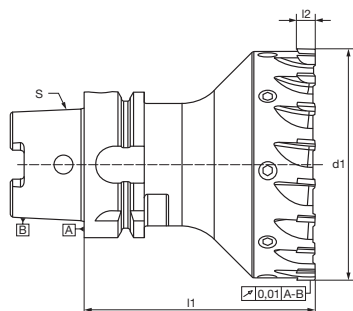

with internal cooling

Cutting data page 698

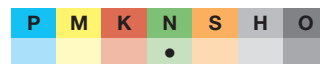

High-performance milling cutters

Article no. 3016

d1 ±0,05 mm	S	l1 mm	l2 mm	Z	Order no.
32.00	HSK-A 63	132	8.0	8	3016 32.000
40.00	HSK-A 63	132	8.0	10	3016 40.000
50.00	HSK-A 63	132	8.0	12	3016 50.000
63.00	HSK-A 63	132	8.0	14	3016 63.000
80.00	HSK-A 63	132	8.0	16	3016 80.000
100.00	HSK-A 63	132	8.0	18	3016 100.000
125.00	HSK-A 63	132	8.0	22	3016 125.000

HSC face milling cutters

Article no. 4201

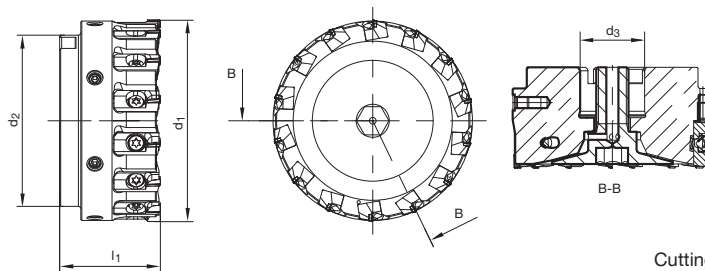

axially µm-accurate adjustable • order PCD cartridges art. no. 4204 separately • defined roughness by selecting insert types • order GM 300 cutter head holders art. no. 4362/4231 separately • coolant distribution screw art. no. 4203 (order separately for Ø 63-125)

Cutting data page 698

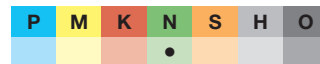

Article no. 4201

d1 ±0,05 mm	d2 mm	d mm	l1 mm	kg	Z	Order no.
63.00	49.00	22.00	40	0.34	8	4201 63.000
80.00	65.00	27.00	50	0.61	10	4201 80.000
100.00	85.00	32.00	50	0.94	14	4201 100.000
125.00	110.00	40.00	63	1.77	18	4201 125.000
160.00	145.00	40.00	63	2.94	24	4201 160.000
200.00	185.00	40.00	63	4.38	28	4201 200.000
250.00	235.00	40.00	63	7.32	36	4201 250.000



PCD cartridges HSC

Article no. **4204**

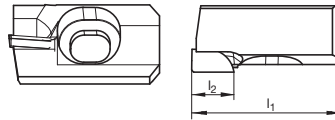

Cutting data page 698



for PF 3000 • axial μm -accurate adjustable inserts • defined roughness by selecting insert types
• for finishing operations additionally use art. no. 4204 30.300

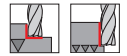

Article no. **4204**

Application	l1 mm	l2 mm	kg	Order no.
Rz 2-4	23	7.00	0.156	4204 30.000
Rz 10-25	23	7.00	0.158	4204 30.200
Rz 2-4	23	7.00	0.159	4204 30.300

High-performance milling cutters

Coolant distributor

Article no. **4203**

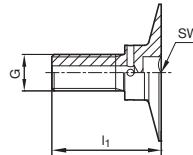

for PF 3000 • coolant distribution screw (for \varnothing 63-125) • coolant distribution disc (for \varnothing 160-250)

Article no. **4203**

l1 mm	d1	SW mm	Order no.
39	M10	8	4203 63.000
47	M12	10	4203 80.000
48	M16	14	4203 100.000
58	M20	17	4203 125.000
11			4203 160.000
11			4203 200.000
11			4203 250.000



90° Chamfering milling cutters SpyroTec

Article no. 6992



Cutting data page 690



face cutting • without centre cutting

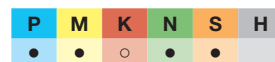

90° Chamfering milling cutters SpyroTec

Article no. 6993



Cutting data page 690



face cutting • without centre cutting

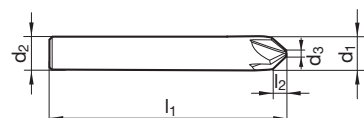

Article no. **6992** **6993**

d1 js9 mm	d2 h6 mm	d3 mm	l1 mm	l2 mm	Z	Order no.
6.00	6.00	1.50	57.0	2.2	5	6992 6.000 6993 6.000
8.00	8.00	2.00	63.0	3.0	5	6992 8.000 6993 8.000
10.00	10.00	2.50	72.0	3.7	5	6992 10.000 6993 10.000
12.00	12.00	3.00	83.0	4.5	5	6992 12.000 6993 12.000
16.00	16.00	4.00	92.0	6.0	5	6992 16.000 6993 16.000
20.00	20.00	5.00	104.0	7.5	5	6992 20.000 6993 20.000

90° Chamfering milling cutters

Article no. 6786



Cutting data page 690



face cutting • without centre cutting

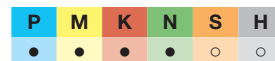

90° Chamfering milling cutters

Article no. 6787



Cutting data page 690



face cutting • without centre cutting

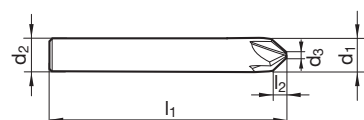
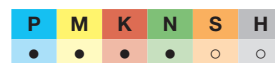

Article no. **6786** **6787**

d1 js9 mm	d2 h6 mm	l1 mm	l2 mm	Z	Order no.
6.00	6.00	57.0	3.0	6	6786 6.000 6787 6.000
8.00	8.00	63.0	4.0	6	6786 8.000 6787 8.000
10.00	10.00	72.0	5.0	6	6786 10.000 6787 10.000
12.00	12.00	83.0	6.0	6	6786 12.000 6787 12.000
16.00	16.00	92.0	8.0	6	6786 16.000 6787 16.000
20.00	20.00	92.0	10.0	6	6786 20.000 6787 20.000



High-performance milling cutters

90° Chamfering milling cutters

Article no. **6713**



Cutting data page 690



P	M	K	N	S	H
•	•	•	•	•	○

90° Chamfering milling cutters

Article no. **3396**



Cutting data page 690



P	M	K	N	S	H
•	•	•	•	•	○

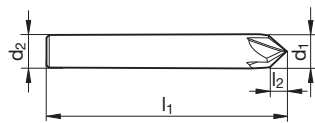

Article no.

6713

3396

d1 js9 mm	d2 h6 mm	l1 mm	l2 mm	Z	Order no.
4.00	4.00	50.0	2.0	4	6713 4.000
6.00	6.00	57.0	3.0	4	6713 6.000 3396 6.000
8.00	8.00	63.0	4.0	4	6713 8.000 3396 8.000
10.00	10.00	72.0	5.0	4	6713 10.000 3396 10.000
12.00	12.00	83.0	6.0	4	6713 12.000 3396 12.000

90° Chamfering milling cutters

Article no. **6784**



Cutting data page 690



P	M	K	N	S	H
•	•	•	•	•	•

90° Chamfering milling cutters

Article no. **6785**



Cutting data page 690



P	M	K	N	S	H
•	•	•	•	•	•



Article no.

6784

6785

d1 js9 mm	d2 h6 mm	l1 mm	l2 mm	Z	Order no.
4.00	4.00	50.0	2.0	4	6784 4.000
6.00	6.00	57.0	3.0	4	6784 6.000 6785 6.000
8.00	8.00	63.0	4.0	4	6784 8.000 6785 8.000
10.00	10.00	72.0	5.0	4	6784 10.000 6785 10.000
12.00	12.00	83.0	6.0	4	6784 12.000 6785 12.000



60° Chamfering milling cutters SpyroTec

Article no. **6810**



Cutting data page 690



face cutting • without centre cutting

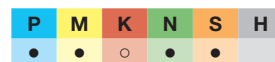

60° Chamfering milling cutters SpyroTec

Article no. **6811**



Cutting data page 690

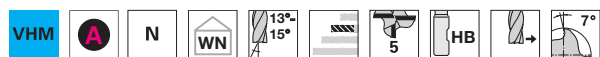

face cutting • without centre cutting

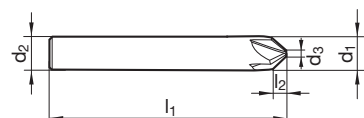

Article no. **6810** **6811**

d1 js9 mm	d2 h6 mm	d3 mm	l1 mm	l2 mm	Z	Order no.
6.00	6.00	1.50	57.0	3.9	5	6810 6.000 6811 6.000
8.00	8.00	2.00	63.0	5.2	5	6810 8.000 6811 8.000
10.00	10.00	2.50	72.0	6.5	5	6810 10.000 6811 10.000
12.00	12.00	3.00	83.0	7.8	5	6810 12.000 6811 12.000
16.00	16.00	4.00	92.0	10.4	5	6810 16.000 6811 16.000
20.00	20.00	5.00	104.0	13.0	5	6810 20.000 6811 20.000

60° Chamfering milling cutters

Article no. **6711**



Cutting data page 690

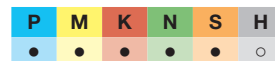

60° Chamfering milling cutters

Article no. **6712**



Cutting data page 690



Article no. **6711** **6712**

d1 js9 mm	d2 h6 mm	l1 mm	l2 mm	Z	Order no.
4.00	4.00	50.0	3.5	4	6711 4.000
6.00	6.00	57.0	5.2	4	6711 6.000 6712 6.000
8.00	8.00	63.0	7.0	4	6711 8.000 6712 8.000
10.00	10.00	72.0	8.7	4	6711 10.000 6712 10.000
12.00	12.00	83.0	10.4	4	6711 12.000 6712 12.000



High-performance milling cutters

120° Chamfering milling cutters SpyroTec

Article no. **6812**



Cutting data page 690

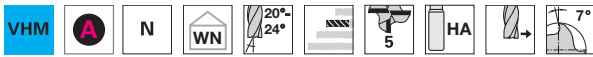

face cutting • without centre cutting

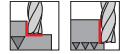

120° Chamfering milling cutters SpyroTec

Article no. **6813**



Cutting data page 690

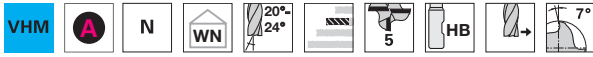

face cutting • without centre cutting

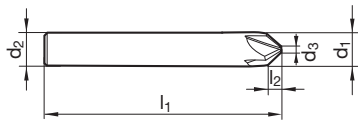
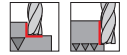

Article no.	6812	6813
	Order no.	
	6812 6.000	6813 6.000
	6812 8.000	6813 8.000
	6812 10.000	6813 10.000
	6812 12.000	6813 12.000
	6812 16.000	6813 16.000
	6812 20.000	6813 20.000

d1 js9 mm	d2 h6 mm	d3 mm	l1 mm	l2 mm	Z
6.00	6.00	1.50	57.0	1.3	5
8.00	8.00	2.00	63.0	1.7	5
10.00	10.00	2.50	72.0	2.1	5
12.00	12.00	3.00	83.0	2.6	5
16.00	16.00	4.00	92.0	3.4	5
20.00	20.00	5.00	104.0	4.3	5

120° Chamfering milling cutters

Article no. **6714**



Cutting data page 690

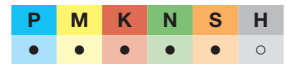

120° Chamfering milling cutters

Article no. **6715**



Cutting data page 690



Article no.	6714	6715
	Order no.	
	6714 4.000	
	6714 6.000	6715 6.000
	6714 8.000	6715 8.000
	6714 10.000	6715 10.000
	6714 12.000	6715 12.000

d1 js9 mm	d2 h6 mm	l1 mm	l2 mm	Z
4.00	4.00	50.0	1.2	4
6.00	6.00	57.0	1.8	4
8.00	8.00	63.0	2.4	4
10.00	10.00	72.0	2.9	4
12.00	12.00	83.0	3.5	4



90° Front/back deburrers

Article no. 495



neck clearance $\lt; \varnothing 6.0 \text{ mm}$ • without centre cutting

P	M	K	N	S	H
•	•	•	○	•	•

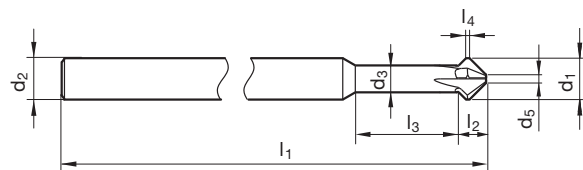

Article no. **495**

d1 mm	d2 h6 mm	d3 mm	d5 mm	l1 mm	l2 mm	l3 mm	l4 mm	Z	Order no.
3.00	4.00	2.20	0.60	75.0	2.1	9.3	0.5	4	495 3.000
4.00	4.00	2.90	0.80	75.0	2.7	12.3	0.5	4	495 4.000
5.00	5.00	3.90	1.00	75.0	3.0	15.0	0.5	4	495 5.000
6.00	6.00	3.90	1.20	100.0	3.9	14.3	0.5	4	495 6.000
8.00	6.00	6.00	1.60	100.0	4.7		0.5	4	495 8.000
10.00	6.00	6.00	2.00	100.0	6.5		0.5	4	495 10.000
12.00	6.00	6.00	2.40	100.0	8.3		0.5	4	495 12.000

High-performance milling cutters

Quadrant milling cutters

Article no. 6788



without centre cutting

P	M	K	N	S	H
•	•	•	•	○	•

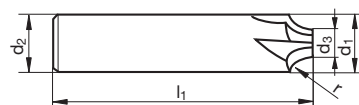

Article no. **6788**

d1 mm	r mm	d2 mm	d3 mm	l1 mm	Z	Order no.
6.00	0.50	6.00	3.5	50	4	6788 6.005
6.00	1.00	6.00	4.0	50	4	6788 6.010
8.00	1.50	8.00	4.6	58	4	6788 8.015
10.00	2.00	10.00	6.0	66	4	6788 10.020
10.00	2.50	10.00	5.0	66	4	6788 10.025
12.00	3.00	12.00	6.0	73	4	6788 12.030
14.00	3.50	14.00	7.0	75	4	6788 14.035
14.00	4.00	14.00	6.0	75	4	6788 14.040
16.00	4.50	16.00	7.0	76	4	6788 16.045
16.00	5.00	16.00	6.0	76	4	6788 16.050
20.00	5.50	20.00	9.0	92	4	6788 20.055
20.00	6.00	20.00	8.0	92	4	6788 20.060



Ball nose end mills G-Mold μ 65 B

Article no. **6815**



high-precision ball nose end mills for maximum form accuracy • exact tolerance of the radius contour $r = 0.5 \times d1 \pm 0.005 \text{ mm}$ • \varnothing tolerance $d1$ of $\varnothing 0.2\text{-}3 \text{ mm} +0.000/-0.010 \text{ mm}$ • with GühroJet peripheral cooling from $\varnothing 0.2\text{-}3 \text{ mm}$ • centre cutting • neck clearance

Cutting data page 700

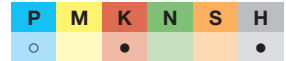

High-performance milling cutters

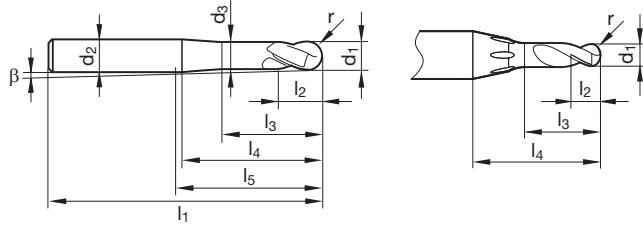

Article no.

6815

d1 ^{-0,005/-0,015} mm	d2 h5 mm	d3 mm	l1 mm	l2 mm	l3 mm	l4 mm	l5 mm	r mm	β °	Z	Order no.
0.20	4.00	0.18	50	0.2	0.5	9.2	9.2	0.10	11.80	2	6815 0.200
0.30	4.00	0.28	50	0.3	0.7	9.1	9.1	0.15	11.60	2	6815 0.300
0.40	4.00	0.38	50	0.4	1.0	9.1	9.1	0.20	11.40	2	6815 0.400
0.50	4.00	0.45	50	0.5	1.2	9.2	9.2	0.25	11.00	2	6815 0.500
0.60	4.00	0.55	50	0.6	1.5	9.2	9.2	0.30	10.80	2	6815 0.600
0.80	4.00	0.75	50	0.8	2.0	9.1	9.1	0.40	10.40	2	6815 0.800
1.00	4.00	0.92	50	1.0	2.5	9.2	9.2	0.50	9.70	2	6815 1.000
1.20	4.00	1.12	50	1.2	3.0	9.3	9.3	0.60	9.10	2	6815 1.200
1.50	4.00	1.40	50	1.5	4.0	9.6	9.6	0.75	8.00	2	6815 1.500
1.80	4.00	1.70	50	1.8	4.5	9.4	9.4	0.90	7.30	2	6815 1.800
2.00	6.00	1.85	50	2.0	5.0	14.2	14.2	1.00	8.60	2	6815 2.000
2.50	6.00	2.35	50	2.5	6.5	14.6	14.6	1.25	7.40	2	6815 2.500
3.00	6.00	2.85	50	3.0	7.5	14.4	14.4	1.50	6.60	2	6815 3.000
4.00	6.00	3.80	50	4.0	12.5	15.5	14.0	2.00	4.20	2	6815 4.000
5.00	6.00	4.80	50	5.0	15.0	16.6	14.0	2.50	2.00	2	6815 5.000
6.00	6.00	5.70	54	6.0	17.0	17.6	18.0	3.00		2	6815 6.000
8.00	8.00	7.70	58	8.0	22.0	22.6	22.0	4.00		2	6815 8.000
10.00	10.00	9.50	72	10.0	25.0	25.9	32.0	5.00		2	6815 10.000
12.00	12.00	11.50	73	12.0	30.0	30.9	28.0	6.00		2	6815 12.000



Ball nose end mills G-Mold μ 65 B

Article no. 6816



Cutting data page 700

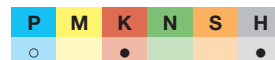

high-precision ball nose end mills for maximum form accuracy • exact tolerance of the radius contour $r = 0.5 \times d1 \pm 0.005 \text{ mm}$ • \varnothing tolerance $d1$ of $\varnothing 0.2\text{-}3 \text{ mm} +0.000/-0.010 \text{ mm}$ • with GühroJet peripheral cooling from $\varnothing 0.2\text{-}3 \text{ mm}$ • centre cutting • neck clearance

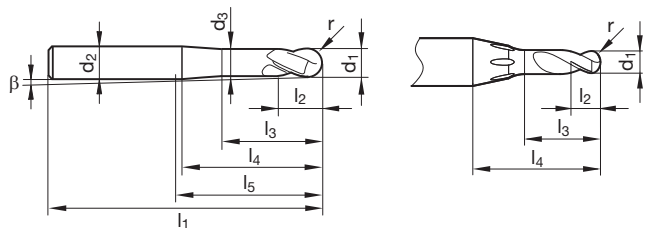
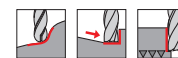

Article no.

6816

d1 ^{-0,005/-0,015} mm	d2 h5 mm	d3 mm	l1 mm	l2 mm	l3 mm	l4 mm	l5 mm	r mm	β °	Z	Order no.
0.20	4.00	0.18	50	0.2	0.7	9.5	22.0	0.10	11.40	2	6816 0.200
0.30	4.00	0.28	50	0.3	1.0	9.4	22.0	0.15	11.30	2	6816 0.300
0.40	4.00	0.38	50	0.4	1.5	9.6	22.0	0.20	10.80	2	6816 0.400
0.50	4.00	0.45	50	0.5	1.5	9.5	22.0	0.25	10.70	2	6816 0.500
0.60	4.00	0.55	50	0.6	2.0	9.7	22.0	0.30	10.20	2	6816 0.600
0.80	4.00	0.75	50	0.8	3.0	10.1	22.0	0.40	9.30	2	6816 0.800
1.00	4.00	0.92	50	1.0	3.0	9.7	22.0	0.50	9.20	2	6816 1.000
1.20	4.00	1.12	50	1.2	4.0	10.3	22.0	0.60	8.20	2	6816 1.200
1.50	4.00	1.40	50	1.5	6.0	11.6	22.0	0.75	6.50	2	6816 1.500
1.80	4.00	1.70	50	1.8	6.0	10.9	22.0	0.90	6.20	2	6816 1.800
2.00	6.00	1.85	50	2.0	6.0	15.2	15.0	1.00	8.00	2	6816 2.000
2.50	6.00	2.35	50	2.5	8.0	16.1	16.0	1.25	6.70	2	6816 2.500
3.00	6.00	2.85	57	3.0	10.0	16.9	21.0	1.50	5.50	2	6816 3.000
4.00	6.00	3.80	57	4.0	14.0	17.0	21.0	2.00	3.80	2	6816 4.000
5.00	6.00	4.80	57	5.0	18.0	19.6	21.0	2.50	1.60	2	6816 5.000
6.00	6.00	5.70	57	6.0	20.0	20.6	21.0	3.00		2	6816 6.000
8.00	8.00	7.70	63	8.0	26.0	26.6	27.0	4.00		2	6816 8.000
10.00	10.00	9.50	72	10.0	31.0	31.9	32.0	5.00		2	6816 10.000
12.00	12.00	11.50	83	12.0	37.0	37.9	38.0	6.00		2	6816 12.000

High-performance milling cutters



Ball nose end mills G-Mold μ 65 B

Article no. **6817**



Cutting data page 700

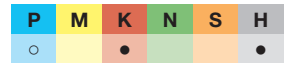

high-precision ball nose end mills for maximum form accuracy • exact tolerance of the radius contour $r = 0.5 \times d1 \pm 0.005 \text{ mm}$ • \varnothing tolerance $d1$ of $\varnothing 0.2\text{-}3 \text{ mm} +0.000/-0.010 \text{ mm}$ • with GühroJet peripheral cooling from $\varnothing 0.2\text{-}3 \text{ mm}$ • centre cutting • neck clearance

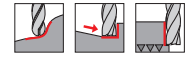

High-performance milling cutters

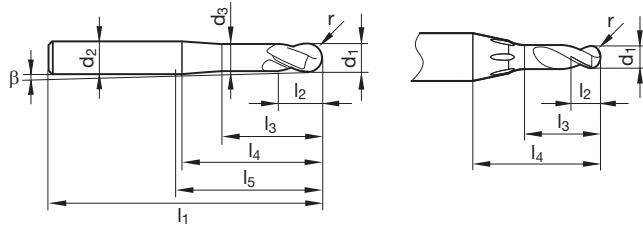

Article no.

6817

d1 ^{-0,005/-0,015} mm	d2 h5 mm	d3 mm	l1 mm	l2 mm	l3 mm	l4 mm	l5 mm	r mm	β °	Z	Order no.
0.20	4.00	0.18	50	0.2	1.0	9.7	22.0	0.10	11.20	2	6817 0.200
0.30	4.00	0.28	50	0.3	1.5	9.9	22.0	0.15	10.70	2	6817 0.300
0.40	4.00	0.38	50	0.4	2.0	10.1	22.0	0.20	10.30	2	6817 0.400
0.50	4.00	0.45	50	0.5	2.5	10.5	22.0	0.25	9.60	2	6817 0.500
0.60	4.00	0.55	50	0.6	3.0	10.7	22.0	0.30	9.20	2	6817 0.600
0.80	4.00	0.75	50	0.8	4.0	11.1	22.0	0.40	8.50	2	6817 0.800
1.00	4.00	0.92	50	1.0	5.0	11.7	22.0	0.50	7.60	2	6817 1.000
1.20	4.00	1.12	50	1.2	6.0	12.3	22.0	0.60	6.80	2	6817 1.200
1.50	4.00	1.40	50	1.5	8.0	13.6	22.0	0.75	5.50	2	6817 1.500
1.80	4.00	1.70	50	1.8	9.0	13.9	22.0	0.90	4.80	2	6817 1.800
2.00	6.00	1.85	50	2.0	10.0	19.2	19.0	1.00	6.20	2	6817 2.000
2.50	6.00	2.35	50	2.5	12.5	20.6	21.0	1.25	5.10	2	6817 2.500
3.00	6.00	2.85	65	3.0	15.0	21.9	29.0	1.50	4.20	2	6817 3.000
4.00	6.00	3.80	65	4.0	20.0	23.0	29.0	2.00	2.70	2	6817 4.000
5.00	6.00	4.80	65	5.0	25.0	26.6	29.0	2.50	1.10	2	6817 5.000
6.00	6.00	5.70	65	6.0	25.0	25.6	29.0	3.00		2	6817 6.000
8.00	8.00	7.70	75	8.0	30.0	30.6	39.0	4.00		2	6817 8.000
10.00	10.00	9.50	90	10.0	40.0	40.9	50.0	5.00		2	6817 10.000
12.00	12.00	11.50	100	12.0	40.0	40.9	55.0	6.00		2	6817 12.000



Ball nose end mills G-Mold μ 65 B

Article no. **6818**



Cutting data page 700

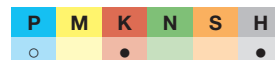

high-precision ball nose end mills for maximum form accuracy • exact tolerance of the radius contour $r = 0.5 \times d1 \pm 0.005 \text{ mm}$ • \varnothing tolerance $d1$ of $\varnothing 0.2\text{-}3 \text{ mm } +0.000/-0.010 \text{ mm}$ • with GühroJet peripheral cooling from $\varnothing 0.2\text{-}3 \text{ mm}$ • centre cutting • neck clearance

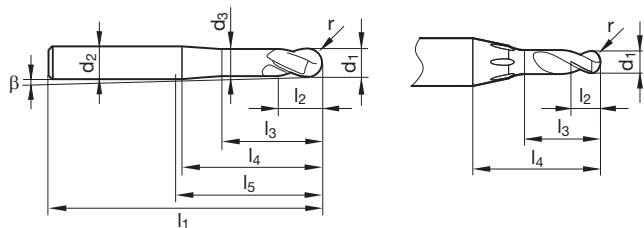
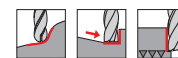

Article no.

6818

d1 ^{-0,005/-0,015} mm	d2 h5 mm	d3 mm	l1 mm	l2 mm	l3 mm	l4 mm	l5 mm	r mm	β °	Z	Order no.
0.20	4.00	0.18	50	0.2	1.2	10.0	22.0	0.10	10.80	2	6818 0.200
0.30	4.00	0.28	50	0.3	2.0	10.4	22.0	0.15	10.20	2	6818 0.300
0.40	4.00	0.38	50	0.4	3.0	11.1	22.0	0.20	9.30	2	6818 0.400
0.50	4.00	0.45	50	0.5	3.0	11.0	22.0	0.25	9.20	2	6818 0.500
0.60	4.00	0.55	50	0.6	4.0	11.7	22.0	0.30	8.40	2	6818 0.600
0.80	4.00	0.75	50	0.8	5.0	12.1	22.0	0.40	7.70	2	6818 0.800
1.00	4.00	0.92	50	1.0	7.0	13.7	22.0	0.50	6.40	2	6818 1.000
1.20	4.00	1.12	50	1.2	8.0	14.3	22.0	0.60	5.80	2	6818 1.200
1.50	4.00	1.40	50	1.5	10.0	15.6	22.0	0.75	4.80	2	6818 1.500
1.80	4.00	1.70	55	1.8	12.0	16.9	27.0	0.90	3.90	2	6818 1.800
2.00	6.00	1.85	57	2.0	12.0	21.2	21.0	1.00	5.60	2	6818 2.000
2.50	6.00	2.35	57	2.5	15.0	23.1	23.0	1.25	4.50	2	6818 2.500
3.00	6.00	2.85	65	3.0	18.0	24.9	29.0	1.50	3.60	2	6818 3.000
4.00	6.00	3.80	65	4.0	24.0	27.0	29.0	2.00	2.30	2	6818 4.000
5.00	6.00	4.80	80	5.0	30.0	31.6	44.0	2.50	0.90	2	6818 5.000
6.00	6.00	5.70	80	6.0	30.0	30.6	44.0	3.00		2	6818 6.000
8.00	8.00	7.70	90	8.0	40.0	40.6	54.0	4.00		2	6818 8.000
10.00	10.00	9.50	100	10.0	50.0	50.9	60.0	5.00		2	6818 10.000
12.00	12.00	11.50	120	12.0	60.0	60.9	75.0	6.00		2	6818 12.000

High-performance milling cutters



Ball nose end mills G-Mold μ 65 B

Article no. **6819**



Cutting data page 700

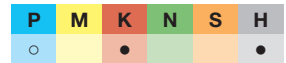

high-precision ball nose end mills for maximum form accuracy • exact tolerance of the radius contour $r = 0.5 \times d1 \pm 0.005 \text{ mm}$ • \varnothing tolerance $d1$ of $\varnothing 0.2\text{-}3 \text{ mm} +0.000/-0.010 \text{ mm}$ • with GühroJet peripheral cooling from $\varnothing 0.2\text{-}3 \text{ mm}$ • centre cutting • neck clearance

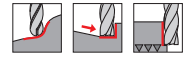

High-performance milling cutters

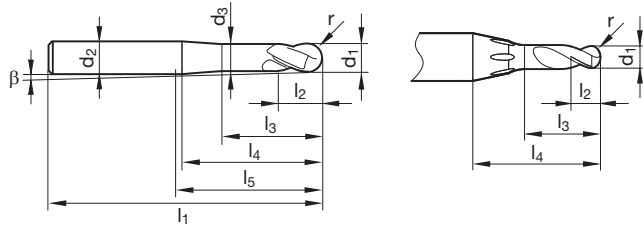

Article no.

6819

d1 ^{-0,005/-0,015} mm	d2 h5 mm	d3 mm	l1 mm	l2 mm	l3 mm	l4 mm	l5 mm	r mm	β °	Z
0.20	4.00	0.18	50	0.2	1.5	10.2	22.0	0.10	10.60	2
0.30	4.00	0.28	50	0.3	3.0	11.4	22.0	0.15	9.30	2
0.40	4.00	0.38	50	0.4	4.0	12.1	22.0	0.20	8.60	2
0.50	4.00	0.45	50	0.5	5.0	13.0	22.0	0.25	7.80	2
0.60	4.00	0.55	50	0.6	6.0	13.7	22.0	0.30	7.20	2
0.80	4.00	0.75	50	0.8	8.0	15.1	22.0	0.40	6.20	2
1.00	4.00	0.92	50	1.0	10.0	16.7	22.0	0.50	5.30	2
1.20	4.00	1.12	55	1.2	12.0	18.3	27.0	0.60	4.50	2
1.50	4.00	1.40	55	1.5	16.0	21.6	27.0	0.75	3.40	2
1.80	4.00	1.70	63	1.8	20.0	24.9	35.0	0.90	2.60	2
2.00	6.00	1.85	65	2.0	20.0	29.2	29.0	1.00	4.00	2
2.50	6.00	2.35	65	2.5	20.0	28.1	29.0	1.25	3.70	2
3.00	6.00	2.85	70	3.0	25.0	31.9	34.0	1.50	2.80	2
4.00	6.00	3.80	75	4.0	32.0	35.0	39.0	2.00	1.70	2
5.00	6.00	4.80	80	5.0	42.0	43.6	44.0	2.50	0.70	2
6.00	6.00	5.70	100	6.0	40.0	40.6	64.0	3.00		2
8.00	8.00	7.70	100	8.0	40.0	40.6	64.0	4.00		2

Order no.
6819 0.200
6819 0.300
6819 0.400
6819 0.500
6819 0.600
6819 0.800
6819 1.000
6819 1.200
6819 1.500
6819 1.800
6819 2.000
6819 2.500
6819 3.000
6819 4.000
6819 5.000
6819 6.000
6819 8.000



Ball nose end mills G-Mold 65 B

Article no. **6832**



neck clearance • centre cutting

Cutting data page 700

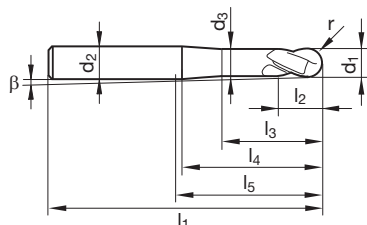
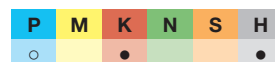

Article no. **6832**

d1 ^{-0,01/-0,03} mm	d2 h5 mm	d3 mm	l1 mm	l2 mm	l3 mm	l4 mm	l5 mm	r mm	β °	Z	Order no.
0.50	4.00	0.45	45	0.5	2.5	9.1	17.0	0.25	11.10	2	6832 0.500
0.80	4.00	0.75	45	0.8	3.2	9.3	17.0	0.40	10.20	2	6832 0.800
1.00	4.00	0.92	45	1.0	4.0	9.7	17.0	0.50	9.20	2	6832 1.000
1.50	4.00	1.40	45	1.5	6.0	10.9	17.0	0.75	7.00	2	6832 1.500
2.00	6.00	1.85	54	2.0	8.0	13.7	18.0	1.00	8.90	2	6832 2.000
3.00	6.00	2.85	54	3.0	12.0	16.3	18.0	1.50	5.70	2	6832 3.000
4.00	6.00	3.80	57	4.0	14.0	17.0	21.0	2.00	3.80	2	6832 4.000
5.00	6.00	4.80	57	5.0	17.0	18.6	21.0	2.50	1.70	2	6832 5.000
6.00	6.00	5.70	57	6.0	20.0	20.6	21.0	3.00		2	6832 6.000
8.00	8.00	7.70	63	8.0	26.0	26.6	27.0	4.00		2	6832 8.000
10.00	10.00	9.50	72	10.0	31.0	31.9	32.0	5.00		2	6832 10.000
12.00	12.00	11.50	83	12.0	37.0	37.9	38.0	6.00		2	6832 12.000

Ball nose end mills G-Mold 65 B

Article no. **6833**



neck clearance • centre cutting

Cutting data page 700

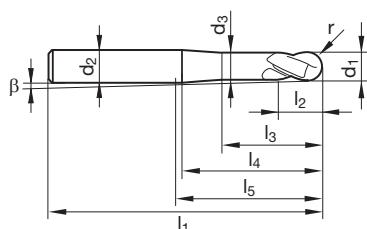
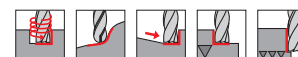
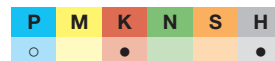

Article no. **6833**

d1 ^{-0,01/-0,03} mm	d2 h5 mm	d3 mm	l1 mm	l2 mm	l3 mm	l4 mm	l5 mm	r mm	β °	Z	Order no.
0.50	4.00	0.45	50	0.5	3.6	10.2	22.0	0.25	9.90	2	6833 0.500
0.80	4.00	0.75	50	0.8	5.0	11.1	22.0	0.40	8.50	2	6833 0.800
1.00	4.00	0.92	50	1.0	6.5	12.2	22.0	0.50	7.30	2	6833 1.000
1.50	4.00	1.40	50	1.5	10.0	14.9	22.0	0.75	5.00	2	6833 1.500
2.00	6.00	1.85	57	2.0	13.0	18.7	21.0	1.00	6.40	2	6833 2.000
3.00	6.00	2.85	65	3.0	20.0	24.3	29.0	1.50	3.70	2	6833 3.000
4.00	6.00	3.80	75	4.0	25.0	28.0	39.0	2.00	2.20	2	6833 4.000
5.00	6.00	4.80	75	5.0	31.0	32.6	39.0	2.50	0.90	2	6833 5.000
6.00	6.00	5.70	75	6.0	38.0	38.6	39.0	3.00		2	6833 6.000
8.00	8.00	7.70	90	8.0	53.0	53.6	54.0	4.00		2	6833 8.000
10.00	10.00	9.50	100	10.0	59.0	59.9	60.0	5.00		2	6833 10.000
12.00	12.00	11.50	120	12.0	74.0	74.9	75.0	6.00		2	6833 12.000



Ball nose end mills G-Mold 65 B

Article no. **6834**



neck clearance • centre cutting

Cutting data page 700

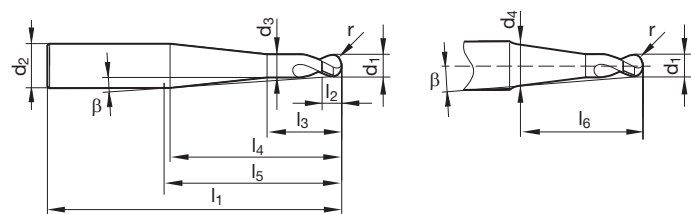
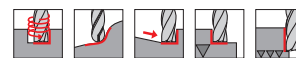
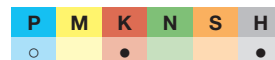

Article no.

6834

d1 ^{-0,01} / _{-0,03}	d2 h5	d3	d4	l1	l2	l3	l4	l5	l6	r	β	Z
mm	mm	mm	mm	mm	mm	mm	mm	mm	mm	mm	°	
0.50	4.00	0.45	1.47	50	0.5	1.3	14.7	22.0	10.0	0.25	3.00	2
0.80	4.00	0.75	2.38	50	0.8	2.0	19.0	22.0	16.0	0.40	3.00	2
1.00	4.00	0.92	2.99	63	1.0	2.5	21.9	35.0	20.0	0.50	3.00	2
1.50	4.00	1.40		63	1.5	3.8	25.6	35.0		0.75	3.00	2
2.00	6.00	1.85		80	2.0	5.0	40.1	44.0		1.00	3.00	2
3.00	6.00	2.85		80	3.0	7.5	31.1	44.0		1.50	3.00	2
4.00	6.00	3.80		80	4.0	10.0	22.0	44.0		2.00	3.00	2
5.00	8.00	4.80		90	5.0	12.5	32.1	54.0		2.50	3.00	2
6.00	8.00	5.70		90	6.0	15.0	43.1	54.0		3.00	1.50	2
8.00	10.00	7.70		100	8.0	20.0	44.1	60.0		4.00	1.50	2
10.00	12.00	9.50		120	10.0	25.0	45.1	75.0		5.00	1.50	2

Order no.

6834 0.500
6834 0.800
6834 1.000
6834 1.500
6834 2.000
6834 3.000
6834 4.000
6834 5.000
6834 6.000
6834 8.000
6834 10.000

Ball nose end mills G-Mold 65 B

Article no. **6835**



4 face cutting edges up to the centre • neck clearance • centre cutting

Cutting data page 700

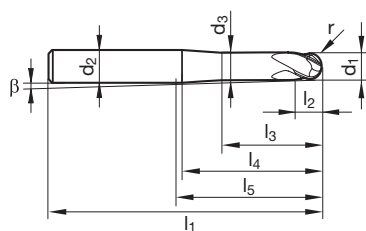
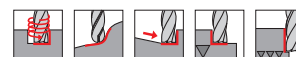

Article no.

6835

d1 ^{-0,01} / _{-0,03}	d2 h5	d3	l1	l2	l3	l4	l5	r	β	Z
mm	mm	mm	mm	mm	mm	mm	mm	mm	°	
1.00	4.00	0.92	45	1.0	4.0	9.7	17.0	0.50	9.20	4
1.50	4.00	1.40	45	1.5	6.0	10.9	17.0	0.75	7.00	4
2.00	6.00	1.85	54	2.0	8.0	13.7	18.0	1.00	8.90	4
3.00	6.00	2.85	54	3.0	12.0	16.3	18.0	1.50	5.70	4
4.00	6.00	3.80	57	4.0	14.0	17.0	21.0	2.00	3.80	4
5.00	6.00	4.80	57	5.0	17.0	18.6	21.0	2.50	1.70	4
6.00	6.00	5.70	57	6.0	20.0	20.6	21.0	3.00		4
8.00	8.00	7.70	63	8.0	26.0	26.6	27.0	4.00		4
10.00	10.00	9.50	72	10.0	31.0	31.9	32.0	5.00		4
12.00	12.00	11.50	83	12.0	37.0	37.9	38.0	6.00		4

Order no.

6835 1.000
6835 1.500
6835 2.000
6835 3.000
6835 4.000
6835 5.000
6835 6.000
6835 8.000
6835 10.000
6835 12.000



Ball nose end mills G-Mold 65 B

Article no. **6836**



4 face cutting edges up to the centre • neck clearance • centre cutting

Cutting data page 700

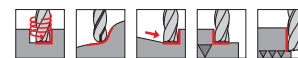
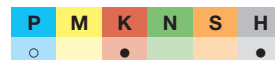

High-performance milling cutters

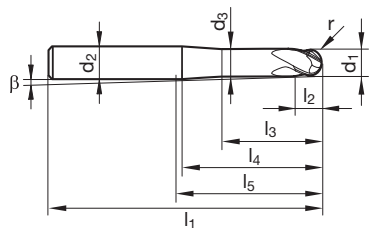

Article no.

6836

d1 ^{-0,01 -0,03} mm	d2 h5 mm	d3 mm	l1 mm	l2 mm	l3 mm	l4 mm	l5 mm	r mm	β °	Z
1.00	4.00	0.92	50	1.0	6.5	12.2	25.0	0.50	7.30	4
1.50	4.00	1.40	50	1.5	10.0	14.9	25.5	0.75	5.00	4
2.00	6.00	1.85	57	2.0	13.0	18.7	29.5	1.00	6.40	4
3.00	6.00	2.85	65	3.0	20.0	24.3	34.5	1.50	3.70	4
4.00	6.00	3.80	75	4.0	25.0	28.0	40.6	2.00	2.20	4
5.00	6.00	4.80	75	5.0	31.0	32.6	41.6	2.50	0.90	4
6.00	6.00	5.70	75	6.0	38.0	38.6	39.0	3.00		4
8.00	8.00	7.70	90	8.0	53.0	53.6	54.0	4.00		4
10.00	10.00	9.50	100	10.0	59.0	59.9	60.0	5.00		4
12.00	12.00	11.50	120	12.0	74.0	74.9	75.0	6.00		4

Order no.
6836 1.000
6836 1.500
6836 2.000
6836 3.000
6836 4.000
6836 5.000
6836 6.000
6836 8.000
6836 10.000
6836 12.000



Ball nose end mills G-Mold 55 B

Article no. **6844**



neck clearance • centre cutting

Cutting data page 700

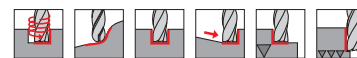
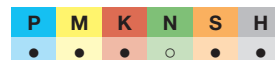

High-performance milling cutters

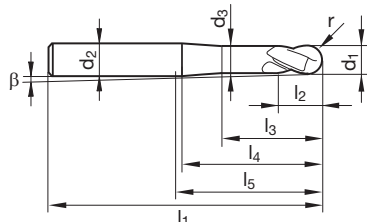

Article no. **6844**

d1 ^{-0,01/-0,03} mm	d2 h5 mm	d3 mm	l1 mm	l2 mm	l3 mm	l4 mm	l5 mm	r mm	β °	Z	Order no.
0.50	4.00	0.45	45	0.5	2.5	9.1	17.0	0.25	11.10	2	6844 0.500
0.80	4.00	0.75	45	0.8	3.2	9.3	17.0	0.40	10.20	2	6844 0.800
1.00	4.00	0.92	45	1.0	4.0	9.7	17.0	0.50	9.20	2	6844 1.000
1.50	4.00	1.40	45	1.5	6.0	10.9	17.0	0.75	7.00	2	6844 1.500
2.00	6.00	1.85	54	2.0	8.0	13.7	18.0	1.00	8.90	2	6844 2.000
3.00	6.00	2.85	54	3.0	12.0	16.3	18.0	1.50	5.70	2	6844 3.000
4.00	6.00	3.80	57	4.0	14.0	17.0	21.0	2.00	3.80	2	6844 4.000
5.00	6.00	4.80	57	5.0	17.0	18.6	21.0	2.50	1.70	2	6844 5.000
6.00	6.00	5.70	57	6.0	20.0	20.6	21.0	3.00		2	6844 6.000
8.00	8.00	7.70	63	8.0	26.0	26.6	27.0	4.00		2	6844 8.000
10.00	10.00	9.50	72	10.0	31.0	31.9	32.0	5.00		2	6844 10.000
12.00	12.00	11.50	83	12.0	37.0	37.9	38.0	6.00		2	6844 12.000

Ball nose end mills G-Mold 55 B

Article no. **6845**



neck clearance • centre cutting

Cutting data page 700

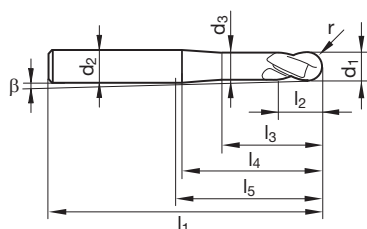
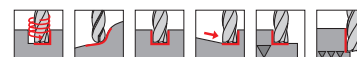

Article no. **6845**

d1 ^{-0,01/-0,03} mm	d2 h5 mm	d3 mm	l1 mm	l2 mm	l3 mm	l4 mm	l5 mm	r mm	β °	Z	Order no.
0.50	4.00	0.45	50	0.5	3.6	10.2	22.0	0.25	9.90	2	6845 0.500
0.80	4.00	0.75	50	0.8	5.0	11.1	22.0	0.40	8.50	2	6845 0.800
1.00	4.00	0.92	50	1.0	6.5	12.2	22.0	0.50	7.30	2	6845 1.000
1.50	4.00	1.40	50	1.5	10.0	14.9	22.0	0.75	5.00	2	6845 1.500
2.00	6.00	1.85	57	2.0	13.0	18.7	21.0	1.00	6.40	2	6845 2.000
3.00	6.00	2.85	65	3.0	20.0	24.3	29.0	1.50	3.70	2	6845 3.000
4.00	6.00	3.80	75	4.0	25.0	28.0	39.0	2.00	2.20	2	6845 4.000
5.00	6.00	4.80	75	5.0	31.0	32.6	39.0	2.50	0.90	2	6845 5.000
6.00	6.00	5.70	75	6.0	38.0	38.6	39.0	3.00		2	6845 6.000
8.00	8.00	7.70	90	8.0	53.0	53.6	54.0	4.00		2	6845 8.000
10.00	10.00	9.50	100	10.0	59.0	59.9	60.0	5.00		2	6845 10.000
12.00	12.00	11.50	120	12.0	74.0	74.9	75.0	6.00		2	6845 12.000



Ball nose end mills G-Mold 55 B

Article no. **6846**



neck clearance • centre cutting

Cutting data page 700

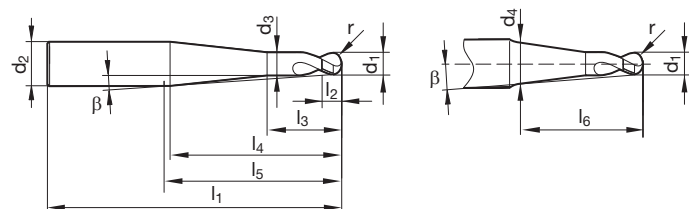
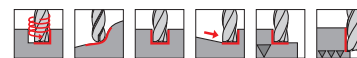
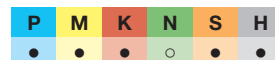

Article no.													6846
													Order no.
0.50	4.00	0.45	0.96	50	0.5	1.3	15.7	22.0	10.0	0.25	1.50	2	6846 0.500
0.80	4.00	0.75	1.56	50	0.8	2.0	20.5	22.0	16.0	0.40	1.50	2	6846 0.800
1.00	4.00	0.92	1.97	63	1.0	2.5	23.8	35.0	20.0	0.50	1.50	2	6846 1.000
1.50	4.00	1.40	2.98	63	1.5	3.8	31.9	35.0	30.0	0.75	1.50	2	6846 1.500
2.00	6.00	1.85	3.99	80	2.0	5.0	43.7	44.0	40.0	1.00	1.50	2	6846 2.000
3.00	6.00	2.85	4.96	80	3.0	7.5	41.9	44.0	40.0	1.50	1.50	2	6846 3.000
4.00	6.00	3.80		80	4.0	10.0	42.1	44.0		2.00	1.50	2	6846 4.000
5.00	8.00	4.80	6.91	90	5.0	12.5	42.0	54.0	40.0	2.50	1.50	2	6846 5.000
6.00	8.00	5.70		90	6.0	15.0	43.1	54.0		3.00	1.50	2	6846 6.000
8.00	10.00	7.70		100	8.0	20.0	44.1	60.0		4.00	1.50	2	6846 8.000
10.00	12.00	9.50		120	10.0	25.0	45.1	75.0		5.00	1.50	2	6846 10.000

Ball nose end mills G-Mold 55 B

Article no. **6847**



neck clearance • centre cutting

Cutting data page 700

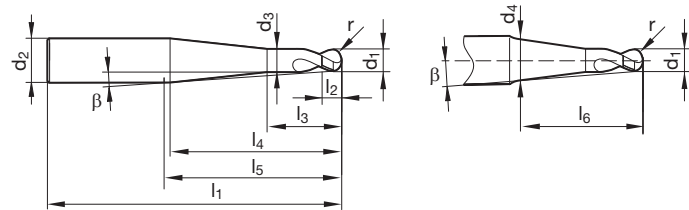
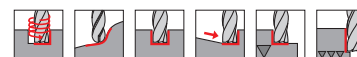

Article no.													6847
													Order no.
0.50	4.00	0.45	0.79	50	0.5	1.3	16.0	22.0	10.0	0.25	1.00	2	6847 0.500
0.80	4.00	0.75	1.29	50	0.8	2.0	21.0	22.0	16.0	0.40	1.00	2	6847 0.800
1.00	4.00	0.92	1.63	63	1.0	2.5	24.4	35.0	20.0	0.50	1.00	2	6847 1.000
1.50	4.00	1.40	2.47	63	1.5	3.8	32.8	35.0	30.0	0.75	1.00	2	6847 1.500
2.00	6.00	1.85	3.31	80	2.0	5.0	45.0	44.0	40.0	1.00	1.00	2	6847 2.000
3.00	6.00	2.85	4.29	80	3.0	7.5	43.2	44.0	40.0	1.50	1.00	2	6847 3.000
4.00	6.00	3.80	5.28	80	4.0	10.0	41.3	44.0	40.0	2.00	1.00	2	6847 4.000
5.00	8.00	4.80	6.61	90	5.0	12.5	52.6	54.0	50.0	2.50	1.00	2	6847 5.000
6.00	8.00	5.70	7.59	90	6.0	15.0	50.8	54.0	50.0	3.00	1.00	2	6847 6.000
8.00	10.00	7.70		100	8.0	20.0	64.2	60.0		4.00	1.00	2	6847 8.000



Ball nose end mills G-Mold 55 B

Article no. **6848**

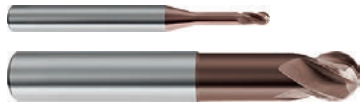

4 face cutting edges up to the centre • neck clearance • centre cutting

Cutting data page 700



High-performance milling cutters

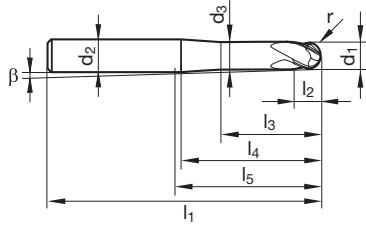

Article no.

6848

d1 ^{-0,01} _{-0,03} mm	d2 h5 mm	d3 mm	l1 mm	l2 mm	l3 mm	l4 mm	l5 mm	r mm	β °	Z
1.00	4.00	0.92	45	1.0	4.0	9.7	17.0	0.50	9.20	4
1.50	4.00	1.40	45	1.5	6.0	10.9	17.0	0.75	7.00	4
2.00	6.00	1.85	54	2.0	8.0	13.7	18.0	1.00	8.90	4
3.00	6.00	2.85	54	3.0	12.0	16.3	18.0	1.50	5.70	4
4.00	6.00	3.80	57	4.0	14.0	17.0	21.0	2.00	3.80	4
5.00	6.00	4.80	57	5.0	17.0	18.6	21.0	2.50	1.70	4
6.00	6.00	5.70	57	6.0	20.0	20.6	21.0	3.00		4
8.00	8.00	7.70	63	8.0	26.0	26.6	27.0	4.00		4
10.00	10.00	9.50	72	10.0	31.0	31.9	32.0	5.00		4
12.00	12.00	11.50	83	12.0	37.0	37.9	38.0	6.00		4

Order no.

6848 1.000
6848 1.500
6848 2.000
6848 3.000
6848 4.000
6848 5.000
6848 6.000
6848 8.000
6848 10.000
6848 12.000

Ball nose end mills G-Mold 55 B

Article no. **6849**



4 face cutting edges up to the centre • neck clearance • centre cutting

Cutting data page 700

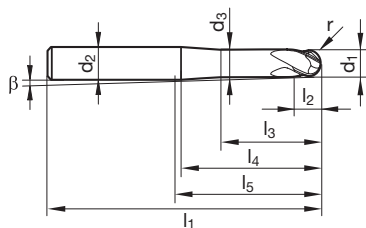

Article no.

6849

d1 ^{-0,01} _{-0,03} mm	d2 h5 mm	d3 mm	l1 mm	l2 mm	l3 mm	l4 mm	l5 mm	r mm	β °	Z
1.00	4.00	0.92	50	1.0	6.5	12.2	25.0	0.50	7.30	4
1.50	4.00	1.40	50	1.5	10.0	14.9	25.5	0.75	5.00	4
2.00	6.00	1.85	57	2.0	13.0	18.7	29.5	1.00	6.40	4
3.00	6.00	2.85	65	3.0	20.0	24.3	34.5	1.50	3.70	4
4.00	6.00	3.80	75	4.0	25.0	28.0	40.5	2.00	2.20	4
5.00	6.00	4.80	75	5.0	31.0	32.6	41.5	2.50	0.90	4
6.00	6.00	5.70	75	6.0	38.0	38.6	39.0	3.00		4
8.00	8.00	7.70	90	8.0	53.0	53.6	54.0	4.00		4
10.00	10.00	9.50	100	10.0	59.0	59.9	60.0	5.00		4
12.00	12.00	11.50	120	12.0	74.0	74.9	75.0	6.00		4

Order no.

6849 1.000
6849 1.500
6849 2.000
6849 3.000
6849 4.000
6849 5.000
6849 6.000
6849 8.000
6849 10.000
6849 12.000



Ball nose slot drills (2-fluted)

Article no. **3679**



centre cutting

Cutting data page 704

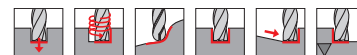
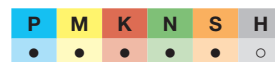

Ball nose slot drills (2-fluted)

Article no. **3049**



centre cutting

Cutting data page 704

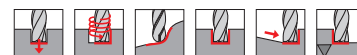

High-performance milling cutters

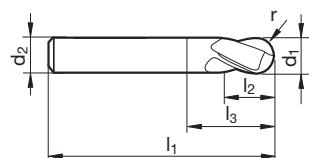

Article no. **3679** **3049**

d1 h10 mm	d2 h6 mm	l1 mm	l2 mm	l3 mm	r mm	Z	Order no.
0.50	3.00	38	1.0	2.1	0.25	2	3679 0.500
0.80	3.00	38	1.0	2.1	0.40	2	3679 0.800
1.00	3.00	38	2.0	3.9	0.50	2	3679 1.000
1.50	3.00	38	3.0	6.4	0.75	2	3679 1.500
2.00	6.00	57	6.0	9.4	1.00	2	3679 2.000 3049 2.000
3.00	6.00	57	7.0	11.9	1.50	2	3679 3.000 3049 3.000
4.00	6.00	57	8.0	13.4	2.00	2	3679 4.000 3049 4.000
5.00	6.00	57	10.0	16.9	2.50	2	3679 5.000 3049 5.000
6.00	6.00	57	10.0	21.0	3.00	2	3679 6.000 3049 6.000
8.00	8.00	63	16.0	27.0	4.00	2	3679 8.000 3049 8.000
10.00	10.00	72	19.0	32.0	5.00	2	3679 10.000 3049 10.000
12.00	12.00	83	22.0	38.0	6.00	2	3679 12.000 3049 12.000
14.00	14.00	83	22.0	38.0	7.00	2	3679 14.000 3049 14.000
14.00	16.00	92	26.0	42.0	7.00	2	3679 14.001
16.00	16.00	92	26.0	44.0	8.00	2	3679 16.000 3049 16.000
18.00	18.00	92	26.0	44.0	9.00	2	3679 18.000 3049 18.000
18.00	20.00	104	32.0	51.0	9.00	2	3679 18.001
20.00	20.00	104	32.0	54.0	10.00	2	3679 20.000 3049 20.000



Ball nose end mills (4-fluted)

Article no. **3727**



Cutting data page 704



2 face cutting edges up to the centre • centre cutting

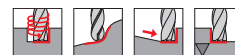
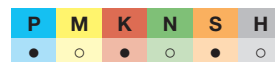

High-performance milling cutters

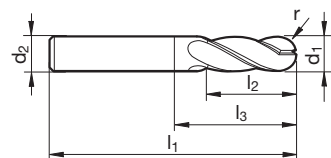

Article no. **3727**

d1 h10 mm	d2 h6 mm	l1 mm	l2 mm	l3 mm	r mm	Z	Order no.
4.00	4.00	50	11.0	22.0	2.00	4	3727 4.000
5.00	5.00	50	13.0	22.0	2.50	4	3727 5.000
6.00	6.00	57	13.0	21.0	3.00	4	3727 6.000
8.00	8.00	63	19.0	27.0	4.00	4	3727 8.000
10.00	10.00	72	22.0	32.0	5.00	4	3727 10.000
12.00	12.00	83	26.0	38.0	6.00	4	3727 12.000
14.00	14.00	83	26.0	38.0	7.00	4	3727 14.000
14.00	16.00	92	32.0	36.0	7.00	4	3727 14.001
16.00	16.00	92	32.0	44.0	8.00	4	3727 16.000
18.00	18.00	92	32.0	44.0	9.00	4	3727 18.000
18.00	20.00	104	38.0	44.0	9.00	4	3727 18.001
20.00	20.00	104	38.0	54.0	10.00	4	3727 20.000

Ball nose end mills (4-fluted)

Article no. **3050**



Cutting data page 704



2 face cutting edges up to the centre • centre cutting

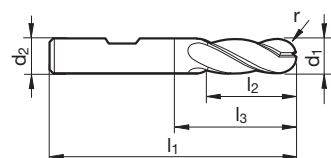
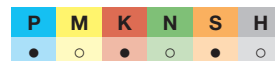

Article no. **3050**

d1 h10 mm	d2 h6 mm	l1 mm	l2 mm	l3 mm	r mm	Z	Order no.
3.00	6.00	57	8.0	11.9	1.50	4	3050 3.000
4.00	6.00	57	11.0	15.9	2.00	4	3050 4.000
5.00	6.00	57	13.0	18.9	2.50	4	3050 5.000
6.00	6.00	57	13.0	21.0	3.00	4	3050 6.000
8.00	8.00	63	19.0	27.0	4.00	4	3050 8.000
10.00	10.00	72	22.0	32.0	5.00	4	3050 10.000
12.00	12.00	83	26.0	38.0	6.00	4	3050 12.000
14.00	14.00	83	26.0	38.0	7.00	4	3050 14.000
16.00	16.00	92	32.0	44.0	8.00	4	3050 16.000
18.00	18.00	92	32.0	44.0	9.00	4	3050 18.000
20.00	20.00	104	38.0	54.0	10.00	4	3050 20.000



Ball nose slot drills XL (2-fluted)

Article no. **3030**



Cutting data page 704



centre cutting

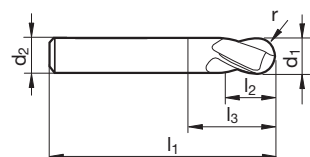
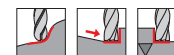
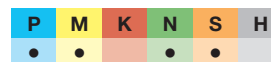

Article no. **3030**

d1 h10 mm	d2 h6 mm	l1 mm	l2 mm	l3 mm	r mm	Z	Order no.
3.00	3.00	75	20.0	47.0	1.50	2	3030 3.000
4.00	4.00	75	25.0	47.0	2.00	2	3030 4.000
5.00	5.00	75	30.0	47.0	2.50	2	3030 5.000
6.00	6.00	75	30.0	39.0	3.00	2	3030 6.000
8.00	8.00	100	40.0	64.0	4.00	2	3030 8.000
10.00	10.00	100	40.0	60.0	5.00	2	3030 10.000
12.00	12.00	150	45.0	105.0	6.00	2	3030 12.000

High-performance milling cutters

Ball nose end mills XL (4-fluted)

Article no. **3043**



Cutting data page 704



2 face cutting edges up to the centre • centre cutting

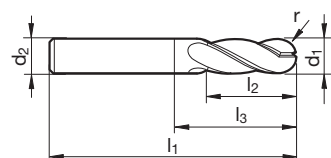
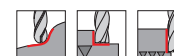
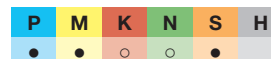

Article no. **3043**

d1 h10 mm	d2 h6 mm	l1 mm	l2 mm	l3 mm	r mm	Z	Order no.
3.00	3.00	75	20.0	47.0	1.50	4	3043 3.000
4.00	4.00	75	25.0	47.0	2.00	4	3043 4.000
5.00	5.00	75	30.0	47.0	2.50	4	3043 5.000
6.00	6.00	75	30.0	39.0	3.00	4	3043 6.000
8.00	8.00	100	40.0	64.0	4.00	4	3043 8.000
10.00	10.00	100	40.0	60.0	5.00	4	3043 10.000
12.00	12.00	150	45.0	105.0	6.00	4	3043 12.000



Torus end mills G-Mold μ 65 T

Article no. **6820**



Cutting data page 702

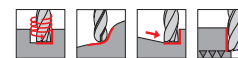
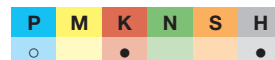

high-precision ball nose end mills for maximum form accuracy • exact tolerance of the radius contour $r = \pm 0.005 \text{ mm}$ • \varnothing tolerance $d1$ of $\varnothing 0.2\text{-}3 \text{ mm} +0.000/-0.010 \text{ mm}$ • with GühroJet peripheral cooling from $\varnothing 0.3\text{-}3 \text{ mm}$ • centre cutting • neck clearance

High-performance milling cutters

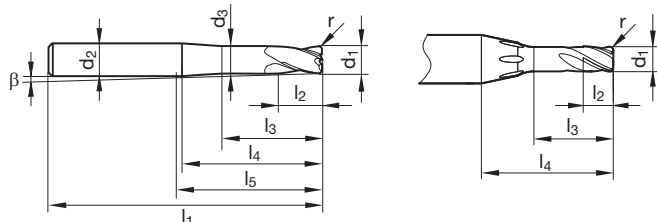

Article no.

6820

d1 f8 mm	d2 h5 mm	d3 mm	l1 mm	l2 mm	l3 mm	l4 mm	l5 mm	r mm	β °	Z	Order no.
0.30	4.00	0.28	50	0.3	0.7	9.1	22.0	0.05	11.50	2	6820 0.300
0.50	4.00	0.45	50	0.5	1.2	9.2	22.0	0.05	10.80	2	6820 0.500
0.50	4.00	0.45	50	0.5	1.2	9.2	22.0	0.10	10.80	2	6820 0.501
0.60	4.00	0.55	50	0.6	1.5	9.2	22.0	0.10	10.50	2	6820 0.601
0.60	4.00	0.55	50	0.6	1.5	9.2	22.0	0.05	10.50	2	6820 0.600
0.80	4.00	0.75	50	0.8	2.0	9.1	22.0	0.10	10.00	2	6820 0.801
0.80	4.00	0.75	50	0.8	2.0	9.1	22.0	0.05	10.00	2	6820 0.800
0.80	4.00	0.75	50	0.8	2.0	9.1	22.0	0.20	10.20	2	6820 0.802
1.00	4.00	0.92	50	1.0	2.5	9.2	22.0	0.20	9.40	2	6820 1.002
1.00	4.00	0.92	50	1.0	2.5	9.2	22.0	0.10	9.30	2	6820 1.001
1.00	4.00	0.92	50	1.0	2.5	9.2	22.0	0.30	9.50	2	6820 1.003
1.50	4.00	1.40	50	1.5	4.0	9.6	22.0	0.20	7.50	2	6820 1.502
1.50	4.00	1.40	50	1.5	4.0	9.6	22.0	0.10	7.50	2	6820 1.501
1.50	4.00	1.40	50	1.5	4.0	9.6	22.0	0.50	7.80	2	6820 1.505
2.00	6.00	1.85	50	2.0	5.0	14.2	14.0	0.20	8.10	2	6820 2.002
2.00	6.00	1.85	50	2.0	5.0	14.2	14.0	0.50	8.30	2	6820 2.005
2.50	6.00	2.35	50	2.5	6.0	14.1	14.0	0.50	7.30	2	6820 2.505
2.50	6.00	2.35	50	2.5	6.0	14.1	14.0	0.20	7.10	2	6820 2.502
3.00	6.00	2.85	50	3.0	8.0	14.9	14.9	0.20	5.80	2	6820 3.002
3.00	6.00	2.85	50	3.0	8.0	14.9	14.9	0.30	5.80	2	6820 3.003
3.00	6.00	2.85	50	3.0	8.0	14.9	14.9	0.50	5.90	2	6820 3.005
4.00	6.00	3.80	50	4.0	10.0	13.0	14.0	0.50	4.50	4	6820 4.005
4.00	6.00	3.80	50	4.0	10.0	13.0	14.0	0.20	4.40	4	6820 4.002
4.00	6.00	3.80	50	4.0	10.0	13.0	14.0	1.00	4.70	4	6820 4.010
5.00	6.00	4.80	50	5.0	12.5	14.1	14.0	0.50	2.10	4	6820 5.005
6.00	6.00	5.70	54	6.0	15.0	15.6	18.0	0.50		4	6820 6.005
6.00	6.00	5.70	54	6.0	15.0	15.6	18.0	0.20		4	6820 6.002
6.00	6.00	5.70	54	6.0	15.0	15.6	18.0	1.00		4	6820 6.010
8.00	8.00	7.70	58	8.0	20.0	20.6	22.0	0.80		4	6820 8.008
8.00	8.00	7.70	58	8.0	20.0	20.6	22.0	0.50		4	6820 8.005
8.00	8.00	7.70	58	8.0	20.0	20.6	22.0	1.00		4	6820 8.010
10.00	10.00	9.50	72	10.0	25.0	25.9	32.0	1.00		4	6820 10.010
10.00	10.00	9.50	72	10.0	25.0	25.9	32.0	0.50		4	6820 10.005
10.00	10.00	9.50	72	10.0	25.0	25.9	32.0	2.00		4	6820 10.020
12.00	12.00	11.50	73	12.0	30.0	30.9	28.0	0.50		4	6820 12.005
12.00	12.00	11.50	73	12.0	30.0	30.9	28.0	1.00		4	6820 12.010
12.00	12.00	11.50	73	12.0	30.0	30.9	28.0	2.00		4	6820 12.020



Torus end mills G-Mold μ 65 T

Article no. 6821



Cutting data page 702

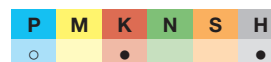

high-precision ball nose end mills for maximum form accuracy • exact tolerance of the radius contour $r = \pm 0.005 \text{ mm}$ • \varnothing tolerance d_1 of $\varnothing 0.2\text{-}3 \text{ mm} +0.000/-0.010 \text{ mm}$ • with GühroJet peripheral cooling from $\varnothing 0.3\text{-}3 \text{ mm}$ • centre cutting • neck clearance

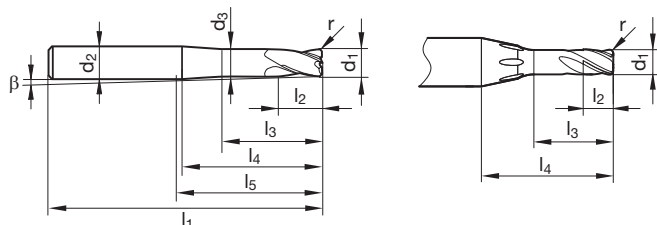
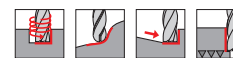

Article no.

6821

d1 f8 mm	d2 h5 mm	d3 mm	l1 mm	l2 mm	l3 mm	l4 mm	l5 mm	r mm	β °	Z	Order no.
0.30	4.00	0.28	50	0.3	1.0	9.4	22.0	0.05	11.20	2	6821 0.300
0.50	4.00	0.45	50	0.5	1.5	9.5	22.0	0.05	10.50	2	6821 0.500
0.50	4.00	0.45	50	0.5	1.5	9.5	22.0	0.10	10.50	2	6821 0.501
0.60	4.00	0.55	50	0.6	2.0	9.7	22.0	0.10	10.00	2	6821 0.601
0.60	4.00	0.55	50	0.6	2.0	9.7	22.0	0.05	10.00	2	6821 0.600
0.80	4.00	0.75	50	0.8	3.0	10.1	22.0	0.10	9.10	2	6821 0.801
0.80	4.00	0.75	50	0.8	3.0	10.1	22.0	0.05	9.00	2	6821 0.800
0.80	4.00	0.75	50	0.8	3.0	10.1	22.0	0.20	9.10	2	6821 0.802
1.00	4.00	0.92	50	1.0	3.0	9.7	22.0	0.20	8.90	2	6821 1.002
1.00	4.00	0.92	50	1.0	3.0	9.7	22.0	0.10	8.80	2	6821 1.001
1.00	4.00	0.92	50	1.0	3.0	9.7	22.0	0.30	9.00	2	6821 1.003
1.50	4.00	1.40	50	1.5	6.0	11.6	22.0	0.20	6.20	2	6821 1.502
1.50	4.00	1.40	50	1.5	6.0	11.6	22.0	0.10	6.20	2	6821 1.501
1.50	4.00	1.40	50	1.5	6.0	11.6	22.0	0.50	6.40	2	6821 1.505
2.00	6.00	1.85	50	2.0	6.0	15.2	15.2	0.20	7.60	2	6821 2.002
2.00	6.00	1.85	50	2.0	6.0	15.2	15.2	0.50	7.70	2	6821 2.005
2.50	6.00	2.35	50	2.5	8.0	16.1	16.1	0.50	6.40	2	6821 2.505
2.50	6.00	2.35	50	2.5	8.0	16.1	16.1	0.20	6.20	2	6821 2.502
3.00	6.00	2.85	57	3.0	10.0	16.9	21.0	0.20	5.10	2	6821 3.002
3.00	6.00	2.85	57	3.0	10.0	16.9	21.0	0.30	5.10	2	6821 3.003
3.00	6.00	2.85	57	3.0	10.0	16.9	21.0	0.50	5.20	2	6821 3.005
4.00	6.00	3.80	57	4.0	14.0	17.0	21.0	0.50	3.40	4	6821 4.005
4.00	6.00	3.80	57	4.0	14.0	17.0	21.0	0.20	3.40	4	6821 4.002
4.00	6.00	3.80	57	4.0	14.0	17.0	21.0	1.00	3.50	4	6821 4.010
5.00	6.00	4.80	57	5.0	18.0	19.6	21.0	0.50	1.50	4	6821 5.005
6.00	6.00	5.70	57	6.0	20.0	20.6	21.0	0.50		4	6821 6.005
6.00	6.00	5.70	57	6.0	20.0	20.6	21.0	0.20		4	6821 6.002
6.00	6.00	5.70	57	6.0	20.0	20.6	21.0	1.00		4	6821 6.010
8.00	8.00	7.70	63	8.0	26.0	26.6	27.0	0.80		4	6821 8.008
8.00	8.00	7.70	63	8.0	26.0	26.6	27.0	0.50		4	6821 8.005
8.00	8.00	7.70	63	8.0	26.0	26.6	27.0	1.00		4	6821 8.010
10.00	10.00	9.50	72	10.0	31.0	31.9	32.0	1.00		4	6821 10.010
10.00	10.00	9.50	72	10.0	31.0	31.9	32.0	0.50		4	6821 10.005
10.00	10.00	9.50	72	10.0	31.0	31.9	32.0	2.00		4	6821 10.020
12.00	12.00	11.50	83	12.0	37.0	37.9	38.0	0.50		4	6821 12.005
12.00	12.00	11.50	83	12.0	37.0	37.9	38.0	1.00		4	6821 12.010
12.00	12.00	11.50	83	12.0	37.0	37.9	38.0	2.00		4	6821 12.020

High-performance milling cutters



Torus end mills G-Mold μ 65 T

Article no. **6822**



high-precision ball nose end mills for maximum form accuracy • exact tolerance of the radius contour $r = \pm 0.005 \text{ mm}$ • \varnothing tolerance $d1$ of $\varnothing 0.2\text{-}3 \text{ mm} +0.000/-0.010 \text{ mm}$ • with GühroJet peripheral cooling from $\varnothing 0.3\text{-}3 \text{ mm}$ • centre cutting • neck clearance

Cutting data page 702

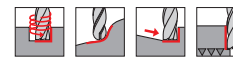
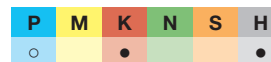

High-performance milling cutters

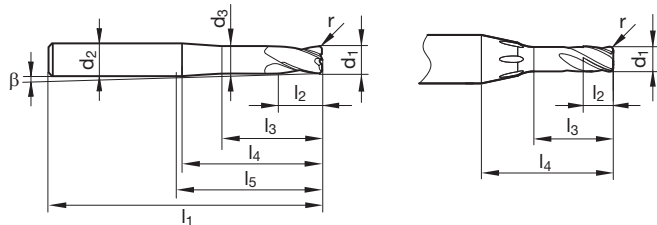

Article no.

6822

d1 f8 mm	d2 h5 mm	d3 mm	l1 mm	l2 mm	l3 mm	l4 mm	l5 mm	r mm	β °	Z	Order no.
0.30	4.00	0.28	50	0.3	1.5	9.9	22.0	0.05	10.60	2	6822 0.300
0.50	4.00	0.45	50	0.5	2.5	10.5	22.0	0.05	9.50	2	6822 0.500
0.50	4.00	0.45	50	0.5	2.5	10.5	22.0	0.10	9.50	2	6822 0.501
0.60	4.00	0.55	50	0.6	3.0	10.7	22.0	0.10	9.10	2	6822 0.601
0.60	4.00	0.55	50	0.6	3.0	10.7	22.0	0.05	9.00	2	6822 0.600
0.80	4.00	0.75	50	0.8	4.0	11.1	22.0	0.10	8.20	2	6822 0.801
0.80	4.00	0.75	50	0.8	4.0	11.1	22.0	0.05	8.20	2	6822 0.800
0.80	4.00	0.75	50	0.8	4.0	11.1	22.0	0.20	8.30	2	6822 0.802
1.00	4.00	0.92	50	1.0	5.0	11.7	22.0	0.20	7.40	2	6822 1.002
1.00	4.00	0.92	50	1.0	5.0	11.7	22.0	0.10	7.30	2	6822 1.001
1.00	4.00	0.92	50	1.0	5.0	11.7	22.0	0.30	7.50	2	6822 1.003
1.50	4.00	1.40	50	1.5	8.0	13.6	22.0	0.20	5.30	2	6822 1.502
1.50	4.00	1.40	50	1.5	8.0	13.6	22.0	0.10	5.30	2	6822 1.501
1.50	4.00	1.40	50	1.5	8.0	13.6	22.0	0.50	5.40	2	6822 1.505
2.00	6.00	1.85	50	2.0	10.0	19.2	19.2	0.20	6.00	2	6822 2.002
2.00	6.00	1.85	50	2.0	10.0	19.2	19.2	0.50	6.10	2	6822 2.005
2.50	6.00	2.35	50	2.5	12.5	20.6	20.6	0.50	4.90	2	6822 2.505
2.50	6.00	2.35	50	2.5	12.5	20.6	20.6	0.20	4.90	2	6822 2.502
3.00	6.00	2.85	65	3.0	15.0	21.9	29.0	0.20	3.90	2	6822 3.002
3.00	6.00	2.85	65	3.0	15.0	21.9	29.0	0.30	3.90	2	6822 3.003
3.00	6.00	2.85	65	3.0	15.0	21.9	29.0	0.50	4.00	2	6822 3.005
4.00	6.00	3.80	65	4.0	20.0	23.0	29.0	0.50	2.50	4	6822 4.005
4.00	6.00	3.80	65	4.0	20.0	23.0	29.0	0.20	2.50	4	6822 4.002
4.00	6.00	3.80	65	4.0	20.0	23.0	29.0	1.00	2.60	4	6822 4.010
5.00	6.00	4.80	65	5.0	25.0	26.6	29.0	0.50	1.10	4	6822 5.005
6.00	6.00	5.70	65	6.0	25.0	25.6	29.0	0.50		4	6822 6.005
6.00	6.00	5.70	65	6.0	25.0	25.6	29.0	0.20		4	6822 6.002
6.00	6.00	5.70	65	6.0	25.0	25.6	29.0	1.00		4	6822 6.010
8.00	8.00	7.70	75	8.0	30.0	30.6	39.0	0.80		4	6822 8.008
8.00	8.00	7.70	75	8.0	30.0	30.6	39.0	0.50		4	6822 8.005
8.00	8.00	7.70	75	8.0	30.0	30.6	39.0	1.00		4	6822 8.010
10.00	10.00	9.50	90	10.0	40.0	40.9	50.0	1.00		4	6822 10.010
10.00	10.00	9.50	90	10.0	40.0	40.9	50.0	0.50		4	6822 10.005
10.00	10.00	9.50	90	10.0	40.0	40.9	50.0	2.00		4	6822 10.020
12.00	12.00	11.50	100	12.0	40.0	40.9	55.0	0.50		4	6822 12.005
12.00	12.00	11.50	100	12.0	40.0	40.9	55.0	1.00		4	6822 12.010
12.00	12.00	11.50	100	12.0	40.0	40.9	55.0	2.00		4	6822 12.020



Torus end mills G-Mold μ 65 T

Article no. 6823



Cutting data page 702

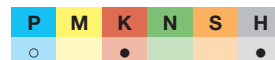

high-precision ball nose end mills for maximum form accuracy • exact tolerance of the radius contour $r = \pm 0.005 \text{ mm}$ • \varnothing tolerance d_1 of $\varnothing 0.2\text{-}3 \text{ mm} +0.000/-0.010 \text{ mm}$ • with GühroJet peripheral cooling from $\varnothing 0.3\text{-}3 \text{ mm}$ • centre cutting • neck clearance

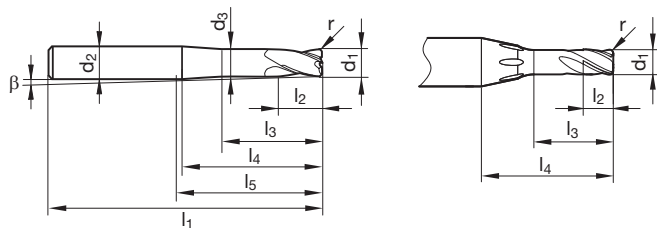
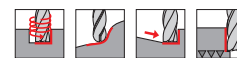

Article no.

6823

d1 f8 mm	d2 h5 mm	d3 mm	l1 mm	l2 mm	l3 mm	l4 mm	l5 mm	r mm	β °	Z	Order no.
0.30	4.00	0.28	50	0.3	2.0	10.4	22.0	0.05	10.10	2	6823 0.300
0.50	4.00	0.45	50	0.5	3.0	11.0	22.0	0.05	9.00	2	6823 0.500
0.50	4.00	0.45	50	0.5	3.0	11.0	22.0	0.10	9.10	2	6823 0.501
0.60	4.00	0.55	50	0.6	4.0	11.7	22.0	0.10	8.30	2	6823 0.601
0.60	4.00	0.55	50	0.6	4.0	11.7	22.0	0.05	8.30	2	6823 0.600
0.80	4.00	0.75	50	0.8	5.0	12.1	22.0	0.10	7.60	2	6823 0.801
0.80	4.00	0.75	50	0.8	5.0	12.1	22.0	0.05	7.50	2	6823 0.800
0.80	4.00	0.75	50	0.8	5.0	12.1	22.0	0.20	7.60	2	6823 0.802
1.00	4.00	0.92	50	1.0	8.0	14.7	22.0	0.20	5.90	2	6823 1.002
1.00	4.00	0.92	50	1.0	8.0	14.7	22.0	0.10	5.80	2	6823 1.001
1.00	4.00	0.92	50	1.0	8.0	14.7	22.0	0.30	5.90	2	6823 1.003
1.50	4.00	1.40	50	1.5	10.0	15.6	22.0	0.20	4.60	2	6823 1.502
1.50	4.00	1.40	50	1.5	10.0	15.6	22.0	0.10	4.60	2	6823 1.501
1.50	4.00	1.40	50	1.5	10.0	15.6	22.0	0.50	4.70	2	6823 1.505
2.00	6.00	1.85	57	2.0	12.0	21.2	21.0	0.20	5.40	2	6823 2.002
2.00	6.00	1.85	57	2.0	12.0	21.2	21.0	0.50	5.50	2	6823 2.005
2.50	6.00	2.35	57	2.5	15.0	23.1	21.0	0.50	4.40	2	6823 2.505
2.50	6.00	2.35	57	2.5	15.0	23.1	21.0	0.20	4.30	2	6823 2.502
3.00	6.00	2.85	65	3.0	18.0	24.9	29.0	0.20	3.40	2	6823 3.002
3.00	6.00	2.85	65	3.0	18.0	24.9	29.0	0.30	3.50	2	6823 3.003
3.00	6.00	2.85	65	3.0	18.0	24.9	29.0	0.50	3.50	2	6823 3.005
4.00	6.00	3.80	65	4.0	24.0	27.0	29.0	0.50	2.10	4	6823 4.005
4.00	6.00	3.80	65	4.0	24.0	27.0	29.0	0.20	2.10	4	6823 4.002
4.00	6.00	3.80	65	4.0	24.0	27.0	29.0	1.00	2.20	4	6823 4.010
5.00	6.00	4.80	80	5.0	30.0	31.6	44.0	0.50	0.90	4	6823 5.005
6.00	6.00	5.70	80	6.0	30.0	30.6	44.0	0.50		4	6823 6.005
6.00	6.00	5.70	80	6.0	30.0	30.6	44.0	0.20		4	6823 6.002
6.00	6.00	5.70	80	6.0	30.0	30.6	44.0	1.00		4	6823 6.010
8.00	8.00	7.70	90	8.0	40.0	40.6	54.0	0.80		4	6823 8.008
8.00	8.00	7.70	90	8.0	40.0	40.6	54.0	0.50		4	6823 8.005
8.00	8.00	7.70	90	8.0	40.0	40.6	54.0	1.00		4	6823 8.010
10.00	10.00	9.50	100	10.0	50.0	50.9	60.0	1.00		4	6823 10.010
10.00	10.00	9.50	100	10.0	50.0	50.9	60.0	0.50		4	6823 10.005
10.00	10.00	9.50	100	10.0	50.0	50.9	60.0	2.00		4	6823 10.020
12.00	12.00	11.50	120	12.0	60.0	60.9	75.0	0.50		4	6823 12.005
12.00	12.00	11.50	120	12.0	60.0	60.9	75.0	1.00		4	6823 12.010
12.00	12.00	11.50	120	12.0	60.0	60.9	75.0	2.00		4	6823 12.020

High-performance milling cutters



Torus end mills G-Mold μ 65 T

Article no. **6824**



Cutting data page 702

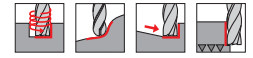
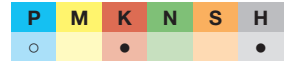

high-precision ball nose end mills for maximum form accuracy • exact tolerance of the radius contour $r = \pm 0.005 \text{ mm}$ • \varnothing tolerance $d1$ of $\varnothing 0.2\text{-}3 \text{ mm} +0.000/-0.010 \text{ mm}$ • with GühroJet peripheral cooling from $\varnothing 0.3\text{-}3 \text{ mm}$ • centre cutting • neck clearance

High-performance milling cutters

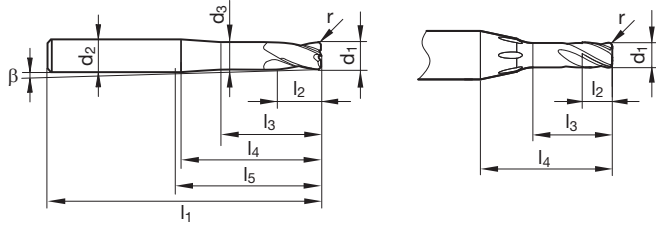

Article no.

6824

d1 f8 mm	d2 h5 mm	d3 mm	l1 mm	l2 mm	l3 mm	l4 mm	l5 mm	r mm	β °	Z	Order no.
0.30	4.00	0.28	50	0.3	3.0	11.4	22.0	0.05	9.20	2	6824 0.300
0.50	4.00	0.45	50	0.5	5.0	13.0	22.0	0.10	7.70	2	6824 0.501
0.50	4.00	0.45	50	0.5	5.0	13.0	22.0	0.05	7.70	2	6824 0.500
0.60	4.00	0.55	50	0.6	6.0	13.7	22.0	0.10	7.10	2	6824 0.601
0.60	4.00	0.55	50	0.6	6.0	13.7	22.0	0.05	7.10	2	6824 0.600
0.80	4.00	0.75	50	0.8	8.0	15.1	22.0	0.20	6.10	2	6824 0.802
0.80	4.00	0.75	50	0.8	8.0	15.1	22.0	0.05	6.00	2	6824 0.800
0.80	4.00	0.75	50	0.8	8.0	15.1	22.0	0.10	6.10	2	6824 0.801
1.00	4.00	0.92	50	1.0	10.0	16.7	22.0	0.20	5.20	2	6824 1.002
1.00	4.00	0.92	50	1.0	10.0	16.7	22.0	0.10	5.10	2	6824 1.001
1.00	4.00	0.92	50	1.0	10.0	16.7	22.0	0.30	5.20	2	6824 1.003
1.50	4.00	1.40	55	1.5	16.0	21.6	27.0	0.10	3.30	2	6824 1.501
1.50	4.00	1.40	55	1.5	16.0	21.6	27.0	0.20	3.30	2	6824 1.502
1.50	4.00	1.40	55	1.5	16.0	21.6	27.0	0.50	3.30	2	6824 1.505
2.00	6.00	1.85	65	2.0	20.0	29.2	29.0	0.50	3.90	2	6824 2.005
2.00	6.00	1.85	65	2.0	20.0	29.2	29.0	0.20	3.90	2	6824 2.002
2.50	6.00	2.35	65	2.5	20.0	28.1	29.0	0.50	3.60	2	6824 2.505
2.50	6.00	2.35	65	2.5	20.0	28.1	29.0	0.20	3.50	2	6824 2.502
3.00	6.00	2.85	70	3.0	25.0	31.9	34.0	0.20	2.70	2	6824 3.002
3.00	6.00	2.85	70	3.0	25.0	31.9	34.0	0.30	2.70	2	6824 3.003
3.00	6.00	2.85	70	3.0	25.0	31.9	34.0	0.50	2.70	2	6824 3.005
4.00	6.00	3.80	75	4.0	32.0	35.0	39.0	1.00	1.60	4	6824 4.010
4.00	6.00	3.80	75	4.0	32.0	35.0	39.0	0.20	1.60	4	6824 4.002
4.00	6.00	3.80	75	4.0	32.0	35.0	39.0	0.50	1.60	4	6824 4.005
5.00	6.00	4.80	80	5.0	42.0	43.6	44.0	0.50	0.60	4	6824 5.005
6.00	6.00	5.70	100	6.0	40.0	40.6	64.0	1.00		4	6824 6.010
6.00	6.00	5.70	100	6.0	40.0	40.6	64.0	0.20		4	6824 6.002
6.00	6.00	5.70	100	6.0	40.0	40.6	64.0	0.50		4	6824 6.005
8.00	8.00	7.70	100	8.0	40.0	40.6	64.0	0.80		4	6824 8.008
8.00	8.00	7.70	100	8.0	40.0	40.6	64.0	0.50		4	6824 8.005
8.00	8.00	7.70	100	8.0	40.0	40.6	64.0	1.00		4	6824 8.010



Torus end mills G-Mold 65 T

Article no. 6837



neck clearance • centre cutting

Cutting data page 702

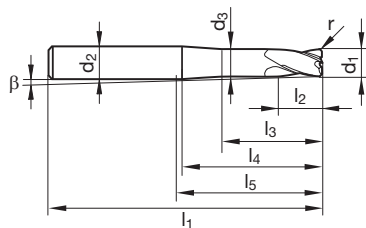
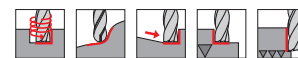
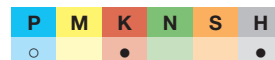

Article no.

6837

d1 f8 mm	d2 h5 mm	d3 mm	l1 mm	l2 mm	l3 mm	l4 mm	l5 mm	r mm	β °	Z	Order no.
1.00	4.00	0.92	45	1.0	4.0	9.7	17.0	0.20	8.90	4	6837 1.002
1.00	4.00	0.92	45	1.0	4.0	9.7	17.0	0.10	8.80	4	6837 1.001
1.50	4.00	1.40	45	1.5	6.0	10.9	17.0	0.20	6.60	4	6837 1.502
2.00	6.00	1.85	54	2.0	8.0	13.7	18.0	0.10	8.30	4	6837 2.001
2.00	6.00	1.85	54	2.0	8.0	13.7	18.0	0.20	8.40	4	6837 2.002
2.00	6.00	1.85	54	2.0	8.0	13.7	18.0	0.50	8.60	4	6837 2.005
3.00	6.00	2.85	54	3.0	12.0	16.3	18.0	0.30	5.30	4	6837 3.003
3.00	6.00	2.85	54	3.0	12.0	16.3	18.0	0.10	5.30	4	6837 3.001
3.00	6.00	2.85	54	3.0	12.0	16.3	18.0	0.50	5.40	4	6837 3.005
4.00	6.00	3.80	57	4.0	14.0	17.0	21.0	0.30	3.40	4	6837 4.003
4.00	6.00	3.80	57	4.0	14.0	17.0	21.0	0.20	3.40	4	6837 4.002
4.00	6.00	3.80	57	4.0	14.0	17.0	21.0	0.50	3.40	4	6837 4.005
5.00	6.00	4.80	57	5.0	17.0	18.6	21.0	0.20	1.50	4	6837 5.002
5.00	6.00	4.80	57	5.0	17.0	18.6	21.0	0.50	1.50	4	6837 5.005
5.00	6.00	4.80	57	5.0	17.0	18.6	21.0	1.00	1.60	4	6837 5.010
6.00	6.00	5.70	57	6.0	20.0	20.6	21.0	1.00		4	6837 6.010
6.00	6.00	5.70	57	6.0	20.0	20.6	21.0	0.20		4	6837 6.002
6.00	6.00	5.70	57	6.0	20.0	20.6	21.0	0.30		4	6837 6.003
6.00	6.00	5.70	57	6.0	20.0	20.6	21.0	0.50		4	6837 6.005
6.00	6.00	5.70	57	6.0	20.0	20.6	21.0	1.50		4	6837 6.015
6.00	6.00	5.70	57	6.0	20.0	20.6	21.0	2.00		4	6837 6.020
8.00	8.00	7.70	63	8.0	26.0	26.6	27.0	1.00		4	6837 8.010
8.00	8.00	7.70	63	8.0	26.0	26.6	27.0	0.30		4	6837 8.003
8.00	8.00	7.70	63	8.0	26.0	26.6	27.0	0.50		4	6837 8.005
8.00	8.00	7.70	63	8.0	26.0	26.6	27.0	1.50		4	6837 8.015
8.00	8.00	7.70	63	8.0	26.0	26.6	27.0	2.00		4	6837 8.020
10.00	10.00	9.50	72	10.0	31.0	31.9	32.0	1.50		4	6837 10.015
10.00	10.00	9.50	72	10.0	31.0	31.9	32.0	0.30		4	6837 10.003
10.00	10.00	9.50	72	10.0	31.0	31.9	32.0	0.50		4	6837 10.005
10.00	10.00	9.50	72	10.0	31.0	31.9	32.0	1.00		4	6837 10.010
10.00	10.00	9.50	72	10.0	31.0	31.9	32.0	2.00		4	6837 10.020
10.00	10.00	9.50	72	10.0	31.0	31.9	32.0	3.00		4	6837 10.030
12.00	12.00	11.50	83	12.0	37.0	37.9	38.0	2.00		4	6837 12.020
12.00	12.00	11.50	83	12.0	37.0	37.9	38.0	0.50		4	6837 12.005
12.00	12.00	11.50	83	12.0	37.0	37.9	38.0	1.00		4	6837 12.010
12.00	12.00	11.50	83	12.0	37.0	37.9	38.0	3.00		4	6837 12.030
12.00	12.00	11.50	83	12.0	37.0	37.9	38.0	4.00		4	6837 12.040

High-performance milling cutters



Torus end mills G-Mold 65 T

Article no. **6838**



neck clearance • centre cutting

Cutting data page 702

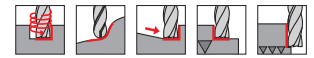
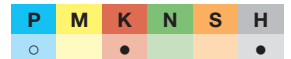

High-performance milling cutters

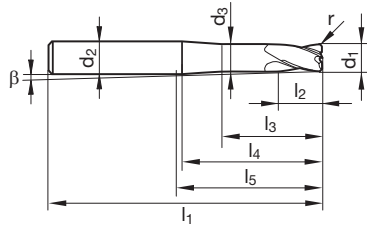

Article no.

6838

d1 f8 mm	d2 h5 mm	d3 mm	l1 mm	l2 mm	l3 mm	l4 mm	l5 mm	r mm	β °	Z	Order no.
1.00	4.00	0.92	50	1.0	6.5	12.2	22.0	0.20	7.10	4	6838 1.002
1.00	4.00	0.92	50	1.0	6.5	12.2	22.0	0.10	7.00	4	6838 1.001
1.50	4.00	1.40	50	1.5	10.0	14.9	22.0	0.20	4.80	4	6838 1.502
2.00	6.00	1.85	57	2.0	13.0	18.7	21.0	0.10	6.10	4	6838 2.001
2.00	6.00	1.85	57	2.0	13.0	18.7	21.0	0.20	6.10	4	6838 2.002
2.00	6.00	1.85	57	2.0	13.0	18.7	21.0	0.50	6.20	4	6838 2.005
3.00	6.00	2.85	65	3.0	20.0	24.3	29.0	0.30	3.50	4	6838 3.003
3.00	6.00	2.85	65	3.0	20.0	24.3	29.0	0.10	3.50	4	6838 3.001
3.00	6.00	2.85	65	3.0	20.0	24.3	29.0	0.50	3.60	4	6838 3.005
4.00	6.00	3.80	75	4.0	25.0	28.0	39.0	0.30	2.00	4	6838 4.003
4.00	6.00	3.80	75	4.0	25.0	28.0	39.0	0.20	2.00	4	6838 4.002
4.00	6.00	3.80	75	4.0	25.0	28.0	39.0	0.50	2.00	4	6838 4.005
5.00	6.00	4.80	75	5.0	31.0	32.6	39.0	0.20	0.80	4	6838 5.002
5.00	6.00	4.80	75	5.0	31.0	32.6	39.0	0.50	0.90	4	6838 5.005
5.00	6.00	4.80	75	5.0	31.0	32.6	39.0	1.00	0.90	4	6838 5.010
6.00	6.00	5.70	75	6.0	38.0	38.6	39.0	1.00		4	6838 6.010
6.00	6.00	5.70	75	6.0	38.0	38.6	39.0	0.20		4	6838 6.002
6.00	6.00	5.70	75	6.0	38.0	38.6	39.0	0.30		4	6838 6.003
6.00	6.00	5.70	75	6.0	38.0	38.6	39.0	0.50		4	6838 6.005
6.00	6.00	5.70	75	6.0	38.0	38.6	39.0	1.50		4	6838 6.015
6.00	6.00	5.70	75	6.0	38.0	38.6	39.0	2.00		4	6838 6.020
8.00	8.00	7.70	90	8.0	53.0	53.6	54.0	1.00		4	6838 8.010
8.00	8.00	7.70	90	8.0	53.0	53.6	54.0	0.30		4	6838 8.003
8.00	8.00	7.70	90	8.0	53.0	53.6	54.0	0.50		4	6838 8.005
8.00	8.00	7.70	90	8.0	53.0	53.6	54.0	1.50		4	6838 8.015
8.00	8.00	7.70	90	8.0	53.0	53.6	54.0	2.00		4	6838 8.020
10.00	10.00	9.50	100	10.0	59.0	59.9	60.0	1.50		4	6838 10.015
10.00	10.00	9.50	100	10.0	59.0	59.9	60.0	0.30		4	6838 10.003
10.00	10.00	9.50	100	10.0	59.0	59.9	60.0	0.50		4	6838 10.005
10.00	10.00	9.50	100	10.0	59.0	59.9	60.0	1.00		4	6838 10.010
10.00	10.00	9.50	100	10.0	59.0	59.9	60.0	2.00		4	6838 10.020
10.00	10.00	9.50	100	10.0	59.0	59.9	60.0	3.00		4	6838 10.030
12.00	12.00	11.50	120	12.0	74.0	74.9	75.0	2.00		4	6838 12.020
12.00	12.00	11.50	120	12.0	74.0	74.9	75.0	0.50		4	6838 12.005
12.00	12.00	11.50	120	12.0	74.0	74.9	75.0	1.00		4	6838 12.010
12.00	12.00	11.50	120	12.0	74.0	74.9	75.0	3.00		4	6838 12.030
12.00	12.00	11.50	120	12.0	74.0	74.9	75.0	4.00		4	6838 12.040



Torus end mills G-Mold 55 T

Article no. 6850



neck clearance • centre cutting

Cutting data page 702

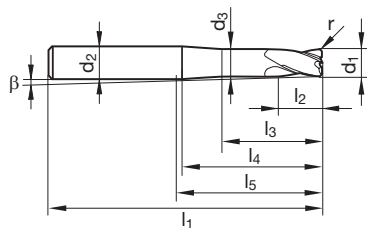
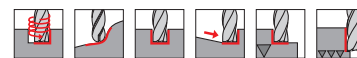
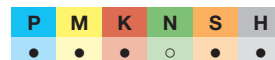

Article no. **6850**

d1 f8 mm	d2 h5 mm	d3 mm	l1 mm	l2 mm	l3 mm	l4 mm	l5 mm	r mm	β °	Z	Order no.
0.50	4.00	0.45	45	0.5	3.0	9.6	17.0	0.10	10.40	2	6850 0.501
1.00	4.00	0.92	45	1.0	4.0	9.7	17.0	0.10	8.80	2	6850 1.001
1.00	4.00	0.92	45	1.0	4.0	9.7	17.0	0.20	8.90	2	6850 1.002
1.50	4.00	1.40	45	1.5	6.0	10.9	17.0	0.20	6.60	2	6850 1.502
2.00	6.00	1.85	54	2.0	8.0	13.7	18.0	0.20	8.40	2	6850 2.002
2.00	6.00	1.85	54	2.0	8.0	13.7	18.0	0.10	8.30	2	6850 2.001
2.00	6.00	1.85	54	2.0	8.0	13.7	18.0	0.50	8.60	2	6850 2.005
3.00	6.00	2.85	54	3.0	12.0	16.3	18.0	0.30	5.30	2	6850 3.003
3.00	6.00	2.85	54	3.0	12.0	16.3	18.0	0.10	5.30	2	6850 3.001
3.00	6.00	2.85	54	3.0	12.0	16.3	18.0	0.50	5.40	2	6850 3.005
4.00	6.00	3.80	57	4.0	14.0	17.0	21.0	0.30	3.40	2	6850 4.003
4.00	6.00	3.80	57	4.0	14.0	17.0	21.0	0.20	3.40	2	6850 4.002
4.00	6.00	3.80	57	4.0	14.0	17.0	21.0	0.50	3.40	2	6850 4.005
5.00	6.00	4.80	57	5.0	17.0	18.6	21.0	0.20	1.50	2	6850 5.002
5.00	6.00	4.80	57	5.0	17.0	18.6	21.0	0.50	1.50	2	6850 5.005
5.00	6.00	4.80	57	5.0	17.0	18.6	21.0	1.00	1.60	2	6850 5.010
6.00	6.00	5.70	57	6.0	20.0	20.6	21.0	1.00		2	6850 6.010
6.00	6.00	5.70	57	6.0	20.0	20.6	21.0	0.20		2	6850 6.002
6.00	6.00	5.70	57	6.0	20.0	20.6	21.0	0.30		2	6850 6.003
6.00	6.00	5.70	57	6.0	20.0	20.6	21.0	0.50		2	6850 6.005
6.00	6.00	5.70	57	6.0	20.0	20.6	21.0	1.50		2	6850 6.015
6.00	6.00	5.70	57	6.0	20.0	20.6	21.0	2.00		2	6850 6.020
8.00	8.00	7.70	63	8.0	26.0	26.6	27.0	1.00		2	6850 8.010
8.00	8.00	7.70	63	8.0	26.0	26.6	27.0	0.30		2	6850 8.003
8.00	8.00	7.70	63	8.0	26.0	26.6	27.0	0.50		2	6850 8.005
8.00	8.00	7.70	63	8.0	26.0	26.6	27.0	1.50		2	6850 8.015
8.00	8.00	7.70	63	8.0	26.0	26.6	27.0	2.00		2	6850 8.020
10.00	10.00	9.50	72	10.0	31.0	31.9	32.0	1.50		2	6850 10.015
10.00	10.00	9.50	72	10.0	31.0	31.9	32.0	0.30		2	6850 10.003
10.00	10.00	9.50	72	10.0	31.0	31.9	32.0	0.50		2	6850 10.005
10.00	10.00	9.50	72	10.0	31.0	31.9	32.0	1.00		2	6850 10.010
10.00	10.00	9.50	72	10.0	31.0	31.9	32.0	2.00		2	6850 10.020
10.00	10.00	9.50	72	10.0	31.0	31.9	32.0	3.00		2	6850 10.030
12.00	12.00	11.50	83	12.0	37.0	37.9	38.0	2.00		2	6850 12.020
12.00	12.00	11.50	83	12.0	37.0	37.9	38.0	0.50		2	6850 12.005
12.00	12.00	11.50	83	12.0	37.0	37.9	38.0	1.00		2	6850 12.010
12.00	12.00	11.50	83	12.0	37.0	37.9	38.0	3.00		2	6850 12.030
12.00	12.00	11.50	83	12.0	37.0	37.9	38.0	4.00		2	6850 12.040

High-performance milling cutters



Torus end mills G-Mold 55 T

Article no. **6851**



Cutting data page 702



neck clearance • centre cutting

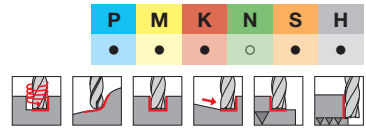

High-performance milling cutters

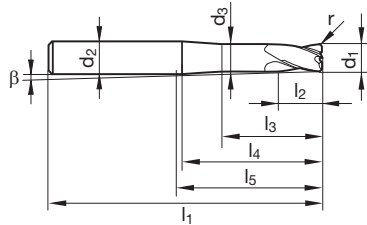

Article no.

6851

d1 f8 mm	d2 h5 mm	d3 mm	l1 mm	l2 mm	l3 mm	l4 mm	l5 mm	r mm	β °	Z	Order no.
0.50	4.00	0.45	50	0.5	3.6	10.2	22.0	0.10	9.80	2	6851 0.501
1.00	4.00	0.92	50	1.0	6.5	12.2	22.0	0.10	7.00	2	6851 1.001
1.00	4.00	0.92	50	1.0	6.5	12.2	22.0	0.20	7.10	2	6851 1.002
1.50	4.00	1.40	50	1.5	10.0	14.9	22.0	0.20	4.80	2	6851 1.502
2.00	6.00	1.85	57	2.0	13.0	18.7	21.0	0.20	6.10	2	6851 2.002
2.00	6.00	1.85	57	2.0	13.0	18.7	21.0	0.10	6.10	2	6851 2.001
2.00	6.00	1.85	57	2.0	13.0	18.7	21.0	0.50	6.20	2	6851 2.005
3.00	6.00	2.85	65	3.0	20.0	24.3	29.0	0.30	3.50	2	6851 3.003
3.00	6.00	2.85	65	3.0	20.0	24.3	29.0	0.10	3.50	2	6851 3.001
3.00	6.00	2.85	65	3.0	20.0	24.3	29.0	0.50	3.60	2	6851 3.005
4.00	6.00	3.80	75	4.0	25.0	28.0	39.0	0.30	2.00	2	6851 4.003
4.00	6.00	3.80	75	4.0	25.0	28.0	39.0	0.20	2.00	2	6851 4.002
4.00	6.00	3.80	75	4.0	25.0	28.0	39.0	0.50	2.00	2	6851 4.005
5.00	6.00	4.80	75	5.0	31.0	32.6	39.0	0.20	0.80	2	6851 5.002
5.00	6.00	4.80	75	5.0	31.0	32.6	39.0	0.50	0.90	2	6851 5.005
5.00	6.00	4.80	75	5.0	31.0	32.6	39.0	1.00	0.90	2	6851 5.010
6.00	6.00	5.70	75	6.0	38.0	38.6	39.0	1.00		2	6851 6.010
6.00	6.00	5.70	75	6.0	38.0	38.6	39.0	0.20		2	6851 6.002
6.00	6.00	5.70	75	6.0	38.0	38.6	39.0	0.30		2	6851 6.003
6.00	6.00	5.70	75	6.0	38.0	38.6	39.0	0.50		2	6851 6.005
6.00	6.00	5.70	75	6.0	38.0	38.6	39.0	1.50		2	6851 6.015
6.00	6.00	5.70	75	6.0	38.0	38.6	39.0	2.00		2	6851 6.020
8.00	8.00	7.70	90	8.0	53.0	53.6	54.0	1.00		2	6851 8.010
8.00	8.00	7.70	90	8.0	53.0	53.6	54.0	0.30		2	6851 8.003
8.00	8.00	7.70	90	8.0	53.0	53.6	54.0	0.50		2	6851 8.005
8.00	8.00	7.70	90	8.0	53.0	53.6	54.0	1.50		2	6851 8.015
8.00	8.00	7.70	90	8.0	53.0	53.6	54.0	2.00		2	6851 8.020
10.00	10.00	9.50	100	10.0	59.0	59.9	60.0	1.50		2	6851 10.015
10.00	10.00	9.50	100	10.0	59.0	59.9	60.0	0.30		2	6851 10.003
10.00	10.00	9.50	100	10.0	59.0	59.9	60.0	0.50		2	6851 10.005
10.00	10.00	9.50	100	10.0	59.0	59.9	60.0	1.00		2	6851 10.010
10.00	10.00	9.50	100	10.0	59.0	59.9	60.0	2.00		2	6851 10.020
10.00	10.00	9.50	100	10.0	59.0	59.9	60.0	3.00		2	6851 10.030
12.00	12.00	11.50	120	12.0	74.0	74.9	75.0	2.00		2	6851 12.020
12.00	12.00	11.50	120	12.0	74.0	74.9	75.0	0.50		2	6851 12.005
12.00	12.00	11.50	120	12.0	74.0	74.9	75.0	1.00		2	6851 12.010
12.00	12.00	11.50	120	12.0	74.0	74.9	75.0	3.00		2	6851 12.030
12.00	12.00	11.50	120	12.0	74.0	74.9	75.0	4.00		2	6851 12.040



Torus end mills G-Mold 55 T

Article no. 6852



neck clearance • centre cutting

Cutting data page 702

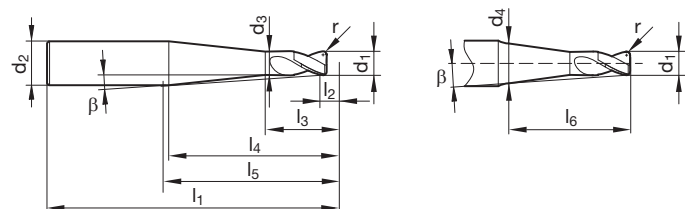
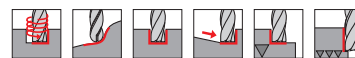
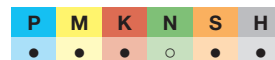

Article no.													6852
													Order no.
1.00	4.00	0.92	1.99	50	1.0	2.5	23.7	22.0	20.0	0.20	1.50	2	6852 1.002
2.00	6.00	1.85	4.04	80	2.0	5.0	43.6	44.0	40.0	0.20	1.50	2	6852 2.002
2.00	6.00	1.85	4.04	80	2.0	5.0	43.6	44.0	40.0	0.50	1.50	2	6852 2.005
3.00	6.00	2.85	5.04	80	3.0	7.5	41.8	44.0	40.0	0.20	1.50	2	6852 3.002
3.00	6.00	2.85	5.04	80	3.0	7.5	41.8	44.0	40.0	0.50	1.50	2	6852 3.005
4.00	6.00	3.80		80	4.0	10.0	40.1	44.0		0.50	1.50	2	6852 4.005
4.00	6.00	3.80		80	4.0	10.0	40.1	44.0		0.20	1.50	2	6852 4.002
6.00	8.00	5.70		90	6.0	15.0	40.1	54.0		0.50	1.50	2	6852 6.005
6.00	8.00	5.70		90	6.0	15.0	40.1	54.0		0.20	1.50	2	6852 6.002
6.00	8.00	5.70		90	6.0	15.0	40.1	54.0		1.00	1.50	2	6852 6.010
8.00	10.00	7.70		100	8.0	20.0	40.1	60.0		0.50	1.50	2	6852 8.005
8.00	10.00	7.70		100	8.0	20.0	40.1	60.0		0.30	1.50	2	6852 8.003
8.00	10.00	7.70		100	8.0	20.0	40.1	60.0		1.00	1.50	2	6852 8.010
10.00	12.00	9.50		120	10.0	25.0	40.1	75.0		0.50	1.50	2	6852 10.005
10.00	12.00	9.50		120	10.0	25.0	40.1	75.0		1.00	1.50	2	6852 10.010
10.00	12.00	9.50		120	10.0	25.0	40.1	75.0		1.50	1.50	2	6852 10.015
10.00	12.00	9.50		120	10.0	25.0	40.1	75.0		2.00	1.50	2	6852 10.020

Torus end mills G-Mold 55 T

Article no. 6853



neck clearance • centre cutting

Cutting data page 702

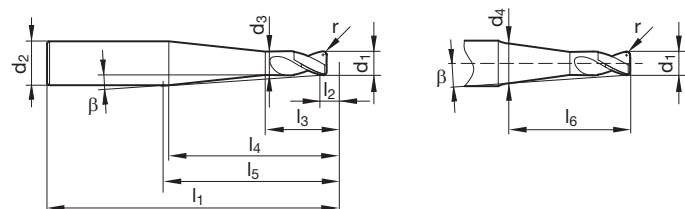
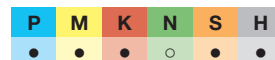

Article no.													6853
													Order no.
1.00	4.00	0.92	1.65	63	1.0	2.5	24.4	35.0	20.0	0.20	1.00	2	6853 1.002
2.00	6.00	1.85	3.35	80	2.0	5.0	44.9	44.0	40.0	0.50	1.00	2	6853 2.005
2.00	6.00	1.85	3.35	80	2.0	5.0	44.9	44.0	40.0	0.20	1.00	2	6853 2.002
3.00	6.00	2.85	4.35	80	3.0	7.5	43.1	44.0	40.0	0.50	1.00	2	6853 3.005
3.00	6.00	2.85	4.35	80	3.0	7.5	43.1	44.0	40.0	0.20	1.00	2	6853 3.002
4.00	6.00	3.80	5.35	80	4.0	10.0	41.2	44.0	40.0	0.20	1.00	2	6853 4.002
4.00	6.00	3.80	5.35	80	4.0	10.0	41.2	44.0	40.0	0.50	1.00	2	6853 4.005
6.00	8.00	5.70	7.70	100	6.0	15.0	50.6	64.0	50.0	0.50	1.00	2	6853 6.005
6.00	8.00	5.70	7.70	100	6.0	15.0	50.6	64.0	50.0	0.20	1.00	2	6853 6.002
8.00	10.00	7.70		100	8.0	20.0	60.2	60.0		0.50	1.00	2	6853 8.005
8.00	10.00	7.70		100	8.0	20.0	60.2	60.0		1.00	1.00	2	6853 8.010



Torus end mills G-Mold 55 T

Article no. **6854**



neck clearance • centre cutting

Cutting data page 702

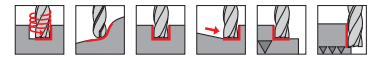

High-performance milling cutters

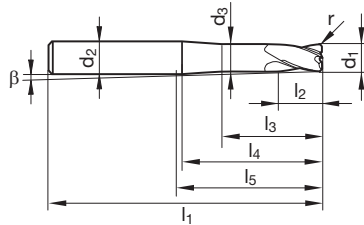

Article no.

6854

d1 f8 mm	d2 h5 mm	d3 mm	l1 mm	l2 mm	l3 mm	l4 mm	l5 mm	r mm	β °	Z	Order no.
1.00	4.00	0.92	45	1.0	4.0	9.7	17.0	0.20	8.90	4	6854 1.002
1.00	4.00	0.92	45	1.0	4.0	9.7	17.0	0.10	8.80	4	6854 1.001
1.50	4.00	1.40	45	1.5	6.0	10.9	17.0	0.20	6.60	4	6854 1.502
2.00	6.00	1.85	54	2.0	8.0	13.7	18.0	0.10	8.30	4	6854 2.001
2.00	6.00	1.85	54	2.0	8.0	13.7	18.0	0.20	8.40	4	6854 2.002
2.00	6.00	1.85	54	2.0	8.0	13.7	18.0	0.50	8.60	4	6854 2.005
3.00	6.00	2.85	54	3.0	12.0	16.3	18.0	0.30	5.30	4	6854 3.003
3.00	6.00	2.85	54	3.0	12.0	16.3	18.0	0.10	5.30	4	6854 3.001
3.00	6.00	2.85	54	3.0	12.0	16.3	18.0	0.50	5.40	4	6854 3.005
4.00	6.00	3.80	57	4.0	14.0	17.0	21.0	0.30	3.40	4	6854 4.003
4.00	6.00	3.80	57	4.0	14.0	17.0	21.0	0.20	3.40	4	6854 4.002
4.00	6.00	3.80	57	4.0	14.0	17.0	21.0	0.50	3.40	4	6854 4.005
5.00	6.00	4.80	57	5.0	17.0	18.6	21.0	0.20	1.50	4	6854 5.002
5.00	6.00	4.80	57	5.0	17.0	18.6	21.0	0.50	1.50	4	6854 5.005
5.00	6.00	4.80	57	5.0	17.0	18.6	21.0	1.00	1.60	4	6854 5.010
6.00	6.00	5.70	57	6.0	20.0	20.6	21.0	1.00		4	6854 6.010
6.00	6.00	5.70	57	6.0	20.0	20.6	21.0	0.20		4	6854 6.002
6.00	6.00	5.70	57	6.0	20.0	20.6	21.0	0.30		4	6854 6.003
6.00	6.00	5.70	57	6.0	20.0	20.6	21.0	0.50		4	6854 6.005
6.00	6.00	5.70	57	6.0	20.0	20.6	21.0	1.50		4	6854 6.015
6.00	6.00	5.70	57	6.0	20.0	20.6	21.0	2.00		4	6854 6.020
8.00	8.00	7.70	63	8.0	26.0	26.6	27.0	1.00		4	6854 8.010
8.00	8.00	7.70	63	8.0	26.0	26.6	27.0	0.30		4	6854 8.003
8.00	8.00	7.70	63	8.0	26.0	26.6	27.0	0.50		4	6854 8.005
8.00	8.00	7.70	63	8.0	26.0	26.6	27.0	1.50		4	6854 8.015
8.00	8.00	7.70	63	8.0	26.0	26.6	27.0	2.00		4	6854 8.020
10.00	10.00	9.50	72	10.0	31.0	31.9	32.0	1.50		4	6854 10.015
10.00	10.00	9.50	72	10.0	31.0	31.9	32.0	0.30		4	6854 10.003
10.00	10.00	9.50	72	10.0	31.0	31.9	32.0	0.50		4	6854 10.005
10.00	10.00	9.50	72	10.0	31.0	31.9	32.0	1.00		4	6854 10.010
10.00	10.00	9.50	72	10.0	31.0	31.9	32.0	2.00		4	6854 10.020
10.00	10.00	9.50	72	10.0	31.0	31.9	32.0	3.00		4	6854 10.030
12.00	12.00	11.50	83	12.0	37.0	37.9	38.0	2.00		4	6854 12.020
12.00	12.00	11.50	83	12.0	37.0	37.9	38.0	0.50		4	6854 12.005
12.00	12.00	11.50	83	12.0	37.0	37.9	38.0	1.00		4	6854 12.010
12.00	12.00	11.50	83	12.0	37.0	37.9	38.0	3.00		4	6854 12.030
12.00	12.00	11.50	83	12.0	37.0	37.9	38.0	4.00		4	6854 12.040



Torus end mills G-Mold 55 T

Article no. 6855



Cutting data page 702



neck clearance • centre cutting

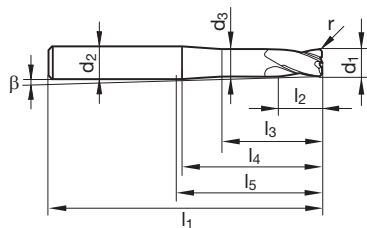
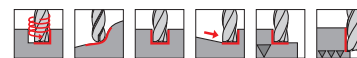
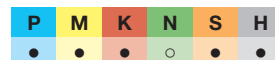

Article no. **6855**

d1 f8 mm	d2 h5 mm	d3 mm	l1 mm	l2 mm	l3 mm	l4 mm	l5 mm	r mm	β °	Z	Order no.
1.00	4.00	0.92	50	1.0	6.5	12.2	20.0	0.20	7.10	4	6855 1.002
1.00	4.00	0.92	50	1.0	6.5	12.2	20.0	0.10	7.00	4	6855 1.001
1.50	4.00	1.40	50	1.5	10.0	14.9	20.0	0.20	4.80	4	6855 1.502
2.00	6.00	1.85	57	2.0	13.0	18.7	17.0	0.10	6.10	4	6855 2.001
2.00	6.00	1.85	57	2.0	13.0	18.7	17.0	0.20	6.10	4	6855 2.002
2.00	6.00	1.85	57	2.0	13.0	18.7	17.0	0.50	6.20	4	6855 2.005
3.00	6.00	2.85	65	3.0	20.0	24.3	25.0	0.30	3.50	4	6855 3.003
3.00	6.00	2.85	65	3.0	20.0	24.3	25.0	0.10	3.50	4	6855 3.001
3.00	6.00	2.85	65	3.0	20.0	24.3	25.0	0.50	3.60	4	6855 3.005
4.00	6.00	3.80	75	4.0	25.0	28.0	35.0	0.30	2.00	4	6855 4.003
4.00	6.00	3.80	75	4.0	25.0	28.0	35.0	0.20	2.00	4	6855 4.002
4.00	6.00	3.80	75	4.0	25.0	28.0	35.0	0.50	2.00	4	6855 4.005
5.00	6.00	4.80	75	5.0	31.0	32.6	35.0	0.20	0.80	4	6855 5.002
5.00	6.00	4.80	75	5.0	31.0	32.6	35.0	0.50	0.90	4	6855 5.005
5.00	6.00	4.80	75	5.0	31.0	32.6	35.0	1.00	0.90	4	6855 5.010
6.00	6.00	5.70	75	6.0	38.0	38.6	35.0	1.00		4	6855 6.010
6.00	6.00	5.70	75	6.0	38.0	38.6	35.0	0.20		4	6855 6.002
6.00	6.00	5.70	75	6.0	38.0	38.6	35.0	0.30		4	6855 6.003
6.00	6.00	5.70	75	6.0	38.0	38.6	35.0	0.50		4	6855 6.005
6.00	6.00	5.70	75	6.0	38.0	38.6	35.0	1.50		4	6855 6.015
6.00	6.00	5.70	75	6.0	38.0	38.6	35.0	2.00		4	6855 6.020
8.00	8.00	7.70	90	8.0	53.0	53.6	50.0	1.00		4	6855 8.010
8.00	8.00	7.70	90	8.0	53.0	53.6	50.0	0.30		4	6855 8.003
8.00	8.00	7.70	90	8.0	53.0	53.6	50.0	0.50		4	6855 8.005
8.00	8.00	7.70	90	8.0	53.0	53.6	50.0	1.50		4	6855 8.015
8.00	8.00	7.70	90	8.0	53.0	53.6	50.0	2.00		4	6855 8.020
10.00	10.00	9.50	100	10.0	59.0	59.9	55.0	1.50		4	6855 10.015
10.00	10.00	9.50	100	10.0	59.0	59.9	55.0	0.30		4	6855 10.003
10.00	10.00	9.50	100	10.0	59.0	59.9	55.0	0.50		4	6855 10.005
10.00	10.00	9.50	100	10.0	59.0	59.9	55.0	1.00		4	6855 10.010
10.00	10.00	9.50	100	10.0	59.0	59.9	55.0	2.00		4	6855 10.020
10.00	10.00	9.50	100	10.0	59.0	59.9	55.0	3.00		4	6855 10.030
12.00	12.00	11.50	120	12.0	74.0	74.9	75.0	2.00		4	6855 12.020
12.00	12.00	11.50	120	12.0	74.0	74.9	75.0	0.50		4	6855 12.005
12.00	12.00	11.50	120	12.0	74.0	74.9	75.0	1.00		4	6855 12.010
12.00	12.00	11.50	120	12.0	74.0	74.9	75.0	3.00		4	6855 12.030
12.00	12.00	11.50	120	12.0	74.0	74.9	75.0	4.00		4	6855 12.040

High-performance milling cutters



High-feed end mills G-Mold 65 HF

Article no. **6830**



for high-feed roughing with low ap and maximum fz • with central internal cooling from Ø 4 mm • with GühroJet peripheral cooling from Ø 1-3 mm • neck clearance • without centre cutting

Cutting data page 699

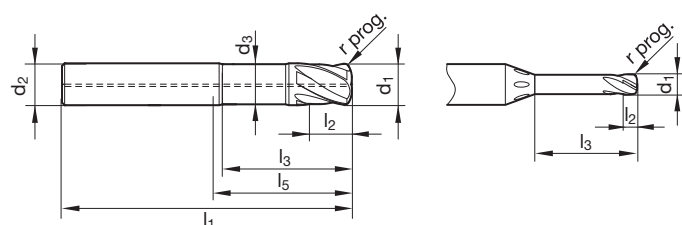
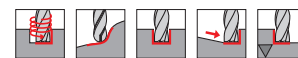
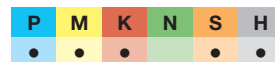

High-performance milling cutters

Article no. **6830**

d1 h10 mm	d2 h6 mm	d3 mm	l1 mm	l2 mm	l3 mm	l5 mm	r prog. mm	Z	Order no.
1.00	4.00	0.92	50	0.6	5.0	22.0	0.18	4	6830 1.000
1.50	4.00	1.40	50	1.0	7.5	22.0	0.25	4	6830 1.500
2.00	6.00	1.85	57	1.2	10.0	21.0	0.35	4	6830 2.000
2.50	6.00	2.35	57	1.5	12.5	21.0	0.40	4	6830 2.500
3.00	6.00	2.85	57	2.0	15.0	21.0	0.50	4	6830 3.000
4.00	6.00	3.80	57	3.0	18.0	21.0	0.80	4	6830 4.000
5.00	6.00	4.80	57	4.0	20.0	21.0	0.80	4	6830 5.000
6.00	6.00	5.70	57	5.0	20.0	21.0	1.00	4	6830 6.000
8.00	8.00	7.70	63	6.0	26.0	27.0	1.50	4	6830 8.000
10.00	10.00	9.50	72	8.0	30.0	32.0	2.00	4	6830 10.000
12.00	12.00	11.50	83	10.0	36.0	38.0	2.00	4	6830 12.000
16.00	16.00	15.50	92	12.0	42.0	44.0	2.50	4	6830 16.000

High-feed end mills G-Mold 65 HF

Article no. **6814**



for high-feed roughing with low ap and maximum fz • with central internal cooling from Ø 4 mm • with GühroJet peripheral cooling from Ø 1-3 mm • neck clearance • without centre cutting

Cutting data page 699

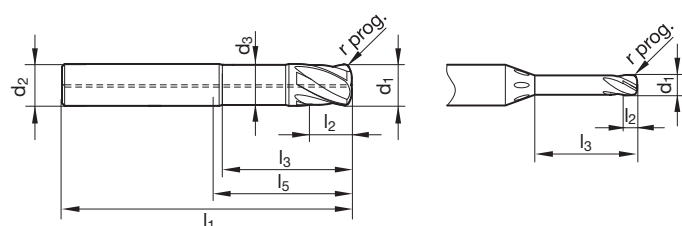
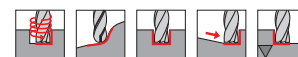
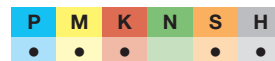

Article no. **6814**

d1 h10 mm	d2 h6 mm	d3 mm	l1 mm	l2 mm	l3 mm	l5 mm	r prog. mm	Z	Order no.
1.00	4.00	0.92	50	0.6	8.0	24.8	0.18	4	6814 1.000
1.50	4.00	1.40	50	1.0	12.0	25.2	0.25	4	6814 1.500
2.00	6.00	1.85	57	1.2	16.0	29.1	0.35	4	6814 2.000
2.50	6.00	2.35	65	1.5	20.0	33.5	0.40	4	6814 2.500
3.00	6.00	2.85	65	2.0	24.0	34.0	0.50	4	6814 3.000
4.00	6.00	3.80	65	3.0	26.0	29.0	0.80	4	6814 4.000
5.00	6.00	4.80	65	4.0	27.0	29.0	0.80	4	6814 5.000
6.00	6.00	5.70	65	5.0	28.0	29.0	1.00	4	6814 6.000
8.00	8.00	7.70	75	6.0	38.0	39.0	1.50	4	6814 8.000
10.00	10.00	9.50	100	8.0	58.0	60.0	2.00	4	6814 10.000
12.00	12.00	11.50	100	10.0	53.0	55.0	2.00	4	6814 12.000
16.00	16.00	15.50	125	12.0	75.0	77.0	2.50	4	6814 16.000



High-feed end mills G-Mold 65 HF

Article no. 6831



for high-feed roughing with low ap and maximum fz • with central internal cooling from Ø 4 mm • with GühroJet peripheral cooling from Ø 1-3 mm • neck clearance • without centre cutting

Cutting data page 699

P	M	K	N	S	H
•	•	•	•	•	•

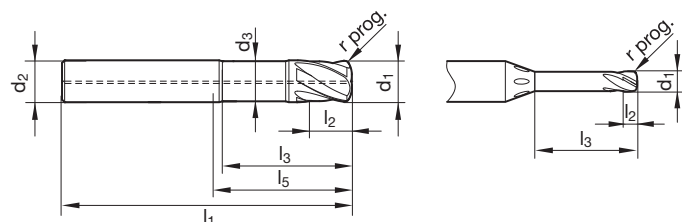
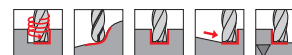

Article no. 6831

d1 h10 mm	d2 h6 mm	d3 mm	l1 mm	l2 mm	l3 mm	l5 mm	r prog. mm	Z	Order no.
1.00	4.00	0.92	50	0.6	10.0	22.0	0.18	4	6831 1.000
1.50	4.00	1.40	50	1.0	15.0	22.0	0.25	4	6831 1.500
2.00	6.00	1.85	65	1.2	20.0	29.0	0.35	4	6831 2.000
2.50	6.00	2.35	65	1.5	25.0	29.0	0.40	4	6831 2.500
3.00	6.00	2.85	80	2.0	30.0	44.0	0.50	4	6831 3.000
4.00	6.00	3.80	80	3.0	32.0	44.0	0.80	4	6831 4.000
5.00	6.00	4.80	80	4.0	40.0	44.0	0.80	4	6831 5.000
6.00	6.00	5.70	80	5.0	43.0	44.0	1.00	4	6831 6.000
8.00	8.00	7.70	100	6.0	63.0	64.0	1.50	4	6831 8.000
10.00	10.00	9.50	120	8.0	78.0	80.0	2.00	4	6831 10.000
12.00	12.00	11.50	120	10.0	73.0	75.0	2.00	4	6831 12.000
16.00	16.00	15.50	150	12.0	100.0	102.0	2.50	4	6831 16.000

High-performance milling cutters



Ratio end mills G-Mold 65 U

Article no. **6943**



Cutting data page 682



slotting up to max. 65 HRC • neck clearance • centre cutting

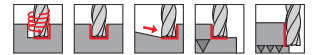

Ratio end mills G-Mold 65 U

Article no. **6944**



Cutting data page 682



slotting up to max. 65 HRC • neck clearance • centre cutting

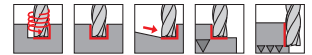
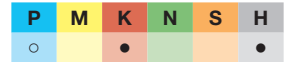

High-performance milling cutters

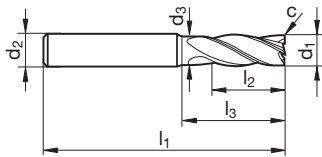

Article no.

6943

6944

d1 f9 mm	d2 h5 mm	d3 mm	l1 mm	l2 mm	l3 mm	c mm x 45°	Z	Order no.
3.00	6.00	2.85	57	8.0	12.0	0.06	4	6943 3.000 6944 3.000
4.00	6.00	3.80	57	11.0	15.0	0.08	4	6943 4.000 6944 4.000
5.00	6.00	4.80	57	13.0	18.0	0.10	4	6943 5.000 6944 5.000
6.00	6.00	5.70	57	13.0	20.0	0.12	4	6943 6.000 6944 6.000
8.00	8.00	7.70	63	19.0	26.0	0.16	4	6943 8.000 6944 8.000
10.00	10.00	9.50	72	22.0	31.0	0.20	4	6943 10.000 6944 10.000
12.00	12.00	11.50	83	26.0	37.0	0.24	4	6943 12.000 6944 12.000
16.00	16.00	15.50	92	32.0	43.0	0.32	4	6943 16.000 6944 16.000
20.00	20.00	19.50	104	38.0	53.0	0.40	4	6943 20.000 6944 20.000



Hard roughing end mills GS 100 H (fine teeth)

Article no. 3682



Cutting data page 688



centre cutting

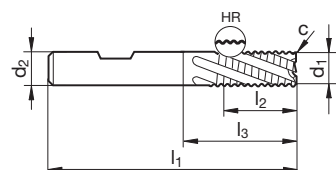
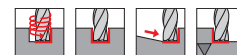
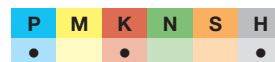

Article no.

3682

d1 h10 mm	d2 h6 mm	l1 mm	l2 mm	l3 mm	c mm x 45°	Z	Order no.
6.00	6.00	57	13.0	21.0	0.30	4	3682 6.000
8.00	8.00	63	19.0	27.0	0.30	4	3682 8.000
10.00	10.00	72	22.0	32.0	0.30	4	3682 10.000
12.00	12.00	83	26.0	38.0	0.50	4	3682 12.000
16.00	16.00	92	32.0	44.0	0.50	4	3682 16.000
20.00	20.00	104	38.0	54.0	0.50	4	3682 20.000

High-performance milling cutters



Finishing end mills G-Mold μ 65 F

Article no. **6827**

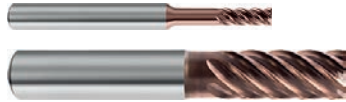

Cutting data page 686

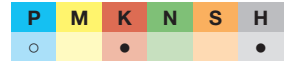

restricted tolerances for maximum component accuracy • max. taper 0.005 mm • neck clearance • Ø 3-6 mm with centre cutting • Ø 8-20 mm without centre cutting



High-performance milling cutters

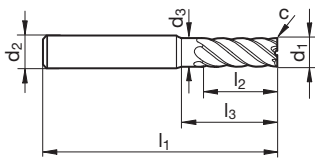

Article no. **6827**

d1 f8 mm	d2 mm	d3 mm	l1 mm	l2 mm	l3 mm	c mm x 45°	Z	Order no.
3.00	6.00	2.85	57	8.0	15.0	0.06	4	6827 3.000
4.00	6.00	3.80	57	11.0	18.0	0.08	4	6827 4.000
5.00	6.00	4.80	57	13.0	18.0	0.10	4	6827 5.000
6.00	6.00	5.70	57	13.0	20.0	0.12	4	6827 6.000
8.00	8.00	7.70	63	19.0	26.0	0.08	6	6827 8.000
10.00	10.00	9.50	72	22.0	30.0	0.10	6	6827 10.000
12.00	12.00	11.50	83	26.0	36.0	0.12	6	6827 12.000
16.00	16.00	15.50	92	32.0	42.0	0.16	6	6827 16.000
20.00	20.00	19.50	104	38.0	52.0	0.20	6	6827 20.000

Finishing end mills G-Mold μ 65 F

Article no. **6828**



Cutting data page 686

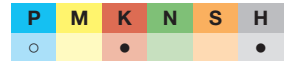

restricted tolerances for maximum component accuracy • max. taper 0.005 mm • neck clearance • Ø 3-6 mm with centre cutting • Ø 8-20 mm without centre cutting

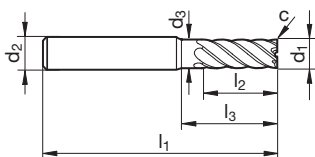

Article no. **6828**

d1 f8 mm	d2 mm	d3 mm	l1 mm	l2 mm	l3 mm	c mm x 45°	Z	Order no.
3.00	6.00	2.85	65	12.0	24.0	0.06	4	6828 3.000
4.00	6.00	3.80	65	16.0	26.0	0.08	4	6828 4.000
5.00	6.00	4.80	65	18.0	26.0	0.10	4	6828 5.000
6.00	6.00	5.70	65	21.0	28.0	0.12	4	6828 6.000
8.00	8.00	7.70	75	26.0	38.0	0.08	6	6828 8.000
10.00	10.00	9.50	80	30.0	38.0	0.10	6	6828 10.000
12.00	12.00	11.50	93	36.0	46.0	0.12	6	6828 12.000
16.00	16.00	15.50	108	48.0	58.0	0.16	6	6828 16.000
20.00	20.00	19.50	126	60.0	74.0	0.20	6	6828 20.000



Finishing end mills G-Mold 65 F

Article no. 6945



without centre cutting • neck clearance

Cutting data page 686

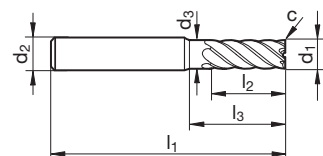
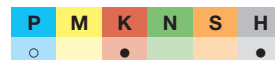

Article no. 6945

d1 f8 mm	d2 h5 mm	d3 mm	l1 mm	l2 mm	l3 mm	c mm x 45°	Z	Order no.
3.00	6.00	2.85	57	8.0	12.0	0.03	6	6945 3.000
4.00	6.00	3.80	57	11.0	15.0	0.04	6	6945 4.000
5.00	6.00	4.80	57	13.0	18.0	0.05	6	6945 5.000
6.00	6.00	5.70	57	13.0	20.0	0.06	6	6945 6.000
8.00	8.00	7.70	63	19.0	26.0	0.08	6	6945 8.000
10.00	10.00	9.50	72	22.0	31.0	0.10	6	6945 10.000
12.00	12.00	11.50	83	26.0	37.0	0.12	6	6945 12.000
14.00	14.00	13.50	83	26.0	37.0	0.14	6	6945 14.000
16.00	16.00	15.50	92	32.0	43.0	0.16	6	6945 16.000
20.00	20.00	19.50	104	38.0	53.0	0.20	6	6945 20.000

Finishing end mills G-Mold 65 F

Article no. 6946



without centre cutting • neck clearance

Cutting data page 686

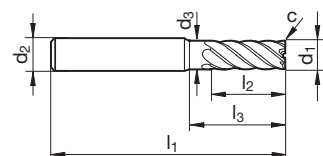
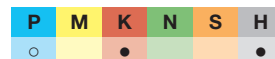

Article no. 6946

d1 f8 mm	d2 h5 mm	d3 mm	l1 mm	l2 mm	l3 mm	c mm x 45°	Z	Order no.
3.00	6.00	2.85	65	11.0	21.0	0.03	6	6946 3.000
4.00	6.00	3.80	65	14.0	26.0	0.04	6	6946 4.000
5.00	6.00	4.80	75	17.0	32.0	0.05	6	6946 5.000
6.00	6.00	5.70	75	20.0	38.0	0.06	6	6946 6.000
8.00	8.00	7.70	90	28.0	53.0	0.08	6	6946 8.000
10.00	10.00	9.50	100	31.0	59.0	0.10	6	6946 10.000
12.00	12.00	11.50	114	36.0	68.0	0.12	6	6946 12.000
14.00	14.00	13.50	100	42.0	54.0	0.14	6	6946 14.000
16.00	16.00	15.50	125	52.0	76.0	0.16	6	6946 16.000
20.00	20.00	19.50	150	62.0	100.0	0.20	6	6946 20.000



Finishing end mills with corner radius G-Mold 65 FR

Article no. **6947**

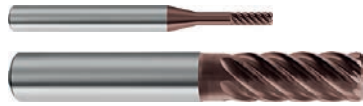

without centre cutting • neck clearance

Cutting data page 686

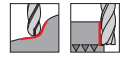
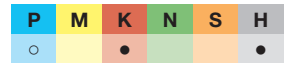

High-performance milling cutters

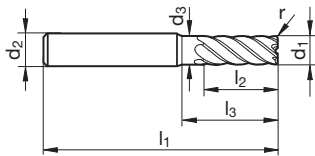

Article no.

6947

d1 f8 mm	d2 h5 mm	d3 mm	l1 mm	l2 mm	l3 mm	r mm	Z	Order no.
3.00	6.00	2.85	57	8.0	12.0	0.10	6	6947 3.001
3.00	6.00	2.85	57	8.0	12.0	0.30	6	6947 3.003
3.00	6.00	2.85	57	8.0	12.0	0.50	6	6947 3.005
4.00	6.00	3.80	57	11.0	15.0	0.20	6	6947 4.002
4.00	6.00	3.80	57	11.0	15.0	0.50	6	6947 4.005
5.00	6.00	4.80	57	13.0	18.0	0.20	6	6947 5.002
5.00	6.00	4.80	57	13.0	18.0	0.50	6	6947 5.005
6.00	6.00	5.70	57	13.0	20.0	0.20	6	6947 6.002
6.00	6.00	5.70	57	13.0	20.0	0.50	6	6947 6.005
6.00	6.00	5.70	57	13.0	20.0	1.00	6	6947 6.010
8.00	8.00	7.70	63	19.0	26.0	0.30	6	6947 8.003
8.00	8.00	7.70	63	19.0	26.0	0.50	6	6947 8.005
8.00	8.00	7.70	63	19.0	26.0	1.00	6	6947 8.010
10.00	10.00	9.50	72	22.0	31.0	0.30	6	6947 10.003
10.00	10.00	9.50	72	22.0	31.0	0.50	6	6947 10.005
10.00	10.00	9.50	72	22.0	31.0	1.00	6	6947 10.010
10.00	10.00	9.50	72	22.0	31.0	1.50	6	6947 10.015
12.00	12.00	11.50	83	26.0	37.0	0.50	6	6947 12.005
12.00	12.00	11.50	83	26.0	37.0	1.00	6	6947 12.010
12.00	12.00	11.50	83	26.0	37.0	1.50	6	6947 12.015
16.00	16.00	15.50	92	32.0	43.0	0.50	6	6947 16.005
16.00	16.00	15.50	92	32.0	43.0	1.00	6	6947 16.010
16.00	16.00	15.50	92	32.0	43.0	2.00	6	6947 16.020



Finishing end mills with corner radius G-Mold 65 FR

Article no. 6948



without centre cutting • neck clearance

Cutting data page 686

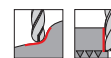
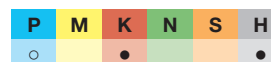

High-performance milling cutters

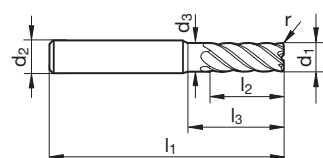

Article no.

6948

d1 f8 mm	d2 h5 mm	d3 mm	l1 mm	l2 mm	l3 mm	r mm	Z	Order no.
3.00	6.00	2.85	75	8.0	25.0	0.20	6	6948 3.002
4.00	6.00	3.80	75	11.0	30.0	0.20	6	6948 4.002
5.00	6.00	4.80	75	13.0	35.0	0.20	6	6948 5.002
6.00	6.00	5.70	80	13.0	42.0	0.50	6	6948 6.005
8.00	8.00	7.70	100	19.0	62.0	0.50	6	6948 8.005
10.00	10.00	9.50	120	22.0	78.0	0.50	6	6948 10.005
12.00	12.00	11.50	150	26.0	101.0	1.00	6	6948 12.010
16.00	16.00	15.50	150	32.0	101.0	1.00	6	6948 16.010



Finishing end mills G-Mold μ 48 F

Article no. **6825**

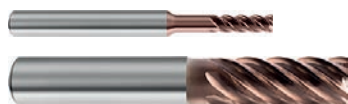

Cutting data page 686



restricted tolerances for maximum component accuracy • max. taper 0.005 mm • neck clearance • \emptyset 3-6 mm with centre cutting • \emptyset 8-20 mm without centre cutting



High-performance milling cutters

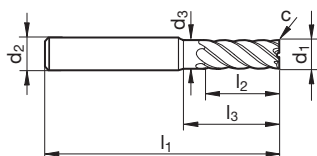

Article no. **6825**

d1 f8 mm	d2 h5 mm	d3 mm	l1 mm	l2 mm	l3 mm	c mm x 45°	Z	Order no.
3.00	6.00	2.85	57	8.0	15.0	0.06	4	6825 3.000
4.00	6.00	3.80	57	11.0	18.0	0.08	4	6825 4.000
5.00	6.00	4.80	57	13.0	18.0	0.10	4	6825 5.000
6.00	6.00	5.70	57	13.0	20.0	0.12	4	6825 6.000
8.00	8.00	7.70	63	19.0	26.0	0.08	6	6825 8.000
10.00	10.00	9.50	72	22.0	30.0	0.10	6	6825 10.000
12.00	12.00	11.50	83	26.0	36.0	0.12	6	6825 12.000
16.00	16.00	15.50	92	32.0	42.0	0.16	6	6825 16.000
20.00	20.00	19.50	104	38.0	52.0	0.20	6	6825 20.000

Finishing end mills G-Mold μ 48 F

Article no. **6826**



Cutting data page 686



restricted tolerances for maximum component accuracy • max. taper 0.005 mm • neck clearance • \emptyset 3-6 mm with centre cutting • \emptyset 8-20 mm without centre cutting

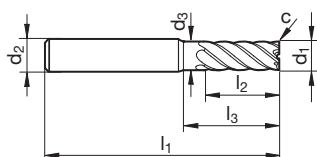

Article no. **6826**

d1 f8 mm	d2 h5 mm	d3 mm	l1 mm	l2 mm	l3 mm	c mm x 45°	Z	Order no.
3.00	6.00	2.85	65	12.0	24.0	0.06	4	6826 3.000
4.00	6.00	3.80	65	16.0	26.0	0.08	4	6826 4.000
5.00	6.00	4.80	65	18.0	26.0	0.10	4	6826 5.000
6.00	6.00	5.70	65	21.0	28.0	0.12	4	6826 6.000
8.00	8.00	7.70	75	26.0	38.0	0.08	6	6826 8.000
10.00	10.00	9.50	80	30.0	38.0	0.10	6	6826 10.000
12.00	12.00	11.50	93	36.0	46.0	0.12	6	6826 12.000
16.00	16.00	15.50	108	48.0	58.0	0.16	6	6826 16.000
20.00	20.00	19.50	126	60.0	74.0	0.20	6	6826 20.000



Multi-tooth end mills with corner radius GH 100 U

Article no. 3563



neck clearance • without centre cutting

Cutting data page 686



Multi-tooth end mills with corner radius GH 100 U

Article no. 6969



neck clearance • without centre cutting

Cutting data page 686

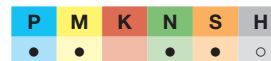

High-performance milling cutters

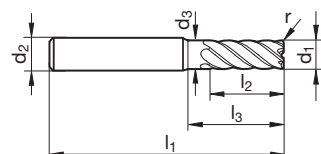

Article no.

3563

6969

d1 f9 mm	d2 h6 mm	d3 mm	l1 mm	l2 mm	l3 mm	r mm	Z	Order no.
3.00	6.00	2.85	57	8.0	14.0	0.20	6	3563 3.002
3.00	6.00	2.85	57	8.0	14.0	0.50	6	3563 3.005
4.00	6.00	3.80	57	11.0	16.0	0.20	6	3563 4.002
4.00	6.00	3.80	57	11.0	16.0	0.50	6	3563 4.005
5.00	6.00	4.80	57	13.0	18.0	0.20	6	3563 5.002
5.00	6.00	4.80	57	13.0	18.0	0.50	6	3563 5.005
6.00	6.00	5.70	57	13.0	20.0	0.20	6	3563 6.002
6.00	6.00	5.70	57	13.0	20.0	0.50	6	3563 6.005
6.00	6.00	5.70	57	13.0	20.0	1.00	6	6969 6.005
6.00	6.00	5.70	57	13.0	20.0	1.00	6	6969 6.010
8.00	8.00	7.70	63	19.0	26.0	0.30	6	3563 8.003
8.00	8.00	7.70	63	19.0	26.0	0.50	6	3563 8.005
8.00	8.00	7.70	63	19.0	26.0	1.00	6	6969 8.005
8.00	8.00	7.70	63	19.0	26.0	1.00	6	6969 8.010
8.00	8.00	7.70	63	19.0	26.0	1.50	6	3563 8.015
8.00	8.00	7.70	63	19.0	26.0	2.00	6	6969 8.015
8.00	8.00	7.70	63	19.0	26.0	2.00	6	3563 8.020
10.00	10.00	9.50	72	22.0	30.0	0.30	6	3563 10.003
10.00	10.00	9.50	72	22.0	30.0	0.50	6	3563 10.005
10.00	10.00	9.50	72	22.0	30.0	1.00	6	6969 10.005
10.00	10.00	9.50	72	22.0	30.0	1.00	6	3563 10.010
10.00	10.00	9.50	72	22.0	30.0	1.50	6	6969 10.010
10.00	10.00	9.50	72	22.0	30.0	1.50	6	3563 10.015
10.00	10.00	9.50	72	22.0	30.0	2.00	6	6969 10.015
10.00	10.00	9.50	72	22.0	30.0	2.00	6	3563 10.020
12.00	12.00	11.50	83	26.0	36.0	0.50	6	3563 12.005
12.00	12.00	11.50	83	26.0	36.0	1.00	6	6969 12.005
12.00	12.00	11.50	83	26.0	36.0	1.50	6	3563 12.010
12.00	12.00	11.50	83	26.0	36.0	1.50	6	6969 12.010
12.00	12.00	11.50	83	26.0	36.0	2.00	6	3563 12.015
12.00	12.00	11.50	83	26.0	36.0	2.00	6	6969 12.015
12.00	12.00	11.50	83	26.0	36.0	2.00	6	3563 12.020
12.00	12.00	11.50	83	26.0	36.0	2.00	6	6969 12.020
16.00	16.00	15.50	92	32.0	42.0	0.50	6	3563 16.005
16.00	16.00	15.50	92	32.0	42.0	1.00	6	6969 16.005
16.00	16.00	15.50	92	32.0	42.0	1.50	6	3563 16.010
16.00	16.00	15.50	92	32.0	42.0	1.50	6	6969 16.010
16.00	16.00	15.50	92	32.0	42.0	2.00	6	3563 16.015
16.00	16.00	15.50	92	32.0	42.0	2.00	6	6969 16.015
16.00	16.00	15.50	92	32.0	42.0	2.00	6	3563 16.020
16.00	16.00	15.50	92	32.0	42.0	2.00	6	6969 16.020
20.00	20.00	19.50	104	38.0	52.0	0.50	6	3563 20.005
20.00	20.00	19.50	104	38.0	52.0	1.00	6	6969 20.005
20.00	20.00	19.50	104	38.0	52.0	1.00	6	3563 20.010
20.00	20.00	19.50	104	38.0	52.0	1.50	6	6969 20.010
20.00	20.00	19.50	104	38.0	52.0	1.50	6	3563 20.015
20.00	20.00	19.50	104	38.0	52.0	1.50	6	6969 20.015
20.00	20.00	19.50	104	38.0	52.0	2.00	6	3563 20.020
20.00	20.00	19.50	104	38.0	52.0	2.00	6	6969 20.020



End mills with corner radius (4-fluted)

Article no. **3562**



Cutting data page 690



neck clearance • centre cutting

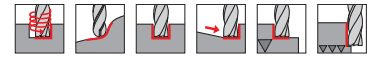

High-performance milling cutters

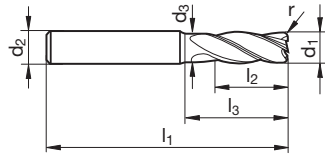

Article no. **3562**

d1 f9 mm	d2 h6 mm	d3 mm	l1 mm	l2 mm	l3 mm	r mm	Z	Order no.
1.00	4.00	0.92	50	3.0	6.0	0.10	4	3562 1.001
1.50	4.00	1.40	50	4.0	9.0	0.20	4	3562 1.502
2.00	6.00	1.85	57	7.0	12.0	0.20	4	3562 2.002
2.00	6.00	1.85	57	7.0	12.0	0.50	4	3562 2.005
3.00	6.00	2.85	57	8.0	14.0	0.20	4	3562 3.002
3.00	6.00	2.85	57	8.0	14.0	0.50	4	3562 3.005
4.00	6.00	3.80	57	11.0	16.0	0.20	4	3562 4.002
4.00	6.00	3.80	57	11.0	16.0	0.50	4	3562 4.005
5.00	6.00	4.80	57	13.0	18.0	0.20	4	3562 5.002
5.00	6.00	4.80	57	13.0	18.0	0.50	4	3562 5.005
6.00	6.00	5.70	57	13.0	20.0	0.50	4	3562 6.005
6.00	6.00	5.70	57	13.0	20.0	1.00	4	3562 6.010
8.00	8.00	7.70	63	19.0	26.0	0.50	4	3562 8.005
8.00	8.00	7.70	63	19.0	26.0	1.00	4	3562 8.010
8.00	8.00	7.70	63	19.0	26.0	1.50	4	3562 8.015
8.00	8.00	7.70	63	19.0	26.0	2.00	4	3562 8.020
10.00	10.00	9.50	72	22.0	30.0	0.50	4	3562 10.005
10.00	10.00	9.50	72	22.0	30.0	0.80	4	3562 10.008
10.00	10.00	9.50	72	22.0	30.0	1.00	4	3562 10.010
10.00	10.00	9.50	72	22.0	30.0	1.50	4	3562 10.015
10.00	10.00	9.50	72	22.0	30.0	2.00	4	3562 10.020
12.00	12.00	11.50	83	26.0	36.0	0.50	4	3562 12.005
12.00	12.00	11.50	83	26.0	36.0	0.80	4	3562 12.008
12.00	12.00	11.50	83	26.0	36.0	1.00	4	3562 12.010
12.00	12.00	11.50	83	26.0	36.0	1.50	4	3562 12.015
12.00	12.00	11.50	83	26.0	36.0	2.00	4	3562 12.020
16.00	16.00	15.50	92	32.0	42.0	0.50	4	3562 16.005
16.00	16.00	15.50	92	32.0	42.0	1.00	4	3562 16.010
16.00	16.00	15.50	92	32.0	42.0	1.50	4	3562 16.015
16.00	16.00	15.50	92	32.0	42.0	2.00	4	3562 16.020
20.00	20.00	19.50	104	38.0	52.0	0.50	4	3562 20.005
20.00	20.00	19.50	104	38.0	52.0	1.00	4	3562 20.010
20.00	20.00	19.50	104	38.0	52.0	1.50	4	3562 20.015
20.00	20.00	19.50	104	38.0	52.0	2.00	4	3562 20.020



Slot drills with corner radius (2-fluted)

Article no. 3561



Cutting data page 690



neck clearance • centre cutting

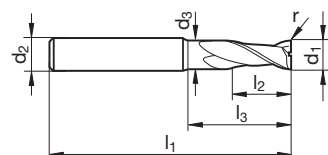
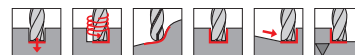
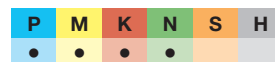

Article no. 3561

d1 f9 mm	d2 h6 mm	d3 mm	l1 mm	l2 mm	l3 mm	r mm	Z	Order no.
1.00	4.00	0.92	50	2.0	6.0	0.10	2	3561 1.001
1.50	4.00	1.40	50	3.0	9.0	0.20	2	3561 1.502
2.00	6.00	1.85	57	6.0	12.0	0.20	2	3561 2.002
2.00	6.00	1.85	57	6.0	12.0	0.50	2	3561 2.005
3.00	6.00	2.85	57	7.0	14.0	0.20	2	3561 3.002
3.00	6.00	2.85	57	7.0	14.0	0.50	2	3561 3.005
4.00	6.00	3.80	57	8.0	16.0	0.20	2	3561 4.002
4.00	6.00	3.80	57	8.0	16.0	0.50	2	3561 4.005
5.00	6.00	4.80	57	10.0	18.0	0.20	2	3561 5.002
5.00	6.00	4.80	57	10.0	18.0	0.50	2	3561 5.005
6.00	6.00	5.70	57	10.0	20.0	0.50	2	3561 6.005
6.00	6.00	5.70	57	10.0	20.0	1.00	2	3561 6.010
8.00	8.00	7.70	63	16.0	26.0	0.50	2	3561 8.005
8.00	8.00	7.70	63	16.0	26.0	1.00	2	3561 8.010
8.00	8.00	7.70	63	16.0	26.0	1.50	2	3561 8.015
8.00	8.00	7.70	63	16.0	26.0	2.00	2	3561 8.020
10.00	10.00	9.50	72	19.0	30.0	0.50	2	3561 10.005
10.00	10.00	9.50	72	19.0	30.0	1.00	2	3561 10.010
10.00	10.00	9.50	72	19.0	30.0	1.50	2	3561 10.015
10.00	10.00	9.50	72	19.0	30.0	2.00	2	3561 10.020
12.00	12.00	11.50	83	22.0	36.0	0.50	2	3561 12.005
12.00	12.00	11.50	83	22.0	36.0	1.00	2	3561 12.010
12.00	12.00	11.50	83	22.0	36.0	1.50	2	3561 12.015
12.00	12.00	11.50	83	22.0	36.0	2.00	2	3561 12.020
16.00	16.00	15.50	92	26.0	42.0	0.50	2	3561 16.005
16.00	16.00	15.50	92	26.0	42.0	1.00	2	3561 16.010
16.00	16.00	15.50	92	26.0	42.0	1.50	2	3561 16.015
16.00	16.00	15.50	92	26.0	42.0	2.00	2	3561 16.020
20.00	20.00	19.50	104	32.0	52.0	0.50	2	3561 20.005
20.00	20.00	19.50	104	32.0	52.0	1.00	2	3561 20.010
20.00	20.00	19.50	104	32.0	52.0	1.50	2	3561 20.015
20.00	20.00	19.50	104	32.0	52.0	2.00	2	3561 20.020

High-performance milling cutters



Die sinking cutter holders GF 200 WP

Article no. **1941**



Cutting data page 700



to be used with indexable inserts art. no. 1947/2520

P	M	K	N	S	H
•	•	•	○	•	•



High-performance milling cutters

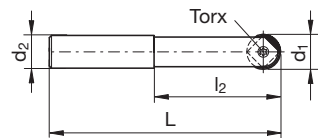

Article no. **1941**

d1 ±0,015 mm	d2 h6 mm	l1 mm	l2 mm	Torx	Order no.
10.00	10.00	95	45	T8	1941 10.000
12.00	12.00	110	50	T15	1941 12.000
16.00	16.00	125	65	T20	1941 16.000
20.00	20.00	140	75	T20	1941 20.000
25.00	25.00	165	90	T30	1941 25.000
32.00	32.00	185	105	T30	1941 32.000

Die sinking cutter holders GF 200 WP

Article no. **1942**



Cutting data page 700



to be used with indexable inserts art. no. 1947/2520

P	M	K	N	S	H
•	•	•	○	•	•

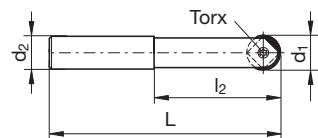

Article no. **1942**

d1 ±0,015 mm	d2 h6 mm	l1 mm	l2 mm	Torx	Order no.
10.00	12.00	150	35	T8	1942 10.000
12.00	16.00	160	60	T15	1942 12.000
16.00	20.00	174	70	T20	1942 16.000
20.00	25.00	189	80	T20	1942 20.000
25.00	32.00	210	100	T30	1942 25.000



Indexable inserts round

Article no. **1947**



for GF 200 WP • applicable twice

Cutting data page 700

P	M	K	N	S	H
●	●	●	○	●	●

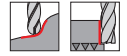

Indexable inserts round

Article no. **2520**



for GF 200 WP • applicable twice

Cutting data page 700

P	M	K	N	S	H
●	●	●	○	●	●

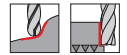

High-performance milling cutters

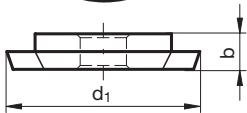
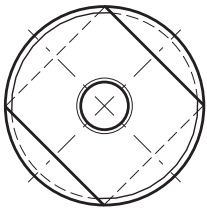

Article no. **1947** **2520**

d1 ±0,015 mm	b mm	Order no.	
20.00	4.0	1947 20.000	2520 20.000
10.00	2.5	1947 10.000	2520 10.000
12.00	2.5	1947 12.000	2520 12.000
16.00	3.2	1947 16.000	2520 16.000
25.00	4.6	1947 25.000	2520 25.000
32.00	5.0		2520 32.000



Torx screwdrivers

Article no. **1612**

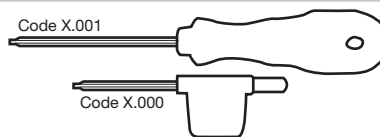

Article no. **1612**

High-performance milling cutters

Torx	Order no.
T5	1612 5.001
T6	1612 6.000
T6	1612 6.001
T7	1612 7.000
T7	1612 7.001
T8	1612 8.000
T8	1612 8.001
T9	1612 9.001
T10	1612 10.001
T15	1612 15.000
T15	1612 15.001
T20	1612 20.001
T25	1612 25.001
T30	1612 30.001

Clamping screws for die sinking cutter holders

Article no. **1691**

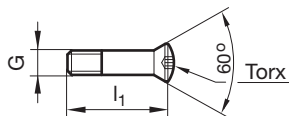

for GF 200 WP

Article no. **1691**

G	l1 mm	Torx	Order no.
M 3	8.50	T8	1691 3.000
M 4 X0.5	10.20	T15	1691 4.000
M 5 X0.5	12.80	T20	1691 5.000
M 5 X0.5	15.40	T20	1691 5.001
M12 X 1.5	20.40	T30	1691 6.000
M 8 X0.75	24.80	T30	1691 8.000



Slot drills (2-fluted)

Article no. 3633



centre cutting

Cutting data page 690

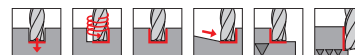
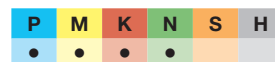

Slot drills (2-fluted)

Article no. 3634



centre cutting

Cutting data page 690



Universal milling cutters

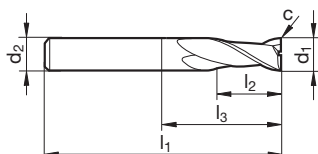

Article no. 3633 3634

d1 h10 mm	d2 h6 mm	l1 mm	l2 mm	l3 mm	c mm x 45°	Z	Order no.	
2.00	6.00	50	3.0	6.4	0.02	2	3633 2.000	3634 2.000
2.50	6.00	50	3.0	6.4	0.05	2	3633 2.500	3634 2.500
3.00	6.00	50	4.0	8.9	0.05	2	3633 3.000	3634 3.000
4.00	6.00	54	5.0	10.4	0.05	2	3633 4.000	3634 4.000
5.00	6.00	54	6.0	12.9	0.05	2	3633 5.000	3634 5.000
6.00	6.00	54	7.0	18.0	0.05	2	3633 6.000	3634 6.000
6.50	8.00	58	8.0	17.4	0.10	2	3633 6.500	
8.00	8.00	58	9.0	22.0	0.10	2	3633 8.000	3634 8.000
10.00	10.00	66	11.0	26.0	0.10	2	3633 10.000	3634 10.000
12.00	12.00	73	12.0	28.0	0.10	2	3633 12.000	3634 12.000
14.00	14.00	75	14.0	30.0	0.15	2	3633 14.000	3634 14.000
16.00	16.00	82	16.0	34.0	0.15	2	3633 16.000	3634 16.000
18.00	18.00	84	18.0	36.0	0.15	2	3633 18.000	3634 18.000
20.00	20.00	92	20.0	42.0	0.15	2	3633 20.000	3634 20.000



Universal milling cutters

Slot drills (2-fluted)

 Article no. **3635**

centre cutting

Cutting data page 690

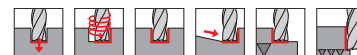
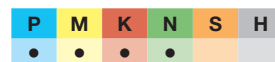

Slot drills (2-fluted)

 Article no. **3154**

centre cutting

Cutting data page 690

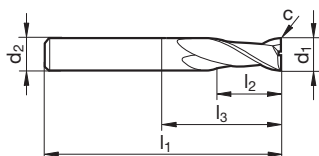
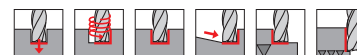
 Article no. **3635** **3154**

d1 h10 mm	d2 h6 mm	l1 mm	l2 mm	l3 mm	c mm x 45°	Z	Order no.
1.00	3.00	38	2.0	3.9	0.025	2	3635 1.000
1.50	3.00	38	3.0	6.4	0.025	2	3635 1.500
2.00	6.00	57	6.0	9.4	0.025	2	3635 2.000
2.50	6.00	57	7.0	10.4	0.050	2	3635 2.500
2.80	6.00	57	7.0	11.9	0.050	2	3635 2.800
3.00	6.00	57	7.0	11.9	0.050	2	3635 3.000 3154 3.000
3.50	6.00	57	7.0	12.4	0.050	2	3635 3.500 3154 3.500
3.80	6.00	57	8.0	13.4	0.050	2	3635 3.800 3154 3.800
4.00	6.00	57	8.0	13.4	0.050	2	3635 4.000 3154 4.000
4.50	6.00	57	8.0	14.9	0.050	2	3635 4.500 3154 4.500
4.80	6.00	57	10.0	16.9	0.050	2	3635 4.800 3154 4.800
5.00	6.00	57	10.0	16.9	0.050	2	3635 5.000 3154 5.000
5.50	6.00	57	10.0	17.4	0.050	2	3635 5.500 3154 5.500
5.75	6.00	57	10.0	18.4	0.050	2	3635 5.750 3154 5.750
6.00	6.00	57	10.0	21.0	0.050	2	3635 6.000 3154 6.000
6.75	8.00	63	13.0	22.4	0.100	2	3635 6.750 3154 6.750
7.00	8.00	63	13.0	22.4	0.100	2	3635 7.000 3154 7.000
7.50	8.00	63	16.0	25.4	0.100	2	3635 7.500 3154 7.500
7.75	8.00	63	16.0	25.4	0.100	2	3635 7.750 3154 7.750
8.00	8.00	63	16.0	27.0	0.100	2	3635 8.000 3154 8.000
8.70	10.00	72	16.0	27.4	0.100	2	3635 8.700 3154 8.700
9.00	10.00	72	16.0	27.4	0.100	2	3635 9.000 3154 9.000
9.70	10.00	72	19.0	30.4	0.100	2	3635 9.700 3154 9.700
10.00	10.00	72	19.0	32.0	0.100	2	3635 10.000 3154 10.000
11.70	12.00	83	22.0	35.4	0.100	2	3635 11.700 3154 11.700
12.00	12.00	83	22.0	38.0	0.100	2	3635 12.000 3154 12.000
13.70	14.00	83	22.0	37.4	0.150	2	3635 13.700 3154 13.700
14.00	14.00	83	22.0	38.0	0.150	2	3635 14.000 3154 14.000
14.00	16.00	92	26.0	42.0	0.150	2	3635 14.001
15.70	16.00	92	26.0	44.0	0.150	2	3635 15.700 3154 15.700
16.00	16.00	92	26.0	44.0	0.150	2	3635 16.000 3154 16.000
18.00	18.00	92	26.0	44.0	0.150	2	3635 18.000 3154 18.000
18.00	20.00	104	32.0	51.0	0.150	2	3635 18.001
20.00	20.00	104	32.0	54.0	0.150	2	3635 20.000 3154 20.000



Slot drills (2-fluted)

Article no. 3709



Cutting data page 690



centre cutting

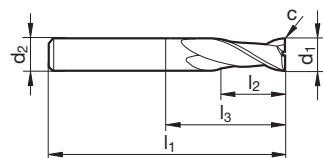
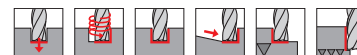
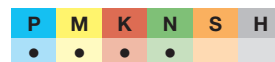

Article no. 3709

d1 h10 mm	d2 h6 mm	l1 mm	l2 mm	l3 mm	c mm x 45°	Z	Order no.
2.00	2.00	32	8.0	10.5	0.02	2	3709 2.000
2.50	2.50	32	8.0	10.5	0.05	2	3709 2.500
3.00	3.00	32	12.0	16.0	0.05	2	3709 3.000
3.50	3.50	32	12.0	16.5	0.05	2	3709 3.500
4.00	4.00	40	12.0	16.5	0.05	2	3709 4.000
4.50	4.50	50	14.0	19.5	0.05	2	3709 4.500
5.00	5.00	50	14.0	19.5	0.05	2	3709 5.000
5.50	5.50	50	16.0	22.0	0.05	2	3709 5.500
6.00	6.00	50	16.0	23.0	0.05	2	3709 6.000
6.50	6.50	60	16.0	24.0	0.10	2	3709 6.500
7.00	7.00	60	20.0	28.0	0.10	2	3709 7.000
7.50	7.50	60	20.0	28.0	0.10	2	3709 7.500
8.00	8.00	60	20.0	28.0	0.10	2	3709 8.000
8.50	8.50	60	20.0	30.0	0.10	2	3709 8.500
9.00	9.00	60	20.0	30.0	0.10	2	3709 9.000
9.50	9.50	70	22.0	32.0	0.10	2	3709 9.500
10.00	10.00	70	22.0	32.0	0.10	2	3709 10.000
11.00	11.00	70	22.0	34.0	0.10	2	3709 11.000
12.00	12.00	70	22.0	35.0	0.10	2	3709 12.000
13.00	13.00	75	25.0	39.0	0.15	2	3709 13.000
14.00	14.00	75	25.0	39.0	0.15	2	3709 14.000
15.00	15.00	75	25.0	41.0	0.15	2	3709 15.000
16.00	16.00	75	25.0	41.0	0.15	2	3709 16.000
18.00	18.00	100	35.0	52.0	0.15	2	3709 18.000
20.00	20.00	100	35.0	54.0	0.15	2	3709 20.000

Universal milling cutters



Slot drills (2-fluted)

Article no. **3676**



Cutting data page 690



centre cutting

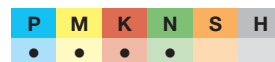

Universal milling cutters

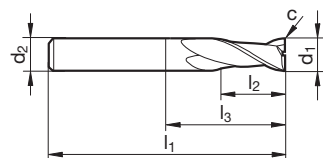

Article no.

3676

d1 h10 mm	d2 h6 mm	l1 mm	l2 mm	l3 mm	c mm x 45°	Z	Order no.
2.00	2.00	32	5.0	7.5	0.02	2	3676 2.000
2.50	2.50	32	6.0	8.5	0.05	2	3676 2.500
3.00	3.00	38	7.0	11.0	0.05	2	3676 3.000
3.50	3.50	50	7.0	22.0	0.05	2	3676 3.500
4.00	4.00	50	8.0	22.0	0.05	2	3676 4.000
4.50	4.50	50	8.0	22.0	0.05	2	3676 4.500
5.00	5.00	50	10.0	22.0	0.05	2	3676 5.000
5.50	5.50	57	10.0	21.0	0.05	2	3676 5.500
6.00	6.00	57	10.0	21.0	0.05	2	3676 6.000
6.50	6.50	60	13.0	24.0	0.10	2	3676 6.500
7.00	7.00	60	13.0	24.0	0.10	2	3676 7.000
7.50	7.50	63	16.0	27.0	0.10	2	3676 7.500
8.00	8.00	63	16.0	27.0	0.10	2	3676 8.000
8.50	8.50	67	16.0	27.0	0.10	2	3676 8.500
9.00	9.00	67	16.0	27.0	0.10	2	3676 9.000
9.50	9.50	72	19.0	32.0	0.10	2	3676 9.500
10.00	10.00	72	19.0	32.0	0.10	2	3676 10.000
11.00	11.00	83	22.0	38.0	0.10	2	3676 11.000
12.00	12.00	83	22.0	38.0	0.10	2	3676 12.000
13.00	13.00	83	22.0	38.0	0.15	2	3676 13.000
14.00	14.00	83	22.0	38.0	0.15	2	3676 14.000
15.00	15.00	92	26.0	44.0	0.15	2	3676 15.000
16.00	16.00	92	26.0	44.0	0.15	2	3676 16.000
18.00	18.00	92	26.0	44.0	0.15	2	3676 18.000
20.00	20.00	104	32.0	54.0	0.15	2	3676 20.000



Slot drills XL (2-fluted)

Article no. 3021



Cutting data page 690



centre cutting

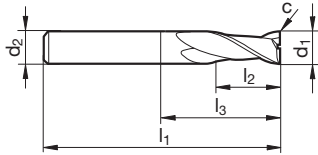
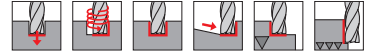
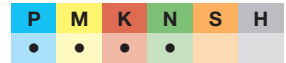

Article no. 3021

d1 h10 mm	d2 h6 mm	l1 mm	l2 mm	l3 mm	c mm x 45°	Z	Order no.
3.00	3.00	75	20.0	47.0	0.05	2	3021 3.000
4.00	4.00	75	25.0	47.0	0.05	2	3021 4.000
5.00	5.00	75	30.0	47.0	0.05	2	3021 5.000
6.00	6.00	75	30.0	39.0	0.05	2	3021 6.000
8.00	8.00	100	40.0	64.0	0.10	2	3021 8.000
10.00	10.00	100	40.0	60.0	0.10	2	3021 10.000
12.00	12.00	150	45.0	105.0	0.10	2	3021 12.000
14.00	14.00	150	45.0	105.0	0.15	2	3021 14.000
14.00	16.00	150	65.0	81.0	0.15	2	3021 14.001
16.00	16.00	150	65.0	102.0	0.15	2	3021 16.000
18.00	18.00	150	65.0	102.0	0.15	2	3021 18.000
18.00	20.00	150	65.0	84.0	0.15	2	3021 18.001
20.00	20.00	150	65.0	100.0	0.15	2	3021 20.000

Universal milling cutters



Mini slot drills (3-fluted)

Article no. **3684**



Cutting data page 690



centre cutting

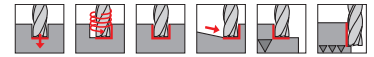

Universal milling cutters

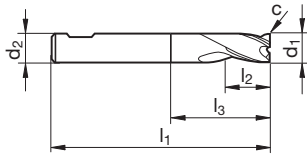

Article no. **3684**

d1 e8 mm	d2 h6 mm	l1 mm	l2 mm	l3 mm	c mm x 45°	Z	Order no.
0.30	3.00	38	1.0	2.1		3	3684 0.300
0.40	3.00	38	1.0	2.1		3	3684 0.400
0.50	3.00	38	1.5	2.8	0.025	3	3684 0.500
0.60	3.00	38	1.5	2.8	0.025	3	3684 0.600
0.80	3.00	38	2.0	3.3	0.025	3	3684 0.800
1.00	3.00	38	2.0	3.9	0.025	3	3684 1.000
1.20	3.00	38	2.0	3.9	0.025	3	3684 1.200
1.50	3.00	38	2.0	5.4	0.025	3	3684 1.500
1.80	3.00	38	2.0	5.4	0.025	3	3684 1.800
2.00	6.00	38	4.0	7.4	0.025	3	3684 2.000
2.50	6.00	38	5.0	8.4	0.050	3	3684 2.500
3.00	6.00	38	5.0	9.9	0.050	3	3684 3.000
3.50	6.00	38	6.0	11.4	0.050	3	3684 3.500
4.00	6.00	38	7.0	12.4	0.050	3	3684 4.000
4.50	6.00	38	8.0	14.5	0.050	3	3684 4.500
5.00	6.00	38	8.0	14.5	0.050	3	3684 5.000
5.50	6.00	38	8.0	15.0	0.050	3	3684 5.500
5.75	6.00	38	8.0	16.0	0.050	3	3684 5.750
6.00	6.00	38	8.0	14.0	0.050	3	3684 6.000
6.75	8.00	42	10.0	18.0	0.100	3	3684 6.750
7.00	8.00	42	10.0	18.0	0.100	3	3684 7.000
7.75	8.00	42	10.0	18.0	0.100	3	3684 7.750
8.00	8.00	43	11.0	19.0	0.100	3	3684 8.000
8.70	10.00	48	11.0	21.0	0.100	3	3684 8.700
9.00	10.00	48	11.0	21.0	0.100	3	3684 9.000
9.70	10.00	48	11.0	21.0	0.100	3	3684 9.700
10.00	10.00	50	13.0	23.0	0.100	3	3684 10.000
12.00	12.00	55	15.0	24.5	0.100	3	3684 12.000
14.00	14.00	58	15.0	27.5	0.150	3	3684 14.000
16.00	16.00	62	18.0	29.0	0.150	3	3684 16.000
18.00	18.00	70	20.0	37.0	0.150	3	3684 18.000
20.00	20.00	75	22.0	41.0	0.150	3	3684 20.000



Mini slot drills (3-fluted)

Article no. 3686



Cutting data page 690



centre cutting

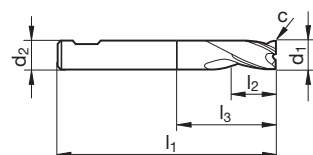
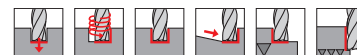
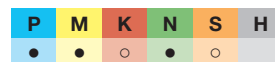

Article no. 3686

d1 e8 mm	d2 h6 mm	l1 mm	l2 mm	l3 mm	c mm x 45°	Z	Order no.
1.00	3.00	38	2.0	3.4	0.025	3	3686 1.000
1.20	3.00	38	2.0	3.4	0.025	3	3686 1.200
1.50	3.00	38	3.0	5.9	0.025	3	3686 1.500
1.80	3.00	38	3.0	5.9	0.025	3	3686 1.800
2.00	6.00	45	4.0	6.9	0.025	3	3686 2.000
2.50	6.00	45	5.0	7.9	0.050	3	3686 2.500
3.00	6.00	45	6.0	9.9	0.050	3	3686 3.000
3.50	6.00	45	6.0	9.9	0.050	3	3686 3.500
4.00	6.00	45	7.0	10.9	0.050	3	3686 4.000
4.50	6.00	45	8.0	13.4	0.050	3	3686 4.500
5.00	6.00	45	8.0	13.4	0.050	3	3686 5.000
5.50	6.00	45	8.0	14.4	0.050	3	3686 5.500
5.75	6.00	45	10.0	17.0	0.050	3	3686 5.750
6.00	6.00	45	10.0	15.0	0.050	3	3686 6.000
6.75	8.00	55	10.0	18.4	0.100	3	3686 6.750
7.00	8.00	55	12.0	20.4	0.100	3	3686 7.000
7.75	8.00	55	12.0	20.4	0.100	3	3686 7.750
8.00	8.00	55	13.0	18.9	0.100	3	3686 8.000
8.70	10.00	55	14.0	23.4	0.100	3	3686 8.700
9.00	10.00	55	14.0	23.4	0.100	3	3686 9.000
9.70	10.00	55	16.0	25.0	0.100	3	3686 9.700
10.00	10.00	55	16.0	25.0	0.100	3	3686 10.000

Universal milling cutters



Universal milling cutters

Slot drills (3-fluted)

 Article no. **3558**

centre cutting

Cutting data page 690

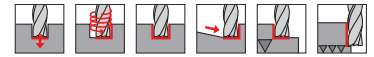

Slot drills (3-fluted)

 Article no. **3719**

centre cutting

Cutting data page 690

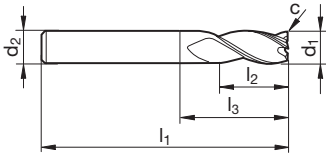
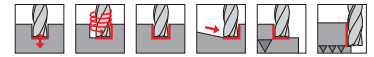
 Article no. **3558** **3719**

d1 h10 mm	d2 h6 mm	l1 mm	l2 mm	l3 mm	c mm x 45°	Z	Order no.	
2.00	6.00	50	3.0	7.4	0.02	3	3558 2.000	3719 2.000
2.50	6.00	50	3.0	7.4	0.05	3	3558 2.500	3719 2.500
3.00	6.00	50	4.0	8.4	0.05	3	3558 3.000	3719 3.000
3.50	6.00	50	4.0	8.4	0.05	3	3558 3.500	3719 3.500
4.00	6.00	54	5.0	10.4	0.05	3	3558 4.000	3719 4.000
5.00	6.00	54	6.0	12.4	0.05	3	3558 5.000	3719 5.000
5.50	6.00	54	7.0	14.9	0.05	3	3558 5.500	3719 5.500
6.00	6.00	54	7.0	18.0	0.05	3	3558 6.000	3719 6.000
7.00	8.00	58	8.0	16.9	0.10	3	3558 7.000	3719 7.000
8.00	8.00	58	9.0	22.0	0.10	3	3558 8.000	3719 8.000
8.50	10.00	66	10.0	20.9	0.10	3	3558 8.500	3719 8.500
9.00	10.00	66	10.0	20.9	0.10	3	3558 9.000	3719 9.000
10.00	10.00	66	11.0	26.0	0.10	3	3558 10.000	3719 10.000
12.00	12.00	73	12.0	28.0	0.10	3	3558 12.000	3719 12.000
14.00	14.00	75	14.0	30.0	0.15	3	3558 14.000	3719 14.000
16.00	16.00	82	16.0	34.0	0.15	3	3558 16.000	3719 16.000
18.00	18.00	84	18.0	36.0	0.15	3	3558 18.000	3719 18.000
20.00	20.00	92	20.0	42.0	0.15	3	3558 20.000	3719 20.000



Slot drills (3-fluted)

Article no. 3560



centre cutting

Cutting data page 690

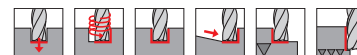
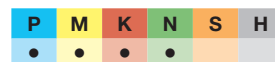

Slot drills (3-fluted)

Article no. 3720



centre cutting

Cutting data page 690

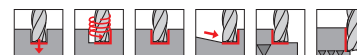

Universal milling cutters

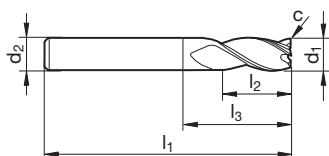

Article no. **3560** **3720**

d1 h10 mm	d2 h6 mm	l1 mm	l2 mm	l3 mm	c mm x 45°	Z	Order no.
2.00	6.00	57	6.0	10.4	0.02	3	3560 2.000 3720 2.000
2.50	6.00	57	7.0	11.4	0.05	3	3560 2.500 3720 2.500
2.80	6.00	57	7.0	11.4	0.05	3	3560 2.800 3720 2.800
3.00	6.00	57	7.0	11.4	0.05	3	3560 3.000 3720 3.000
3.50	6.00	57	7.0	11.4	0.05	3	3560 3.500 3720 3.500
3.80	6.00	57	8.0	13.9	0.05	3	3560 3.800
4.00	6.00	57	8.0	13.9	0.05	3	3560 4.000 3720 4.000
4.50	6.00	57	8.0	13.9	0.05	3	3560 4.500 3720 4.500
4.80	6.00	57	10.0	16.9	0.05	3	3560 4.800
5.00	6.00	57	10.0	16.9	0.05	3	3560 5.000 3720 5.000
5.50	6.00	57	10.0	17.9	0.05	3	3560 5.500 3720 5.500
5.80	6.00	57	10.0	17.9	0.05	3	3560 5.800
6.00	6.00	57	10.0	21.0	0.05	3	3560 6.000 3720 6.000
6.80	8.00	63	13.0	21.9	0.10	3	3560 6.800
7.00	8.00	63	13.0	21.9	0.10	3	3560 7.000 3720 7.000
7.80	8.00	63	16.0	25.9	0.10	3	3560 7.800
8.00	8.00	63	16.0	27.0	0.10	3	3560 8.000 3720 8.000
8.50	10.00	72	16.0	27.4	0.10	3	3560 8.500 3720 8.500
8.70	10.00	72	16.0	27.4	0.10	3	3560 8.700
9.00	10.00	72	16.0	27.4	0.10	3	3560 9.000 3720 9.000
9.70	10.00	72	19.0	31.4	0.10	3	3560 9.700
10.00	10.00	72	19.0	32.0	0.10	3	3560 10.000 3720 10.000
11.70	12.00	83	22.0	36.4	0.10	3	3560 11.700
12.00	12.00	83	22.0	38.0	0.10	3	3560 12.000 3720 12.000
13.70	14.00	83	22.0	37.4	0.15	3	3560 13.700
14.00	14.00	83	22.0	38.0	0.15	3	3560 14.000 3720 14.000
14.00	16.00	92	26.0	37.4	0.15	3	3560 14.001
15.70	16.00	92	26.0	44.0	0.15	3	3560 15.700
16.00	16.00	92	26.0	44.0	0.15	3	3560 16.000 3720 16.000
18.00	18.00	92	26.0	44.0	0.15	3	3560 18.000 3720 18.000
18.00	20.00	104	32.0	45.0	0.15	3	3560 18.001
20.00	20.00	104	32.0	54.0	0.15	3	3560 20.000 3720 20.000



Slot drills (3-fluted)

Article no. **3677**



Cutting data page 690



centre cutting

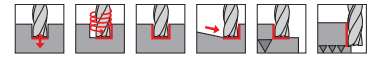

Universal milling cutters

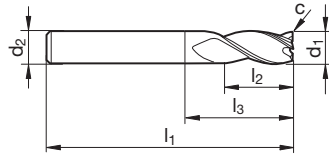

Article no.

3677

d1 h10 mm	d2 h6 mm	l1 mm	l2 mm	l3 mm	c mm x 45°	Z	Order no.
2.00	2.00	32	5.0	9.0	0.02	3	3677 2.000
2.50	2.50	32	6.0	10.0	0.05	3	3677 2.500
3.00	3.00	38	7.0	10.0	0.05	3	3677 3.000
3.50	3.50	50	7.0	22.0	0.05	3	3677 3.500
4.00	4.00	50	8.0	22.0	0.05	3	3677 4.000
4.50	4.50	50	8.0	22.0	0.05	3	3677 4.500
5.00	5.00	50	10.0	22.0	0.05	3	3677 5.000
5.50	5.50	57	10.0	21.0	0.05	3	3677 5.500
6.00	6.00	57	10.0	21.0	0.05	3	3677 6.000
6.50	6.50	60	13.0	24.0	0.10	3	3677 6.500
7.00	7.00	60	13.0	24.0	0.10	3	3677 7.000
7.50	7.50	63	16.0	27.0	0.10	3	3677 7.500
8.00	8.00	63	16.0	27.0	0.10	3	3677 8.000
8.50	8.50	67	16.0	27.0	0.10	3	3677 8.500
9.00	9.00	67	16.0	27.0	0.10	3	3677 9.000
9.50	9.50	72	19.0	32.0	0.10	3	3677 9.500
10.00	10.00	72	19.0	32.0	0.10	3	3677 10.000
11.00	11.00	83	22.0	38.0	0.10	3	3677 11.000
12.00	12.00	83	22.0	38.0	0.10	3	3677 12.000
13.00	13.00	83	22.0	38.0	0.15	3	3677 13.000
14.00	14.00	83	22.0	38.0	0.15	3	3677 14.000
15.00	15.00	92	26.0	44.0	0.15	3	3677 15.000
16.00	16.00	92	26.0	44.0	0.15	3	3677 16.000
18.00	18.00	92	26.0	44.0	0.15	3	3677 18.000
20.00	20.00	104	32.0	54.0	0.15	3	3677 20.000



Slot drills (3-fluted)

Article no. 3711



Cutting data page 690



centre cutting

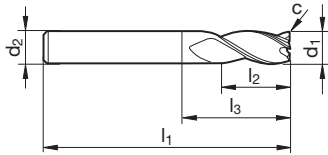
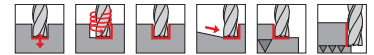

Article no. **3711**

d1 h10 mm	d2 h6 mm	l1 mm	l2 mm	l3 mm	c mm x 45°	Z	Order no.
2.00	2.00	32	8.0	12.0	0.02	3	3711 2.000
2.50	2.50	32	8.0	12.0	0.05	3	3711 2.500
3.00	3.00	32	12.0	16.0	0.05	3	3711 3.000
4.00	4.00	40	12.0	16.0	0.05	3	3711 4.000
4.50	4.50	50	14.0	19.0	0.05	3	3711 4.500
5.00	5.00	50	14.0	19.0	0.05	3	3711 5.000
5.50	5.50	50	16.0	22.0	0.05	3	3711 5.500
6.00	6.00	50	16.0	22.0	0.05	3	3711 6.000
6.50	6.50	60	16.0	23.0	0.10	3	3711 6.500
7.00	7.00	60	20.0	27.0	0.10	3	3711 7.000
7.50	7.50	60	20.0	28.0	0.10	3	3711 7.500
8.00	8.00	60	20.0	28.0	0.10	3	3711 8.000
8.50	8.50	60	20.0	29.0	0.10	3	3711 8.500
9.00	9.00	60	20.0	29.0	0.10	3	3711 9.000
9.50	9.50	70	22.0	32.0	0.10	3	3711 9.500
10.00	10.00	70	22.0	32.0	0.10	3	3711 10.000
11.00	11.00	70	22.0	33.0	0.10	3	3711 11.000
12.00	12.00	70	22.0	34.0	0.10	3	3711 12.000
13.00	13.00	75	25.0	37.0	0.15	3	3711 13.000
14.00	14.00	75	25.0	38.0	0.15	3	3711 14.000
15.00	15.00	75	25.0	39.0	0.15	3	3711 15.000
16.00	16.00	75	25.0	40.0	0.15	3	3711 16.000
18.00	18.00	100	35.0	51.0	0.15	3	3711 18.000
20.00	20.00	100	35.0	54.0	0.15	3	3711 20.000

Universal milling cutters



Slot drills XL (3-fluted)

Article no. **3314**



centre cutting

Cutting data page 690

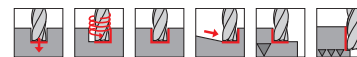

Slot drills XL (3-fluted)

Article no. **3680**



centre cutting

Cutting data page 690

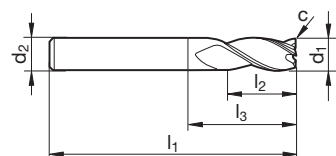
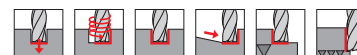
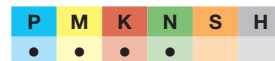

Article no. **3314** **3680**

d1 h10 mm	d2 h6 mm	l1 mm	l2 mm	l3 mm	c mm x 45°	Z	Order no.	
3.00	3.00	75	20.0	47.0	0.05	3	3314 3.000	3680 3.000
4.00	4.00	75	25.0	47.0	0.05	3	3314 4.000	3680 4.000
5.00	5.00	75	30.0	47.0	0.05	3	3314 5.000	3680 5.000
6.00	6.00	75	30.0	39.0	0.05	3	3314 6.000	3680 6.000
8.00	8.00	100	40.0	64.0	0.10	3	3314 8.000	3680 8.000
10.00	10.00	100	40.0	60.0	0.10	3	3314 10.000	3680 10.000
12.00	12.00	150	45.0	105.0	0.10	3	3314 12.000	3680 12.000
16.00	16.00	150	65.0	102.0	0.15	3	3314 16.000	3680 16.000
20.00	20.00	150	65.0	100.0	0.15	3	3314 20.000	3680 20.000



End mills (4-fluted)

Article no. **3637**



centre cutting

Cutting data page 690

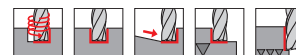
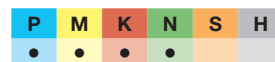

End mills (4-fluted)

Article no. **3721**



centre cutting

Cutting data page 690

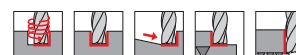

Universal milling cutters

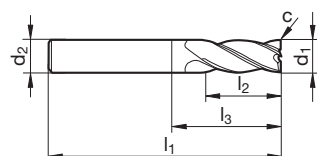

Article no. **3637** **3721**

d1 h10 mm	d2 h6 mm	l1 mm	l2 mm	l3 mm	c mm x 45°	Z	Order no.	
2.00	6.00	50	4.0	6.9	0.02	4	3637 2.000	3721 2.000
3.00	6.00	50	5.0	8.9	0.05	4	3637 3.000	3721 3.000
4.00	6.00	54	8.0	12.9	0.05	4	3637 4.000	3721 4.000
5.00	6.00	54	9.0	14.9	0.05	4	3637 5.000	3721 5.000
6.00	6.00	54	10.0	18.0	0.05	4	3637 6.000	3721 6.000
8.00	8.00	58	12.0	22.0	0.10	4	3637 8.000	3721 8.000
10.00	10.00	66	14.0	26.0	0.10	4	3637 10.000	3721 10.000
12.00	12.00	73	16.0	28.0	0.10	4	3637 12.000	3721 12.000
14.00	14.00	75	18.0	30.0	0.15	4	3637 14.000	3721 14.000
16.00	16.00	82	22.0	34.0	0.15	4	3637 16.000	3721 16.000
18.00	18.00	84	24.0	36.0	0.15	4	3637 18.000	3721 18.000
20.00	20.00	92	26.0	42.0	0.15	4	3637 20.000	3721 20.000



End mills (4-fluted)

Article no. **3649**



centre cutting

Cutting data page 690

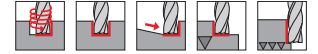
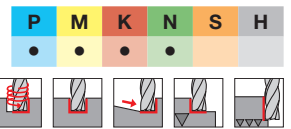

End mills (4-fluted)

Article no. **3722**



centre cutting

Cutting data page 690

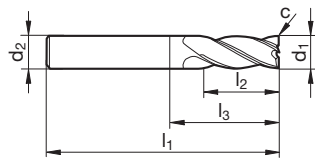
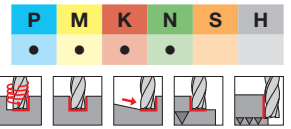

Article no.

3649

3722

d1 h10 mm	d2 h6 mm	l1 mm	l2 mm	l3 mm	c mm x 45°	Z	Order no.	
2.00	6.00	57	7.0	9.9	0.02	4	3649 2.000	3722 2.000
3.00	6.00	57	8.0	11.9	0.05	4	3649 3.000	3722 3.000
3.50	6.00	57	10.0	14.4	0.05	4	3649 3.500	3722 3.500
4.00	6.00	57	11.0	15.9	0.05	4	3649 4.000	3722 4.000
4.50	6.00	57	11.0	16.4	0.05	4	3649 4.500	3722 4.500
5.00	6.00	57	13.0	18.9	0.05	4	3649 5.000	3722 5.000
6.00	6.00	57	13.0	21.0	0.05	4	3649 6.000	3722 6.000
7.00	8.00	63	16.0	24.4	0.10	4	3649 7.000	3722 7.000
8.00	8.00	63	19.0	27.0	0.10	4	3649 8.000	3722 8.000
9.00	10.00	72	19.0	29.4	0.10	4	3649 9.000	3722 9.000
10.00	10.00	72	22.0	32.0	0.10	4	3649 10.000	3722 10.000
12.00	12.00	83	26.0	38.0	0.10	4	3649 12.000	3722 12.000
14.00	14.00	83	26.0	38.0	0.15	4	3649 14.000	3722 14.000
14.00	16.00	92	32.0	36.0	0.15	4	3649 14.001	
16.00	16.00	92	32.0	44.0	0.15	4	3649 16.000	3722 16.000
18.00	18.00	92	32.0	44.0	0.15	4	3649 18.000	3722 18.000
18.00	20.00	104	38.0	44.0	0.15	4	3649 18.001	
20.00	20.00	104	38.0	54.0	0.15	4	3649 20.000	3722 20.000



End mills (4-fluted)

Article no. 3678



Cutting data page 690



centre cutting

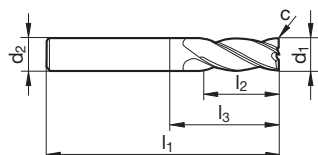
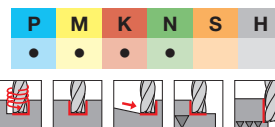

Article no. 3678

d1 h10 mm	d2 h6 mm	l1 mm	l2 mm	l3 mm	c mm x 45°	Z	Order no.
2.00	2.00	32	5.0	7.0	0.02	4	3678 2.000
2.50	2.50	32	6.0	8.5	0.05	4	3678 2.500
3.00	3.00	38	7.0	10.0	0.05	4	3678 3.000
3.50	3.50	50	8.0	11.5	0.05	4	3678 3.500
4.00	4.00	50	11.0	22.0	0.05	4	3678 4.000
4.50	4.50	50	11.0	22.0	0.05	4	3678 4.500
5.00	5.00	50	13.0	22.0	0.05	4	3678 5.000
6.00	6.00	57	13.0	21.0	0.05	4	3678 6.000
7.00	7.00	60	16.0	24.0	0.10	4	3678 7.000
7.50	7.50	63	19.0	27.0	0.10	4	3678 7.500
8.00	8.00	63	19.0	27.0	0.10	4	3678 8.000
9.00	9.00	67	19.0	27.0	0.10	4	3678 9.000
10.00	10.00	72	22.0	32.0	0.10	4	3678 10.000
11.00	11.00	83	26.0	38.0	0.10	4	3678 11.000
12.00	12.00	83	26.0	38.0	0.10	4	3678 12.000
13.00	13.00	83	26.0	38.0	0.15	4	3678 13.000
14.00	14.00	83	26.0	38.0	0.15	4	3678 14.000
16.00	16.00	92	32.0	44.0	0.15	4	3678 16.000
18.00	18.00	92	32.0	44.0	0.15	4	3678 18.000
20.00	20.00	104	38.0	54.0	0.15	4	3678 20.000

Universal milling cutters



End mills (4-fluted)

Article no. **3713**



Cutting data page 690



centre cutting

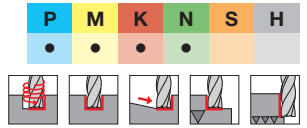

Universal milling cutters

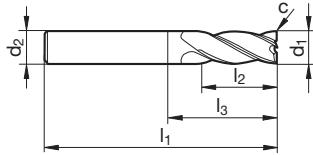

Article no.

3713

d1 h10 mm	d2 h6 mm	l1 mm	l2 mm	l3 mm	c mm x 45°	Z	Order no.
4.50	4.50	50	14.0	18.5	0.05	4	3713 4.500
5.00	5.00	50	14.0	19.0	0.05	4	3713 5.000
6.00	6.00	50	16.0	22.0	0.05	4	3713 6.000
7.00	7.00	60	20.0	25.0	0.10	4	3713 7.000
7.50	7.50	60	20.0	27.5	0.10	4	3713 7.500
8.00	8.00	60	20.0	28.0	0.10	4	3713 8.000
9.00	9.00	60	20.0	29.0	0.10	4	3713 9.000
10.00	10.00	70	22.0	32.0	0.10	4	3713 10.000
11.00	11.00	70	22.0	32.1	0.10	4	3713 11.000
12.00	12.00	70	22.0	33.0	0.10	4	3713 12.000
13.00	13.00	75	25.0	36.9	0.15	4	3713 13.000
14.00	14.00	75	25.0	37.8	0.15	4	3713 14.000
16.00	16.00	75	25.0	39.7	0.15	4	3713 16.000
18.00	18.00	100	35.0	51.5	0.15	4	3713 18.000
20.00	20.00	100	35.0	53.4	0.15	4	3713 20.000



End mills XL (4-fluted)

Article no. **3023**



Cutting data page 690



centre cutting

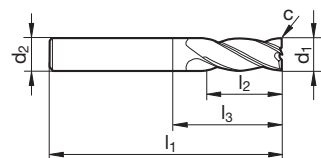
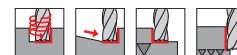

Article no. **3023**

d1 h10 mm	d2 h6 mm	l1 mm	l2 mm	l3 mm	c mm x 45°	Z	Order no.
3.00	3.00	75	20.0	47.0	0.05	4	3023 3.000
4.00	4.00	75	25.0	47.0	0.05	4	3023 4.000
5.00	5.00	75	30.0	47.0	0.05	4	3023 5.000
6.00	6.00	75	30.0	39.0	0.05	4	3023 6.000
8.00	8.00	100	40.0	64.0	0.10	4	3023 8.000
10.00	10.00	100	40.0	60.0	0.10	4	3023 10.000
12.00	12.00	150	45.0	105.0	0.10	4	3023 12.000
14.00	14.00	150	45.0	105.0	0.15	4	3023 14.000
14.00	16.00	150	65.0	79.8	0.15	4	3023 14.001
16.00	16.00	150	65.0	102.0	0.15	4	3023 16.000
18.00	18.00	150	65.0	102.0	0.15	4	3023 18.000
18.00	20.00	150	65.0	84.0	0.15	4	3023 18.001
20.00	20.00	150	65.0	100.0	0.15	4	3023 20.000

Universal milling cutters



HSS-E-PM end mills

Ratio end mills RF 40

Article no. **3429**

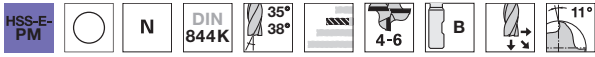

neck clearance • centre cutting

Cutting data page 706

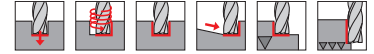

Ratio end mills RF 40

Article no. **3705**



neck clearance • centre cutting

Cutting data page 706

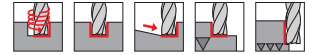

Universal milling cutters

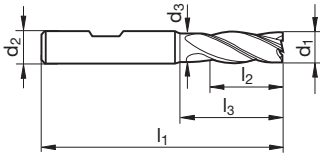

Article no.

3429

3705

d1 js12 mm	d2 mm	d3 mm	l1 mm	l2 mm	l3 mm	Z
8.00	10.00	7.70	69	19.0		4
8.00	10.00	7.70	69	19.0	21.5	4
10.00	10.00	9.50	72	22.0	30.0	4
12.00	12.00	11.50	83	26.0	36.0	4
14.00	12.00	12.00	83	26.0	38.0	4
16.00	16.00	15.50	92	32.0	42.0	4
18.00	16.00	16.00	92	32.0	44.0	4
20.00	20.00	19.00	104	38.0	52.0	4
25.00	25.00	24.00	121	45.0	63.0	4

Order no.
3705 8.000
3429 8.000
3429 10.000
3429 12.000
3429 14.000
3429 16.000
3429 18.000
3429 20.000
3429 25.000
3705 10.000
3705 12.000
3705 14.000
3705 16.000
3705 18.000
3705 20.000
3705 25.000



Ratio end mills RF 40

Article no. 3432

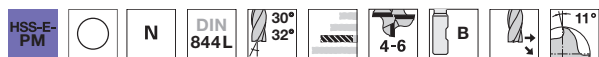

neck clearance • centre cutting

Cutting data page 706

P	M	K	N	S	H
●	●	●	●	○	

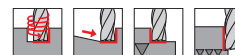

Ratio end mills RF 40

Article no. 3706

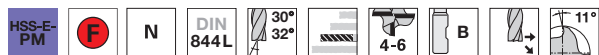

neck clearance • centre cutting

Cutting data page 706

P	M	K	N	S	H
●	●	●	●	○	

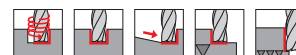

Universal milling cutters

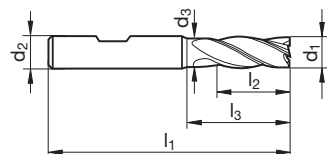

Article no.

3432

3706

d1 js12 mm	d2 mm	d3 mm	l1 mm	l2 mm	l3 mm	Z	Order no.	
16.00	16.00	15.50	123	63.0	73.0	4	3432 16.000	3706 16.000
18.00	16.00	15.70	123	63.0	75.0	4	3432 18.000	3706 18.000
20.00	20.00	19.00	141	75.0	89.0	4	3432 20.000	3706 20.000
25.00	25.00	24.00	166	90.0	108.0	4	3432 25.000	3706 25.000
30.00	25.00	24.70	166	90.0	110.0	6	3432 30.000	3706 30.000



HSS-E-PM end mills

Roughing end mills GS 40 (fine teeth)

Article no. **3322**



neck clearance • centre cutting

Cutting data page 706

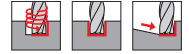

Universal milling cutters

Roughing end mills GS 40 (fine teeth)

Article no. **3668**

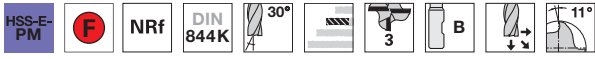

neck clearance • centre cutting

Cutting data page 706

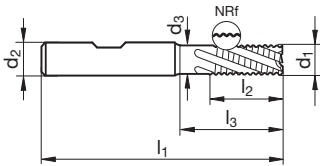
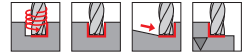

Article no.

3322

3668

d1 js12 mm	d2 mm	d3 mm	l1 mm	l2 mm	l3 mm	Z
6.00	6.00	5.70	57	13.0	20.0	3
6.00	6.00	5.70	57	13.0		3
8.00	10.00	7.70	69	19.0	21.5	3
8.00	10.00	7.70	69	19.0		3
10.00	10.00	9.50	72	22.0	30.0	3
12.00	12.00	11.50	83	26.0	36.0	3
14.00	12.00	12.00	83	26.0	38.0	3
16.00	16.00	15.50	92	32.0	42.0	3
18.00	16.00	16.00	92	32.0	44.0	3
20.00	20.00	19.00	104	38.0	52.0	3

Order no.
3668 6.000
3322 6.000
3668 8.000
3322 8.000
3668 10.000
3322 10.000
3668 12.000
3322 12.000
3668 14.000
3322 14.000
3668 16.000
3322 16.000
3668 18.000
3322 18.000
3668 20.000
3322 20.000



Roughing end mills GS 40 (fine teeth)

Article no. **3340**



neck clearance • centre cutting

Cutting data page 706

P	M	K	N	S	H
●	●	●	●	○	

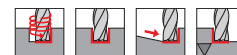

Roughing end mills GS 40 (fine teeth)

Article no. **3660**

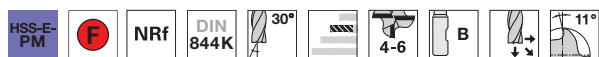

neck clearance • centre cutting

Cutting data page 706

P	M	K	N	S	H
●	●	●	●	○	

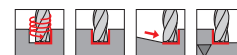

Universal milling cutters

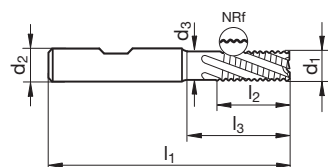

Article no. **3340** **3660**

d1 js12 mm	d2 mm	d3 mm	l1 mm	l2 mm	l3 mm	Z	Order no.	
6.00	6.00	5.70	57	13.0	20.0	4	3340 6.000	3660 6.000
7.00	10.00	6.70	66	16.0	17.9	4	3340 7.000	3660 7.000
8.00	10.00	7.70	69	19.0	21.5	4	3340 8.000	3660 8.000
9.00	10.00	8.70	69	19.0	24.3	4	3340 9.000	3660 9.000
10.00	10.00	9.50	72	22.0	30.0	4	3340 10.000	3660 10.000
11.00	12.00	10.50	79	22.0	30.7	4	3340 11.000	3660 11.000
12.00	12.00	11.50	83	26.0	36.0	4	3340 12.000	3660 12.000
13.00	12.00	12.00	83	26.0	38.0	4	3340 13.000	3660 13.000
14.00	12.00	12.00	83	26.0	38.0	4	3340 14.000	3660 14.000
15.00	12.00	12.00	83	26.0	38.0	4	3340 15.000	3660 15.000
16.00	16.00	15.50	92	32.0	42.0	4	3340 16.000	3660 16.000
18.00	16.00	16.00	92	32.0	44.0	4	3340 18.000	3660 18.000
20.00	20.00	19.00	104	38.0	52.0	4	3340 20.000	3660 20.000
25.00	25.00	24.00	121	45.0	63.0	5	3340 25.000	3660 25.000
28.00	25.00	25.00	121	45.0	65.0	5	3340 28.000	3660 28.000
30.00	25.00	25.00	121	45.0	65.0	5	3340 30.000	3660 30.000
32.00	32.00	31.00	133	53.0	71.0	6	3340 32.000	3660 32.000



Roughing end mills GS 80 (fine teeth)

Article no. **6756**



Cutting data page 706

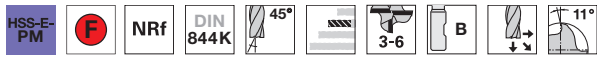

neck clearance • centre cutting

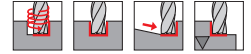

Universal milling cutters

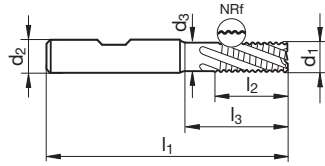

Article no. **6756**

d1 js12 mm	d2 mm	d3 mm	l1 mm	l2 mm	l3 mm	Z	Order no.
4.00	6.00	3.70	55	11.0	15.0	3	6756 4.000
5.00	6.00	4.70	57	13.0	18.0	4	6756 5.000
6.00	6.00	5.70	57	13.0	20.0	4	6756 6.000
7.00	10.00	6.70	66	16.0	22.1	4	6756 7.000
8.00	10.00	7.70	69	19.0	26.0	4	6756 8.000
9.00	10.00	8.70	69	19.0	26.9	4	6756 9.000
10.00	10.00	9.50	72	22.0	30.0	4	6756 10.000
12.00	12.00	11.50	83	26.0	36.0	4	6756 12.000
14.00	12.00	13.50	83	26.0	38.0	5	6756 14.000
16.00	16.00	15.50	92	32.0	42.0	5	6756 16.000
18.00	16.00	17.50	92	32.0	44.0	6	6756 18.000
20.00	20.00	19.00	104	38.0	52.0	6	6756 20.000
25.00	25.00	24.00	121	45.0	63.0	6	6756 25.000



Slot drills (2-fluted)

Article no. 3451



centre cutting

Cutting data page 708

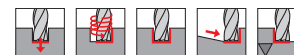

Slot drills (2-fluted)

Article no. 3663

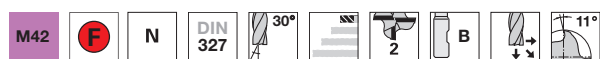

centre cutting

Cutting data page 708

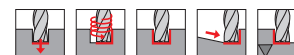

Universal milling cutters

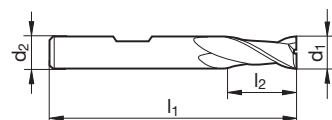

Article no. **3451** **3663**

d1 mm	Tolerance d1	d2 mm	l1 mm	l2 mm	Z	Order no.
1.00	h10	6.00	47	2.0	2	3451 1.000 3663 1.000
1.50	h10	6.00	47	3.0	2	3451 1.500 3663 1.500
2.00	e8	6.00	48	4.0	2	3451 2.000 3663 2.000
2.50	e8	6.00	49	5.0	2	3451 2.500 3663 2.500
3.00	e8	6.00	49	5.0	2	3451 3.000 3663 3.000
3.50	h10	6.00	50	6.0	2	3451 3.500 3663 3.500
4.00	e8	6.00	51	7.0	2	3451 4.000 3663 4.000
4.50	h10	6.00	51	7.0	2	3451 4.500 3663 4.500
5.00	e8	6.00	52	8.0	2	3451 5.000 3663 5.000
5.50	h10	6.00	52	8.0	2	3451 5.500 3663 5.500
6.00	e8	6.00	52	8.0	2	3451 6.000 3663 6.000
6.50	h10	10.00	60	10.0	2	3451 6.500 3663 6.500
7.00	e8	10.00	60	10.0	2	3451 7.000 3663 7.000
7.50	h10	10.00	60	10.0	2	3451 7.500 3663 7.500
8.00	e8	10.00	61	11.0	2	3451 8.000 3663 8.000
8.50	h10	10.00	61	11.0	2	3451 8.500 3663 8.500
9.00	h10	10.00	61	11.0	2	3451 9.000 3663 9.000
9.50	h10	10.00	61	11.0	2	3451 9.500 3663 9.500
10.00	e8	10.00	63	13.0	2	3451 10.000 3663 10.000
10.50	h10	12.00	70	13.0	2	3451 10.500 3663 10.500
11.00	h10	12.00	70	13.0	2	3451 11.000 3663 11.000
11.50	h10	12.00	70	13.0	2	3451 11.500 3663 11.500
12.00	e8	12.00	73	16.0	2	3451 12.000 3663 12.000
13.00	h10	12.00	73	16.0	2	3451 13.000 3663 13.000
14.00	e8	12.00	73	16.0	2	3451 14.000 3663 14.000
15.00	h10	12.00	73	16.0	2	3451 15.000 3663 15.000
16.00	e8	16.00	79	19.0	2	3451 16.000 3663 16.000
17.00	h10	16.00	79	19.0	2	3451 17.000 3663 17.000
18.00	e8	16.00	79	19.0	2	3451 18.000 3663 18.000
19.00	h10	16.00	79	19.0	2	3451 19.000 3663 19.000
20.00	e8	20.00	88	22.0	2	3451 20.000 3663 20.000
22.00	e8	20.00	88	22.0	2	3451 22.000 3663 22.000
24.00	e8	25.00	102	26.0	2	3451 24.000 3663 24.000
25.00	e8	25.00	102	26.0	2	3451 25.000 3663 25.000



Slot drills (2-fluted)

Article no. **3452**

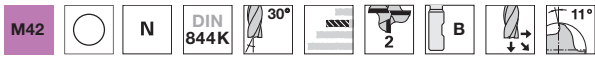

centre cutting

Cutting data page 708

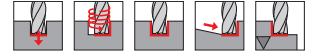

Slot drills (2-fluted)

Article no. **3694**

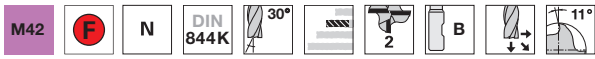

centre cutting

Cutting data page 708

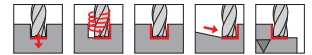

Universal milling cutters

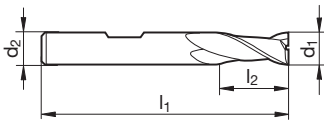

Article no.

3452

3694

d1 mm	Tolerance d1	d2 mm	l1 mm	l2 mm	Z	Order no.	
						3452	3694
3.00	e8	6.00	52	8.0	2	3452 3.000	3694 3.000
3.50	h10	6.00	54	10.0	2	3452 3.500	
4.00	e8	6.00	55	11.0	2	3452 4.000	3694 4.000
4.50	h10	6.00	55	11.0	2	3452 4.500	3694 4.500
5.00	e8	6.00	57	13.0	2	3452 5.000	3694 5.000
5.50	h10	6.00	57	13.0	2	3452 5.500	3694 5.500
6.00	e8	6.00	57	13.0	2	3452 6.000	3694 6.000
7.00	e8	10.00	66	16.0	2	3452 7.000	3694 7.000
8.00	e8	10.00	69	19.0	2	3452 8.000	3694 8.000
10.00	e8	10.00	72	22.0	2	3452 10.000	3694 10.000
11.00	h10	12.00	79	22.0	2	3452 11.000	
12.00	e8	12.00	83	26.0	2	3452 12.000	3694 12.000
13.00	h10	12.00	83	26.0	2	3452 13.000	3694 13.000
14.00	e8	12.00	83	26.0	2	3452 14.000	3694 14.000
15.00	h10	12.00	83	26.0	2	3452 15.000	3694 15.000
16.00	e8	16.00	92	32.0	2	3452 16.000	3694 16.000
18.00	e8	16.00	92	32.0	2	3452 18.000	3694 18.000
20.00	e8	20.00	104	38.0	2	3452 20.000	3694 20.000



Slot drills (2-fluted)

Article no. 3453



centre cutting

Cutting data page 708

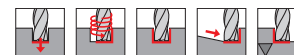

Slot drills (2-fluted)

Article no. 3695

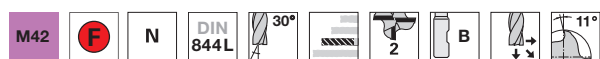

centre cutting

Cutting data page 708

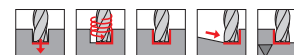

Universal milling cutters

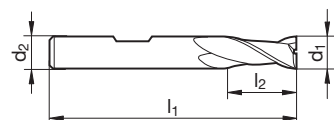

Article no. **3453** **3695**

d1 mm	Tolerance d1	d2 mm	l1 mm	l2 mm	Z	Order no.	
						3453	3695
3.00	h10	6.00	56	12.0	2	3453 3.000	3695 3.000
4.00	h10	6.00	63	19.0	2	3453 4.000	3695 4.000
5.00	h10	6.00	68	24.0	2	3453 5.000	3695 5.000
6.00	h10	6.00	68	24.0	2	3453 6.000	3695 6.000
8.00	h10	10.00	88	38.0	2	3453 8.000	3695 8.000
10.00	h10	10.00	95	45.0	2	3453 10.000	3695 10.000
12.00	h10	12.00	110	53.0	2	3453 12.000	3695 12.000
14.00	h10	12.00	110	53.0	2	3453 14.000	3695 14.000
16.00	h10	16.00	123	63.0	2	3453 16.000	3695 16.000
18.00	h10	16.00	123	63.0	2	3453 18.000	3695 18.000
20.00	h10	20.00	141	75.0	2	3453 20.000	3695 20.000



Ball nose slot drills (2-fluted)

Article no. **3466**



Cutting data page 708



centre cutting

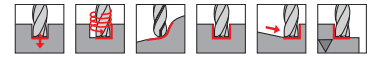

Ball nose slot drills (2-fluted)

Article no. **3703**



Cutting data page 708



centre cutting

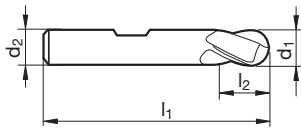
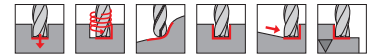

Article no. **3466** **3703**

d1 mm	Tolerance d1	d2 mm	l1 mm	l2 mm	Z	Order no.
2.00	e8	6.00	48	4.0	2	3466 2.000 3703 2.000
3.00	e8	6.00	49	5.0	2	3466 3.000 3703 3.000
4.00	e8	6.00	51	7.0	2	3466 4.000 3703 4.000
5.00	e8	6.00	52	8.0	2	3466 5.000 3703 5.000
6.00	e8	6.00	52	8.0	2	3466 6.000 3703 6.000
7.00	e8	10.00	60	10.0	2	3466 7.000 3703 7.000
8.00	e8	10.00	61	11.0	2	3466 8.000 3703 8.000
9.00	h10	10.00	61	11.0	2	3466 9.000 3703 9.000
10.00	e8	10.00	63	13.0	2	3466 10.000 3703 10.000
12.00	e8	12.00	73	16.0	2	3466 12.000 3703 12.000
13.00	h10	12.00	73	16.0	2	3466 13.000 3703 13.000
14.00	e8	12.00	73	16.0	2	3466 14.000 3703 14.000
15.00	h10	12.00	73	16.0	2	3466 15.000 3703 15.000
16.00	e8	16.00	79	19.0	2	3466 16.000 3703 16.000
18.00	e8	16.00	79	19.0	2	3466 18.000 3703 18.000
19.00	h10	16.00	79	19.0	2	3466 19.000 3703 19.000
20.00	e8	20.00	88	22.0	2	3466 20.000 3703 20.000
22.00	e8	20.00	88	22.0	2	3466 22.000 3703 22.000
24.00	e8	25.00	102	26.0	2	3466 24.000 3703 24.000
25.00	e8	25.00	102	26.0	2	3466 25.000 3703 25.000
28.00	e8	25.00	102	26.0	2	3466 28.000 3703 28.000



Ball nose slot drills (2-fluted)

Article no. **3467**



centre cutting

Cutting data page 708

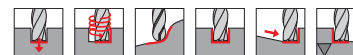

Ball nose slot drills (2-fluted)

Article no. **3704**



centre cutting

Cutting data page 708

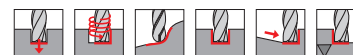

Universal milling cutters

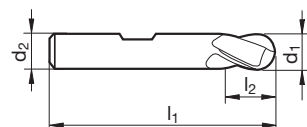

Article no. **3467** **3704**

d1 mm	Tolerance d1	d2 mm	l1 mm	l2 mm	Z	Order no.	
3.00	h10	6.00	56	8.0	2	3467 3.000	3704 3.000
4.00	h10	6.00	63	11.0	2	3467 4.000	3704 4.000
5.00	h10	6.00	68	13.0	2	3467 5.000	3704 5.000
6.00	h10	6.00	68	13.0	2	3467 6.000	3704 6.000
7.00	h10	10.00	80	16.0	2	3467 7.000	
8.00	h10	10.00	88	19.0	2	3467 8.000	3704 8.000
10.00	h10	10.00	95	22.0	2	3467 10.000	3704 10.000
12.00	h10	12.00	110	26.0	2	3467 12.000	3704 12.000
14.00	h10	12.00	110	26.0	2	3467 14.000	3704 14.000
15.00	h10	12.00	110	26.0	2		3704 15.000
16.00	h10	16.00	123	32.0	2	3467 16.000	3704 16.000
18.00	h10	16.00	123	32.0	2	3467 18.000	3704 18.000
20.00	h10	20.00	141	38.0	2	3467 20.000	
24.00	h10	25.00	166	45.0	2	3467 24.000	



Mini slot drills (3-fluted)

Article no. 3142



Cutting data page 708

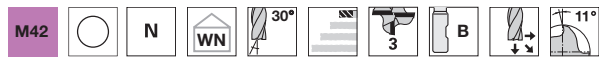

centre cutting

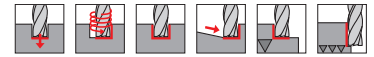

Mini slot drills (3-fluted)

Article no. 3144



Cutting data page 708

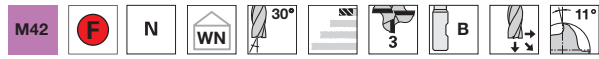

centre cutting

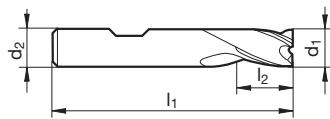
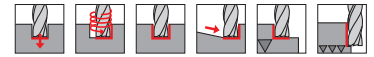

Article no.		3142	3144
		Order no.	
d1 e8 mm	d2 mm		
3.00	6.00	3142 3.000	3144 3.000
4.00	6.00	3142 4.000	3144 4.000
5.00	6.00		3144 5.000
6.00	6.00	3142 6.000	3144 6.000
8.00	8.00	3142 8.000	3144 8.000
10.00	10.00	3142 10.000	3144 10.000

Mini slot drills (3-fluted)

Article no. 3143



Cutting data page 708

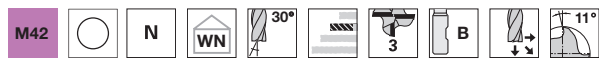

centre cutting

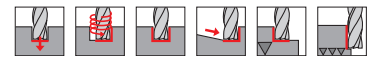
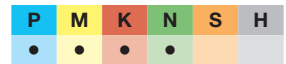

Mini slot drills (3-fluted)

Article no. 3145



Cutting data page 708

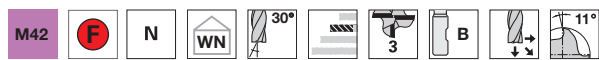

centre cutting

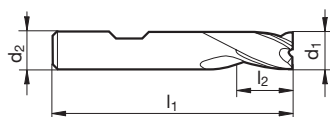
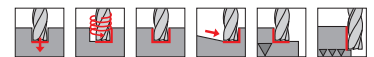

Article no.		3143	3145
		Order no.	
d1 e8 mm	d2 mm		
3.00	6.00	3143 3.000	3145 3.000
4.00	6.00	3143 4.000	3145 4.000
5.00	6.00	3143 5.000	3145 5.000
6.00	6.00	3143 6.000	3145 6.000
8.00	8.00	3143 8.000	3145 8.000
10.00	10.00	3143 10.000	3145 10.000



Slot drills (3-fluted)

Article no. 3458

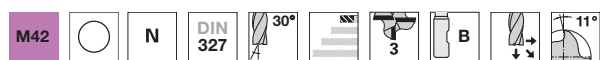

centre cutting

Cutting data page 708

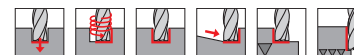

Slot drills (3-fluted)

Article no. 3651

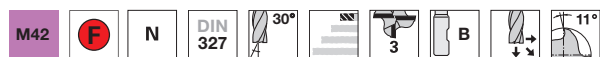

centre cutting

Cutting data page 708

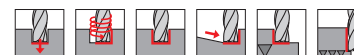

Universal milling cutters

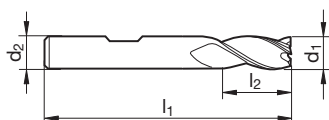

Article no. **3458** **3651**

d1 mm	Tolerance d1	d2 mm	l1 mm	l2 mm	Z	Order no.	
						3458	3651
2.80	e8	6.00	49	5.0	3	3458 2.800	3651 2.800
3.00	e8	6.00	49	5.0	3	3458 3.000	3651 3.000
3.80	e8	6.00	51	7.0	3	3458 3.800	3651 3.800
4.00	e8	6.00	51	7.0	3	3458 4.000	3651 4.000
4.80	e8	6.00	52	8.0	3	3458 4.800	3651 4.800
5.00	e8	6.00	52	8.0	3	3458 5.000	3651 5.000
5.75	e8	6.00	52	8.0	3	3458 5.750	3651 5.750
6.00	e8	6.00	52	8.0	3	3458 6.000	3651 6.000
6.75	e8	10.00	60	10.0	3	3458 6.750	3651 6.750
7.00	e8	10.00	60	10.0	3	3458 7.000	3651 7.000
7.75	e8	10.00	61	11.0	3	3458 7.750	3651 7.750
8.00	e8	10.00	61	11.0	3	3458 8.000	3651 8.000
9.70	e8	10.00	63	13.0	3	3458 9.700	3651 9.700
10.00	e8	10.00	63	13.0	3	3458 10.000	3651 10.000
11.70	e8	12.00	70	13.0	3	3458 11.700	3651 11.700
12.00	e8	12.00	73	16.0	3	3458 12.000	3651 12.000
13.70	e8	12.00	73	16.0	3	3458 13.700	
14.00	e8	12.00	73	16.0	3	3458 14.000	3651 14.000
15.70	e8	16.00	79	19.0	3	3458 15.700	3651 15.700
16.00	e8	16.00	79	19.0	3	3458 16.000	3651 16.000
18.00	e8	16.00	79	19.0	3	3458 18.000	3651 18.000
20.00	e8	20.00	88	22.0	3	3458 20.000	3651 20.000
22.00	e8	20.00	88	22.0	3	3458 22.000	3651 22.000
25.00	e8	25.00	102	26.0	3	3458 25.000	3651 25.000
28.00	e8	25.00	102	26.0	3	3458 28.000	
30.00	e8	25.00	102	26.0	3	3458 30.000	3651 30.000



Slot drills (3-fluted)

Article no. **3459**



Cutting data page 708

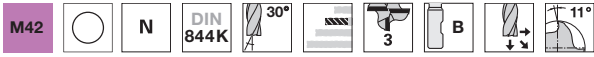

centre cutting

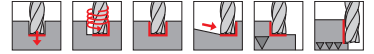

Slot drills (3-fluted)

Article no. **3664**



Cutting data page 708

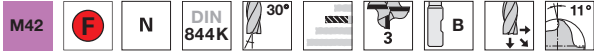

centre cutting

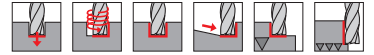

Universal milling cutters

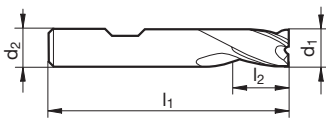

Article no. **3459** **3664**

d1 mm	Tolerance d1	d2 mm	l1 mm	l2 mm	Z	Order no.
2.80	h10	6.00	52	8.0	3	3459 2.800 3664 2.800
3.00	e8	6.00	52	8.0	3	3459 3.000 3664 3.000
3.80	h10	6.00	55	11.0	3	3459 3.800 3664 3.800
4.00	e8	6.00	55	11.0	3	3459 4.000 3664 4.000
4.80	h10	6.00	57	13.0	3	3459 4.800 3664 4.800
5.00	e8	6.00	57	13.0	3	3459 5.000 3664 5.000
5.75	h10	6.00	57	13.0	3	3459 5.750 3664 5.750
6.00	e8	6.00	57	13.0	3	3459 6.000 3664 6.000
6.75	h10	10.00	66	16.0	3	3459 6.750 3664 6.750
7.00	e8	10.00	66	16.0	3	3459 7.000 3664 7.000
7.75	h10	10.00	69	19.0	3	3459 7.750 3664 7.750
8.00	e8	10.00	69	19.0	3	3459 8.000 3664 8.000
9.00	h10	10.00	69	19.0	3	3459 9.000 3664 9.000
9.70	h10	10.00	72	22.0	3	3459 9.700 3664 9.700
10.00	e8	10.00	72	22.0	3	3459 10.000 3664 10.000
11.00	h10	12.00	79	22.0	3	3459 11.000 3664 11.000
11.70	h10	12.00	79	22.0	3	3459 11.700 3664 11.700
12.00	e8	12.00	83	26.0	3	3459 12.000 3664 12.000
13.70	h10	12.00	83	26.0	3	3459 13.700 3664 13.700
14.00	e8	12.00	83	26.0	3	3459 14.000 3664 14.000
15.00	h10	12.00	83	26.0	3	3459 15.000 3664 15.000
15.70	h10	16.00	92	32.0	3	3459 15.700 3664 15.700
16.00	e8	16.00	92	32.0	3	3459 16.000 3664 16.000
18.00	e8	16.00	92	32.0	3	3459 18.000 3664 18.000
20.00	e8	20.00	104	38.0	3	3459 20.000 3664 20.000



Slot drills (3-fluted)

Article no. **3460**



centre cutting

Cutting data page 708

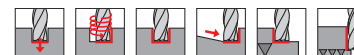

Slot drills (3-fluted)

Article no. **3836**

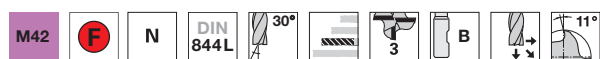

centre cutting

Cutting data page 708

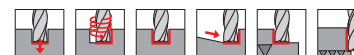

Universal milling cutters

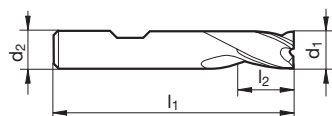

Article no. **3460** **3836**

d1 mm	Tolerance d1	d2 mm	l1 mm	l2 mm	Z	Order no.	
3.00	h10	6.00	56	12.0	3	3460 3.000	3836 3.000
4.00	h10	6.00	63	19.0	3	3460 4.000	3836 4.000
5.00	h10	6.00	68	24.0	3	3460 5.000	3836 5.000
6.00	h10	6.00	68	24.0	3	3460 6.000	3836 6.000
8.00	h10	10.00	88	38.0	3	3460 8.000	3836 8.000
10.00	h10	10.00	95	45.0	3	3460 10.000	3836 10.000
12.00	h10	12.00	110	53.0	3	3460 12.000	3836 12.000
14.00	h10	12.00	110	53.0	3	3460 14.000	3836 14.000
16.00	h10	16.00	123	63.0	3	3460 16.000	3836 16.000
18.00	h10	16.00	123	63.0	3	3460 18.000	3836 18.000
20.00	h10	20.00	141	75.0	3	3460 20.000	3836 20.000



End mills

Article no. **3428**



Cutting data page 708

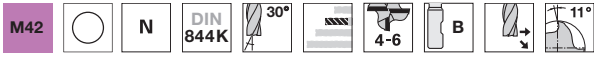

centre cutting

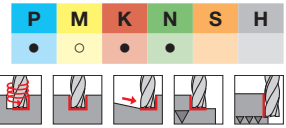

End mills

Article no. **3670**



Cutting data page 708

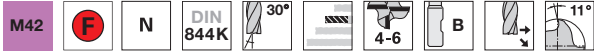

centre cutting

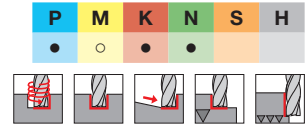

Universal milling cutters

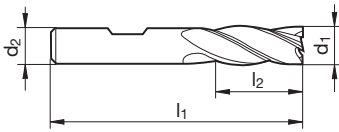

Article no.

3428

3670

d1 js12 mm	d2 mm	l1 mm	l2 mm	Z	Order no.	
2.00	6.00	51	7.0	4	3428 2.000	3670 2.000
2.50	6.00	52	8.0	4	3428 2.500	3670 2.500
3.00	6.00	52	8.0	4	3428 3.000	3670 3.000
3.50	6.00	54	10.0	4	3428 3.500	3670 3.500
4.00	6.00	55	11.0	4	3428 4.000	3670 4.000
4.50	6.00	55	11.0	4	3428 4.500	3670 4.500
5.00	6.00	57	13.0	4	3428 5.000	3670 5.000
5.50	6.00	57	13.0	4	3428 5.500	3670 5.500
6.00	6.00	57	13.0	4	3428 6.000	3670 6.000
6.50	10.00	66	16.0	4	3428 6.500	3670 6.500
7.00	10.00	66	16.0	4	3428 7.000	3670 7.000
7.50	10.00	66	16.0	4	3428 7.500	3670 7.500
8.00	10.00	69	19.0	4	3428 8.000	3670 8.000
8.50	10.00	69	19.0	4	3428 8.500	3670 8.500
9.00	10.00	69	19.0	4	3428 9.000	3670 9.000
9.50	10.00	69	19.0	4	3428 9.500	3670 9.500
10.00	10.00	72	22.0	4	3428 10.000	3670 10.000
11.00	12.00	79	22.0	4	3428 11.000	3670 11.000
12.00	12.00	83	26.0	4	3428 12.000	3670 12.000
13.00	12.00	83	26.0	4	3428 13.000	3670 13.000
14.00	12.00	83	26.0	4	3428 14.000	3670 14.000
15.00	12.00	83	26.0	4	3428 15.000	3670 15.000
16.00	16.00	92	32.0	4	3428 16.000	3670 16.000
18.00	16.00	92	32.0	4	3428 18.000	3670 18.000
20.00	20.00	104	38.0	4	3428 20.000	3670 20.000
22.00	20.00	104	38.0	6	3428 22.000	3670 22.000
24.00	25.00	121	45.0	6	3428 24.000	3670 24.000
25.00	25.00	121	45.0	6	3428 25.000	3670 25.000
26.00	25.00	121	45.0	6	3428 26.000	3670 26.000
28.00	25.00	121	45.0	6	3428 28.000	3670 28.000
30.00	25.00	121	45.0	6	3428 30.000	3670 30.000
32.00	32.00	133	53.0	6	3428 32.000	3670 32.000



End mills

Article no. **3431**



centre cutting

Cutting data page 708

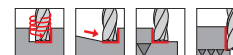

End mills

Article no. **3692**



centre cutting

Cutting data page 708

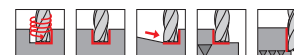

Universal milling cutters

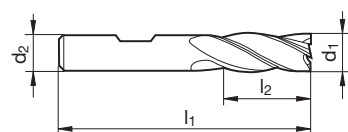

Article no. **3431** **3692**

d1 js12 mm	d2 mm	l1 mm	l2 mm	Z	Order no.
3.00	6.00	56	12.0	4	3431 3.000 3692 3.000
4.00	6.00	63	19.0	4	3431 4.000 3692 4.000
5.00	6.00	68	24.0	4	3431 5.000 3692 5.000
6.00	6.00	68	24.0	4	3431 6.000 3692 6.000
7.00	10.00	80	30.0	4	3431 7.000 3692 7.000
8.00	10.00	88	38.0	4	3431 8.000 3692 8.000
9.00	10.00	88	38.0	4	3431 9.000 3692 9.000
10.00	10.00	95	45.0	4	3431 10.000 3692 10.000
11.00	12.00	102	45.0	4	3431 11.000 3692 11.000
12.00	12.00	110	53.0	4	3431 12.000 3692 12.000
14.00	12.00	110	53.0	4	3431 14.000 3692 14.000
15.00	12.00	110	53.0	4	3431 15.000 3692 15.000
16.00	16.00	123	63.0	4	3431 16.000 3692 16.000
18.00	16.00	123	63.0	4	3431 18.000 3692 18.000
20.00	20.00	141	75.0	4	3431 20.000 3692 20.000
25.00	25.00	166	90.0	6	3431 25.000 3692 25.000
28.00	25.00	166	90.0	6	3431 28.000 3692 28.000
30.00	25.00	166	90.0	6	3431 30.000 3692 30.000
32.00	32.00	186	106.0	6	3431 32.000 3692 32.000
40.00	40.00	217	125.0	6	3431 40.000



End mills

Article no. **3433**



Cutting data page 708



centre cutting

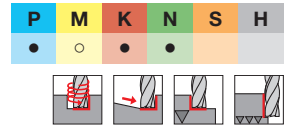

Universal milling cutters

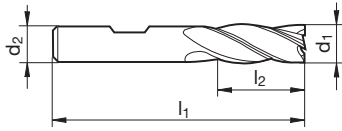

Article no.

3433

d1 js12 mm	d2 mm	l1 mm	l2 mm	Z	Order no.
6.00	6.00	79	40.0	4	3433 6.000
8.00	10.00	105	56.0	4	3433 8.000
10.00	10.00	112	63.0	4	3433 10.000
12.00	12.00	125	71.0	4	3433 12.000
14.00	12.00	125	71.0	4	3433 14.000
16.00	16.00	141	80.0	4	3433 16.000
18.00	16.00	141	80.0	4	3433 18.000
20.00	20.00	163	100.0	4	3433 20.000



Roughing end mills

Article no. **3346**

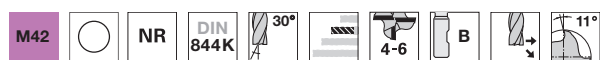

centre cutting

Cutting data page 708

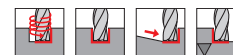

Roughing end mills

Article no. **3690**

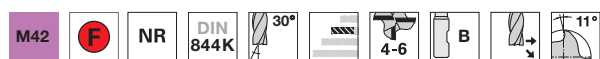

centre cutting

Cutting data page 708

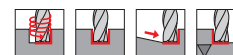

Universal milling cutters

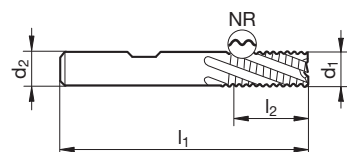

Article no.

3346

3690

d1 js12 mm	d2 mm	l1 mm	l2 mm	Z	Order no.
6.00	6.00	57	13.0	4	3346 6.000 3690 6.000
7.00	10.00	66	16.0	4	3346 7.000 3690 7.000
8.00	10.00	69	19.0	4	3346 8.000 3690 8.000
9.00	10.00	69	19.0	4	3346 9.000 3690 9.000
10.00	10.00	72	22.0	4	3346 10.000 3690 10.000
11.00	12.00	79	22.0	4	3346 11.000 3690 11.000
12.00	12.00	83	26.0	4	3346 12.000 3690 12.000
14.00	12.00	83	26.0	4	3346 14.000 3690 14.000
15.00	12.00	83	26.0	4	3346 15.000 3690 15.000
16.00	16.00	92	32.0	4	3346 16.000 3690 16.000
18.00	16.00	92	32.0	4	3346 18.000 3690 18.000
20.00	20.00	104	38.0	4	3346 20.000 3690 20.000
22.00	20.00	104	38.0	4	3346 22.000 3690 22.000
24.00	25.00	121	45.0	4	3346 24.000 3690 24.000
25.00	25.00	121	45.0	4	3346 25.000 3690 25.000
26.00	25.00	121	45.0	4	3346 26.000 3690 26.000
28.00	25.00	121	45.0	4	3346 28.000 3690 28.000
30.00	25.00	121	45.0	4	3346 30.000 3690 30.000
32.00	32.00	133	53.0	4	3346 32.000 3690 32.000
36.00	32.00	133	53.0	6	3690 36.000
40.00	40.00	155	63.0	6	3346 40.000 3690 40.000



Roughing end mills

Article no. **3347**



centre cutting

Cutting data page 708

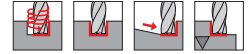

Roughing end mills

Article no. **3650**



centre cutting

Cutting data page 708

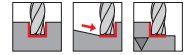

Universal milling cutters

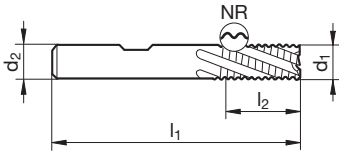

Article no.

3347

3650

d1 js12 mm	d2 mm	l1 mm	l2 mm	Z	Order no.	
					3347	3650
6.00	6.00	68	24.0	4	3347 6.000	3650 6.000
7.00	10.00	80	30.0	4	3347 7.000	3650 7.000
8.00	10.00	88	38.0	4	3347 8.000	3650 8.000
9.00	10.00	88	38.0	4	3347 9.000	3650 9.000
10.00	10.00	95	45.0	4	3347 10.000	3650 10.000
12.00	12.00	110	53.0	4	3347 12.000	3650 12.000
14.00	12.00	110	53.0	4	3347 14.000	3650 14.000
16.00	16.00	123	63.0	4	3347 16.000	3650 16.000
18.00	16.00	123	63.0	4	3347 18.000	3650 18.000
20.00	20.00	141	75.0	4	3347 20.000	3650 20.000
22.00	20.00	141	75.0	4	3347 22.000	3650 22.000
25.00	25.00	166	90.0	4	3347 25.000	3650 25.000
28.00	25.00	166	90.0	4	3347 28.000	3650 28.000
32.00	32.00	186	106.0	4	3347 32.000	3650 32.000
36.00	32.00	186	106.0	6	3347 36.000	3650 36.000



Roughing/finishing end mills

Article no. **3343**

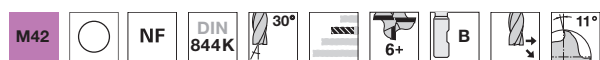

centre cutting

Cutting data page 708

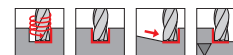

Roughing/finishing end mills

Article no. **3669**

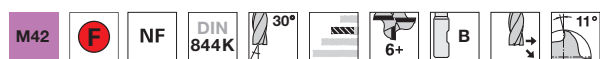

centre cutting

Cutting data page 708

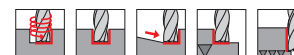

Universal milling cutters

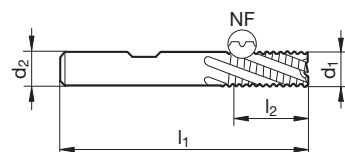

Article no. **3343** **3669**

d1 js12 mm	d2 mm	l1 mm	l2 mm	Z	Order no.
6.00	6.00	57	13.0	4	3343 6.000 3669 6.000
7.00	10.00	66	16.0	4	3343 7.000 3669 7.000
8.00	10.00	69	19.0	4	3343 8.000 3669 8.000
9.00	10.00	69	19.0	4	3343 9.000
10.00	10.00	72	22.0	4	3343 10.000 3669 10.000
11.00	12.00	79	22.0	4	3343 11.000 3669 11.000
12.00	12.00	83	26.0	4	3343 12.000 3669 12.000
14.00	12.00	83	26.0	4	3343 14.000 3669 14.000
15.00	12.00	83	26.0	4	3343 15.000 3669 15.000
16.00	16.00	92	32.0	4	3343 16.000 3669 16.000
18.00	16.00	92	32.0	4	3343 18.000 3669 18.000
20.00	20.00	104	38.0	4	3343 20.000 3669 20.000
22.00	20.00	104	38.0	4	3343 22.000 3669 22.000
24.00	25.00	121	45.0	4	3343 24.000 3669 24.000
25.00	25.00	121	45.0	4	3343 25.000 3669 25.000
26.00	25.00	121	45.0	4	3669 26.000
28.00	25.00	121	45.0	4	3343 28.000 3669 28.000
30.00	25.00	121	45.0	4	3343 30.000 3669 30.000
32.00	32.00	133	53.0	4	3343 32.000 3669 32.000
36.00	32.00	133	53.0	6	3343 36.000
40.00	40.00	155	63.0	6	3343 40.000



Roughing/finishing end mills

Article no. **3342**



centre cutting

Cutting data page 708

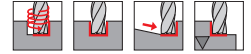

Roughing/finishing end mills

Article no. **3698**



centre cutting

Cutting data page 708

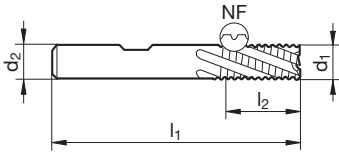
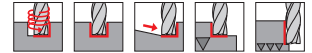

Article no.

3342

3698

d1 js12 mm	d2 mm	l1 mm	l2 mm	Z	Order no.	
					3342	3698
6.00	6.00	68	24.0	4	3342 6.000	3698 6.000
8.00	10.00	88	38.0	4	3342 8.000	3698 8.000
10.00	10.00	95	45.0	4	3342 10.000	3698 10.000
12.00	12.00	110	53.0	4	3342 12.000	3698 12.000
14.00	12.00	110	53.0	4	3342 14.000	3698 14.000
16.00	16.00	123	63.0	4	3342 16.000	3698 16.000
18.00	16.00	123	63.0	4	3342 18.000	3698 18.000
20.00	20.00	141	75.0	4	3342 20.000	3698 20.000
22.00	20.00	141	75.0	4	3342 22.000	3698 22.000
25.00	25.00	166	90.0	4	3342 25.000	3698 25.000
28.00	25.00	166	90.0	4	3342 28.000	3698 28.000
32.00	32.00	186	106.0	4	3342 32.000	3698 32.000



Morse taper end mills

Article no. 3117



Cutting data page 708

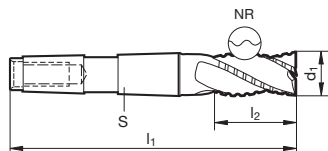
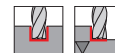
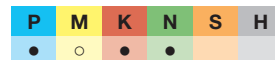
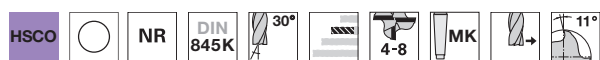

Article no. 3117

d1 js12 mm	S	l1 mm	l2 mm	Z	Order no.
10.00	MK-1	92	22.0	4	3117 10.000
14.00	MK-2	111	26.0	4	3117 14.000
16.00	MK-2	117	32.0	4	3117 16.000
20.00	MK-2	123	38.0	4	3117 20.000
25.00	MK-3	147	45.0	5	3117 25.000
26.00	MK-3	147	45.0	5	3117 26.000
28.00	MK-3	147	45.0	5	3117 28.000
30.00	MK-3	147	45.0	5	3117 30.000
32.00	MK-4	201	53.0	6	3117 32.000
40.00	MK-4	211	63.0	6	3117 40.000
50.00	MK-5	261	75.0	8	3117 50.000

Universal milling cutters



Morse taper end mills

Article no. **3440**



Cutting data page 708

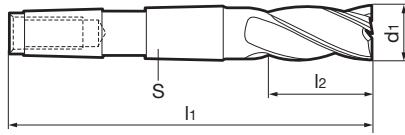
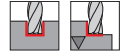

Article no. **3440**

d1 js12 mm	S	l1 mm	l2 mm	Z	Order no.
14.00	MK-2	111	26.0	4	3440 14.000
16.00	MK-2	117	32.0	4	3440 16.000
18.00	MK-2	117	32.0	4	3440 18.000
20.00	MK-2	123	38.0	4	3440 20.000
22.00	MK-2	123	38.0	5	3440 22.000
25.00	MK-3	147	45.0	5	3440 25.000
26.00	MK-3	147	45.0	5	3440 26.000
28.00	MK-3	147	45.0	5	3440 28.000
30.00	MK-3	147	45.0	6	3440 30.000
32.00	MK-4	178	53.0	6	3440 32.000
36.00	MK-4	178	53.0	6	3440 36.000
40.00	MK-4	188	63.0	6	3440 40.000
45.00	MK-4	188	63.0	6	3440 45.000

Morse taper end mills

Article no. **3121**



Cutting data page 708

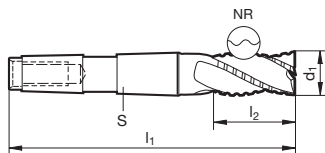

Article no. **3121**

d1 js12 mm	S	l1 mm	l2 mm	Z	Order no.
16.00	MK-2	148	63.0	4	3121 16.000
20.00	MK-2	160	75.0	4	3121 20.000
25.00	MK-3	192	90.0	5	3121 25.000
28.00	MK-3	192	90.0	5	3121 28.000
30.00	MK-3	192	90.0	5	3121 30.000
32.00	MK-4	254	106.0	6	3121 32.000
36.00	MK-4	254	106.0	6	3121 36.000
40.00	MK-4	273	125.0	6	3121 40.000
50.00	MK-5	336	150.0	8	3121 50.000



Morse taper end mills

Article no. **3120**



Cutting data page 708

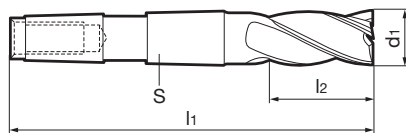

Article no. **3120**

d1 js12 mm	S	l1 mm	l2 mm	Z	Order no.
16.00	MK-2	148	63.0	4	3120 16.000
16.00	MK-3	165	63.0	4	3120 16.001
18.00	MK-2	148	63.0	4	3120 18.000
18.00	MK-3	165	63.0	4	3120 18.001
20.00	MK-2	160	75.0	4	3120 20.000
25.00	MK-3	192	90.0	5	3120 25.000
28.00	MK-3	192	90.0	5	3120 28.000
28.00	MK-4	265	112.0	5	3120 28.001
32.00	MK-4	231	106.0	6	3120 32.000
36.00	MK-4	231	106.0	6	3120 36.000
40.00	MK-4	250	125.0	6	3120 40.000
50.00	MK-5	308	150.0	6	3120 50.000
50.00	MK-5	298	112.0	6	3120 50.001
56.00	MK-5	308	150.0	8	3120 56.000
63.00	MK-5	338	180.0	8	3120 63.000
63.00	MK-5	411	225.0	8	3120 63.002

Universal milling cutters



Side and face cutters

Article no. **3530**



cross tooth

Cutting data page 708

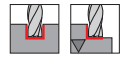

Universal milling cutters

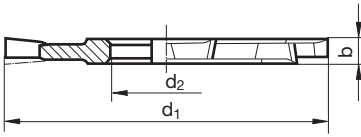

Article no.

3530

d1 k14 mm	d2 mm	b mm	Z	Order no.
50.00	16.00	4	12	3530 50.000
50.00	16.00	6	12	3530 50.002
50.00	16.00	8	12	3530 50.003
63.00	22.00	5	12	3530 63.000
63.00	22.00	6	12	3530 63.001
63.00	22.00	8	12	3530 63.002
63.00	22.00	10	12	3530 63.003
63.00	22.00	12	12	3530 63.004
80.00	27.00	5	14	3530 80.000
80.00	27.00	6	14	3530 80.001
80.00	27.00	8	14	3530 80.002
80.00	27.00	10	14	3530 80.003
80.00	27.00	12	14	3530 80.004
80.00	27.00	16	14	3530 80.006
100.00	32.00	6	14	3530 100.000
100.00	32.00	8	14	3530 100.001
100.00	32.00	10	14	3530 100.002
100.00	32.00	12	14	3530 100.003
100.00	32.00	14	14	3530 100.004
100.00	32.00	16	14	3530 100.005
100.00	32.00	20	14	3530 100.007
125.00	32.00	6	16	3530 125.000
125.00	32.00	8	16	3530 125.001
125.00	32.00	10	16	3530 125.002
125.00	32.00	14	16	3530 125.004
125.00	32.00	16	16	3530 125.005
125.00	32.00	20	16	3530 125.007
160.00	40.00	10	18	3530 160.001
160.00	40.00	12	18	3530 160.002
160.00	40.00	14	18	3530 160.003
160.00	40.00	20	18	3530 160.006
200.00	40.00	20	24	3530 200.005



Shell end mills

Article no. **3504**



face cutting • without centre cutting

Cutting data page 708



Shell end mills

Article no. **3654**



face cutting • without centre cutting

Cutting data page 708



Universal milling cutters

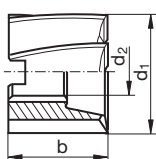

Article no. **3504** **3654**

d1 k12 mm	d2 mm	b mm	Z	Order no.
40.00	16.00	32	8	3504 40.000 3654 40.000
50.00	22.00	36	8	3504 50.000 3654 50.000
63.00	27.00	40	8	3504 63.000 3654 63.000
80.00	27.00	45	10	3504 80.000 3654 80.000
125.00	40.00	56	14	3504 125.000



Shell end mills

Article no. **3185**



face cutting • without centre cutting

Cutting data page 708

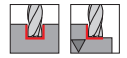

Shell end mills

Article no. **3749**



face cutting • without centre cutting

Cutting data page 708

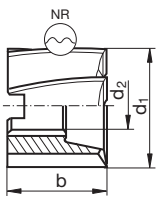
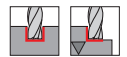

Article no. **3185** **3749**

d1 k12 mm	d2 mm	b mm	Z	Order no.
40.00	16.00	32	6	3185 40.000 3749 40.000
50.00	22.00	36	6	3185 50.000 3749 50.000
63.00	27.00	40	8	3185 63.000 3749 63.000
80.00	27.00	45	8	3185 80.000 3749 80.000
100.00	32.00	50	10	3185 100.000 3749 100.000
125.00	40.00	56	12	3185 125.000

Shell end mills

Article no. **3187**



face cutting • without centre cutting

Cutting data page 708

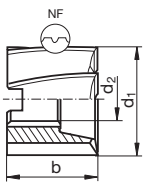
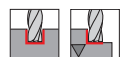
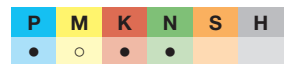

Article no. **3187**

d1 k12 mm	d2 mm	b mm	Z	Order no.
40.00	16.00	32	6	3187 40.000
50.00	22.00	36	6	3187 50.000
63.00	27.00	40	8	3187 63.000
80.00	27.00	45	8	3187 80.000
100.00	32.00	50	10	3187 100.000
125.00	40.00	56	12	3187 125.000



T-slot end mills

Article no. 3570

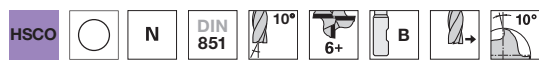

cross tooth

Cutting data page 708

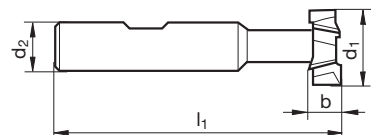
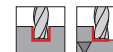

Article no. 3570

d1 mm	Tolerance d1	d2 mm	l1 mm	b mm	Z	Order no.
12.50	d11	10.00	57	6.0	6	3570 12.500
16.00	d11	10.00	62	8.0	6	3570 16.000
18.00	d11	12.00	70	8.0	6	3570 18.000
19.00	d11	12.00	71	9.0	6	3570 19.000
21.00	d11	12.00	74	9.0	6	3570 21.000
22.00	d11	12.00	75	10.0	6	3570 22.000
25.00	d11	16.00	82	11.0	8	3570 25.000
28.00	d11	16.00	85	12.0	8	3570 28.000
32.00	d11	16.00	90	14.0	8	3570 32.000

Woodruff cutters

Article no. 3580

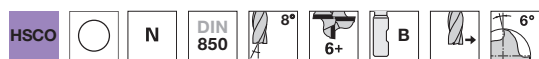

cross tooth

Cutting data page 708

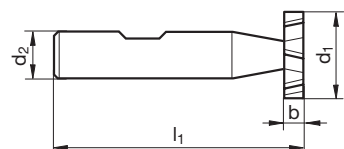
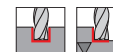

Article no. 3580

d1 mm	Tolerance d1	d2 mm	l1 mm	b mm	Z	Order no.
4.50	h12	6.00	50	1.0	6	3580 4.500
7.50	h12	6.00	50	1.5	6	3580 7.500
7.50	h12	6.00	50	2.0	6	3580 7.501
10.50	h12	6.00	50	2.0	6	3580 10.500
10.50	h12	6.00	50	2.5	6	3580 10.501
10.50	h12	6.00	50	3.0	6	3580 10.502
13.50	h12	10.00	56	3.0	6	3580 13.500
13.50	h12	10.00	56	4.0	6	3580 13.501
16.50	h12	10.00	56	3.0	6	3580 16.500
16.50	h12	10.00	56	4.0	6	3580 16.501
16.50	h12	10.00	56	5.0	6	3580 16.502
19.50	h12	10.00	63	4.0	8	3580 19.500
19.50	h12	10.00	63	5.0	8	3580 19.501
19.50	h12	10.00	63	6.0	8	3580 19.502
22.50	h12	10.00	63	5.0	8	3580 22.500
22.50	h12	10.00	63	6.0	8	3580 22.501
22.50	h12	10.00	63	8.0	8	3580 22.502
25.50	h12	10.00	63	6.0	10	3580 25.500
28.50	h12	10.00	63	6.0	10	3580 28.500
28.50	h12	10.00	63	8.0	10	3580 28.501
28.50	h12	12.00	71	10.0	10	3580 28.502
32.50	h12	12.00	71	8.0	10	3580 32.500
32.50	h12	12.00	71	10.0	10	3580 32.501
45.50	h12	12.00	71	10.0	12	3580 45.500



Dovetail cutters

Article no. **3572**



Cutting data page 708



without centre cutting

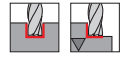

Dovetail cutters

Article no. **3576**



Cutting data page 708



without centre cutting

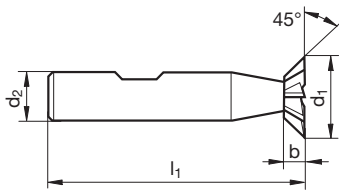
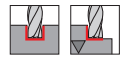

Article no.

3572

3576

d1 mm	d2 mm	l1 mm	b mm	Z
16.00	12.00	60	4.0	10
20.00	12.00	63	5.0	10
25.00	12.00	67	6.3	10
32.00	16.00	71	8.0	12

Order no.	
3572 16.000	3576 16.000
3572 20.000	3576 20.000
3572 25.000	3576 25.000
3572 32.000	3576 32.000

Dovetail cutters

Article no. **3574**



Cutting data page 708



without centre cutting

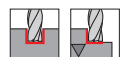

Dovetail cutters

Article no. **3577**



Cutting data page 708

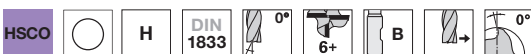

without centre cutting

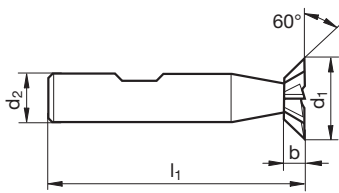
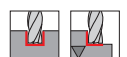

Article no.

3574

3577

d1 mm	d2 mm	l1 mm	b mm	Z
16.00	12.00	60	6.3	10
20.00	12.00	63	8.0	10
25.00	12.00	67	10.0	10
32.00	16.00	71	12.5	12

Order no.	
3574 16.000	3577 16.000
3574 20.000	3577 20.000
3574 25.000	3577 25.000
3574 32.000	3577 32.000



Quadrant milling cutters

Article no. 3176



Cutting data page 708



without centre cutting

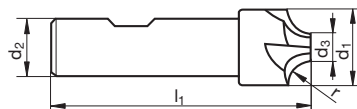

Article no. **3176**

r mm	d1 mm	d2 mm	d3 mm	l1 mm	Z	Order no.
2.00	10.00	10.00	6	60	4	3176 2.000
2.50	10.00	10.00	6	60	4	3176 2.500
3.00	12.00	12.00	6	60	4	3176 3.000
4.00	14.00	12.00	6	60	4	3176 4.000
5.00	16.00	12.00	6	60	4	3176 5.000
6.00	20.00	16.00	8	67	4	3176 6.000
	24.00	16.00	8	71	4	3176 8.000
	28.00	25.00	8	85	4	3176 10.000
	34.00	25.00	10	90	4	3176 12.000
	48.00	25.00	16	100	4	3176 16.000
	56.00	32.00	16	112	4	3176 20.000

Universal milling cutters



RF 100 Diver

Milling conditions:

HPC stable machining conditions
high drive power

short tools

long tools

Correction factors:



a_p roughing > 1.5xD

v_c -25 % f_z -25 %



Machining group	Application	v_c (m/min)	a_p max.	a_e max.	f_z (mm/z) with nom. \emptyset							
					4	5	6	8	10	12	16	20
P1.1.1 Unalloyed steel, annealed, 0.15 % C, Rm 420 N/mm ² , 125 HB P1.1.2 Unalloyed steel, heat-treated, 0.15 % C, Rm 420 N/mm ² , 125 HB P1.1.3 Unalloyed steel, annealed, 0.45 % C, Rm 640 N/mm ² , 190 HB P1.1.4 Unalloyed steel, heat-treated, 0.45 % C, Rm 640 N/mm ² , 190 HB P1.1.5 Unalloyed steel, heat-treated, 0.45 % C, Rm 850 N/mm ² , 250 HB P1.1.6 Unalloyed steel, annealed, 0.75 % C, Rm 915 N/mm ² , 270 HB P1.1.7 Unalloyed steel, heat-treated, 0.75 % C, Rm 1020 N/mm ² , 300 HB	Plunging	270	1xD	1xD	0.015	0.025	0.030	0.040	0.045	0.060	0.075	0.075
	Slotting	270	1xD	1xD	0.020	0.025	0.035	0.050	0.060	0.080	0.100	0.100
	Roughing	350	1.5xD	0.4xD	0.025	0.040	0.050	0.065	0.075	0.100	0.125	0.125
	Finishing	540	2xD	0.02xD	0.020	0.035	0.045	0.055	0.065	0.090	0.110	0.110
P2.1.1 Low-alloy steel, annealed, Rm 610 N/mm ² , 180 HB P2.1.2 Low-alloy steel, heat-treated, Rm 930 N/mm ² , 275 HB P2.1.3 Low-alloy steel, heat-treated, Rm 1020 N/mm ² , 300 HB P2.1.4 Low-alloy steel, heat-treated, Rm 1190 N/mm ² , 350 HB	Plunging	230	1xD	1xD	0.015	0.025	0.030	0.040	0.045	0.060	0.075	0.075
	Slotting	230	1xD	1xD	0.020	0.025	0.035	0.050	0.060	0.080	0.100	0.100
	Roughing	300	1.5xD	0.4xD	0.025	0.040	0.050	0.065	0.075	0.100	0.125	0.125
	Finishing	460	2xD	0.02xD	0.020	0.035	0.045	0.055	0.065	0.090	0.110	0.110
P3.1.1 High-alloy steel and tool steel, annealed, Rm 680 N/mm ² , 200 HB P3.1.2 High-alloy steel and tool steel, hardened and tempered, Rm 1100 N/mm ² , 325 HB	Plunging	180	1xD	1xD	0.015	0.020	0.025	0.035	0.040	0.055	0.070	0.070
	Slotting	180	1xD	1xD	0.015	0.025	0.030	0.045	0.055	0.070	0.090	0.090
	Roughing	235	1.5xD	0.4xD	0.025	0.035	0.045	0.055	0.070	0.090	0.115	0.115
	Finishing	360	2xD	0.02xD	0.020	0.030	0.040	0.050	0.060	0.080	0.100	0.100
M1.1.1 Stainless steel, ferritic/martensitic, with machining additives M1.1.2 Stainless steel, ferritic/martensitic, annealed, Rm 680 N/mm ² , 200 HB	Plunging	115	1xD	1xD	0.015	0.020	0.025	0.035	0.040	0.055	0.070	0.070
	Slotting	115	1xD	1xD	0.015	0.025	0.030	0.045	0.055	0.070	0.090	0.090
	Roughing	170	1.5xD	0.33xD	0.025	0.035	0.045	0.060	0.070	0.095	0.115	0.115
	Finishing	230	2xD	0.02xD	0.020	0.030	0.040	0.050	0.060	0.080	0.100	0.100
M1.1.3 Stainless steel, ferritic/martensitic, heat-treated, Rm 810 N/mm ² , 240 HB	Plunging	85	1xD	1xD	0.010	0.020	0.025	0.030	0.035	0.050	0.060	0.060
	Slotting	85	1xD	1xD	0.015	0.020	0.030	0.040	0.050	0.065	0.080	0.080
	Roughing	125	1.5xD	0.33xD	0.020	0.030	0.040	0.055	0.065	0.085	0.105	0.105
	Finishing	165	2xD	0.02xD	0.020	0.025	0.035	0.045	0.055	0.070	0.090	0.090
M2.1.1 Stainless steel, austenitic, quenched, 180 HB	Plunging	80	1xD	1xD	0.010	0.020	0.025	0.030	0.035	0.050	0.060	0.060
	Slotting	80	1xD	1xD	0.015	0.020	0.030	0.040	0.050	0.065	0.080	0.080
	Roughing	120	1.5xD	0.33xD	0.020	0.030	0.040	0.050	0.060	0.085	0.105	0.105
	Finishing	160	2xD	0.02xD	0.020	0.025	0.035	0.045	0.055	0.070	0.090	0.090
M2.2.1 Duplex steel, high-strength stainless steels	Plunging	60	1xD	1xD	0.010	0.015	0.020	0.025	0.030	0.040	0.050	0.050
	Slotting	60	1xD	1xD	0.010	0.020	0.025	0.035	0.040	0.055	0.070	0.070
	Roughing	90	1.5xD	0.33xD	0.020	0.025	0.035	0.045	0.055	0.075	0.090	0.090
	Finishing	120	2xD	0.02xD	0.015	0.025	0.030	0.040	0.045	0.060	0.075	0.075
K1.1.1 Grey cast iron, pearlitic/ferritic, 180 HB K1.1.2 Grey cast iron, pearlitic/martensitic, 260 HB K1.2.1 Cast iron with spheroidal graphite, ferritic, 160 HB K1.2.2 Cast iron with spheroidal graphite, pearlitic, 250 HB	Slotting	175	1xD	1xD	0.020	0.030	0.040	0.055	0.070	0.090	0.115	0.115
	Roughing	200	1xD	0.75xD	0.025	0.040	0.050	0.065	0.080	0.105	0.130	0.130
	Finishing	350	1xD	0.02xD	0.025	0.040	0.050	0.065	0.075	0.100	0.125	0.125
	Plunging	175	1xD	1xD	0.015	0.025	0.035	0.045	0.050	0.070	0.085	0.085
N1.1.1 Wrought aluminium alloys, non-hardened, 60 HB N1.1.2 Wrought aluminium alloys, hardened, 100 HB	Plunging	500	1xD	1xD	0.020	0.030	0.040	0.050	0.060	0.080	0.100	0.100
	Slotting	500	1xD	1xD	0.025	0.035	0.045	0.065	0.080	0.105	0.130	0.130
	Roughing	650	1.5xD	0.4xD	0.035	0.050	0.065	0.080	0.100	0.130	0.165	0.165
	Finishing	1000	2xD	0.02xD	0.030	0.045	0.055	0.070	0.085	0.115	0.145	0.145







Machining group	Application	V _c (m/min)	a _p max.	a _e max.	f _z (mm/z) with nom. Ø							
					4	5	6	8	10	12	16	20
N2.1.1 Aluminium casting alloys, non-hardened, ≤ 12 % Si, 75 HB N2.1.2 Aluminium casting alloys, hardened, ≤ 12 % Si, 90 HB	Plunging	340	1xD	1xD	0.015	0.025	0.035	0.040	0.050	0.065	0.085	0.085
	Slotting	340	1xD	1xD	0.020	0.030	0.040	0.055	0.065	0.090	0.110	0.110
	Roughing	440	1.5xD	0.4xD	0.030	0.040	0.055	0.070	0.085	0.110	0.140	0.140
	Finishing	680	2xD	0.02xD	0.025	0.035	0.050	0.060	0.075	0.095	0.120	0.120
N2.1.3 Aluminium casting alloys, non-hardened, > 12 % Si, 130 HB	Plunging	270	1xD	1xD	0.015	0.025	0.035	0.040	0.050	0.065	0.085	0.085
	Slotting	270	1xD	1xD	0.020	0.030	0.040	0.055	0.065	0.090	0.110	0.110
	Roughing	350	1.5xD	0.4xD	0.030	0.040	0.055	0.070	0.085	0.110	0.140	0.140
	Finishing	535	2xD	0.02xD	0.025	0.035	0.050	0.060	0.075	0.095	0.120	0.120
N3.1.1 Copper and copper alloys: Free-machining alloy, Pb > 1 % N3.1.2 Copper and copper alloys: CuZn, CuSnZn	Plunging	260	1xD	1xD	0.015	0.025	0.035	0.040	0.050	0.065	0.085	0.085
	Slotting	260	1xD	1xD	0.020	0.030	0.040	0.055	0.065	0.090	0.110	0.110
	Roughing	335	1.5xD	0.4xD	0.030	0.040	0.055	0.070	0.085	0.110	0.140	0.140
	Finishing	515	2xD	0.02xD	0.025	0.035	0.050	0.060	0.075	0.095	0.120	0.120
N3.1.3 Copper and copper alloys: CuSn, lead-free copper and copper electrolyte	Plunging	200	1xD	1xD	0.015	0.025	0.030	0.040	0.045	0.060	0.075	0.075
	Slotting	200	1xD	1xD	0.020	0.025	0.035	0.050	0.060	0.080	0.100	0.100
	Roughing	265	1.5xD	0.4	0.025	0.040	0.050	0.065	0.075	0.100	0.125	0.125
	Finishing	405	2xD	0.02xD	0.020	0.035	0.045	0.055	0.065	0.090	0.110	0.110
S1.1.1 Heat-resistant alloys, Fe-based, annealed, 200 HB	Plunging	35	1xD	1xD	0.010	0.015	0.020	0.025	0.030	0.040	0.055	0.055
	Slotting	35	1xD	1xD	0.010	0.020	0.025	0.035	0.040	0.055	0.070	0.070
	Roughing	50	1.5xD	0.33xD	0.020	0.025	0.035	0.045	0.055	0.075	0.090	0.090
	Finishing	65	2xD	0.02xD	0.015	0.025	0.030	0.040	0.045	0.060	0.075	0.075
S1.1.2 Heat-resistant alloys, Fe-based, hardened, 280 HB	Plunging	30	1xD	1xD	0.010	0.015	0.020	0.025	0.030	0.040	0.055	0.055
	Slotting	30	1xD	1xD	0.010	0.020	0.025	0.035	0.040	0.055	0.070	0.070
	Roughing	40	1.5xD	0.33xD	0.020	0.025	0.035	0.045	0.055	0.075	0.090	0.090
	Finishing	55	2xD	0.02xD	0.015	0.025	0.030	0.040	0.045	0.060	0.075	0.075
S1.1.3 Heat-resistant alloys, Ni- or Co-based, annealed, 250 HB	Plunging	20	1xD	1xD	0.010	0.015	0.015	0.020	0.025	0.035	0.045	0.045
	Slotting	20	1xD	1xD	0.010	0.015	0.020	0.030	0.035	0.045	0.055	0.055
	Roughing	30	1.5xD	0.33xD	0.015	0.020	0.030	0.035	0.045	0.060	0.075	0.075
	Finishing	40	2xD	0.02xD	0.015	0.020	0.025	0.030	0.040	0.050	0.065	0.065
S1.1.4 Heat-resistant alloys, Ni- or Co-based, hardened, 350 HB	Plunging	15	1xD	1xD	0.010	0.010	0.015	0.020	0.025	0.030	0.040	0.040
	Slotting	15	1xD	1xD	0.010	0.015	0.020	0.025	0.030	0.045	0.055	0.055
	Roughing	20	1.5xD	0.33xD	0.015	0.020	0.030	0.035	0.040	0.055	0.070	0.070
	Finishing	30	2xD	0.02xD	0.010	0.020	0.025	0.030	0.035	0.045	0.060	0.060
S1.1.5 Heat-resistant alloys, Ni- or Co-based, cast, 320 HB	Plunging	15	1xD	1xD	0.010	0.015	0.015	0.020	0.025	0.035	0.045	0.045
	Slotting	15	1xD	1xD	0.010	0.015	0.020	0.030	0.035	0.045	0.055	0.055
	Roughing	25	1.5xD	0.33xD	0.015	0.020	0.030	0.035	0.045	0.060	0.075	0.075
	Finishing	35	2xD	0.02xD	0.015	0.020	0.025	0.030	0.040	0.050	0.065	0.065
S2.1.1 Titanium alloys, pure titanium, Rm 400 N/mm ²	Plunging	80	1xD	1xD	0.015	0.020	0.025	0.035	0.040	0.055	0.065	0.065
	Slotting	80	1xD	1xD	0.015	0.025	0.030	0.045	0.055	0.070	0.090	0.090
	Roughing	120	1.5xD	0.33xD	0.025	0.035	0.045	0.055	0.070	0.090	0.115	0.115
	Finishing	160	2xD	0.02xD	0.020	0.030	0.040	0.050	0.060	0.075	0.095	0.095
S2.1.2 Titanium alloys, Alpha and Beta alloys, hardened, Rm 1050 N/mm ²	Plunging	65	1xD	1xD	0.010	0.020	0.025	0.030	0.035	0.045	0.060	0.060
	Slotting	65	1xD	1xD	0.015	0.020	0.030	0.040	0.045	0.065	0.080	0.080
	Roughing	100	1.5xD	0.33xD	0.020	0.030	0.040	0.050	0.060	0.080	0.105	0.105
	Finishing	135	2xD	0.02xD	0.015	0.025	0.035	0.045	0.050	0.070	0.085	0.085
H1.1.1 Hardened steel, hardened and tempered, < 55 HRC	Roughing	190	1xD	0.05xD	0.035	0.055	0.070	0.090	0.105	0.140	0.175	0.175
	Finishing	180	1xD	0.01xD	0.015	0.020	0.030	0.035	0.040	0.055	0.070	0.070
H2.1.1 Chilled cast iron, 400 HB	Roughing	225	1xD	0.1xD	0.035	0.055	0.075	0.090	0.110	0.145	0.185	0.185
	Finishing	235	1xD	0.01xD	0.015	0.025	0.030	0.040	0.050	0.065	0.080	0.080
H2.1.2 Chilled cast iron, hardened and tempered, < 55 HRC	Roughing	175	1xD	0.05xD	0.035	0.055	0.070	0.090	0.105	0.140	0.180	0.180
	Finishing	170	1xD	0.01xD	0.015	0.020	0.030	0.035	0.045	0.055	0.070	0.070







RF 100 Speed

Milling conditions:

	stable machining conditions low cutting depths, high cutting values
	stable machining conditions high drive power
	long tools
	medium length tools

Correction factors:

	a_p roughing > 1.5xD	v_c -25 %	f_z -25 %
	medium length tools	v_c -40 %	f_z -40 %
	extra length tools	v_c -60 %	f_z -55 %
	uncoated tools	v_c -50 %	f_z -25 %



Cutting data

Machining group	Application	Type	v_c (m/min)	a_p max.	a_e max.	f_z (mm/z) with nom. Ø							
						4	5	6	8	10	12	16	20
P1.1.1 Unalloyed steel, annealed, 0.15 % C, Rm 420 N/mm ² , 125 HB P1.1.2 Unalloyed steel, heat-treated, 0.15 % C, Rm 420 N/mm ² , 125 HB P1.1.3 Unalloyed steel, annealed, 0.45 % C, Rm 640 N/mm ² , 190 HB P1.1.4 Unalloyed steel, heat-treated, 0.45 % C, Rm 640 N/mm ² , 190 HB P1.1.5 Unalloyed steel, heat-treated, 0.45 % C, Rm 850 N/mm ² , 250 HB P1.1.6 Unalloyed steel, annealed, 0.75 % C, Rm 915 N/mm ² , 270 HB P1.1.7 Unalloyed steel, heat-treated, 0.75 % C, Rm 1020 N/mm ² , 300 HB	HPC Roughing	Speed M	260	3xD	0.15xD	0.040	0.060	0.080	0.095	0.115	0.155	0.195	0.195
	HSC Roughing	Speed M	275	3xD	0.1xD	0.045	0.070	0.095	0.120	0.140	0.190	0.235	0.235
	HSC Finishing	Speed M	290	3xD	0.01xD	0.020	0.030	0.040	0.050	0.060	0.075	0.095	0.095
P2.1.1 Low-alloy steel, annealed, Rm 610 N/mm ² , 180 HB P2.1.2 Low-alloy steel, heat-treated, Rm 930 N/mm ² , 275 HB P2.1.3 Low-alloy steel, heat-treated, Rm 1020 N/mm ² , 300 HB P2.1.4 Low-alloy steel, heat-treated, Rm 1190 N/mm ² , 350 HB	HPC Roughing	Speed M	235	3xD	0.15xD	0.035	0.055	0.070	0.090	0.105	0.145	0.180	0.180
	HSC Roughing	Speed M	245	3xD	0.1xD	0.045	0.065	0.085	0.110	0.130	0.175	0.215	0.215
	HSC Finishing	Speed M	255	3xD	0.01xD	0.020	0.025	0.035	0.045	0.055	0.070	0.090	0.090
P3.1.1 High-alloy steel and tool steel, annealed, Rm 680 N/mm ² , 200 HB P3.1.2 High-alloy steel and tool steel, hardened and tempered, Rm 1100 N/mm ² , 325 HB	HPC Roughing	Speed P	195	3xD	0.15xD	0.030	0.050	0.065	0.080	0.095	0.130	0.160	0.160
	HSC Roughing	Speed P	210	3xD	0.1xD	0.040	0.060	0.080	0.100	0.120	0.155	0.195	0.195
	Finishing	Speed P	215	3xD	0.01xD	0.015	0.025	0.030	0.040	0.050	0.065	0.080	0.080
M1.1.1 Stainless steel, ferritic/martensitic, with machining additives M1.1.2 Stainless steel, ferritic/martensitic, annealed, Rm 680 N/mm ² , 200 HB	HPC Roughing	Speed M	185	3xD	0.1xD	0.040	0.060	0.080	0.100	0.120	0.155	0.195	0.195
	HSC Roughing	Speed M	195	3xD	0.08xD	0.045	0.065	0.085	0.105	0.130	0.170	0.215	0.215
	Finishing	Speed M	190	3xD	0.02xD	0.015	0.025	0.030	0.040	0.050	0.065	0.080	0.080
M1.1.3 Stainless steel, ferritic/martensitic, heat-treated, Rm 810 N/mm ² , 240 HB	HPC Roughing	Speed M	135	3xD	0.1xD	0.035	0.055	0.070	0.090	0.105	0.140	0.180	0.180
	HSC Roughing	Speed M	140	3xD	0.08xD	0.040	0.060	0.075	0.095	0.115	0.155	0.195	0.195
	Finishing	Speed M	140	3xD	0.02xD	0.015	0.020	0.030	0.035	0.045	0.060	0.070	0.070
M2.1.1 Stainless steel, austenitic, quenched, 180 HB	HPC Roughing	5 Speed	125	3xD	0.1xD	0.035	0.055	0.070	0.090	0.105	0.140	0.175	0.175
	HSC Roughing	5 Speed	130	3xD	0.08xD	0.040	0.060	0.075	0.095	0.115	0.155	0.190	0.190
	Finishing	5 Speed	130	3xD	0.02xD	0.015	0.020	0.030	0.035	0.045	0.060	0.070	0.070
M2.2.1 Duplex steel, high-strength stainless steels	HPC Roughing	5 Speed	90	3xD	0.1xD	0.030	0.045	0.060	0.075	0.095	0.125	0.155	0.155
	HSC Roughing	5 Speed	95	3xD	0.08xD	0.035	0.050	0.065	0.085	0.100	0.135	0.170	0.170
	Finishing	5 Speed	95	3xD	0.02xD	0.015	0.020	0.025	0.030	0.040	0.050	0.065	0.065
K1.1.1 Grey cast iron, pearlitic/ferritic, 180 HB K1.1.2 Grey cast iron, pearlitic/martensitic, 260 HB K1.2.1 Cast iron with spheroidal graphite, ferritic, 160 HB K1.2.2 Cast iron with spheroidal graphite, pearlitic, 250 HB	HPC Roughing	Speed P	235	3xD	0.15xD	0.040	0.060	0.080	0.100	0.125	0.165	0.205	0.205
	HSC Roughing	Speed P	245	3xD	0.1xD	0.050	0.075	0.100	0.125	0.150	0.200	0.250	0.250
	Finishing	Speed P	255	3xD	0.01xD	0.020	0.030	0.040	0.050	0.060	0.080	0.100	0.100
K1.3.1 Malleable cast iron, ferritic, 130 HB K1.3.2 Malleable cast iron, pearlitic, 230 HB	HPC Roughing	Speed P	195	3xD	0.15xD	0.035	0.055	0.075	0.090	0.110	0.145	0.180	0.180
	HSC Roughing	Speed P	205	3xD	0.1xD	0.045	0.065	0.090	0.110	0.130	0.175	0.220	0.220
	Finishing	Speed P	215	3xD	0.01xD	0.020	0.025	0.035	0.045	0.055	0.070	0.090	0.090
K2.1.1 Vermicular graphite cast iron (GJV) K2.2.1 Austenitic-ferritic spheroidal graphite cast iron (ADI)	HPC Roughing	Speed P	175	3xD	0.15xD	0.030	0.050	0.065	0.080	0.095	0.130	0.160	0.160
	HSC Roughing	Speed P	185	3xD	0.1xD	0.040	0.060	0.080	0.100	0.120	0.155	0.195	0.195
	Finishing	Speed P	190	3xD	0.01xD	0.015	0.025	0.030	0.040	0.050	0.065	0.080	0.080
N1.1.1 Wrought aluminium alloys, non-hardened, 60 HB N1.1.2 Wrought aluminium alloys, hardened, 100 HB	HPC Roughing	5 Speed	690	3xD	0.2xD	0.045	0.065	0.090	0.110	0.130	0.175	0.220	0.220
	HSC Roughing	5 Speed	730	3xD	0.15xD	0.050	0.080	0.105	0.130	0.155	0.210	0.260	0.260
	Finishing	5 Speed	800	3xD	0.02xD	0.030	0.040	0.055	0.070	0.085	0.115	0.140	0.140
N2.1.1 Aluminium casting alloys, non-hardened, ≤ 12 % Si, 75 HB N2.1.2 Aluminium casting alloys, hardened, ≤ 12 % Si, 90 HB	HPC Roughing	5 Speed	315	3xD	0.2xD	0.035	0.050	0.065	0.080	0.100	0.130	0.165	0.165
	HSC Roughing	5 Speed	335	3xD	0.15xD	0.040	0.060	0.080	0.095	0.115	0.155	0.195	0.195
	Finishing	5 Speed	370	3xD	0.02xD	0.020	0.030	0.040	0.055	0.065	0.085	0.105	0.105
N2.1.3 Aluminium casting alloys, non-hardened, > 12 % Si, 130 HB	HPC Roughing	5 Speed	250	3xD	0.2xD	0.035	0.050	0.065	0.080	0.100	0.130	0.165	0.165
	HSC Roughing	5 Speed	265	3xD	0.15xD	0.040	0.060	0.080	0.095	0.115	0.155	0.195	0.195
	Finishing	5 Speed	290	3xD	0.02xD	0.020	0.030	0.040	0.055	0.065	0.085	0.105	0.105



Machining group	Application	Type	V _c (m/min)	a _p max.	a _e max.	f _z (mm/z) with nom. Ø							
						4	5	6	8	10	12	16	20
N3.1.1 Copper and copper alloys: Free-machining alloy, Pb > 1 % N3.1.2 Copper and copper alloys: CuZn, CuSnZn	HPC Roughing	5 Speed	345	3xD	0.2xD	0.035	0.050	0.065	0.080	0.100	0.130	0.165	0.165
	HSC Roughing	5 Speed	365	3xD	0.15xD	0.040	0.060	0.080	0.095	0.115	0.155	0.195	0.195
	Finishing	5 Speed	400	3xD	0.02xD	0.020	0.030	0.040	0.055	0.065	0.085	0.105	0.105
N3.1.3 Copper and copper alloys: CuSn, lead-free copper and copper electrolyte	HPC Roughing	5 Speed	270	3xD	0.2xD	0.030	0.045	0.060	0.075	0.090	0.120	0.150	0.150
	HSC Roughing	5 Speed	285	3xD	0.15xD	0.035	0.055	0.070	0.090	0.110	0.145	0.180	0.180
	Finishing	5 Speed	315	3xD	0.02xD	0.020	0.030	0.040	0.050	0.060	0.080	0.095	0.095
N4.1.1 Non-metallic materials: Duroplastics, fibre-reinforced plastics													
N4.1.2 Non-metallic materials: Hard rubber, wood, etc.													
N4.1.3 Non-metallic materials: Graphite													
S1.1.1 Heat-resistant alloys, Fe-based, annealed, 200 HB	HPC Roughing	7 Speed	50	3xD	0.08xD	0.035	0.050	0.070	0.085	0.105	0.135	0.170	0.170
	HSC Roughing	7 Speed	50	3xD	0.05xD	0.035	0.050	0.070	0.085	0.105	0.135	0.170	0.170
	Finishing	7 Speed	50	3xD	0.01xD	0.015	0.020	0.025	0.030	0.040	0.050	0.065	0.065
S1.1.2 Heat-resistant alloys, Fe-based, hardened, 280 HB	HPC Roughing	7 Speed	40	3xD	0.08xD	0.035	0.050	0.070	0.085	0.105	0.135	0.170	0.170
	HSC Roughing	7 Speed	45	3xD	0.05xD	0.035	0.050	0.070	0.085	0.105	0.135	0.170	0.170
	Finishing	7 Speed	40	3xD	0.01xD	0.015	0.020	0.025	0.030	0.040	0.050	0.065	0.065
S1.1.3 Heat-resistant alloys, Ni- or Co-based, annealed, 250 HB	HPC Roughing	7 Speed	30	3xD	0.08xD	0.030	0.040	0.055	0.070	0.085	0.110	0.140	0.140
	HSC Roughing	7 Speed	30	3xD	0.05xD	0.030	0.040	0.055	0.070	0.085	0.110	0.140	0.140
	Finishing	7 Speed	30	3xD	0.01xD	0.010	0.015	0.020	0.025	0.030	0.040	0.050	0.050
S1.1.4 Heat-resistant alloys, Ni- or Co-based, hardened, 350 HB	HPC Roughing	7 Speed	20	3xD	0.08xD	0.025	0.040	0.055	0.065	0.080	0.105	0.130	0.130
	HSC Roughing	7 Speed	20	3xD	0.05xD	0.025	0.040	0.055	0.065	0.080	0.105	0.130	0.130
	Finishing	7 Speed	20	3xD	0.01xD	0.010	0.015	0.020	0.025	0.030	0.040	0.050	0.050
S1.1.5 Heat-resistant alloys, Ni- or Co-based, cast, 320 HB	HPC Roughing	7 Speed	25	3xD	0.08xD	0.030	0.040	0.055	0.070	0.085	0.110	0.140	0.140
	HSC Roughing	7 Speed	25	3xD	0.05xD	0.030	0.040	0.055	0.070	0.085	0.110	0.140	0.140
	Finishing	7 Speed	25	3xD	0.01xD	0.010	0.015	0.020	0.025	0.030	0.040	0.050	0.050
S2.1.1 Titanium alloys, pure titanium, Rm 400 N/mm ²	HPC Roughing	7 Speed	115	3xD	0.08xD	0.045	0.065	0.085	0.105	0.130	0.170	0.215	0.215
	HSC Roughing	7 Speed	120	3xD	0.05xD	0.045	0.065	0.085	0.105	0.130	0.170	0.215	0.215
	Finishing	7 Speed	115	3xD	0.01xD	0.015	0.025	0.030	0.040	0.050	0.065	0.080	0.080
S2.1.2 Titanium alloys, Alpha and Beta alloys, hardened, Rm 1050 N/mm ²	HPC Roughing	7 Speed	95	3xD	0.08xD	0.040	0.060	0.075	0.095	0.115	0.155	0.190	0.190
	HSC Roughing	7 Speed	100	3xD	0.05xD	0.040	0.060	0.075	0.095	0.115	0.155	0.190	0.190
	Finishing	7 Speed	95	3xD	0.01xD	0.015	0.020	0.030	0.035	0.045	0.060	0.070	0.070
H1.1.1 Hardened steel, hardened and tempered, < 55 HRC	Roughing	Speed P	120	1xD	0.05xD	0.035	0.050	0.070	0.085	0.105	0.135	0.170	0.170
	Finishing	Speed P	110	1xD	0.01xD	0.015	0.020	0.025	0.030	0.040	0.050	0.065	0.065
H1.1.2 Hardened steel, hardened and tempered, < 60 HRC													
H1.1.3 Hardened steel, hardened and tempered, > 60 HRC													
H2.1.1 Chilled cast iron, 400 HB	Roughing	Speed P	155	1xD	0.1xD	0.030	0.045	0.065	0.080	0.095	0.125	0.155	0.155
	Finishing	Speed P	160	1xD	0.01xD	0.015	0.020	0.025	0.030	0.040	0.050	0.065	0.065
H2.1.2 Chilled cast iron, hardened and tempered, < 55 HRC	Roughing	Speed P	120	1xD	0.5xD	0.030	0.045	0.060	0.075	0.090	0.120	0.150	0.150
	Finishing	Speed P	115	1xD	0.01xD	0.010	0.015	0.025	0.030	0.035	0.045	0.055	0.055

Cutting data



RF 100 Sharp

Milling conditions:

HPC	stable machining conditions high drive power
MTC	unstable machining conditions low drive power
	long tools

Correction factors:

	a_p roughing > 1.5xD	v_c -25 %	f_z -25 %
	medium length tools	v_c -40 %	f_z -40 %

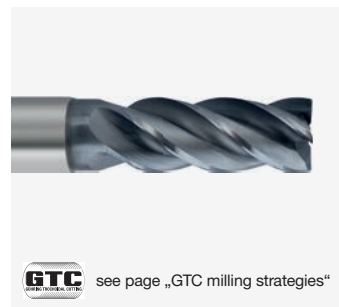

Cutting data

Machining group	Application	v_c (m/min)	a_e max.	f_z (mm/z) with nom. \emptyset								
				1	3	4	6	8	10	12	16	20
P1.1.1 Unalloyed steel, annealed, 0.15 % C, Rm 420 N/mm ² , 125 HB P1.1.2 Unalloyed steel, heat-treated, 0.15 % C, Rm 420 N/mm ² , 125 HB P1.1.3 Unalloyed steel, annealed, 0.45 % C, Rm 640 N/mm ² , 190 HB P1.1.4 Unalloyed steel, heat-treated, 0.45 % C, Rm 640 N/mm ² , 190 HB P1.1.5 Unalloyed steel, heat-treated, 0.45 % C, Rm 850 N/mm ² , 250 HB P1.1.6 Unalloyed steel, annealed, 0.75 % C, Rm 915 N/mm ² , 270 HB P1.1.7 Unalloyed steel, heat-treated, 0.75 % C, Rm 1020 N/mm ² , 300 HB	Slotting	180	1xD	0.005	0.016	0.020	0.030	0.040	0.060	0.070	0.095	0.120
	Roughing	205	0.75xD	0.007	0.021	0.030	0.040	0.055	0.070	0.085	0.110	0.140
	Finishing	360	0.02xD	0.007	0.020	0.025	0.040	0.055	0.065	0.080	0.105	0.130
P2.1.1 Low-alloy steel, annealed, Rm 610 N/mm ² , 180 HB P2.1.2 Low-alloy steel, heat-treated, Rm 930 N/mm ² , 275 HB P2.1.3 Low-alloy steel, heat-treated, Rm 1020 N/mm ² , 300 HB P2.1.4 Low-alloy steel, heat-treated, Rm 1190 N/mm ² , 350 HB	Slotting	160	1xD	0.005	0.015	0.020	0.030	0.040	0.055	0.065	0.090	0.110
	Roughing	185	0.75xD	0.006	0.019	0.025	0.040	0.050	0.065	0.075	0.100	0.125
	Finishing	320	0.02xD	0.006	0.018	0.025	0.035	0.050	0.060	0.075	0.095	0.120
P3.1.1 High-alloy steel and tool steel, annealed, Rm 680 N/mm ² , 200 HB P3.1.2 High-alloy steel and tool steel, hardened and tempered, Rm 1100 N/mm ² , 325 HB	Slotting	135	1xD	0.004	0.013	0.020	0.025	0.035	0.050	0.060	0.080	0.100
	Roughing	155	0.75xD	0.006	0.017	0.025	0.035	0.045	0.060	0.070	0.090	0.115
	Finishing	270	0.02xD	0.006	0.017	0.020	0.035	0.045	0.055	0.065	0.090	0.110
M1.1.1 Stainless steel, ferritic/martensitic, with machining additives M1.1.2 Stainless steel, ferritic/martensitic, annealed, Rm 680 N/mm ² , 200 HB	Slotting	120	1xD	0.004	0.013	0.020	0.025	0.035	0.050	0.060	0.080	0.100
	Roughing	140	0.75xD	0.006	0.017	0.025	0.035	0.045	0.060	0.070	0.090	0.115
	Finishing	240	0.02xD	0.006	0.017	0.020	0.035	0.045	0.055	0.065	0.090	0.110
M1.1.3 Stainless steel, ferritic/martensitic, heat-treated, Rm 810 N/mm ² , 240 HB	Slotting	90	1xD	0.004	0.012	0.015	0.025	0.030	0.045	0.055	0.070	0.090
	Roughing	100	0.75xD	0.005	0.016	0.020	0.030	0.040	0.050	0.060	0.085	0.105
	Finishing	175	0.02xD	0.005	0.015	0.020	0.030	0.040	0.050	0.060	0.080	0.100
M2.1.1 Stainless steel, austenitic, quenched, 180 HB	Slotting	80	1xD	0.004	0.012	0.015	0.025	0.030	0.045	0.055	0.070	0.090
	Roughing	100	0.6xD	0.005	0.016	0.020	0.030	0.045	0.055	0.065	0.085	0.110
	Finishing	160	0.01xD	0.005	0.014	0.020	0.025	0.035	0.045	0.055	0.070	0.090
M2.2.1 Duplex steel, high-strength stainless steels	Slotting	60	1xD	0.003	0.010	0.015	0.020	0.030	0.040	0.045	0.065	0.080
	Roughing	75	0.6xD	0.005	0.014	0.020	0.030	0.040	0.045	0.055	0.075	0.095
	Finishing	120	0.01xD	0.004	0.012	0.015	0.025	0.030	0.040	0.045	0.065	0.080
K1.1.1 Grey cast iron, pearlitic/ferritic, 180 HB K1.1.2 Grey cast iron, pearlitic/martensitic, 260 HB K1.2.1 Cast iron with spheroidal graphite, ferritic, 160 HB K1.2.2 Cast iron with spheroidal graphite, pearlitic, 250 HB												
K1.3.1 Malleable cast iron, ferritic, 130 HB K1.3.2 Malleable cast iron, pearlitic, 230 HB												
K2.1.1 Vermicular graphite cast iron (GJV) K2.2.1 Austenitic-ferritic spheroidal graphite cast iron (ADI)												
N1.1.1 Wrought aluminium alloys, non-hardened, 60 HB N1.1.2 Wrought aluminium alloys, hardened, 100 HB	Slotting	500	1xD	0.007	0.021	0.030	0.040	0.055	0.080	0.095	0.130	0.160
	Roughing	575	0.75xD	0.009	0.028	0.035	0.055	0.075	0.090	0.110	0.145	0.185
	Finishing	1000	0.02xD	0.009	0.026	0.035	0.055	0.070	0.090	0.105	0.140	0.175
N2.1.1 Aluminium casting alloys, non-hardened, \leq 12 % Si, 75 HB N2.1.2 Aluminium casting alloys, hardened, \leq 12 % Si, 90 HB	Slotting	230	1xD	0.005	0.016	0.020	0.030	0.040	0.060	0.070	0.095	0.120
	Roughing	265	0.75xD	0.007	0.021	0.030	0.040	0.055	0.070	0.085	0.110	0.140
	Finishing	460	0.02xD	0.007	0.020	0.025	0.040	0.055	0.065	0.080	0.105	0.130
N2.1.3 Aluminium casting alloys, non-hardened, > 12 % Si, 130 HB	Slotting	180	1xD	0.005	0.016	0.020	0.030	0.040	0.060	0.070	0.095	0.120
	Roughing	180	0.75xD	0.006	0.018	0.025	0.035	0.050	0.060	0.070	0.095	0.120
	Finishing	365	0.02xD	0.007	0.020	0.025	0.040	0.055	0.065	0.080	0.105	0.130



Machining group	Application	V _c (m/min)	a _e max.	f _z (mm/z) with nom. Ø								
				1	3	4	6	8	10	12	16	20
N3.1.1 Copper and copper alloys: Free-machining alloy, Pb > 1 % N3.1.2 Copper and copper alloys: CuZn, CuSnZn	Slotting	250	1xD	0.005	0.016	0.020	0.030	0.040	0.060	0.070	0.095	0.120
	Roughing	290	0.75xD	0.007	0.021	0.030	0.040	0.055	0.070	0.085	0.110	0.140
	Finishing	500	0.02xD	0.007	0.020	0.025	0.040	0.055	0.065	0.080	0.105	0.130
N3.1.3 Copper and copper alloys: CuSn, lead-free copper and copper electrolyte	Slotting	195	1xD	0.005	0.015	0.020	0.030	0.040	0.055	0.065	0.090	0.110
	Roughing	225	0.75xD	0.006	0.019	0.025	0.040	0.050	0.065	0.075	0.100	0.125
	Finishing	390	0.02xD	0.006	0.018	0.025	0.035	0.050	0.060	0.075	0.095	0.120
N4.1.1 Non-metallic materials: Duroplastics, fibre-reinforced plastics	Slotting	150	1xD	0.006	0.017	0.020	0.035	0.045	0.065	0.075	0.100	0.125
	Roughing	175	0.75xD	0.007	0.022	0.030	0.045	0.060	0.070	0.085	0.115	0.145
	Finishing	300	0.02xD	0.007	0.021	0.030	0.040	0.055	0.070	0.085	0.110	0.140
N4.1.2 Non-metallic materials: Hard rubber, wood, etc.	Slotting	200	1xD	0.005	0.015	0.020	0.030	0.040	0.055	0.065	0.090	0.110
	Roughing	230	0.75xD	0.006	0.019	0.025	0.040	0.050	0.065	0.075	0.105	0.130
	Finishing	400	0.02xD	0.006	0.019	0.025	0.035	0.050	0.060	0.075	0.100	0.125
N4.1.3 Non-metallic materials: Graphite	Slotting	240	1xD	0.007	0.021	0.030	0.040	0.055	0.080	0.095	0.130	0.160
	Roughing	275	0.75xD	0.009	0.028	0.035	0.055	0.075	0.090	0.110	0.145	0.185
	Finishing	480	0.02xD	0.009	0.026	0.035	0.055	0.070	0.090	0.105	0.140	0.175
S1.1.1 Heat-resistant alloys, Fe-based, annealed, 200 HB	Slotting	30	1xD	0.004	0.011	0.015	0.020	0.030	0.040	0.050	0.065	0.080
	Roughing	40	0.6xD	0.005	0.014	0.020	0.030	0.040	0.050	0.060	0.075	0.095
	Finishing	60	0.01xD	0.004	0.012	0.015	0.025	0.030	0.040	0.050	0.065	0.080
S1.1.2 Heat-resistant alloys, Fe-based, hardened, 280 HB	Slotting	25	1xD	0.004	0.011	0.015	0.020	0.030	0.040	0.050	0.065	0.080
	Roughing	30	0.6xD	0.005	0.014	0.020	0.030	0.040	0.050	0.060	0.075	0.095
	Finishing	50	0.01xD	0.004	0.012	0.015	0.025	0.030	0.040	0.050	0.065	0.080
S1.1.3 Heat-resistant alloys, Ni- or Co-based, annealed, 250 HB	Slotting	15	1xD	0.003	0.009	0.010	0.015	0.025	0.030	0.040	0.050	0.065
	Roughing	20	0.6xD	0.004	0.012	0.015	0.025	0.030	0.040	0.045	0.060	0.080
	Finishing	35	0.01xD	0.003	0.010	0.015	0.020	0.025	0.030	0.040	0.050	0.065
S1.1.4 Heat-resistant alloys, Ni- or Co-based, hardened, 350 HB	Slotting	15	1xD	0.003	0.008	0.010	0.015	0.020	0.030	0.035	0.050	0.060
	Roughing	15	0.6xD	0.004	0.011	0.015	0.020	0.030	0.035	0.045	0.060	0.075
	Finishing	25	0.01xD	0.003	0.009	0.010	0.020	0.025	0.030	0.035	0.050	0.060
S1.1.5 Heat-resistant alloys, Ni- or Co-based, cast, 320 HB	Slotting	15	1xD	0.003	0.009	0.010	0.015	0.025	0.030	0.040	0.050	0.065
	Roughing	20	0.6xD	0.004	0.012	0.015	0.025	0.030	0.040	0.045	0.060	0.080
	Finishing	30	0.01xD	0.003	0.010	0.015	0.020	0.025	0.030	0.040	0.050	0.065
S2.1.1 Titanium alloys, pure titanium, Rm 400 N/mm ²	Slotting	70	1xD	0.004	0.013	0.020	0.025	0.035	0.050	0.060	0.080	0.100
	Roughing	90	0.6xD	0.006	0.018	0.025	0.035	0.050	0.060	0.070	0.095	0.120
	Finishing	140	0.02xD	0.006	0.017	0.020	0.035	0.045	0.055	0.065	0.090	0.110
S2.1.2 Titanium alloys, Alpha and Beta alloys, hardened, Rm 1050 N/mm ²	Slotting	60	1xD	0.004	0.012	0.015	0.025	0.030	0.045	0.055	0.070	0.090
	Roughing	75	0.6xD	0.005	0.016	0.020	0.030	0.045	0.055	0.065	0.085	0.110
	Finishing	120	0.02xD	0.005	0.015	0.020	0.030	0.040	0.050	0.060	0.080	0.100
H1.1.1 Hardened steel, hardened and tempered, < 55 HRC												
H1.1.2 Hardened steel, hardened and tempered, < 60 HRC												
H1.1.3 Hardened steel, hardened and tempered, > 60 HRC												
H2.1.1 Chilled cast iron, 400 HB												
H2.1.2 Chilled cast iron, hardened and tempered, < 55 HRC												



RF 100 for stable conditions, G-Mold 65 U

Milling conditions:

HPC	stable machining conditions high drive power
	short tools
	long tools

Correction factors:

	a_p roughing > 1.5xD	v_c -25 %	f_z -25 %
	medium length tools	v_c -40 %	f_z -40 %
	extra length tools	v_c -60 %	f_z -55 %

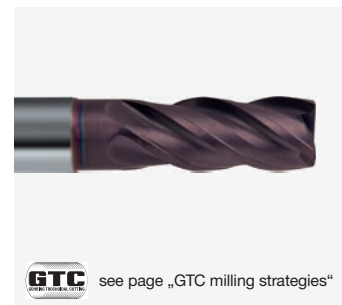

GTC see page „GTC milling strategies“

Cutting data

Machining group	Application	v_c (m/min)	a_e max.	f_z (mm/z) with nom. Ø								
				3	4	6	8	10	12	16	20	25
P1.1.1 Unalloyed steel, annealed, 0.15 % C, Rm 420 N/mm ² , 125 HB P1.1.2 Unalloyed steel, heat-treated, 0.15 % C, Rm 420 N/mm ² , 125 HB P1.1.3 Unalloyed steel, annealed, 0.45 % C, Rm 640 N/mm ² , 190 HB P1.1.4 Unalloyed steel, heat-treated, 0.45 % C, Rm 640 N/mm ² , 190 HB P1.1.5 Unalloyed steel, heat-treated, 0.45 % C, Rm 850 N/mm ² , 250 HB P1.1.6 Unalloyed steel, annealed, 0.75 % C, Rm 915 N/mm ² , 270 HB P1.1.7 Unalloyed steel, heat-treated, 0.75 % C, Rm 1020 N/mm ² , 300 HB	Slotting	180	1xD	0.016	0.020	0.030	0.040	0.060	0.070	0.095	0.120	0.150
	Roughing	205	0.75xD	0.021	0.030	0.040	0.055	0.070	0.085	0.110	0.140	0.175
	Finishing	360	0.02xD	0.020	0.025	0.040	0.055	0.065	0.080	0.105	0.130	0.165
P2.1.1 Low-alloy steel, annealed, Rm 610 N/mm ² , 180 HB P2.1.2 Low-alloy steel, heat-treated, Rm 930 N/mm ² , 275 HB P2.1.3 Low-alloy steel, heat-treated, Rm 1020 N/mm ² , 300 HB P2.1.4 Low-alloy steel, heat-treated, Rm 1190 N/mm ² , 350 HB	Slotting	160	1xD	0.015	0.020	0.030	0.040	0.055	0.065	0.090	0.110	0.140
	Roughing	185	0.75xD	0.019	0.025	0.040	0.050	0.065	0.075	0.100	0.125	0.160
	Finishing	320	0.02xD	0.018	0.025	0.035	0.050	0.060	0.075	0.095	0.120	0.150
P3.1.1 High-alloy steel and tool steel, annealed, Rm 680 N/mm ² , 200 HB P3.1.2 High-alloy steel and tool steel, hardened and tempered, Rm 1100 N/mm ² , 325 HB	Slotting	135	1xD	0.013	0.020	0.025	0.035	0.050	0.060	0.080	0.100	0.125
	Roughing	155	0.75xD	0.017	0.025	0.035	0.045	0.060	0.070	0.090	0.115	0.145
	Finishing	270	0.02xD	0.017	0.020	0.035	0.045	0.055	0.065	0.090	0.110	0.140
M1.1.1 Stainless steel, ferritic/martensitic, with machining additives M1.1.2 Stainless steel, ferritic/martensitic, annealed, Rm 680 N/mm ² , 200 HB	Slotting	120	1xD	0.013	0.020	0.025	0.035	0.050	0.060	0.080	0.100	0.125
	Roughing	140	0.75xD	0.017	0.025	0.035	0.045	0.060	0.070	0.090	0.115	0.145
	Finishing	240	0.02xD	0.017	0.020	0.035	0.045	0.055	0.065	0.090	0.110	0.140
M1.1.3 Stainless steel, ferritic/martensitic, heat-treated, Rm 810 N/mm ² , 240 HB	Slotting	90	1xD	0.012	0.015	0.025	0.030	0.045	0.055	0.070	0.090	0.115
	Roughing	100	0.75xD	0.016	0.020	0.030	0.040	0.050	0.060	0.085	0.105	0.130
	Finishing	175	0.02xD	0.015	0.020	0.030	0.040	0.050	0.060	0.080	0.100	0.125
M2.1.1 Stainless steel, austenitic, quenched, 180 HB	Slotting	80	1xD	0.012	0.015	0.025	0.030	0.045	0.055	0.070	0.090	0.115
	Roughing	100	0.6xD	0.016	0.020	0.030	0.045	0.055	0.065	0.085	0.110	0.135
	Finishing	160	0.01xD	0.014	0.020	0.025	0.035	0.045	0.055	0.070	0.090	0.115
M2.2.1 Duplex steel, high-strength stainless steels	Slotting	60	1xD	0.010	0.015	0.020	0.030	0.040	0.045	0.065	0.080	0.100
	Roughing	75	0.6xD	0.014	0.020	0.030	0.040	0.045	0.055	0.075	0.095	0.120
	Finishing	120	0.01xD	0.012	0.015	0.025	0.030	0.040	0.045	0.065	0.080	0.100
K1.1.1 Grey cast iron, pearlitic/ferritic, 180 HB K1.1.2 Grey cast iron, pearlitic/martensitic, 260 HB K1.2.1 Cast iron with spheroidal graphite, ferritic, 160 HB K1.2.2 Cast iron with spheroidal graphite, pearlitic, 250 HB	Slotting	160	1xD	0.017	0.020	0.035	0.045	0.065	0.075	0.100	0.125	0.160
	Roughing	185	0.75xD	0.022	0.030	0.045	0.060	0.070	0.085	0.115	0.145	0.180
	Finishing	320	0.02xD	0.021	0.030	0.040	0.055	0.070	0.085	0.110	0.140	0.175
K1.3.1 Malleable cast iron, ferritic, 130 HB K1.3.2 Malleable cast iron, pearlitic, 230 HB	Slotting	135	1xD	0.015	0.020	0.030	0.040	0.055	0.065	0.090	0.110	0.140
	Roughing	135	0.75xD	0.017	0.020	0.035	0.045	0.055	0.065	0.090	0.110	0.140
	Finishing	270	0.02xD	0.018	0.025	0.035	0.050	0.060	0.075	0.100	0.125	0.155
K2.1.1 Vermicular graphite cast iron (GJV) K2.2.1 Austenitic-ferritic spheroidal graphite cast iron (ADI)	Slotting	120	1xD	0.013	0.020	0.025	0.035	0.050	0.060	0.080	0.100	0.125
	Roughing	120	0.75xD	0.015	0.020	0.030	0.040	0.050	0.060	0.080	0.100	0.125
	Finishing	240	0.02xD	0.017	0.020	0.035	0.045	0.055	0.065	0.090	0.110	0.140
N1.1.1 Wrought aluminium alloys, non-hardened, 60 HB N1.1.2 Wrought aluminium alloys, hardened, 100 HB	Slotting	500	1xD	0.021	0.030	0.040	0.055	0.080	0.095	0.130	0.160	0.200
	Roughing	575	0.75xD	0.028	0.035	0.055	0.075	0.090	0.110	0.145	0.185	0.230
	Finishing	1000	0.02xD	0.026	0.035	0.055	0.070	0.090	0.105	0.140	0.175	0.220
N2.1.1 Aluminium casting alloys, non-hardened, ≤ 12 % Si, 75 HB N2.1.2 Aluminium casting alloys, hardened, ≤ 12 % Si, 90 HB	Slotting	230	1xD	0.016	0.020	0.030	0.040	0.060	0.070	0.095	0.120	0.150
	Roughing	265	0.75xD	0.021	0.030	0.040	0.055	0.070	0.085	0.110	0.140	0.175
	Finishing	460	0.02xD	0.020	0.025	0.040	0.055	0.065	0.080	0.105	0.130	0.165
N2.1.3 Aluminium casting alloys, non-hardened, > 12 % Si, 130 HB	Slotting	180	1xD	0.016	0.020	0.030	0.040	0.060	0.070	0.095	0.120	0.150
	Roughing	180	0.75xD	0.018	0.025	0.035	0.050	0.060	0.070	0.095	0.120	0.150
	Finishing	365	0.02xD	0.020	0.025	0.040	0.055	0.065	0.080	0.105	0.130	0.165



Machining group	Application	V _c (m/min)	a _e max.	f _z (mm/z) with nom. Ø								
				3	4	6	8	10	12	16	20	25
N3.1.1 Copper and copper alloys: Free-machining alloy, Pb > 1 % N3.1.2 Copper and copper alloys: CuZn, CuSnZn	Slotting	250	1xD	0.016	0.020	0.030	0.040	0.060	0.070	0.095	0.120	0.150
	Roughing	290	0.75xD	0.021	0.030	0.040	0.055	0.070	0.085	0.110	0.140	0.175
	Finishing	500	0.02xD	0.020	0.025	0.040	0.055	0.065	0.080	0.105	0.130	0.165
N3.1.3 Copper and copper alloys: CuSn, lead-free copper and copper electrolyte	Slotting	195	1xD	0.015	0.020	0.030	0.040	0.055	0.065	0.090	0.110	0.140
	Roughing	225	0.75xD	0.019	0.025	0.040	0.050	0.065	0.075	0.100	0.125	0.160
	Finishing	390	0.02xD	0.018	0.025	0.035	0.050	0.060	0.075	0.095	0.120	0.150
N4.1.1 Non-metallic materials: Duroplastics, fibre-reinforced plastics	Slotting	150	1xD	0.017	0.020	0.035	0.045	0.065	0.075	0.100	0.125	0.155
	Roughing	175	0.75xD	0.022	0.030	0.045	0.060	0.070	0.085	0.115	0.145	0.180
	Finishing	300	0.02xD	0.021	0.030	0.040	0.055	0.070	0.085	0.110	0.140	0.170
N4.1.2 Non-metallic materials: Hard rubber, wood, etc.	Slotting	200	1xD	0.015	0.020	0.030	0.040	0.055	0.065	0.090	0.110	0.140
	Roughing	230	0.75xD	0.019	0.025	0.040	0.050	0.065	0.075	0.105	0.130	0.160
	Finishing	400	0.02xD	0.019	0.025	0.035	0.050	0.060	0.075	0.100	0.125	0.155
N4.1.3 Non-metallic materials: Graphite	Slotting	240	1xD	0.021	0.030	0.040	0.055	0.080	0.095	0.130	0.160	0.200
	Roughing	275	0.75xD	0.028	0.035	0.055	0.075	0.090	0.110	0.145	0.185	0.230
	Finishing	480	0.02xD	0.026	0.035	0.055	0.070	0.090	0.105	0.140	0.175	0.220
S1.1.1 Heat-resistant alloys, Fe-based, annealed, 200 HB	Slotting	30	1xD	0.011	0.015	0.020	0.030	0.040	0.050	0.065	0.080	0.100
	Roughing	40	0.6xD	0.014	0.020	0.030	0.040	0.050	0.060	0.075	0.095	0.120
	Finishing	60	0.01xD	0.012	0.015	0.025	0.030	0.040	0.050	0.065	0.080	0.100
S1.1.2 Heat-resistant alloys, Fe-based, hardened, 280 HB	Slotting	25	1xD	0.011	0.015	0.020	0.030	0.040	0.050	0.065	0.080	0.100
	Roughing	30	0.6xD	0.014	0.020	0.030	0.040	0.050	0.060	0.075	0.095	0.120
	Finishing	50	0.01xD	0.012	0.015	0.025	0.030	0.040	0.050	0.065	0.080	0.100
S1.1.3 Heat-resistant alloys, Ni- or Co-based, annealed, 250 HB	Slotting	15	1xD	0.009	0.010	0.015	0.025	0.030	0.040	0.050	0.065	0.080
	Roughing	20	0.6xD	0.012	0.015	0.025	0.030	0.040	0.045	0.060	0.080	0.095
	Finishing	35	0.01xD	0.010	0.015	0.020	0.025	0.030	0.040	0.050	0.065	0.080
S1.1.4 Heat-resistant alloys, Ni- or Co-based, hardened, 350 HB	Slotting	15	1xD	0.008	0.010	0.015	0.020	0.030	0.035	0.050	0.060	0.075
	Roughing	15	0.6xD	0.011	0.015	0.020	0.030	0.035	0.045	0.060	0.075	0.090
	Finishing	25	0.01xD	0.009	0.010	0.020	0.025	0.030	0.035	0.050	0.060	0.075
S1.1.5 Heat-resistant alloys, Ni- or Co-based, cast, 320 HB	Slotting	15	1xD	0.009	0.010	0.015	0.025	0.030	0.040	0.050	0.065	0.080
	Roughing	20	0.6xD	0.012	0.015	0.025	0.030	0.040	0.045	0.060	0.080	0.095
	Finishing	30	0.01xD	0.010	0.015	0.020	0.025	0.030	0.040	0.050	0.065	0.080
S2.1.1 Titanium alloys, pure titanium, Rm 400 N/mm ²	Slotting	70	1xD	0.013	0.020	0.025	0.035	0.050	0.060	0.080	0.100	0.125
	Roughing	90	0.6xD	0.018	0.025	0.035	0.050	0.060	0.070	0.095	0.120	0.150
	Finishing	140	0.02xD	0.017	0.020	0.035	0.045	0.055	0.065	0.090	0.110	0.140
S2.1.2 Titanium alloys, Alpha and Beta alloys, hardened, Rm 1050 N/mm ²	Slotting	60	1xD	0.012	0.015	0.025	0.030	0.045	0.055	0.070	0.090	0.110
	Roughing	75	0.6xD	0.016	0.020	0.030	0.045	0.055	0.065	0.085	0.110	0.135
	Finishing	120	0.02xD	0.015	0.020	0.030	0.040	0.050	0.060	0.080	0.100	0.125
H1.1.1 Hardened steel, hardened and tempered, < 55 HRC	Slotting	70	1xD	0.011	0.015	0.020	0.030	0.040	0.050	0.065	0.080	0.100
	Roughing	105	0.33xD	0.016	0.020	0.030	0.040	0.050	0.060	0.085	0.105	0.130
	Finishing	140	0.01xD	0.012	0.015	0.025	0.030	0.040	0.050	0.065	0.080	0.100
H1.1.2 Hardened steel, hardened and tempered, < 60 HRC	Roughing	105	0.03xD	0.012	0.015	0.025	0.035	0.040	0.050	0.065	0.080	0.100
	Finishing	115	0.005xD	0.009	0.010	0.020	0.025	0.030	0.035	0.050	0.060	0.075
H1.1.3 Hardened steel, hardened and tempered, > 60 HRC	Roughing	85	0.03xD	0.011	0.015	0.020	0.030	0.035	0.045	0.060	0.070	0.090
	Finishing	90	0.005xD	0.008	0.010	0.015	0.020	0.025	0.030	0.045	0.055	0.070
H2.1.1 Chilled cast iron, 400 HB	Slotting	100	1xD	0.011	0.015	0.020	0.030	0.040	0.050	0.065	0.080	0.100
	Roughing	150	0.33xD	0.016	0.020	0.030	0.040	0.050	0.060	0.085	0.105	0.130
	Finishing	200	0.01xD	0.012	0.015	0.025	0.030	0.040	0.050	0.065	0.080	0.100
H2.1.2 Chilled cast iron, hardened and tempered, < 55 HRC	Slotting	70	1xD	0.009	0.015	0.020	0.025	0.035	0.045	0.055	0.070	0.090
	Roughing	105	0.33xD	0.014	0.020	0.030	0.035	0.045	0.055	0.075	0.090	0.115
	Finishing	145	0.01xD	0.011	0.015	0.020	0.030	0.035	0.045	0.055	0.070	0.090



RF 100 U/HF, VA/NF, A/WF, RS 100 U/F for unstable conditions

Milling conditions:

MTC unstable machining conditions
low drive power

long tools

Correction factors:

a_p roughing > 1.5xD v_c -25 % f_z -25 %

medium length tools v_c -40 % f_z -40 %

extra length tools v_c -60 % f_z -55 %

uncoated tools v_c -50 % f_z -25 %



Cutting data

Machining group	Application	v_c (m/min)	a_e max.	f_z (mm/z) with nom. \emptyset								
				3	4	6	8	10	12	16	20	25
P1.1.1 Unalloyed steel, annealed, 0.15 % C, Rm 420 N/mm ² , 125 HB P1.1.2 Unalloyed steel, heat-treated, 0.15 % C, Rm 420 N/mm ² , 125 HB P1.1.3 Unalloyed steel, annealed, 0.45 % C, Rm 640 N/mm ² , 190 HB P1.1.4 Unalloyed steel, heat-treated, 0.45 % C, Rm 640 N/mm ² , 190 HB P1.1.5 Unalloyed steel, heat-treated, 0.45 % C, Rm 850 N/mm ² , 250 HB P1.1.6 Unalloyed steel, annealed, 0.75 % C, Rm 915 N/mm ² , 270 HB P1.1.7 Unalloyed steel, heat-treated, 0.75 % C, Rm 1020 N/mm ² , 300 HB	Slotting	135	1xD	0.008	0.010	0.015	0.025	0.030	0.040	0.050	0.065	0.080
	Roughing	155	0.75xD	0.011	0.015	0.020	0.030	0.035	0.045	0.060	0.075	0.090
P2.1.1 Low-alloy steel, annealed, Rm 610 N/mm ² , 180 HB P2.1.2 Low-alloy steel, heat-treated, Rm 930 N/mm ² , 275 HB P2.1.3 Low-alloy steel, heat-treated, Rm 1020 N/mm ² , 300 HB P2.1.4 Low-alloy steel, heat-treated, Rm 1190 N/mm ² , 350 HB	Slotting	120	1xD	0.008	0.010	0.015	0.025	0.030	0.040	0.050	0.065	0.080
	Roughing	140	0.75xD	0.011	0.015	0.020	0.030	0.035	0.045	0.060	0.075	0.090
P3.1.1 High-alloy steel and tool steel, annealed, Rm 680 N/mm ² , 200 HB P3.1.2 High-alloy steel and tool steel, hardened and tempered, Rm 1100 N/mm ² , 325 HB	Slotting	100	1xD	0.008	0.010	0.015	0.020	0.030	0.035	0.050	0.060	0.075
	Roughing	115	0.75xD	0.010	0.015	0.020	0.030	0.035	0.040	0.055	0.070	0.085
M1.1.1 Stainless steel, ferritic/martensitic, with machining additives M1.1.2 Stainless steel, ferritic/martensitic, annealed, Rm 680 N/mm ² , 200 HB	Slotting	90	1xD	0.008	0.010	0.015	0.020	0.030	0.035	0.050	0.060	0.075
	Roughing	105	0.75xD	0.010	0.015	0.020	0.030	0.035	0.040	0.055	0.070	0.085
M1.1.3 Stainless steel, ferritic/martensitic, heat-treated, Rm 810 N/mm ² , 240 HB	Slotting	65	1xD	0.007	0.010	0.015	0.020	0.025	0.035	0.045	0.055	0.070
	Roughing	75	0.75xD	0.009	0.010	0.020	0.025	0.030	0.035	0.050	0.060	0.080
M2.1.1 Stainless steel, austenitic, quenched, 180 HB	Slotting	70	1xD	0.007	0.010	0.015	0.020	0.030	0.035	0.045	0.055	0.070
	Roughing	80	0.75xD	0.010	0.015	0.020	0.025	0.030	0.040	0.050	0.065	0.080
M2.2.1 Duplex steel, high-strength stainless steels	Slotting	50	1xD	0.006	0.010	0.015	0.015	0.025	0.030	0.040	0.050	0.060
	Roughing	65	0.6xD	0.009	0.010	0.020	0.025	0.030	0.035	0.045	0.060	0.075
K1.1.1 Grey cast iron, pearlitic/ferritic, 180 HB K1.1.2 Grey cast iron, pearlitic/martensitic, 260 HB K1.2.1 Cast iron with spheroidal graphite, ferritic, 160 HB K1.2.2 Cast iron with spheroidal graphite, pearlitic, 250 HB	Slotting	120	1xD	0.009	0.010	0.015	0.025	0.035	0.040	0.055	0.065	0.085
	Roughing	140	0.75xD	0.011	0.015	0.025	0.030	0.040	0.045	0.060	0.075	0.095
K1.3.1 Malleable cast iron, ferritic, 130 HB K1.3.2 Malleable cast iron, pearlitic, 230 HB	Slotting	100	1xD	0.008	0.010	0.015	0.020	0.030	0.035	0.045	0.060	0.075
	Roughing	100	0.75xD	0.009	0.010	0.020	0.025	0.030	0.035	0.045	0.060	0.075
K2.1.1 Vermicular graphite cast iron (GJV) K2.2.1 Austenitic-ferritic spheroidal graphite cast iron (ADI)	Slotting	90	1xD	0.007	0.010	0.015	0.020	0.025	0.030	0.045	0.055	0.070
	Roughing	90	0.75xD	0.008	0.010	0.015	0.020	0.025	0.030	0.045	0.055	0.070
N1.1.1 Wrought aluminium alloys, non-hardened, 60 HB N1.1.2 Wrought aluminium alloys, hardened, 100 HB	Slotting	375	1xD	0.010	0.015	0.020	0.025	0.035	0.045	0.060	0.075	0.095
	Roughing	430	0.75xD	0.013	0.015	0.025	0.035	0.045	0.050	0.070	0.085	0.105
N2.1.1 Aluminium casting alloys, non-hardened, \leq 12 % Si, 75 HB N2.1.2 Aluminium casting alloys, hardened, \leq 12 % Si, 90 HB	Slotting	200	1xD	0.009	0.010	0.020	0.025	0.035	0.040	0.055	0.070	0.090
	Roughing	230	0.75xD	0.012	0.015	0.025	0.030	0.040	0.050	0.065	0.080	0.100
N2.1.3 Aluminium casting alloys, non-hardened, > 12 % Si, 130 HB	Slotting	160	1xD	0.009	0.010	0.020	0.025	0.035	0.040	0.055	0.070	0.090
	Roughing	160	0.75xD	0.011	0.015	0.020	0.030	0.035	0.040	0.055	0.070	0.090



Machining group	Application	V _c (m/min)	a _e max.	f _z (mm/z) with nom. Ø								
				3	4	6	8	10	12	16	20	25
N3.1.1 Copper and copper alloys: Free-machining alloy, Pb > 1 % N3.1.2 Copper and copper alloys: CuZn, CuSnZn	Slotting	220	1xD	0.009	0.010	0.020	0.025	0.035	0.040	0.055	0.070	0.090
	Roughing	255	0.75xD	0.012	0.015	0.025	0.030	0.040	0.050	0.065	0.080	0.100
N3.1.3 Copper and copper alloys: CuSn, lead-free copper and copper electrolyte	Slotting	170	1xD	0.009	0.010	0.015	0.025	0.030	0.040	0.050	0.065	0.080
	Roughing	200	0.75xD	0.011	0.015	0.020	0.030	0.035	0.045	0.060	0.075	0.095
N4.1.1 Non-metallic materials: Duroplastics, fibre-reinforced plastics	Slotting	110	1xD	0.009	0.010	0.015	0.025	0.035	0.040	0.055	0.065	0.085
	Roughing	130	0.75xD	0.011	0.015	0.025	0.030	0.040	0.045	0.060	0.075	0.095
N4.1.2 Non-metallic materials: Hard rubber, wood, etc.	Slotting	150	1xD	0.008	0.010	0.015	0.020	0.030	0.035	0.045	0.060	0.075
	Roughing	170	0.75xD	0.010	0.015	0.020	0.025	0.035	0.040	0.055	0.070	0.085
N4.1.3 Non-metallic materials: Graphite	Slotting	180	1xD	0.011	0.015	0.020	0.030	0.040	0.050	0.065	0.085	0.105
	Roughing	205	0.75xD	0.015	0.020	0.030	0.040	0.050	0.060	0.080	0.095	0.120
S1.1.1 Heat-resistant alloys, Fe-based, annealed, 200 HB	Slotting	25	1xD	0.007	0.010	0.015	0.020	0.025	0.030	0.040	0.055	0.065
	Roughing	35	0.6xD	0.010	0.015	0.020	0.025	0.030	0.040	0.050	0.065	0.080
S1.1.2 Heat-resistant alloys, Fe-based, hardened, 280 HB	Slotting	20	1xD	0.007	0.010	0.015	0.020	0.025	0.030	0.040	0.055	0.065
	Roughing	30	0.6xD	0.010	0.015	0.020	0.025	0.030	0.040	0.050	0.065	0.080
S1.1.3 Heat-resistant alloys, Ni- or Co-based, annealed, 250 HB	Slotting	15	1xD	0.006	0.010	0.010	0.015	0.020	0.025	0.035	0.045	0.055
	Roughing	20	0.6xD	0.008	0.010	0.015	0.020	0.025	0.030	0.040	0.050	0.065
S1.1.4 Heat-resistant alloys, Ni- or Co-based, hardened, 350 HB	Slotting	10	1xD	0.005	0.005	0.010	0.015	0.020	0.025	0.035	0.040	0.050
	Roughing	15	0.6xD	0.007	0.010	0.015	0.020	0.025	0.030	0.040	0.050	0.060
S1.1.5 Heat-resistant alloys, Ni- or Co-based, cast, 320 HB	Slotting	15	1xD	0.006	0.010	0.010	0.015	0.020	0.025	0.035	0.045	0.055
	Roughing	15	0.6xD	0.008	0.010	0.015	0.020	0.025	0.030	0.040	0.050	0.065
S2.1.1 Titanium alloys, pure titanium, Rm 400 N/mm ²	Slotting	60	1xD	0.007	0.010	0.015	0.020	0.030	0.035	0.045	0.055	0.070
	Roughing	80	0.6xD	0.010	0.015	0.020	0.025	0.035	0.040	0.055	0.065	0.085
S2.1.2 Titanium alloys, Alpha and Beta alloys, hardened, Rm 1050 N/mm ²	Slotting	50	1xD	0.007	0.010	0.015	0.015	0.025	0.030	0.040	0.050	0.060
	Roughing	65	0.6xD	0.009	0.010	0.020	0.025	0.030	0.035	0.045	0.060	0.075
H1.1.1 Hardened steel, hardened and tempered, < 55 HRC	Slotting	55	1xD	0.006	0.010	0.010	0.015	0.025	0.030	0.035	0.045	0.060
	Roughing	85	0.33xD	0.009	0.010	0.020	0.025	0.030	0.035	0.050	0.060	0.075
H1.1.2 Hardened steel, hardened and tempered, < 60 HRC												
H1.1.3 Hardened steel, hardened and tempered, > 60 HRC												
H2.1.1 Chilled cast iron, 400 HB	Slotting	80	1xD	0.007	0.010	0.015	0.020	0.025	0.030	0.040	0.050	0.065
	Roughing	115	0.33xD	0.010	0.015	0.020	0.025	0.035	0.040	0.050	0.065	0.080
H2.1.2 Chilled cast iron, hardened and tempered, < 55 HRC	Slotting	55	1xD	0.006	0.010	0.010	0.015	0.020	0.025	0.035	0.045	0.055
	Roughing	85	0.33xD	0.009	0.010	0.015	0.025	0.030	0.035	0.045	0.060	0.070



GH 100 U, G-Mold 48 F, G-Mold 65 F

Milling conditions:

HPC	stable machining conditions high drive power
	short tools
	long tools

Correction factors:

	a_p roughing > 1.5xD	v_c -25 %	f_z -25 %
	medium length tools	v_c -40 %	f_z -40 %
	extra length tools	v_c -60 %	f_z -55 %
	uncoated tools	v_c -50 %	f_z -25 %

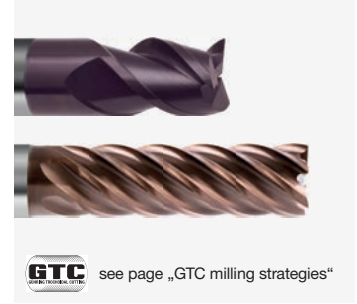

Cutting data

Machining group	Application	v_c (m/min)	a_e max.	f_z (mm/z) with nom. Ø								
				1	3	6	8	10	12	16	20	25
P1.1.1 Unalloyed steel, annealed, 0.15 % C, Rm 420 N/mm ² , 125 HB P1.1.2 Unalloyed steel, heat-treated, 0.15 % C, Rm 420 N/mm ² , 125 HB P1.1.3 Unalloyed steel, annealed, 0.45 % C, Rm 640 N/mm ² , 190 HB P1.1.4 Unalloyed steel, heat-treated, 0.45 % C, Rm 640 N/mm ² , 190 HB P1.1.5 Unalloyed steel, heat-treated, 0.45 % C, Rm 850 N/mm ² , 250 HB P1.1.6 Unalloyed steel, annealed, 0.75 % C, Rm 915 N/mm ² , 270 HB P1.1.7 Unalloyed steel, heat-treated, 0.75 % C, Rm 1020 N/mm ² , 300 HB	Slotting	120	1xD	0.004	0.012	0.025	0.030	0.045	0.055	0.070	0.090	0.115
	Roughing	140	0.75xD	0.005	0.016	0.030	0.040	0.050	0.060	0.085	0.105	0.130
	Finishing	240	0.02xD	0.005	0.015	0.030	0.040	0.050	0.060	0.080	0.100	0.125
P2.1.1 Low-alloy steel, annealed, Rm 610 N/mm ² , 180 HB P2.1.2 Low-alloy steel, heat-treated, Rm 930 N/mm ² , 275 HB P2.1.3 Low-alloy steel, heat-treated, Rm 1020 N/mm ² , 300 HB P2.1.4 Low-alloy steel, heat-treated, Rm 1190 N/mm ² , 350 HB	Slotting	105	1xD	0.004	0.012	0.025	0.030	0.045	0.055	0.070	0.090	0.115
	Roughing	120	0.75xD	0.005	0.016	0.030	0.040	0.050	0.060	0.085	0.105	0.130
	Finishing	210	0.02xD	0.005	0.015	0.030	0.040	0.050	0.060	0.080	0.100	0.125
P3.1.1 High-alloy steel and tool steel, annealed, Rm 680 N/mm ² , 200 HB P3.1.2 High-alloy steel and tool steel, hardened and tempered, Rm 1100 N/mm ² , 325 HB	Slotting	90	1xD	0.004	0.011	0.020	0.030	0.040	0.050	0.065	0.085	0.105
	Roughing	105	0.75xD	0.005	0.014	0.030	0.040	0.050	0.060	0.075	0.095	0.120
	Finishing	180	0.02xD	0.005	0.014	0.030	0.035	0.045	0.055	0.075	0.090	0.115
M1.1.1 Stainless steel, ferritic/martensitic, with machining additives M1.1.2 Stainless steel, ferritic/martensitic, annealed, Rm 680 N/mm ² , 200 HB	Slotting	90	1xD	0.004	0.011	0.020	0.030	0.040	0.050	0.065	0.085	0.105
	Roughing	105	0.75xD	0.005	0.014	0.030	0.040	0.050	0.060	0.075	0.095	0.120
	Finishing	180	0.02xD	0.005	0.014	0.030	0.035	0.045	0.055	0.075	0.090	0.115
M1.1.3 Stainless steel, ferritic/martensitic, heat-treated, Rm 810 N/mm ² , 240 HB	Slotting	65	1xD	0.003	0.010	0.020	0.025	0.040	0.045	0.060	0.075	0.095
	Roughing	75	0.75xD	0.004	0.013	0.025	0.035	0.045	0.050	0.070	0.085	0.110
	Finishing	130	0.02xD	0.004	0.013	0.025	0.035	0.040	0.050	0.065	0.085	0.105
M2.1.1 Stainless steel, austenitic, quenched, 180 HB	Slotting	60	1xD	0.003	0.010	0.020	0.025	0.040	0.045	0.060	0.075	0.095
	Roughing	75	0.6xD	0.005	0.014	0.025	0.035	0.045	0.055	0.075	0.090	0.115
	Finishing	120	0.01xD	0.004	0.011	0.025	0.030	0.040	0.045	0.060	0.075	0.095
M2.2.1 Duplex steel, high-strength stainless steels	Slotting	45	1xD	0.003	0.009	0.020	0.025	0.035	0.040	0.055	0.065	0.085
	Roughing	55	0.6xD	0.004	0.012	0.025	0.030	0.040	0.050	0.065	0.080	0.100
	Finishing	90	0.01xD	0.003	0.010	0.020	0.025	0.035	0.040	0.055	0.065	0.085
K1.1.1 Grey cast iron, pearlitic/ferritic, 180 HB K1.1.2 Grey cast iron, pearlitic/martensitic, 260 HB K1.2.1 Cast iron with spheroidal graphite, ferritic, 160 HB K1.2.2 Cast iron with spheroidal graphite, pearlitic, 250 HB	Slotting	110	1xD	0.004	0.012	0.025	0.030	0.045	0.055	0.070	0.090	0.115
	Roughing	125	0.75xD	0.005	0.016	0.030	0.040	0.050	0.060	0.085	0.105	0.130
	Finishing	220	0.02xD	0.005	0.015	0.030	0.040	0.050	0.060	0.080	0.100	0.125
K1.3.1 Malleable cast iron, ferritic, 130 HB K1.3.2 Malleable cast iron, pearlitic, 230 HB	Slotting	90	1xD	0.004	0.011	0.020	0.030	0.040	0.050	0.065	0.080	0.100
	Roughing	90	0.75xD	0.004	0.012	0.025	0.030	0.040	0.050	0.065	0.080	0.100
	Finishing	185	0.02xD	0.004	0.013	0.025	0.035	0.045	0.055	0.070	0.090	0.110
K2.1.1 Vermicular graphite cast iron (GJV) K2.2.1 Austenitic-ferritic spheroidal graphite cast iron (ADI)	Slotting	75	1xD	0.003	0.010	0.020	0.025	0.040	0.045	0.060	0.075	0.095
	Roughing	75	0.75xD	0.004	0.011	0.025	0.030	0.040	0.045	0.060	0.075	0.095
	Finishing	150	0.02xD	0.004	0.013	0.025	0.035	0.040	0.050	0.065	0.085	0.105
N1.1.1 Wrought aluminium alloys, non-hardened, 60 HB N1.1.2 Wrought aluminium alloys, hardened, 100 HB	Slotting	350	1xD	0.004	0.011	0.020	0.030	0.040	0.050	0.065	0.085	0.105
	Roughing	400	0.75xD	0.005	0.014	0.030	0.040	0.050	0.060	0.075	0.095	0.120
	Finishing	700	0.02xD	0.005	0.014	0.030	0.035	0.045	0.055	0.075	0.090	0.115
N2.1.1 Aluminium casting alloys, non-hardened, ≤ 12 % Si, 75 HB N2.1.2 Aluminium casting alloys, hardened, ≤ 12 % Si, 90 HB	Slotting	200	1xD	0.004	0.011	0.020	0.030	0.040	0.050	0.065	0.085	0.105
	Roughing	230	0.75xD	0.005	0.014	0.030	0.040	0.050	0.060	0.075	0.095	0.120
	Finishing	400	0.02xD	0.005	0.014	0.030	0.035	0.045	0.055	0.075	0.090	0.115
N2.1.3 Aluminium casting alloys, non-hardened, > 12 % Si, 130 HB	Slotting	160	1xD	0.004	0.011	0.020	0.030	0.040	0.050	0.065	0.085	0.105
	Roughing	160	0.75xD	0.004	0.013	0.025	0.035	0.040	0.050	0.065	0.085	0.105
	Finishing	315	0.02xD	0.005	0.014	0.030	0.035	0.045	0.055	0.075	0.090	0.115



Machining group	Application	V _c (m/min)	a _e max.	f _z (mm/z) with nom. Ø								
				1	3	6	8	10	12	16	20	25
N3.1.1 Copper and copper alloys: Free-machining alloy, Pb > 1 % N3.1.2 Copper and copper alloys: CuZn, CuSnZn	Slotting	220	1xD	0.004	0.013	0.025	0.035	0.050	0.060	0.080	0.100	0.125
	Roughing	255	0.75xD	0.006	0.017	0.035	0.045	0.060	0.070	0.090	0.115	0.145
	Finishing	440	0.02xD	0.006	0.017	0.035	0.045	0.055	0.065	0.090	0.110	0.140
N3.1.3 Copper and copper alloys: CuSn, lead-free copper and copper electrolyte	Slotting	170	1xD	0.004	0.012	0.025	0.030	0.045	0.055	0.075	0.090	0.115
	Roughing	200	0.75xD	0.005	0.016	0.030	0.040	0.055	0.065	0.085	0.105	0.130
	Finishing	345	0.02xD	0.005	0.015	0.030	0.040	0.050	0.060	0.080	0.100	0.125
N4.1.1 Non-metallic materials: Duroplastics, fibre-reinforced plastics	Slotting	120	1xD	0.004	0.012	0.025	0.035	0.045	0.055	0.075	0.095	0.120
	Roughing	140	0.75xD	0.005	0.016	0.030	0.045	0.055	0.065	0.085	0.110	0.135
	Finishing	240	0.02xD	0.005	0.016	0.030	0.040	0.050	0.060	0.085	0.105	0.130
N4.1.2 Non-metallic materials: Hard rubber, wood, etc.	Slotting	160	1xD	0.004	0.011	0.020	0.030	0.040	0.050	0.065	0.085	0.105
	Roughing	185	0.75xD	0.005	0.015	0.030	0.040	0.050	0.060	0.080	0.095	0.120
	Finishing	320	0.02xD	0.005	0.014	0.030	0.035	0.045	0.055	0.075	0.095	0.115
N4.1.3 Non-metallic materials: Graphite	Slotting	190	1xD	0.005	0.016	0.030	0.040	0.060	0.070	0.095	0.120	0.150
	Roughing	220	0.75xD	0.007	0.021	0.040	0.055	0.070	0.085	0.110	0.140	0.175
	Finishing	380	0.02xD	0.007	0.020	0.040	0.055	0.065	0.080	0.105	0.130	0.165
S1.1.1 Heat-resistant alloys, Fe-based, annealed, 200 HB	Slotting	25	1xD	0.003	0.010	0.020	0.025	0.035	0.045	0.060	0.075	0.090
	Roughing	30	0.6xD	0.004	0.013	0.025	0.035	0.045	0.055	0.070	0.090	0.110
	Finishing	50	0.01xD	0.004	0.011	0.020	0.030	0.035	0.045	0.060	0.075	0.090
S1.1.2 Heat-resistant alloys, Fe-based, hardened, 280 HB	Slotting	20	1xD	0.003	0.010	0.020	0.025	0.035	0.045	0.060	0.075	0.090
	Roughing	25	0.6xD	0.004	0.013	0.025	0.035	0.045	0.055	0.070	0.090	0.110
	Finishing	40	0.01xD	0.004	0.011	0.020	0.030	0.035	0.045	0.060	0.075	0.090
S1.1.3 Heat-resistant alloys, Ni- or Co-based, annealed, 250 HB	Slotting	15	1xD	0.003	0.008	0.015	0.020	0.030	0.035	0.045	0.060	0.075
	Roughing	15	0.6xD	0.004	0.011	0.020	0.030	0.035	0.045	0.055	0.070	0.090
	Finishing	30	0.01xD	0.003	0.009	0.020	0.025	0.030	0.035	0.045	0.060	0.075
S1.1.4 Heat-resistant alloys, Ni- or Co-based, hardened, 350 HB	Slotting	10	1xD	0.002	0.007	0.015	0.020	0.030	0.035	0.045	0.055	0.070
	Roughing	15	0.6xD	0.003	0.010	0.020	0.025	0.035	0.040	0.055	0.065	0.085
	Finishing	20	0.01xD	0.003	0.008	0.015	0.020	0.030	0.035	0.045	0.055	0.070
S1.1.5 Heat-resistant alloys, Ni- or Co-based, cast, 320 HB	Slotting	10	1xD	0.003	0.008	0.015	0.020	0.030	0.035	0.045	0.060	0.075
	Roughing	15	0.6xD	0.004	0.011	0.020	0.030	0.035	0.045	0.055	0.070	0.090
	Finishing	25	0.01xD	0.003	0.009	0.020	0.025	0.030	0.035	0.045	0.060	0.075
S2.1.1 Titanium alloys, pure titanium, Rm 400 N/mm ²	Slotting	50	1xD	0.004	0.011	0.020	0.030	0.040	0.050	0.065	0.080	0.105
	Roughing	65	0.6xD	0.005	0.015	0.030	0.040	0.050	0.060	0.080	0.100	0.125
	Finishing	105	0.02xD	0.005	0.014	0.025	0.035	0.045	0.055	0.070	0.090	0.115
S2.1.2 Titanium alloys, Alpha and Beta alloys, hardened, Rm 1050 N/mm ²	Slotting	45	1xD	0.003	0.010	0.020	0.025	0.035	0.045	0.060	0.075	0.090
	Roughing	55	0.6xD	0.004	0.013	0.025	0.035	0.045	0.055	0.070	0.090	0.110
	Finishing	90	0.02xD	0.004	0.012	0.025	0.030	0.040	0.050	0.065	0.080	0.100
H1.1.1 Hardened steel, hardened and tempered, < 55 HRC	Slotting	55	1xD	0.003	0.009	0.020	0.025	0.035	0.040	0.055	0.070	0.090
	Roughing	85	0.33xD	0.005	0.014	0.025	0.035	0.045	0.055	0.075	0.090	0.115
	Finishing	110	0.01xD	0.004	0.011	0.020	0.030	0.035	0.040	0.055	0.070	0.090
H1.1.2 Hardened steel, hardened and tempered, < 60 HRC	Roughing	85	0.03xD	0.007	0.022	0.045	0.060	0.075	0.090	0.120	0.150	0.185
	Finishing	90	0.005xD	0.003	0.008	0.015	0.020	0.025	0.030	0.045	0.055	0.065
H1.1.3 Hardened steel, hardened and tempered, > 60 HRC	Roughing	70	0.03xD	0.007	0.020	0.040	0.055	0.065	0.080	0.105	0.130	0.165
	Finishing	75	0.005xD	0.002	0.007	0.015	0.020	0.025	0.030	0.040	0.045	0.060
H2.1.1 Chilled cast iron, 400 HB	Slotting	70	1xD	0.003	0.010	0.020	0.025	0.035	0.045	0.060	0.070	0.090
	Roughing	110	0.33xD	0.005	0.014	0.030	0.035	0.045	0.055	0.075	0.095	0.115
	Finishing	145	0.01xD	0.004	0.011	0.020	0.030	0.035	0.045	0.060	0.070	0.090
H2.1.2 Chilled cast iron, hardened and tempered, < 55 HRC	Slotting	50	1xD	0.003	0.008	0.015	0.025	0.030	0.040	0.050	0.065	0.080
	Roughing	75	0.33xD	0.004	0.012	0.025	0.035	0.040	0.050	0.065	0.085	0.105
	Finishing	105	0.01xD	0.003	0.010	0.020	0.025	0.030	0.040	0.050	0.065	0.080



GS 100 U, H, A

Milling conditions:

MTC unstable machining conditions
low drive power

long tools

Correction factors:

a_p roughing > 1.5xD v_c -25 % f_z -25 %

uncoated tools v_c -50 % f_z -25 %



Machining group	Application	v_c (m/min)	a_e max.	f_z (mm/z) with nom. \emptyset								
				3	4	6	8	10	12	16	20	25
P1.1.1 Unalloyed steel, annealed, 0.15 % C, Rm 420 N/mm ² , 125 HB P1.1.2 Unalloyed steel, heat-treated, 0.15 % C, Rm 420 N/mm ² , 125 HB P1.1.3 Unalloyed steel, annealed, 0.45 % C, Rm 640 N/mm ² , 190 HB P1.1.4 Unalloyed steel, heat-treated, 0.45 % C, Rm 640 N/mm ² , 190 HB P1.1.5 Unalloyed steel, heat-treated, 0.45 % C, Rm 850 N/mm ² , 250 HB P1.1.6 Unalloyed steel, annealed, 0.75 % C, Rm 915 N/mm ² , 270 HB P1.1.7 Unalloyed steel, heat-treated, 0.75 % C, Rm 1020 N/mm ² , 300 HB	Slotting	120	1xD	0.008	0.010	0.015	0.020	0.030	0.035	0.050	0.060	0.075
	Roughing	140	0.75xD	0.010	0.015	0.020	0.030	0.035	0.040	0.055	0.070	0.085
P2.1.1 Low-alloy steel, annealed, Rm 610 N/mm ² , 180 HB P2.1.2 Low-alloy steel, heat-treated, Rm 930 N/mm ² , 275 HB P2.1.3 Low-alloy steel, heat-treated, Rm 1020 N/mm ² , 300 HB P2.1.4 Low-alloy steel, heat-treated, Rm 1190 N/mm ² , 350 HB	Slotting	100	1xD	0.008	0.010	0.015	0.020	0.030	0.035	0.050	0.060	0.075
	Roughing	115	0.75xD	0.010	0.015	0.020	0.030	0.035	0.040	0.055	0.070	0.085
P3.1.1 High-alloy steel and tool steel, annealed, Rm 680 N/mm ² , 200 HB P3.1.2 High-alloy steel and tool steel, hardened and tempered, Rm 1100 N/mm ² , 325 HB	Slotting	90	1xD	0.007	0.010	0.015	0.020	0.030	0.035	0.045	0.055	0.070
	Roughing	105	0.75xD	0.010	0.015	0.020	0.025	0.030	0.040	0.050	0.065	0.080
M1.1.1 Stainless steel, ferritic/martensitic, with machining additives M1.1.2 Stainless steel, ferritic/martensitic, annealed, Rm 680 N/mm ² , 200 HB	Slotting	80	1xD	0.007	0.010	0.015	0.020	0.030	0.035	0.045	0.055	0.070
	Roughing	90	0.75xD	0.010	0.015	0.020	0.025	0.030	0.040	0.050	0.065	0.080
M1.1.3 Stainless steel, ferritic/martensitic, heat-treated, Rm 810 N/mm ² , 240 HB	Slotting	60	1xD	0.007	0.010	0.015	0.020	0.025	0.030	0.040	0.050	0.065
	Roughing	65	0.75xD	0.009	0.010	0.015	0.025	0.030	0.035	0.045	0.060	0.075
M2.1.1 Stainless steel, austenitic, quenched, 180 HB	Slotting	60	1xD	0.007	0.010	0.015	0.020	0.025	0.030	0.040	0.050	0.065
	Roughing	75	0.6xD	0.009	0.010	0.020	0.025	0.030	0.035	0.050	0.060	0.075
M2.2.1 Duplex steel, high-strength stainless steels	Slotting	45	1xD	0.006	0.010	0.010	0.015	0.020	0.025	0.035	0.045	0.055
	Roughing	55	0.6xD	0.008	0.010	0.015	0.020	0.025	0.030	0.040	0.050	0.065
K1.1.1 Grey cast iron, pearlitic/ferritic, 180 HB K1.1.2 Grey cast iron, pearlitic/martensitic, 260 HB K1.2.1 Cast iron with spheroidal graphite, ferritic, 160 HB K1.2.2 Cast iron with spheroidal graphite, pearlitic, 250 HB	Slotting	105	1xD	0.008	0.010	0.015	0.020	0.030	0.035	0.050	0.060	0.075
	Roughing	120	0.75xD	0.010	0.015	0.020	0.030	0.035	0.040	0.055	0.070	0.085
K1.3.1 Malleable cast iron, ferritic, 130 HB K1.3.2 Malleable cast iron, pearlitic, 230 HB	Slotting	85	1xD	0.007	0.010	0.015	0.020	0.025	0.030	0.045	0.055	0.065
	Roughing	85	0.75xD	0.008	0.010	0.015	0.020	0.025	0.030	0.045	0.055	0.065
K2.1.1 Vermicular graphite cast iron (GJV) K2.2.1 Austenitic-ferritic spheroidal graphite cast iron (ADI)	Slotting	75	1xD	0.007	0.010	0.015	0.020	0.025	0.030	0.040	0.050	0.065
	Roughing	75	0.75xD	0.008	0.010	0.015	0.020	0.025	0.030	0.040	0.050	0.065
N1.1.1 Wrought aluminium alloys, non-hardened, 60 HB N1.1.2 Wrought aluminium alloys, hardened, 100 HB	Slotting	320	1xD	0.009	0.010	0.020	0.025	0.035	0.040	0.055	0.070	0.090
	Roughing	370	0.75xD	0.012	0.015	0.025	0.030	0.040	0.050	0.065	0.080	0.100
N2.1.1 Aluminium casting alloys, non-hardened, ≤ 12 % Si, 75 HB N2.1.2 Aluminium casting alloys, hardened, ≤ 12 % Si, 90 HB	Slotting	180	1xD	0.008	0.010	0.015	0.025	0.030	0.040	0.050	0.065	0.080
	Roughing	205	0.75xD	0.011	0.015	0.020	0.030	0.035	0.045	0.060	0.075	0.090
N2.1.3 Aluminium casting alloys, non-hardened, > 12 % Si, 130 HB	Slotting	140	1xD	0.008	0.010	0.015	0.025	0.030	0.040	0.050	0.065	0.080
	Roughing	140	0.75xD	0.010	0.015	0.020	0.025	0.030	0.040	0.050	0.065	0.080



Machining group	Application	V _c (m/min)	a _e max.	f _z (mm/z) with nom. Ø								
				3	4	6	8	10	12	16	20	25
N3.1.1 Copper and copper alloys: Free-machining alloy, Pb > 1 % N3.1.2 Copper and copper alloys: CuZn, CuSnZn	Slotting	180	1xD	0.008	0.010	0.015	0.025	0.030	0.040	0.050	0.065	0.080
	Roughing	205	0.75xD	0.011	0.015	0.020	0.030	0.035	0.045	0.060	0.075	0.090
N3.1.3 Copper and copper alloys: CuSn, lead-free copper and copper electrolyte	Slotting	140	1xD	0.008	0.010	0.015	0.020	0.030	0.035	0.045	0.060	0.075
	Roughing	160	0.75xD	0.010	0.015	0.020	0.025	0.035	0.040	0.055	0.070	0.085
N4.1.1 Non-metallic materials: Duroplastics, fibre-reinforced plastics	Slotting	100	1xD	0.008	0.010	0.015	0.020	0.030	0.035	0.050	0.060	0.080
	Roughing	115	0.75xD	0.011	0.015	0.020	0.030	0.035	0.045	0.055	0.070	0.090
N4.1.2 Non-metallic materials: Hard rubber, wood, etc.	Slotting	135	1xD	0.007	0.010	0.015	0.020	0.030	0.035	0.045	0.055	0.070
	Roughing	155	0.75xD	0.010	0.015	0.020	0.025	0.030	0.040	0.050	0.065	0.080
N4.1.3 Non-metallic materials: Graphite	Slotting	160	1xD	0.010	0.015	0.020	0.030	0.040	0.050	0.065	0.080	0.100
	Roughing	185	0.75xD	0.014	0.020	0.025	0.035	0.045	0.055	0.075	0.090	0.115
S1.1.1 Heat-resistant alloys, Fe-based, annealed, 200 HB	Slotting	20	1xD	0.006	0.010	0.015	0.015	0.025	0.030	0.040	0.050	0.060
	Roughing	25	0.6xD	0.009	0.010	0.015	0.025	0.030	0.035	0.045	0.060	0.070
S1.1.2 Heat-resistant alloys, Fe-based, hardened, 280 HB	Slotting	15	1xD	0.006	0.010	0.015	0.015	0.025	0.030	0.040	0.050	0.060
	Roughing	20	0.6xD	0.009	0.010	0.015	0.025	0.030	0.035	0.045	0.060	0.070
S1.1.3 Heat-resistant alloys, Ni- or Co-based, annealed, 250 HB	Slotting	10	1xD	0.005	0.005	0.010	0.015	0.020	0.025	0.030	0.040	0.050
	Roughing	15	0.6xD	0.007	0.010	0.015	0.020	0.025	0.030	0.035	0.045	0.060
S1.1.4 Heat-resistant alloys, Ni- or Co-based, hardened, 350 HB	Slotting	10	1xD	0.005	0.005	0.010	0.015	0.020	0.020	0.030	0.035	0.045
	Roughing	10	0.6xD	0.007	0.010	0.015	0.020	0.020	0.025	0.035	0.045	0.055
S1.1.5 Heat-resistant alloys, Ni- or Co-based, cast, 320 HB	Slotting	10	1xD	0.005	0.005	0.010	0.015	0.020	0.025	0.030	0.040	0.050
	Roughing	15	0.6xD	0.007	0.010	0.015	0.020	0.025	0.030	0.035	0.045	0.060
S2.1.1 Titanium alloys, pure titanium, Rm 400 N/mm ²	Slotting	55	1xD	0.006	0.010	0.015	0.015	0.025	0.030	0.040	0.050	0.060
	Roughing	70	0.6xD	0.009	0.010	0.015	0.025	0.030	0.035	0.045	0.060	0.070
S2.1.2 Titanium alloys, Alpha and Beta alloys, hardened, Rm 1050 N/mm ²	Slotting	45	1xD	0.006	0.010	0.010	0.015	0.020	0.025	0.035	0.045	0.055
	Roughing	60	0.6xD	0.008	0.010	0.015	0.020	0.025	0.030	0.040	0.050	0.065
H1.1.1 Hardened steel, hardened and tempered, < 55 HRC	Slotting	50	1xD	0.005	0.005	0.010	0.015	0.020	0.020	0.030	0.035	0.045
	Roughing	75	0.33xD	0.007	0.010	0.015	0.020	0.025	0.030	0.035	0.045	0.060
H1.1.2 Hardened steel, hardened and tempered, < 60 HRC												
H1.1.3 Hardened steel, hardened and tempered, > 60 HRC												
H2.1.1 Chilled cast iron, 400 HB	Slotting	70	1xD	0.006	0.010	0.010	0.015	0.025	0.030	0.035	0.045	0.060
	Roughing	80	0.75xD	0.008	0.010	0.015	0.020	0.025	0.030	0.040	0.055	0.065
H2.1.2 Chilled cast iron, hardened and tempered, < 55 HRC	Slotting	50	1xD	0.005	0.005	0.010	0.015	0.020	0.025	0.035	0.040	0.050
	Roughing	75	0.33xD	0.008	0.010	0.015	0.020	0.025	0.030	0.045	0.055	0.065



Universal end mills, 2-/3-/4-fluted, type N

Milling conditions:

HPC	stable machining conditions high drive power
	short tools
	long tools

Correction factors:

	a_p roughing > 1.5xD	v_c -25 %	f_z -25 %
	extra length tools	v_c -60 %	f_z -55 %
	uncoated tools	v_c -50 %	f_z -25 %



Cutting data

Machining group	Application	v_c (m/min)	a_e max.	f_z (mm/z) with nom. \emptyset								
				0.5	1	3	6	8	10	12	16	20
P1.1.1 Unalloyed steel, annealed, 0.15 % C, Rm 420 N/mm ² , 125 HB P1.1.2 Unalloyed steel, heat-treated, 0.15 % C, Rm 420 N/mm ² , 125 HB P1.1.3 Unalloyed steel, annealed, 0.45 % C, Rm 640 N/mm ² , 190 HB P1.1.4 Unalloyed steel, heat-treated, 0.45 % C, Rm 640 N/mm ² , 190 HB P1.1.5 Unalloyed steel, heat-treated, 0.45 % C, Rm 850 N/mm ² , 250 HB P1.1.6 Unalloyed steel, annealed, 0.75 % C, Rm 915 N/mm ² , 270 HB P1.1.7 Unalloyed steel, heat-treated, 0.75 % C, Rm 1020 N/mm ² , 300 HB	Slotting	120	1xD	0.002	0.004	0.011	0.020	0.030	0.040	0.050	0.065	0.085
	Roughing	140	0.75xD	0.002	0.005	0.014	0.030	0.040	0.050	0.060	0.075	0.095
	Finishing	240	0.02xD	0.002	0.005	0.014	0.030	0.035	0.045	0.055	0.075	0.090
P2.1.1 Low-alloy steel, annealed, Rm 610 N/mm ² , 180 HB P2.1.2 Low-alloy steel, heat-treated, Rm 930 N/mm ² , 275 HB P2.1.3 Low-alloy steel, heat-treated, Rm 1020 N/mm ² , 300 HB P2.1.4 Low-alloy steel, heat-treated, Rm 1190 N/mm ² , 350 HB	Slotting	110	1xD	0.002	0.004	0.011	0.020	0.030	0.040	0.050	0.065	0.085
	Roughing	125	0.75xD	0.002	0.005	0.014	0.030	0.040	0.050	0.060	0.075	0.095
	Finishing	220	0.02xD	0.002	0.005	0.014	0.030	0.035	0.045	0.055	0.075	0.090
P3.1.1 High-alloy steel and tool steel, annealed, Rm 680 N/mm ² , 200 HB P3.1.2 High-alloy steel and tool steel, hardened and tempered, Rm 1100 N/mm ² , 325 HB	Slotting	90	1xD	0.002	0.003	0.010	0.020	0.025	0.040	0.045	0.060	0.080
	Roughing	105	0.75xD	0.002	0.004	0.013	0.025	0.035	0.045	0.055	0.070	0.090
	Finishing	180	0.02xD	0.002	0.004	0.013	0.025	0.035	0.045	0.050	0.070	0.085
M1.1.1 Stainless steel, ferritic/martensitic, with machining additives M1.1.2 Stainless steel, ferritic/martensitic, annealed, Rm 680 N/mm ² , 200 HB	Slotting	85	1xD	0.001	0.003	0.008	0.015	0.020	0.030	0.035	0.050	0.060
	Roughing	100	0.75xD	0.002	0.003	0.010	0.020	0.030	0.035	0.040	0.055	0.070
	Finishing	170	0.02xD	0.002	0.003	0.010	0.020	0.025	0.035	0.040	0.055	0.065
M1.1.3 Stainless steel, ferritic/martensitic, heat-treated, Rm 810 N/mm ² , 240 HB	Slotting	60	1xD	0.001	0.002	0.007	0.015	0.020	0.025	0.035	0.045	0.055
	Roughing	70	0.75xD	0.002	0.003	0.009	0.020	0.025	0.030	0.035	0.050	0.060
	Finishing	125	0.02xD	0.001	0.003	0.009	0.020	0.025	0.030	0.035	0.050	0.060
M2.1.1 Stainless steel, austenitic, quenched, 180 HB	Slotting	60	1xD	0.001	0.002	0.007	0.015	0.020	0.025	0.030	0.045	0.055
	Roughing	75	0.6xD	0.002	0.003	0.010	0.020	0.025	0.030	0.040	0.050	0.065
	Finishing	115	0.01xD	0.001	0.003	0.008	0.015	0.020	0.025	0.030	0.045	0.055
M2.2.1 Duplex steel, high-strength stainless steels	Slotting	45	1xD	0.001	0.002	0.006	0.010	0.015	0.025	0.030	0.040	0.045
	Roughing	55	0.6xD	0.001	0.003	0.008	0.015	0.025	0.030	0.035	0.045	0.055
	Finishing	85	0.01xD	0.001	0.002	0.007	0.015	0.020	0.025	0.030	0.040	0.045
K1.1.1 Grey cast iron, pearlitic/ferritic, 180 HB K1.1.2 Grey cast iron, pearlitic/martensitic, 260 HB K1.2.1 Cast iron with spheroidal graphite, ferritic, 160 HB K1.2.2 Cast iron with spheroidal graphite, pearlitic, 250 HB	Slotting	105	1xD	0.002	0.003	0.010	0.020	0.025	0.040	0.045	0.060	0.075
	Roughing	120	0.75xD	0.002	0.004	0.013	0.025	0.035	0.045	0.050	0.070	0.085
	Finishing	210	0.02xD	0.002	0.004	0.013	0.025	0.035	0.040	0.050	0.065	0.085
K1.3.1 Malleable cast iron, ferritic, 130 HB K1.3.2 Malleable cast iron, pearlitic, 230 HB	Slotting	90	1xD	0.001	0.003	0.009	0.020	0.025	0.035	0.040	0.055	0.070
	Roughing	90	0.75xD	0.002	0.003	0.010	0.020	0.025	0.035	0.040	0.055	0.070
	Finishing	175	0.02xD	0.002	0.004	0.011	0.020	0.030	0.035	0.045	0.060	0.075
K2.1.1 Vermicular graphite cast iron (GJV) K2.2.1 Austenitic-ferritic spheroidal graphite cast iron (ADI)	Slotting	80	1xD	0.001	0.003	0.008	0.015	0.020	0.030	0.035	0.045	0.060
	Roughing	80	0.75xD	0.001	0.003	0.009	0.015	0.025	0.030	0.035	0.045	0.060
	Finishing	160	0.02xD	0.002	0.003	0.010	0.020	0.025	0.030	0.040	0.050	0.065
N1.1.1 Wrought aluminium alloys, non-hardened, 60 HB N1.1.2 Wrought aluminium alloys, hardened, 100 HB	Slotting	300	1xD	0.003	0.006	0.017	0.035	0.045	0.065	0.080	0.105	0.130
	Roughing	345	0.75xD	0.004	0.007	0.022	0.045	0.060	0.075	0.090	0.120	0.150
	Finishing	600	0.02xD	0.004	0.007	0.021	0.045	0.055	0.070	0.085	0.115	0.145
N2.1.1 Aluminium casting alloys, non-hardened, \leq 12 % Si, 75 HB N2.1.2 Aluminium casting alloys, hardened, \leq 12 % Si, 90 HB	Slotting	160	1xD	0.002	0.005	0.015	0.030	0.040	0.055	0.065	0.090	0.110
	Roughing	185	0.75xD	0.003	0.006	0.019	0.040	0.050	0.065	0.075	0.105	0.130
	Finishing	320	0.02xD	0.003	0.006	0.018	0.035	0.050	0.060	0.075	0.100	0.125
N2.1.3 Aluminium casting alloys, non-hardened, > 12 % Si, 130 HB	Slotting	125	1xD	0.002	0.005	0.015	0.030	0.040	0.055	0.065	0.090	0.110
	Roughing	125	0.75xD	0.003	0.006	0.017	0.035	0.045	0.055	0.065	0.090	0.110
	Finishing	255	0.02xD	0.003	0.006	0.018	0.035	0.050	0.060	0.075	0.100	0.125



Machining group	Application	V _c (m/min)	a _e max.	f _z (mm/z) with nom. Ø								
				0.5	1	3	6	8	10	12	16	20
N3.1.1 Copper and copper alloys: Free-machining alloy, Pb > 1 % N3.1.2 Copper and copper alloys: CuZn, CuSnZn	Slotting	200	1xD	0.002	0.004	0.012	0.025	0.030	0.045	0.055	0.075	0.090
	Roughing	230	0.75xD	0.003	0.005	0.016	0.030	0.040	0.055	0.065	0.085	0.105
	Finishing	400	0.02xD	0.003	0.005	0.015	0.030	0.040	0.050	0.060	0.080	0.100
N3.1.3 Copper and copper alloys: CuSn, lead-free copper and copper electrolyte	Slotting	155	1xD	0.002	0.004	0.011	0.020	0.030	0.040	0.050	0.070	0.085
	Roughing	180	0.75xD	0.002	0.005	0.015	0.030	0.040	0.050	0.060	0.080	0.095
	Finishing	315	0.02xD	0.002	0.005	0.014	0.030	0.035	0.045	0.055	0.075	0.095
N4.1.1 Non-metallic materials: Duroplastics, fibre-reinforced plastics	Slotting	100	1xD	0.002	0.004	0.012	0.025	0.030	0.045	0.055	0.070	0.090
	Roughing	115	0.75xD	0.003	0.005	0.015	0.030	0.040	0.050	0.060	0.080	0.100
	Finishing	200	0.02xD	0.002	0.005	0.015	0.030	0.040	0.050	0.060	0.075	0.095
N4.1.2 Non-metallic materials: Hard rubber, wood, etc.	Slotting	135	1xD	0.002	0.003	0.010	0.020	0.030	0.040	0.045	0.065	0.080
	Roughing	155	0.75xD	0.002	0.005	0.014	0.025	0.035	0.045	0.055	0.075	0.090
	Finishing	265	0.02xD	0.002	0.004	0.013	0.025	0.035	0.045	0.050	0.070	0.085
N4.1.3 Non-metallic materials: Graphite	Slotting	160	1xD	0.002	0.005	0.015	0.030	0.040	0.055	0.065	0.090	0.110
	Roughing	185	0.75xD	0.003	0.006	0.019	0.040	0.050	0.065	0.080	0.105	0.130
	Finishing	320	0.02xD	0.003	0.006	0.019	0.035	0.050	0.060	0.075	0.100	0.125
S1.1.1 Heat-resistant alloys, Fe-based, annealed, 200 HB	Slotting	25	1xD	0.001	0.002	0.006	0.010	0.015	0.025	0.030	0.035	0.045
	Roughing	30	0.6xD	0.001	0.003	0.008	0.015	0.020	0.030	0.035	0.045	0.055
	Finishing	50	0.01xD	0.001	0.002	0.007	0.015	0.020	0.025	0.030	0.035	0.045
S1.1.2 Heat-resistant alloys, Fe-based, hardened, 280 HB	Slotting	20	1xD	0.001	0.002	0.006	0.010	0.015	0.025	0.030	0.035	0.045
	Roughing	25	0.6xD	0.001	0.003	0.008	0.015	0.020	0.030	0.035	0.045	0.055
	Finishing	40	0.01xD	0.001	0.002	0.007	0.015	0.020	0.025	0.030	0.035	0.045
S1.1.3 Heat-resistant alloys, Ni- or Co-based, annealed, 250 HB	Slotting	15	1xD	0.001	0.002	0.005	0.010	0.015	0.020	0.020	0.030	0.035
	Roughing	20	0.6xD	0.001	0.002	0.007	0.015	0.020	0.020	0.025	0.035	0.045
	Finishing	30	0.01xD	0.001	0.002	0.006	0.010	0.015	0.020	0.020	0.030	0.035
S1.1.4 Heat-resistant alloys, Ni- or Co-based, hardened, 350 HB	Slotting	10	1xD	0.001	0.002	0.005	0.010	0.010	0.020	0.020	0.030	0.035
	Roughing	15	0.6xD	0.001	0.002	0.006	0.015	0.015	0.020	0.025	0.035	0.040
	Finishing	20	0.01xD	0.001	0.002	0.005	0.010	0.015	0.020	0.020	0.030	0.035
S1.1.5 Heat-resistant alloys, Ni- or Co-based, cast, 320 HB	Slotting	15	1xD	0.001	0.002	0.005	0.010	0.015	0.020	0.020	0.030	0.035
	Roughing	15	0.6xD	0.001	0.002	0.007	0.015	0.020	0.020	0.025	0.035	0.045
	Finishing	25	0.01xD	0.001	0.002	0.006	0.010	0.015	0.020	0.020	0.030	0.035
S2.1.1 Titanium alloys, pure titanium, Rm 400 N/mm ²	Slotting	50	1xD	0.002	0.003	0.009	0.020	0.025	0.035	0.040	0.055	0.070
	Roughing	65	0.6xD	0.002	0.004	0.013	0.025	0.035	0.040	0.050	0.065	0.085
	Finishing	100	0.02xD	0.002	0.004	0.012	0.025	0.030	0.040	0.045	0.060	0.075
S2.1.2 Titanium alloys, Alpha and Beta alloys, hardened, Rm 1050 N/mm ²	Slotting	40	1xD	0.001	0.003	0.008	0.015	0.020	0.030	0.040	0.050	0.065
	Roughing	55	0.6xD	0.002	0.004	0.011	0.025	0.030	0.040	0.045	0.060	0.075
	Finishing	85	0.02xD	0.002	0.003	0.010	0.020	0.030	0.035	0.040	0.055	0.070
H1.1.1 Hardened steel, hardened and tempered, < 55 HRC	Slotting	40	1xD	0.001	0.003	0.008	0.015	0.020	0.030	0.035	0.050	0.060
	Roughing	60	0.33xD	0.002	0.004	0.012	0.025	0.030	0.040	0.045	0.060	0.080
	Finishing	80	0.01xD	0.002	0.003	0.009	0.020	0.025	0.030	0.035	0.050	0.060
H1.1.2 Hardened steel, hardened and tempered, < 60 HRC	Slotting											
	Roughing											
	Finishing											
H1.1.3 Hardened steel, hardened and tempered, > 60 HRC	Slotting											
	Roughing											
	Finishing											
H2.1.1 Chilled cast iron, 400 HB	Slotting	50	1xD	0.001	0.003	0.008	0.015	0.020	0.030	0.035	0.045	0.060
	Roughing	80	0.33xD	0.002	0.004	0.011	0.025	0.030	0.040	0.045	0.060	0.075
	Finishing	105	0.01xD	0.001	0.003	0.009	0.015	0.025	0.030	0.035	0.045	0.060
H2.1.2 Chilled cast iron, hardened and tempered, < 55 HRC	Slotting	35	1xD	0.001	0.002	0.007	0.015	0.020	0.025	0.030	0.040	0.050
	Roughing	55	0.33xD	0.002	0.003	0.010	0.020	0.025	0.035	0.040	0.055	0.065
	Finishing	75	0.01xD	0.001	0.003	0.008	0.015	0.020	0.025	0.030	0.040	0.050



RF 100 Micro Diver, 2.5xD

Milling conditions:

HSC stable machining conditions
low cutting depths, high cutting values

long tools



Cutting data

Machining group	Application	v _c (m/min) with nom. Ø				a _p max.	a _e max.	f _z (mm/z) with nom. Ø							
		0.79 - 1.2	1.5 - 1.98	2.0 - 2.5	2.78 - 3.175			0.8	1	1.2	1.5	1.8	2	2.5	3
P1.1.1 Unalloyed steel, annealed, 0.15 % C, Rm 420 N/mm ² , 125 HB P1.1.2 Unalloyed steel, heat-treated, 0.15 % C, Rm 420 N/mm ² , 125 HB P1.1.3 Unalloyed steel, annealed, 0.45 % C, Rm 640 N/mm ² , 190 HB P1.1.4 Unalloyed steel, heat-treated, 0.45 % C, Rm 640 N/mm ² , 190 HB P1.1.5 Unalloyed steel, heat-treated, 0.45 % C, Rm 850 N/mm ² , 250 HB P1.1.6 Unalloyed steel, annealed, 0.75 % C, Rm 915 N/mm ² , 270 HB P1.1.7 Unalloyed steel, heat-treated, 0.75 % C, Rm 1020 N/mm ² , 300 HB	Plunging	120	130	145	160	1xD	1xD	0.0040	0.0050	0.0060	0.0080	0.0120	0.0140	0.0170	0.0200
	Slotting	130	145	160	170	1xD	1xD	0.0060	0.0080	0.0100	0.0120	0.0160	0.0180	0.0230	0.0270
	Roughing	200	210	220	230	2xD	0.25xD	0.0100	0.0120	0.0150	0.0180	0.0240	0.0270	0.0340	0.0400
	Finishing	240	250	260	275	2xD	0.03xD	0.0060	0.0080	0.0090	0.0120	0.0170	0.0190	0.0240	0.0290
P2.1.1 Low-alloy steel, annealed, Rm 610 N/mm ² , 180 HB P2.1.2 Low-alloy steel, heat-treated, Rm 930 N/mm ² , 275 HB P2.1.3 Low-alloy steel, heat-treated, Rm 1020 N/mm ² , 300 HB P2.1.4 Low-alloy steel, heat-treated, Rm 1190 N/mm ² , 350 HB	Plunging	110	120	135	145	1xD	1xD	0.0040	0.0050	0.0060	0.0070	0.0110	0.0120	0.0150	0.0180
	Slotting	120	135	145	155	1xD	1xD	0.0060	0.0070	0.0090	0.0110	0.0140	0.0160	0.0200	0.0240
	Roughing	185	195	200	210	2xD	0.25xD	0.0090	0.0110	0.0130	0.0160	0.0220	0.0240	0.0300	0.0360
	Finishing	220	230	240	250	2xD	0.03xD	0.0060	0.0070	0.0080	0.0100	0.0160	0.0170	0.0220	0.0260
P3.1.1 High-alloy steel and tool steel, annealed, Rm 680 N/mm ² , 200 HB P3.1.2 High-alloy steel and tool steel, hardened and tempered, Rm 1100 N/mm ² , 325 HB	Plunging	100	110	120	130	0.75xD	1xD	0.0030	0.0040	0.0040	0.0050	0.0080	0.0090	0.0110	0.0140
	Slotting	110	120	130	145	0.75xD	1xD	0.0040	0.0050	0.0060	0.0080	0.0110	0.0120	0.0150	0.0180
	Roughing	180	185	195	205	2xD	0.2xD	0.0070	0.0090	0.0100	0.0130	0.0170	0.0190	0.0240	0.0290
	Finishing	200	210	220	230	2xD	0.03xD	0.0040	0.0050	0.0060	0.0080	0.0120	0.0130	0.0160	0.0190
M1.1.1 Stainless steel, ferritic/martensitic, with machining additives M1.1.2 Stainless steel, ferritic/martensitic, annealed, Rm 680 N/mm ² , 200 HB	Plunging	110	120	135	145	1xD	1xD	0.0040	0.0050	0.0060	0.0070	0.0110	0.0120	0.0150	0.0180
	Slotting	120	135	145	155	1xD	1xD	0.0060	0.0070	0.0090	0.0110	0.0140	0.0160	0.0200	0.0240
	Roughing	185	195	200	210	2xD	0.25xD	0.0090	0.0110	0.0130	0.0160	0.0220	0.0240	0.0300	0.0360
	Finishing	220	230	240	250	2xD	0.03xD	0.0060	0.0070	0.0080	0.0100	0.0160	0.0170	0.0220	0.0260
M1.1.3 Stainless steel, ferritic/martensitic, heat-treated, Rm 810 N/mm ² , 240 HB	Plunging	80	90	100	105	1xD	1xD	0.0030	0.0040	0.0050	0.0070	0.0100	0.0110	0.0140	0.0160
	Slotting	90	100	105	115	1xD	1xD	0.0050	0.0070	0.0080	0.0100	0.0130	0.0140	0.0180	0.0220
	Roughing	135	140	150	155	2xD	0.25xD	0.0080	0.0100	0.0120	0.0150	0.0200	0.0220	0.0270	0.0330
	Finishing	160	170	175	185	2xD	0.03xD	0.0050	0.0060	0.0080	0.0090	0.0140	0.0160	0.0200	0.0230
M2.1.1 Stainless steel, austenitic, quenched, 180 HB	Plunging	90	100	110	120	0.75xD	1xD	0.0030	0.0040	0.0050	0.0060	0.0090	0.0110	0.0130	0.0160
	Slotting	100	110	120	130	0.75xD	1xD	0.0050	0.0060	0.0080	0.0090	0.0130	0.0140	0.0180	0.0210
	Roughing	160	170	175	185	2xD	0.2xD	0.0080	0.0100	0.0120	0.0150	0.0200	0.0220	0.0280	0.0340
	Finishing	180	185	195	205	2xD	0.03xD	0.0050	0.0060	0.0070	0.0090	0.0140	0.0150	0.0190	0.0230
M2.2.1 Duplex steel, high-strength stainless steels	Plunging	65	75	80	90	0.75xD	1xD	0.0030	0.0040	0.0040	0.0060	0.0080	0.0090	0.0110	0.0140
	Slotting	75	80	90	95	0.75xD	1xD	0.0040	0.0060	0.0070	0.0080	0.0110	0.0120	0.0150	0.0180
	Roughing	120	125	130	135	2xD	0.2xD	0.0070	0.0090	0.0110	0.0130	0.0180	0.0200	0.0240	0.0290
	Finishing	135	140	145	150	2xD	0.03xD	0.0040	0.0050	0.0060	0.0080	0.0120	0.0130	0.0170	0.0200
K1.1.1 Grey cast iron, pearlitic/ferritic, 180 HB K1.1.2 Grey cast iron, pearlitic/martensitic, 260 HB K1.2.1 Cast iron with spheroidal graphite, ferritic, 160 HB K1.2.2 Cast iron with spheroidal graphite, pearlitic, 250 HB	Plunging	110	120	135	145	1xD	1xD	0.0030	0.0040	0.0050	0.0060	0.0090	0.0110	0.0130	0.0160
	Slotting	120	135	145	155	1xD	1xD	0.0050	0.0060	0.0080	0.0090	0.0130	0.0140	0.0180	0.0210
	Roughing	185	195	200	210	2xD	0.25xD	0.0080	0.0090	0.0110	0.0140	0.0190	0.0210	0.0260	0.0320
	Finishing	220	230	240	250	2xD	0.03xD	0.0050	0.0060	0.0070	0.0090	0.0140	0.0150	0.0190	0.0230



Machining group	Application	v _c (m/min) with nom. Ø				a _p max.	a _e max.	f _z (mm/z) with nom. Ø							
		0.79 - 1.2	1.5 - 1.98	2.0 - 2.5	2.78 - 3.175			0.8	1	1.2	1.5	1.8	2	2.5	3
N1.1.1 Wrought aluminium alloys, non-hardened, 60 HB N1.1.2 Wrought aluminium alloys, hardened, 100 HB	Plunging	170	185	205	225	1xD	1xD	0.0060	0.0070	0.0090	0.0110	0.0160	0.0180	0.0230	0.0270
	Slotting	185	205	225	245	1xD	1xD	0.0090	0.0110	0.0130	0.0160	0.0220	0.0240	0.0300	0.0360
	Roughing	285	300	315	325	2xD	0.25xD	0.0130	0.0160	0.0190	0.0240	0.0320	0.0360	0.0450	0.0540
	Finishing	335	355	370	385	2xD	0.03xD	0.0080	0.0100	0.0120	0.0160	0.0230	0.0260	0.0320	0.0390
N2.1.1 Aluminium casting alloys, non-hardened, ≤ 12 % Si, 75 HB N2.1.2 Aluminium casting alloys, hardened, ≤ 12 % Si, 90 HB	Plunging	170	185	205	225	1xD	1xD	0.0060	0.0070	0.0090	0.0110	0.0160	0.0180	0.0230	0.0270
	Slotting	185	205	225	245	1xD	1xD	0.0090	0.0110	0.0130	0.0160	0.0220	0.0240	0.0300	0.0360
	Roughing	285	300	315	325	2xD	0.25xD	0.0130	0.0160	0.0190	0.0240	0.0320	0.0360	0.0450	0.0540
	Finishing	335	355	370	385	2xD	0.03xD	0.0080	0.0100	0.0120	0.0160	0.0230	0.0260	0.0320	0.0390
N2.1.3 Aluminium casting alloys, non-hardened, > 12 % Si, 130 HB	Plunging	135	150	165	175	1xD	1xD	0.0060	0.0070	0.0090	0.0110	0.0160	0.0180	0.0230	0.0270
	Slotting	150	165	175	190	1xD	1xD	0.0090	0.0110	0.0130	0.0160	0.0220	0.0240	0.0300	0.0360
	Roughing	225	235	245	260	2xD	0.25xD	0.0130	0.0160	0.0190	0.0240	0.0320	0.0360	0.0450	0.0540
	Finishing	265	280	295	305	2xD	0.03xD	0.0080	0.0100	0.0120	0.0160	0.0230	0.0260	0.0320	0.0390
N3.1.1 Copper and copper alloys: Free-machining alloy, Pb > 1 % N3.1.2 Copper and copper alloys: CuZn, CuSnZn	Plunging	160	175	195	210	1xD	1xD	0.0050	0.0060	0.0070	0.0090	0.0140	0.0150	0.0190	0.0230
	Slotting	175	195	210	230	1xD	1xD	0.0070	0.0090	0.0110	0.0140	0.0180	0.0200	0.0250	0.0300
	Roughing	270	280	295	310	2xD	0.25xD	0.0110	0.0140	0.0160	0.0200	0.0270	0.0300	0.0380	0.0450
	Finishing	315	335	350	365	2xD	0.03xD	0.0070	0.0090	0.0100	0.0130	0.0190	0.0220	0.0270	0.0320
N3.1.3 Copper and copper alloys: CuSn, lead-free copper and copper electrolyte	Plunging	125	140	150	165	1xD	1xD	0.0040	0.0060	0.0070	0.0080	0.0120	0.0140	0.0170	0.0210
	Slotting	140	150	165	180	1xD	1xD	0.0070	0.0080	0.0100	0.0120	0.0170	0.0180	0.0230	0.0280
	Roughing	210	220	230	240	2xD	0.25xD	0.0100	0.0120	0.0150	0.0190	0.0250	0.0280	0.0350	0.0410
	Finishing	250	260	275	285	2xD	0.03xD	0.0060	0.0080	0.0100	0.0120	0.0180	0.0200	0.0250	0.0300
S1.1.1 Heat-resistant alloys, Fe-based, annealed, 200 HB	Plunging	50	55	60	65	0.5xD	1xD	0.0030	0.0030	0.0040	0.0050	0.0070	0.0080	0.0100	0.0120
	Slotting	55	60	65	70	0.5xD	1xD	0.0040	0.0050	0.0060	0.0070	0.0100	0.0110	0.0140	0.0170
	Roughing	95	100	105	110	2xD	0.15xD	0.0080	0.0090	0.0110	0.0140	0.0190	0.0210	0.0260	0.0310
	Finishing	100	105	110	115	2xD	0.03xD	0.0040	0.0050	0.0060	0.0070	0.0110	0.0120	0.0150	0.0180
S1.1.2 Heat-resistant alloys, Fe-based, hardened, 280 HB	Plunging	40	45	50	55	0.5xD	1xD	0.0030	0.0030	0.0040	0.0050	0.0070	0.0080	0.0100	0.0120
	Slotting	45	50	55	60	0.5xD	1xD	0.0040	0.0050	0.0060	0.0070	0.0100	0.0110	0.0140	0.0170
	Roughing	80	85	90	90	2xD	0.15xD	0.0080	0.0090	0.0110	0.0140	0.0190	0.0210	0.0260	0.0310
	Finishing	85	90	90	95	2xD	0.03xD	0.0040	0.0050	0.0060	0.0070	0.0110	0.0120	0.0150	0.0180
S1.1.3 Heat-resistant alloys, Ni- or Co-based, annealed, 250 HB	Plunging	30	30	35	40	0.5xD	1xD	0.0020	0.0030	0.0030	0.0040	0.0060	0.0070	0.0080	0.0100
	Slotting	30	35	40	40	0.5xD	1xD	0.0030	0.0040	0.0050	0.0060	0.0080	0.0090	0.0110	0.0130
	Roughing	55	55	60	60	2xD	0.15xD	0.0060	0.0080	0.0090	0.0110	0.0150	0.0170	0.0210	0.0250
	Finishing	55	60	65	65	2xD	0.03xD	0.0030	0.0040	0.0050	0.0060	0.0090	0.0100	0.0120	0.0140
S1.1.4 Heat-resistant alloys, Ni- or Co-based, hardened, 350 HB	Plunging	20	25	25	30	0.5xD	1xD	0.0020	0.0030	0.0030	0.0040	0.0060	0.0060	0.0080	0.0100
	Slotting	25	25	30	30	0.5xD	1xD	0.0030	0.0040	0.0050	0.0060	0.0080	0.0080	0.0110	0.0130
	Roughing	40	40	45	45	2xD	0.15xD	0.0060	0.0070	0.0090	0.0110	0.0140	0.0160	0.0200	0.0240
	Finishing	40	45	45	50	2xD	0.03xD	0.0030	0.0040	0.0040	0.0050	0.0080	0.0090	0.0110	0.0140
S1.1.5 Heat-resistant alloys, Ni- or Co-based, cast, 320 HB	Plunging	25	30	30	35	0.5xD	1xD	0.0020	0.0030	0.0030	0.0040	0.0060	0.0070	0.0080	0.0100
	Slotting	30	30	35	35	0.5xD	1xD	0.0030	0.0040	0.0050	0.0060	0.0080	0.0090	0.0110	0.0130
	Roughing	50	50	50	55	2xD	0.15xD	0.0060	0.0080	0.0090	0.0110	0.0150	0.0170	0.0210	0.0250
	Finishing	50	55	55	60	2xD	0.03xD	0.0030	0.0040	0.0050	0.0060	0.0090	0.0100	0.0120	0.0140
S2.1.1 Titanium alloys, pure titanium, Rm 400 N/mm ²	Plunging	80	90	95	105	0.75xD	1xD	0.0040	0.0050	0.0060	0.0070	0.0110	0.0120	0.0150	0.0180
	Slotting	90	95	105	115	0.75xD	1xD	0.0060	0.0070	0.0090	0.0110	0.0140	0.0160	0.0200	0.0240
	Roughing	140	150	155	165	2xD	0.2xD	0.0090	0.0120	0.0140	0.0170	0.0230	0.0260	0.0320	0.0380
	Finishing	160	165	175	180	2xD	0.03xD	0.0060	0.0070	0.0080	0.0100	0.0160	0.0170	0.0220	0.0260
S2.1.2 Titanium alloys, Alpha and Beta alloys, hardened, Rm 1050 N/mm ²	Plunging	65	75	80	90	0.75xD	1xD	0.0030	0.0040	0.0050	0.0060	0.0100	0.0110	0.0130	0.0160
	Slotting	75	80	90	95	0.75xD	1xD	0.0050	0.0060	0.0080	0.0100	0.0130	0.0140	0.0180	0.0220
	Roughing	120	125	130	140	2xD	0.2xD	0.0080	0.0100	0.0120	0.0160	0.0210	0.0230	0.0290	0.0350
	Finishing	135	140	145	155	2xD	0.03xD	0.0050	0.0060	0.0070	0.0090	0.0140	0.0160	0.0190	0.0230



RF 100 Micro Diver, 5xD

Milling conditions:



stable machining conditions
low cutting depths, high cutting values



extra length tools



see page "GTC milling strategies"

Machining group	Application	v _c (m/min) with nom. Ø				a _p max.	a _e max.	f _z (mm/z) with nom. Ø						
		0.79 - 1.2	1.5 - 1.98	2.0 - 2.5	2.78 - 3.175			1	1.2	1.5	2	2.5	2.8	3
P1.1.1 Unalloyed steel, annealed, 0.15 % C, Rm 420 N/mm ² , 125 HB P1.1.2 Unalloyed steel, heat-treated, 0.15 % C, Rm 420 N/mm ² , 125 HB P1.1.3 Unalloyed steel, annealed, 0.45 % C, Rm 640 N/mm ² , 190 HB P1.1.4 Unalloyed steel, heat-treated, 0.45 % C, Rm 640 N/mm ² , 190 HB P1.1.5 Unalloyed steel, heat-treated, 0.45 % C, Rm 850 N/mm ² , 250 HB P1.1.6 Unalloyed steel, annealed, 0.75 % C, Rm 915 N/mm ² , 270 HB P1.1.7 Unalloyed steel, heat-treated, 0.75 % C, Rm 1020 N/mm ² , 300 HB	Plunging	50	55	60	65	0.5xD	1xD	0.0020	0.0030	0.0040	0.0060	0.0080	0.0090	0.0090
	Slotting	65	75	80	85	0.25xD	1xD	0.0040	0.0050	0.0060	0.0090	0.0110	0.0130	0.0140
	Roughing	145	150	155	165	2.5xD	0.08xD	0.0120	0.0140	0.0170	0.0260	0.0320	0.0360	0.0380
	Finishing	145	150	155	165	5xD	0.02xD	0.0050	0.0060	0.0080	0.0130	0.0160	0.0180	0.0190
P2.1.1 Low-alloy steel, annealed, Rm 610 N/mm ² , 180 HB P2.1.2 Low-alloy steel, heat-treated, Rm 930 N/mm ² , 275 HB P2.1.3 Low-alloy steel, heat-treated, Rm 1020 N/mm ² , 300 HB P2.1.4 Low-alloy steel, heat-treated, Rm 1190 N/mm ² , 350 HB	Plunging	45	50	55	60	0.5xD	1xD	0.0020	0.0030	0.0030	0.0050	0.0070	0.0080	0.0080
	Slotting	60	65	75	80	0.25xD	1xD	0.0040	0.0040	0.0050	0.0080	0.0100	0.0110	0.0120
	Roughing	130	135	145	150	2.5xD	0.08xD	0.0100	0.0120	0.0150	0.0230	0.0290	0.0320	0.0340
	Finishing	130	135	145	150	5xD	0.02xD	0.0050	0.0050	0.0070	0.0110	0.0140	0.0160	0.0170
P3.1.1 High-alloy steel and tool steel, annealed, Rm 680 N/mm ² , 200 HB P3.1.2 High-alloy steel and tool steel, hardened and tempered, Rm 1100 N/mm ² , 325 HB	Plunging	40	45	50	55	0.5xD	1xD	0.0020	0.0020	0.0020	0.0040	0.0050	0.0060	0.0060
	Slotting	55	60	65	70	0.25xD	1xD	0.0030	0.0030	0.0040	0.0060	0.0080	0.0080	0.0090
	Roughing	120	125	130	135	2.5xD	0.08xD	0.0080	0.0090	0.0120	0.0170	0.0210	0.0240	0.0260
	Finishing	120	125	130	135	5xD	0.02xD	0.0030	0.0040	0.0050	0.0090	0.0110	0.0120	0.0130
M1.1.1 Stainless steel, ferritic/martensitic, with machining additives M1.1.2 Stainless steel, ferritic/martensitic, annealed, Rm 680 N/mm ² , 200 HB	Plunging	45	50	55	60	0.5xD	1xD	0.0020	0.0030	0.0030	0.0050	0.0070	0.0080	0.0080
	Slotting	60	65	75	80	0.25xD	1xD	0.0040	0.0040	0.0050	0.0080	0.0100	0.0110	0.0120
	Roughing	130	135	145	150	2.5xD	0.08xD	0.0100	0.0120	0.0150	0.0230	0.0290	0.0320	0.0340
	Finishing	130	135	145	150	5xD	0.02xD	0.0050	0.0050	0.0070	0.0110	0.0140	0.0160	0.0170
M1.1.3 Stainless steel, ferritic/martensitic, heat-treated, Rm 810 N/mm ² , 240 HB	Plunging	30	35	40	45	0.5xD	1xD	0.0020	0.0020	0.0030	0.0050	0.0060	0.0070	0.0070
	Slotting	45	50	55	60	0.25xD	1xD	0.0030	0.0040	0.0050	0.0070	0.0090	0.0100	0.0110
	Roughing	95	100	105	110	2.5xD	0.08xD	0.0090	0.0110	0.0140	0.0210	0.0260	0.0290	0.0310
	Finishing	95	100	105	110	5xD	0.02xD	0.0040	0.0050	0.0060	0.0100	0.0130	0.0140	0.0160
M2.1.1 Stainless steel, austenitic, quenched, 180 HB	Plunging	35	40	45	50	0.5xD	1xD	0.0020	0.0020	0.0030	0.0050	0.0060	0.0070	0.0070
	Slotting	50	55	60	65	0.25xD	1xD	0.0030	0.0040	0.0050	0.0070	0.0090	0.0100	0.0110
	Roughing	105	110	120	125	2.5xD	0.08xD	0.0090	0.0110	0.0130	0.0200	0.0250	0.0280	0.0300
	Finishing	105	110	120	125	5xD	0.02xD	0.0040	0.0050	0.0060	0.0100	0.0130	0.0140	0.0150
M2.2.1 Duplex steel, high-strength stainless steels	Plunging	25	30	30	35	0.5xD	1xD	0.0020	0.0020	0.0020	0.0040	0.0050	0.0060	0.0060
	Slotting	35	40	45	50	0.25xD	1xD	0.0030	0.0030	0.0040	0.0060	0.0080	0.0090	0.0090
	Roughing	85	90	90	95	2.5xD	0.05xD	0.0080	0.0090	0.0120	0.0170	0.0220	0.0240	0.0260
	Finishing	80	85	85	90	5xD	0.02xD	0.0040	0.0040	0.0050	0.0090	0.0110	0.0120	0.0130
K1.1.1 Grey cast iron, pearlitic/ferritic, 180 HB K1.1.2 Grey cast iron, pearlitic/martensitic, 260 HB K1.2.1 Cast iron with spheroidal graphite, ferritic, 160 HB K1.2.2 Cast iron with spheroidal graphite, pearlitic, 250 HB	Plunging	45	50	55	60	0.5xD	1xD	0.0020	0.0020	0.0030	0.0050	0.0060	0.0070	0.0070
	Slotting	60	65	75	80	0.25xD	1xD	0.0030	0.0040	0.0050	0.0070	0.0090	0.0100	0.0110
	Roughing	130	135	145	150	2.5xD	0.08xD	0.0090	0.0110	0.0130	0.0200	0.0250	0.0280	0.0300
	Finishing	130	135	145	150	5xD	0.02xD	0.0040	0.0050	0.0060	0.0100	0.0130	0.0140	0.0150



Machining group	Application	v _c (m/min) with nom. Ø				a _p max.	a _e max.	f _z (mm/z) with nom. Ø						
		0.79 - 1.2	1.5 - 1.98	2.0 - 2.5	2.78 - 3.175			1	1.2	1.5	2	2.5	2.8	3
N1.1.1 Wrought aluminium alloys, non-hardened, 60 HB N1.1.2 Wrought aluminium alloys, hardened, 100 HB	Plunging	65	75	80	90	0.5xD	1xD	0.0030	0.0040	0.0050	0.0080	0.0100	0.0110	0.0120
	Slotting	95	105	110	120	0.25xD	1xD	0.0050	0.0060	0.0080	0.0120	0.0150	0.0170	0.0180
	Roughing	190	200	210	220	2.5xD	0.1xD	0.0140	0.0170	0.0210	0.0310	0.0390	0.0440	0.0470
	Finishing	200	210	220	230	5xD	0.02xD	0.0070	0.0080	0.0100	0.0170	0.0210	0.0240	0.0260
N2.1.1 Aluminium casting alloys, non-hardened, ≤ 12 % Si, 75 HB N2.1.2 Aluminium casting alloys, hardened, ≤ 12 % Si, 90 HB	Plunging	65	75	80	90	0.5xD	1xD	0.0030	0.0040	0.0050	0.0080	0.0100	0.0110	0.0120
	Slotting	95	105	110	120	0.25xD	1xD	0.0050	0.0060	0.0080	0.0120	0.0150	0.0170	0.0180
	Roughing	190	200	210	220	2.5xD	0.1xD	0.0140	0.0170	0.0210	0.0310	0.0390	0.0440	0.0470
	Finishing	200	210	220	230	5xD	0.02xD	0.0070	0.0080	0.0100	0.0170	0.0210	0.0240	0.0260
N2.1.3 Aluminium casting alloys, non-hardened, > 12 % Si, 130 HB	Plunging	55	60	65	70	0.5xD	1xD	0.0030	0.0040	0.0050	0.0080	0.0100	0.0110	0.0120
	Slotting	75	80	90	95	0.25xD	1xD	0.0050	0.0060	0.0080	0.0120	0.0150	0.0170	0.0180
	Roughing	150	160	165	175	2.5xD	0.1xD	0.0140	0.0170	0.0210	0.0310	0.0390	0.0440	0.0470
	Finishing	160	170	175	185	5xD	0.02xD	0.0070	0.0080	0.0100	0.0170	0.0210	0.0240	0.0260
N3.1.1 Copper and copper alloys: Free-machining alloy, Pb > 1 % N3.1.2 Copper and copper alloys: CuZn, CuSnZn	Plunging	65	70	75	85	0.5xD	1xD	0.0030	0.0030	0.0040	0.0070	0.0080	0.0090	0.0100
	Slotting	90	95	105	115	0.25xD	1xD	0.0050	0.0050	0.0070	0.0100	0.0130	0.0140	0.0150
	Roughing	180	190	200	210	2.5xD	0.1xD	0.0120	0.0140	0.0180	0.0260	0.0330	0.0370	0.0390
	Finishing	190	200	210	220	5xD	0.02xD	0.0060	0.0070	0.0090	0.0140	0.0180	0.0200	0.0210
N3.1.3 Copper and copper alloys: CuSn, lead-free copper and copper electrolyte	Plunging	50	55	60	65	0.5xD	1xD	0.0020	0.0030	0.0040	0.0060	0.0080	0.0090	0.0090
	Slotting	70	75	85	90	0.25xD	1xD	0.0040	0.0050	0.0060	0.0090	0.0120	0.0130	0.0140
	Roughing	140	150	155	165	2.5xD	0.1xD	0.0110	0.0130	0.0160	0.0240	0.0300	0.0340	0.0360
	Finishing	150	155	165	170	5xD	0.02xD	0.0050	0.0060	0.0080	0.0130	0.0160	0.0180	0.0200
S1.1.1 Heat-resistant alloys, Fe-based, annealed, 200 HB	Plunging	20	20	25	25	0.5xD	1xD	0.0010	0.0020	0.0020	0.0040	0.0050	0.0050	0.0060
	Slotting	30	30	35	35	0.25xD	1xD	0.0020	0.0030	0.0040	0.0060	0.0070	0.0080	0.0080
	Roughing	60	60	65	70	2.5xD	0.08xD	0.0070	0.0080	0.0110	0.0160	0.0200	0.0220	0.0240
	Finishing	60	60	65	70	5xD	0.02xD	0.0030	0.0040	0.0050	0.0080	0.0100	0.0110	0.0120
S1.1.2 Heat-resistant alloys, Fe-based, hardened, 280 HB	Plunging	15	20	20	20	0.5xD	1xD	0.0010	0.0020	0.0020	0.0040	0.0050	0.0050	0.0060
	Slotting	25	25	30	30	0.25xD	1xD	0.0020	0.0030	0.0040	0.0060	0.0070	0.0080	0.0080
	Roughing	55	55	60	60	2.5xD	0.05xD	0.0070	0.0080	0.0110	0.0160	0.0200	0.0220	0.0240
	Finishing	50	55	55	60	5xD	0.02xD	0.0030	0.0040	0.0050	0.0080	0.0100	0.0110	0.0120
S1.1.3 Heat-resistant alloys, Ni- or Co-based, annealed, 250 HB	Plunging	10	15	15	15	0.5xD	1xD	0.0010	0.0010	0.0020	0.0030	0.0040	0.0040	0.0050
	Slotting	15	15	20	20	0.25xD	1xD	0.0020	0.0020	0.0030	0.0040	0.0060	0.0060	0.0070
	Roughing	35	40	40	40	2.5xD	0.05xD	0.0060	0.0070	0.0090	0.0130	0.0160	0.0180	0.0190
	Finishing	35	35	40	40	5xD	0.02xD	0.0030	0.0030	0.0040	0.0060	0.0080	0.0090	0.0100
S1.1.4 Heat-resistant alloys, Ni- or Co-based, hardened, 350 HB	Plunging	10	10	10	10	0.5xD	1xD	0.0010	0.0010	0.0020	0.0030	0.0040	0.0040	0.0040
	Slotting	10	15	15	15	0.25xD	1xD	0.0020	0.0020	0.0030	0.0040	0.0050	0.0060	0.0060
	Roughing	25	30	30	30	2.5xD	0.05xD	0.0050	0.0070	0.0080	0.0120	0.0150	0.0170	0.0180
	Finishing	25	25	30	30	5xD	0.02xD	0.0020	0.0030	0.0040	0.0060	0.0080	0.0080	0.0090
S1.1.5 Heat-resistant alloys, Ni- or Co-based, cast, 320 HB	Plunging	10	10	10	15	0.5xD	1xD	0.0010	0.0010	0.0020	0.0030	0.0040	0.0040	0.0050
	Slotting	15	15	15	20	0.25xD	1xD	0.0020	0.0020	0.0030	0.0040	0.0060	0.0060	0.0070
	Roughing	30	35	35	35	2.5xD	0.05xD	0.0060	0.0070	0.0090	0.0130	0.0160	0.0180	0.0190
	Finishing	30	30	35	35	5xD	0.02xD	0.0030	0.0030	0.0040	0.0060	0.0080	0.0090	0.0100
S2.1.1 Titanium alloys, pure titanium, Rm 400 N/mm ²	Plunging	30	35	40	40	0.5xD	1xD	0.0020	0.0030	0.0030	0.0050	0.0070	0.0080	0.0080
	Slotting	45	50	55	55	0.25xD	1xD	0.0040	0.0040	0.0050	0.0080	0.0100	0.0110	0.0120
	Roughing	95	100	105	110	2.5xD	0.08xD	0.0100	0.0120	0.0150	0.0230	0.0290	0.0320	0.0340
	Finishing	95	100	105	110	5xD	0.02xD	0.0050	0.0050	0.0070	0.0110	0.0140	0.0160	0.0170
S2.1.2 Titanium alloys, Alpha and Beta alloys, hardened, Rm 1050 N/mm ²	Plunging	25	30	35	35	0.5xD	1xD	0.0020	0.0020	0.0030	0.0050	0.0060	0.0070	0.0070
	Slotting	35	40	45	50	0.25xD	1xD	0.0030	0.0040	0.0050	0.0070	0.0090	0.0100	0.0110
	Roughing	80	85	90	90	2.5xD	0.08xD	0.0090	0.0110	0.0140	0.0200	0.0260	0.0290	0.0310
	Finishing	80	85	90	90	5xD	0.02xD	0.0040	0.0050	0.0060	0.0100	0.0130	0.0140	0.0150



RF 100 A for stable conditions

Milling conditions:

HPC	stable machining conditions high drive power
	short tools
	long tools

Correction factors:

	a_p roughing > 1.5xD	v_c -25 %	f_z -25 %
	medium length tools	v_c -40 %	f_z -40 %
	extra length tools	v_c -60 %	f_z -55 %



Cutting data

Machining group	Application	v_c (m/min)	a_e max.	f_z (mm/z) with nom. \emptyset								
				3	4	6	8	10	12	16	20	25
N1.1.1 Wrought aluminium alloys, non-hardened, 60 HB N1.1.2 Wrought aluminium alloys, hardened, 100 HB	Slotting	500	1xD	0.021	0.030	0.040	0.055	0.080	0.095	0.130	0.160	0.200
	Roughing	575	0.75xD	0.028	0.035	0.055	0.075	0.090	0.110	0.145	0.185	0.230
	Finishing	1000	0.02xD	0.026	0.035	0.055	0.070	0.090	0.105	0.140	0.175	0.220
N2.1.1 Aluminium casting alloys, non-hardened, $\leq 12\%$ Si, 75 HB N2.1.2 Aluminium casting alloys, hardened, $\leq 12\%$ Si, 90 HB	Slotting	230	1xD	0.016	0.020	0.030	0.040	0.060	0.070	0.095	0.120	0.150
	Roughing	265	0.75xD	0.021	0.030	0.040	0.055	0.070	0.085	0.110	0.140	0.175
	Finishing	460	0.02xD	0.020	0.025	0.040	0.055	0.065	0.080	0.105	0.130	0.165
N2.1.3 Aluminium casting alloys, non-hardened, > 12% Si, 130 HB	Slotting	180	1xD	0.016	0.020	0.030	0.040	0.060	0.070	0.095	0.120	0.150
	Roughing	180	0.75xD	0.018	0.025	0.035	0.050	0.060	0.070	0.095	0.120	0.150
	Finishing	365	0.02xD	0.020	0.025	0.040	0.055	0.065	0.080	0.105	0.130	0.165
N3.1.1 Copper and copper alloys: Free-machining alloy, Pb > 1 % N3.1.2 Copper and copper alloys: CuZn, CuSnZn	Slotting	250	1xD	0.016	0.020	0.030	0.040	0.060	0.070	0.095	0.120	0.150
	Roughing	290	0.75xD	0.021	0.030	0.040	0.055	0.070	0.085	0.110	0.140	0.175
	Finishing	500	0.02xD	0.020	0.025	0.040	0.055	0.065	0.080	0.105	0.130	0.165
N3.1.3 Copper and copper alloys: CuSn, lead-free copper and copper electrolyte	Slotting	195	1xD	0.015	0.020	0.030	0.040	0.055	0.065	0.090	0.110	0.140
	Roughing	225	0.75xD	0.019	0.025	0.040	0.050	0.065	0.075	0.100	0.125	0.160
	Finishing	390	0.02xD	0.018	0.025	0.035	0.050	0.060	0.075	0.095	0.120	0.150
01.1.1 Thermoplastics	Slotting	150	1xD	0.017	0.020	0.035	0.045	0.065	0.075	0.100	0.125	0.155
	Roughing	225	0.33xD	0.024	0.035	0.050	0.065	0.080	0.100	0.130	0.165	0.205
	Finishing	300	0.01xD	0.019	0.025	0.040	0.050	0.065	0.075	0.100	0.125	0.155
01.1.3 Duroplastics	Slotting	105	1xD	0.017	0.020	0.035	0.045	0.065	0.075	0.100	0.125	0.155
	Roughing	160	0.33xD	0.024	0.035	0.050	0.065	0.080	0.100	0.130	0.165	0.205
	Finishing	210	0.01xD	0.019	0.025	0.040	0.050	0.065	0.075	0.100	0.125	0.155
01.1.5 Acrylic glass / Plexiglass / PMMA	Slotting	120	1xD	0.017	0.020	0.035	0.045	0.065	0.075	0.100	0.125	0.155
	Roughing	180	0.33xD	0.024	0.035	0.050	0.065	0.080	0.100	0.130	0.165	0.205
	Finishing	240	0.01xD	0.019	0.025	0.040	0.050	0.065	0.075	0.100	0.125	0.155



RF 100 A for unstable conditions

Milling conditions:

MTC unstable machining conditions
low drive power

lange Werkzeuge

Correction factors:

a_p roughing > 1.5xD v_c -25 % f_z -25 %

medium length tools v_c -40 % f_z -40 %

extra length tools v_c -60 % f_z -55 %

uncoated tools v_c -50 % f_z -25 %

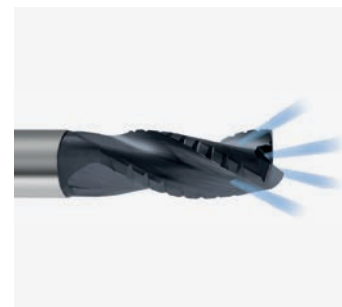

Cutting data

Machining group	Application	v_c (m/min)	a_p max.	a_e max.	f_z (mm/z) with nom. Ø								
					3	4	6	8	10	12	16	20	25
N1.1.1 Wrought aluminium alloys, non-hardened, 60 HB N1.1.2 Wrought aluminium alloys, hardened, 100 HB	Slotting	375	1xD	1xD	0.010	0.015	0.020	0.025	0.035	0.045	0.060	0.075	0.095
	Roughing	430	1xD	0.75xD	0.013	0.015	0.025	0.035	0.045	0.050	0.070	0.085	0.105
N2.1.1 Aluminium casting alloys, non-hardened, ≤ 12 % Si, 75 HB N2.1.2 Aluminium casting alloys, hardened, ≤ 12 % Si, 90 HB	Slotting	200	1xD	1xD	0.009	0.010	0.020	0.025	0.035	0.040	0.055	0.070	0.090
	Roughing	230	1xD	0.75xD	0.012	0.015	0.025	0.030	0.040	0.050	0.065	0.080	0.100
N2.1.3 Aluminium casting alloys, non-hardened, > 12 % Si, 130 HB	Slotting	160	1xD	1xD	0.009	0.010	0.020	0.025	0.035	0.040	0.055	0.070	0.090
	Roughing	160	1xD	0.75xD	0.011	0.015	0.020	0.030	0.035	0.040	0.055	0.070	0.090
N3.1.1 Copper and copper alloys: Free-machining alloy, Pb > 1 % N3.1.2 Copper and copper alloys: CuZn, CuSnZn	Slotting	220	1xD	1xD	0.009	0.010	0.020	0.025	0.035	0.040	0.055	0.070	0.090
	Roughing	255	1xD	0.75xD	0.012	0.015	0.025	0.030	0.040	0.050	0.065	0.080	0.100
N3.1.3 Copper and copper alloys: CuSn, lead-free copper and copper electrolyte	Slotting	170	1xD	1xD	0.009	0.010	0.015	0.025	0.030	0.040	0.050	0.065	0.080
	Roughing	200	1xD	0.75xD	0.011	0.015	0.020	0.030	0.035	0.045	0.060	0.075	0.095
01.1.1 Thermoplastics	Slotting	110	1xD	1xD	0.009	0.010	0.015	0.025	0.035	0.040	0.055	0.065	0.085
	Roughing	170	1xD	0.33xD	0.013	0.015	0.025	0.035	0.045	0.050	0.070	0.085	0.105
01.1.3 Duroplastics	Slotting	80	1xD	1xD	0.009	0.010	0.015	0.025	0.035	0.040	0.055	0.065	0.085
	Roughing	120	1xD	0.33xD	0.013	0.015	0.025	0.035	0.045	0.050	0.070	0.085	0.105
01.1.5 Acrylic glass / Plexiglass / PMMA	Slotting	90	1xD	1xD	0.009	0.010	0.015	0.025	0.035	0.040	0.055	0.065	0.085
	Roughing	135	1xD	0.33xD	0.013	0.015	0.025	0.035	0.045	0.050	0.070	0.085	0.105



Diamond-coated milling cutters for fibre-reinforced plastics and graphite

Milling conditions:

HPC	stable machining conditions high drive power
	short tools
	long tools

Correction factors:

	a_p roughing > 1.5xD	v_c -25 %	f_z -25 %
	medium length tools	v_c -40 %	f_z -40 %
	extra length tools	v_c -60 %	f_z -55 %
	uncoated tools	v_c -50 %	f_z -25 %





Cutting data

Machining group	Application	v_c (m/min)	a_p max.	a_e max.	f_z (mm/z) with nom. \emptyset							
					3	4	6	8	10	12	16	20
N1.1.1 Wrought aluminium alloys, non-hardened, 60 HB N1.1.2 Wrought aluminium alloys, hardened, 100 HB	Slotting	450	1xD	1xD	0.021	0.030	0.045	0.055	0.080	0.100	0.130	0.165
	Roughing	520	1xD	0.75xD	0.028	0.035	0.055	0.075	0.095	0.110	0.150	0.185
	Finishing	900	1xD	0.02xD	0.027	0.035	0.055	0.070	0.090	0.105	0.145	0.180
N2.1.1 Aluminium casting alloys, non-hardened, $\leq 12\%$ Si, 75 HB N2.1.2 Aluminium casting alloys, hardened, $\leq 12\%$ Si, 90 HB	Slotting	240	1xD	1xD	0.018	0.025	0.035	0.050	0.070	0.085	0.110	0.140
	Roughing	275	1xD	0.75xD	0.024	0.030	0.050	0.065	0.080	0.095	0.130	0.160
	Finishing	480	1xD	0.02xD	0.023	0.030	0.045	0.060	0.075	0.090	0.125	0.155
N2.1.3 Aluminium casting alloys, non-hardened, $> 12\%$ Si, 130 HB	Slotting	190	1xD	1xD	0.018	0.025	0.035	0.050	0.070	0.085	0.110	0.140
	Roughing	190	1xD	0.75xD	0.021	0.030	0.040	0.055	0.070	0.085	0.110	0.140
	Finishing	380	1xD	0.02xD	0.023	0.030	0.045	0.060	0.075	0.090	0.125	0.155
N3.1.1 Copper and copper alloys: Free-machining alloy, Pb > 1 % N3.1.2 Copper and copper alloys: CuZn, CuSnZn	Slotting	300	1xD	1xD	0.015	0.020	0.030	0.040	0.060	0.070	0.090	0.115
	Roughing	345	1xD	0.75xD	0.020	0.025	0.040	0.055	0.065	0.080	0.105	0.130
	Finishing	600	1xD	0.02xD	0.019	0.025	0.040	0.050	0.065	0.075	0.100	0.125
N3.1.3 Copper and copper alloys: CuSn, lead-free copper and copper electrolyte	Slotting	235	1xD	1xD	0.014	0.020	0.030	0.035	0.055	0.065	0.085	0.105
	Roughing	270	1xD	0.75xD	0.018	0.025	0.035	0.050	0.060	0.075	0.095	0.120
	Finishing	470	1xD	0.02xD	0.017	0.025	0.035	0.045	0.060	0.070	0.095	0.115
01.2.1 Carbon-fibre-reinforced thermoplastics	Slotting	400	1xD	1xD	0.016	0.020	0.030	0.040	0.060	0.070	0.095	0.120
01.2.2 Carbon-fibre-reinforced elastomers	Slotting	495	1xD	1xD	0.013	0.020	0.025	0.035	0.050	0.060	0.080	0.100
01.2.3 Carbon-fibre-reinforced duroplastics	Slotting	400	1xD	1xD	0.016	0.020	0.030	0.040	0.060	0.070	0.095	0.120
01.2.4 Glass-fibre-reinforced thermoplastics	Slotting	200	1xD	1xD	0.020	0.025	0.040	0.055	0.075	0.090	0.120	0.150
01.2.5 Glass-fibre-reinforced elastomers	Slotting	495	1xD	1xD	0.013	0.020	0.025	0.035	0.050	0.060	0.080	0.100
01.2.6 Glass-fibre-reinforced duroplastics	Slotting	200	1xD	1xD	0.016	0.020	0.030	0.040	0.060	0.070	0.095	0.120
01.2.7 Natural-fibre-reinforced thermoplastics	Slotting	250	1xD	1xD	0.020	0.025	0.040	0.055	0.075	0.090	0.120	0.150
01.2.8 Natural-fibre-reinforced duroplastics	Slotting	250	1xD	1xD	0.020	0.025	0.040	0.055	0.075	0.090	0.120	0.150
01.2.9 Aramid/Kevlar-fibre-reinforced thermoplastics	Slotting	250	1xD	1xD	0.020	0.025	0.040	0.055	0.075	0.090	0.120	0.150
01.2.11 Aramid/Kevlar-fibre-reinforced duroplastics	Slotting	250	1xD	1xD	0.020	0.025	0.040	0.055	0.075	0.090	0.120	0.150
01.2.12 Synthetic-fibre-reinforced thermoplastics	Slotting	225	1xD	1xD	0.016	0.020	0.030	0.040	0.060	0.070	0.095	0.120
01.2.14 Synthetic-fibre-reinforced duroplastics	Slotting	150	1xD	1xD	0.016	0.020	0.030	0.040	0.060	0.070	0.095	0.120
01.4.1 Graphite	Slotting	265	1xD	1xD	0.026	0.035	0.055	0.070	0.100	0.120	0.160	0.200
	Copying	370	0.05xD	0.2xD	0.033	0.045	0.065	0.090	0.110	0.130	0.175	0.220





G-Mold 65 HF

Milling conditions:

	stable machining conditions low cutting depths, high cutting values
	long tools

Correction factors:

	medium length tools	v_c -25 % a_p -20 % f_z -25 %
	extra length tools	v_c -50 % a_p -50 % f_z -50 %

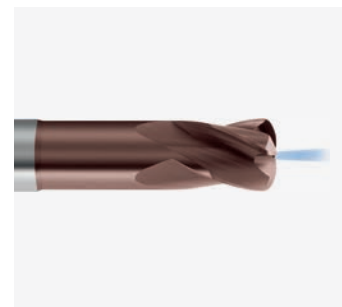

Cutting data

Machining group	Application Copy milling	v_c (m/min)	a_e max.	f_z (mm/z) with nom. \emptyset										
				1	2	3	4	6	8	10	12	16		
P2.1.1 Low-alloy steel, annealed, Rm 610 N/mm ² , 180 HB P2.1.2 Low-alloy steel, heat-treated, Rm 930 N/mm ² , 275 HB P2.1.3 Low-alloy steel, heat-treated, Rm 1020 N/mm ² , 300 HB P2.1.4 Low-alloy steel, heat-treated, Rm 1190 N/mm ² , 350 HB	Slotting	285	1xD	0.031	0.062	0.092	0.125	0.185	0.245	0.350	0.420	0.560		
	Roughing	275	0.6xD	0.042	0.084	0.126	0.170	0.250	0.335	0.420	0.505	0.670		
	(Pre-)Finishing	285	0.4xD	0.035	0.070	0.105	0.140	0.210	0.280	0.350	0.420	0.560		
P3.1.1 High-alloy steel and tool steel, annealed, Rm 680 N/mm ² , 200 HB P3.1.2 High-alloy steel and tool steel, hardened and tempered, Rm 1100 N/mm ² , 325 HB	Slotting	255	1xD	0.026	0.053	0.079	0.105	0.160	0.210	0.300	0.360	0.480		
	Roughing	245	0.6xD	0.036	0.072	0.108	0.145	0.215	0.290	0.360	0.430	0.575		
	(Pre-)Finishing	255	0.4xD	0.030	0.060	0.090	0.120	0.180	0.240	0.300	0.360	0.480		
M1.1.3 Stainless steel, ferritic/martensitic, heat-treated, Rm 810 N/mm ² , 240 HB	Slotting	150	1xD	0.028	0.056	0.084	0.110	0.165	0.225	0.315	0.380	0.505		
	Roughing	145	0.4xD	0.040	0.079	0.119	0.160	0.235	0.315	0.395	0.475	0.635		
	(Pre-)Finishing	150	0.3xD	0.032	0.063	0.095	0.125	0.190	0.255	0.315	0.380	0.505		
M2.1.1 Stainless steel, austenitic, quenched, 180 HB	Slotting	150	1xD	0.026	0.053	0.079	0.105	0.160	0.210	0.300	0.360	0.480		
	Roughing	135	0.4xD	0.037	0.075	0.112	0.150	0.225	0.300	0.375	0.450	0.600		
	(Pre-)Finishing	135	0.3xD	0.030	0.060	0.090	0.120	0.180	0.240	0.300	0.360	0.480		
M2.2.1 Duplex steel, high-strength stainless steels	Slotting	115	1xD	0.023	0.046	0.069	0.090	0.140	0.185	0.260	0.315	0.420		
	Roughing	100	0.4xD	0.033	0.066	0.098	0.130	0.195	0.260	0.330	0.395	0.525		
	(Pre-)Finishing	100	0.3xD	0.026	0.052	0.079	0.105	0.155	0.210	0.260	0.315	0.420		
S1.1.2 Heat-resistant alloys, Fe-based, hardened, 280 HB	Slotting	60	1xD	0.016	0.032	0.047	0.065	0.095	0.125	0.180	0.215	0.290		
	Roughing	55	0.3xD	0.023	0.047	0.070	0.095	0.140	0.185	0.235	0.280	0.375		
	(Pre-)Finishing	55	0.2xD	0.020	0.040	0.059	0.080	0.120	0.160	0.200	0.235	0.315		
S1.1.4 Heat-resistant alloys, Ni- or Co-based, hardened, 350 HB	Slotting	30	1xD	0.012	0.024	0.037	0.050	0.075	0.095	0.140	0.165	0.220		
	Roughing	25	0.3xD	0.018	0.036	0.054	0.070	0.110	0.145	0.180	0.215	0.290		
	(Pre-)Finishing	25	0.2xD	0.015	0.030	0.046	0.060	0.090	0.120	0.150	0.185	0.245		
S2.1.2 Titanium alloys, Alpha and Beta alloys, hardened, Rm 1050 N/mm ²	Slotting	85	1xD	0.022	0.045	0.067	0.090	0.135	0.180	0.255	0.305	0.410		
	Roughing	75	0.4xD	0.032	0.064	0.096	0.130	0.190	0.255	0.320	0.385	0.510		
	(Pre-)Finishing	75	0.3xD	0.026	0.051	0.077	0.100	0.155	0.205	0.255	0.305	0.410		
H1.1.1 Hardened steel, hardened and tempered, < 55 HRC	Slotting	235	1xD	0.019	0.039	0.058	0.075	0.115	0.155	0.220	0.265	0.350		
	Roughing	205	0.4xD	0.027	0.055	0.082	0.110	0.165	0.220	0.275	0.330	0.440		
	(Pre-)Finishing	205	0.3xD	0.022	0.044	0.066	0.090	0.130	0.175	0.220	0.265	0.350		
H1.1.2 Hardened steel, hardened and tempered, < 60 HRC	Slotting	175	1xD	0.016	0.033	0.049	0.065	0.100	0.130	0.185	0.225	0.300		
	Roughing	155	0.3xD	0.024	0.049	0.073	0.095	0.145	0.195	0.245	0.290	0.390		
	(Pre-)Finishing	155	0.2xD	0.021	0.041	0.062	0.080	0.125	0.165	0.205	0.245	0.330		
H1.1.3 Hardened steel, hardened and tempered, > 60 HRC	Slotting	140	1xD	0.015	0.029	0.044	0.060	0.085	0.115	0.165	0.200	0.265		
	Roughing	125	0.3xD	0.021	0.043	0.064	0.085	0.130	0.170	0.215	0.255	0.345		
	(Pre-)Finishing	125	0.2xD	0.018	0.036	0.054	0.075	0.110	0.145	0.180	0.220	0.290		

Material	Hardness	a_p max. (mm) with nom. \emptyset										
		1	2	3	4	6	8	10	12	16		
P	less than 850 N/mm ²	0.06	0.12	0.18	0.24	0.36	0.48	0.60	0.72	0.96		
	more than 850 N/mm ²	0.05	0.10	0.15	0.20	0.30	0.40	0.50	0.60	0.80		
M	less than 850 N/mm ²	0.04	0.08	0.12	0.16	0.24	0.32	0.40	0.48	0.64		
	more than 850 N/mm ²	0.03	0.07	0.10	0.12	0.18	0.24	0.30	0.36	0.48		
K	less than 240 HB	0.06	0.12	0.18	0.24	0.36	0.48	0.60	0.72	0.96		
	more than 240 HB	0.05	0.10	0.15	0.20	0.30	0.40	0.50	0.60	0.80		
S	Ti alloys	0.03	0.07	0.10	0.12	0.18	0.24	0.30	0.36	0.48		
H	less than 55 HRC	0.04	0.08	0.12	0.16	0.24	0.32	0.40	0.48	0.64		
	55-65 HRC	0.03	0.07	0.10	0.12	0.18	0.24	0.30	0.36	0.48		



G-Mold 55 B, G-Mold 65 B, GA 200 A, GF 200

Milling conditions:

	stable machining conditions low cutting depths, high cutting values
	short tools
	long tools

Correction factors:

	medium length tools	v_c -25 %	f_z -25 %
	extra length tools	v_c -50 %	f_z -50 %
	uncoated tools	v_c -60 %	f_z -25 %

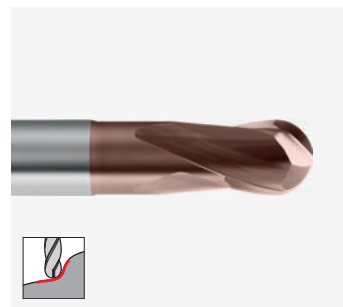

Cutting data

Machining group	Application Copy milling	v_c (m/min)	a_p max.	a_e max.	f_z (mm/z) with nom. \emptyset								
					0.5	1	2	3	4	6	8	10	12
P1.1.1 Unalloyed steel, annealed, 0.15 % C, Rm 420 N/mm ² , 125 HB P1.1.2 Unalloyed steel, heat-treated, 0.15 % C, Rm 420 N/mm ² , 125 HB P1.1.3 Unalloyed steel, annealed, 0.45 % C, Rm 640 N/mm ² , 190 HB P1.1.4 Unalloyed steel, heat-treated, 0.45 % C, Rm 640 N/mm ² , 190 HB P1.1.5 Unalloyed steel, heat-treated, 0.45 % C, Rm 850 N/mm ² , 250 HB P1.1.6 Unalloyed steel, annealed, 0.75 % C, Rm 915 N/mm ² , 270 HB P1.1.7 Unalloyed steel, heat-treated, 0.75 % C, Rm 1020 N/mm ² , 300 HB	Roughing	315	0.1xD	0.3xD	0.010	0.019	0.039	0.058	0.080	0.115	0.155	0.195	0.235
	(Pre-)Finishing	305	0.05xD	0.1xD	0.012	0.024	0.048	0.072	0.095	0.145	0.190	0.240	0.290
	Fine finishing	315	0.01xD	0.02xD	0.010	0.021	0.042	0.063	0.085	0.125	0.170	0.210	0.250
P2.1.1 Low-alloy steel, annealed, Rm 610 N/mm ² , 180 HB P2.1.2 Low-alloy steel, heat-treated, Rm 930 N/mm ² , 275 HB P2.1.3 Low-alloy steel, heat-treated, Rm 1020 N/mm ² , 300 HB P2.1.4 Low-alloy steel, heat-treated, Rm 1190 N/mm ² , 350 HB	Roughing	285	0.1xD	0.3xD	0.010	0.019	0.039	0.058	0.080	0.115	0.155	0.195	0.235
	(Pre-)Finishing	275	0.05xD	0.1xD	0.012	0.024	0.048	0.072	0.095	0.145	0.190	0.240	0.290
	Fine finishing	285	0.01xD	0.02xD	0.010	0.021	0.042	0.063	0.085	0.125	0.170	0.210	0.250
P3.1.1 High-alloy steel and tool steel, annealed, Rm 680 N/mm ² , 200 HB P3.1.2 High-alloy steel and tool steel, hardened and tempered, Rm 1100 N/mm ² , 325 HB	Roughing	255	0.1xD	0.3xD	0.008	0.016	0.031	0.047	0.060	0.095	0.125	0.155	0.185
	(Pre-)Finishing	245	0.05xD	0.1xD	0.010	0.019	0.038	0.058	0.075	0.115	0.155	0.190	0.230
	Fine finishing	255	0.01xD	0.02xD	0.008	0.017	0.034	0.050	0.065	0.100	0.135	0.170	0.200
M1.1.1 Stainless steel, ferritic/martensitic, with machining additives M1.1.2 Stainless steel, ferritic/martensitic, annealed, Rm 680 N/mm ² , 200 HB	Roughing	200	0.1xD	0.3xD	0.009	0.018	0.035	0.053	0.070	0.105	0.140	0.175	0.210
	(Pre-)Finishing	195	0.05xD	0.1xD	0.011	0.022	0.043	0.065	0.085	0.130	0.175	0.215	0.260
	Fine finishing	200	0.01xD	0.02xD	0.009	0.019	0.038	0.057	0.075	0.115	0.150	0.190	0.225
M1.1.3 Stainless steel, ferritic/martensitic, heat-treated, Rm 810 N/mm ² , 240 HB	Roughing	150	0.1xD	0.3xD	0.008	0.016	0.032	0.048	0.065	0.095	0.125	0.160	0.190
	(Pre-)Finishing	145	0.05xD	0.1xD	0.010	0.020	0.039	0.059	0.080	0.115	0.155	0.195	0.235
	Fine finishing	150	0.01xD	0.02xD	0.009	0.017	0.034	0.051	0.070	0.105	0.135	0.170	0.205
M2.1.1 Stainless steel, austenitic, quenched, 180 HB	Roughing	150	0.06xD	0.2xD	0.010	0.019	0.038	0.058	0.075	0.115	0.155	0.190	0.230
	(Pre-)Finishing	135	0.02xD	0.05xD	0.010	0.019	0.038	0.058	0.075	0.115	0.155	0.190	0.230
	Fine finishing	135	0.01xD	0.02xD	0.008	0.017	0.034	0.050	0.065	0.100	0.135	0.170	0.200
M2.2.1 Duplex steel, high-strength stainless steels	Roughing	115	0.06xD	0.2xD	0.008	0.017	0.034	0.050	0.065	0.100	0.135	0.170	0.200
	(Pre-)Finishing	100	0.02xD	0.05xD	0.008	0.017	0.034	0.050	0.065	0.100	0.135	0.170	0.200
	Fine finishing	100	0.01xD	0.02xD	0.007	0.015	0.029	0.044	0.060	0.090	0.115	0.145	0.175
K1.1.1 Grey cast iron, pearlitic/ferritic, 180 HB K1.1.2 Grey cast iron, pearlitic/martensitic, 260 HB K1.2.1 Cast iron with spheroidal graphite, ferritic, 160 HB K1.2.2 Cast iron with spheroidal graphite, pearlitic, 250 HB	Roughing	285	0.1xD	0.3xD	0.010	0.019	0.039	0.058	0.080	0.115	0.155	0.195	0.235
	(Pre-)Finishing	275	0.05xD	0.1xD	0.012	0.024	0.048	0.072	0.095	0.145	0.190	0.240	0.290
	Fine finishing	285	0.01xD	0.02xD	0.010	0.021	0.042	0.063	0.085	0.125	0.170	0.210	0.250
K1.3.1 Malleable cast iron, ferritic, 130 HB K1.3.2 Malleable cast iron, pearlitic, 230 HB	Roughing	235	0.1xD	0.3xD	0.009	0.017	0.035	0.052	0.070	0.105	0.140	0.175	0.210
	(Pre-)Finishing	230	0.05xD	0.1xD	0.011	0.021	0.043	0.064	0.085	0.130	0.170	0.215	0.255
	Fine finishing	235	0.01xD	0.02xD	0.009	0.019	0.037	0.056	0.075	0.110	0.150	0.185	0.225
K2.1.1 Vermicular graphite cast iron (GJV) K2.2.1 Austenitic-ferritic spheroidal graphite cast iron (ADI)	Roughing	185	0.1xD	0.3xD	0.008	0.015	0.030	0.046	0.060	0.090	0.120	0.150	0.180
	(Pre-)Finishing	180	0.05xD	0.1xD	0.009	0.019	0.037	0.056	0.075	0.110	0.150	0.185	0.225
	Fine finishing	185	0.01xD	0.02xD	0.008	0.016	0.033	0.049	0.065	0.100	0.130	0.165	0.195
N1.1.1 Wrought aluminium alloys, non-hardened, 60 HB N1.1.2 Wrought aluminium alloys, hardened, 100 HB	Roughing	895	0.1xD	0.3xD	0.011	0.021	0.043	0.064	0.085	0.130	0.170	0.215	0.255
	(Pre-)Finishing	865	0.05xD	0.1xD	0.013	0.026	0.053	0.079	0.105	0.160	0.210	0.265	0.315
	Fine finishing	895	0.01xD	0.02xD	0.012	0.023	0.046	0.069	0.090	0.140	0.185	0.230	0.275
N2.1.1 Aluminium casting alloys, non-hardened, \leq 12 % Si, 75 HB N2.1.2 Aluminium casting alloys, hardened, \leq 12 % Si, 90 HB	Roughing	450	0.1xD	0.3xD	0.010	0.019	0.039	0.058	0.080	0.115	0.155	0.195	0.235
	(Pre-)Finishing	435	0.05xD	0.1xD	0.012	0.024	0.048	0.072	0.095	0.145	0.190	0.240	0.290
	Fine finishing	450	0.01xD	0.02xD	0.010	0.021	0.042	0.063	0.085	0.125	0.170	0.210	0.250
N2.1.3 Aluminium casting alloys, non-hardened, $>$ 12 % Si, 130 HB	Roughing	355	0.1xD	0.3xD	0.010	0.019	0.039	0.058	0.080	0.115	0.155	0.195	0.235
	(Pre-)Finishing	340	0.05xD	0.1xD	0.012	0.024	0.048	0.072	0.095	0.145	0.190	0.240	0.290
	Fine finishing	355	0.01xD	0.02xD	0.010	0.021	0.042	0.063	0.085	0.125	0.170	0.210	0.250



Machining group	Application Copy milling	v _c (m/min)	a _p max.	a _e max.	f _z (mm/z) with nom. Ø								
					0.5	1	2	3	4	6	8	10	12
N3.1.1 Copper and copper alloys: Free-machining alloy, Pb > 1 % N3.1.2 Copper and copper alloys: CuZn, CuSnZn	Roughing	360	0.1xD	0.3xD	0.010	0.019	0.039	0.058	0.080	0.115	0.155	0.195	0.235
	(Pre-)Finishing	345	0.05xD	0.1xD	0.012	0.024	0.048	0.072	0.095	0.145	0.190	0.240	0.290
	Fine finishing	360	0.01xD	0.02xD	0.010	0.021	0.042	0.063	0.085	0.125	0.170	0.210	0.250
N3.1.3 Copper and copper alloys: CuSn, lead-free copper and copper electrolyte	Roughing	280	0.1xD	0.3xD	0.009	0.018	0.036	0.054	0.070	0.110	0.145	0.180	0.215
	(Pre-)Finishing	270	0.05xD	0.1xD	0.011	0.022	0.044	0.066	0.090	0.130	0.175	0.220	0.265
	Fine finishing	280	0.01xD	0.02xD	0.010	0.019	0.039	0.058	0.075	0.115	0.155	0.195	0.230
N4.1.1 Non-metallic materials: Duroplastics, fibre-reinforced plastics	Roughing	295	0.1xD	0.3xD	0.010	0.021	0.042	0.062	0.085	0.125	0.165	0.210	0.250
	(Pre-)Finishing	285	0.05xD	0.1xD	0.013	0.026	0.051	0.077	0.100	0.155	0.205	0.255	0.305
	Fine finishing	295	0.01xD	0.02xD	0.011	0.022	0.045	0.067	0.090	0.135	0.180	0.225	0.270
N4.1.2 Non-metallic materials: Hard rubber, wood, etc.	Roughing	395	0.1xD	0.3xD	0.009	0.019	0.037	0.056	0.075	0.110	0.150	0.185	0.225
	(Pre-)Finishing	380	0.05xD	0.1xD	0.011	0.023	0.046	0.069	0.090	0.140	0.185	0.230	0.275
	Fine finishing	395	0.01xD	0.02xD	0.010	0.020	0.040	0.060	0.080	0.120	0.160	0.200	0.240
N4.1.3 Non-metallic materials: Graphite	Roughing	475	0.1xD	0.3xD	0.013	0.027	0.053	0.080	0.105	0.160	0.210	0.265	0.320
	(Pre-)Finishing	455	0.05xD	0.1xD	0.016	0.033	0.065	0.098	0.130	0.195	0.260	0.325	0.390
	Fine finishing	475	0.01xD	0.02xD	0.014	0.029	0.057	0.086	0.115	0.170	0.230	0.285	0.345
S1.1.1 Heat-resistant alloys, Fe-based, annealed, 200 HB	Roughing	75	0.06xD	0.2xD	0.010	0.019	0.039	0.058	0.075	0.115	0.155	0.195	0.230
	(Pre-)Finishing	65	0.02xD	0.05xD	0.010	0.019	0.039	0.058	0.075	0.115	0.155	0.195	0.230
	Fine finishing	65	0.01xD	0.02xD	0.008	0.017	0.034	0.051	0.070	0.100	0.135	0.170	0.205
S1.1.2 Heat-resistant alloys, Fe-based, hardened, 280 HB	Roughing	60	0.06xD	0.2xD	0.010	0.019	0.039	0.058	0.075	0.115	0.155	0.195	0.230
	(Pre-)Finishing	55	0.02xD	0.05xD	0.010	0.019	0.039	0.058	0.075	0.115	0.155	0.195	0.230
	Fine finishing	55	0.01xD	0.02xD	0.008	0.017	0.034	0.051	0.070	0.100	0.135	0.170	0.205
S1.1.3 Heat-resistant alloys, Ni- or Co-based, annealed, 250 HB	Roughing	40	0.06xD	0.2xD	0.008	0.016	0.031	0.047	0.065	0.095	0.125	0.155	0.190
	(Pre-)Finishing	35	0.02xD	0.05xD	0.008	0.016	0.031	0.047	0.065	0.095	0.125	0.155	0.190
	Fine finishing	35	0.01xD	0.02xD	0.007	0.014	0.027	0.041	0.055	0.080	0.110	0.135	0.165
S1.1.4 Heat-resistant alloys, Ni- or Co-based, hardened, 350 HB	Roughing	30	0.06xD	0.2xD	0.007	0.015	0.030	0.045	0.060	0.090	0.120	0.150	0.180
	(Pre-)Finishing	25	0.02xD	0.05xD	0.007	0.015	0.030	0.045	0.060	0.090	0.120	0.150	0.180
	Fine finishing	25	0.01xD	0.02xD	0.007	0.013	0.026	0.039	0.050	0.080	0.105	0.130	0.155
S1.1.5 Heat-resistant alloys, Ni- or Co-based, cast, 320 HB	Roughing	35	0.06xD	0.2xD	0.008	0.016	0.031	0.047	0.065	0.095	0.125	0.155	0.190
	(Pre-)Finishing	35	0.02xD	0.05xD	0.008	0.016	0.031	0.047	0.065	0.095	0.125	0.155	0.190
	Fine finishing	35	0.01xD	0.02xD	0.007	0.014	0.027	0.041	0.055	0.080	0.110	0.135	0.165
S2.1.1 Titanium alloys, pure titanium, Rm 400 N/mm ²	Roughing	100	0.06xD	0.2xD	0.011	0.021	0.042	0.063	0.085	0.125	0.170	0.210	0.255
	(Pre-)Finishing	90	0.02xD	0.05xD	0.011	0.021	0.042	0.063	0.085	0.125	0.170	0.210	0.255
	Fine finishing	90	0.01xD	0.02xD	0.009	0.018	0.037	0.055	0.075	0.110	0.150	0.185	0.220
S2.1.2 Titanium alloys, Alpha and Beta alloys, hardened, Rm 1050 N/mm ²	Roughing	85	0.06xD	0.2xD	0.009	0.019	0.038	0.057	0.075	0.115	0.150	0.190	0.230
	(Pre-)Finishing	75	0.02xD	0.05xD	0.009	0.019	0.038	0.057	0.075	0.115	0.150	0.190	0.230
	Fine finishing	75	0.01xD	0.02xD	0.008	0.017	0.033	0.050	0.065	0.100	0.135	0.165	0.200
H1.1.1 Hardened steel, hardened and tempered, < 55 HRC	Roughing	235	0.06xD	0.2xD	0.010	0.020	0.041	0.061	0.080	0.120	0.160	0.205	0.245
	(Pre-)Finishing	205	0.02xD	0.05xD	0.010	0.020	0.041	0.061	0.080	0.120	0.160	0.205	0.245
	Fine finishing	205	0.01xD	0.02xD	0.009	0.018	0.036	0.053	0.070	0.105	0.140	0.180	0.215
H1.1.2 Hardened steel, hardened and tempered, < 60 HRC	Roughing	175	0.06xD	0.2xD	0.009	0.017	0.035	0.052	0.070	0.105	0.140	0.175	0.205
	(Pre-)Finishing	155	0.02xD	0.05xD	0.009	0.017	0.035	0.052	0.070	0.105	0.140	0.175	0.205
	Fine finishing	155	0.01xD	0.02xD	0.008	0.015	0.030	0.045	0.060	0.090	0.120	0.150	0.180
H1.1.3 Hardened steel, hardened and tempered, > 60 HRC	Roughing	140	0.06xD	0.2xD	0.008	0.015	0.030	0.046	0.060	0.090	0.120	0.150	0.185
	(Pre-)Finishing	125	0.02xD	0.05xD	0.008	0.015	0.030	0.046	0.060	0.090	0.120	0.150	0.185
	Fine finishing	125	0.01xD	0.02xD	0.007	0.013	0.027	0.040	0.055	0.080	0.105	0.135	0.160
H2.1.1 Chilled cast iron, 400 HB	Roughing	260	0.1xD	0.3xD	0.009	0.017	0.035	0.052	0.070	0.105	0.140	0.175	0.205
	(Pre-)Finishing	250	0.05xD	0.1xD	0.011	0.021	0.043	0.064	0.085	0.130	0.170	0.215	0.255
	Fine finishing	260	0.01xD	0.02xD	0.009	0.019	0.037	0.056	0.075	0.110	0.150	0.185	0.225
H2.1.2 Chilled cast iron, hardened and tempered, < 55 HRC	Roughing	210	0.06xD	0.2xD	0.009	0.019	0.038	0.057	0.075	0.115	0.150	0.190	0.225
	(Pre-)Finishing	185	0.02xD	0.05xD	0.009	0.019	0.038	0.057	0.075	0.115	0.150	0.190	0.225
	Fine finishing	185	0.01xD	0.02xD	0.008	0.017	0.033	0.050	0.065	0.100	0.130	0.165	0.200



G-Mold 55 T, G-Mold 65 T

Milling conditions:

	stable machining conditions low cutting depths, high cutting values
	short tools
	long tools

Correction factors:

	medium length tools	v_c -25 %	f_z -25 %
	extra length tools	v_c -50 %	f_z -50 %
	uncoated tools	v_c -60 %	f_z -25 %

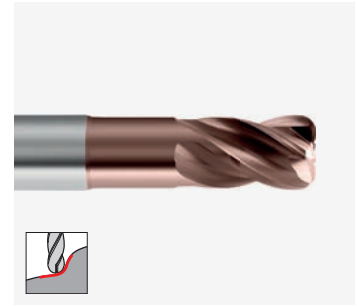

Cutting data

Machining group	Application Copy milling	v_c (m/min)	a_p max.	a_e max.	f_z (mm/z) with nom. Ø								
					0.5	1	2	3	4	6	8	10	12
P1.1.1 Unalloyed steel, annealed, 0.15 % C, Rm 420 N/mm ² , 125 HB P1.1.2 Unalloyed steel, heat-treated, 0.15 % C, Rm 420 N/mm ² , 125 HB P1.1.3 Unalloyed steel, annealed, 0.45 % C, Rm 640 N/mm ² , 190 HB P1.1.4 Unalloyed steel, heat-treated, 0.45 % C, Rm 640 N/mm ² , 190 HB P1.1.5 Unalloyed steel, heat-treated, 0.45 % C, Rm 850 N/mm ² , 250 HB P1.1.6 Unalloyed steel, annealed, 0.75 % C, Rm 915 N/mm ² , 270 HB P1.1.7 Unalloyed steel, heat-treated, 0.75 % C, Rm 1020 N/mm ² , 300 HB	Roughing	220	0.05xD	0.4xD	0.008	0.017	0.034	0.051	0.070	0.100	0.135	0.170	0.200
	(Pre-)Finishing	225	0.03xD	0.25xD	0.007	0.014	0.027	0.041	0.055	0.080	0.110	0.135	0.160
	Fine finishing	235	0.01xD	0.15xD	0.007	0.015	0.030	0.045	0.060	0.090	0.120	0.150	0.180
P2.1.1 Low-alloy steel, annealed, Rm 610 N/mm ² , 180 HB P2.1.2 Low-alloy steel, heat-treated, Rm 930 N/mm ² , 275 HB P2.1.3 Low-alloy steel, heat-treated, Rm 1020 N/mm ² , 300 HB P2.1.4 Low-alloy steel, heat-treated, Rm 1190 N/mm ² , 350 HB	Roughing	195	0.05xD	0.4xD	0.008	0.017	0.034	0.051	0.070	0.100	0.135	0.170	0.200
	(Pre-)Finishing	205	0.03xD	0.25xD	0.007	0.014	0.027	0.041	0.055	0.080	0.110	0.135	0.160
	Fine finishing	210	0.01xD	0.15xD	0.007	0.015	0.030	0.045	0.060	0.090	0.120	0.150	0.180
P3.1.1 High-alloy steel and tool steel, annealed, Rm 680 N/mm ² , 200 HB P3.1.2 High-alloy steel and tool steel, hardened and tempered, Rm 1100 N/mm ² , 325 HB	Roughing	175	0.05xD	0.4xD	0.007	0.014	0.027	0.041	0.055	0.080	0.110	0.135	0.160
	(Pre-)Finishing	185	0.03xD	0.25xD	0.005	0.011	0.022	0.032	0.045	0.065	0.085	0.110	0.130
	Fine finishing	190	0.01xD	0.15xD	0.006	0.012	0.024	0.036	0.050	0.070	0.095	0.120	0.145
M1.1.1 Stainless steel, ferritic/martensitic, with machining additives M1.1.2 Stainless steel, ferritic/martensitic, annealed, Rm 680 N/mm ² , 200 HB	Roughing	140	0.05xD	0.4xD	0.007	0.015	0.029	0.044	0.060	0.090	0.115	0.145	0.175
	(Pre-)Finishing	145	0.03xD	0.25xD	0.006	0.012	0.023	0.035	0.045	0.070	0.095	0.115	0.140
	Fine finishing	150	0.01xD	0.15xD	0.006	0.013	0.026	0.039	0.050	0.075	0.105	0.130	0.155
M1.1.3 Stainless steel, ferritic/martensitic, heat-treated, Rm 810 N/mm ² , 240 HB	Roughing	100	0.05xD	0.4xD	0.007	0.013	0.026	0.040	0.055	0.080	0.105	0.130	0.160
	(Pre-)Finishing	105	0.03xD	0.25xD	0.005	0.011	0.021	0.032	0.040	0.065	0.085	0.105	0.125
	Fine finishing	110	0.01xD	0.15xD	0.006	0.012	0.023	0.035	0.045	0.070	0.095	0.115	0.140
M2.1.1 Stainless steel, austenitic, quenched, 180 HB	Roughing	115	0.04xD	0.25xD	0.008	0.016	0.032	0.049	0.065	0.095	0.130	0.160	0.195
	(Pre-)Finishing	95	0.03xD	0.2xD	0.005	0.011	0.022	0.032	0.045	0.065	0.085	0.110	0.130
	Fine finishing	105	0.01xD	0.1xD	0.009	0.017	0.035	0.052	0.070	0.105	0.140	0.175	0.205
M2.2.1 Duplex steel, high-strength stainless steels	Roughing	85	0.04xD	0.25xD	0.007	0.014	0.028	0.042	0.055	0.085	0.115	0.140	0.170
	(Pre-)Finishing	70	0.03xD	0.2xD	0.005	0.009	0.019	0.028	0.040	0.055	0.075	0.095	0.115
	Fine finishing	80	0.01xD	0.1xD	0.008	0.015	0.030	0.045	0.060	0.090	0.120	0.150	0.180
K1.1.1 Grey cast iron, pearlitic/ferritic, 180 HB K1.1.2 Grey cast iron, pearlitic/martensitic, 260 HB K1.2.1 Cast iron with spheroidal graphite, ferritic, 160 HB K1.2.2 Cast iron with spheroidal graphite, pearlitic, 250 HB	Roughing	195	0.05xD	0.4xD	0.008	0.017	0.034	0.051	0.070	0.100	0.135	0.170	0.200
	(Pre-)Finishing	205	0.03xD	0.25xD	0.007	0.014	0.027	0.041	0.055	0.080	0.110	0.135	0.160
	Fine finishing	210	0.01xD	0.15xD	0.007	0.015	0.030	0.045	0.060	0.090	0.120	0.150	0.180
K1.3.1 Malleable cast iron, ferritic, 130 HB K1.3.2 Malleable cast iron, pearlitic, 230 HB	Roughing	165	0.05xD	0.4xD	0.007	0.015	0.030	0.045	0.060	0.090	0.120	0.150	0.180
	(Pre-)Finishing	170	0.03xD	0.25xD	0.006	0.012	0.024	0.036	0.050	0.070	0.095	0.120	0.145
	Fine finishing	175	0.01xD	0.15xD	0.007	0.013	0.026	0.040	0.055	0.080	0.105	0.130	0.160
K2.1.1 Vermicular graphite cast iron (GJV) K2.2.1 Austenitic-ferritic spheroidal graphite cast iron (ADI)	Roughing	130	0.05xD	0.4xD	0.007	0.013	0.026	0.039	0.055	0.080	0.105	0.130	0.160
	(Pre-)Finishing	135	0.03xD	0.25xD	0.005	0.011	0.021	0.032	0.040	0.065	0.085	0.105	0.125
	Fine finishing	135	0.01xD	0.15xD	0.006	0.012	0.023	0.035	0.045	0.070	0.095	0.115	0.140
N1.1.1 Wrought aluminium alloys, non-hardened, 60 HB N1.1.2 Wrought aluminium alloys, hardened, 100 HB	Roughing	620	0.05xD	0.4xD	0.009	0.018	0.036	0.054	0.070	0.110	0.145	0.180	0.215
	(Pre-)Finishing	645	0.03xD	0.25xD	0.007	0.014	0.029	0.043	0.060	0.085	0.115	0.145	0.175
	Fine finishing	670	0.01xD	0.15xD	0.008	0.016	0.032	0.048	0.065	0.095	0.125	0.160	0.190
N2.1.1 Aluminium casting alloys, non-hardened, ≤ 12 % Si, 75 HB N2.1.2 Aluminium casting alloys, hardened, ≤ 12 % Si, 90 HB	Roughing	310	0.05xD	0.4xD	0.008	0.017	0.034	0.051	0.070	0.100	0.135	0.170	0.200
	(Pre-)Finishing	320	0.03xD	0.25xD	0.007	0.014	0.027	0.041	0.055	0.080	0.110	0.135	0.160
	Fine finishing	335	0.01xD	0.15xD	0.007	0.015	0.030	0.045	0.060	0.090	0.120	0.150	0.180
N2.1.3 Aluminium casting alloys, non-hardened, > 12 % Si, 130 HB	Roughing	245	0.05xD	0.4xD	0.008	0.017	0.034	0.051	0.070	0.100	0.135	0.170	0.200
	(Pre-)Finishing	255	0.03xD	0.25xD	0.007	0.014	0.027	0.041	0.055	0.080	0.110	0.135	0.160
	Fine finishing	265	0.01xD	0.15xD	0.007	0.015	0.030	0.045	0.060	0.090	0.120	0.150	0.180



Machining group	Application Copy milling	v _c (m/min)	a _p max.	a _e max.	f _z (mm/z) with nom. Ø								
					0.5	1	2	3	4	6	8	10	12
N3.1.1 Copper and copper alloys: Free-machining alloy, Pb > 1 % N3.1.2 Copper and copper alloys: CuZn, CuSnZn	Roughing	250	0.05xD	0.4xD	0.008	0.017	0.034	0.051	0.070	0.100	0.135	0.170	0.200
	(Pre-)Finishing	255	0.03xD	0.25xD	0.007	0.014	0.027	0.041	0.055	0.080	0.110	0.135	0.160
	Fine finishing	265	0.01xD	0.15xD	0.007	0.015	0.030	0.045	0.060	0.090	0.120	0.150	0.180
N3.1.3 Copper and copper alloys: CuSn, lead-free copper and copper electrolyte	Roughing	195	0.05xD	0.4xD	0.008	0.016	0.031	0.047	0.060	0.095	0.125	0.155	0.185
	(Pre-)Finishing	200	0.03xD	0.25xD	0.006	0.012	0.025	0.037	0.050	0.075	0.100	0.125	0.150
	Fine finishing	210	0.01xD	0.15xD	0.007	0.014	0.027	0.041	0.055	0.080	0.110	0.135	0.165
N4.1.1 Non-metallic materials: Duroplastics, fibre-reinforced plastics	Roughing	205	0.05xD	0.4xD	0.009	0.018	0.036	0.054	0.070	0.110	0.145	0.180	0.215
	(Pre-)Finishing	215	0.03xD	0.25xD	0.007	0.014	0.029	0.043	0.060	0.085	0.115	0.145	0.175
	Fine finishing	220	0.01xD	0.15xD	0.008	0.016	0.032	0.048	0.065	0.095	0.125	0.160	0.190
N4.1.2 Non-metallic materials: Hard rubber, wood, etc.	Roughing	275	0.05xD	0.4xD	0.008	0.016	0.032	0.048	0.065	0.095	0.130	0.160	0.195
	(Pre-)Finishing	285	0.03xD	0.25xD	0.006	0.013	0.026	0.039	0.050	0.080	0.105	0.130	0.155
	Fine finishing	295	0.01xD	0.15xD	0.007	0.014	0.028	0.043	0.055	0.085	0.115	0.140	0.170
N4.1.3 Non-metallic materials: Graphite	Roughing	330	0.05xD	0.4xD	0.012	0.023	0.046	0.069	0.090	0.140	0.185	0.230	0.275
	(Pre-)Finishing	340	0.03xD	0.25xD	0.009	0.018	0.037	0.055	0.075	0.110	0.145	0.185	0.220
	Fine finishing	355	0.01xD	0.15xD	0.010	0.020	0.040	0.061	0.080	0.120	0.160	0.200	0.245
S1.1.1 Heat-resistant alloys, Fe-based, annealed, 200 HB	Roughing	55	0.04xD	0.25xD	0.008	0.016	0.033	0.049	0.065	0.100	0.130	0.165	0.195
	(Pre-)Finishing	50	0.03xD	0.2xD	0.006	0.012	0.024	0.036	0.050	0.070	0.095	0.120	0.145
	Fine finishing	50	0.01xD	0.1xD	0.009	0.017	0.035	0.052	0.070	0.105	0.140	0.175	0.210
S1.1.2 Heat-resistant alloys, Fe-based, hardened, 280 HB	Roughing	45	0.04xD	0.25xD	0.008	0.016	0.033	0.049	0.065	0.100	0.130	0.165	0.195
	(Pre-)Finishing	40	0.03xD	0.2xD	0.006	0.012	0.024	0.036	0.050	0.070	0.095	0.120	0.145
	Fine finishing	40	0.01xD	0.1xD	0.009	0.017	0.035	0.052	0.070	0.105	0.140	0.175	0.210
S1.1.3 Heat-resistant alloys, Ni- or Co-based, annealed, 250 HB	Roughing	30	0.04xD	0.25xD	0.007	0.013	0.027	0.040	0.055	0.080	0.105	0.135	0.160
	(Pre-)Finishing	25	0.03xD	0.2xD	0.005	0.010	0.019	0.029	0.040	0.060	0.080	0.095	0.115
	Fine finishing	30	0.01xD	0.1xD	0.007	0.014	0.028	0.042	0.055	0.085	0.115	0.140	0.170
S1.1.4 Heat-resistant alloys, Ni- or Co-based, hardened, 350 HB	Roughing	25	0.04xD	0.25xD	0.006	0.013	0.025	0.038	0.050	0.075	0.100	0.125	0.150
	(Pre-)Finishing	20	0.03xD	0.2xD	0.005	0.009	0.018	0.028	0.035	0.055	0.075	0.090	0.110
	Fine finishing	20	0.01xD	0.1xD	0.007	0.013	0.027	0.040	0.055	0.080	0.105	0.135	0.160
S1.1.5 Heat-resistant alloys, Ni- or Co-based, cast, 320 HB	Roughing	30	0.04xD	0.25xD	0.007	0.013	0.027	0.040	0.055	0.080	0.105	0.135	0.160
	(Pre-)Finishing	25	0.03xD	0.2xD	0.005	0.010	0.019	0.029	0.040	0.060	0.080	0.095	0.115
	Fine finishing	25	0.01xD	0.1xD	0.007	0.014	0.028	0.042	0.055	0.085	0.115	0.140	0.170
S2.1.1 Titanium alloys, pure titanium, Rm 400 N/mm ²	Roughing	70	0.05xD	0.3xD	0.008	0.015	0.031	0.046	0.060	0.095	0.125	0.155	0.185
	(Pre-)Finishing	65	0.03xD	0.2xD	0.007	0.013	0.026	0.039	0.050	0.080	0.105	0.130	0.155
	Fine finishing	65	0.01xD	0.15xD	0.007	0.013	0.026	0.039	0.050	0.080	0.105	0.130	0.155
S2.1.2 Titanium alloys, Alpha and Beta alloys, hardened, Rm 1050 N/mm ²	Roughing	60	0.05xD	0.3xD	0.007	0.014	0.028	0.042	0.055	0.085	0.110	0.140	0.165
	(Pre-)Finishing	55	0.03xD	0.2xD	0.006	0.012	0.023	0.035	0.045	0.070	0.095	0.115	0.140
	Fine finishing	55	0.01xD	0.15xD	0.006	0.012	0.023	0.035	0.045	0.070	0.095	0.115	0.140
H1.1.1 Hardened steel, hardened and tempered, < 55 HRC	Roughing	165	0.04xD	0.3xD	0.007	0.015	0.030	0.045	0.060	0.090	0.120	0.150	0.180
	(Pre-)Finishing	155	0.03xD	0.20xD	0.006	0.013	0.025	0.038	0.050	0.075	0.100	0.125	0.150
	Fine finishing	155	0.01xD	0.15xD	0.006	0.013	0.025	0.038	0.050	0.075	0.100	0.125	0.150
H1.1.2 Hardened steel, hardened and tempered, < 60 HRC	Roughing	125	0.04xD	0.3xD	0.006	0.013	0.025	0.038	0.050	0.075	0.100	0.125	0.150
	(Pre-)Finishing	115	0.03xD	0.20xD	0.005	0.011	0.021	0.032	0.045	0.065	0.085	0.105	0.130
	Fine finishing	115	0.01xD	0.15xD	0.005	0.011	0.021	0.032	0.045	0.065	0.085	0.105	0.130
H1.1.3 Hardened steel, hardened and tempered, > 60 HRC	Roughing	100	0.04xD	0.3xD	0.006	0.011	0.022	0.033	0.045	0.065	0.090	0.110	0.135
	(Pre-)Finishing	90	0.03xD	0.20xD	0.005	0.009	0.019	0.028	0.040	0.055	0.075	0.095	0.115
	Fine finishing	90	0.01xD	0.15xD	0.005	0.009	0.019	0.028	0.040	0.055	0.075	0.095	0.115
H2.1.1 Chilled cast iron, 400 HB	Roughing	180	0.08xD	0.4xD	0.007	0.015	0.030	0.045	0.060	0.090	0.120	0.150	0.180
	(Pre-)Finishing	185	0.05xD	0.3xD	0.006	0.012	0.024	0.036	0.050	0.070	0.095	0.120	0.145
	Fine finishing	195	0.01xD	0.15xD	0.007	0.013	0.026	0.040	0.055	0.080	0.105	0.130	0.160
H2.1.2 Chilled cast iron, hardened and tempered, < 55 HRC	Roughing	150	0.04xD	0.3xD	0.007	0.014	0.028	0.041	0.055	0.085	0.110	0.140	0.165
	(Pre-)Finishing	140	0.03xD	0.20xD	0.006	0.012	0.023	0.035	0.045	0.070	0.095	0.115	0.140
	Fine finishing	140	0.01xD	0.15xD	0.006	0.012	0.023	0.035	0.045	0.070	0.095	0.115	0.140



Universal slot drills and end mills with ball nose

Milling conditions:

 stable machining conditions
low cutting depths, high cutting values

 long tools

Correction factors:

 extra length tools v_c -50 % f_z -50 %

 uncoated tools v_c -60 % f_z -25 %

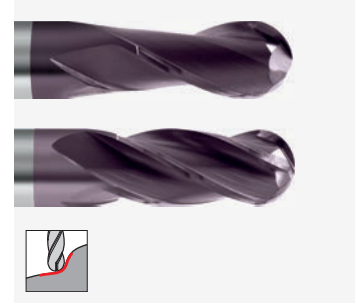

Machining group	Application Copy milling	v_c (m/min)	a_p max.	a_e max.	f_z (mm/z) with nom. Ø								
					0.5	1	3	6	8	10	12	16	20
P1.1.1 Unalloyed steel, annealed, 0.15 % C, Rm 420 N/mm ² , 125 HB P1.1.2 Unalloyed steel, heat-treated, 0.15 % C, Rm 420 N/mm ² , 125 HB P1.1.3 Unalloyed steel, annealed, 0.45 % C, Rm 640 N/mm ² , 190 HB P1.1.4 Unalloyed steel, heat-treated, 0.45 % C, Rm 640 N/mm ² , 190 HB P1.1.5 Unalloyed steel, heat-treated, 0.45 % C, Rm 850 N/mm ² , 250 HB P1.1.6 Unalloyed steel, annealed, 0.75 % C, Rm 915 N/mm ² , 270 HB P1.1.7 Unalloyed steel, heat-treated, 0.75 % C, Rm 1020 N/mm ² , 300 HB	Roughing	335	0.1xD	0.1xD	0.005	0.010	0.029	0.060	0.075	0.095	0.115	0.155	0.195
	(Pre-)Finishing	265	0.03xD	0.03xD	0.003	0.006	0.018	0.035	0.045	0.060	0.070	0.095	0.120
	Fine finishing	265	0.01xD	0.01xD	0.002	0.003	0.010	0.020	0.025	0.035	0.040	0.055	0.065
P2.1.1 Low-alloy steel, annealed, Rm 610 N/mm ² , 180 HB P2.1.2 Low-alloy steel, heat-treated, Rm 930 N/mm ² , 275 HB P2.1.3 Low-alloy steel, heat-treated, Rm 1020 N/mm ² , 300 HB P2.1.4 Low-alloy steel, heat-treated, Rm 1190 N/mm ² , 350 HB	Roughing	335	0.1xD	0.1xD	0.005	0.010	0.029	0.060	0.075	0.095	0.115	0.155	0.195
	(Pre-)Finishing	265	0.03xD	0.03xD	0.003	0.006	0.018	0.035	0.045	0.060	0.070	0.095	0.120
	Fine finishing	265	0.01xD	0.01xD	0.002	0.003	0.010	0.020	0.025	0.035	0.040	0.055	0.065
P3.1.1 High-alloy steel and tool steel, annealed, Rm 680 N/mm ² , 200 HB P3.1.2 High-alloy steel and tool steel, hardened and tempered, Rm 1100 N/mm ² , 325 HB	Roughing	265	0.1xD	0.1xD	0.005	0.009	0.028	0.055	0.075	0.090	0.110	0.145	0.185
	(Pre-)Finishing	210	0.03xD	0.03xD	0.003	0.006	0.017	0.035	0.045	0.055	0.065	0.090	0.110
	Fine finishing	210	0.01xD	0.01xD	0.002	0.003	0.010	0.020	0.025	0.030	0.040	0.050	0.065
M1.1.1 Stainless steel, ferritic/martensitic, with machining additives M1.1.2 Stainless steel, ferritic/martensitic, annealed, Rm 680 N/mm ² , 200 HB	Roughing	230	0.1xD	0.1xD	0.004	0.009	0.026	0.050	0.070	0.085	0.105	0.140	0.175
	(Pre-)Finishing	180	0.03xD	0.03xD	0.003	0.005	0.016	0.030	0.045	0.055	0.065	0.085	0.105
	Fine finishing	180	0.01xD	0.01xD	0.002	0.003	0.009	0.020	0.025	0.030	0.035	0.050	0.060
M1.1.3 Stainless steel, ferritic/martensitic, heat-treated, Rm 810 N/mm ² , 240 HB	Roughing	165	0.1xD	0.1xD	0.004	0.008	0.024	0.045	0.065	0.080	0.095	0.125	0.160
	(Pre-)Finishing	130	0.03xD	0.03xD	0.002	0.005	0.014	0.030	0.040	0.050	0.060	0.075	0.095
	Fine finishing	130	0.01xD	0.01xD	0.001	0.003	0.008	0.015	0.020	0.030	0.035	0.045	0.055
M2.1.1 Stainless steel, austenitic, quenched, 180 HB	Roughing	155	0.1xD	0.1xD	0.004	0.008	0.025	0.050	0.065	0.085	0.100	0.130	0.165
	(Pre-)Finishing	120	0.02xD	0.02xD	0.003	0.005	0.015	0.030	0.040	0.050	0.060	0.080	0.100
	Fine finishing	120	0.01xD	0.01xD	0.001	0.003	0.009	0.015	0.025	0.030	0.035	0.045	0.060
M2.2.1 Duplex steel, high-strength stainless steels	Roughing	115	0.1xD	0.1xD	0.004	0.007	0.022	0.045	0.060	0.070	0.085	0.115	0.145
	(Pre-)Finishing	90	0.02xD	0.02xD	0.002	0.004	0.013	0.025	0.035	0.045	0.055	0.070	0.090
	Fine finishing	90	0.01xD	0.01xD	0.001	0.003	0.008	0.015	0.020	0.025	0.030	0.040	0.050
K1.1.1 Grey cast iron, pearlitic/ferritic, 180 HB K1.1.2 Grey cast iron, pearlitic/martensitic, 260 HB K1.2.1 Cast iron with spheroidal graphite, ferritic, 160 HB K1.2.2 Cast iron with spheroidal graphite, pearlitic, 250 HB	Roughing	255	0.1xD	0.1xD	0.005	0.010	0.030	0.060	0.080	0.100	0.120	0.160	0.200
	(Pre-)Finishing	200	0.02xD	0.02xD	0.003	0.006	0.018	0.035	0.050	0.060	0.075	0.100	0.125
	Fine finishing	200	0.01xD	0.01xD	0.002	0.004	0.011	0.020	0.030	0.035	0.040	0.055	0.070
K1.3.1 Malleable cast iron, ferritic, 130 HB K1.3.2 Malleable cast iron, pearlitic, 230 HB	Roughing	210	0.1xD	0.1xD	0.004	0.009	0.027	0.055	0.070	0.090	0.110	0.145	0.180
	(Pre-)Finishing	165	0.03xD	0.03xD	0.003	0.005	0.016	0.035	0.045	0.055	0.065	0.090	0.110
	Fine finishing	165	0.01xD	0.01xD	0.002	0.003	0.009	0.020	0.025	0.030	0.040	0.050	0.065
K2.1.1 Vermicular graphite cast iron (GJV) K2.2.1 Austenitic-ferritic spheroidal graphite cast iron (ADI)	Roughing	175	0.1xD	0.1xD	0.004	0.008	0.025	0.050	0.065	0.085	0.100	0.130	0.165
	(Pre-)Finishing	135	0.02xD	0.02xD	0.003	0.005	0.015	0.030	0.040	0.050	0.060	0.080	0.100
	Fine finishing	135	0.01xD	0.01xD	0.001	0.003	0.009	0.015	0.025	0.030	0.035	0.045	0.060
N1.1.1 Wrought aluminium alloys, non-hardened, 60 HB N1.1.2 Wrought aluminium alloys, hardened, 100 HB	Roughing	570	0.1xD	0.1xD	0.007	0.015	0.045	0.090	0.120	0.150	0.180	0.240	0.300
	(Pre-)Finishing	450	0.03xD	0.03xD	0.005	0.009	0.027	0.055	0.075	0.090	0.110	0.145	0.180
	Fine finishing	450	0.01xD	0.01xD	0.003	0.005	0.016	0.030	0.040	0.050	0.060	0.085	0.105
N2.1.1 Aluminium casting alloys, non-hardened, ≤ 12 % Si, 75 HB N2.1.2 Aluminium casting alloys, hardened, ≤ 12 % Si, 90 HB	Roughing	370	0.1xD	0.1xD	0.006	0.012	0.034	0.070	0.090	0.115	0.140	0.185	0.230
	(Pre-)Finishing	295	0.03xD	0.03xD	0.004	0.007	0.021	0.040	0.055	0.070	0.085	0.110	0.140
	Fine finishing	295	0.01xD	0.01xD	0.002	0.004	0.012	0.025	0.030	0.040	0.050	0.065	0.080
N2.1.3 Aluminium casting alloys, non-hardened, > 12 % Si, 130 HB	Roughing	295	0.1xD	0.1xD	0.006	0.012	0.034	0.070	0.090	0.115	0.140	0.185	0.230
	(Pre-)Finishing	230	0.03xD	0.03xD	0.004	0.007	0.021	0.040	0.055	0.070	0.085	0.110	0.140
	Fine finishing	230	0.01xD	0.01xD	0.002	0.004	0.012	0.025	0.030	0.040	0.050	0.065	0.080



Machining group	Application Copy milling	v _c (m/min)	a _p max.	a _e max.	f _z (mm/z) with nom. Ø								
					0.5	1	3	6	8	10	12	16	20
N3.1.1 Copper and copper alloys: Free-machining alloy, Pb > 1 % N3.1.2 Copper and copper alloys: CuZn, CuSnZn	Roughing	320	0.1xD	0.1xD	0.005	0.009	0.028	0.055	0.075	0.090	0.110	0.145	0.185
	(Pre-)Finishing	250	0.03xD	0.03xD	0.003	0.006	0.017	0.035	0.045	0.055	0.065	0.090	0.110
	Fine finishing	250	0.01xD	0.01xD	0.002	0.003	0.010	0.020	0.025	0.030	0.040	0.050	0.065
N3.1.3 Copper and copper alloys: CuSn, lead-free copper and copper electrolyte	Roughing	250	0.1xD	0.1xD	0.004	0.008	0.025	0.050	0.070	0.085	0.100	0.135	0.170
	(Pre-)Finishing	195	0.03xD	0.03xD	0.003	0.005	0.015	0.030	0.040	0.050	0.060	0.080	0.105
	Fine finishing	195	0.01xD	0.01xD	0.001	0.003	0.009	0.020	0.025	0.030	0.035	0.045	0.060
N4.1.1 Non-metallic materials: Duroplastics, fibre-reinforced plastics	Roughing	275	0.1xD	0.1xD	0.005	0.010	0.030	0.060	0.080	0.100	0.120	0.160	0.200
	(Pre-)Finishing	220	0.03xD	0.03xD	0.003	0.006	0.018	0.035	0.050	0.060	0.075	0.100	0.125
	Fine finishing	220	0.01xD	0.01xD	0.002	0.004	0.011	0.020	0.030	0.035	0.040	0.055	0.070
N4.1.2 Non-metallic materials: Hard rubber, wood, etc.	Roughing	365	0.1xD	0.1xD	0.005	0.009	0.027	0.055	0.075	0.090	0.110	0.145	0.180
	(Pre-)Finishing	290	0.03xD	0.03xD	0.003	0.006	0.017	0.035	0.045	0.055	0.065	0.090	0.110
	Fine finishing	290	0.01xD	0.01xD	0.002	0.003	0.009	0.020	0.025	0.030	0.040	0.050	0.065
N4.1.3 Non-metallic materials: Graphite	Roughing	440	0.1xD	0.1xD	0.006	0.013	0.039	0.080	0.105	0.130	0.155	0.205	0.260
	(Pre-)Finishing	345	0.03xD	0.03xD	0.004	0.008	0.024	0.045	0.065	0.080	0.095	0.125	0.155
	Fine finishing	345	0.01xD	0.01xD	0.002	0.004	0.013	0.025	0.035	0.045	0.055	0.070	0.090
S1.1.1 Heat-resistant alloys, Fe-based, annealed, 200 HB	Roughing	55	0.1xD	0.1xD	0.004	0.008	0.023	0.045	0.065	0.080	0.095	0.125	0.155
	(Pre-)Finishing	45	0.02xD	0.02xD	0.002	0.005	0.014	0.030	0.040	0.050	0.055	0.075	0.095
	Fine finishing	45	0.01xD	0.01xD	0.001	0.003	0.008	0.015	0.020	0.025	0.035	0.045	0.055
S1.1.2 Heat-resistant alloys, Fe-based, hardened, 280 HB	Roughing	45	0.1xD	0.1xD	0.004	0.008	0.023	0.045	0.065	0.080	0.095	0.125	0.155
	(Pre-)Finishing	35	0.02xD	0.02xD	0.002	0.005	0.014	0.030	0.040	0.050	0.055	0.075	0.095
	Fine finishing	35	0.01xD	0.01xD	0.001	0.003	0.008	0.015	0.020	0.025	0.035	0.045	0.055
S1.1.3 Heat-resistant alloys, Ni- or Co-based, annealed, 250 HB	Roughing	30	0.1xD	0.1xD	0.003	0.006	0.019	0.040	0.050	0.065	0.075	0.100	0.125
	(Pre-)Finishing	25	0.02xD	0.02xD	0.002	0.004	0.012	0.025	0.030	0.040	0.045	0.060	0.075
	Fine finishing	25	0.01xD	0.01xD	0.001	0.002	0.007	0.015	0.020	0.020	0.025	0.035	0.045
S1.1.4 Heat-resistant alloys, Ni- or Co-based, hardened, 350 HB	Roughing	25	0.1xD	0.1xD	0.003	0.006	0.018	0.035	0.050	0.060	0.070	0.095	0.120
	(Pre-)Finishing	20	0.02xD	0.02xD	0.002	0.004	0.011	0.020	0.030	0.035	0.045	0.060	0.075
	Fine finishing	20	0.01xD	0.01xD	0.001	0.002	0.006	0.015	0.015	0.020	0.025	0.035	0.040
S1.1.5 Heat-resistant alloys, Ni- or Co-based, cast, 320 HB	Roughing	30	0.1xD	0.1xD	0.003	0.006	0.019	0.040	0.050	0.065	0.075	0.100	0.125
	(Pre-)Finishing	20	0.02xD	0.02xD	0.002	0.004	0.012	0.025	0.030	0.040	0.045	0.060	0.075
	Fine finishing	20	0.01xD	0.01xD	0.001	0.002	0.007	0.015	0.020	0.020	0.025	0.035	0.045
S2.1.1 Titanium alloys, pure titanium, Rm 400 N/mm ²	Roughing	130	0.1xD	0.1xD	0.005	0.009	0.028	0.055	0.075	0.095	0.115	0.150	0.190
	(Pre-)Finishing	105	0.02xD	0.02xD	0.003	0.006	0.017	0.035	0.045	0.055	0.070	0.090	0.115
	Fine finishing	105	0.01xD	0.01xD	0.002	0.003	0.010	0.020	0.025	0.035	0.040	0.050	0.065
S2.1.2 Titanium alloys, Alpha and Beta alloys, hardened, Rm 1050 N/mm ²	Roughing	110	0.1xD	0.1xD	0.004	0.008	0.025	0.050	0.070	0.085	0.100	0.135	0.170
	(Pre-)Finishing	85	0.02xD	0.02xD	0.003	0.005	0.015	0.030	0.040	0.050	0.060	0.085	0.105
	Fine finishing	85	0.01xD	0.01xD	0.001	0.003	0.009	0.020	0.025	0.030	0.035	0.045	0.060
H1.1.1 Hardened steel, hardened and tempered, < 55 HRC	Roughing	80	0.1xD	0.1xD	0.003	0.007	0.021	0.040	0.055	0.070	0.085	0.110	0.140
	(Pre-)Finishing	60	0.03xD	0.03xD	0.002	0.004	0.013	0.025	0.035	0.040	0.050	0.065	0.085
	Fine finishing	60	0.01xD	0.01xD	0.001	0.002	0.007	0.015	0.020	0.025	0.030	0.040	0.050
H1.1.2 Hardened steel, hardened and tempered, < 60 HRC													
H1.1.3 Hardened steel, hardened and tempered, > 60 HRC													
H2.1.1 Chilled cast iron, 400 HB	Roughing	100	0.1xD	0.1xD	0.003	0.007	0.020	0.040	0.055	0.065	0.080	0.105	0.135
	(Pre-)Finishing	80	0.03xD	0.03xD	0.002	0.004	0.012	0.025	0.030	0.040	0.050	0.065	0.080
	Fine finishing	80	0.01xD	0.01xD	0.001	0.002	0.007	0.015	0.020	0.025	0.030	0.035	0.045
H2.1.2 Chilled cast iron, hardened and tempered, < 55 HRC	Roughing	70	0.1xD	0.1xD	0.003	0.006	0.018	0.035	0.045	0.060	0.070	0.095	0.120
	(Pre-)Finishing	55	0.03xD	0.03xD	0.002	0.004	0.011	0.020	0.030	0.035	0.045	0.060	0.070
	Fine finishing	55	0.01xD	0.01xD	0.001	0.002	0.006	0.010	0.015	0.020	0.025	0.035	0.040



High-performance milling cutters HSS-E-PM

Milling conditions:

HPC stable machining conditions
high drive power

long tools

Correction factors:

a_p roughing > 1.5xD v_c -25 % f_z -25 %

medium length tools v_c -40 % f_z -40 %

uncoated tools v_c -50 % f_z -25 %



Cutting data

Machining group	Application	v_c (m/min)	a_e max.	f_z (mm/z) with nom. Ø								
				3	4	6	8	10	12	16	20	25
P1.1.1 Unalloyed steel, annealed, 0.15 % C, Rm 420 N/mm ² , 125 HB P1.1.2 Unalloyed steel, heat-treated, 0.15 % C, Rm 420 N/mm ² , 125 HB P1.1.3 Unalloyed steel, annealed, 0.45 % C, Rm 640 N/mm ² , 190 HB P1.1.4 Unalloyed steel, heat-treated, 0.45 % C, Rm 640 N/mm ² , 190 HB P1.1.5 Unalloyed steel, heat-treated, 0.45 % C, Rm 850 N/mm ² , 250 HB P1.1.6 Unalloyed steel, annealed, 0.75 % C, Rm 915 N/mm ² , 270 HB P1.1.7 Unalloyed steel, heat-treated, 0.75 % C, Rm 1020 N/mm ² , 300 HB	Slotting	60	1xD	0.012	0.015	0.025	0.030	0.045	0.055	0.070	0.090	0.115
	Roughing	70	0.75xD	0.016	0.020	0.030	0.040	0.050	0.060	0.085	0.105	0.130
	Finishing	120	0.02xD	0.015	0.020	0.030	0.040	0.050	0.060	0.080	0.100	0.125
P2.1.1 Low-alloy steel, annealed, Rm 610 N/mm ² , 180 HB P2.1.2 Low-alloy steel, heat-treated, Rm 930 N/mm ² , 275 HB P2.1.3 Low-alloy steel, heat-treated, Rm 1020 N/mm ² , 300 HB P2.1.4 Low-alloy steel, heat-treated, Rm 1190 N/mm ² , 350 HB	Slotting	55	1xD	0.012	0.015	0.025	0.030	0.045	0.055	0.070	0.090	0.115
	Roughing	65	0.75xD	0.016	0.020	0.030	0.040	0.050	0.060	0.085	0.105	0.130
	Finishing	110	0.02xD	0.015	0.020	0.030	0.040	0.050	0.060	0.080	0.100	0.125
P3.1.1 High-alloy steel and tool steel, annealed, Rm 680 N/mm ² , 200 HB P3.1.2 High-alloy steel and tool steel, hardened and tempered, Rm 1100 N/mm ² , 325 HB	Slotting	50	1xD	0.011	0.015	0.020	0.030	0.040	0.050	0.065	0.080	0.100
	Roughing	55	0.75xD	0.014	0.020	0.030	0.035	0.045	0.055	0.075	0.090	0.115
	Finishing	95	0.02xD	0.013	0.020	0.025	0.035	0.045	0.055	0.070	0.090	0.110
M1.1.1 Stainless steel, ferritic/martensitic, with machining additives M1.1.2 Stainless steel, ferritic/martensitic, annealed, Rm 680 N/mm ² , 200 HB	Slotting	50	1xD	0.009	0.010	0.020	0.025	0.035	0.040	0.055	0.070	0.085
	Roughing	60	0.75xD	0.012	0.015	0.025	0.030	0.040	0.045	0.065	0.080	0.100
	Finishing	100	0.02xD	0.011	0.015	0.020	0.030	0.035	0.045	0.060	0.075	0.095
M1.1.3 Stainless steel, ferritic/martensitic, heat-treated, Rm 810 N/mm ² , 240 HB	Slotting	35	1xD	0.008	0.010	0.015	0.020	0.030	0.035	0.050	0.060	0.075
	Roughing	40	0.75xD	0.011	0.015	0.020	0.030	0.035	0.040	0.055	0.070	0.090
	Finishing	75	0.02xD	0.010	0.015	0.020	0.025	0.035	0.040	0.055	0.070	0.085
M2.1.1 Stainless steel, austenitic, quenched, 180 HB	Slotting	40	1xD	0.008	0.010	0.015	0.020	0.030	0.035	0.050	0.060	0.075
	Roughing	50	0.6xD	0.011	0.015	0.020	0.030	0.035	0.045	0.060	0.070	0.090
	Finishing	75	0.01xD	0.009	0.010	0.020	0.025	0.030	0.035	0.050	0.060	0.075
M2.2.1 Duplex steel, high-strength stainless steels	Slotting	30	1xD	0.007	0.010	0.015	0.020	0.025	0.030	0.040	0.050	0.065
	Roughing	35	0.6xD	0.009	0.015	0.020	0.025	0.030	0.040	0.050	0.065	0.080
	Finishing	55	0.01xD	0.008	0.010	0.015	0.020	0.025	0.030	0.040	0.050	0.065
K1.1.1 Grey cast iron, pearlitic/ferritic, 180 HB K1.1.2 Grey cast iron, pearlitic/martensitic, 260 HB K1.2.1 Cast iron with spheroidal graphite, ferritic, 160 HB K1.2.2 Cast iron with spheroidal graphite, pearlitic, 250 HB	Slotting	45	1xD	0.012	0.015	0.025	0.030	0.045	0.055	0.070	0.090	0.115
	Roughing	55	0.75xD	0.016	0.020	0.030	0.040	0.050	0.060	0.085	0.105	0.130
	Finishing	90	0.02xD	0.015	0.020	0.030	0.040	0.050	0.060	0.080	0.100	0.125
K1.3.1 Malleable cast iron, ferritic, 130 HB K1.3.2 Malleable cast iron, pearlitic, 230 HB	Slotting	40	1xD	0.011	0.015	0.020	0.030	0.040	0.050	0.065	0.080	0.100
	Roughing	40	0.75xD	0.012	0.015	0.025	0.030	0.040	0.050	0.065	0.080	0.100
	Finishing	75	0.02xD	0.013	0.020	0.025	0.035	0.045	0.055	0.070	0.090	0.110
K2.1.1 Vermicular graphite cast iron (GJV) K2.2.1 Austenitic-ferritic spheroidal graphite cast iron (ADI)	Slotting	30	1xD	0.010	0.015	0.020	0.025	0.035	0.045	0.060	0.070	0.090
	Roughing	30	0.75xD	0.011	0.015	0.020	0.030	0.035	0.045	0.060	0.070	0.090
	Finishing	60	0.02xD	0.012	0.015	0.025	0.030	0.040	0.050	0.065	0.080	0.100
N1.1.1 Wrought aluminium alloys, non-hardened, 60 HB N1.1.2 Wrought aluminium alloys, hardened, 100 HB	Slotting	120	1xD	0.016	0.020	0.030	0.040	0.060	0.070	0.095	0.120	0.150
	Roughing	140	0.75xD	0.021	0.030	0.040	0.055	0.070	0.085	0.110	0.140	0.175
	Finishing	240	0.02xD	0.020	0.025	0.040	0.055	0.065	0.080	0.105	0.130	0.165
N2.1.1 Aluminium casting alloys, non-hardened, ≤ 12 % Si, 75 HB N2.1.2 Aluminium casting alloys, hardened, ≤ 12 % Si, 90 HB	Slotting	80	1xD	0.015	0.020	0.030	0.040	0.055	0.065	0.090	0.110	0.140
	Roughing	90	0.75xD	0.019	0.025	0.040	0.050	0.065	0.075	0.100	0.125	0.160
	Finishing	160	0.02xD	0.018	0.025	0.035	0.050	0.060	0.075	0.095	0.120	0.150
N2.1.3 Aluminium casting alloys, non-hardened, > 12 % Si, 130 HB	Slotting	65	1xD	0.015	0.020	0.030	0.040	0.055	0.065	0.090	0.110	0.140
	Roughing	65	0.75xD	0.017	0.020	0.035	0.045	0.055	0.065	0.090	0.110	0.140
	Finishing	125	0.02xD	0.018	0.025	0.035	0.050	0.060	0.075	0.095	0.120	0.150





Machining group	Application	V _c (m/min)	a _e max.	f _z (mm/z) with nom. Ø								
				3	4	6	8	10	12	16	20	25
N3.1.1 Copper and copper alloys: Free-machining alloy, Pb > 1 % N3.1.2 Copper and copper alloys: CuZn, CuSnZn	Slotting	80	1xD	0.013	0.020	0.025	0.035	0.050	0.060	0.080	0.100	0.125
	Roughing	90	0.75xD	0.017	0.025	0.035	0.045	0.060	0.070	0.090	0.115	0.145
	Finishing	160	0.02xD	0.017	0.020	0.035	0.045	0.055	0.065	0.090	0.110	0.140
N3.1.3 Copper and copper alloys: CuSn, lead-free copper and copper electrolyte	Slotting	65	1xD	0.012	0.015	0.025	0.030	0.045	0.055	0.075	0.090	0.115
	Roughing	70	0.75xD	0.016	0.020	0.030	0.040	0.055	0.065	0.085	0.105	0.130
	Finishing	125	0.02xD	0.015	0.020	0.030	0.040	0.050	0.060	0.080	0.100	0.125
N4.1.1 Non-metallic materials: Duroplastics, fibre-reinforced plastics	Slotting	50	1xD	0.012	0.015	0.025	0.035	0.045	0.055	0.075	0.095	0.120
	Roughing	60	0.75xD	0.016	0.020	0.030	0.045	0.055	0.065	0.085	0.110	0.135
	Finishing	100	0.02xD	0.016	0.020	0.030	0.040	0.050	0.060	0.085	0.105	0.130
N4.1.2 Non-metallic materials: Hard rubber, wood, etc.	Slotting	65	1xD	0.011	0.015	0.020	0.030	0.040	0.050	0.065	0.085	0.105
	Roughing	75	0.75xD	0.015	0.020	0.030	0.040	0.050	0.060	0.080	0.095	0.120
	Finishing	135	0.02xD	0.014	0.020	0.030	0.035	0.045	0.055	0.075	0.095	0.115
N4.1.3 Non-metallic materials: Graphite	Slotting	80	1xD	0.016	0.020	0.030	0.040	0.060	0.070	0.095	0.120	0.150
	Roughing	90	0.75xD	0.021	0.030	0.040	0.055	0.070	0.085	0.110	0.140	0.175
	Finishing	160	0.02xD	0.020	0.025	0.040	0.055	0.065	0.080	0.105	0.130	0.165
S1.1.1 Heat-resistant alloys, Fe-based, annealed, 200 HB	Slotting	10	1xD	0.008	0.010	0.015	0.020	0.030	0.035	0.050	0.060	0.075
	Roughing	15	0.6xD	0.011	0.015	0.020	0.030	0.035	0.045	0.060	0.070	0.090
	Finishing	20	0.01xD	0.009	0.010	0.020	0.025	0.030	0.035	0.050	0.060	0.075
S1.1.2 Heat-resistant alloys, Fe-based, hardened, 280 HB	Slotting	10	1xD	0.008	0.010	0.015	0.020	0.030	0.035	0.050	0.060	0.075
	Roughing	10	0.6xD	0.011	0.015	0.020	0.030	0.035	0.045	0.060	0.070	0.090
	Finishing	15	0.01xD	0.009	0.010	0.020	0.025	0.030	0.035	0.050	0.060	0.075
S1.1.3 Heat-resistant alloys, Ni- or Co-based, annealed, 250 HB	Slotting	5	1xD	0.006	0.010	0.015	0.015	0.025	0.030	0.040	0.050	0.060
	Roughing	5	0.6xD	0.009	0.010	0.020	0.025	0.030	0.035	0.045	0.060	0.075
	Finishing	10	0.01xD	0.007	0.010	0.015	0.020	0.025	0.030	0.040	0.050	0.060
S1.1.4 Heat-resistant alloys, Ni- or Co-based, hardened, 350 HB	Slotting	5	1xD	0.006	0.010	0.010	0.015	0.025	0.030	0.035	0.045	0.060
	Roughing	5	0.6xD	0.008	0.010	0.015	0.020	0.030	0.035	0.045	0.055	0.070
	Finishing	10	0.01xD	0.007	0.010	0.015	0.020	0.025	0.030	0.035	0.045	0.060
S1.1.5 Heat-resistant alloys, Ni- or Co-based, cast, 320 HB	Slotting	5	1xD	0.006	0.010	0.015	0.015	0.025	0.030	0.040	0.050	0.060
	Roughing	5	0.6xD	0.009	0.010	0.020	0.025	0.030	0.035	0.045	0.060	0.075
	Finishing	10	0.01xD	0.007	0.010	0.015	0.020	0.025	0.030	0.040	0.050	0.060
S2.1.1 Titanium alloys, pure titanium, Rm 400 N/mm ²	Slotting	30	1xD	0.010	0.015	0.020	0.025	0.040	0.045	0.060	0.080	0.100
	Roughing	40	0.6xD	0.014	0.020	0.030	0.035	0.045	0.055	0.075	0.095	0.115
	Finishing	60	0.02xD	0.013	0.015	0.025	0.035	0.045	0.050	0.070	0.085	0.105
S2.1.2 Titanium alloys, Alpha and Beta alloys, hardened, Rm 1050 N/mm ²	Slotting	25	1xD	0.009	0.010	0.020	0.025	0.035	0.040	0.055	0.070	0.090
	Roughing	35	0.6xD	0.013	0.015	0.025	0.035	0.040	0.050	0.065	0.085	0.105
	Finishing	50	0.02xD	0.012	0.015	0.025	0.030	0.040	0.045	0.060	0.075	0.095
H1.1.1 Hardened steel, hardened and tempered, < 55 HRC												
H1.1.2 Hardened steel, hardened and tempered, < 60 HRC												
H1.1.3 Hardened steel, hardened and tempered, > 60 HRC												
H2.1.1 Chilled cast iron, 400 HB												
H2.1.2 Chilled cast iron, hardened and tempered, < 55 HRC												

Cutting data







Universal milling cutters M42/HSCO

Milling conditions:

 unstable machining conditions low drive power
 short tools
 long tools

Correction factors:

 a_p roughing > 1.5xD	v_c -25 %	f_z -25 %
 medium length tools	v_c -40 %	f_z -40 %
 extra length tools	v_c -60 %	f_z -55 %
 uncoated tools	v_c -50 %	f_z -25 %



Cutting data

Machining group	Application	v_c (m/min)	a_e max.	f_z (mm/z) with nom. Ø								
				3	4	6	8	10	12	16	20	25
P1.1.1 Unalloyed steel, annealed, 0.15 % C, Rm 420 N/mm ² , 125 HB P1.1.2 Unalloyed steel, heat-treated, 0.15 % C, Rm 420 N/mm ² , 125 HB P1.1.3 Unalloyed steel, annealed, 0.45 % C, Rm 640 N/mm ² , 190 HB P1.1.4 Unalloyed steel, heat-treated, 0.45 % C, Rm 640 N/mm ² , 190 HB P1.1.5 Unalloyed steel, heat-treated, 0.45 % C, Rm 850 N/mm ² , 250 HB P1.1.6 Unalloyed steel, annealed, 0.75 % C, Rm 915 N/mm ² , 270 HB P1.1.7 Unalloyed steel, heat-treated, 0.75 % C, Rm 1020 N/mm ² , 300 HB	Slotting	40	1xD	0.016	0.020	0.030	0.040	0.060	0.070	0.095	0.120	0.150
	Roughing	45	0.75xD	0.021	0.030	0.040	0.055	0.070	0.085	0.110	0.140	0.175
	Finishing	80	0.02xD	0.020	0.025	0.040	0.055	0.065	0.080	0.105	0.130	0.165
P2.1.1 Low-alloy steel, annealed, Rm 610 N/mm ² , 180 HB P2.1.2 Low-alloy steel, heat-treated, Rm 930 N/mm ² , 275 HB P2.1.3 Low-alloy steel, heat-treated, Rm 1020 N/mm ² , 300 HB P2.1.4 Low-alloy steel, heat-treated, Rm 1190 N/mm ² , 350 HB	Slotting	35	1xD	0.015	0.020	0.030	0.040	0.055	0.065	0.090	0.110	0.140
	Roughing	40	0.75xD	0.019	0.025	0.040	0.050	0.065	0.075	0.100	0.125	0.160
	Finishing	70	0.02xD	0.018	0.025	0.035	0.050	0.060	0.075	0.095	0.120	0.150
P3.1.1 High-alloy steel and tool steel, annealed, Rm 680 N/mm ² , 200 HB P3.1.2 High-alloy steel and tool steel, hardened and tempered, Rm 1100 N/mm ² , 325 HB	Slotting	25	1xD	0.013	0.020	0.025	0.035	0.050	0.060	0.080	0.100	0.125
	Roughing	30	0.75xD	0.017	0.025	0.035	0.045	0.060	0.070	0.090	0.115	0.145
	Finishing	50	0.02xD	0.017	0.020	0.035	0.045	0.055	0.065	0.090	0.110	0.140
M1.1.1 Stainless steel, ferritic/martensitic, with machining additives M1.1.2 Stainless steel, ferritic/martensitic, annealed, Rm 680 N/mm ² , 200 HB	Slotting	30	1xD	0.013	0.020	0.025	0.035	0.050	0.060	0.080	0.100	0.125
	Roughing	35	0.75xD	0.017	0.025	0.035	0.045	0.060	0.070	0.090	0.115	0.145
	Finishing	65	0.02xD	0.017	0.020	0.035	0.045	0.055	0.065	0.090	0.110	0.140
M1.1.3 Stainless steel, ferritic/martensitic, heat-treated, Rm 810 N/mm ² , 240 HB	Slotting	25	1xD	0.012	0.015	0.025	0.030	0.045	0.055	0.070	0.090	0.115
	Roughing	25	0.75xD	0.016	0.020	0.030	0.040	0.050	0.060	0.085	0.105	0.130
	Finishing	45	0.02xD	0.015	0.020	0.030	0.040	0.050	0.060	0.080	0.100	0.125
M2.1.1 Stainless steel, austenitic, quenched, 180 HB	Slotting	20	1xD	0.012	0.015	0.025	0.030	0.045	0.055	0.070	0.090	0.115
	Roughing	30	0.6xD	0.016	0.020	0.030	0.045	0.055	0.065	0.085	0.110	0.135
	Finishing	45	0.01xD	0.014	0.020	0.025	0.035	0.045	0.055	0.070	0.090	0.115
M2.2.1 Duplex steel, high-strength stainless steels	Slotting	15	1xD	0.010	0.015	0.020	0.030	0.040	0.045	0.065	0.080	0.100
	Roughing	20	0.6xD	0.014	0.020	0.030	0.040	0.045	0.055	0.075	0.095	0.120
	Finishing	35	0.01xD	0.012	0.015	0.025	0.030	0.040	0.045	0.065	0.080	0.100
K1.1.1 Grey cast iron, pearlitic/ferritic, 180 HB K1.1.2 Grey cast iron, pearlitic/martensitic, 260 HB K1.2.1 Cast iron with spheroidal graphite, ferritic, 160 HB K1.2.2 Cast iron with spheroidal graphite, pearlitic, 250 HB	Slotting	40	1xD	0.017	0.025	0.035	0.045	0.065	0.075	0.100	0.130	0.160
	Roughing	45	0.75xD	0.022	0.030	0.045	0.060	0.075	0.090	0.120	0.145	0.185
	Finishing	75	0.02xD	0.021	0.030	0.040	0.055	0.070	0.085	0.115	0.140	0.175
K1.3.1 Malleable cast iron, ferritic, 130 HB K1.3.2 Malleable cast iron, pearlitic, 230 HB	Slotting	30	1xD	0.015	0.020	0.030	0.040	0.055	0.070	0.090	0.115	0.140
	Roughing	30	0.75xD	0.017	0.025	0.035	0.045	0.055	0.070	0.090	0.115	0.140
	Finishing	65	0.02xD	0.019	0.025	0.040	0.050	0.065	0.075	0.100	0.125	0.155
K2.1.1 Vermicular graphite cast iron (GJV) K2.2.1 Austenitic-ferritic spheroidal graphite cast iron (ADI)	Slotting	25	1xD	0.013	0.020	0.025	0.035	0.050	0.060	0.080	0.100	0.125
	Roughing	25	0.75xD	0.015	0.020	0.030	0.040	0.050	0.060	0.080	0.100	0.125
	Finishing	50	0.02xD	0.017	0.020	0.035	0.045	0.055	0.065	0.090	0.110	0.140
N1.1.1 Wrought aluminium alloys, non-hardened, 60 HB N1.1.2 Wrought aluminium alloys, hardened, 100 HB	Slotting	100	1xD	0.021	0.030	0.040	0.055	0.080	0.095	0.130	0.160	0.200
	Roughing	115	0.75xD	0.028	0.035	0.055	0.075	0.090	0.110	0.145	0.185	0.230
	Finishing	200	0.02xD	0.026	0.035	0.055	0.070	0.090	0.105	0.140	0.175	0.220
N2.1.1 Aluminium casting alloys, non-hardened, ≤ 12 % Si, 75 HB N2.1.2 Aluminium casting alloys, hardened, ≤ 12 % Si, 90 HB	Slotting	70	1xD	0.016	0.020	0.030	0.040	0.060	0.070	0.095	0.120	0.150
	Roughing	80	0.75xD	0.021	0.030	0.040	0.055	0.070	0.085	0.110	0.140	0.175
	Finishing	140	0.02xD	0.020	0.025	0.040	0.055	0.065	0.080	0.105	0.130	0.165
N2.1.3 Aluminium casting alloys, non-hardened, > 12 % Si, 130 HB	Slotting	55	1xD	0.016	0.020	0.030	0.040	0.060	0.070	0.095	0.120	0.150
	Roughing	55	0.75xD	0.018	0.025	0.035	0.050	0.060	0.070	0.095	0.120	0.150
	Finishing	110	0.02xD	0.020	0.025	0.040	0.055	0.065	0.080	0.105	0.130	0.165



Machining group	Application	V _c (m/min)	a _e max.	f _z (mm/z) with nom. Ø								
				3	4	6	8	10	12	16	20	25
N3.1.1 Copper and copper alloys: Free-machining alloy, Pb > 1 % N3.1.2 Copper and copper alloys: CuZn, CuSnZn	Slotting	60	1xD	0.016	0.020	0.030	0.040	0.060	0.070	0.095	0.120	0.150
	Roughing	70	0.75xD	0.021	0.030	0.040	0.055	0.070	0.085	0.110	0.140	0.175
	Finishing	120	0.02xD	0.020	0.025	0.040	0.055	0.065	0.080	0.105	0.130	0.165
N3.1.3 Copper and copper alloys: CuSn, lead-free copper and copper electrolyte	Slotting	45	1xD	0.015	0.020	0.030	0.040	0.055	0.065	0.090	0.110	0.140
	Roughing	55	0.75xD	0.019	0.025	0.040	0.050	0.065	0.075	0.100	0.125	0.160
	Finishing	95	0.02xD	0.018	0.025	0.035	0.050	0.060	0.075	0.095	0.120	0.150
N4.1.1 Non-metallic materials: Duroplastics, fibre-reinforced plastics	Slotting	35	1xD	0.016	0.020	0.035	0.045	0.060	0.075	0.100	0.125	0.155
	Roughing	40	0.75xD	0.021	0.030	0.045	0.055	0.070	0.085	0.115	0.145	0.180
	Finishing	65	0.02xD	0.020	0.025	0.040	0.055	0.070	0.080	0.110	0.135	0.170
N4.1.2 Non-metallic materials: Hard rubber, wood, etc.	Slotting	45	1xD	0.015	0.020	0.030	0.040	0.055	0.065	0.090	0.110	0.140
	Roughing	50	0.75xD	0.019	0.025	0.040	0.050	0.065	0.075	0.100	0.130	0.160
	Finishing	90	0.02xD	0.018	0.025	0.035	0.050	0.060	0.075	0.100	0.120	0.155
N4.1.3 Non-metallic materials: Graphite	Slotting	55	1xD	0.021	0.030	0.040	0.055	0.080	0.095	0.125	0.160	0.200
	Roughing	60	0.75xD	0.027	0.035	0.055	0.075	0.090	0.110	0.145	0.180	0.230
	Finishing	105	0.02xD	0.026	0.035	0.050	0.070	0.085	0.105	0.140	0.175	0.220
S1.1.1 Heat-resistant alloys, Fe-based, annealed, 200 HB												
S1.1.2 Heat-resistant alloys, Fe-based, hardened, 280 HB												
S1.1.3 Heat-resistant alloys, Ni- or Co-based, annealed, 250 HB												
S1.1.4 Heat-resistant alloys, Ni- or Co-based, hardened, 350 HB												
S1.1.5 Heat-resistant alloys, Ni- or Co-based, cast, 320 HB												
S2.1.1 Titanium alloys, pure titanium, Rm 400 N/mm ²												
S2.1.2 Titanium alloys, Alpha and Beta alloys, hardened, Rm 1050 N/mm ²												
H1.1.1 Hardened steel, hardened and tempered, < 55 HRC												
H1.1.2 Hardened steel, hardened and tempered, < 60 HRC												
H1.1.3 Hardened steel, hardened and tempered, > 60 HRC												
H2.1.1 Chilled cast iron, 400 HB												
H2.1.2 Chilled cast iron, hardened and tempered, < 55 HRC												

Cutting data



EFFICIENT MILLING

WITH THE RIGHT STRATEGIES

GTC MILLING STRATEGIES

These milling strategies belong to the state-of-the-art and most effective application methods for current solid carbide milling tools. When applied, an enormously high metal removal rate ensures a considerable increase in productivity. Very high cutting parameters can be achieved even with less powerful machines or unstable machining conditions. With difficult-to-machine materials or unfavourable diameter-length-ratios of the tools a massive increase of process reliability can be achieved.



1 HIGH PERFORMANCE CUTTING

max. metal removal rate/time → stable conditions; short de-clamping; high performance; good cooling



2 HIGH SPEED CUTTING

at high speed/high feed rate → high dynamics; low cutting depth; low drive power



PRINCIPLES & OBJECTIVES



- Maximum tool utilisation
- utilisation of entire cutting edge length
 - full power delivery
 - increased tool life
 - balanced wear



- Modification of cutting distribution
- low cutting widths a_e
 - high cutting depths a_p



- High process reliability
- low tool wrapping
 - improved thermal conditions at tool cutting edge
 - low mechanical stress



- Maximum metal removal rate
- saving time/machine costs





Guide values for increasing the cutting values with cutting edge lengths up to 3xD					
Roughing and finishing					
Material	Application	radial feed in % of Ø	v _c factor*	f _z factor*	Angle of engagement
	Slotting	100 %	1	1	180°
	HPC Roughing	33 %	1.5	1.3	70°
	HPC Roughing	25 %	1.6	1.5	60°
	HPC Roughing	20 %	1.7	1.6	53°
	HPC Roughing	15 %	1.8	1.9	46°
	HPC Roughing	10 %	1.9	2.3	37°
	HPC Roughing	8 %	2.0	2.5	31°
	HPC Roughing	5 %	2.1	2.5	26°
	HSC Finishing	3 %	2.0	1.2	20°
	HSC Finishing	2 %	2.0	1.1	18°
	HSC Finishing	1 %	2.0	1.0	11°
	HSC fine finishing	0.5 %	2.2	0.9	8°

*Base value for the calculation with v_c and f_z factors is the value specified in the Gühring Navigator for "slotting" in the respective material group.

Base cutting values slotting – RF 100 tools – smooth cutting													
Material	Hardness	Application	v _c	f _z with nom. Ø									
				3	4	5	6	8	10	12	16	20	25
P1	≤ 850 N/mm ²	Slotting	180	0.015	0.020	0.025	0.030	0.040	0.060	0.072	0.096	0.120	0.150
P2	850-1200 N/mm ²	Slotting	160	0.014	0.019	0.024	0.029	0.038	0.055	0.066	0.088	0.110	0.138
P3	850-1400 N/mm ²	Slotting	135	0.014	0.018	0.023	0.027	0.036	0.050	0.060	0.080	0.100	0.125
M1	< 750 N/mm ²	Slotting	120	0.014	0.018	0.023	0.027	0.036	0.050	0.060	0.080	0.100	0.125
M2	750-850 N/mm ²	Slotting	80	0.012	0.016	0.020	0.024	0.032	0.045	0.054	0.072	0.090	0.113
M3	> 850 N/mm ²	Slotting	70	0.011	0.014	0.018	0.021	0.028	0.040	0.048	0.064	0.080	0.100
S-Ni	≤ 1300 N/mm ²	Slotting	30	0.008	0.011	0.014	0.017	0.022	0.032	0.038	0.051	0.064	0.080
S-Ti	≤ 1300 N/mm ²	Slotting	60	0.012	0.016	0.020	0.024	0.032	0.045	0.054	0.072	0.090	0.113
K1	≤ 240 HB	Slotting	160	0.017	0.022	0.028	0.033	0.044	0.065	0.078	0.104	0.130	0.163
K2	> 240 HB	Slotting	140	0.015	0.020	0.025	0.030	0.040	0.055	0.066	0.088	0.110	0.138
Wr. al. alloy	≤ 5 % Si	Slotting	500	0.020	0.026	0.033	0.039	0.052	0.075	0.090	0.120	0.150	0.188
Cast al. alloy	> 5 % Si	Slotting	230	0.017	0.022	0.028	0.033	0.044	0.060	0.072	0.096	0.120	0.150
Non-fer. metals	≤ 850 N/mm ²	Slotting	250	0.017	0.022	0.028	0.033	0.044	0.060	0.072	0.096	0.120	0.150

Cutting data

METAL REMOVAL RATE

$$a_p \text{ (mm)} \times a_e \text{ (mm)} \times v_f \text{ (m/min)} = Q \text{ (cm}^3\text{/min)}$$

Example – RF 100 U (Ø 12 mm, 4 flutes)	
Application	HPC roughing: 15 % a _e , 2xD a _p , C45
Feed	radial feed, a _e = 1.8 mm (15 % of D)
Base value slotting	v _c = 180 m/min, f _z = 0.072 mm
Conversion	v _c factor = 1.8 → v _c : 180 m/min x 1.8 = 324 m/min f _z factor = 1.9 → f _z : 0.072 mm x 1.9 = 0,137 mm
Increased values	v _c = 324 m/min / f _z = 0.137 mm, n = 8594 rev/min / v _f = 4710 mm/min
Metal removal rate	Q = 203 cm ³ /min



Threading tools

Focus on cost-effectiveness

Be it drilling, moulding or milling –
process-reliable threading tools
for every scenario

GÜHRING

Page

742 **Taps**

742 High-performance taps Pionex

765 Through-holes

807 Blind holes

874 Through- and blind holes

890 **Fluteless taps**

890 High-performance fluteless taps Pionex

899 Thread depth up to 1.5xD without oil grooves

903 Thread depth up to 3xD with oil grooves

922 **Thread milling cutters**

922 Thread milling cutters without chamfer

926 Thread milling cutters with chamfer

928 Universal thread milling cutters

932 Micro thread milling cutters

936 SC-Line Thread milling cutters

938 Circular thread milling cutters

940 Drill thread milling cutters

942 **Hand taps**950 **Dies**

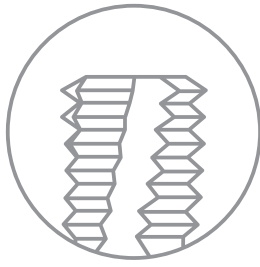

ALL-ROUNDER
High degree of material flexibility

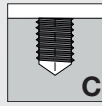

P Steel, high-alloy steel



Type N R40
e.g. # 836
p. 812



Type N
e.g. # 2876
p. 769

M Stainless steel



Type N R40
e.g. # 836
p. 812



Type N
e.g. # 2876
p. 769

K Grey cast iron, spheroidal graphite iron and malleable cast iron



Type GG
e.g. # 807
p. 876



Type GG
e.g. # 807
p. 876

N Aluminium, magnesium, non-ferrous metals



Type N R40
e.g. # 836
p. 812



Type N
e.g. # 2876
p. 769

S Special, super and titanium alloy



H Chilled cast iron, hardened steel

Didn't find what you were looking for?

Enter very specific requirements into our online Gühring Navigator and you will receive precise tool recommendations – cutting values included.

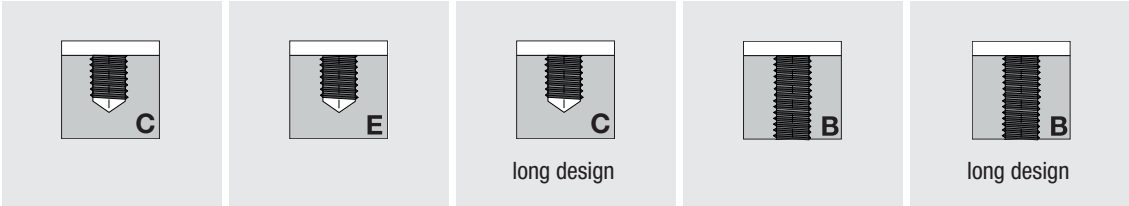

SPECIALIST
Maximum tool life, minimum cycle time

PIONEX
e.g. # 393
p. 752



PIONEX
e.g. # 4630
p. 754



PIONEX
e.g. # 4633
p. 752



PIONEX
e.g. # 4218
p. 742



PIONEX
e.g. # 4645
p. 742



PIONEX
e.g. # 393
p. 752



PIONEX
e.g. # 4630
p. 754



PIONEX
e.g. # 4633
p. 752



PIONEX
e.g. # 4218
p. 742



PIONEX
e.g. # 4645
p. 742



Type GG
e.g. # 1919
p. 876



Type H
e.g. # 1091
p. 821



Type H
e.g. # 779
p. 819



Type GG
e.g. # 1919
p. 876



Type H
e.g. # 779
p. 819



Type N R45
e.g. # 4670
p. 832



Type N R45
e.g. # 4671
p. 832



PIONEX
e.g. # 4633
p. 752



Type N
e.g. # 4672
p. 777



PIONEX
e.g. # 4645
p. 742



Type Ti R15
e.g. # 2909
p. 834



Type Ti
e.g. # 2901
p. 779



Type H/D
e.g. # 2944
p. 877

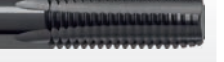

Type H/D
e.g. # 2944
p. 877

Threading tools

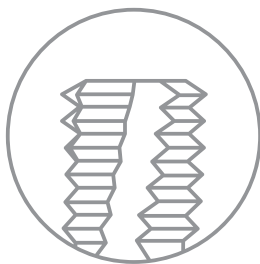

ALL-ROUNDER
High degree of material flexibility

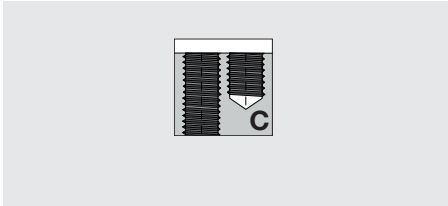

Threading tools

P
Steel,
high-alloy
steel



Type N
e.g. # 919
p. 903

M
Stainless
steel



Type N
e.g. # 919
p. 903

K
Grey cast iron,
spheroidal graphite
iron and malleable
cast iron

For this material group
we recommend
thread milling cutters or
taps.

N
Aluminium,
magnesium,
non-ferrous metals



Type N
e.g. # 919
p. 903

S
Special, super
and titanium
alloy



Type N
e.g. # 919
p. 903

H
Chilled cast iron,
hardened
steel

For this material group
we recommend
thread milling cutters or
taps.

Didn't find what you were looking for?

Enter very specific requirements into our online Gühring Navigator and you will receive precise tool recommendations – cutting values included.



SPECIALIST
Maximum tool life, minimum cycle time

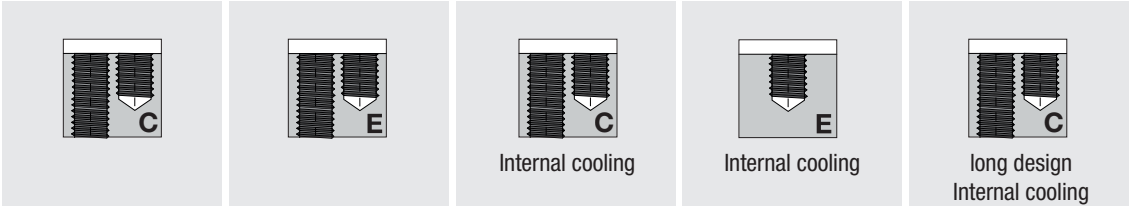

For this material group we recommend thread milling cutters or taps.





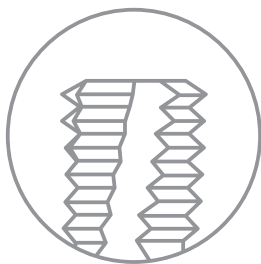

For this material group we recommend thread milling cutters or taps.



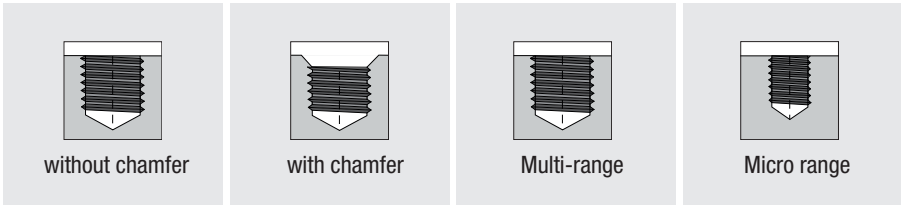

Threading tools











ALL-ROUNDER High degree of material flexibility











P Steel, high-alloy steel				
	TM SP e.g. # 3737 p. 922	TMC SP e.g. # 3526 p. 926	TMU SP e.g. # 3541 p. 928	MTM3 SP e.g. # 4226 p. 932

M Stainless steel				
	TM SP e.g. # 3737 p. 922	TMC SP e.g. # 3526 p. 926	TMU SP e.g. # 3541 p. 928	MTM3 SP e.g. # 4226 p. 932

K Grey cast iron, spheroidal graphite iron and malleable cast iron				
	TM SP e.g. # 3737 p. 922	TMC SP e.g. # 3526 p. 926	TMU SP e.g. # 3541 p. 928	MTM3 SP e.g. # 4226 p. 932

N Aluminium, magnesium, non-ferrous metals				
	TM SP e.g. # 3737 p. 922	TMC SP e.g. # 3526 p. 926	TMU SP e.g. # 3541 p. 928	MTM3 SP e.g. # 4226 p. 932

S Special, super and titanium alloy				
	TM SP e.g. # 3737 p. 922	TMC SP e.g. # 3526 p. 926	TMU SP e.g. # 3541 p. 928	MTM3 SP e.g. # 4226 p. 932

H Chilled cast iron, hardened steel				
	TM SP e.g. # 3737 p. 922	TMC SP e.g. # 3526 p. 926	TMU SP e.g. # 3541 p. 928	MTM3 SP e.g. # 4226 p. 932

Didn't find what you were looking for?

Enter very specific requirements into our online Gühring Navigator and you will receive precise tool recommendations – cutting values included.



SPECIALIST
Maximum tool life, minimum cycle time

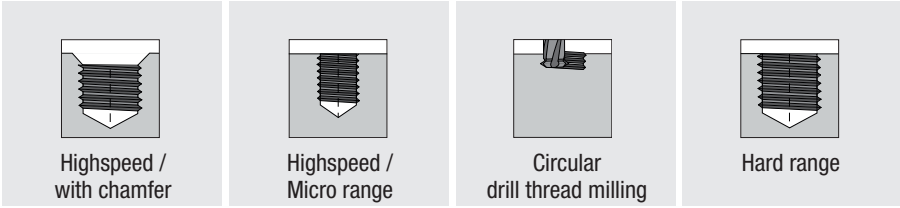

SC TMC SP
e.g. # 4000
p. 936



SC-MTM3 SP
e.g. # 4001
p. 937



MTMH3-Z
e.g. # 4002
p. 938



SC TMC SP
e.g. # 4000
p. 936



SC-MTM3 SP
e.g. # 4001
p. 937



MTMH3-Z
e.g. # 4002
p. 938



SC TMC SP
e.g. # 4000
p. 936



SC-MTM3 SP
e.g. # 4001
p. 937



MTMH3-Z
e.g. # 4002
p. 938



SC-MTM3 SP
e.g. # 4001
p. 937



MTMH3-Z
e.g. # 4002
p. 938



SC-MTM3 SP
e.g. # 4001
p. 937



MTMH3-Z
e.g. # 4002
p. 938



MTMH3 SP
e.g. # 4496
p. 935



SC-MTM3 SP
e.g. # 4001
p. 937



MTMH3-Z
e.g. # 4002
p. 938



MTMH3 SP
e.g. # 4496
p. 935

Threading tools



Thread depth		≤3xD					
Tool material		HSS-E			HSS-E-PM		
		<i>Pionex</i>	<i>Pionex</i>	<i>Pionex</i>	<i>Pionex</i>	<i>Pionex</i>	<i>Pionex</i>
Type/form	VA/B	VA/B	VA/B	VA/B	VA/B	VA/B	VA/B
Surface							
Cutting direction							
Coolant supply							
<p>Through-hole</p>							
Thread type	Tol.	Article no./page					
M	6HX	4218 742 M2 - M42	4644 744 M2 - M30	4645 742 M3 - M20	4646 745 M3 - M20	4651 745 M3 - M20	4648 746 M5 - M30
	6GX	4638 743 M2 - M30					
	7GX	4639 743 M2 - M30					
	6H+0,1	4640 743 M2 - M30					
MF	6HX	4219 747 M3 x 0,35 - M24 x 2			4647 748 M8 x 1 - M24 x 1,5		4649 748 M8 x 1 - M24 x 1,5
	6GX	4641 747 M6 x 0,75 - M24 x 1,5					
UNC	2BX	4642 749 2 - 56 - 1 - 8					
UNF	2BX	4643 749 2 - 64 - 1 - 12					
G	-	4220 750 G1/16 - G1					
Rp	-	4682 750 Rp1/16 - Rp1					
BSW	-	4680 751 W1/8 - W1					

P	•	•	•	•	•	•
M	•	•	•	•	•	•
K	○	○	○	○	○	○
N	○	○	○	○	○	○
S	○	○	○	○	○	○
H	○	○	○	○	○	○



Thread depth		≤3xD						
Tool material		HSS-E				HSS-E-PM		
		<i>Pionex</i>	<i>Pionex</i>	<i>Pionex</i>	<i>Pionex</i>	<i>Pionex</i>	<i>Pionex</i>	<i>Pionex</i>
Type/form		VA R45/C	VA L45/C	VA R45/E	VA R45/C	VA R45/C	VA R45/C	VA R45/C
Surface								
Shank tolerance								
Coolant supply								
<p>Blind-hole</p>								
Thread type	Tol.	Article no./page						
M	6HX	393 752 M2 - M42	4629 754 M2 - M30	4630 754 M2 - M30	4633 752 M3 - M20	4634 755 M3 - M20	4650 755 M3 - M20	4636 756 M5 - M30
	6GX	4625 753 M2 - M30						
	7GX	4626 753 M2 - M30						
	6H+0,1	4627 753 M2 - M30						
MF	6HX	394 757 M3 x 0,35 - M24 x 2		4631 758 M6 x 0,75 - M24 x 1,5	4860 759 M8 x 0,75 - M20 x 1,5	4635 760 M8 x 1 - M24 x 1,5		4637 760 M8 x 1 - M24 x 1,5
	6GX	4628 757 M6 x 0,75 - M24 x 1,5						
UNC	2BX	391 761 2 - 56 - 1 - 8						
UNF	2BX	392 761 2 - 64 - 1 - 12						
G	-	395 762 G1/16 - G1		4632 762 G1/16 - G1	4861 763 G1/8 - G1/2			
Rp	-	4681 764 Rp1/16 - Rp1						
BSW	-	4679 764 W1/8 - W1						

P	•	•	•	•	•	•	•
M	•	•	•	•	•	•	•
K	○	○	○	○	○	○	○
N	○	○	○	○	○	○	○
S	○	○	○	○	○	○	○
H	○	○	○	○	○	○	○

Threading tools



Thread depth		1,5xD				3xD			
Tool material		HSS-E							
Type/form	N/D	N/-	N/C	N/B	N/B	N/B	N/B	N/B	N/B
Surface									
Coolant supply									
Through-hole									
Thread type	Tol.	Article no./page							
M	4H							794 767 M2 - M10	
	6H	1839 782 M3 - M12	851 781 M3 - M20	806/818 874 M1 - M48	838 780 M1,4 - M10	991 780 M3 - M24	998 781 M3 - M20	803/815 765 M1,4 - M52	912/915 765 M1,4 - M52
	6G			795 875 M3 - M10				837/845 768 M1,4 - M20	
MF	6H			830 878 M3 x 0,35 - M42 x 1,5				827 783 M3 x 0,35 - M40 x 1,5	832 783 M3 x 0,35 - M36 x 1,5
	6G			829 879 M6 x 0,75 - M63 x 1,5				316 784 M6 x 0,75 - M20 x 1,5	
UNC	2B			1977 882 2 - 56 - 3/8 - 16				873/878 794 2 - 56 - 1 1/2 - 6	
UNF	2B			1987 885 3 - 56 - 1 - 12				908 798 10 - 32 - 1 1/4 - 12	
G	-			963 887 G1/8 - G2				962 800 G1/8 - G2	
BSW	-								
NPT	-			973 889 1/16 - 2					
PG	-			979 889 PG7 - PG29		980 804 PG7 - PG21			

P	•	•	•	•	•	•	•	•
M								
K								
N								
S								
H								



Thread depth		1,5xD		3xD			
Tool material		HSS-E					
Type/form		N R15/C	N R15/C	N R40/C	N R40/C	N R40/C	N R40/C
Surface							
Coolant supply							
<p>Blind-hole</p>							
Thread type	Tol.	Article no./page					
M	4H						
	6H	809/821 807 M2 - M24	913/916 807 M2 - M24	993 835 M3 - M12	888 835 M3 - M20	810/822 809 M2 - M30	914/ 917 809 M2 - M10
	6G	799 808 M2 - M10				844/848 810 M3 - M24	
MF	6H	833 836 M6 x 0,75 - M30 x 2	1971 836 M6 x 0,75 - M30 x 2			834 837 M3 x 0,35 - M30 x 2	852 837 M3 x 0,35 - M30 x 2
	6G						
UNC	2B	1978 851 2 - 56 - 3/8 - 16				876/881 852 2 - 56 - 1 - 8	
UNF	2B	1988 858 1/4 - 28 - 9/16 - 18				911 858 3 - 56 - 1 - 12	
G	-	964 864 G1/8 - G1				965 864 G1/8 - G1 1/2	
BSW	-						
NPT	-						
PG	-						

P	•	•	•	•	•	•
M						
K						
N						
S						
H						

Threading tools



Thread depth		3xD			
Tool material		HSS-E		HSS-E-PM	VHM
Type/form		N/B	N/B	N/B	N/B
Surface					
Coolant supply					
 Through-hole					
Thread type	Tol.	Article no./page			
M	6H	2876/2877 769 M2 - M36	313/315 769 M2 - M36	1285/1286 769 M2 - M20	
	6HX				942 771 M5 - M12
	6G	2990 770 M2 - M10	2991 770 M2 - M10		
MF	6H	2879 785 M5 x 0,5 - M50 x 1,5	4778 785 M5 x 0,5 - M30 x 2	1291 786 M8 x 1 - M24 x 2	
	6HX				943/944 788 M8 x 1 - M16 x 1,5
	6G	2992 787 M8 x 1 - M20 x 1,5	2993 787 M8 x 1 - M20 x 1,5		
UNC	2B	2881/2883 795 4 - 40 - 1 - 8			
UNF	2B	2885 798 10 - 32 - 7/8 - 14			
G	-	2887 800 G1/8 - G2			
EG M	6H mod.		1010 803 EG/STI M3 - EG/STI M16		

P				
M				
K				
N				
S				
H				



Thread depth		1,5xD			3xD			
Tool material		HSS-E						HSS-E-PM
Type/form		N R15/C	N R15/E	N R40/C	N R40/C	N R40/C (K)	N R40/C	N R40/C
Surface								
Coolant supply								
 Blind-hole								
Thread type	Tol.	Article no./page						
M	6H	4154 811 M3 - M20	4155 811 M3 - M20	836/826 812 M2 - M36	2440/2441 812 M2 - M36	196 815 M5 - M30		1288/1289 812 M2 - M20
	6HX						4153 815 M3 - M20	
	6G			2994 814 M2 - M10	2995 814 M2 - M10			
MF	6H	4156 838 M8 x 1 - M16 x 1,5	4157 838 M8 x 1 - M16 x 1,5	2853 839 M5 x 0,5 - M30 x 2	4779 839 M5 x 0,5 - M30 x 2	273 840 M10 x 1 - M24 x 1,5		1292 839 M8 x 1 - M24 x 2
	6HX							
	6G			2999 840 M8 x 1 - M20 x 1,5	1049 840 M8 x 1 - M20 x 1,5			
UNC	2B			2855/2857 853 4 - 40 - 1 - 8		1837 854 10 - 24 - 3/8 - 16		
UNF	2B			2859 859 10 - 32 - 7/8 - 14		1838 859 10 - 32 - 1 - 12		
G	-		4158 865 G1/16 - G1	2861 866 G1/8 - G2		937 866 G1/8 - G1		
EG M	6H mod.				1011 ??? ?? ???? ? M16			

P	•	•	•	•	•	•	•
M	○	○	○	○	○	○	○
K							
N							
S							
H							

Threading tools



Threading tools







Thread depth	3xD			
Tool material	HSS-E		HSS-E-PM	
Type/form	H/B	H/B	H/B	
Surface				
Coolant supply				
Through-hole				
Thread type	Tol.	Article no./page		
M	6H	2941/2942 772 M2 - M24	4791 773 M2 - M24	1575/1576 772 M3 - M30
	6G	4792 773 M2 - M10	2710 773 M2 - M10	
MF	6H	2943 789 M8 x 0,75 - M24 x 1,5	4793 789 M8 x 0,75 - M24 x 1,5	
	6G	4794 790 M8 x 1 - M20 x 1,5	2983 790 M8 x 1 - M20 x 1,5	
G	-		4795 801 G1/16 - G1	

Thread depth	3xD		1,5xD	
Tool material	HSS-E		HSS-E-PM	
Type/form	H R40/C	H R40/C	H R15/C	
Surface				
Coolant supply				
Blind-hole				
Thread type	Tol.	Article no./page		
M	6H	2850/2851 817 M2 - M30	361/362 817 M2 - M30	1577/1578 816 M3 - M20
	6G	2985 818 M2 - M10	2986 818 M2 - M10	
MF	6H	2852 841 M8 x 0,75 - M24 x 1,5	4796 841 M8 x 0,75 - M24 x 1,5	
	6G	2988 841 M8 x 1 - M20 x 1,5	2989 841 M8 x 1 - M20 x 1,5	
G	-		4797 867 G1/16 - G1	

P	•	•	•
M			
K			
N			
S			
H			

P	•	•	•
M			
K			
N			
S			
H			







Thread depth		2xD					
Tool material		HSS-E		HSS-E-PM			
Type/form		H/C	H/C	H/C	H/E	H/C	NR15/C
Surface							
Coolant supply		<input type="checkbox"/>	<input type="checkbox"/>	<input type="checkbox"/>	<input type="checkbox"/>	<input checked="" type="checkbox"/>	<input type="checkbox"/>
 Blind-hole							
Thread type	Tol.	Article no./page					
M	6HX	778 819 M16 - M39	779 819 M16 - M39	302/297 820 M5 - M14	1091/4165 821 M5 - M20		1188/1194 822 M6 - M24
	6GX						
MF	6HX			1090 842 M5 x 0,5 - M16 x 1,5	1007 842 M5 x 0,5 - M16 x 1,5		1200 843 M6 x 0,75 - M24 x 1,5
	6GX						
RC	-					4683 869 Rc1/8 - Rc1	

Threading tools

P	•	•	•	•	•	•
M						
K	•	•	•	•	•	•
N	○	○	○	○	○	○
S						
H						



Thread depth		3xD		
Tool material		HSS-E		
Type/form		VA/B	VA/B	VA AZ/B
Surface		○	●	○
Coolant supply		⊗	⊗	⊗
 Through-hole				
Thread type	Tol.	Article no./page		
M	6H	1870/1872 774 M2 - M30	2869/2870 774 M2 - M30	1871 775 M3 - M10
	6G			
MF	6H	1873 791 M3 x 0,35 - M24 x 1,5	2871 791 M3 x 0,35 - M24 x 1,5	
	6G			
UNC	2B	1980/1985 796 4 - 40 - 1 - 8	2872/2873 796 4 - 40 - 1 - 8	
UNF	2B			
G	-	967 802 G1/8 - G1	2875 802 G1/8 - G1	
NPT	-			
NPTF	-			

P	○	○	○
M	●	●	●
K			
N	○	○	○
S			
H			







Thread depth		1,5xD			3xD		
Tool material		HSS-E				HSS-E-PM	
Type/form		VA R15/C	VA R15/C	VA R40/C	VA R40/C	VA R50/C	VA R50/C
Surface							
Coolant supply							
 Blind-hole						Synchro 	Synchro
Thread type	Tol.	Article no./page					
M	6H	843/785 823 M2 - M24	2896/2895 823 M2 - M24	814/825 824 M3 - M30	2862/2863 824 M3 - M30		
	6G					761/763 825 M3 - M10	1139/1142 826 M5 - M20
MF	6H	1874 844 M4 x 0,5 - M24 x 1,5	2897 844 M4 x 0,5 - M24 x 1,5	4798 845 M3 x 0,35 - M24 x 1,5	2864 845 M3 x 0,35 - M24 x 1,5		
	6G					764 846 M8 x 1 - M20 x 1,5	1144 846 M8 x 1 - M20 x 1,5
UNC	2B			1981/1986 855 2 - 56 - 7/8 - 9	2865/2866 855 2 - 56 - 7/8 - 9		
UNF	2B	1991 860 10 - 32 - 5/8 - 18		2867 861 10 - 32 - 7/8 - 14	2868 861 10 - 32 - 7/8 - 14		
G	-			4799 868 G1/16 - G1 1/2	968 868 G1/16 - G1 1/2	4159 869 G1/8 - G1/2	
NPT	-	1087 870 1/16 NPT - 1 NPT	1088 870 1/16 NPT - 1 NPT				
NPTF	-		4127 870 1/16 NPTF - 1 NPTF				

P	○	○			●	●
M	●	●	●	●	●	●
K						
N	○		○	○	○	○
S						
H						

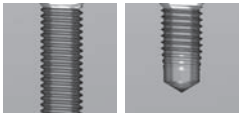
Threading tools







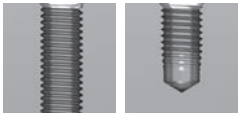

Thread depth		3xD			
Tool material		HSS-E			
Type/form	GG/C	GG/C	GG/C	GG/C	
Surface	●	● F	●	● F	
Coolant supply	☒	☒	☐	☐	
 <p>Through- and blind hole</p>					
Thread type	Tol.	Article no./page			
M	6H				
	6HX	807/819 876 M3 - M30	1918/1919 876 M3 - M30	1890/1897 827 M5 - M20	318/319 827 M5 - M20
MF	6HX	831 880 M8 x 1 - M30 x 1,5	169 880 M8 x 1 - M30 x 1,5	1904 847 M8 x 1 - M24 x 1,5	347 847 M8 x 1 - M24 x 1,5
UNC	2B	1979/1984 883 2 - 56 - 1 - 8	4857 884 2 - 56 - 1 - 8		1085/1086 856 10 - 24 - 7/8 - 9
UNF	2B	1989 886 1/4 - 28 - 1 - 12	4858 886 1/4 - 28 - 1 - 12		1082 862 10 - 32 - 7/8 - 14
UNF	-	961 887 G1/8 - G2	4859 887 G1/8 - G2		

Threading tools

P				
M				
K	●	●	●	●
N	○	○	○	○
S				
H				







Thread depth		3xD				
Tool material		VHM				
Type/form	H/C	H/E	H/C	H/C	H/C	
Surface	○	○	●	○	●	
Coolant supply	☐	☐	☐	☐	☐	
 <p>Through- and blind hole</p>						
Thread type	Tol.	Article no./page				
M	6H					
	6HX	969/1883 828 M3 - M20	1008 829 M3 - M10	2506 829 M5 - M10	1858/1859 778 M5 - M20	2311 776 M5 - M10
MF	6HX	972/974 848 M5 x 0,5 - M20 x 1,5	1009 848 M10 x 1 - M16 x 1,5		1861/1860 792 M8 x 1 - M20 x 1,5	
UNC	2B					
UNF	2B					
UNF	-					

P					
M					
K	•	•	•	•	•
N	•	•		•	
S					
H					

Threading tools



Thread depth		3xD			
Tool material		HSS-E		VHM	
Type/form		A/B	N/B	H/C	N/C
Surface		○	Ⓞ	○	Ⓞ
Coolant supply		☒	☒	☒	☒
 Through-hole					
Thread type	Tol.	Article no./page			
M	6H	805/817 777 M1,6 - M20			
	6HX		4672 777 M2 - M16	1858/1859 778 M5 - M20	4675 778 M3 - M16
	6G				
MF	6H				
	6HX			1861/1860 792 M8 x 1 - M20 x 1,5	
UNC	2B				
UNF	2B				
G	-				

P					
M					
K				•	
N	•	•	•	•	•
S			○		
H					













Thread depth		3xD						
Tool material		HSS-E			VHM			
Type/form		AI R45/C	N R45/C	N R45/E	MS/E	N R15/C	N R15/C	N R15/E
Surface								
Coolant supply								
<p>Blind-hole</p>								
Thread type	Tol.	Article no./page						
M	6H	812/824 831 M1,6 - M20			800 830 M3 - M10			
	6HX		4670 832 M2 - M16	4671 832 M2 - M16		971 833 M3 - M10	4673 833 M3 - M16	4674 834 M3 - M16
	6G				1084 830 M3 - M10			
MF	6H							
	6HX					977/978 849 M4 x 0,5 - M18 x 1,5		
UNC	2B							
UNF	2B							
G	-							

P							
M							
K							
N		•	•	•	•	•	•
S			○	○			
H							

Threading tools



Thread depth	2xD	
Tool material	HSS-E-PM	
Type/form	Ti Ni/B	Ti Ni/B
Surface		
Coolant supply		
 Through-hole		
		
Thread type	Tol.	Article no./page
M	6HX	2901 779 M3 - M16 2916 779 M3 - M16
MF	6HX	2903 793 M3 x 0,35 - M10 x 1 2917 793 M3 x 0,35 - M10 x 1,25
UNC	2BX	2905 797 6 - 32 - 3/8 - 16 2918 797 6 - 32 - 3/8 - 16
UNF	2BX	2907 799 6 - 40 - 3/8 - 24 2919 799 6 - 40 - 3/8 - 24
MJ	4HX	1057 805 MJ3 x 0,5 - MJ16 x 2,0
MJF	4HX	1058 805 MJF6 x 0,5 - MJF10 x 1,25
UNJC	3BX	1059 806 6 - 32 - 5/8 - 11
UNJF	3BX	1060 806 6 - 40 - 5/8 - 18

Thread depth	2xD	
Tool material	HSS-E-PM	
Type/form	Ti R15/C	Ni R10/C
Surface		
Coolant supply		
 Blind-hole		
		
Thread type	Tol.	Article no./page
M	6HX	2909 834 M3 - M16 2920 834 M3 - M16
MF	6HX	2910 850 M3 x 0,35 - M10 x 1 2921 850 M3 x 0,35 - M10 x 1,25
UNC	2BX	2912 857 4 - 40 - 5/8 - 11 2922 857 4 - 40 - 5/8 - 11
UNF	2BX	2914 863 4 - 48 - 5/8 - 18 2923 863 4 - 48 - 5/8 - 18
MJ	4HX	1061 872 MJ3 x 0,5 - MJ16 x 2,0 1065 872 MJ3 x 0,5 - MJ16 x 2,0
MJF	4HX	1062 872 MJF6 x 0,5 - MJF10 x 1,25 1066 872 MJF6 x 0,5 - MJF10 x 1,25
UNJC	3BX	1063 873 6 - 32 - 5/8 - 11 1067 873 6 - 32 - 5/8 - 11
UNJF	3BX	1064 873 6 - 40 - 5/8 - 18 1068 873 6 - 40 - 5/8 - 18

P		
M		
K		
N		
S	•	•
H		

P		
M		
K		
N		
S	•	•
H		



Thread depth		3xD	
Tool material		HSS-E-PM	VHM
Type/form		H/D	H/D
Surface			
Coolant supply			
<p>Through- and blind hole</p>			
Thread type	Tol.	Article no./page	
M	6H		2944 877 M3 - M16
	6HX	1201 877 M3 - M16	
MF	6H		1161 881 M6 x 0,5 - M16 x 1,5
	6HX	4161 881 M6 x 0,75 - M16 x 1,5	
G	-	4607 888 G1/8 - G1/2	4599 888 G1/8 - G1/2

P		
M		
K		
N		
S		
H	•	•

Threading tools



Compass – Fluteless taps

Threading tools

Thread depth		1,5xD			3xD			
Tool material		HSS-E	HSS-E-PM	VHM	HSS-E			
Type/form		N/C	N/C	N/C	N/C	N/C	N/C	N/C
Surface								
Coolant supply								
<p>Through- and blind hole</p>								
Thread type	Tol.	Article no./page						
M	6HX	921/925 899 M1 - M16	1255/1256 899 M2 - M16	2518 900 M5 - M16	919/923 903 M3 - M39	1587/1589 903 M3 - M20	2442/2444 907 M5 - M16	2446/2448 908 M5 - M16
	6GX	920 900 M2 - M10	903 900 M2 - M10		918/922 905 M3 - M20	1588 906 M3 - M10	2443 909 M5 - M10	2447 909 M5 - M10
MF	6HX	929 902 M8 x 1 - M14 x 1,5			1275/927 914 M6 x 0,75 - M24 x 1,5			
	6GX				1277/926 915 M8 x 1 - M20 x 1,5			
UNC	2BX				1582/1583 919 4 - 40 - 3/4 - 10			
UNF	2BX				1584/1585 920 4 - 48 - 3/4 - 16			
G	-	966 902 G1/8 - G1 1/4			1586 921 G1/8 - G3/4			

P	•	•	•	•	•	•	•
M	•	•	○	•	•	•	•
K	○	○	○	○	○	○	○
N	○	○	○	○	○	○	•
S			○	○	○	○	○
H							



3xD							
HSS-E-PM						VHM	
		<i>Pionex</i>	<i>Pionex</i>	<i>Pionex</i>	<i>Pionex</i>		
N/C	N/C	N/C	N/E	N/C	N/E	N/C	N/E
S	S	C	C	C	C	C	C
☒	☐	☒	☒	☒	☒	☒	☒
1266/1267 903 M3 - M20	4143 910 M3 - M20	4487 890 M1 - M20	4494 891 M2 - M20	4485 892 M5 - M20	4483 892 M5 - M20	1972/1931 910 M3 - M20	1927 911 M3 - M10
		4488 890 M2 - M20	4703 891 M2 - M20	4705 892 M5 - M20	4707 892 M5 - M20		
1268/1269 914 M8 x 1 - M24 x 2	4145 916 M8 x 1 - M16 x 1,5	4489 893 M3 x 0,35 - M24 x 2	4495 894 M8 x 1 - M20 x 1,5	4486 895 M8 x 1 - M20 x 1,5	4484 896 M8 x 1 - M20 x 1,5	1581 917 M10 x 1 - M24 x 1,5	
		4490 893 M8 x 1 - M24 x 1,5	4704 894 M8 x 1 - M20 x 1,5	4706 895 M8 x 1 - M20 x 1,5	4708 896 M8 x 1 - M20 x 1,5		
		4491 897 4 - 40 - 3/4 - 10					
		4492 897 4 - 48 - 3/4 - 16					
		4493 898 G1/8 - G1/2					

Article no./page

Threading tools

•	•	•	•	•	•	•	•
•	•	•	•	•	•	○	○
○	○	•	•	•	•	○	○
○	○	•	•	•	•	•	•
○	○	•	•	•	•	○	○

N ≥ 7% Si N ≥ 7% Si N ≥ 7% Si N ≥ 7% Si



Thread depth		3xD				
Tool material		HSS-E				VHM
Type/form		N/C	N/C	N/E	N/C	N/C
Surface						
Coolant supply						
<p>Through- and blind hole</p>						
Thread type	Tol.	Article no./page				
M	6H					
	6HX	1347 901 M2 - M10	4676 911 M2 - M16	4677 913 M2 - M16	2515 912 M5 - M20	4678 913 M3 - M16
	6G	1565 901 M2 - M10			4146 912 M5 - M20	
MF	6H				4147 918 M8 x 1 - M16 x 1,5	
	6HX					
UNC	2B					
UNF	2B					
G	-				4152 921 G1/8 - G1	

P					
M					
K					
N	•	•	•	•	•
S					
H					

PIONEX

LONGER TOOL LIFE THANKS TO

30 PERCENT LESS TORQUE

- Advanced coating system reduces friction, improves chip removal and increases tool life
- Powder metallurgical steel as cutting material for high wear resistance
- Safe chip removal thanks to optimised flute geometry





Compass – Thread milling cutters

Threading tools

Thread depth	≤2xD				≤2,5xD		≤2xD			
Tool material	VHM									
Type/form	TM SP	TM SP	TM SP	TM SP	TM SP	TM SP	TMC SP	TMC SP	TMU SP	TMU SP
Surface										
Coolant supply										
Shank form	HA	HB	HA	HB	HA	HB	HA	HB	HA	HB
<p>Through- and blind hole</p>										
Thread type	Article no./page									
M	4132 922	4133 922	3737 922	3743 922	3735 923	3740 923	3526 926	3544 926	3541 928	3556 928
MF			3737 922	3743 922			3528 927	3546 927	3541 928	3556 928
UNC				4134 924	4135 924				3595 929	3596 929
UNF				4136 924	4137 924				3595 929	3596 929
UNEF									3595 929	3596 929
UNS									3595 929	3596 929
UN-8/UN-12/UN-16/UN-20									3595 929	3596 929
G [BSP]			3745 925	3748 925			3515 927	3533 927	3542 930	3557 930
Rp [BSPP]			3745 925	3748 925			3515 927	3533 927	3542 930	3557 930
NPT			3753 925	3754 925					3768 930	3769 930
NPTF										
Rc [BSPT, PT]										4770 931
EG M	EG threads can be produced with every thread milling cutter type and dimension									
EG UNC [STI]										
EG UNF [STI]										
MJ										
UNJC										
UNJF										

P	•	•	•	•	•	•	•	•	•	•
M	•	•	•	•	•	•	•	•	•	•
K	•	•	•	•	•	•	•	•	•	•
N	•	•	•	•	•	•	•	•	•	•
S	○	○	○	○	○	○	•	•	•	•
H	○	○	○	○	○	○	○	○	○	○



		SC-Line		≤2,5xD		≤3xD		≤2xD		≤2,5xD	
VHM											
TMU SP	TMU SP	SC-TMC SP	SC-MTM3 SP	MTMH3-Z	MTMH3 SP	MTM3 SP	MTM1 SP	MTMH3 SP	DTMC SP	DTMC SP	DTMC SP
HA	HB	HB	~ HA	~ HB	~ HA	HA	HA	HA	HA	HA	HA
Article no./page											
4162 931	4163 931	4000 936	4001 937	4002 938	4496 935	4226 932	4225 934	4227 935	3778 940	3779 940	3783 941
4162 931	4163 931	4000 936		4002 938			4225 934				
				4700 939		4223 932					
				4700 939		4223 932					
3542 930	3557 930			4780 939		4228 933					
3542 930	3557 930			4780 939		4228 933					
EG threads can be produced with every thread milling cutter type and dimension											
						4214 933					
						4215 934					
						4215 934					

Threading tools

•	•	•	•	•	○	•	•				
•	•	•	•	•		•	•				
•	•	•	•	•		•	•		○	○	○
•	•	○	•	•		•	•		•	•	•
•	•	○	•	•	•	•	•	○			
○	○		○	•	•	○	•				



Taps for ISO metric threads

Article no. **4218**



Cutting data page 958

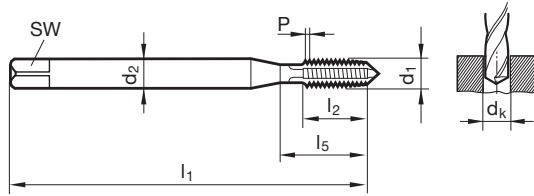
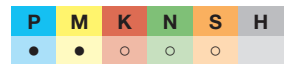

Standard **DIN 371/DIN 376**
Article no. **4218**

Taps

d1	P mm	d2 mm	SW mm	dk mm	l1 mm	l2 mm	l5 mm	Standard	Order no.
M2	0.400	2.80	2.10	1.60	45.00	8.00	13.50	DIN 371	4218 2.000
M2,5	0.450	2.80	2.10	2.05	50.00	9.00	14.50	DIN 371	4218 2.500
M3	0.500	3.50	2.70	2.50	56.00	10.00	18.00	DIN 371	4218 3.000
M4	0.700	4.50	3.40	3.30	63.00	12.00	21.00	DIN 371	4218 4.000
M4,5	0.750	6.00	4.90	3.70	70.00	14.00	25.00	DIN 371	4218 4.500
M5	0.800	6.00	4.90	4.20	70.00	14.00	25.00	DIN 371	4218 5.000
M6	1.000	6.00	4.90	5.00	80.00	16.00	30.00	DIN 371	4218 6.000
M7	1.000	7.00	5.50	6.00	80.00	16.00	30.00	DIN 371	4218 7.000
M8	1.250	8.00	6.20	6.80	90.00	17.00	35.00	DIN 371	4218 8.000
M9	1.250	9.00	7.00	7.80	90.00	17.00	35.00	DIN 371	4218 9.000
M10	1.500	10.00	8.00	8.50	100.00	20.00	39.00	DIN 371	4218 10.000
M11	1.500	8.00	6.20	9.50	100.00	20.00	42.00	DIN 376	4218 11.000
M12	1.750	9.00	7.00	10.20	110.00	24.00	49.00	DIN 376	4218 12.000
M14	2.000	11.00	9.00	12.00	110.00	26.00	53.00	DIN 376	4218 14.000
M16	2.000	12.00	9.00	14.00	110.00	26.00	54.00	DIN 376	4218 16.000
M18	2.500	14.00	11.00	15.50	125.00	30.00	62.00	DIN 376	4218 18.000
M20	2.500	16.00	12.00	17.50	140.00	32.00	62.00	DIN 376	4218 20.000
M22	2.500	18.00	14.50	19.50	140.00	32.00	62.00	DIN 376	4218 22.000
M24	3.000	18.00	14.50	21.00	160.00	36.00	73.00	DIN 376	4218 24.000
M27	3.000	20.00	16.00	24.00	160.00	36.00	73.00	DIN 376	4218 27.000
M30	3.500	22.00	18.00	26.50	180.00	40.00	85.00	DIN 376	4218 30.000
M33	3.500	25.00	20.00	29.50	180.00	40.00	91.00	DIN 376	4218 33.000
M36	4.000	28.00	22.00	32.00	200.00	50.00	102.00	DIN 376	4218 36.000
M39	4.000	32.00	24.00	35.00	200.00	50.00	107.00	DIN 376	4218 39.000
M42	4.500	32.00	24.00	37.50	200.00	56.00	112.00	DIN 376	4218 42.000

Taps for ISO metric threads

Article no. **4645**



Cutting data page 958



long design

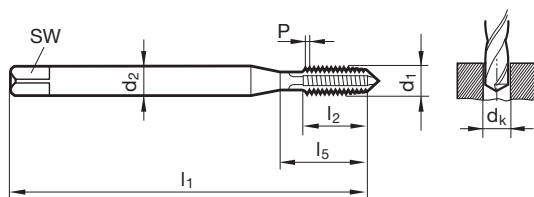

Standard **Company std.**
Article no. **4645**

d1	P mm	d2 mm	SW mm	dk mm	l1 mm	l2 mm	l5 mm	Standard	Order no.
M3	0.500	3.50	2.70	2.50	90.00	10.00	18.00	Company std.	4645 3.000
M4	0.700	4.50	3.40	3.30	125.00	12.00	21.00	Company std.	4645 4.000
M5	0.800	6.00	4.90	4.20	140.00	14.00	25.00	Company std.	4645 5.000
M6	1.000	6.00	4.90	5.00	160.00	16.00	30.00	Company std.	4645 6.000
M8	1.250	8.00	6.20	6.80	180.00	17.00	35.00	Company std.	4645 8.010
M10	1.500	10.00	8.00	8.50	200.00	20.00	39.00	Company std.	4645 10.010
M12	1.750	9.00	7.00	10.20	220.00	24.00	158.00	Company std.	4645 12.000
M14	2.000	11.00	9.00	12.00	220.00	26.00	160.00	Company std.	4645 14.000
M16	2.000	12.00	9.00	14.00	220.00	26.00	160.00	Company std.	4645 16.000
M20	2.500	16.00	12.00	17.50	280.00	32.00	217.00	Company std.	4645 20.000



Taps for ISO metric threads

Article no. 4638



Cutting data page 958



P	M	K	N	S	H
●	●	○	○	○	○

Taps for ISO metric threads

Article no. 4639



Cutting data page 958



P	M	K	N	S	H
●	●	○	○	○	○

Taps for ISO metric threads

Article no. 4640



Cutting data page 958



P	M	K	N	S	H
●	●	○	○	○	○

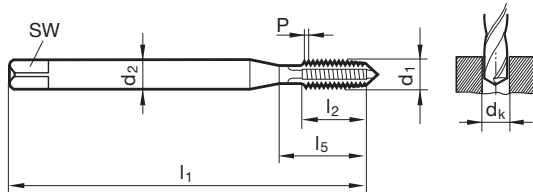

Standard
Article no.

DIN 371/DIN 376

4638	4639	4640
------	------	------

d1	P	d2	SW	dk	l1	l2	l5		Order no.		
mm	mm	mm	mm	mm	mm	mm	mm		4638	4639	4640
M2	0.400	2.80	2.10	1.60	45.00	8.00	13.50	DIN 371	4638 2.000	4639 2.000	4640 2.000
M2,5	0.450	2.80	2.10	2.05	50.00	9.00	14.50	DIN 371	4638 2.500	4639 2.500	4640 2.500
M3	0.500	3.50	2.70	2.50	56.00	10.00	18.00	DIN 371	4638 3.000	4639 3.000	4640 3.000
M4	0.700	4.50	3.40	3.30	63.00	12.00	21.00	DIN 371	4638 4.000	4639 4.000	4640 4.000
M5	0.800	6.00	4.90	4.20	70.00	14.00	25.00	DIN 371	4638 5.000	4639 5.000	4640 5.000
M6	1.000	6.00	4.90	5.00	80.00	16.00	30.00	DIN 371	4638 6.000	4639 6.000	4640 6.000
M8	1.250	8.00	6.20	6.80	90.00	17.00	35.00	DIN 371	4638 8.000	4639 8.000	4640 8.000
M10	1.500	10.00	8.00	8.50	100.00	20.00	39.00	DIN 371	4638 10.000	4639 10.000	4640 10.000
M12	1.750	9.00	7.00	10.20	110.00	24.00	49.00	DIN 376	4638 12.000	4639 12.000	4640 12.000
M14	2.000	11.00	9.00	12.00	110.00	26.00	53.00	DIN 376	4638 14.000	4639 14.000	4640 14.000
M16	2.000	12.00	9.00	14.00	110.00	26.00	54.00	DIN 376	4638 16.000	4639 16.000	4640 16.000
M18	2.500	14.00	11.00	15.50	125.00	30.00	62.00	DIN 376	4638 18.000	4639 18.000	4640 18.000
M20	2.500	16.00	12.00	17.50	140.00	32.00	62.00	DIN 376	4638 20.000	4639 20.000	4640 20.000
M24	3.000	18.00	14.50	21.00	160.00	36.00	73.00	DIN 376	4638 24.000	4639 24.000	4640 24.000
M30	3.500	22.00	18.00	26.50	180.00	40.00	85.00	DIN 376	4638 30.000	4639 30.000	4640 30.000

Taps



Taps for ISO metric threads

Article no. **4644**



Cutting data page 958

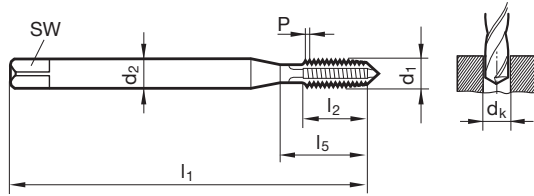
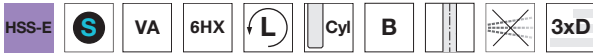

Standard **DIN 371/DIN 376**
Article no. **4644**

Taps

d1	P mm	d2 mm	SW mm	dk mm	l1 mm	l2 mm	l5 mm	Standard	Order no.
M2	0.400	2.80	2.10	1.60	45.00	8.00	13.50	DIN 371	4644 2.000
M2,5	0.450	2.80	2.10	2.05	50.00	9.00	14.50	DIN 371	4644 2.500
M3	0.500	3.50	2.70	2.50	56.00	10.00	18.00	DIN 371	4644 3.000
M4	0.700	4.50	3.40	3.30	63.00	12.00	21.00	DIN 371	4644 4.000
M5	0.800	6.00	4.90	4.20	70.00	14.00	25.00	DIN 371	4644 5.000
M6	1.000	6.00	4.90	5.00	80.00	16.00	30.00	DIN 371	4644 6.000
M8	1.250	8.00	6.20	6.80	90.00	17.00	35.00	DIN 371	4644 8.000
M10	1.500	10.00	8.00	8.50	100.00	20.00	39.00	DIN 371	4644 10.000
M12	1.750	9.00	7.00	10.20	110.00	24.00	49.00	DIN 376	4644 12.000
M14	2.000	11.00	9.00	12.00	110.00	26.00	53.00	DIN 376	4644 14.000
M16	2.000	12.00	9.00	14.00	110.00	26.00	54.00	DIN 376	4644 16.000
M18	2.500	14.00	11.00	15.50	125.00	30.00	62.00	DIN 376	4644 18.000
M20	2.500	16.00	12.00	17.50	140.00	32.00	62.00	DIN 376	4644 20.000
M24	3.000	18.00	14.50	21.00	160.00	36.00	73.00	DIN 376	4644 24.000
M30	3.500	22.00	18.00	26.50	180.00	40.00	85.00	DIN 376	4644 30.000



Taps for ISO metric threads

Article no. 4646



Cutting data page 958



P	M	K	N	S	H
●	●	○	○	○	○

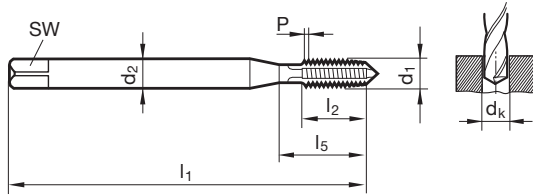

Standard	DIN 371/DIN 376
Article no.	4646

d1	P mm	d2 mm	SW mm	dk mm	l1 mm	l2 mm	l5 mm	Standard	Order no.
M3	0.500	3.50	2.70	2.50	56.00	10.00	18.00	DIN 371	4646 3.000
M4	0.700	4.50	3.40	3.30	63.00	12.00	21.00	DIN 371	4646 4.000
M5	0.800	6.00	4.90	4.20	70.00	14.00	25.00	DIN 371	4646 5.000
M6	1.000	6.00	4.90	5.00	80.00	16.00	30.00	DIN 371	4646 6.000
M8	1.250	8.00	6.20	6.80	90.00	17.00	35.00	DIN 371	4646 8.000
M10	1.500	10.00	8.00	8.50	100.00	20.00	39.00	DIN 371	4646 10.000
M12	1.750	9.00	7.00	10.20	110.00	24.00	49.00	DIN 376	4646 12.000
M14	2.000	11.00	9.00	12.00	110.00	26.00	53.00	DIN 376	4646 14.000
M16	2.000	12.00	9.00	14.00	110.00	26.00	54.00	DIN 376	4646 16.000
M20	2.500	16.00	12.00	17.50	140.00	32.00	62.00	DIN 376	4646 20.000

Taps

Taps for ISO metric threads

Article no. 4651



Cutting data page 958



P	M	K	N	S	H
●	●	○	○	○	○

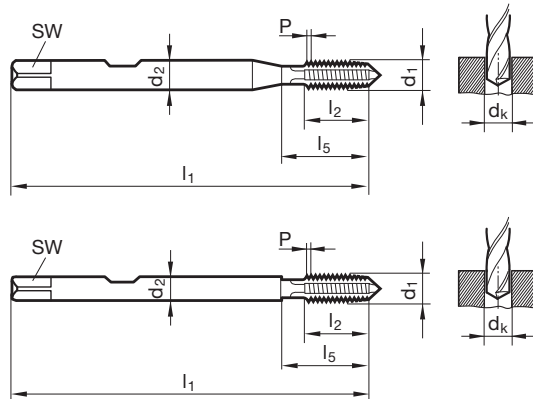

Standard	DIN 371/DIN 376
Article no.	4651

d1	P mm	d2 mm	SW mm	dk mm	l1 mm	l2 mm	l5 mm	Standard	Order no.
M3	0.500	6.00	4.90	2.50	56.00	10.00	18.00	~DIN 371	4651 3.000
M4	0.700	6.00	4.90	3.30	63.00	12.00	21.00	~DIN 371	4651 4.000
M5	0.800	6.00	4.90	4.20	70.00	14.00	25.00	DIN 371	4651 5.000
M6	1.000	6.00	4.90	5.00	80.00	16.00	30.00	DIN 371	4651 6.000
M8	1.250	8.00	6.20	6.80	90.00	17.00	35.00	DIN 371	4651 8.000
M10	1.500	10.00	8.00	8.50	100.00	20.00	39.00	DIN 371	4651 10.000
M12	1.750	12.00	9.00	10.20	110.00	24.00	24.00	~DIN 376	4651 12.000
M14	2.000	12.00	9.00	12.00	110.00	26.00	53.00	~DIN 376	4651 14.000
M16	2.000	12.00	9.00	14.00	110.00	26.00	54.00	DIN 376	4651 16.000
M20	2.500	16.00	12.00	17.50	140.00	32.00	62.00	DIN 376	4651 20.000



Taps with coolant ducts for ISO metric threads

Article no. **4648**



Cutting data page 958

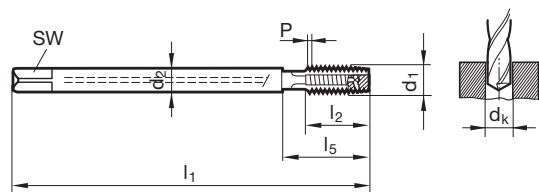
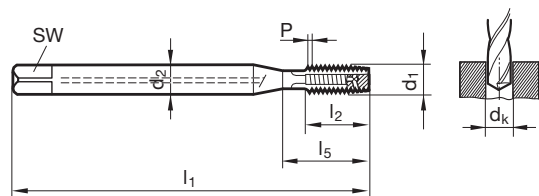
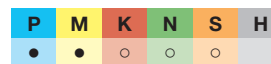

Taps

Standard **DIN 371/DIN 376**
Article no. **4648**

d1	P mm	d2 mm	SW mm	dk mm	l1 mm	l2 mm	l5 mm	Standard	Order no.
M5	0.800	6.00	4.90	4.20	70.00	14.00	25.00	DIN 371	4648 5.000
M6	1.000	6.00	4.90	5.00	80.00	16.00	30.00	DIN 371	4648 6.000
M8	1.250	8.00	6.20	6.80	90.00	17.00	35.00	DIN 371	4648 8.000
M10	1.500	10.00	8.00	8.50	100.00	20.00	39.00	DIN 371	4648 10.000
M12	1.750	9.00	7.00	10.20	110.00	24.00	49.00	DIN 376	4648 12.000
M14	2.000	11.00	9.00	12.00	110.00	26.00	53.00	DIN 376	4648 14.000
M16	2.000	12.00	9.00	14.00	110.00	26.00	54.00	DIN 376	4648 16.000
M20	2.500	16.00	12.00	17.50	140.00	32.00	62.00	DIN 376	4648 20.000
M24	3.000	18.00	14.50	21.00	160.00	36.00	73.00	DIN 376	4648 24.000
M30	3.500	22.00	18.00	26.50	180.00	40.00	85.00	DIN 376	4648 30.000



Taps for ISO metric fine threads

Article no. 4219



Cutting data page 958



P	M	K	N	S	H
●	●	○	○	○	○

Taps for ISO metric fine threads

Article no. 4641



Cutting data page 958



P	M	K	N	S	H
●	●	○	○	○	○

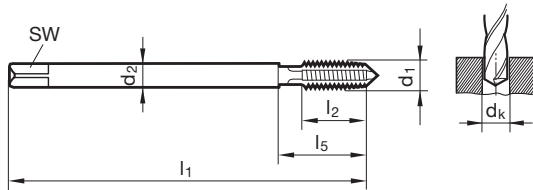

Standard
Article no.

DIN 374	
4219	4641

Taps

d1	d2 mm	SW mm	dk mm	l1 mm	l2 mm	l5 mm	Order no.
M3 x 0,35	2.20	1.80	2.65	56.00	7.00	18.00	4219 3.002
M4 x 0,35	2.80	2.10	3.65	63.00	8.00	21.00	4219 4.002
M4 x 0,5	2.80	2.10	3.50	63.00	8.00	21.00	4219 4.003
M5 x 0,5	3.50	2.70	4.50	70.00	10.00	25.00	4219 5.003
M6 x 0,5	4.50	3.40	5.50	80.00	13.00	30.00	4219 6.003
M6 x 0,75	4.50	3.40	5.20	80.00	13.00	30.00	4219 6.004
M8 x 0,75	6.00	4.90	7.20	80.00	14.00	30.00	4219 8.004
M8 x 1	6.00	4.90	7.00	90.00	17.00	35.00	4219 8.005
M9 x 1	7.00	5.50	8.00	90.00	16.00	35.00	4219 9.005
M10 x 0,75	7.00	5.50	9.20	90.00	16.00	35.00	4219 10.004
M10 x 1	7.00	5.50	9.00	90.00	16.00	35.00	4219 10.005
M10 x 1,25	7.00	5.50	8.80	100.00	20.00	39.00	4219 10.006
M11 x 1	8.00	6.20	10.00	90.00	20.00	33.00	4219 11.005
M12 x 1	9.00	7.00	11.00	100.00	20.00	40.00	4219 12.005
M12 x 1,25	9.00	7.00	10.80	100.00	20.00	40.00	4219 12.006
M12 x 1,5	9.00	7.00	10.50	100.00	20.00	40.00	4219 12.007
M14 x 1	11.00	9.00	13.00	100.00	20.00	40.00	4219 14.005
M14 x 1,25	11.00	9.00	12.80	100.00	20.00	40.00	4219 14.006
M14 x 1,5	11.00	9.00	12.50	100.00	20.00	40.00	4219 14.007
M16 x 1	12.00	9.00	15.00	100.00	22.00	44.00	4219 16.005
M16 x 1,5	12.00	9.00	14.50	100.00	22.00	44.00	4219 16.007
M18 x 1	14.00	11.00	17.00	110.00	25.00	44.00	4219 18.005
M18 x 1,5	14.00	11.00	16.50	110.00	25.00	44.00	4219 18.007
M18 x 2	14.00	11.00	16.00	125.00	30.00	58.00	4219 18.008
M20 x 1	16.00	12.00	19.00	125.00	25.00	44.00	4219 20.005
M20 x 1,5	16.00	12.00	18.50	125.00	25.00	44.00	4219 20.007
M20 x 2	16.00	12.00	18.00	140.00	32.00	60.00	4219 20.008
M22 x 1	18.00	14.50	21.00	125.00	25.00	44.00	4219 22.005
M22 x 1,5	18.00	14.50	20.50	125.00	25.00	44.00	4219 22.007
M22 x 2	18.00	14.50	20.00	140.00	32.00	62.00	4219 22.008
M24 x 1	18.00	14.50	23.00	140.00	28.00	48.00	4219 24.005
M24 x 1,5	18.00	14.50	22.50	140.00	28.00	48.00	4219 24.007
M24 x 2	18.00	14.50	22.00	140.00	28.00	48.00	4219 24.008

Taps for ISO metric fine threads

Article no. **4647**



Cutting data page 958

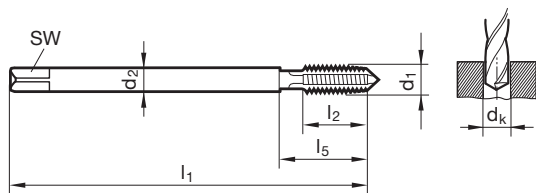
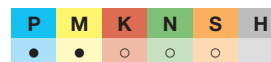

Standard

DIN 374

Article no.

4647

Taps

d1	d2 mm	SW mm	dk mm	l1 mm	l2 mm	l5 mm	Order no.
M8 x 1	6.00	4.90	7.00	90.00	17.00	35.00	4647 8.005
M10 x 1	7.00	5.50	9.00	90.00	16.00	35.00	4647 10.005
M10 x 1,25	7.00	5.50	8.80	100.00	20.00	39.00	4647 10.006
M12 x 1	9.00	7.00	11.00	100.00	20.00	40.00	4647 12.005
M12 x 1,25	9.00	7.00	10.80	100.00	20.00	40.00	4647 12.006
M12 x 1,5	9.00	7.00	10.50	100.00	20.00	40.00	4647 12.007
M14 x 1,5	11.00	9.00	12.50	100.00	20.00	40.00	4647 14.007
M16 x 1,5	12.00	9.00	14.50	100.00	22.00	44.00	4647 16.007
M18 x 1,5	14.00	11.00	16.50	110.00	25.00	44.00	4647 18.007
M20 x 1,5	16.00	12.00	18.50	125.00	25.00	44.00	4647 20.007
M24 x 1,5	18.00	14.50	22.50	140.00	28.00	48.00	4647 24.007

Taps with coolant ducts for ISO metric fine threads

Article no. **4649**



Cutting data page 958

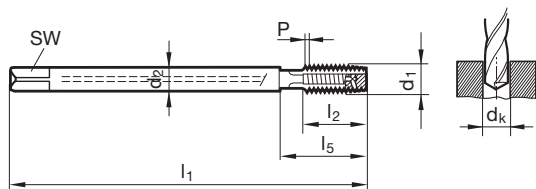
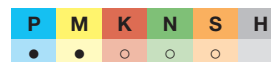

Standard

DIN 374

Article no.

4649

d1	d2 mm	SW mm	dk mm	l1 mm	l2 mm	l5 mm	Order no.
M8 x 1	6.00	4.90	7.00	90.00	17.00	35.00	4649 8.005
M10 x 1	7.00	5.50	9.00	90.00	16.00	35.00	4649 10.005
M10 x 1,25	7.00	5.50	8.80	100.00	20.00	39.00	4649 10.006
M12 x 1	9.00	7.00	11.00	100.00	20.00	40.00	4649 12.005
M12 x 1,25	9.00	7.00	10.80	100.00	20.00	40.00	4649 12.006
M12 x 1,5	9.00	7.00	10.50	100.00	20.00	40.00	4649 12.007
M14 x 1,5	11.00	9.00	12.50	100.00	20.00	40.00	4649 14.007
M16 x 1,5	12.00	9.00	14.50	100.00	22.00	44.00	4649 16.007
M18 x 1,5	14.00	11.00	16.50	110.00	25.00	44.00	4649 18.007
M20 x 1,5	16.00	12.00	18.50	125.00	25.00	44.00	4649 20.007
M24 x 1,5	18.00	14.50	22.50	140.00	28.00	48.00	4649 24.007



Taps for UNC threads

Article no. 4642



Cutting data page 958



P	M	K	N	S	H
●	●	○	○	○	○

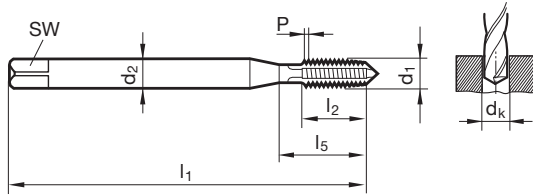

Standard ~DIN 371/~DIN 376
Article no. 4642

d1	d2 mm	SW mm	dk mm	l1 mm	l2 mm	l5 mm		Order no.
2 - 56	2.80	2.10	1.85	45.00	9.00	14.50	~DIN 371	4642 2.184
4 - 40	3.50	2.70	2.35	56.00	11.00	18.00	~DIN 371	4642 2.845
6 - 32	4.00	3.00	2.85	56.00	12.00	20.00	~DIN 371	4642 3.505
8 - 32	4.50	3.40	3.50	63.00	12.00	21.00	~DIN 371	4642 4.166
10 - 24	6.00	4.90	3.90	70.00	14.00	25.00	~DIN 371	4642 4.826
12 - 24	6.00	4.90	4.50	80.00	16.00	30.00	~DIN 371	4642 5.486
1/4 - 20	7.00	5.50	5.10	80.00	16.00	30.00	~DIN 371	4642 6.350
5/16 - 18	8.00	6.20	6.60	90.00	18.00	35.00	~DIN 371	4642 7.938
3/8 - 16	10.00	8.00	8.00	100.00	20.00	39.00	~DIN 371	4642 9.525
7/16 - 14	8.00	6.20	9.40	100.00	22.00	42.00	~DIN 376	4642 11.113
1/2 - 13	9.00	7.00	10.80	110.00	25.00	49.00	~DIN 376	4642 12.700
9/16 - 12	11.00	9.00	12.20	110.00	28.00	53.00	~DIN 376	4642 14.288
5/8 - 11	12.00	9.00	13.50	110.00	30.00	53.00	~DIN 376	4642 15.875
3/4 - 10	14.00	11.00	16.50	125.00	33.00	62.00	~DIN 376	4642 19.050
7/8 - 9	18.00	14.50	19.50	140.00	35.00	62.00	~DIN 376	4642 22.225
1 - 8	18.00	14.50	22.25	160.00	38.00	73.00	~DIN 376	4642 25.400

Taps

Taps for UNF threads

Article no. 4643



Cutting data page 958



P	M	K	N	S	H
●	●	○	○	○	○

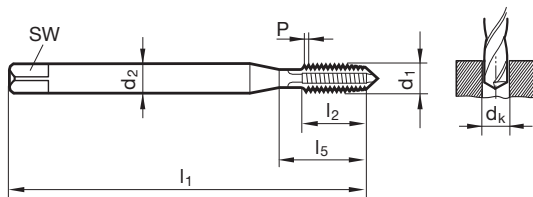

Standard ~DIN 371/~DIN 374
Article no. 4643

d1	d2 mm	SW mm	dk mm	l1 mm	l2 mm	l5 mm		Order no.
2 - 64	2.80	2.10	1.85	45.00	9.00	14.50	~DIN 371	4643 2.184
4 - 48	3.50	2.70	2.40	56.00	10.00	18.00	~DIN 371	4643 2.845
6 - 40	4.00	3.00	2.95	56.00	11.00	20.00	~DIN 371	4643 3.505
8 - 36	4.50	3.40	3.50	63.00	12.00	21.00	~DIN 371	4643 4.166
10 - 32	6.00	4.90	4.10	70.00	14.00	25.00	~DIN 371	4643 4.826
12 - 28	6.00	4.90	4.60	80.00	16.00	30.00	~DIN 371	4643 5.486
1/4 - 28	7.00	5.50	5.50	80.00	16.00	30.00	~DIN 371	4643 6.350
5/16 - 24	8.00	6.20	6.90	90.00	17.00	35.00	~DIN 371	4643 7.938
3/8 - 24	10.00	8.00	8.50	90.00	18.00	35.00	~DIN 371	4643 9.525
7/16 - 20	8.00	6.20	9.90	100.00	22.00	42.00	~DIN 374	4643 11.113
1/2 - 20	9.00	7.00	11.50	100.00	20.00	40.00	~DIN 374	4643 12.700
9/16 - 18	11.00	9.00	12.90	100.00	22.00	40.00	~DIN 374	4643 14.288
5/8 - 18	12.00	9.00	14.50	100.00	22.00	44.00	~DIN 374	4643 15.875
3/4 - 16	14.00	11.00	17.50	110.00	25.00	44.00	~DIN 374	4643 19.050
7/8 - 14	18.00	14.50	20.40	125.00	25.00	44.00	~DIN 374	4643 22.225
1 - 12	18.00	14.50	23.25	140.00	28.00	50.00	~DIN 374	4643 25.400

Taps for BSP threads

Article no. **4220**



Cutting data page 958



P	M	K	N	S	H
●	●	○	○	○	○

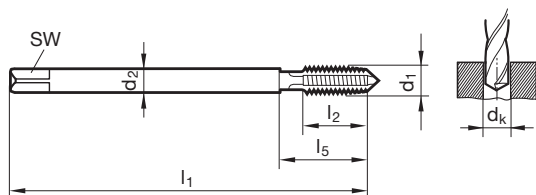

Standard	DIN 5156
Article no.	4220

Taps

d1	d2 mm	SW mm	dk mm	l1 mm	l2 mm	l5 mm		Order no.
G1/16	6.00	4.90	6.80	90.00	18.00	30.00	DIN 5156	4220 7.723
G1/8	7.00	5.50	8.80	90.00	18.00	35.00	DIN 5156	4220 9.728
G1/4	11.00	9.00	11.80	100.00	20.00	40.00	DIN 5156	4220 13.157
G3/8	12.00	9.00	15.25	100.00	22.00	44.00	DIN 5156	4220 16.662
G1/2	16.00	12.00	19.00	125.00	25.00	44.00	DIN 5156	4220 20.955
G5/8	18.00	14.50	21.00	125.00	25.00	48.00	DIN 5156	4220 22.911
G3/4	20.00	16.00	24.50	140.00	28.00	53.00	DIN 5156	4220 26.441
G7/8	22.00	18.00	28.25	150.00	28.00	53.00	DIN 5156	4220 30.201
G1	25.00	20.00	30.75	160.00	30.00	56.00	DIN 5156	4220 33.249

Taps for BSP threads

Article no. **4682**



Cutting data page 958



P	M	K	N	S	H
●	●	○	○	○	○

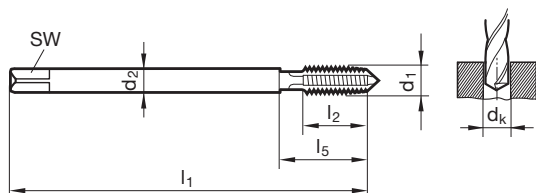

Standard	DIN 5156
Article no.	4682

d1	d2 mm	SW mm	dk mm	l1 mm	l2 mm	l5 mm		Order no.
Rp1/16	6.00	4.90	6.55	90.00	18.00	30.00		4682 7.723
Rp1/8	7.00	5.50	8.60	90.00	18.00	35.00		4682 9.728
Rp1/4	11.00	9.00	11.50	100.00	20.00	40.00		4682 13.157
Rp3/8	12.00	9.00	15.00	100.00	22.00	44.00		4682 16.662
Rp1/2	16.00	12.00	18.50	125.00	25.00	44.00		4682 20.955
Rp3/4	20.00	16.00	24.00	140.00	28.00	53.00		4682 26.441
Rp1	25.00	20.00	30.25	160.00	30.00	56.00		4682 33.249



Taps for BSW threads

Article no. 4680



Cutting data page 958



P	M	K	N	S	H
●	●	○	○	○	

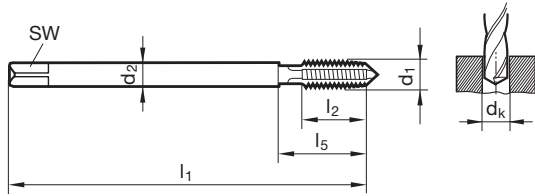

								Standard	~DIN 371
								Article no.	4680
d1	P	d2	SW	dk	l1	l2	l5	Order no.	
	G/inch	mm	mm	mm	mm	mm	mm		
W1/8	40	3.50	2.70	2.50	56.00	11.00	18.00	4680 3.175	
W3/16	24	6.00	4.90	3.60	70.00	14.00	25.00	4680 4.762	
W1/4	20	7.00	5.50	5.10	80.00	16.00	30.00	4680 6.350	
W5/16	18	8.00	6.20	6.50	90.00	18.00	35.00	4680 7.938	
W3/8	16	10.00	8.00	7.90	100.00	20.00	39.00	4680 9.525	
W7/16	14	8.00	6.20	9.20	100.00	22.00	42.00	4680 11.113	
W1/2	12	9.00	7.00	10.50	110.00	25.00	49.00	4680 12.700	
W5/8	11	12.00	9.00	13.50	110.00	30.00	53.00	4680 15.876	
W3/4	10	14.00	11.00	16.25	125.00	33.00	62.00	4680 19.051	
W7/8	9	18.00	14.50	19.25	140.00	35.00	62.00	4680 22.226	
W1	8	18.00	14.50	22.00	160.00	38.00	73.00	4680 25.401	

Taps



Taps for ISO metric threads

Article no. **393**



Cutting data page 958



P	M	K	N	S	H
●	●	○	○	○	○

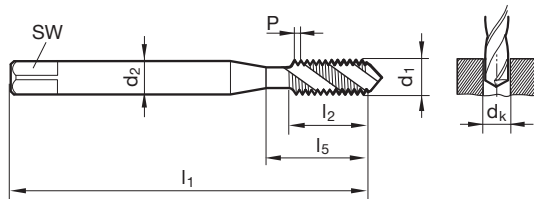

Standard **DIN 371/DIN 376**
Article no. **393**

Taps

d1	P mm	d2 mm	SW mm	dk mm	l1 mm	l2 mm	l5 mm	Standard	Order no.
M2	0.400	2.80	2.10	1.60	45.00	4.50	13.50	DIN 371	393 2.000
M2,5	0.450	2.80	2.10	2.05	50.00	5.00	14.50	DIN 371	393 2.500
M3	0.500	3.50	2.70	2.50	56.00	6.00	18.00	DIN 371	393 3.000
M3,5	0.600	4.00	3.00	2.90	56.00	7.00	20.00	DIN 371	393 3.500
M4	0.700	4.50	3.40	3.30	63.00	7.50	21.00	DIN 371	393 4.000
M4,5	0.750	6.00	4.90	3.70	70.00	8.50	25.00	DIN 371	393 4.500
M5	0.800	6.00	4.90	4.20	70.00	8.50	25.00	DIN 371	393 5.000
M6	1.000	6.00	4.90	5.00	80.00	11.00	30.00	DIN 371	393 6.000
M7	1.000	7.00	5.50	6.00	80.00	11.00	30.00	DIN 371	393 7.000
M8	1.250	8.00	6.20	6.80	90.00	14.00	35.00	DIN 371	393 8.000
M9	1.250	9.00	7.00	7.80	90.00	14.00	35.00	DIN 371	393 9.000
M10	1.500	10.00	8.00	8.50	100.00	16.00	39.00	DIN 371	393 10.000
M11	1.500	8.00	6.20	9.50	100.00	16.00	42.00	DIN 376	393 11.000
M12	1.750	9.00	7.00	10.20	110.00	18.50	49.00	DIN 376	393 12.000
M14	2.000	11.00	9.00	12.00	110.00	20.00	53.00	DIN 376	393 14.000
M16	2.000	12.00	9.00	14.00	110.00	20.00	54.00	DIN 376	393 16.000
M18	2.500	14.00	11.00	15.50	125.00	25.00	62.00	DIN 376	393 18.000
M20	2.500	16.00	12.00	17.50	140.00	25.00	62.00	DIN 376	393 20.000
M22	2.500	18.00	14.50	19.50	140.00	27.00	62.00	DIN 376	393 22.000
M24	3.000	18.00	14.50	21.00	160.00	30.00	73.00	DIN 376	393 24.000
M27	3.000	20.00	16.00	24.00	160.00	30.00	73.00	DIN 376	393 27.000
M30	3.500	22.00	18.00	26.50	180.00	35.00	85.00	DIN 376	393 30.000
M33	3.500	25.00	20.00	29.50	180.00	40.00	91.00	DIN 376	393 33.000
M36	4.000	28.00	22.00	32.00	200.00	40.00	102.00	DIN 376	393 36.000
M39	4.000	32.00	24.00	35.00	200.00	50.00	107.00	DIN 376	393 39.000
M42	4.500	32.00	24.00	37.50	200.00	45.00	112.00	DIN 376	393 42.000

Taps for ISO metric threads

Article no. **4633**



Cutting data page 958



long design

P	M	K	N	S	H
●	●	○	○	○	○



Standard **Company std.**
Article no. **4633**

d1	P mm	d2 mm	SW mm	dk mm	l1 mm	l2 mm	l5 mm	Standard	Order no.
M3	0.500	3.50	2.70	2.50	90.00	6.00	18.00	Company std.	4633 3.000
M4	0.700	4.50	3.40	3.30	125.00	7.50	21.00	Company std.	4633 4.000
M5	0.800	6.00	4.90	4.20	140.00	8.50	25.00	Company std.	4633 5.000
M6	1.000	6.00	4.90	5.00	160.00	11.00	30.00	Company std.	4633 6.000
M8	1.250	8.00	6.20	6.80	180.00	14.00	35.00	Company std.	4633 8.010
M10	1.500	10.00	8.00	8.50	200.00	16.00	39.00	Company std.	4633 10.010
M12	1.750	9.00	7.00	10.20	220.00	18.50	158.00	Company std.	4633 12.000
M14	2.000	11.00	9.00	12.00	220.00	20.00	160.00	Company std.	4633 14.000
M16	2.000	12.00	9.00	14.00	220.00	20.00	160.00	Company std.	4633 16.000
M20	2.500	16.00	12.00	17.50	280.00	25.00	217.00	Company std.	4633 20.000



Taps for ISO metric threads

Article no. 4625



Cutting data page 958



P	M	K	N	S	H
●	●	○	○	○	○

Taps for ISO metric threads

Article no. 4626



Cutting data page 958



P	M	K	N	S	H
●	●	○	○	○	○

Taps for ISO metric threads

Article no. 4627



Cutting data page 958



P	M	K	N	S	H
●	●	○	○	○	○

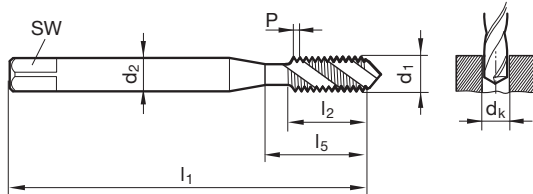

Standard
Article no.

DIN 371/DIN 376

4625	4626	4627
------	------	------

d1	P	d2	SW	dk	l1	l2	l5		Order no.		
mm	mm	mm	mm	mm	mm	mm	mm		4625	4626	4627
M2	0.400	2.80	2.10	1.60	45.00	4.50	13.50	DIN 371	4625 2.000	4626 2.000	4627 2.000
M2,5	0.450	2.80	2.10	2.05	50.00	5.00	14.50	DIN 371	4625 2.500	4626 2.500	4627 2.500
M3	0.500	3.50	2.70	2.50	56.00	6.00	18.00	DIN 371	4625 3.000	4626 3.000	4627 3.000
M3,5	0.600	4.00	3.00	2.90	56.00	7.00	20.00	DIN 371	4625 3.500	4626 3.500	4627 3.500
M4	0.700	4.50	3.40	3.30	63.00	7.50	21.00	DIN 371	4625 4.000	4626 4.000	4627 4.000
M5	0.800	6.00	4.90	4.20	70.00	8.50	25.00	DIN 371	4625 5.000	4626 5.000	4627 5.000
M6	1.000	6.00	4.90	5.00	80.00	11.00	30.00	DIN 371	4625 6.000	4626 6.000	4627 6.000
M8	1.250	8.00	6.20	6.80	90.00	14.00	35.00	DIN 371	4625 8.000	4626 8.000	4627 8.000
M10	1.500	10.00	8.00	8.50	100.00	16.00	39.00	DIN 371	4625 10.000	4626 10.000	4627 10.000
M12	1.750	9.00	7.00	10.20	110.00	18.50	49.00	DIN 376	4625 12.000	4626 12.000	4627 12.000
M14	2.000	11.00	9.00	12.00	110.00	20.00	53.00	DIN 376	4625 14.000	4626 14.000	4627 14.000
M16	2.000	12.00	9.00	14.00	110.00	20.00	54.00	DIN 376	4625 16.000	4626 16.000	4627 16.000
M18	2.500	14.00	11.00	15.50	125.00	25.00	62.00	DIN 376	4625 18.000	4626 18.000	4627 18.000
M20	2.500	16.00	12.00	17.50	140.00	25.00	62.00	DIN 376	4625 20.000	4626 20.000	4627 20.000
M24	3.000	18.00	14.50	21.00	160.00	30.00	73.00	DIN 376	4625 24.000	4626 24.000	4627 24.000
M30	3.500	22.00	18.00	26.50	180.00	35.00	85.00	DIN 376	4625 30.000	4626 30.000	4627 30.000

Taps



Taps for ISO metric threads

Article no. **4630**



Cutting data page 958



P	M	K	N	S	H
●	●	○	○	○	○

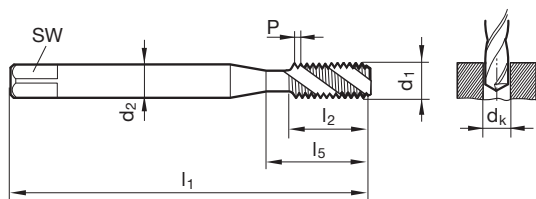

Standard	DIN 371/DIN 376
Article no.	4630

Taps

d1	P mm	d2 mm	SW mm	dk mm	l1 mm	l2 mm	l5 mm	Standard	Order no.
M2	0.400	2.80	2.10	1.60	45.00	4.50	13.50	DIN 371	4630 2.000
M2,5	0.450	2.80	2.10	2.05	50.00	5.00	14.50	DIN 371	4630 2.500
M3	0.500	3.50	2.70	2.50	56.00	6.00	18.00	DIN 371	4630 3.000
M3,5	0.600	4.00	3.00	2.90	56.00	7.00	20.00	DIN 371	4630 3.500
M4	0.700	4.50	3.40	3.30	63.00	7.50	21.00	DIN 371	4630 4.000
M5	0.800	6.00	4.90	4.20	70.00	8.50	25.00	DIN 371	4630 5.000
M6	1.000	6.00	4.90	5.00	80.00	11.00	30.00	DIN 371	4630 6.000
M8	1.250	8.00	6.20	6.80	90.00	14.00	35.00	DIN 371	4630 8.000
M10	1.500	10.00	8.00	8.50	100.00	16.00	39.00	DIN 371	4630 10.000
M12	1.750	9.00	7.00	10.20	110.00	18.50	49.00	DIN 376	4630 12.000
M14	2.000	11.00	9.00	12.00	110.00	20.00	53.00	DIN 376	4630 14.000
M16	2.000	12.00	9.00	14.00	110.00	20.00	54.00	DIN 376	4630 16.000
M18	2.500	14.00	11.00	15.50	125.00	25.00	62.00	DIN 376	4630 18.000
M20	2.500	16.00	12.00	17.50	140.00	25.00	62.00	DIN 376	4630 20.000
M24	3.000	18.00	14.50	21.00	160.00	30.00	73.00	DIN 376	4630 24.000
M30	3.500	22.00	18.00	26.50	180.00	35.00	85.00	DIN 376	4630 30.000

Taps for ISO metric threads

Article no. **4629**



Cutting data page 958



P	M	K	N	S	H
●	●	○	○	○	○

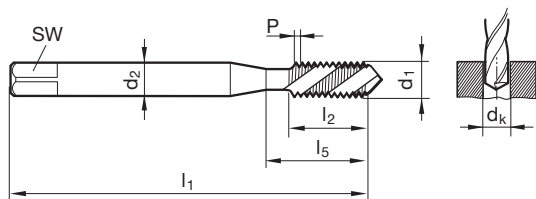

Standard	DIN 371/DIN 376
Article no.	4629

d1	P mm	d2 mm	SW mm	dk mm	l1 mm	l2 mm	l5 mm	Standard	Order no.
M2	0.400	2.80	2.10	1.60	45.00	4.50	13.50	DIN 371	4629 2.000
M2,5	0.450	2.80	2.10	2.05	50.00	5.00	14.50	DIN 371	4629 2.500
M3	0.500	3.50	2.70	2.50	56.00	6.00	18.00	DIN 371	4629 3.000
M3,5	0.600	4.00	3.00	2.90	56.00	7.00	20.00	DIN 371	4629 3.500
M4	0.700	4.50	3.40	3.30	63.00	7.50	21.00	DIN 371	4629 4.000
M5	0.800	6.00	4.90	4.20	70.00	8.50	25.00	DIN 371	4629 5.000
M6	1.000	6.00	4.90	5.00	80.00	11.00	30.00	DIN 371	4629 6.000
M8	1.250	8.00	6.20	6.80	90.00	14.00	35.00	DIN 371	4629 8.000
M10	1.500	10.00	8.00	8.50	100.00	16.00	39.00	DIN 371	4629 10.000
M12	1.750	9.00	7.00	10.20	110.00	18.50	49.00	DIN 376	4629 12.000
M14	2.000	11.00	9.00	12.00	110.00	20.00	53.00	DIN 376	4629 14.000
M16	2.000	12.00	9.00	14.00	110.00	20.00	54.00	DIN 376	4629 16.000
M18	2.500	14.00	11.00	15.50	125.00	25.00	62.00	DIN 376	4629 18.000
M20	2.500	16.00	12.00	17.50	140.00	25.00	62.00	DIN 376	4629 20.000
M24	3.000	18.00	14.50	21.00	160.00	30.00	73.00	DIN 376	4629 24.000
M30	3.500	22.00	18.00	26.50	180.00	35.00	85.00	DIN 376	4629 30.000



Taps for ISO metric threads

Article no. 4634



Cutting data page 958



P	M	K	N	S	H
●	●	○	○	○	○

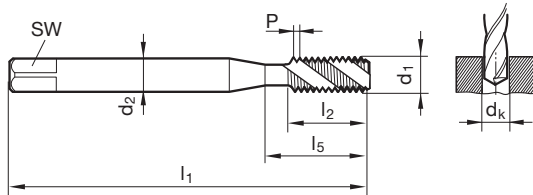

Standard	DIN 371/DIN 376
Article no.	4634

d1	P mm	d2 mm	SW mm	dk mm	l1 mm	l2 mm	l5 mm	Standard	Order no.
M3	0.500	3.50	2.70	2.50	56.00	6.00	18.00	DIN 371	4634 3.000
M4	0.700	4.50	3.40	3.30	63.00	7.50	21.00	DIN 371	4634 4.000
M5	0.800	6.00	4.90	4.20	70.00	8.50	25.00	DIN 371	4634 5.000
M6	1.000	6.00	4.90	5.00	80.00	11.00	30.00	DIN 371	4634 6.000
M8	1.250	8.00	6.20	6.80	90.00	14.00	35.00	DIN 371	4634 8.000
M10	1.500	10.00	8.00	8.50	100.00	16.00	39.00	DIN 371	4634 10.000
M12	1.750	9.00	7.00	10.20	110.00	18.50	49.00	DIN 376	4634 12.000
M14	2.000	11.00	9.00	12.00	110.00	20.00	53.00	DIN 376	4634 14.000
M16	2.000	12.00	9.00	14.00	110.00	20.00	54.00	DIN 376	4634 16.000
M20	2.500	16.00	12.00	17.50	140.00	25.00	62.00	DIN 376	4634 20.000

Taps

Taps for ISO metric threads

Article no. 4650



Cutting data page 958



P	M	K	N	S	H
●	●	○	○	○	○

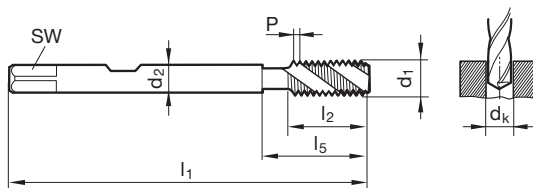
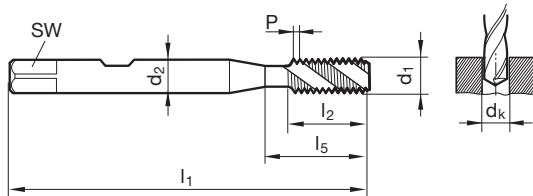

Standard	DIN 371/DIN 376
Article no.	4650

d1	P mm	d2 mm	SW mm	dk mm	l1 mm	l2 mm	l5 mm	Standard	Order no.
M3	0.500	6.00	4.90	2.50	56.00	6.00	18.00	~DIN 371	4650 3.000
M4	0.700	6.00	4.90	3.30	63.00	7.50	21.00	~DIN 371	4650 4.000
M5	0.800	6.00	4.90	4.20	70.00	8.50	25.00	DIN 371	4650 5.000
M6	1.000	6.00	4.90	5.00	80.00	11.00	30.00	DIN 371	4650 6.000
M8	1.250	8.00	6.20	6.80	90.00	14.00	35.00	DIN 371	4650 8.000
M10	1.500	10.00	8.00	8.50	100.00	16.00	39.00	DIN 371	4650 10.000
M12	1.750	12.00	9.00	10.20	110.00	18.50	49.00	~DIN 371	4650 12.000
M14	2.000	12.00	9.00	12.00	110.00	20.00	53.00	~DIN 376	4650 14.000
M16	2.000	12.00	9.00	14.00	110.00	20.00	54.00	DIN 376	4650 16.000
M20	2.500	16.00	12.00	17.50	140.00	25.00	62.00	DIN 376	4650 20.000



Taps with coolant ducts for ISO metric threads

Article no. **4636**



Cutting data page 958

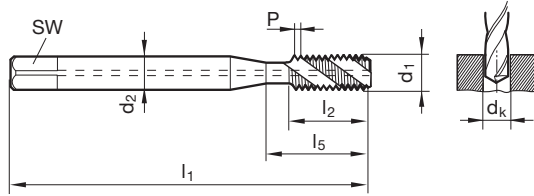
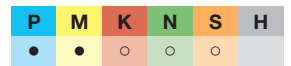

Standard **DIN 371/DIN 376**
Article no. **4636**

Taps

d1	P mm	d2 mm	SW mm	dk mm	l1 mm	l2 mm	l5 mm	Standard	Order no.
M5	0.800	6.00	4.90	4.20	70.00	8.50	25.00	DIN 371	4636 5.000
M6	1.000	6.00	4.90	5.00	80.00	11.00	30.00	DIN 371	4636 6.000
M8	1.250	8.00	6.20	6.80	90.00	14.00	35.00	DIN 371	4636 8.000
M10	1.500	10.00	8.00	8.50	100.00	16.00	39.00	DIN 371	4636 10.000
M12	1.750	9.00	7.00	10.20	110.00	18.50	49.00	DIN 376	4636 12.000
M14	2.000	11.00	9.00	12.00	110.00	20.00	53.00	DIN 376	4636 14.000
M16	2.000	12.00	9.00	14.00	110.00	20.00	54.00	DIN 376	4636 16.000
M20	2.500	16.00	12.00	17.50	140.00	25.00	62.00	DIN 376	4636 20.000
M24	3.000	18.00	14.50	21.00	160.00	30.00	73.00	DIN 376	4636 24.000
M30	3.500	22.00	18.00	26.50	180.00	35.00	85.00	DIN 376	4636 30.000



Taps for ISO metric fine threads

Article no. 394



Cutting data page 958



P	M	K	N	S	H
●	●	○	○	○	○

Taps for ISO metric fine threads

Article no. 4628



Cutting data page 958



P	M	K	N	S	H
●	●	○	○	○	○

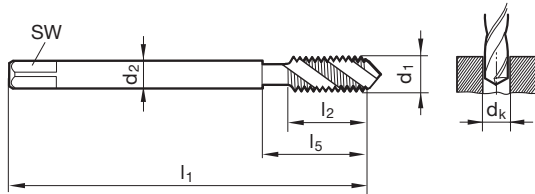

Standard	DIN 374	
Article no.	394	4628

Taps

d1	d2 mm	SW mm	dk mm	l1 mm	l2 mm	l5 mm	Order no.
M3 x 0,35	2.20	1.80	2.65	56.00	4.00	18.00	394 3.002
M4 x 0,35	2.80	2.10	3.65	63.00	5.00	21.00	394 4.002
M4 x 0,5	2.80	2.10	3.50	63.00	5.00	21.00	394 4.003
M5 x 0,5	3.50	2.70	4.50	70.00	5.00	25.00	394 5.003
M6 x 0,5	4.50	3.40	5.50	80.00	5.00	30.00	394 6.003
M6 x 0,75	4.50	3.40	5.20	80.00	8.00	30.00	394 6.004
M8 x 0,75	6.00	4.90	7.20	80.00	8.00	30.00	394 8.004
M8 x 1	6.00	4.90	7.00	90.00	11.00	35.00	394 8.005
M9 x 1	7.00	5.50	8.00	90.00	11.00	35.00	394 9.005
M10 x 0,75	7.00	5.50	9.20	90.00	11.00	35.00	394 10.004
M10 x 1	7.00	5.50	9.00	90.00	11.00	35.00	394 10.005
M10 x 1,25	7.00	5.50	8.80	100.00	14.00	39.00	394 10.006
M11 x 1	8.00	6.20	10.00	90.00	11.00	33.00	394 11.005
M12 x 1	9.00	7.00	11.00	100.00	11.00	40.00	394 12.005
M12 x 1,25	9.00	7.00	10.80	100.00	15.00	40.00	394 12.006
M12 x 1,5	9.00	7.00	10.50	100.00	15.00	40.00	394 12.007
M14 x 1	11.00	9.00	13.00	100.00	11.00	40.00	394 14.005
M14 x 1,25	11.00	9.00	12.80	100.00	15.00	40.00	394 14.006
M14 x 1,5	11.00	9.00	12.50	100.00	15.00	40.00	394 14.007
M16 x 1	12.00	9.00	15.00	100.00	11.00	44.00	394 16.005
M16 x 1,5	12.00	9.00	14.50	100.00	15.00	44.00	394 16.007
M18 x 1	14.00	11.00	17.00	110.00	12.00	44.00	394 18.005
M18 x 1,5	14.00	11.00	16.50	110.00	16.00	44.00	394 18.007
M18 x 2	14.00	11.00	16.00	125.00	20.00	58.00	394 18.008
M20 x 1	16.00	12.00	19.00	125.00	12.00	44.00	394 20.005
M20 x 1,5	16.00	12.00	18.50	125.00	16.00	44.00	394 20.007
M20 x 2	16.00	12.00	18.00	140.00	20.00	60.00	394 20.008
M22 x 1	18.00	14.50	21.00	125.00	12.00	44.00	394 22.005
M22 x 1,5	18.00	14.50	20.50	125.00	16.00	44.00	394 22.007
M22 x 2	18.00	14.50	20.00	140.00	22.00	62.00	394 22.008
M24 x 1	18.00	14.50	23.00	140.00	15.00	48.00	394 24.005
M24 x 1,5	18.00	14.50	22.50	140.00	16.00	48.00	394 24.007
M24 x 2	18.00	14.50	22.00	140.00	22.00	48.00	394 24.008



Taps for ISO metric fine threads

Article no. **4631**



Cutting data page 958

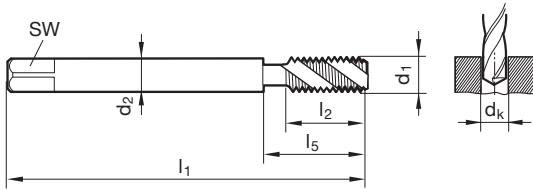
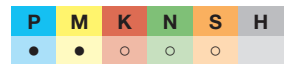

Standard

DIN 374

Article no.

4631

Taps

	d1	d2	SW	dk	l1	l2	l5	Order no.
		mm	mm	mm	mm	mm	mm	
	M6 x 0,75	4.50	3.40	5.20	80.00	8.00	30.00	4631 6.004
	M8 x 0,75	6.00	4.90	7.20	80.00	8.00	30.00	4631 8.004
	M8 x 1	6.00	4.90	7.00	90.00	11.00	35.00	4631 8.005
	M10 x 1	7.00	5.50	9.00	90.00	11.00	35.00	4631 10.005
	M10 x 1,25	7.00	5.50	8.80	100.00	14.00	39.00	4631 10.006
	M12 x 1	9.00	7.00	11.00	100.00	11.00	40.00	4631 12.005
	M12 x 1,25	9.00	7.00	10.80	100.00	15.00	40.00	4631 12.006
	M12 x 1,5	9.00	7.00	10.50	100.00	15.00	40.00	4631 12.007
	M14 x 1,5	11.00	9.00	12.50	100.00	15.00	40.00	4631 14.007
	M16 x 1,5	12.00	9.00	14.50	100.00	15.00	44.00	4631 16.007
	M18 x 1,5	14.00	11.00	16.50	110.00	16.00	44.00	4631 18.007
	M20 x 1,5	16.00	12.00	18.50	125.00	16.00	44.00	4631 20.007
	M24 x 1,5	18.00	14.50	22.50	140.00	16.00	48.00	4631 24.007



Taps for ISO metric fine threads

Article no. 4860



Cutting data page 958



long design

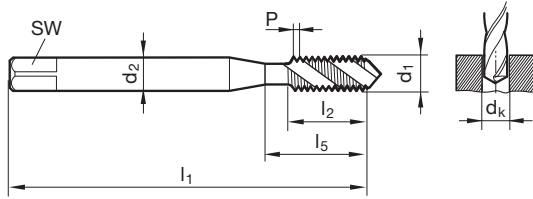

Standard							Company std.	
Article no.							4860	
							Order no.	
d1	d2	SW	dk	l1	l2	l5		
	mm	mm	mm	mm	mm	mm		
M8 x 0,75	6.00	4.90	7.20	180.00	14.00	120.00	4860 8.004	
M8 x 1	6.00	4.90	7.00	180.00	14.00	120.00	4860 8.005	
M9 x 1	7.00	5.50	8.00	200.00	14.00	140.00	4860 9.005	
M10 x 1	7.00	5.50	9.00	200.00	16.00	140.00	4860 10.005	
M12 x 1,5	9.00	7.00	10.50	220.00	18.50	158.00	4860 12.007	
M14 x 1,5	11.00	9.00	12.50	220.00	20.00	160.00	4860 14.007	
M16 x 1,5	12.00	9.00	14.50	220.00	20.00	160.00	4860 16.007	
M20 x 1,5	16.00	12.00	18.50	280.00	25.00	217.00	4860 20.007	

Taps

Taps for ISO metric fine threads

Article no. **4635**



Cutting data page 958



P	M	K	N	S	H
●	●	○	○	○	○

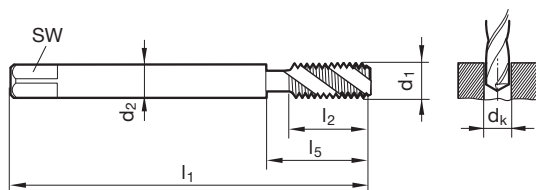

Standard	DIN 374
Article no.	4635

Taps

d1	d2 mm	SW mm	dk mm	l1 mm	l2 mm	l5 mm	Order no.
M8 x 1	6.00	4.90	7.00	90.00	11.00	35.00	4635 8.005
M10 x 1	7.00	5.50	9.00	90.00	11.00	35.00	4635 10.005
M10 x 1,25	7.00	5.50	8.80	100.00	14.00	39.00	4635 10.006
M12 x 1	9.00	7.00	11.00	100.00	11.00	40.00	4635 12.005
M12 x 1,25	9.00	7.00	10.80	100.00	15.00	40.00	4635 12.006
M12 x 1,5	9.00	7.00	10.50	100.00	15.00	40.00	4635 12.007
M14 x 1,5	11.00	9.00	12.50	100.00	15.00	40.00	4635 14.007
M16 x 1,5	12.00	9.00	14.50	100.00	15.00	44.00	4635 16.007
M18 x 1,5	14.00	11.00	16.50	110.00	16.00	44.00	4635 18.007
M20 x 1,5	16.00	12.00	18.50	125.00	16.00	44.00	4635 20.007
M24 x 1,5	18.00	14.50	22.50	140.00	16.00	48.00	4635 24.007

Taps with coolant ducts for ISO metric fine threads

Article no. **4637**



Cutting data page 958



P	M	K	N	S	H
●	●	○	○	○	○

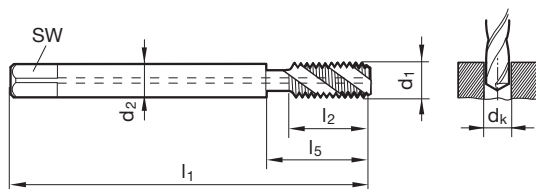

Standard	DIN 374
Article no.	4637

d1	d2 mm	SW mm	dk mm	l1 mm	l2 mm	l5 mm	Order no.
M8 x 1	6.00	4.90	7.00	90.00	11.00	35.00	4637 8.005
M10 x 1	7.00	5.50	9.00	90.00	11.00	35.00	4637 10.005
M10 x 1,25	7.00	5.50	8.80	100.00	14.00	39.00	4637 10.006
M12 x 1	9.00	7.00	11.00	100.00	11.00	40.00	4637 12.005
M12 x 1,25	9.00	7.00	10.80	100.00	15.00	40.00	4637 12.006
M12 x 1,5	9.00	7.00	10.50	100.00	15.00	40.00	4637 12.007
M14 x 1,5	11.00	9.00	12.50	100.00	15.00	40.00	4637 14.007
M16 x 1,5	12.00	9.00	14.50	100.00	15.00	44.00	4637 16.007
M18 x 1,5	14.00	11.00	16.50	110.00	16.00	44.00	4637 18.007
M20 x 1,5	16.00	12.00	18.50	125.00	16.00	44.00	4637 20.007
M24 x 1,5	18.00	14.50	22.50	140.00	16.00	48.00	4637 24.007



Taps for UNC threads

Article no. 391



Cutting data page 958

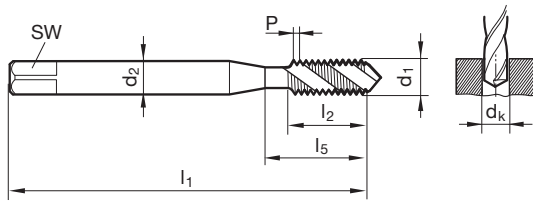

Standard ~DIN 371/~DIN 376
Article no. 391

d1	d2 mm	SW mm	dk mm	l1 mm	l2 mm	l5 mm		Order no.
2 - 56	2.80	2.10	1.85	45.00	5.00	14.50	~DIN 371	391 2.184
4 - 40	3.50	2.70	2.35	56.00	7.00	18.00	~DIN 371	391 2.845
6 - 32	4.00	3.00	2.85	56.00	8.00	20.00	~DIN 371	391 3.505
8 - 32	4.50	3.40	3.50	63.00	8.00	21.00	~DIN 371	391 4.166
10 - 24	6.00	4.90	3.90	70.00	11.00	25.00	~DIN 371	391 4.826
12 - 24	6.00	4.90	4.50	80.00	11.00	30.00	~DIN 371	391 5.486
1/4 - 20	7.00	5.50	5.10	80.00	13.00	30.00	~DIN 371	391 6.350
5/16 - 18	8.00	6.20	6.60	90.00	14.00	35.00	~DIN 371	391 7.938
3/8 - 16	10.00	8.00	8.00	100.00	16.00	39.00	~DIN 371	391 9.525
7/16 - 14	8.00	6.20	9.40	100.00	18.00	42.00	~DIN 376	391 11.113
1/2 - 13	9.00	7.00	10.80	110.00	20.00	49.00	~DIN 376	391 12.700
9/16 - 12	11.00	9.00	12.20	110.00	21.00	53.00	~DIN 376	391 14.288
5/8 - 11	12.00	9.00	13.50	110.00	24.00	53.00	~DIN 376	391 15.875
3/4 - 10	14.00	11.00	16.50	125.00	25.00	62.00	~DIN 376	391 19.050
7/8 - 9	18.00	14.50	19.50	140.00	28.00	62.00	~DIN 376	391 22.225
1 - 8	18.00	14.50	22.25	160.00	32.00	73.00	~DIN 376	391 25.400

Taps

Taps for UNF threads

Article no. 392



Cutting data page 958

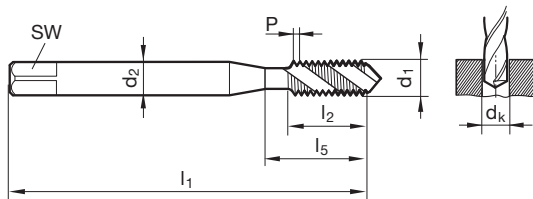

Standard ~DIN 371/~DIN 374
Article no. 392

d1	d2 mm	SW mm	dk mm	l1 mm	l2 mm	l5 mm		Order no.
2 - 64	2.80	2.10	1.85	45.00	5.00	14.50	~DIN 371	392 2.184
4 - 48	3.50	2.70	2.40	56.00	6.00	18.00	~DIN 371	392 2.845
6 - 40	4.00	3.00	2.95	56.00	6.50	20.00	~DIN 371	392 3.505
8 - 36	4.50	3.40	3.50	63.00	7.00	21.00	~DIN 371	392 4.166
10 - 32	6.00	4.90	4.10	70.00	8.50	25.00	~DIN 371	392 4.826
12 - 28	6.00	4.90	4.60	80.00	9.50	30.00	~DIN 371	392 5.486
1/4 - 28	7.00	5.50	5.50	80.00	9.50	30.00	~DIN 371	392 6.350
5/16 - 24	8.00	6.20	6.90	90.00	11.50	35.00	~DIN 371	392 7.938
3/8 - 24	10.00	8.00	8.50	90.00	11.50	35.00	~DIN 371	392 9.525
7/16 - 20	8.00	6.20	9.90	100.00	13.00	42.00	~DIN 374	392 11.113
1/2 - 20	9.00	7.00	11.50	100.00	13.00	40.00	~DIN 374	392 12.700
9/16 - 18	11.00	9.00	12.90	100.00	14.00	40.00	~DIN 374	392 14.288
5/8 - 18	12.00	9.00	14.50	100.00	15.00	44.00	~DIN 374	392 15.875
3/4 - 16	14.00	11.00	17.50	110.00	16.00	44.00	~DIN 374	392 19.050
7/8 - 14	18.00	14.50	20.40	125.00	19.00	44.00	~DIN 374	392 22.225
1 - 12	18.00	14.50	23.25	140.00	22.00	50.00	~DIN 374	392 25.400



Taps for BSP threads

Article no. **395**



Cutting data page 958

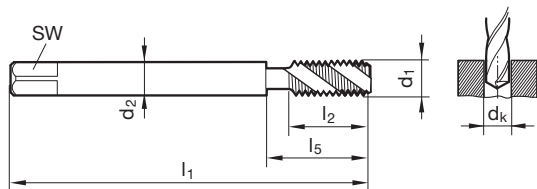
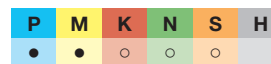

Standard **DIN 5156**
Article no. **395**

Taps

d1	P G/inch	d2 mm	SW mm	dk mm	l1 mm	l2 mm	l5 mm	Order no.
G1/16	28	6.00	4.90	6.80	90.00	11.00	30.00	395 7.723
G1/8	28	7.00	5.50	8.80	90.00	11.00	35.00	395 9.728
G1/4	19	11.00	9.00	11.80	100.00	14.00	40.00	395 13.157
G3/8	19	12.00	9.00	15.25	100.00	14.00	44.00	395 16.662
G1/2	14	16.00	12.00	19.00	125.00	18.00	44.00	395 20.955
G5/8	14	18.00	14.50	21.00	125.00	18.00	48.00	395 22.911
G3/4	14	20.00	16.00	24.50	140.00	20.00	53.00	395 26.441
G7/8	14	22.00	18.00	28.25	150.00	22.00	53.00	395 30.201
G1	11	25.00	20.00	30.75	160.00	24.00	56.00	395 33.249

Taps for BSP threads

Article no. **4632**



Cutting data page 958

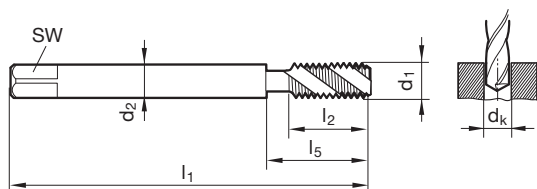

Standard **DIN 5156**
Article no. **4632**

d1	P G/inch	d2 mm	SW mm	dk mm	l1 mm	l2 mm	l5 mm	Order no.
G1/16	28	6.00	4.90	6.80	90.00	11.00	30.00	4632 7.723
G1/8	28	7.00	5.50	8.80	90.00	11.00	35.00	4632 9.728
G1/4	19	11.00	9.00	11.80	100.00	14.00	40.00	4632 13.157
G3/8	19	12.00	9.00	15.25	100.00	14.00	44.00	4632 16.662
G1/2	14	16.00	12.00	19.00	125.00	18.00	44.00	4632 20.955
G5/8	14	18.00	14.50	21.00	125.00	18.00	48.00	4632 22.911
G3/4	14	20.00	16.00	24.50	140.00	20.00	53.00	4632 26.441
G7/8	14	22.00	18.00	28.25	150.00	22.00	53.00	4632 30.201
G1	11	25.00	20.00	30.75	160.00	24.00	56.00	4632 33.249



Taps for BSP threads

Article no. 4861



Cutting data page 958



long design

P	M	K	N	S	H
●	●	○	○	○	○

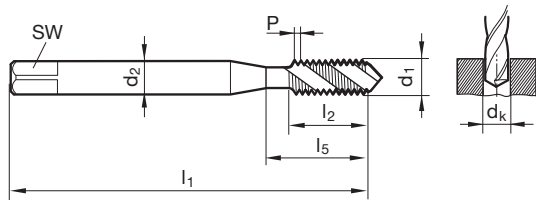

Standard								Company std.
Article no.								4861
d1	P	d2	SW	dk	l1	l2	l5	Order no.
	G/inch	mm	mm	mm	mm	mm	mm	
G1/8	28	7.00	5.50	8.80	200.00	16.00	140.00	4861 9.728
G1/4	19	11.00	9.00	11.80	220.00	20.00	160.00	4861 13.157
G3/8	19	12.00	9.00	15.25	250.00	25.00	160.00	4861 16.662
G1/2	14	16.00	12.00	19.00	280.00	27.00	217.00	4861 20.955

Taps

Taps for BSP threads

Article no. **4681**



Cutting data page 958

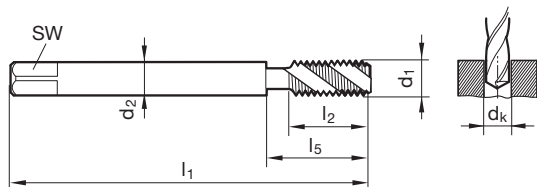
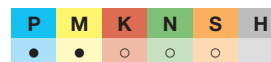

Standard **DIN 5156**
Article no. **4681**

d1	P G/inch	d2 mm	SW mm	dk mm	l1 mm	l2 mm	l5 mm	Order no.
Rp1/16	28	6.00	4.90	6.55	90.00	11.00	30.00	4681 7.723
Rp1/8	28	7.00	5.50	8.60	90.00	11.00	35.00	4681 9.728
Rp1/4	19	11.00	9.00	11.50	100.00	14.00	40.00	4681 13.157
Rp3/8	19	12.00	9.00	15.00	100.00	14.00	44.00	4681 16.662
Rp1/2	14	16.00	12.00	18.50	125.00	18.00	44.00	4681 20.955
Rp3/4	14	20.00	16.00	24.00	140.00	20.00	53.00	4681 26.441
Rp1	11	25.00	20.00	30.25	160.00	24.00	56.00	4681 33.249

Taps

Taps for BSW threads

Article no. **4679**



Cutting data page 958

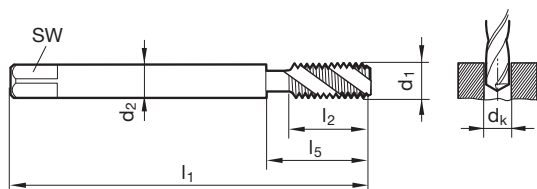
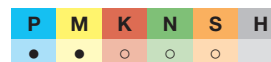

Standard **~DIN 371**
Article no. **4679**

d1	P G/inch	d2 mm	SW mm	dk mm	l1 mm	l2 mm	l5 mm	Order no.
W1/8	40	3.50	2.70	2.50	56.00	7.00	18.00	4679 3.175
W3/16	24	6.00	4.90	3.60	70.00	11.00	25.00	4679 4.762
W1/4	20	7.00	5.50	5.10	80.00	13.00	30.00	4679 6.350
W5/16	18	8.00	6.20	6.50	90.00	14.00	35.00	4679 7.938
W3/8	16	10.00	8.00	7.90	100.00	16.00	39.00	4679 9.525
W7/16	14	8.00	6.20	9.20	100.00	18.00	42.00	4679 11.113
W1/2	12	9.00	7.00	10.50	110.00	20.00	49.00	4679 12.700
W5/8	11	12.00	9.00	13.50	110.00	24.00	53.00	4679 15.876
W3/4	10	14.00	11.00	16.25	125.00	25.00	62.00	4679 19.051
W7/8	9	18.00	14.50	19.25	140.00	28.00	62.00	4679 22.226
W1	8	18.00	14.50	22.00	160.00	32.00	73.00	4679 25.401



Taps for ISO metric threads

Article no. 803



Cutting data page 959

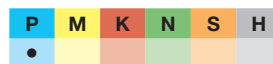

P ≤ 800 N/mm²

Taps for ISO metric threads

Article no. 912



Cutting data page 959

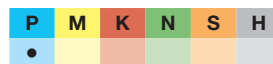

P ≤ 800 N/mm²

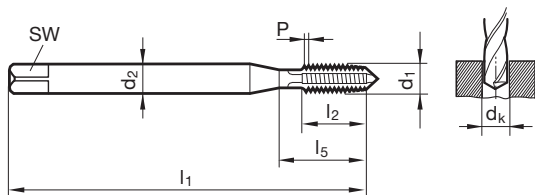

Standard
Article no.

DIN 371	
803	912

Taps

d1	P mm	d2 mm	SW mm	dk mm	l1 mm	l2 mm	l5 mm	Order no.	
M1,4	0.300	2.50	2.10	1.10	40.00	5.60	5.60	803 1.400	912 1.400
M1,6	0.350	2.50	2.10	1.25	40.00	6.40	6.40	803 1.600	912 1.600
M1,7	0.350	2.50	2.10	1.35	40.00	6.80	6.80	803 1.700	912 1.700
M1,8	0.350	2.50	2.10	1.45	40.00	7.30	7.30	803 1.800	912 1.800
M2	0.400	2.80	2.10	1.60	45.00	8.00	13.50	803 2.000	912 2.000
M2,2	0.450	2.80	2.10	1.75	45.00	9.00	14.50	803 2.200	912 2.200
M2,3	0.400	2.80	2.10	1.90	45.00	9.00	14.50	803 2.300	912 2.300
M2,5	0.450	2.80	2.10	2.05	50.00	9.00	14.50	803 2.500	912 2.500
M2,6	0.450	2.80	2.10	2.15	50.00	9.00	14.50	803 2.600	912 2.600
M3	0.500	3.50	2.70	2.50	56.00	10.00	18.00	803 3.000	912 3.000
M3,5	0.600	4.00	3.00	2.90	56.00	12.00	20.00	803 3.500	912 3.500
M4	0.700	4.50	3.40	3.30	63.00	12.00	21.00	803 4.000	912 4.000
M5	0.800	6.00	4.90	4.20	70.00	14.00	25.00	803 5.000	912 5.000
M6	1.000	6.00	4.90	5.00	80.00	16.00	30.00	803 6.000	912 6.000
M7	1.000	7.00	5.50	6.00	80.00	16.00	30.00	803 7.000	912 7.000
M8	1.250	8.00	6.20	6.80	90.00	17.00	35.00	803 8.000	912 8.000
M10	1.500	10.00	8.00	8.50	100.00	20.00	39.00	803 10.000	912 10.000



Taps for ISO metric threads

Article no. **815**



Cutting data page 959

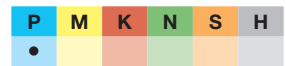

$P \leq 800 \text{ N/mm}^2$

Taps for ISO metric threads

Article no. **915**



Cutting data page 959

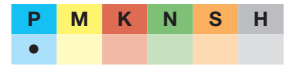

$P \leq 800 \text{ N/mm}^2$

Taps

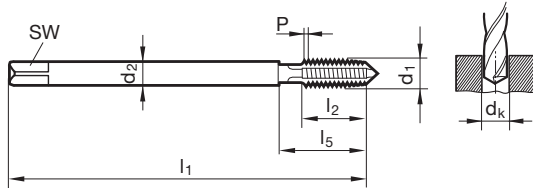

Standard
Article no.

DIN 376	
815	915

d1	P mm	d2 mm	SW mm	dk mm	l1 mm	l2 mm	l5 mm	Order no.	
								815	915
M1,6	0.350	1.20	2.10	1.25	40.00	8.00	12.50	815 1.600	915 1.600
M1,8	0.350	1.20	2.10	1.45	40.00	8.00	12.50	815 1.800	915 1.800
M2	0.400	1.40	1.25	1.60	45.00	8.00	13.50	815 2.000	915 2.000
M2,2	0.450	1.60	1.25	1.75	45.00	9.00	14.50	815 2.200	915 2.200
M2,3	0.400	1.60	1.25	1.90	45.00	9.00	14.50	815 2.300	915 2.300
M2,5	0.450	1.80	1.40	2.05	50.00	9.00	14.50	815 2.500	915 2.500
M2,6	0.450	1.80	1.40	2.15	50.00	9.00	14.50	815 2.600	915 2.600
M3	0.500	2.20	1.80	2.50	56.00	10.00	18.00	815 3.000	915 3.000
M3,5	0.600	2.50	2.10	2.90	56.00	12.00	20.00	815 3.500	915 3.500
M4	0.700	2.80	2.10	3.30	63.00	12.00	21.00	815 4.000	915 4.000
M5	0.800	3.50	2.70	4.20	70.00	14.00	25.00	815 5.000	915 5.000
M6	1.000	4.50	3.40	5.00	80.00	16.00	30.00	815 6.000	915 6.000
M7	1.000	5.50	4.30	6.00	80.00	16.00	30.00	815 7.000	915 7.000
M8	1.250	6.00	4.90	6.80	90.00	17.00	35.00	815 8.000	915 8.000
M10	1.500	7.00	5.50	8.50	100.00	20.00	39.00	815 10.000	915 10.000
M12	1.750	9.00	7.00	10.20	110.00	24.00	49.00	815 12.000	915 12.000
M14	2.000	11.00	9.00	12.00	110.00	26.00	53.00	815 14.000	915 14.000
M16	2.000	12.00	9.00	14.00	110.00	26.00	54.00	815 16.000	915 16.000
M18	2.500	14.00	11.00	15.50	125.00	30.00	62.00	815 18.000	915 18.000
M20	2.500	16.00	12.00	17.50	140.00	32.00	62.00	815 20.000	915 20.000
M22	2.500	18.00	14.50	19.50	140.00	32.00	62.00	815 22.000	915 22.000
M24	3.000	18.00	14.50	21.00	160.00	36.00	73.00	815 24.000	915 24.000
M27	3.000	20.00	16.00	24.00	160.00	36.00	73.00	815 27.000	915 27.000
M30	3.500	22.00	18.00	26.50	180.00	40.00	85.00	815 30.000	915 30.000
M33	3.500	25.00	20.00	29.50	180.00	40.00	91.00	815 33.000	915 33.000
M36	4.000	28.00	22.00	32.00	200.00	50.00	102.00	815 36.000	915 36.000
M39	4.000	32.00	24.00	35.00	200.00	50.00	107.00	815 39.000	915 39.000
M42	4.500	32.00	24.00	37.50	200.00	56.00	112.00	815 42.000	915 42.000
M45	4.500	36.00	29.00	40.50	220.00	58.00	117.00	815 45.000	915 45.000
M48	5.000	36.00	29.00	43.00	250.00	65.00	127.00	815 48.000	915 48.000
M52	5.000	40.00	32.00	47.00	250.00	65.00	128.00	815 52.000	915 52.000



Taps for ISO metric threads

Article no. 794



Cutting data page 959

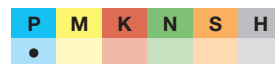

P ≤ 800 N/mm²

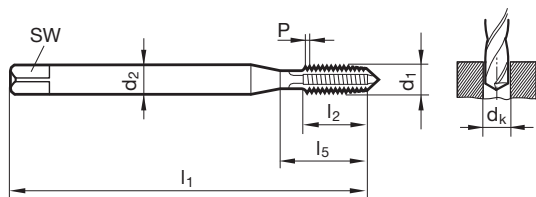

Standard	DIN 371
Article no.	794

d1	P mm	d2 mm	SW mm	dk mm	l1 mm	l2 mm	l5 mm
M2	0.400	2.80	2.10	1.60	45.00	8.00	13.50
M2,5	0.450	2.80	2.10	2.05	50.00	9.00	14.50
M3	0.500	3.50	2.70	2.50	56.00	10.00	18.00
M4	0.700	4.50	3.40	3.30	63.00	12.00	21.00
M5	0.800	6.00	4.90	4.20	70.00	14.00	25.00
M6	1.000	6.00	4.90	5.00	80.00	16.00	30.00
M7	1.000	7.00	5.50	6.00	80.00	16.00	30.00
M8	1.250	8.00	6.20	6.80	90.00	17.00	35.00
M10	1.500	10.00	8.00	8.50	100.00	20.00	39.00

Order no.
794 2.000
794 2.500
794 3.000
794 4.000
794 5.000
794 6.000
794 7.000
794 8.000
794 10.000

Taps



Taps for ISO metric threads

Article no. **837**



Cutting data page 959

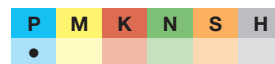

$P \leq 800 \text{ N/mm}^2$

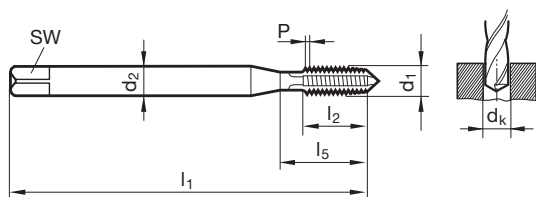

Standard

DIN 371

Article no.

837

Taps

d1	d2 mm	SW mm	dk mm	l1 mm	l2 mm	l5 mm	Order no.
M1,4	2.50	2.10	1.10	40.00	5.60	5.60	837 1.400
M1,6	2.50	2.10	1.25	40.00	6.40	6.40	837 1.600
M2	2.80	2.10	1.60	45.00	8.00	13.50	837 2.000
M2,2	2.80	2.10	1.75	45.00	9.00	14.50	837 2.200
M2,5	2.80	2.10	2.05	50.00	9.00	14.50	837 2.500
M3	3.50	2.70	2.50	56.00	10.00	18.00	837 3.000
M3,5	4.00	3.00	2.90	56.00	12.00	20.00	837 3.500
M4	4.50	3.40	3.30	63.00	12.00	21.00	837 4.000
M5	6.00	4.90	4.20	70.00	14.00	25.00	837 5.000
M6	6.00	4.90	5.00	80.00	16.00	30.00	837 6.000
M8	8.00	6.20	6.80	90.00	17.00	35.00	837 8.000
M10	10.00	8.00	8.50	100.00	20.00	39.00	837 10.000

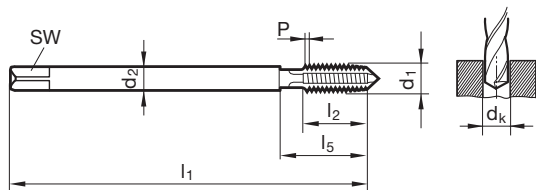

Standard

DIN 376

Article no.

845

d1	d2 mm	SW mm	dk mm	l1 mm	l2 mm	l5 mm	Order no.
M4	2.80	2.10	3.30	63.00	12.00	21.00	845 4.000
M5	3.50	2.70	4.20	70.00	14.00	25.00	845 5.000
M6	4.50	3.40	5.00	80.00	16.00	30.00	845 6.000
M8	6.00	4.90	6.80	90.00	17.00	35.00	845 8.000
M10	7.00	5.50	8.50	100.00	20.00	39.00	845 10.000
M12	9.00	7.00	10.20	110.00	24.00	49.00	845 12.000
M14	11.00	9.00	12.00	110.00	26.00	53.00	845 14.000
M16	12.00	9.00	14.00	110.00	26.00	54.00	845 16.000
M20	16.00	12.00	17.50	140.00	32.00	62.00	845 20.000



Taps for ISO metric threads

Article no. 2876



Cutting data page 960

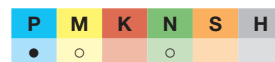

P ≤ 1000 N/mm²

Taps for ISO metric threads

Article no. 313



Cutting data page 960

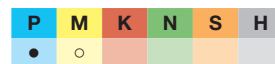

P ≤ 1000 N/mm²

Taps for ISO metric threads

Article no. 1285



Cutting data page 960

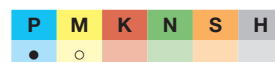

P ≤ 1000 N/mm²

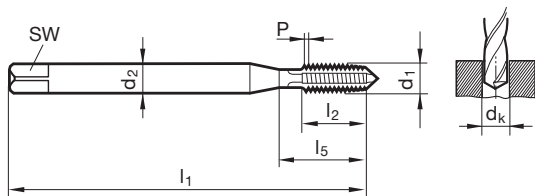

Standard	DIN 371		
Article no.	2876	313	1285

d1	P	d2	SW	dk	l1	l2	l5	Order no.		
mm	mm	mm	mm	mm	mm	mm	mm			
M2	0.400	2.80	2.10	1.60	45.00	8.00	13.50	2876 2.000	313 2.000	1285 2.000
M3	0.500	3.50	2.70	2.50	56.00	10.00	18.00	2876 3.000	313 3.000	1285 3.000
M4	0.700	4.50	3.40	3.30	63.00	12.00	21.00	2876 4.000	313 4.000	1285 4.000
M5	0.800	6.00	4.90	4.20	70.00	14.00	25.00	2876 5.000	313 5.000	1285 5.000
M6	1.000	6.00	4.90	5.00	80.00	16.00	30.00	2876 6.000	313 6.000	1285 6.000
M8	1.250	8.00	6.20	6.80	90.00	17.00	35.00	2876 8.000	313 8.000	1285 8.000
M10	1.500	10.00	8.00	8.50	100.00	20.00	39.00	2876 10.000	313 10.000	1285 10.000

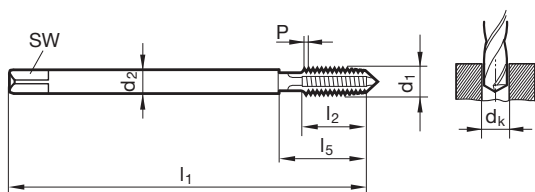

Standard	DIN 376		
Article no.	2877	315	1286

d1	P	d2	SW	dk	l1	l2	l5	Order no.		
mm	mm	mm	mm	mm	mm	mm	mm			
M3	0.500	2.20	1.80	2.50	56.00	10.00	18.00	2877 3.000	315 3.000	
M4	0.700	2.80	2.10	3.30	63.00	12.00	21.00	2877 4.000	315 4.000	
M5	0.800	3.50	2.70	4.20	70.00	14.00	25.00	2877 5.000	315 5.000	
M6	1.000	4.50	3.40	5.00	80.00	16.00	30.00	2877 6.000	315 6.000	
M8	1.250	6.00	4.90	6.80	90.00	17.00	35.00	2877 8.000	315 8.000	
M10	1.500	7.00	5.50	8.50	100.00	20.00	39.00	2877 10.000	315 10.000	
M12	1.750	9.00	7.00	10.20	110.00	24.00	49.00	2877 12.000	315 12.000	1286 12.000
M14	2.000	11.00	9.00	12.00	110.00	26.00	53.00	2877 14.000	315 14.000	1286 14.000
M16	2.000	12.00	9.00	14.00	110.00	26.00	54.00	2877 16.000	315 16.000	1286 16.000
M18	2.500	14.00	11.00	15.50	125.00	30.00	62.00	2877 18.000	315 18.000	1286 18.000
M20	2.500	16.00	12.00	17.50	140.00	32.00	62.00	2877 20.000	315 20.000	1286 20.000
M22	2.500	18.00	14.50	19.50	140.00	32.00	62.00	2877 22.000	315 22.000	
M24	3.000	18.00	14.50	21.00	160.00	36.00	73.00	2877 24.000	315 24.000	
M27	3.000	20.00	16.00	24.00	160.00	36.00	73.00	2877 27.000	315 27.000	
M30	3.500	22.00	18.00	26.50	180.00	40.00	85.00	2877 30.000	315 30.000	
M36	4.000	28.00	22.00	32.00	200.00	50.00	102.00	2877 36.000	315 36.000	



Taps for ISO metric threads

Article no. **2990**



Cutting data page 960



$P \leq 1000 \text{ N/mm}^2$

Taps for ISO metric threads

Article no. **2991**



Cutting data page 960

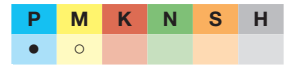

$P \leq 1000 \text{ N/mm}^2$

Taps

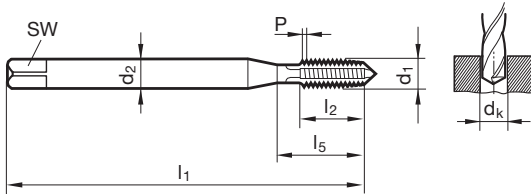

Standard
Article no.

DIN 371	
2990	2991

d1	d2 mm	SW mm	dk mm	l1 mm	l2 mm	l5 mm
M2	2.80	2.10	1.60	45.00	8.00	13.50
M3	3.50	2.70	2.50	56.00	10.00	18.00
M4	4.50	3.40	3.30	63.00	12.00	21.00
M5	6.00	4.90	4.20	70.00	14.00	25.00
M6	6.00	4.90	5.00	80.00	16.00	30.00
M8	8.00	6.20	6.80	90.00	17.00	35.00
M10	10.00	8.00	8.50	100.00	20.00	39.00

Order no.	
2990 2.000	2991 2.000
2990 3.000	2991 3.000
2990 4.000	2991 4.000
2990 5.000	2991 5.000
2990 6.000	2991 6.000
2990 8.000	2991 8.000
2990 10.000	2991 10.000



Taps for ISO metric threads

Article no. 942



Cutting data page 960

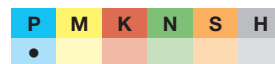

P ≤ 1000 N/mm²

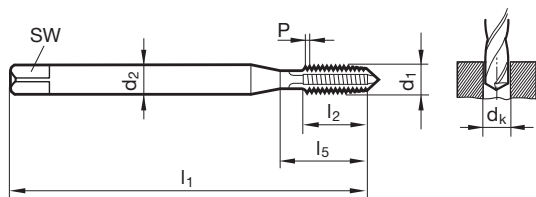

Standard
Article no.

~DIN 371
942

d1	P mm	d2 mm	SW mm	dk mm	l1 mm	l2 mm	l5 mm
M5	0.800	6.00	4.90	4.20	70.00	12.00	25.00
M6	1.000	6.00	4.90	5.00	80.00	15.00	30.00
M8	1.250	8.00	6.20	6.80	90.00	19.00	35.00
M10	1.500	10.00	8.00	8.50	100.00	22.50	39.00
M12	1.750	12.00	9.00	10.20	110.00	26.50	49.00

Order no.
942 5.000
942 6.000
942 8.000
942 10.000
942 12.000

Taps



Taps for ISO metric threads

Article no. **2941**



Cutting data page 961

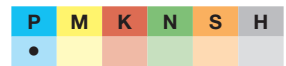

$P \leq 1200 \text{ N/mm}^2$

Taps for ISO metric threads

Article no. **1575**



Cutting data page 961

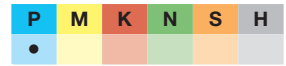

$P \leq 1200 \text{ N/mm}^2$

Taps

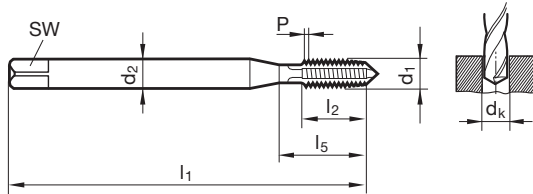

Standard
Article no.

DIN 371

2941 **1575**

d1	P mm	d2 mm	SW mm	dk mm	l1 mm	l2 mm	l5 mm	Order no.
M2	0.400	2.80	2.10	1.60	45.00	8.00	13.50	2941 2.000
M2,5	0.450	2.80	2.10	2.05	50.00	9.00	14.50	2941 2.500
M3	0.500	3.50	2.70	2.50	56.00	10.00	18.00	2941 3.000 1575 3.000
M4	0.700	4.50	3.40	3.30	63.00	12.00	21.00	2941 4.000 1575 4.000
M5	0.800	6.00	4.90	4.20	70.00	14.00	25.00	2941 5.000 1575 5.000
M6	1.000	6.00	4.90	5.00	80.00	16.00	30.00	2941 6.000 1575 6.000
M8	1.250	8.00	6.20	6.80	90.00	17.00	35.00	2941 8.000 1575 8.000
M10	1.500	10.00	8.00	8.50	100.00	20.00	39.00	2941 10.000 1575 10.000

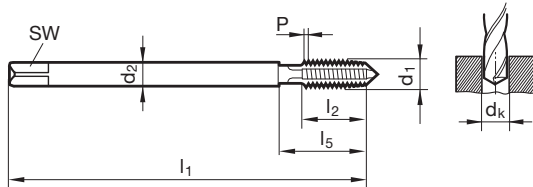

Standard
Article no.

DIN 376

2942 **1576**

d1	P mm	d2 mm	SW mm	dk mm	l1 mm	l2 mm	l5 mm	Order no.
M8	1.250	6.00	4.90	6.80	90.00	17.00	35.00	2942 8.000
M10	1.500	7.00	5.50	8.50	100.00	20.00	39.00	2942 10.000
M12	1.750	9.00	7.00	10.20	110.00	24.00	49.00	2942 12.000 1576 12.000
M14	2.000	11.00	9.00	12.00	110.00	26.00	53.00	2942 14.000 1576 14.000
M16	2.000	12.00	9.00	14.00	110.00	26.00	54.00	2942 16.000 1576 16.000
M18	2.500	14.00	11.00	15.50	125.00	30.00	62.00	2942 18.000
M20	2.500	16.00	12.00	17.50	140.00	32.00	62.00	2942 20.000 1576 20.000
M24	3.000	18.00	14.50	21.00	160.00	36.00	73.00	2942 24.000 1576 24.000
M30	3.500	22.00	18.00	26.50	180.00	40.00	85.00	2942 30.000 1576 30.000



Taps for ISO metric threads

Article no. 4791



Cutting data page 961

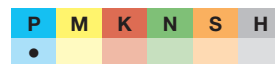

P ≤ 1200 N/mm²

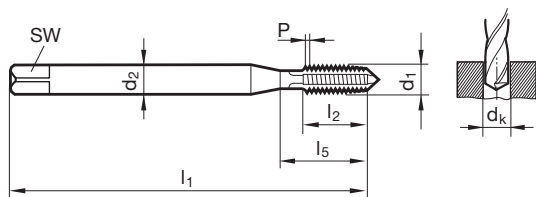

								Standard	DIN 371
								Article no.	4791
d1	P	d2	SW	dk	l1	l2	l5	Order no.	
M2	0.400	2.80	2.10	1.60	45.00	8.00	13.50	4791 2.000	
M2,5	0.450	2.80	2.10	2.05	50.00	9.00	14.50	4791 2.500	
M3	0.500	3.50	2.70	2.50	56.00	10.00	18.00	4791 3.000	
M4	0.700	4.50	3.40	3.30	63.00	12.00	21.00	4791 4.000	
M5	0.800	6.00	4.90	4.20	70.00	14.00	25.00	4791 5.000	
M6	1.000	6.00	4.90	5.00	80.00	16.00	30.00	4791 6.000	
M8	1.250	8.00	6.20	6.80	90.00	17.00	35.00	4791 8.000	
M10	1.500	10.00	8.00	8.50	100.00	20.00	39.00	4791 10.000	
M12	1.750	9.00	7.00	10.20	110.00	24.00	49.00	4791 12.000	
M14	2.000	11.00	9.00	12.00	110.00	26.00	53.00	4791 14.000	
M16	2.000	12.00	9.00	14.00	110.00	26.00	54.00	4791 16.000	
M18	2.500	14.00	11.00	15.50	125.00	30.00	62.00	4791 18.000	
M20	2.500	16.00	12.00	17.50	140.00	32.00	62.00	4791 20.000	
M24	3.000	18.00	14.50	21.00	160.00	36.00	73.00	4791 24.000	

Taps

Taps for ISO metric threads

Article no. 4792



Cutting data page 961

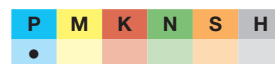

P ≤ 1200 N/mm²

Taps for ISO metric threads

Article no. 2710



Cutting data page 961

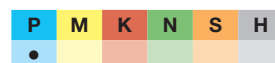

P ≤ 1200 N/mm²

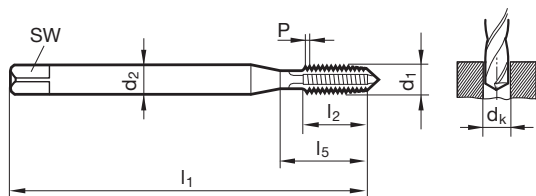

							Standard	DIN 371	
							Article no.	4792	2710
d1	d2	SW	dk	l1	l2	l5	Order no.		
M2	2.80	2.10	1.60	45.00	8.00	13.50	4792 2.000	2710 2.000	
M2,5	2.80	2.10	2.05	50.00	9.00	14.50	4792 2.500	2710 2.500	
M3	3.50	2.70	2.50	56.00	10.00	18.00	4792 3.000	2710 3.000	
M4	4.50	3.40	3.30	63.00	12.00	21.00	4792 4.000	2710 4.000	
M5	6.00	4.90	4.20	70.00	14.00	25.00	4792 5.000	2710 5.000	
M6	6.00	4.90	5.00	80.00	16.00	30.00	4792 6.000	2710 6.000	
M8	8.00	6.20	6.80	90.00	17.00	35.00	4792 8.000	2710 8.000	
M10	10.00	8.00	8.50	100.00	20.00	39.00	4792 10.000	2710 10.000	



Taps for ISO metric threads

Article no. **1870**



Cutting data page 964



$P \leq 1000 \text{ N/mm}^2$

Taps for ISO metric threads

Article no. **2869**



Cutting data page 964



$P \leq 1000 \text{ N/mm}^2$

Taps

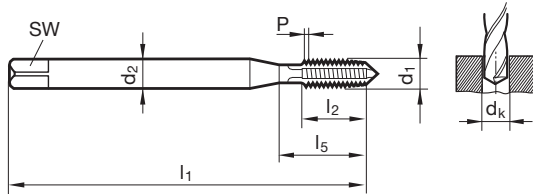

Standard
Article no.

DIN 371	
1870	2869

d1	P mm	d2 mm	SW mm	dk mm	l1 mm	l2 mm	l5 mm
M2	0.400	2.80	2.10	1.60	45.00	8.00	13.50
M2,5	0.450	2.80	2.10	2.05	50.00	9.00	14.50
M3	0.500	3.50	2.70	2.50	56.00	10.00	18.00
M4	0.700	4.50	3.40	3.30	63.00	12.00	21.00
M5	0.800	6.00	4.90	4.20	70.00	14.00	25.00
M6	1.000	6.00	4.90	5.00	80.00	16.00	30.00
M8	1.250	8.00	6.20	6.80	90.00	17.00	35.00
M10	1.500	10.00	8.00	8.50	100.00	20.00	39.00

Order no.	
1870 2.000	2869 2.000
1870 2.500	2869 2.500
1870 3.000	2869 3.000
1870 4.000	2869 4.000
1870 5.000	2869 5.000
1870 6.000	2869 6.000
1870 8.000	2869 8.000
1870 10.000	2869 10.000

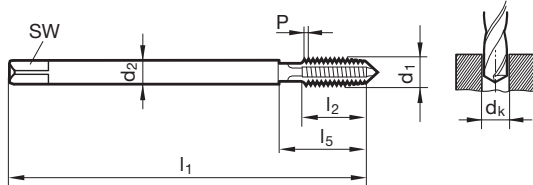

Standard
Article no.

DIN 376	
1872	2870

d1	P mm	d2 mm	SW mm	dk mm	l1 mm	l2 mm	l5 mm
M3	0.500	2.20	1.80	2.50	56.00	10.00	18.00
M4	0.700	2.80	2.10	3.30	63.00	12.00	21.00
M5	0.800	3.50	2.70	4.20	70.00	14.00	25.00
M6	1.000	4.50	3.40	5.00	80.00	16.00	30.00
M8	1.250	6.00	4.90	6.80	90.00	17.00	35.00
M10	1.500	7.00	5.50	8.50	100.00	20.00	39.00
M12	1.750	9.00	7.00	10.20	110.00	24.00	49.00
M14	2.000	11.00	9.00	12.00	110.00	26.00	53.00
M16	2.000	12.00	9.00	14.00	110.00	26.00	54.00
M18	2.500	14.00	11.00	15.50	125.00	30.00	62.00
M20	2.500	16.00	12.00	17.50	140.00	32.00	62.00
M24	3.000	18.00	14.50	21.00	160.00	36.00	73.00
M30	3.500	22.00	18.00	26.50	180.00	40.00	85.00

Order no.	
1872 3.000	2870 3.000
1872 4.000	2870 4.000
1872 5.000	2870 5.000
1872 6.000	2870 6.000
1872 8.000	2870 8.000
1872 10.000	2870 10.000
1872 12.000	2870 12.000
1872 14.000	2870 14.000
1872 16.000	2870 16.000
1872 18.000	2870 18.000
1872 20.000	2870 20.000
1872 24.000	2870 24.000
1872 30.000	2870 30.000



Taps for ISO metric threads

Article no. 1871



Cutting data page 964



P	M	K	N	S	H
○	●	○	○	○	○

P ≤ 1000 N/mm²

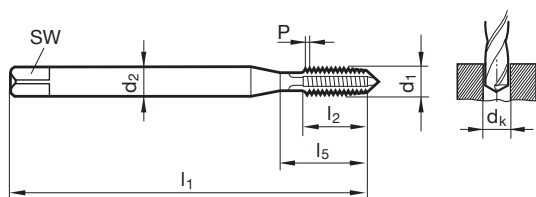

								Standard	DIN 371
								Article no.	1871
d1	P	d2	SW	dk	l1	l2	l5	Order no.	
M3	0.500	3.50	2.70	2.50	56.00	10.00	18.00	1871 3.000	
M4	0.700	4.50	3.40	3.30	63.00	12.00	21.00	1871 4.000	
M5	0.800	6.00	4.90	4.20	70.00	14.00	25.00	1871 5.000	
M6	1.000	6.00	4.90	5.00	80.00	16.00	30.00	1871 6.000	
M8	1.250	8.00	6.20	6.80	90.00	17.00	35.00	1871 8.000	
M10	1.500	10.00	8.00	8.50	100.00	20.00	39.00	1871 10.000	

Taps



Taps with coolant ducts for ISO metric threads

Article no. **2311**



Cutting data page 962

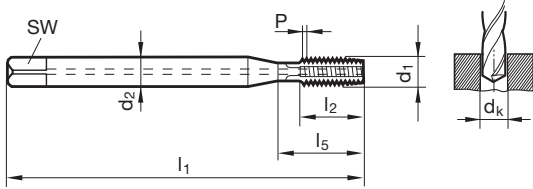
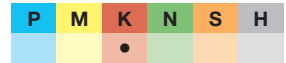

Standard
Article no.

DIN 371

2311

d1	P mm	d2 mm	SW mm	dk mm	l1 mm	l2 mm	l5 mm
M5	0.800	6.00	4.90	4.20	70.00	10.00	25.00
M6	1.000	6.00	4.90	5.00	80.00	12.00	30.00
M8	1.250	8.00	6.20	6.80	90.00	16.00	35.00
M10	1.500	10.00	8.00	8.50	100.00	18.00	39.00

Order no.

2311 5.000

2311 6.000

2311 8.000

2311 10.000

Taps



Taps for ISO metric threads

Article no. 805



Cutting data page 963

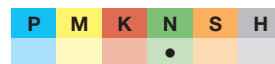

N ≤ 7% Si

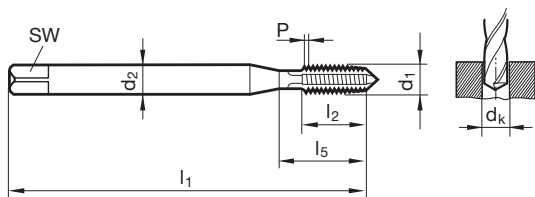

Standard **DIN 371**
Article no. **805**

d1	P mm	d2 mm	SW mm	dk mm	l1 mm	l2 mm	l5 mm	Order no.
M1,6	0.350	2.50	2.10	1.25	40.00	6.40	6.40	805 1.600
M2	0.400	2.80	2.10	1.60	45.00	8.00	13.50	805 2.000
M2,2	0.450	2.80	2.10	1.75	45.00	9.00	14.50	805 2.200
M2,5	0.450	2.80	2.10	2.05	50.00	9.00	14.50	805 2.500
M3	0.500	3.50	2.70	2.50	56.00	10.00	18.00	805 3.000
M4	0.700	4.50	3.40	3.30	63.00	12.00	21.00	805 4.000
M5	0.800	6.00	4.90	4.20	70.00	14.00	25.00	805 5.000
M6	1.000	6.00	4.90	5.00	80.00	16.00	30.00	805 6.000
M8	1.250	8.00	6.20	6.80	90.00	17.00	35.00	805 8.000
M10	1.500	10.00	8.00	8.50	100.00	20.00	39.00	805 10.000

Taps

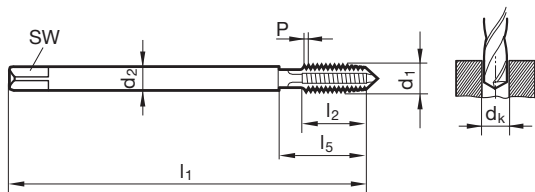

Standard **DIN 376**
Article no. **817**

d1	P mm	d2 mm	SW mm	dk mm	l1 mm	l2 mm	l5 mm	Order no.
M12	1.750	9.00	7.00	10.20	110.00	24.00	49.00	817 12.000
M14	2.000	11.00	9.00	12.00	110.00	26.00	53.00	817 14.000
M16	2.000	12.00	9.00	14.00	110.00	26.00	54.00	817 16.000
M18	2.500	14.00	11.00	15.50	125.00	30.00	62.00	817 18.000
M20	2.500	16.00	12.00	17.50	140.00	32.00	62.00	817 20.000

Taps for ISO metric threads

Article no. 4672



Cutting data page 963

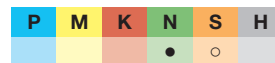

N ≤ 7% Si

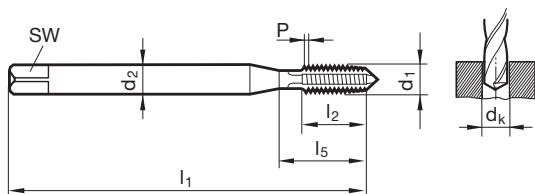

Standard **DIN 371/DIN 376**
Article no. **4672**

d1	P mm	d2 mm	SW mm	dk mm	l1 mm	l2 mm	l5 mm	Order no.
M2	0.400	2.80	2.10	1.60	45.00	8.00	13.50	4672 2.000
M2,5	0.450	2.80	2.10	2.05	50.00	9.00	14.50	4672 2.500
M3	0.500	3.50	2.70	2.50	56.00	10.00	18.00	4672 3.000
M4	0.700	4.50	3.40	3.30	63.00	12.00	21.00	4672 4.000
M5	0.800	6.00	4.90	4.20	70.00	14.00	25.00	4672 5.000
M6	1.000	6.00	4.90	5.00	80.00	16.00	30.00	4672 6.000
M8	1.250	8.00	6.20	6.80	90.00	17.00	35.00	4672 8.000
M10	1.500	10.00	8.00	8.50	100.00	20.00	39.00	4672 10.000
M12	1.750	9.00	7.00	10.20	110.00	24.00	49.00	4672 12.000
M14	2.000	11.00	9.00	12.00	110.00	26.00	53.00	4672 14.000
M16	2.000	12.00	9.00	14.00	110.00	26.00	54.00	4672 16.000



Taps with coolant ducts for ISO metric threads

Article no. **1858**



Cutting data page 962-963



P	M	K	N	S	H
		•	•		

N ≥ 7% Si

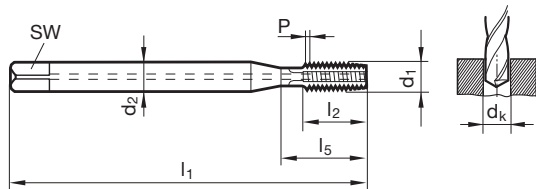

Standard	DIN 371
Article no.	1858

d1	P	d2	SW	dk	l1	l2	l5	Order no.
mm	mm	mm	mm	mm	mm	mm	mm	
M5	0.800	6.00	4.90	4.20	70.00	10.00	25.00	1858 5.000
M6	1.000	6.00	4.90	5.00	80.00	12.00	30.00	1858 6.000
M8	1.250	8.00	6.20	6.80	90.00	16.00	35.00	1858 8.000
M10	1.500	10.00	8.00	8.50	100.00	18.00	39.00	1858 10.000

Taps

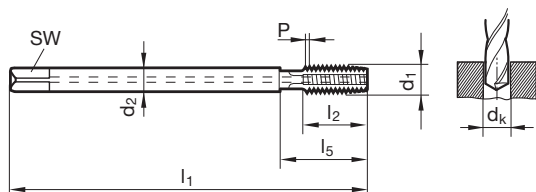

Standard	DIN 376
Article no.	1859

d1	P	d2	SW	dk	l1	l2	l5	Order no.
mm	mm	mm	mm	mm	mm	mm	mm	
M12	1.750	9.00	7.00	10.20	110.00	18.00	49.00	1859 12.000
M14	2.000	11.00	9.00	12.00	110.00	20.00	53.00	1859 14.000
M16	2.000	12.00	9.00	14.00	110.00	20.00	54.00	1859 16.000
M20	2.500	16.00	12.00	17.50	140.00	25.00	62.00	1859 20.000

Taps for ISO metric threads

Article no. **4675**



Cutting data page 963



P	M	K	N	S	H
			•		

with internal cooling ≥ M5

N ≥ 7% Si

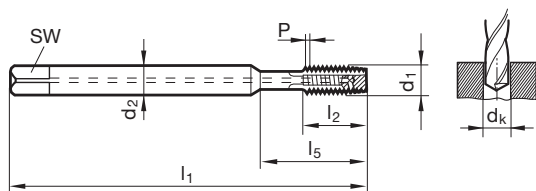

Standard	DIN 371/DIN 376
Article no.	4675

d1	P	d2	SW	dk	l1	l2	l5	Order no.
mm	mm	mm	mm	mm	mm	mm	mm	
M3	0.500	3.50	2.70	2.50	56.00	8.00	18.00	DIN 371 4675 3.000
M4	0.700	4.50	3.40	3.30	63.00	10.00	21.00	DIN 371 4675 4.000
M5	0.800	6.00	4.90	4.20	70.00	10.00	25.00	DIN 371 4675 5.000
M6	1.000	6.00	4.90	5.00	80.00	12.00	30.00	DIN 371 4675 6.000
M8	1.250	8.00	6.20	6.80	90.00	16.00	35.00	DIN 371 4675 8.000
M10	1.500	10.00	8.00	8.50	100.00	18.00	39.00	DIN 371 4675 10.000
M12	1.750	9.00	7.00	10.20	110.00	18.00	49.00	DIN 376 4675 12.000
M14	2.000	11.00	9.00	12.00	110.00	20.00	53.00	DIN 376 4675 14.000
M16	2.000	12.00	9.00	14.00	110.00	20.00	54.00	DIN 376 4675 16.000



Taps for ISO metric threads

Article no. 2901



Cutting data page 966

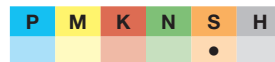

Taps for ISO metric threads

Article no. 2916



Cutting data page 966

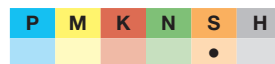

S = Ni

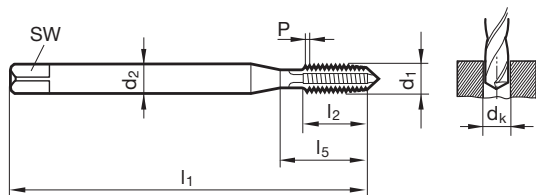

Standard
Article no.

DIN 371/DIN 376

2901 2916

d1	P mm	d2 mm	SW mm	dk mm	l1 mm	l2 mm	l5 mm	Standard Article no.	Order no.	
									2901	2916
M3	0.500	3.50	2.70	2.50	56.00	10.00	18.00	DIN 371	2901 3.000	2916 3.000
M4	0.700	4.50	3.40	3.30	63.00	12.00	21.00	DIN 371	2901 4.000	2916 4.000
M5	0.800	6.00	4.90	4.20	70.00	14.00	25.00	DIN 371	2901 5.000	2916 5.000
M6	1.000	6.00	4.90	5.00	80.00	16.00	30.00	DIN 371	2901 6.000	2916 6.000
M8	1.250	8.00	6.20	6.80	90.00	17.00	35.00	DIN 371	2901 8.000	2916 8.000
M10	1.500	10.00	8.00	8.50	100.00	20.00	39.00	DIN 371	2901 10.000	2916 10.000
M12	1.750	9.00	7.00	10.20	110.00	24.00	49.00	DIN 376	2901 12.000	2916 12.000
M16	2.000	12.00	9.00	14.00	110.00	26.00	54.00	DIN 376	2901 16.000	2916 16.000

Taps



Taps for ISO metric threads

Article no. **838**



Cutting data page 959

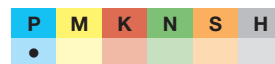

$P \leq 800 \text{ N/mm}^2$

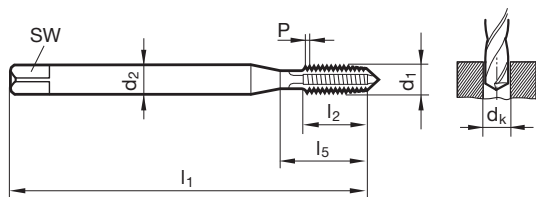

Standard **DIN 371**
Article no. **838**

d1	P	d2	SW	dk	l1	l2	l5	Order no.
M1,4	0.300	2.50	2.10	1.10	40.00	5.60	5.60	838 1.400
M1,6	0.350	2.50	2.10	1.25	40.00	6.40	6.40	838 1.600
M1,7	0.350	2.50	2.10	1.35	40.00	6.80	6.80	838 1.700
M1,8	0.350	2.50	2.10	1.45	40.00	7.30	7.30	838 1.800
M2	0.400	2.80	2.10	1.60	45.00	8.00	13.50	838 2.000
M2,5	0.450	2.80	2.10	2.05	50.00	9.00	14.50	838 2.500
M3	0.500	3.50	2.70	2.50	56.00	10.00	18.00	838 3.000
M3,5	0.600	4.00	3.00	2.90	56.00	12.00	20.00	838 3.500
M4	0.700	4.50	3.40	3.30	63.00	12.00	21.00	838 4.000
M5	0.800	6.00	4.90	4.20	70.00	14.00	25.00	838 5.000
M6	1.000	6.00	4.90	5.00	80.00	16.00	30.00	838 6.000
M8	1.250	8.00	6.20	6.80	90.00	17.00	35.00	838 8.000
M10	1.500	10.00	8.00	8.50	100.00	20.00	39.00	838 10.000

Taps

Taps for ISO metric threads

Article no. **991**



Cutting data page 959

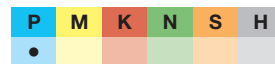

$P \leq 800 \text{ N/mm}^2$

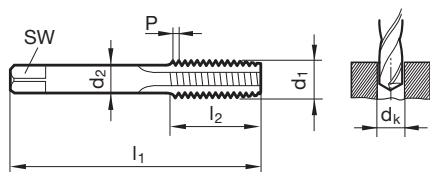

Standard **DIN 352**
Article no. **991**

d1	P	d2	SW	dk	l1	l2	l5	Order no.
M3	0.500	3.50	2.70	2.50	40.00	10.00	18.00	991 3.000
M4	0.700	4.50	3.40	3.30	45.00	12.00	21.00	991 4.000
M4,5	0.750	6.00	4.90	3.70	50.00	14.00	24.00	991 4.500
M5	0.800	6.00	4.90	4.20	50.00	14.00	24.00	991 5.000
M6	1.000	6.00	4.90	5.00	56.00	16.00	27.00	991 6.000
M8	1.250	6.00	4.90	6.80	63.00	17.00	32.00	991 8.000
M10	1.500	7.00	5.50	8.50	70.00	20.00	36.00	991 10.000
M12	1.750	9.00	7.00	10.20	75.00	24.00	40.00	991 12.000
M14	2.000	11.00	9.00	12.00	80.00	26.00	42.00	991 14.000
M16	2.000	12.00	9.00	14.00	80.00	26.00	45.00	991 16.000
M20	2.500	16.00	12.00	17.50	95.00	32.00	50.00	991 20.000
M24	3.000	18.00	14.50	21.00	110.00	36.00	60.00	991 24.000



Taps for ISO metric threads

Article no. 998



Cutting data page 959

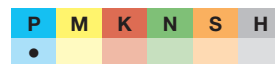

P ≤ 800 N/mm²

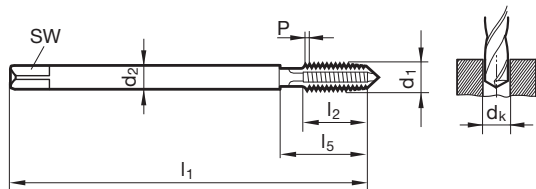

d1	P	d2	SW	dk	l1	l2	l5
mm	mm	mm	mm	mm	mm	mm	mm
M3	0.500	2.20	1.80	2.50	70.00	18.00	29.00
M4	0.700	2.80	2.10	3.30	90.00	22.00	34.00
M5	0.800	3.50	2.70	4.20	100.00	24.00	38.00
M6	1.000	4.50	3.40	5.00	110.00	25.00	39.00
M8	1.250	6.00	4.90	6.80	125.00	28.00	46.00
M10	1.500	7.00	5.50	8.50	140.00	30.00	54.00
M12	1.750	9.00	7.00	10.20	180.00	35.00	64.00
M14	2.000	11.00	9.00	12.00	200.00	35.00	64.00
M16	2.000	12.00	9.00	14.00	200.00	40.00	69.00
M20	2.500	16.00	12.00	17.50	250.00	45.00	74.00

Standard Article no. **Company std. 998**

Order no.
998 3.000
998 4.000
998 5.000
998 6.000
998 8.000
998 10.000
998 12.000
998 14.000
998 16.000
998 20.000

Taps

Machine nut taps for ISO metric threads

Article no. 851



Cutting data page 959

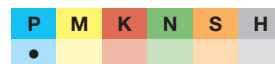

P ≤ 800 N/mm²

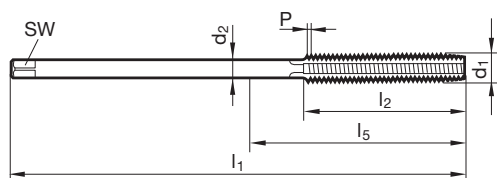

d1	P	d2	SW	dk	l1	l2	l5
mm	mm	mm	mm	mm	mm	mm	mm
M3	0.500	2.20	1.80	2.50	70.00	22.00	30.00
M4	0.700	2.80	2.10	3.30	90.00	25.00	33.00
M5	0.800	3.50	2.70	4.20	100.00	28.00	38.00
M6	1.000	4.50	3.40	5.00	110.00	32.00	44.00
M8	1.250	6.00	4.90	6.80	125.00	40.00	61.00
M10	1.500	7.00	5.50	8.50	140.00	45.00	85.00
M12	1.750	9.00	7.00	10.20	180.00	50.00	120.00
M14	2.000	11.00	9.00	12.00	200.00	56.00	130.00
M16	2.000	12.00	9.00	14.00	200.00	63.00	145.00
M18	2.500	14.00	11.00	15.50	220.00	63.00	155.00
M20	2.500	16.00	12.00	17.50	250.00	70.00	170.00

Standard Article no. **DIN 357 851**

Order no.
851 3.000
851 4.000
851 5.000
851 6.000
851 8.000
851 10.000
851 12.000
851 14.000
851 16.000
851 18.000
851 20.000



Machine combination drill taps for ISO metric threads

Article no. **1839**



Cutting data page 959



Web thinning $\geq \varnothing 3.000$

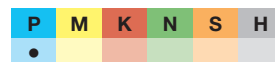

$P \leq 800 \text{ N/mm}^2$

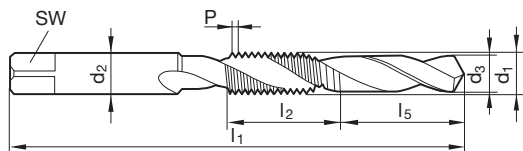

Standard
Article no.

Company std.

1839

Taps

	d1	P	d2	d3	SW	l1	l5	l2	Order no.
		mm	mm	mm	mm	mm	mm	mm	
	M3	0.500	3.50	2.50	2.70	62.00	11.00	12.00	1839 3.000
	M4	0.700	4.50	3.30	3.40	66.00	10.00	16.00	1839 4.000
	M5	0.800	6.00	4.20	4.90	75.00	12.00	18.00	1839 5.000
	M6	1.000	6.00	5.00	4.90	81.00	14.00	20.00	1839 6.000
	M8	1.250	6.00	6.80	4.90	93.00	20.00	12.00	1839 8.000
	M10	1.500	7.00	8.50	5.50	99.00	22.00	14.00	1839 10.000
	M12	1.750	9.00	10.20	7.00	106.00	25.00	16.00	1839 12.000



Taps for ISO metric fine threads

Article no. 827



Cutting data page 959

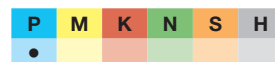

P ≤ 800 N/mm²

Taps for ISO metric fine threads

Article no. 832



Cutting data page 959

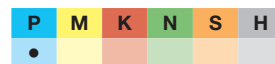

P ≤ 800 N/mm²

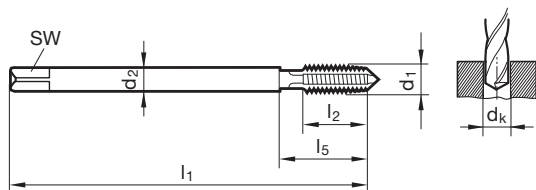

Standard
Article no.

DIN 374	
827	832

Taps

d1	d2 mm	SW mm	dk mm	l1 mm	l2 mm	l5 mm	Order no.	
M3 x 0,35	2.20	1.80	2.65	56.00	7.00	18.00	827 3.002	832 3.002
M3,5 x 0,35	2.50	2.10	3.15	56.00	8.00	20.00	827 3.502	832 3.502
M4 x 0,5	2.80	2.10	3.50	63.00	8.00	21.00	827 4.003	832 4.003
M5 x 0,5	3.50	2.70	4.50	70.00	10.00	25.00	827 5.003	832 5.003
M6 x 0,5	4.50	3.40	5.50	80.00	13.00	30.00	827 6.003	832 6.003
M6 x 0,75	4.50	3.40	5.20	80.00	13.00	30.00	827 6.004	832 6.004
M7 x 0,75	5.50	4.30	6.20	80.00	13.00	30.00	827 7.004	832 7.004
M8 x 0,5	6.00	4.90	7.50	80.00	14.00	30.00	827 8.003	832 8.003
M8 x 0,75	6.00	4.90	7.20	80.00	14.00	30.00	827 8.004	832 8.004
M8 x 1	6.00	4.90	7.00	90.00	17.00	35.00	827 8.005	832 8.005
M9 x 1	7.00	5.50	8.00	90.00	16.00	35.00	827 9.005	832 9.005
M10 x 0,75	7.00	5.50	9.20	90.00	16.00	35.00	827 10.004	832 10.004
M10 x 1	7.00	5.50	9.00	90.00	16.00	35.00	827 10.005	832 10.005
M10 x 1,25	7.00	5.50	8.80	100.00	20.00	39.00	827 10.006	832 10.006
M11 x 1	8.00	6.20	10.00	90.00	20.00	33.00	827 11.005	832 11.005
M12 x 1	9.00	7.00	11.00	100.00	20.00	40.00	827 12.005	832 12.005
M12 x 1,25	9.00	7.00	10.80	100.00	20.00	40.00	827 12.006	832 12.006
M12 x 1,5	9.00	7.00	10.50	100.00	20.00	40.00	827 12.007	832 12.007
M14 x 1	11.00	9.00	13.00	100.00	20.00	40.00	827 14.005	832 14.005
M14 x 1,25	11.00	9.00	12.80	100.00	20.00	40.00	827 14.006	832 14.006
M14 x 1,5	11.00	9.00	12.50	100.00	20.00	40.00	827 14.007	832 14.007
M15 x 1	12.00	9.00	14.00	100.00	20.00	40.00	827 15.005	
M15 x 1,5	12.00	9.00	13.50	100.00	20.00	44.00	827 15.007	832 15.007
M16 x 1	12.00	9.00	15.00	100.00	22.00	44.00	827 16.005	832 16.005
M16 x 1,5	12.00	9.00	14.50	100.00	22.00	44.00	827 16.007	832 16.007
M18 x 1	14.00	11.00	17.00	110.00	25.00	44.00	827 18.005	832 18.005
M18 x 1,5	14.00	11.00	16.50	110.00	25.00	44.00	827 18.007	832 18.007
M18 x 2	14.00	11.00	16.00	125.00	30.00	58.00	827 18.008	
M20 x 1	16.00	12.00	19.00	125.00	25.00	44.00	827 20.005	832 20.005
M20 x 1,5	16.00	12.00	18.50	125.00	25.00	44.00	827 20.007	832 20.007
M20 x 2	16.00	12.00	18.00	140.00	32.00	60.00	827 20.008	
M22 x 1,5	18.00	14.50	20.50	125.00	25.00	44.00	827 22.007	832 22.007
M22 x 2	18.00	14.50	20.00	140.00	32.00	62.00	827 22.008	
M24 x 1	18.00	14.50	23.00	140.00	28.00	48.00	827 24.005	832 24.005
M24 x 1,5	18.00	14.50	22.50	140.00	28.00	48.00	827 24.007	832 24.007
M24 x 2	18.00	14.50	22.00	140.00	28.00	48.00	827 24.008	832 24.008
M26 x 1,5	18.00	14.50	24.50	140.00	28.00	50.00	827 26.007	832 26.007
M27 x 1,5	20.00	16.00	25.50	140.00	28.00	53.00	827 27.007	832 27.007
M27 x 2	20.00	16.00	25.00	140.00	28.00	53.00	827 27.008	832 27.008
M28 x 1,5	20.00	16.00	26.50	140.00	28.00	53.00	827 28.007	
M30 x 1,5	22.00	18.00	28.50	150.00	28.00	53.00	827 30.007	832 30.007
M30 x 2	22.00	18.00	28.00	150.00	28.00	53.00	827 30.008	832 30.008
M32 x 1,5	22.00	18.00	30.50	150.00	28.00	53.00	827 32.007	832 32.007
M33 x 1,5	25.00	20.00	31.50	160.00	30.00	56.00	827 33.007	832 33.007
M35 x 1,5	28.00	22.00	33.50	170.00	30.00	56.00	827 35.007	832 35.007
M36 x 1,5	28.00	22.00	34.50	170.00	30.00	56.00	827 36.007	832 36.007
M38 x 1,5	28.00	22.00	36.50	170.00	30.00	56.00	827 38.007	
M40 x 1,5	32.00	24.00	38.50	170.00	30.00	57.00	827 40.007	



Taps for ISO metric fine threads

Article no. **316**



Cutting data page 959

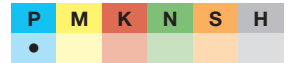

$P \leq 800 \text{ N/mm}^2$

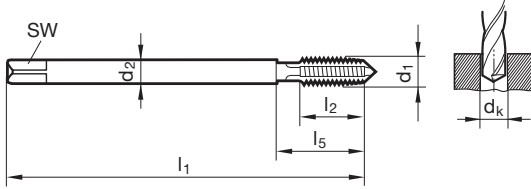

Standard

DIN 374

Article no.

316

	d1	d2	SW	dk	l1	l2	l5	Order no.
		mm	mm	mm	mm	mm	mm	
M6 x 0,75		4.50	3.40	5.20	80.00	13.00	30.00	316 6.004
M8 x 1		6.00	4.90	7.00	90.00	17.00	35.00	316 8.005
M10 x 1		7.00	5.50	9.00	90.00	16.00	35.00	316 10.005
M12 x 1,5		9.00	7.00	10.50	100.00	20.00	40.00	316 12.007
M16 x 1,5		12.00	9.00	14.50	100.00	22.00	44.00	316 16.007
M20 x 1,5		16.00	12.00	18.50	125.00	25.00	44.00	316 20.007

Taps



Taps for ISO metric fine threads

Article no. 2879



Cutting data page 960

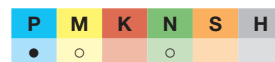

P ≤ 1000 N/mm²

Taps for ISO metric fine threads

Article no. 4778



Cutting data page 960

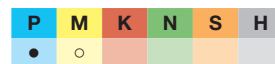

P ≤ 1000 N/mm²

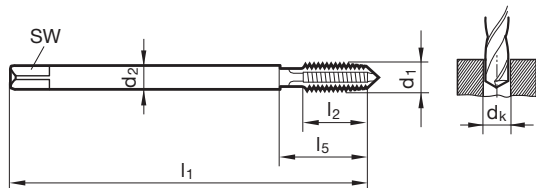

Standard
Article no.

DIN 374	
2879	4778

Taps

d1	d2 mm	SW mm	dk mm	l1 mm	l2 mm	l5 mm	Order no.	
M5 x 0,5	3.50	2.70	4.50	70.00	10.00	25.00	2879 5.003	4778 5.003
M6 x 0,75	4.50	3.40	5.20	80.00	13.00	30.00	2879 6.004	4778 6.004
M8 x 0,75	6.00	4.90	7.20	80.00	14.00	30.00	2879 8.004	4778 8.004
M8 x 1	6.00	4.90	7.00	90.00	17.00	35.00	2879 8.005	4778 8.005
M10 x 1	7.00	5.50	9.00	90.00	16.00	35.00	2879 10.005	4778 10.005
M12 x 1	9.00	7.00	11.00	100.00	20.00	40.00	2879 12.005	4778 12.005
M12 x 1,5	9.00	7.00	10.50	100.00	20.00	40.00	2879 12.007	4778 12.007
M14 x 1,5	11.00	9.00	12.50	100.00	20.00	40.00	2879 14.007	4778 14.007
M16 x 1,5	12.00	9.00	14.50	100.00	22.00	44.00	2879 16.007	4778 16.007
M18 x 1,5	14.00	11.00	16.50	110.00	25.00	44.00	2879 18.007	4778 18.007
M20 x 1,5	16.00	12.00	18.50	125.00	25.00	44.00	2879 20.007	4778 20.007
M22 x 1,5	18.00	14.50	20.50	125.00	25.00	44.00	2879 22.007	4778 22.007
M24 x 1,5	18.00	14.50	22.50	140.00	28.00	48.00	2879 24.007	4778 24.007
M24 x 2	18.00	14.50	22.00	140.00	28.00	48.00	2879 24.008	4778 24.008
M26 x 1,5	18.00	14.50	24.50	140.00	28.00	50.00	2879 26.007	4778 26.007
M27 x 1,5	20.00	16.00	25.50	140.00	28.00	53.00	2879 27.007	4778 27.007
M27 x 2	20.00	16.00	25.00	140.00	28.00	53.00	2879 27.008	4778 27.008
M28 x 1,5	20.00	16.00	26.50	140.00	28.00	53.00	2879 28.007	4778 28.007
M30 x 1,5	22.00	18.00	28.50	150.00	28.00	53.00	2879 30.007	4778 30.007
M30 x 2	22.00	18.00	28.00	150.00	28.00	53.00	2879 30.008	4778 30.008
M32 x 1,5	22.00	18.00	30.50	150.00	28.00	53.00	2879 32.007	
M36 x 1,5	28.00	22.00	34.50	170.00	30.00	56.00	2879 36.007	
M40 x 1,5	32.00	24.00	38.50	170.00	30.00	57.00	2879 40.007	
M42 x 1,5	32.00	24.00	40.50	170.00	30.00	57.00	2879 42.007	
M45 x 1,5	36.00	29.00	43.50	180.00	32.00	60.00	2879 45.007	
M48 x 1,5	36.00	29.00	46.50	190.00	32.00	60.00	2879 48.007	
M50 x 1,5	36.00	29.00	48.50	190.00	32.00	60.00	2879 50.007	



Taps for ISO metric fine threads

Article no. **1291**



Cutting data page 960

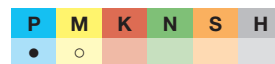

$P \leq 1000 \text{ N/mm}^2$

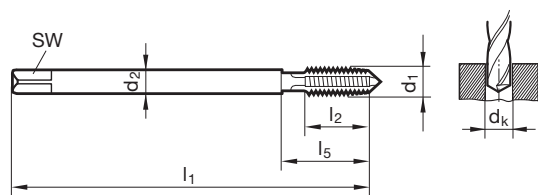

Standard

DIN 374

Article no.

1291

Taps

	d1	d2	SW	dk	l1	l2	l5	Order no.
		mm	mm	mm	mm	mm	mm	
	M8 x 1	6.00	4.90	7.00	90.00	17.00	35.00	1291 8.005
	M10 x 1	7.00	5.50	9.00	90.00	16.00	35.00	1291 10.005
	M10 x 1,25	7.00	5.50	8.80	100.00	20.00	39.00	1291 10.006
	M12 x 1	9.00	7.00	11.00	100.00	20.00	40.00	1291 12.005
	M12 x 1,25	9.00	7.00	10.80	100.00	20.00	40.00	1291 12.006
	M12 x 1,5	9.00	7.00	10.50	100.00	20.00	40.00	1291 12.007
	M14 x 1,25	11.00	9.00	12.80	100.00	20.00	40.00	1291 14.006
	M14 x 1,5	11.00	9.00	12.50	100.00	20.00	40.00	1291 14.007
	M16 x 1,5	12.00	9.00	14.50	100.00	22.00	44.00	1291 16.007
	M18 x 1,5	14.00	11.00	16.50	110.00	25.00	44.00	1291 18.007
	M20 x 1,5	16.00	12.00	18.50	125.00	25.00	44.00	1291 20.007
	M22 x 1,5	18.00	14.50	20.50	125.00	25.00	44.00	1291 22.007
	M24 x 1,5	18.00	14.50	22.50	140.00	28.00	48.00	1291 24.007
	M24 x 2	18.00	14.50	22.00	140.00	28.00	48.00	1291 24.008



Taps for ISO metric fine threads

Article no. 2992



Cutting data page 960

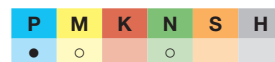

P ≤ 1000 N/mm²

Taps for ISO metric fine threads

Article no. 2993



Cutting data page 960

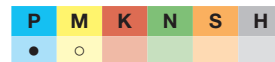

P ≤ 1000 N/mm²

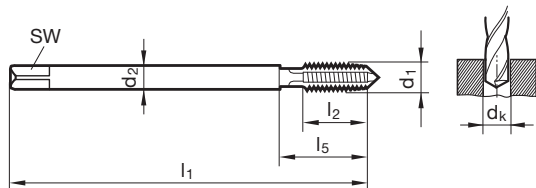

Standard
Article no.

DIN 374	
2992	2993

Taps

d1	d2 mm	SW mm	dk mm	l1 mm	l2 mm	l5 mm
M8 x 1	6.00	4.90	7.00	90.00	17.00	35.00
M10 x 1	7.00	5.50	9.00	90.00	16.00	35.00
M12 x 1	9.00	7.00	11.00	100.00	20.00	40.00
M12 x 1,25	9.00	7.00	10.80	100.00	20.00	40.00
M12 x 1,5	9.00	7.00	10.50	100.00	20.00	40.00
M14 x 1,5	11.00	9.00	12.50	100.00	20.00	40.00
M16 x 1,5	12.00	9.00	14.50	100.00	22.00	44.00
M18 x 1,5	14.00	11.00	16.50	110.00	25.00	44.00
M20 x 1,5	16.00	12.00	18.50	125.00	25.00	44.00

Order no.	
2992 8.005	2993 8.005
2992 10.005	2993 10.005
2992 12.005	2993 12.005
2992 12.006	2993 12.006
2992 12.007	2993 12.007
2992 14.007	2993 14.007
2992 16.007	2993 16.007
2992 18.007	2993 18.007
2992 20.007	2993 20.007



Taps for ISO metric fine threads

Article no. **943**



Cutting data page 960

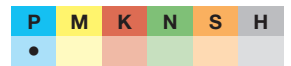

$P \leq 1000 \text{ N/mm}^2$

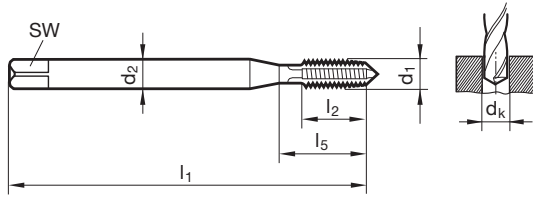

Standard **~DIN 371**
Article no. **943**

d1	d2 mm	SW mm	dk mm	l1 mm	l2 mm	l5 mm	Order no.
M8 x 1	8.00	6.20	7.00	90.00	15.00	35.00	943 8.005
M10 x 1	10.00	8.00	9.00	90.00	15.00	35.00	943 10.005
M10 x 1,25	10.00	8.00	8.80	100.00	19.00	39.00	943 10.006
M12 x 1	12.00	9.00	11.00	100.00	15.00	40.00	943 12.005
M12 x 1,25	12.00	9.00	10.80	100.00	19.00	40.00	943 12.006
M12 x 1,5	12.00	9.00	10.50	100.00	22.50	40.00	943 12.007

Taps

Taps for ISO metric fine threads

Article no. **944**



Cutting data page 960

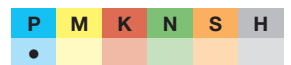

$P \leq 1000 \text{ N/mm}^2$

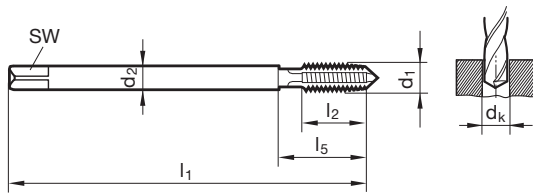

Standard **DIN 374**
Article no. **944**

d1	d2 mm	SW mm	dk mm	l1 mm	l2 mm	l5 mm	Order no.
M14 x 1,5	11.00	9.00	12.50	100.00	22.50	40.00	944 14.007
M16 x 1,5	12.00	9.00	14.50	100.00	22.50	44.00	944 16.007



Taps for ISO metric fine threads

Article no. **2943**



Cutting data page 961

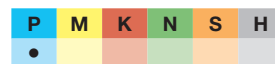

P ≤ 1200 N/mm²

Taps for ISO metric fine threads

Article no. **4793**



Cutting data page 961

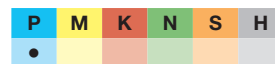

P ≤ 1200 N/mm²

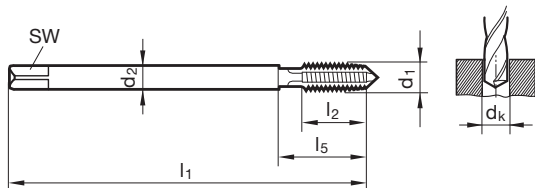

Standard
Article no.

DIN 374	
2943	4793

Taps

d1	d2 mm	SW mm	dk mm	l1 mm	l2 mm	l5 mm
M8 x 0,75	6.00	4.90	7.20	80.00	14.00	30.00
M8 x 1	6.00	4.90	7.00	90.00	17.00	35.00
M10 x 1	7.00	5.50	9.00	90.00	16.00	35.00
M12 x 1	9.00	7.00	11.00	100.00	20.00	40.00
M12 x 1,5	9.00	7.00	10.50	100.00	20.00	40.00
M14 x 1,5	11.00	9.00	12.50	100.00	20.00	40.00
M16 x 1,5	12.00	9.00	14.50	100.00	22.00	44.00
M20 x 1,5	16.00	12.00	18.50	125.00	25.00	44.00
M22 x 1,5	18.00	14.50	20.50	125.00	25.00	44.00
M24 x 1,5	18.00	14.50	22.50	140.00	28.00	48.00

Order no.	
2943 8.004	4793 8.004
2943 8.005	4793 8.005
2943 10.005	4793 10.005
2943 12.005	4793 12.005
2943 12.007	4793 12.007
2943 14.007	4793 14.007
2943 16.007	4793 16.007
2943 20.007	4793 20.007
2943 22.007	4793 22.007
2943 24.007	4793 24.007



Taps for ISO metric fine threads

Article no. **4794**



Cutting data page 961

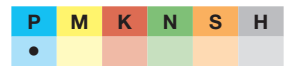

P ≤ 1200 N/mm²

Taps for ISO metric fine threads

Article no. **2983**



Cutting data page 961

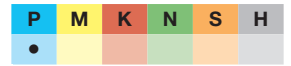

P ≤ 1200 N/mm²

Taps

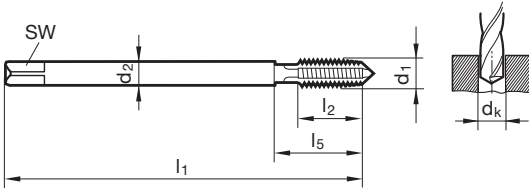

Standard
Article no.

DIN 374

4794

2983

d1	d2 mm	SW mm	dk mm	l1 mm	l2 mm	l5 mm
M8 x 1	6.00	4.90	7.00	90.00	17.00	35.00
M10 x 1	7.00	5.50	9.00	90.00	16.00	35.00
M12 x 1,5	9.00	7.00	10.50	100.00	20.00	40.00
M14 x 1,5	11.00	9.00	12.50	100.00	20.00	40.00
M16 x 1,5	12.00	9.00	14.50	100.00	22.00	44.00
M18 x 1,5	14.00	11.00	16.50	110.00	25.00	44.00
M20 x 1,5	16.00	12.00	18.50	125.00	25.00	44.00

Order no.

4794 8.005	2983 8.005
4794 10.005	2983 10.005
4794 12.007	2983 12.007
4794 14.007	2983 14.007
4794 16.007	2983 16.007
4794 18.007	2983 18.007
4794 20.007	2983 20.007



Taps for ISO metric fine threads

Article no. 1873



Cutting data page 964

P	M	K	N	S	H
○	●	○	○	○	○

P ≤ 1000 N/mm²

Taps for ISO metric fine threads

Article no. 2871



Cutting data page 964

P	M	K	N	S	H
○	●	○	○	○	○

P ≤ 1000 N/mm²

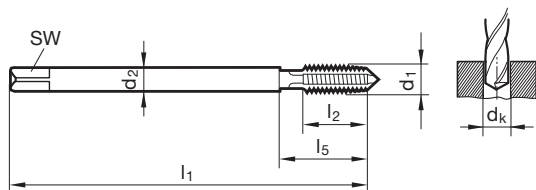

Standard
Article no.

DIN 374	
1873	2871

Taps

d1	d2 mm	SW mm	dk mm	l1 mm	l2 mm	l5 mm	Order no.	
M3 x 0,35	2.20	1.80	2.65	56.00	7.00	18.00	1873 3.002	2871 3.002
M4 x 0,5	2.80	2.10	3.50	63.00	8.00	21.00	1873 4.003	2871 4.003
M5 x 0,5	3.50	2.70	4.50	70.00	10.00	25.00	1873 5.003	2871 5.003
M6 x 0,75	4.50	3.40	5.20	80.00	13.00	30.00	1873 6.004	2871 6.004
M8 x 0,75	6.00	4.90	7.20	80.00	14.00	30.00	1873 8.004	2871 8.004
M8 x 1	6.00	4.90	7.00	90.00	17.00	35.00	1873 8.005	2871 8.005
M10 x 1	7.00	5.50	9.00	90.00	16.00	35.00	1873 10.005	2871 10.005
M12 x 1	9.00	7.00	11.00	100.00	20.00	40.00	1873 12.005	2871 12.005
M12 x 1,5	9.00	7.00	10.50	100.00	20.00	40.00	1873 12.007	2871 12.007
M14 x 1,5	11.00	9.00	12.50	100.00	20.00	40.00	1873 14.007	2871 14.007
M16 x 1,5	12.00	9.00	14.50	100.00	22.00	44.00	1873 16.007	2871 16.007
M18 x 1,5	14.00	11.00	16.50	110.00	25.00	44.00	1873 18.007	2871 18.007
M20 x 1,5	16.00	12.00	18.50	125.00	25.00	44.00	1873 20.007	2871 20.007
M22 x 1,5	18.00	14.50	20.50	125.00	25.00	44.00	1873 22.007	2871 22.007
M24 x 1,5	18.00	14.50	22.50	140.00	28.00	48.00	1873 24.007	2871 24.007



Taps with coolant ducts for ISO metric fine threads

Article no. **1861**



Cutting data page 962-963

P	M	K	N	S	H
		•	•		

N ≥ 7% Si

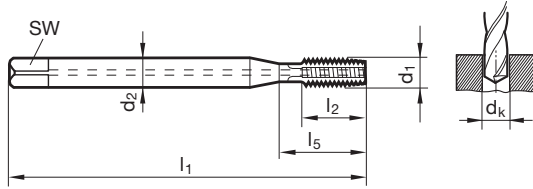

Standard	DIN 371
Article no.	1861

d1	d2 mm	SW mm	dk mm	l1 mm	l2 mm	l5 mm	Order no.
M8 x 1	8.00	6.20	7.00	90.00	16.00	35.00	1861 8.005
M10 x 1	10.00	8.00	9.00	90.00	18.00	35.00	1861 10.005

Taps

Taps with coolant ducts for ISO metric fine threads

Article no. **1860**



Cutting data page 959-963

P	M	K	N	S	H
		•	•		

N ≥ 7% Si

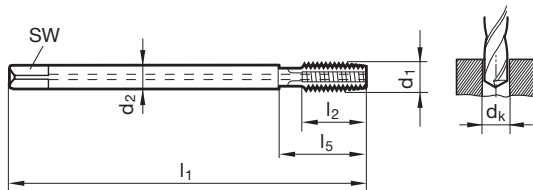

Standard	DIN 374
Article no.	1860

d1	d2 mm	SW mm	dk mm	l1 mm	l2 mm	l5 mm	Order no.
M12 x 1,5	9.00	7.00	10.50	100.00	15.00	40.00	1860 12.007
M14 x 1,5	11.00	9.00	12.50	100.00	15.00	40.00	1860 14.007
M16 x 1,5	12.00	9.00	14.50	100.00	15.00	44.00	1860 16.007
M18 x 1,5	14.00	11.00	16.50	110.00	15.00	44.00	1860 18.007
M20 x 1,5	16.00	12.00	18.50	125.00	15.00	44.00	1860 20.007



Taps for ISO metric fine threads

Article no. 2903



Cutting data page 966-967

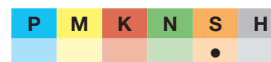

Taps for ISO metric fine threads

Article no. 2917



Cutting data page 966-967

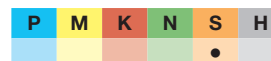

S = Ni

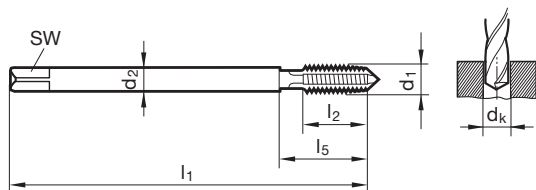

Standard
Article no.

DIN 371	
2903	2917

Taps

d1	d2 mm	SW mm	dk mm	l1 mm	l2 mm	l5 mm	Order no.	
M3 x 0,35	3.50	2.70	2.65	56.00	6.00	18.00	2903 3.002	2917 3.002
M4 x 0,5	4.50	3.40	3.50	63.00	7.50	21.00	2903 4.003	2917 4.003
M5 x 0,5	6.00	4.90	4.50	70.00	8.50	25.00	2903 5.003	2917 5.003
M6 x 0,5	6.00	4.90	5.50	80.00	11.00	30.00	2903 6.003	2917 6.003
M6 x 0,75	6.00	4.90	5.20	80.00	11.00	30.00	2903 6.004	2917 6.004
M8 x 0,5	8.00	6.20	7.50	80.00	14.00	30.00		
M8 x 0,75	8.00	6.20	7.20	80.00	14.00	30.00	2903 8.004	2917 8.004
M8 x 1	8.00	6.20	7.00	90.00	14.00	35.00	2903 8.005	2917 8.005
M10 x 1	10.00	8.00	9.00	90.00	16.00	35.00	2903 10.005	2917 10.005
M10 x 1,25	10.00	8.00	8.80	100.00	20.00	39.00		2917 10.006



Taps for UNC threads

Article no. **873**



Cutting data page 959

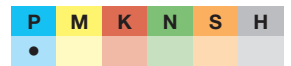

P ≤ 800 N/mm²

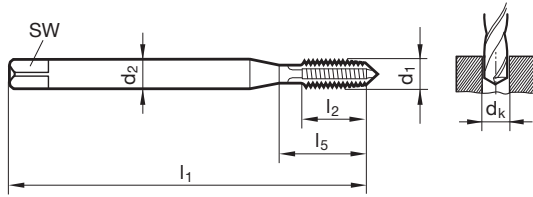

Standard **~DIN 371**
Article no. **873**

Taps

d1	d2 mm	SW mm	dk mm	l1 mm	l2 mm	l5 mm	Order no.
2 - 56	2.80	2.10	1.85	45.00	9.00	14.50	873 2.184
3 - 48	2.80	2.10	2.10	50.00	9.00	14.50	873 2.515
4 - 40	3.50	2.70	2.35	56.00	11.00	18.00	873 2.845
5 - 40	3.50	2.70	2.65	56.00	11.00	18.00	873 3.175
6 - 32	4.00	3.00	2.85	56.00	12.00	20.00	873 3.505
8 - 32	4.50	3.40	3.50	63.00	12.00	21.00	873 4.166
10 - 24	6.00	4.90	3.90	70.00	14.00	25.00	873 4.826
1/4 - 20	7.00	5.50	5.10	80.00	16.00	30.00	873 6.350
5/16 - 18	8.00	6.20	6.60	90.00	18.00	35.00	873 7.938
3/8 - 16	10.00	8.00	8.00	100.00	20.00	39.00	873 9.525

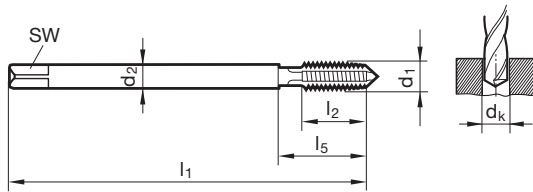

Standard **~DIN 376**
Article no. **878**

d1	d2 mm	SW mm	dk mm	l1 mm	l2 mm	l5 mm	Order no.
7/16 - 14	8.00	6.20	9.40	100.00	22.00	42.00	878 11.113
1/2 - 13	9.00	7.00	10.80	110.00	25.00	49.00	878 12.700
9/16 - 12	11.00	9.00	12.20	110.00	28.00	53.00	878 14.288
5/8 - 11	12.00	9.00	13.50	110.00	30.00	53.00	878 15.875
3/4 - 10	14.00	11.00	16.50	125.00	33.00	62.00	878 19.050
7/8 - 9	18.00	14.50	19.50	140.00	35.00	62.00	878 22.225
1 - 8	18.00	14.50	22.25	160.00	38.00	73.00	878 25.400
1 1/8 - 7	22.00	18.00	25.00	180.00	44.00	85.00	878 28.575
1 1/4 - 7	22.00	18.00	28.00	180.00	44.00	85.00	878 31.750
1 1/2 - 6	28.00	22.00	34.00	200.00	50.00	102.00	878 38.100



Taps for UNC threads

Article no. 2881



Cutting data page 960

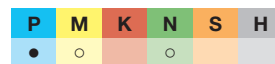

P ≤ 1000 N/mm²

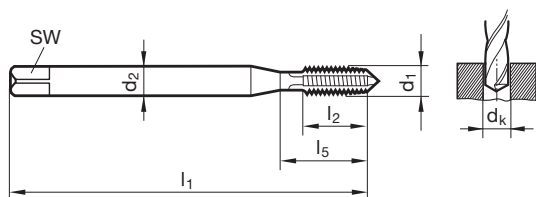

Standard ~DIN 371
Article no. 2881

d1	d2 mm	SW mm	dk mm	l1 mm	l2 mm	l5 mm	Order no.
4 - 40	3.50	2.70	2.35	56.00	11.00	18.00	2881 2.845
5 - 40	3.50	2.70	2.65	56.00	11.00	18.00	2881 3.175
6 - 32	4.00	3.00	2.85	56.00	12.00	20.00	2881 3.505
8 - 32	4.50	3.40	3.50	63.00	12.00	21.00	2881 4.166
10 - 24	6.00	4.90	3.90	70.00	14.00	25.00	2881 4.826
12 - 24	6.00	4.90	4.50	80.00	16.00	30.00	2881 5.486
1/4 - 20	7.00	5.50	5.10	80.00	16.00	30.00	2881 6.350
5/16 - 18	8.00	6.20	6.60	90.00	18.00	35.00	2881 7.938
3/8 - 16	10.00	8.00	8.00	100.00	20.00	39.00	2881 9.525

Taps

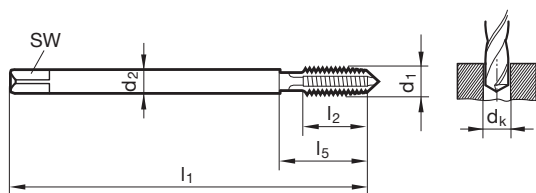

Standard ~DIN 376
Article no. 2883

d1	d2 mm	SW mm	dk mm	l1 mm	l2 mm	l5 mm	Order no.
7/16 - 14	8.00	6.20	9.40	100.00	22.00	42.00	2883 11.113
1/2 - 13	9.00	7.00	10.80	110.00	25.00	49.00	2883 12.700
9/16 - 12	11.00	9.00	12.20	110.00	28.00	53.00	2883 14.288
5/8 - 11	12.00	9.00	13.50	110.00	30.00	53.00	2883 15.875
3/4 - 10	14.00	11.00	16.50	125.00	33.00	62.00	2883 19.050
7/8 - 9	18.00	14.50	19.50	140.00	35.00	62.00	2883 22.225
1 - 8	18.00	14.50	22.25	160.00	38.00	73.00	2883 25.400



Taps for UNC threads

Article no. **1980**



Cutting data page 964

P	M	K	N	S	H
○	●	○	○	○	○

P ≤ 1000 N/mm²

Taps for UNC threads

Article no. **2872**



Cutting data page 964

P	M	K	N	S	H
○	●	○	○	○	○

P ≤ 1000 N/mm²

Taps

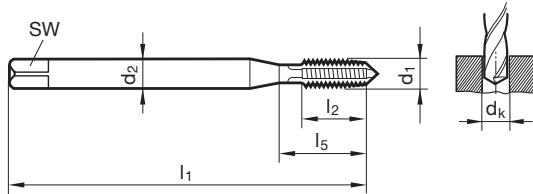

Standard
Article no.

~DIN 371	
1980	2872

d1	d2 mm	SW mm	dk mm	l1 mm	l2 mm	l5 mm
4 - 40	3.50	2.70	2.35	56.00	11.00	18.00
6 - 32	4.00	3.00	2.85	56.00	12.00	20.00
8 - 32	4.50	3.40	3.50	63.00	12.00	21.00
10 - 24	6.00	4.90	3.90	70.00	14.00	25.00
1/4 - 20	7.00	5.50	5.10	80.00	16.00	30.00
5/16 - 18	8.00	6.20	6.60	90.00	18.00	35.00
3/8 - 16	10.00	8.00	8.00	100.00	20.00	39.00

Order no.	
1980 2.845	2872 2.845
1980 3.505	2872 3.505
1980 4.166	2872 4.166
1980 4.826	2872 4.826
1980 6.350	2872 6.350
1980 7.938	2872 7.938
1980 9.525	2872 9.525

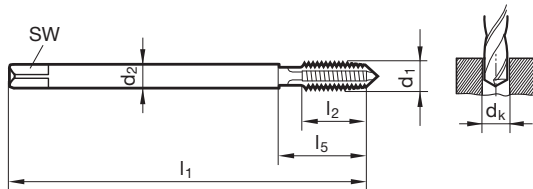

Standard
Article no.

~DIN 376	
1985	2873

d1	d2 mm	SW mm	dk mm	l1 mm	l2 mm	l5 mm
1/2 - 13	9.00	7.00	10.80	110.00	25.00	49.00
5/8 - 11	12.00	9.00	13.50	110.00	30.00	53.00
3/4 - 10	14.00	11.00	16.50	125.00	33.00	62.00
7/8 - 9	18.00	14.50	19.50	140.00	35.00	62.00
1 - 8	18.00	14.50	22.25	160.00	38.00	73.00

Order no.	
1985 12.700	2873 12.700
1985 15.875	2873 15.875
1985 19.050	2873 19.050
1985 22.225	2873 22.225
1985 25.400	2873 25.400



Taps for UNC threads

Article no. 2905



Cutting data page 966-967

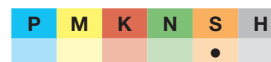

Taps for UNC threads

Article no. 2918



Cutting data page 966-967

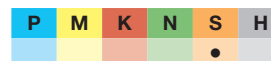

S = Ni

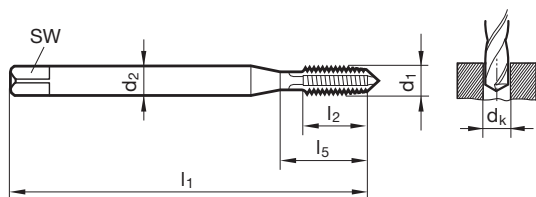

Standard Article no.

~DIN 371	
2905	2918

Taps

d1	d2 mm	SW mm	dk mm	l1 mm	l2 mm	l5 mm
6 - 32	4.00	3.00	2.85	56.00	12.00	20.00
8 - 32	4.50	3.40	3.50	63.00	12.00	21.00
10 - 24	6.00	4.90	3.90	70.00	14.00	25.00
12 - 24	6.00	4.90	4.50	80.00	16.00	30.00
1/4 - 20	7.00	5.50	5.10	80.00	16.00	30.00
5/16 - 18	8.00	6.20	6.60	90.00	18.00	35.00
3/8 - 16	10.00	8.00	8.00	100.00	20.00	39.00

Order no.	
2905 3.505	2918 3.505
2905 4.166	2918 4.166
2905 4.826	2918 4.826
2905 5.486	2918 5.486
2905 6.350	2918 6.350
2905 7.938	2918 7.938
2905 9.525	2918 9.525

Taps for UNF threads

Article no. **908**



Cutting data page 959

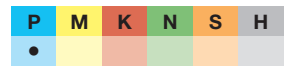

$P \leq 800 \text{ N/mm}^2$

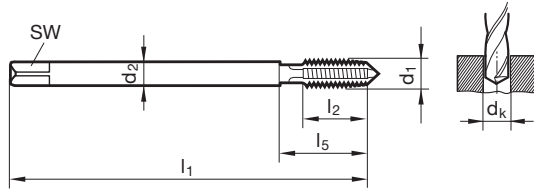

Standard **~DIN 374**
Article no. **908**

Taps

d1	d2 mm	SW mm	dk mm	l1 mm	l2 mm	l5 mm	Order no.
10 - 32	3.50	2.70	4.10	70.00	14.00	25.00	908 4.826
12 - 28	4.00	3.00	4.60	80.00	16.00	30.00	908 5.486
1/4 - 28	4.50	3.40	5.50	80.00	16.00	30.00	908 6.350
5/16 - 24	6.00	4.90	6.90	90.00	17.00	35.00	908 7.938
3/8 - 24	7.00	5.50	8.50	90.00	18.00	35.00	908 9.525
7/16 - 20	8.00	6.20	9.90	100.00	22.00	42.00	908 11.113
1/2 - 20	9.00	7.00	11.50	100.00	20.00	40.00	908 12.700
9/16 - 18	11.00	9.00	12.90	100.00	22.00	40.00	908 14.288
5/8 - 18	12.00	9.00	14.50	100.00	22.00	44.00	908 15.875
3/4 - 16	14.00	11.00	17.50	110.00	25.00	44.00	908 19.050
7/8 - 14	18.00	14.50	20.40	125.00	25.00	44.00	908 22.225
1 - 12	18.00	14.50	23.25	140.00	28.00	50.00	908 25.400
1 1/8 - 12	22.00	18.00	26.50	150.00	28.00	53.00	908 28.575
1 1/4 - 12	22.00	18.00	29.50	150.00	28.00	53.00	908 31.750

Taps for UNF threads

Article no. **2885**



Cutting data page 960



$P \leq 1000 \text{ N/mm}^2$

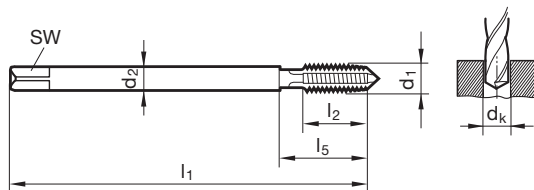

Standard **~DIN 374**
Article no. **2885**

d1	d2 mm	SW mm	dk mm	l1 mm	l2 mm	l5 mm	Order no.
10 - 32	3.50	2.70	4.10	70.00	14.00	25.00	2885 4.826
1/4 - 28	4.50	3.40	5.50	80.00	16.00	30.00	2885 6.350
5/16 - 24	6.00	4.90	6.90	90.00	17.00	35.00	2885 7.938
3/8 - 24	7.00	5.50	8.50	90.00	18.00	35.00	2885 9.525
7/16 - 20	8.00	6.20	9.90	100.00	22.00	42.00	2885 11.113
1/2 - 20	9.00	7.00	11.50	100.00	20.00	40.00	2885 12.700
5/8 - 18	12.00	9.00	14.50	100.00	22.00	44.00	2885 15.875
7/8 - 14	18.00	14.50	20.40	125.00	25.00	44.00	2885 22.225



Taps for UNF threads

Article no. 2907



HSS-E-PM
C
Ti Ni
2BX
R
Cyl
B
2xD

Cutting data page 966-967

P	M	K	N	S	H
				•	

Taps for UNF threads

Article no. 2919



HSS-E-PM
A
Ti Ni
2BX
R
Cyl
B
2xD

Cutting data page 966-967

P	M	K	N	S	H
				•	

S = Ni

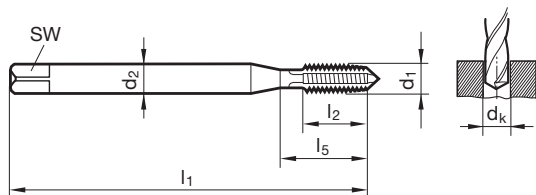

Standard Article no.

~DIN 371	
2907	2919

Taps

d1	d2 mm	SW mm	dk mm	l1 mm	l2 mm	l5 mm
6 - 40	4.00	3.00	2.95	56.00	11.00	20.00
8 - 36	4.50	3.40	3.50	63.00	12.00	21.00
10 - 32	6.00	4.90	4.10	70.00	14.00	25.00
12 - 28	6.00	4.90	4.60	80.00	16.00	30.00
1/4 - 28	7.00	5.50	5.50	80.00	16.00	30.00
5/16 - 24	8.00	6.20	6.90	90.00	17.00	35.00
3/8 - 24	10.00	8.00	8.50	90.00	18.00	35.00

Order no.	
2907 3.505	2919 3.505
2907 4.166	2919 4.166
2907 4.826	2919 4.826
2907 5.486	2919 5.486
2907 6.350	2919 6.350
2907 7.938	2919 7.938
2907 9.525	2919 9.525

Taps for BSP threads

Article no. **962**



Cutting data page 959

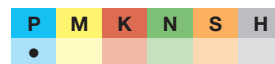

$P \leq 800 \text{ N/mm}^2$

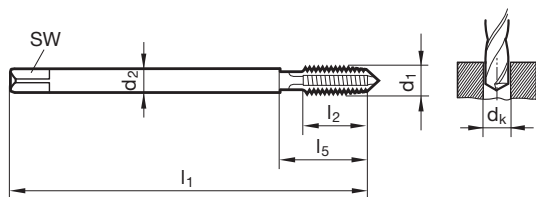

Standard **DIN 5156**
Article no. **962**

d1	P G/inch	d2 mm	SW mm	dk mm	l1 mm	l2 mm	l5 mm	Order no.
G1/8	28	7.00	5.50	8.80	90.00	18.00	35.00	962 9.728
G1/4	19	11.00	9.00	11.80	100.00	20.00	40.00	962 13.157
G3/8	19	12.00	9.00	15.25	100.00	22.00	44.00	962 16.662
G1/2	14	16.00	12.00	19.00	125.00	25.00	44.00	962 20.955
G3/4	14	20.00	16.00	24.50	140.00	28.00	53.00	962 26.441
G1	11	25.00	20.00	30.75	160.00	30.00	56.00	962 33.249
G1 1/4	11	32.00	24.00	39.50	170.00	30.00	57.00	962 41.910
G1 1/2	11	36.00	29.00	45.25	190.00	32.00	60.00	962 47.803
G2	11	45.00	35.00	57.00	220.00	40.00	95.00	962 59.614

Taps

Taps for BSP threads

Article no. **2887**



Cutting data page 960

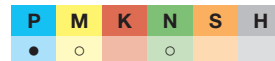

$P \leq 1000 \text{ N/mm}^2$

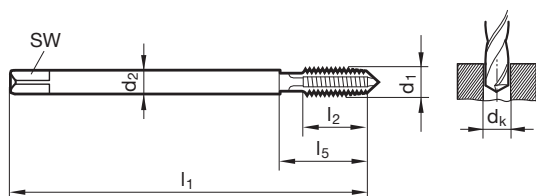

Standard **DIN 5156**
Article no. **2887**

d1	P G/inch	d2 mm	SW mm	dk mm	l1 mm	l2 mm	l5 mm	Order no.
G1/8	28	7.00	5.50	8.80	90.00	18.00	35.00	2887 9.728
G1/4	19	11.00	9.00	11.80	100.00	20.00	40.00	2887 13.157
G3/8	19	12.00	9.00	15.25	100.00	22.00	44.00	2887 16.662
G1/2	14	16.00	12.00	19.00	125.00	25.00	44.00	2887 20.955
G3/4	14	20.00	16.00	24.50	140.00	28.00	53.00	2887 26.441
G1	11	25.00	20.00	30.75	160.00	30.00	56.00	2887 33.249
G1 1/4	11	32.00	24.00	39.50	170.00	30.00	57.00	2887 41.910
G1 1/2	11	36.00	29.00	45.25	190.00	32.00	60.00	2887 47.803
G2	11	45.00	35.00	57.00	220.00	40.00	95.00	2887 59.614



Taps for BSP threads

Article no. 4795



Cutting data page 961

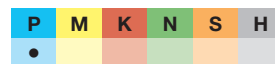

P ≤ 1200 N/mm²

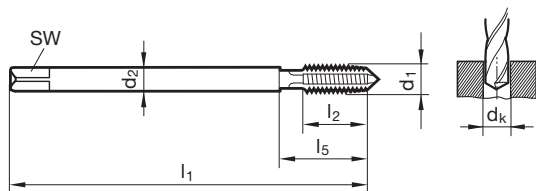

Standard **DIN 5156**
Article no. **4795**

d1	P G/inch	d2 mm	SW mm	dk mm	l1 mm	l2 mm	l5 mm	Order no.
G1/16	28	6.00	4.90	6.80	90.00	18.00	30.00	4795 7.723
G1/8	28	7.00	5.50	8.80	90.00	18.00	35.00	4795 9.728
G1/4	19	11.00	9.00	11.80	100.00	20.00	40.00	4795 13.157
G3/8	19	12.00	9.00	15.25	100.00	22.00	44.00	4795 16.662
G1/2	14	16.00	12.00	19.00	125.00	25.00	44.00	4795 20.955
G3/4	14	20.00	16.00	24.50	140.00	28.00	53.00	4795 26.441
G1	11	25.00	20.00	30.75	160.00	30.00	56.00	4795 33.249

Taps



Taps for BSP threads

Article no. **967**



Cutting data page 964

P	M	K	N	S	H
○	●	○	○	○	○

$P \leq 1000 \text{ N/mm}^2$

Taps for BSP threads

Article no. **2875**



Cutting data page 964

P	M	K	N	S	H
○	●	○	○	○	○

$P \leq 1000 \text{ N/mm}^2$

Taps

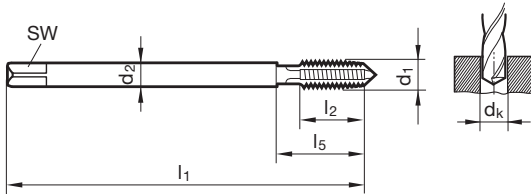

Standard
Article no.

DIN 5156

967	2875
------------	-------------

d1	P G/inch	d2 mm	SW mm	dk mm	l1 mm	l2 mm	l5 mm	Order no.	
G1/8	28	7.00	5.50	8.80	90.00	18.00	35.00	967 9.728	2875 9.728
G1/4	19	11.00	9.00	11.80	100.00	20.00	40.00	967 13.157	2875 13.157
G3/8	19	12.00	9.00	15.25	100.00	22.00	44.00	967 16.662	2875 16.662
G1/2	14	16.00	12.00	19.00	125.00	25.00	44.00	967 20.955	2875 20.955
G3/4	14	20.00	16.00	24.50	140.00	28.00	53.00	967 26.441	2875 26.441
G1	11	25.00	20.00	30.75	160.00	30.00	56.00	967 33.249	2875 33.249



Taps for EG threads

Article no. 1010



Cutting data page 960

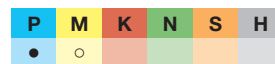

P ≤ 1000 N/mm²

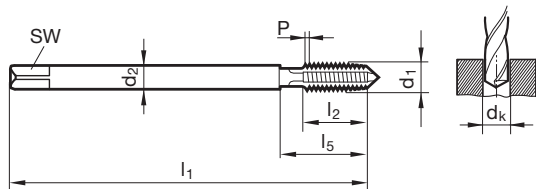

Standard **DIN 40435**
Article no. **1010**

d1	P	d2	SW	dk	l1	l2	l5	Order no.
mm	mm	mm	mm	mm	mm	mm	mm	
EG/STI M3		4.50	3.40	3.15	63.00	12.00	21.00	1010 3.000
EG/STI M4	0.700	6.00	4.90	4.20	70.00	12.00	25.00	1010 4.000
EG/STI M5	0.800	6.00	4.90	5.25	80.00	14.00	30.00	1010 5.000
EG/STI M6	1.000	8.00	6.20	6.30	90.00	17.00	35.00	1010 6.000
EG/STI M8	1.250	10.00	8.00	8.40	100.00	20.00	39.00	1010 8.000
EG/STI M10	1.500	9.00	7.00	10.50	100.00	20.00	40.00	1010 10.000
EG/STI M12	1.750	11.00	9.00	12.50	110.00	28.00	53.00	1010 12.000
EG/STI M14	2.000	12.00	9.00	14.50	110.00	26.00	54.00	1010 14.000
EG/STI M16	2.000	14.00	11.00	16.50	125.00	33.00	62.00	1010 16.000

Taps



Taps for PT threads

Article no. **980**



Cutting data page 959

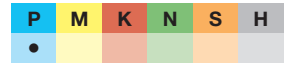

P ≤ 800 N/mm²

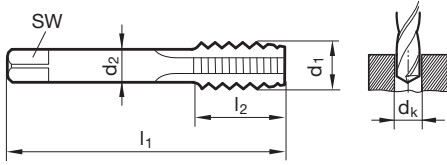

Standard

DIN 40432

Article no.

980

d1	P G/inch	d2 mm	SW mm	dk mm	l1 mm	l2 mm	l5 mm	Order no.
PG7	20	9.00	7.00	11.40	70.00	22.00	35.00	980 12.500
PG9	18	12.00	9.00	14.00	70.00	22.00	35.00	980 15.200
PG11	18	14.00	11.00	17.30	80.00	22.00	40.00	980 18.600
PG13.5	18	16.00	12.00	19.00	80.00	22.00	40.00	980 20.400
PG16	18	18.00	14.50	21.30	80.00	22.00	40.00	980 22.500
PG21	16	22.00	18.00	26.90	90.00	22.00	42.00	980 28.300

Taps

Taps for MJ threads

Article no. 1057

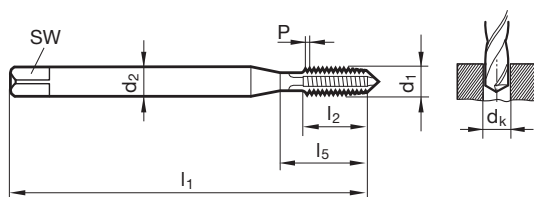
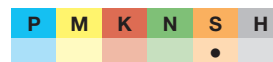

Cutting data page 966-967

 Standard **DIN 371/DIN 376**
 Article no. **1057**

d1	P mm	d2 mm	SW mm	dk mm	l1 mm	l2 mm	l5 mm	Standard	Order no.
MJ3 x 0,5	0.500	3.50	2.70	2.60	56.00	10.00	18.00	DIN 371	1057 3.000
MJ4 x 0,7	0.700	4.50	3.40	3.40	63.00	12.00	21.00	DIN 371	1057 4.000
MJ5 x 0,8	0.800	6.00	4.90	4.30	70.00	14.00	25.00	DIN 371	1057 5.000
MJ6 x 1,0	1.000	6.00	4.90	5.10	80.00	16.00	30.00	DIN 371	1057 6.000
MJ8 x 1,25	1.250	8.00	6.20	6.90	90.00	17.00	35.00	DIN 371	1057 8.000
MJ10 x 1,5	1.500	10.00	8.00	8.60	100.00	20.00	39.00	DIN 371	1057 10.000
MJ12 x 1,5	1.750	9.00	7.00	10.40	110.00	24.00	49.00	DIN 376	1057 12.000
MJ16 x 2,0	2.000	12.00	9.00	14.20	110.00	26.00	54.00	DIN 376	1057 16.000

Taps

Taps for MJF threads

Article no. 1058

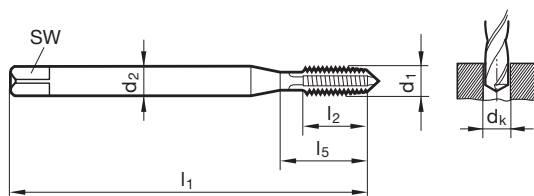
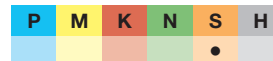

Cutting data page 966-967

 Standard **DIN 371**
 Article no. **1058**

d1	P mm	d2 mm	SW mm	dk mm	l1 mm	l2 mm	l5 mm	Standard	Order no.
MJF6 x 0,5	0.500	6.00	4.90	5.60	80.00	11.00	30.00	DIN 371	1058 6.003
MJF6 x 0,75	0.750	6.00	4.90	5.40	80.00	11.00	30.00	DIN 371	1058 6.004
MJF8 x 1,0	1.000	8.00	6.20	7.10	90.00	14.00	35.00	DIN 371	1058 8.005
MJF10 x 1,0	1.000	10.00	8.00	9.10	90.00	16.00	35.00	DIN 371	1058 10.005
MJF10 x 1,25	1.250	10.00	8.00	8.90	100.00	20.00	39.00	DIN 371	1058 10.006



Taps for UNJC threads

Article no. **1059**



Cutting data page 966-967

P	M	K	N	S	H
				•	

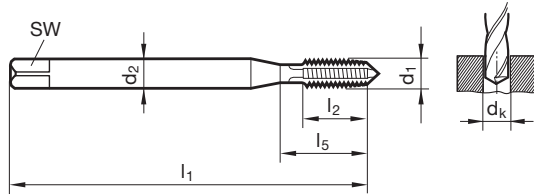

Standard **~DIN 371/~DIN 376**
Article no. **1059**

Taps

d1	d2 mm	SW mm	dk mm	l1 mm	l2 mm	l5 mm		Order no.
6 - 32	4.00	3.00	2.85	56.00	12.00	20.00	~DIN 371	1059 3.505
8 - 32	4.50	3.40	3.50	63.00	12.00	21.00	~DIN 371	1059 4.166
10 - 24	6.00	4.90	3.90	70.00	14.00	25.00	~DIN 371	1059 4.826
12 - 24	6.00	4.90	4.50	80.00	16.00	30.00	~DIN 371	1059 5.486
1/4 - 20	7.00	5.50	5.10	80.00	16.00	30.00	~DIN 371	1059 6.350
5/16 - 18	8.00	6.20	6.60	90.00	18.00	35.00	~DIN 371	1059 7.938
3/8 - 16	10.00	8.00	8.00	100.00	20.00	39.00	~DIN 371	1059 9.525
7/16 - 14	8.00	6.20	9.40	100.00	22.00	42.00	~DIN 376	1059 11.113
1/2 - 13	9.00	7.00	10.80	110.00	25.00	49.00	~DIN 376	1059 12.700
5/8 - 11	12.00	9.00	13.50	110.00	30.00	53.00	~DIN 376	1059 15.875

Taps for UNJF threads

Article no. **1060**



Cutting data page 966-967

P	M	K	N	S	H
				•	

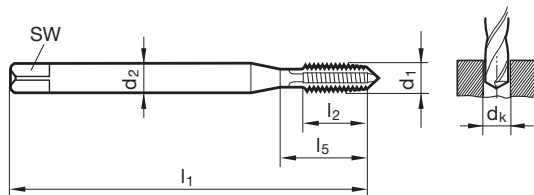

Standard **~DIN 371/~DIN 374**
Article no. **1060**

d1	d2 mm	SW mm	dk mm	l1 mm	l2 mm	l5 mm		Order no.
6 - 40	4.00	3.00	2.95	56.00	11.00	20.00	~DIN 371	1060 3.505
8 - 36	4.50	3.40	3.50	63.00	12.00	21.00	~DIN 371	1060 4.166
10 - 32	6.00	4.90	4.10	70.00	14.00	25.00	~DIN 371	1060 4.826
12 - 28	6.00	4.90	4.60	80.00	16.00	30.00	~DIN 371	1060 5.486
1/4 - 28	7.00	5.50	5.50	80.00	16.00	30.00	~DIN 371	1060 6.350
5/16 - 24	8.00	6.20	6.90	90.00	17.00	35.00	~DIN 371	1060 7.938
3/8 - 24	10.00	8.00	8.50	100.00	18.00	39.00	~DIN 371	1060 9.525
7/16 - 20	8.00	6.20	9.90	100.00	22.00	42.00	~DIN 374	1060 11.113
1/2 - 20	9.00	7.00	11.50	100.00	20.00	40.00	~DIN 374	1060 12.700
5/8 - 18	12.00	9.00	14.50	100.00	22.00	44.00	~DIN 374	1060 15.875



Taps for ISO metric threads

Article no. 809



Cutting data page 959

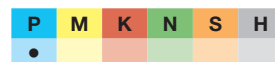

P ≤ 800 N/mm²

Taps for ISO metric threads

Article no. 913



Cutting data page 959

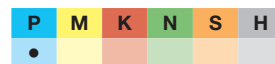

P ≤ 800 N/mm²

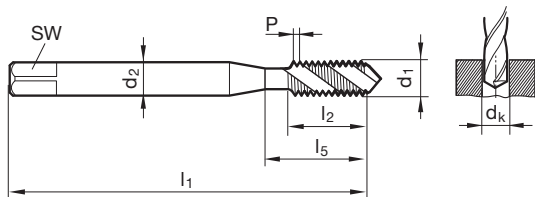

Standard
Article no.

DIN 371	
809	913

d1	P mm	d2 mm	SW mm	dk mm	l1 mm	l2 mm	l5 mm
M2	0.400	2.80	2.10	1.60	45.00	4.50	13.50
M2,5	0.450	2.80	2.10	2.05	50.00	5.00	14.50
M2,6	0.450	2.80	2.10	2.15	50.00	5.00	14.50
M3	0.500	3.50	2.70	2.50	56.00	6.00	18.00
M3,5	0.600	4.00	3.00	2.90	56.00	7.00	20.00
M4	0.700	4.50	3.40	3.30	63.00	7.50	21.00
M5	0.800	6.00	4.90	4.20	70.00	8.50	25.00
M6	1.000	6.00	4.90	5.00	80.00	11.00	30.00
M8	1.250	8.00	6.20	6.80	90.00	14.00	35.00
M10	1.500	10.00	8.00	8.50	100.00	16.00	39.00

Order no.	
809 2.000	913 2.000
809 2.500	913 2.500
809 2.600	913 2.600
809 3.000	913 3.000
809 3.500	913 3.500
809 4.000	913 4.000
809 5.000	913 5.000
809 6.000	913 6.000
809 8.000	913 8.000
809 10.000	913 10.000

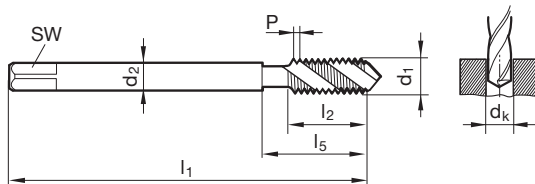

Standard
Article no.

DIN 376	
821	916

d1	P mm	d2 mm	SW mm	dk mm	l1 mm	l2 mm	l5 mm
M3	0.500	2.20	1.80	2.50	56.00	6.00	18.00
M3,5	0.600	2.50	2.10	2.90	56.00	7.00	20.00
M4	0.700	2.80	2.10	3.30	63.00	7.50	21.00
M5	0.800	3.50	2.70	4.20	70.00	8.50	25.00
M6	1.000	4.50	3.40	5.00	80.00	11.00	30.00
M8	1.250	6.00	4.90	6.80	90.00	14.00	35.00
M10	1.500	7.00	5.50	8.50	100.00	16.00	39.00
M12	1.750	9.00	7.00	10.20	110.00	18.50	49.00
M14	2.000	11.00	9.00	12.00	110.00	20.00	53.00
M16	2.000	12.00	9.00	14.00	110.00	20.00	54.00
M20	2.500	16.00	12.00	17.50	140.00	25.00	62.00
M24	3.000	18.00	14.50	21.00	160.00	30.00	73.00

Order no.	
	916 3.000
	916 3.500
	916 4.000
	916 5.000
821 6.000	916 6.000
821 8.000	916 8.000
821 10.000	916 10.000
821 12.000	916 12.000
821 14.000	916 14.000
821 16.000	916 16.000
821 20.000	916 20.000
821 24.000	916 24.000

Taps



Taps for ISO metric threads

Article no. **799**



Cutting data page 959

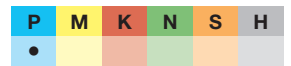

$P \leq 800 \text{ N/mm}^2$

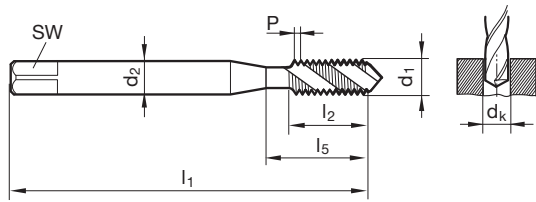

Standard

DIN 371

Article no.

799

Taps

	d1	P mm	d2 mm	SW mm	dk mm	l1 mm	l2 mm	l5 mm	Order no.
	M2	0.400	2.80	2.10	1.60	45.00	4.50	13.50	799 2.000
	M2,5	0.450	2.80	2.10	2.05	50.00	5.00	14.50	799 2.500
	M3	0.500	3.50	2.70	2.50	56.00	6.00	18.00	799 3.000
	M3,5	0.600	4.00	3.00	2.90	56.00	7.00	20.00	799 3.500
	M4	0.700	4.50	3.40	3.30	63.00	7.50	21.00	799 4.000
	M5	0.800	6.00	4.90	4.20	70.00	8.50	25.00	799 5.000
	M6	1.000	6.00	4.90	5.00	80.00	11.00	30.00	799 6.000
	M8	1.250	8.00	6.20	6.80	90.00	14.00	35.00	799 8.000
	M10	1.500	10.00	8.00	8.50	100.00	16.00	39.00	799 10.000



Taps for ISO metric threads

Article no. 810



Cutting data page 959

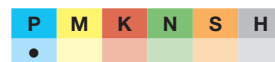

P ≤ 800 N/mm²

Taps for ISO metric threads

Article no. 914



Cutting data page 959

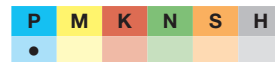

P ≤ 800 N/mm²

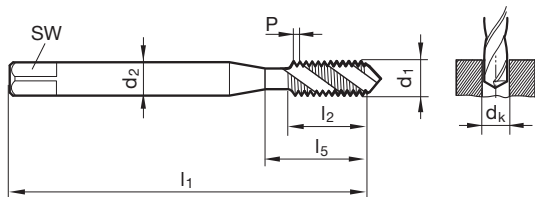

Standard
Article no.

DIN 371	
810	914

Taps

d1	P mm	d2 mm	SW mm	dk mm	l1 mm	l2 mm	l5 mm	Order no.	
M2	0.400	2.80	2.10	1.60	45.00	4.50	13.50	810 2.000	914 2.000
M2,2	0.450	2.80	2.10	1.75	45.00	5.00	14.50	810 2.200	914 2.200
M2,3	0.400	2.80	2.10	1.90	45.00	4.50	14.50	810 2.300	914 2.300
M2,5	0.450	2.80	2.10	2.05	50.00	5.00	14.50	810 2.500	914 2.500
M2,6	0.450	2.80	2.10	2.15	50.00	5.00	14.50	810 2.600	914 2.600
M3	0.500	3.50	2.70	2.50	56.00	6.00	18.00	810 3.000	914 3.000
M3,5	0.600	4.00	3.00	2.90	56.00	7.00	20.00	810 3.500	914 3.500
M4	0.700	4.50	3.40	3.30	63.00	7.50	21.00	810 4.000	914 4.000
M5	0.800	6.00	4.90	4.20	70.00	8.50	25.00	810 5.000	914 5.000
M6	1.000	6.00	4.90	5.00	80.00	11.00	30.00	810 6.000	914 6.000
M8	1.250	8.00	6.20	6.80	90.00	14.00	35.00	810 8.000	914 8.000
M10	1.500	10.00	8.00	8.50	100.00	16.00	39.00	810 10.000	914 10.000

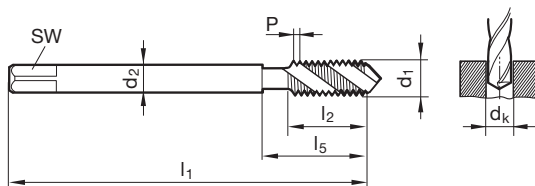

Standard
Article no.

DIN 376	
822	917

d1	P mm	d2 mm	SW mm	dk mm	l1 mm	l2 mm	l5 mm	Order no.	
M3	0.500	2.20	1.80	2.50	56.00	6.00	18.00	822 3.000	917 3.000
M3,5	0.600	2.50	2.10	2.90	56.00	7.00	20.00	822 3.500	917 3.500
M4	0.700	2.80	2.10	3.30	63.00	7.50	21.00	822 4.000	917 4.000
M5	0.800	3.50	2.70	4.20	70.00	8.50	25.00	822 5.000	917 5.000
M6	1.000	4.50	3.40	5.00	80.00	11.00	30.00	822 6.000	917 6.000
M7	1.000	5.50	4.30	6.00	80.00	11.00	30.00	822 7.000	917 7.000
M8	1.250	6.00	4.90	6.80	90.00	14.00	35.00	822 8.000	917 8.000
M10	1.500	7.00	5.50	8.50	100.00	16.00	39.00	822 10.000	917 10.000
M12	1.750	9.00	7.00	10.20	110.00	18.50	49.00	822 12.000	917 12.000
M14	2.000	11.00	9.00	12.00	110.00	20.00	53.00	822 14.000	917 14.000
M16	2.000	12.00	9.00	14.00	110.00	20.00	54.00	822 16.000	917 16.000
M18	2.500	14.00	11.00	15.50	125.00	25.00	62.00	822 18.000	917 18.000
M20	2.500	16.00	12.00	17.50	140.00	25.00	62.00	822 20.000	917 20.000
M22	2.500	18.00	14.50	19.50	140.00	27.00	62.00	822 22.000	917 22.000
M24	3.000	18.00	14.50	21.00	160.00	30.00	73.00	822 24.000	917 24.000
M27	3.000	20.00	16.00	24.00	160.00	30.00	73.00	822 27.000	917 27.000
M30	3.500	22.00	18.00	26.50	180.00	35.00	85.00	822 30.000	917 30.000



Taps for ISO metric threads

Article no. **844**



Cutting data page 959

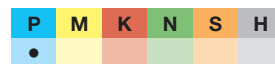

$P \leq 800 \text{ N/mm}^2$

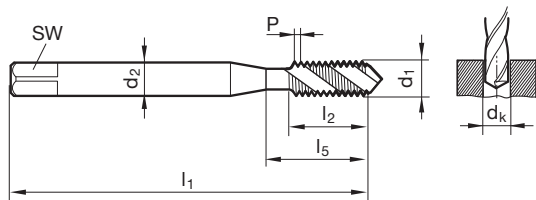

Standard

DIN 371

Article no.

844

d1	d2	SW	dk	l1	l2	l5
mm	mm	mm	mm	mm	mm	mm
M3	3.50	2.70	2.50	56.00	6.00	18.00
M4	4.50	3.40	3.30	63.00	7.50	21.00
M5	6.00	4.90	4.20	70.00	8.50	25.00
M6	6.00	4.90	5.00	80.00	11.00	30.00
M8	8.00	6.20	6.80	90.00	14.00	35.00
M10	10.00	8.00	8.50	100.00	16.00	39.00

Order no.

844 3.000
844 4.000
844 5.000
844 6.000
844 8.000
844 10.000

Taps

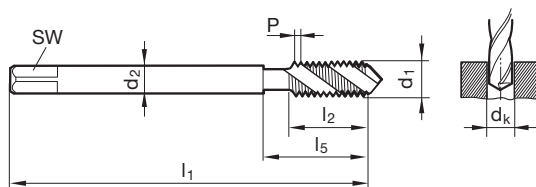

Standard

DIN 376

Article no.

848

d1	d2	SW	dk	l1	l2	l5
mm	mm	mm	mm	mm	mm	mm
M4	2.80	2.10	3.30	63.00	7.50	21.00
M5	3.50	2.70	4.20	70.00	8.50	25.00
M6	4.50	3.40	5.00	80.00	11.00	30.00
M7	5.50	4.30	6.00	80.00	11.00	30.00
M8	6.00	4.90	6.80	90.00	14.00	35.00
M10	7.00	5.50	8.50	100.00	16.00	39.00
M12	9.00	7.00	10.20	110.00	18.50	49.00
M14	11.00	9.00	12.00	110.00	20.00	53.00
M16	12.00	9.00	14.00	110.00	20.00	54.00
M20	16.00	12.00	17.50	140.00	25.00	62.00
M24	18.00	14.50	21.00	160.00	30.00	73.00

Order no.

848 4.000
848 5.000
848 6.000
848 7.000
848 8.000
848 10.000
848 12.000
848 14.000
848 16.000
848 20.000
848 24.000

Taps for ISO metric threads

Article no. 4154

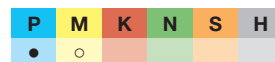
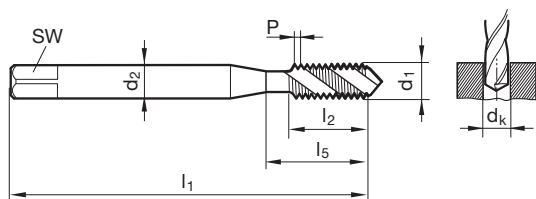

Cutting data page 960

 $P \leq 1000 \text{ N/mm}^2$ 
 Standard **DIN 371/DIN 376**
 Article no. **4154**

d1	P mm	d2 mm	SW mm	dk mm	l1 mm	l2 mm	l5 mm	Standard	Order no.
M3	0.500	3.50	2.70	2.50	56.00	6.00	18.00	DIN 371	4154 3.000
M4	0.700	4.50	3.40	3.30	63.00	7.50	21.00	DIN 371	4154 4.000
M5	0.800	6.00	4.90	4.20	70.00	8.50	25.00	DIN 371	4154 5.000
M6	1.000	6.00	4.90	5.00	80.00	11.00	30.00	DIN 371	4154 6.000
M8	1.250	8.00	6.20	6.80	90.00	14.00	35.00	DIN 371	4154 8.000
M10	1.500	10.00	8.00	8.50	100.00	16.00	39.00	DIN 371	4154 10.000
M12	1.750	9.00	7.00	10.20	110.00	18.50	49.00	DIN 376	4154 12.000
M16	2.000	12.00	9.00	14.00	110.00	20.00	54.00	DIN 376	4154 16.000
M20	2.500	16.00	12.00	17.50	140.00	25.00	62.00	DIN 376	4154 20.000

Taps

Taps for ISO metric threads

Article no. 4155

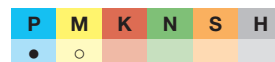
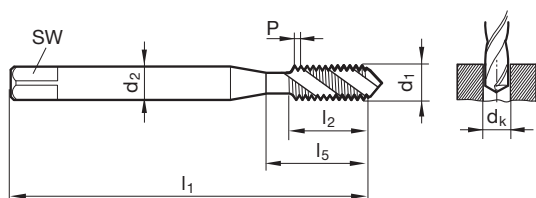

Cutting data page 960

 $P \leq 1000 \text{ N/mm}^2$ 
 Standard **DIN 371/DIN 376**
 Article no. **4155**

d1	P mm	d2 mm	SW mm	dk mm	l1 mm	l2 mm	l5 mm	Standard	Order no.
M3	0.500	3.50	2.70	2.50	56.00	6.00	18.00	DIN 371	4155 3.000
M4	0.700	4.50	3.40	3.30	63.00	7.50	21.00	DIN 371	4155 4.000
M5	0.800	6.00	4.90	4.20	70.00	8.50	25.00	DIN 371	4155 5.000
M6	1.000	6.00	4.90	5.00	80.00	11.00	30.00	DIN 371	4155 6.000
M8	1.250	8.00	6.20	6.80	90.00	14.00	35.00	DIN 371	4155 8.000
M10	1.500	10.00	8.00	8.50	100.00	16.00	39.00	DIN 371	4155 10.000
M12	1.750	9.00	7.00	10.20	110.00	18.50	49.00	DIN 376	4155 12.000
M16	2.000	12.00	9.00	14.00	110.00	20.00	54.00	DIN 376	4155 16.000
M20	2.500	16.00	12.00	17.50	140.00	25.00	62.00	DIN 376	4155 20.000



Taps for ISO metric threads

Article no. **836**



Cutting data page 960

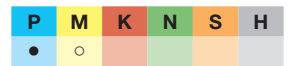

P ≤ 1000 N/mm²

Taps for ISO metric threads

Article no. **2440**



Cutting data page 960

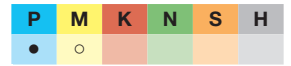

P ≤ 1000 N/mm²

Taps for ISO metric threads

Article no. **1288**



Cutting data page 960

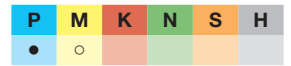

P ≤ 1000 N/mm²

Taps

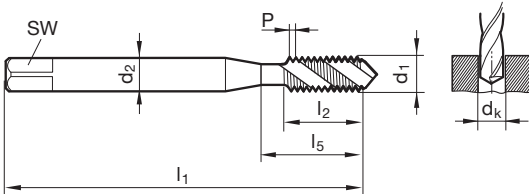

Standard
Article no.

DIN 371

836 2440 1288

Order no.

d1	P mm	d2 mm	SW mm	dk mm	l1 mm	l2 mm	l5 mm	836	2440	1288
M2	0.400	2.80	2.10	1.60	45.00	4.50	13.50	836 2.000	2440 2.000	1288 2.000
M3	0.500	3.50	2.70	2.50	56.00	6.00	18.00	836 3.000	2440 3.000	1288 3.000
M4	0.700	4.50	3.40	3.30	63.00	7.50	21.00	836 4.000	2440 4.000	1288 4.000
M5	0.800	6.00	4.90	4.20	70.00	8.50	25.00	836 5.000	2440 5.000	1288 5.000
M6	1.000	6.00	4.90	5.00	80.00	11.00	30.00	836 6.000	2440 6.000	1288 6.000
M8	1.250	8.00	6.20	6.80	90.00	14.00	35.00	836 8.000	2440 8.000	1288 8.000
M10	1.500	10.00	8.00	8.50	100.00	16.00	39.00	836 10.000	2440 10.000	1288 10.000

Taps for ISO metric threads

Article no. **826**

Cutting data page 960

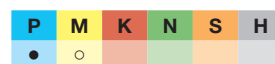
P ≤ 1000 N/mm²

Taps for ISO metric threads

Article no. **2441**

Cutting data page 960

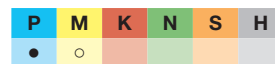
P ≤ 1000 N/mm²

Taps for ISO metric threads

Article no. **1289**

Cutting data page 960

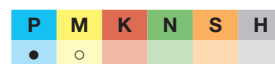
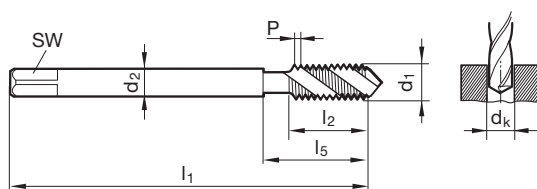
P ≤ 1000 N/mm²

Standard

DIN 376

Article no.

826**2441****1289**

d1	P mm	d2 mm	SW mm	dk mm	l1 mm	l2 mm	l5 mm	Order no.		
								826	2441	1289
M3	0.500	2.20	1.80	2.50	56.00	6.00	18.00	826 3.000	2441 3.000	
M4	0.700	2.80	2.10	3.30	63.00	7.50	21.00	826 4.000	2441 4.000	
M5	0.800	3.50	2.70	4.20	70.00	8.50	25.00	826 5.000	2441 5.000	
M6	1.000	4.50	3.40	5.00	80.00	11.00	30.00	826 6.000	2441 6.000	
M8	1.250	6.00	4.90	6.80	90.00	14.00	35.00	826 8.000	2441 8.000	
M10	1.500	7.00	5.50	8.50	100.00	16.00	39.00	826 10.000	2441 10.000	
M12	1.750	9.00	7.00	10.20	110.00	18.50	49.00	826 12.000	2441 12.000	1289 12.000
M14	2.000	11.00	9.00	12.00	110.00	20.00	53.00	826 14.000	2441 14.000	1289 14.000
M16	2.000	12.00	9.00	14.00	110.00	20.00	54.00	826 16.000	2441 16.000	1289 16.000
M18	2.500	14.00	11.00	15.50	125.00	25.00	62.00	826 18.000	2441 18.000	1289 18.000
M20	2.500	16.00	12.00	17.50	140.00	25.00	62.00	826 20.000	2441 20.000	1289 20.000
M22	2.500	18.00	14.50	19.50	140.00	27.00	62.00	826 22.000	2441 22.000	
M24	3.000	18.00	14.50	21.00	160.00	30.00	73.00	826 24.000	2441 24.000	
M27	3.000	20.00	16.00	24.00	160.00	30.00	73.00	826 27.000	2441 27.000	
M30	3.500	22.00	18.00	26.50	180.00	35.00	85.00	826 30.000	2441 30.000	
M36	4.000	28.00	22.00	32.00	200.00	40.00	102.00	826 36.000	2441 36.000	



Taps for ISO metric threads

Article no. **2994**



Cutting data page 960

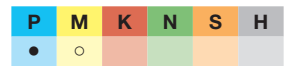

P ≤ 1000 N/mm²

Taps for ISO metric threads

Article no. **2995**



Cutting data page 960

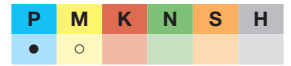

P ≤ 1000 N/mm²

Taps

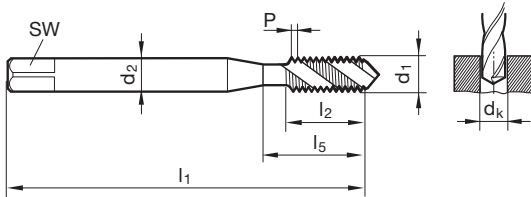

Standard
Article no.

DIN 371	
2994	2995

d1	d2 mm	SW mm	dk mm	l1 mm	l2 mm	l5 mm
M2	2.80	2.10	1.60	45.00	4.50	13.50
M3	3.50	2.70	2.50	56.00	6.00	18.00
M4	4.50	3.40	3.30	63.00	7.50	21.00
M5	6.00	4.90	4.20	70.00	8.50	25.00
M6	6.00	4.90	5.00	80.00	11.00	30.00
M8	8.00	6.20	6.80	90.00	14.00	35.00
M10	10.00	8.00	8.50	100.00	16.00	39.00

Order no.	
2994 2.000	2995 2.000
2994 3.000	2995 3.000
2994 4.000	2995 4.000
2994 5.000	2995 5.000
2994 6.000	2995 6.000
2994 8.000	2995 8.000
2994 10.000	2995 10.000



Taps for ISO metric threads

Article no. 196



bright correction

Cutting data page 960

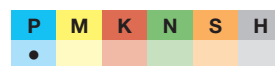
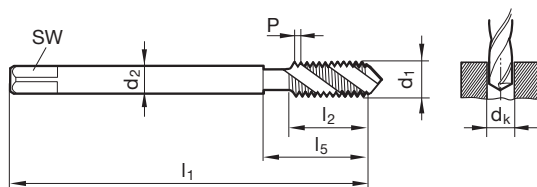
 $P \leq 1000 \text{ N/mm}^2$ 

Standard								DIN 376
Article no.								196
d1	P	d2	SW	dk	l1	l2	l5	Order no.
M5	0.800	3.50	2.70	4.20	70.00	8.50	25.00	196 5.000
M6	1.000	4.50	3.40	5.00	80.00	11.00	30.00	196 6.000
M8	1.250	6.00	4.90	6.80	90.00	14.00	35.00	196 8.000
M10	1.500	7.00	5.50	8.50	100.00	16.00	39.00	196 10.000
M12	1.750	9.00	7.00	10.20	110.00	18.50	49.00	196 12.000
M14	2.000	11.00	9.00	12.00	110.00	20.00	53.00	196 14.000
M16	2.000	12.00	9.00	14.00	110.00	20.00	54.00	196 16.000
M20	2.500	16.00	12.00	17.50	140.00	25.00	62.00	196 20.000
M24	3.000	18.00	14.50	21.00	160.00	30.00	73.00	196 24.000
M30	3.500	22.00	18.00	26.50	180.00	35.00	85.00	196 30.000

Taps

Taps for ISO metric threads

Article no. 4153



long design

Cutting data page 960

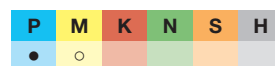
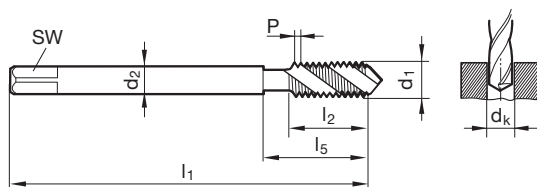
 $P \leq 1000 \text{ N/mm}^2$ 

Standard								Company std.
Article no.								4153
d1	P	d2	SW	dk	l1	l2	l5	Order no.
M3	0.500	3.50	2.70	2.50	112.00	6.00	18.00	4153 3.000
M4	0.700	2.80	2.10	3.30	112.00	7.50	77.00	4153 4.000
M5	0.800	3.50	2.70	4.20	125.00	8.50	85.00	4153 5.000
M6	1.000	4.50	3.40	5.00	125.00	11.00	85.00	4153 6.000
M8	1.250	6.00	4.90	6.80	140.00	14.00	95.00	4153 8.000
M10	1.500	7.00	5.50	8.50	160.00	16.00	115.00	4153 10.000
M12	1.750	9.00	7.00	10.20	180.00	18.50	129.00	4153 12.000
M16	2.000	12.00	9.00	14.00	220.00	20.00	163.00	4153 16.000
M20	2.500	16.00	12.00	17.50	280.00	25.00	217.00	4153 20.000



Taps for ISO metric threads

Article no. **1577**



Cutting data page 961

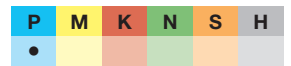

P ≤ 1200 N/mm²

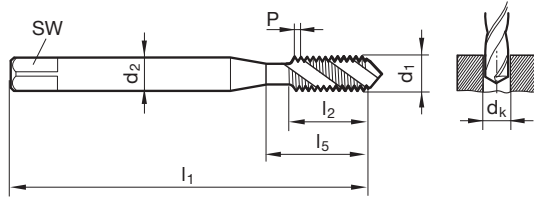

Standard **DIN 371**
Article no. **1577**

d1	d2 mm	SW mm	dk mm	l1 mm	l2 mm	l5 mm	Order no.
M3	3.50	2.70	2.50	56.00	6.00	18.00	1577 3.000
M4	4.50	3.40	3.30	63.00	7.50	21.00	1577 4.000
M5	6.00	4.90	4.20	70.00	8.50	25.00	1577 5.000
M6	6.00	4.90	5.00	80.00	11.00	30.00	1577 6.000
M8	8.00	6.20	6.80	90.00	14.00	35.00	1577 8.000
M10	10.00	8.00	8.50	100.00	16.00	39.00	1577 10.000

Taps

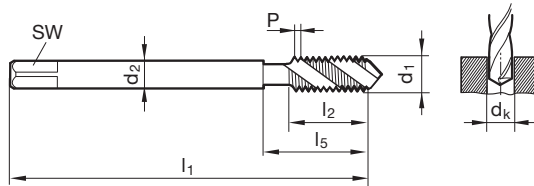

Standard **DIN 376**
Article no. **1578**

d1	d2 mm	SW mm	dk mm	l1 mm	l2 mm	l5 mm	Order no.
M12	9.00	7.00	10.20	110.00	18.50	49.00	1578 12.000
M16	12.00	9.00	14.00	110.00	20.00	54.00	1578 16.000
M20	16.00	12.00	17.50	140.00	25.00	62.00	1578 20.000



Taps for ISO metric threads

Article no. **2850**



Cutting data page 961

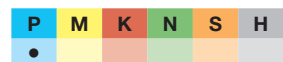

P ≤ 1200 N/mm²

Taps for ISO metric threads

Article no. **361**



Cutting data page 961

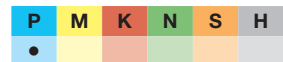

P ≤ 1200 N/mm²

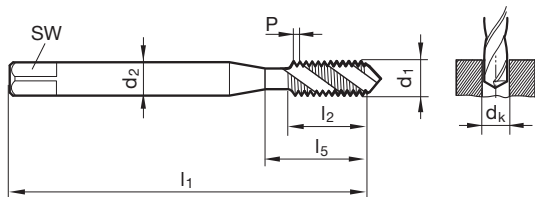

Standard
Article no.

DIN 371	
2850	361

Taps

d1	P mm	d2 mm	SW mm	dk mm	l1 mm	l2 mm	l5 mm
M2	0.400	2.80	2.10	1.60	45.00	4.50	13.50
M2,5	0.450	2.80	2.10	2.05	50.00	5.00	14.50
M3	0.500	3.50	2.70	2.50	56.00	6.00	18.00
M3,5	0.600	4.00	3.00	2.90	56.00	7.00	20.00
M4	0.700	4.50	3.40	3.30	63.00	7.50	21.00
M5	0.800	6.00	4.90	4.20	70.00	8.50	25.00
M6	1.000	6.00	4.90	5.00	80.00	11.00	30.00
M7	1.000	7.00	5.50	6.00	80.00	11.00	30.00
M8	1.250	8.00	6.20	6.80	90.00	14.00	35.00
M10	1.500	10.00	8.00	8.50	100.00	16.00	39.00

Order no.	
2850 2.000	361 2.000
2850 2.500	361 2.500
2850 3.000	361 3.000
2850 3.500	361 3.500
2850 4.000	361 4.000
2850 5.000	361 5.000
2850 6.000	361 6.000
2850 7.000	361 7.000
2850 8.000	361 8.000
2850 10.000	361 10.000

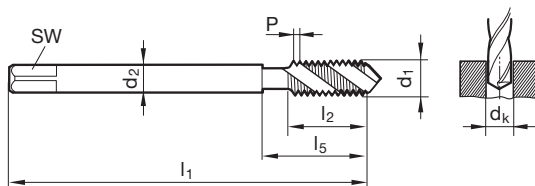

Standard
Article no.

DIN 376	
2851	362

d1	P mm	d2 mm	SW mm	dk mm	l1 mm	l2 mm	l5 mm
M3	0.500	2.20	1.80	2.50	56.00	6.00	18.00
M4	0.700	2.80	2.10	3.30	63.00	7.50	21.00
M5	0.800	3.50	2.70	4.20	70.00	8.50	25.00
M6	1.000	4.50	3.40	5.00	80.00	11.00	30.00
M8	1.250	6.00	4.90	6.80	90.00	14.00	35.00
M10	1.500	7.00	5.50	8.50	100.00	16.00	39.00
M12	1.750	9.00	7.00	10.20	110.00	18.50	49.00
M14	2.000	11.00	9.00	12.00	110.00	20.00	53.00
M16	2.000	12.00	9.00	14.00	110.00	20.00	54.00
M18	2.500	14.00	11.00	15.50	125.00	25.00	62.00
M20	2.500	16.00	12.00	17.50	140.00	25.00	62.00
M24	3.000	18.00	14.50	21.00	160.00	30.00	73.00
M30	3.500	22.00	18.00	26.50	180.00	35.00	85.00

Order no.	
2851 3.000	362 3.000
2851 4.000	362 4.000
2851 5.000	362 5.000
2851 6.000	362 6.000
2851 8.000	362 8.000
2851 10.000	362 10.000
2851 12.000	362 12.000
2851 14.000	362 14.000
2851 16.000	362 16.000
2851 18.000	362 18.000
2851 20.000	362 20.000
2851 24.000	362 24.000
2851 30.000	362 30.000



Taps for ISO metric threads

Article no. **2985**



Cutting data page 961

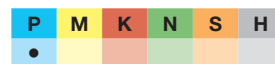

P ≤ 1200 N/mm²

Taps for ISO metric threads

Article no. **2986**



Cutting data page 961

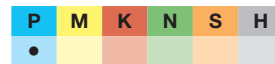

P ≤ 1200 N/mm²

Taps

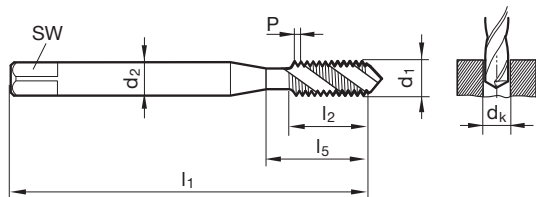

Standard
Article no.

DIN 371	
2985	2986

d1	d2 mm	SW mm	dk mm	l1 mm	l2 mm	l5 mm	Order no.	
M2	2.80	2.10	1.60	45.00	4.50	13.50	2985 2.000	2986 2.000
M2,5	2.80	2.10	2.05	50.00	5.00	14.50	2985 2.500	2986 2.500
M3	3.50	2.70	2.50	56.00	6.00	18.00	2985 3.000	2986 3.000
M4	4.50	3.40	3.30	63.00	7.50	21.00	2985 4.000	2986 4.000
M5	6.00	4.90	4.20	70.00	8.50	25.00	2985 5.000	2986 5.000
M6	6.00	4.90	5.00	80.00	11.00	30.00	2985 6.000	2986 6.000
M8	8.00	6.20	6.80	90.00	14.00	35.00	2985 8.000	2986 8.000
M10	10.00	8.00	8.50	100.00	16.00	39.00	2985 10.000	2986 10.000



Taps with coolant ducts for ISO metric threads

Article no. 778



Cutting data page 961

P	M	K	N	S	H
•		•	○		

P ≤ 1200 N/mm²

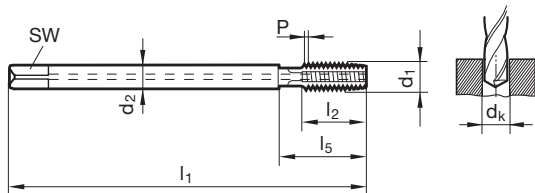

								Standard	DIN 376
								Article no.	778
d1	P	d2	SW	dk	l1	l2	l5	Order no.	
M16	2.000	12.00	9.00	14.00	110.00	26.00	54.00	778 16.000	
M20	2.500	16.00	12.00	17.50	140.00	32.00	62.00	778 20.000	
M24	3.000	18.00	14.50	21.00	160.00	36.00	73.00	778 24.000	
M27	3.000	20.00	16.00	24.00	160.00	36.00	73.00	778 27.000	
M30	3.500	22.00	18.00	26.50	180.00	40.00	85.00	778 30.000	
M33	3.500	25.00	20.00	29.50	180.00	40.00	91.00	778 33.000	
M36	4.000	28.00	22.00	32.00	200.00	50.00	102.00	778 36.000	
M39	4.000	32.00	24.00	35.00	200.00	50.00	107.00	778 39.000	

Taps

Taps with coolant ducts for ISO metric threads

Article no. 779



long design

Cutting data page 961

P	M	K	N	S	H
•		•	○		

P ≤ 1200 N/mm²

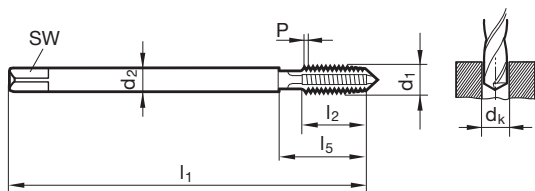

								Standard	~DIN 376
								Article no.	779
d1	P	d2	SW	dk	l1	l2	l5	Order no.	
M16	2.000	12.00	9.00	14.00	160.00	26.00	100.00	779 16.000	
M20	2.500	16.00	12.00	17.50	180.00	32.00	120.00	779 20.000	
M24	3.000	18.00	14.50	21.00	200.00	36.00	120.00	779 24.000	
M27	3.000	20.00	16.00	24.00	225.00	36.00	145.00	779 27.000	
M30	3.500	22.00	18.00	26.50	250.00	40.00	160.00	779 30.000	
M33	3.500	25.00	20.00	29.50	275.00	40.00	170.00	779 33.000	
M36	4.000	28.00	22.00	32.00	300.00	50.00	180.00	779 36.000	
M39	4.000	32.00	24.00	35.00	325.00	50.00	210.00	779 39.000	



Taps with coolant ducts for ISO metric threads

Article no. **302**



Cutting data page 961



P ≤ 1200 N/mm²

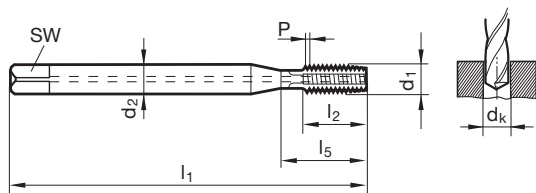

Standard **DIN 371**
Article no. **302**

d1	d2 mm	SW mm	dk mm	l1 mm	l2 mm	l5 mm	Order no.
M5	6.00	4.90	4.20	70.00	14.00	25.00	302 5.000
M6	6.00	4.90	5.00	80.00	16.00	30.00	302 6.000
M8	8.00	6.20	6.80	90.00	17.00	35.00	302 8.000
M10	10.00	8.00	8.50	100.00	20.00	39.00	302 10.000

Taps

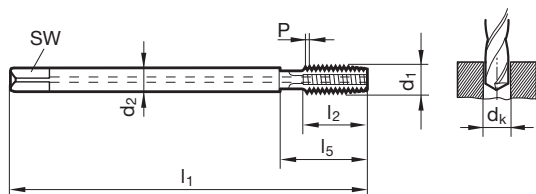

Standard **DIN 376**
Article no. **297**

d1	d2 mm	SW mm	dk mm	l1 mm	l2 mm	l5 mm	Order no.
M10	7.00	5.50	8.50	100.00	20.00	39.00	297 10.000
M12	9.00	7.00	10.20	110.00	24.00	49.00	297 12.000
M14	11.00	9.00	12.00	110.00	26.00	53.00	297 14.000



Taps with coolant ducts for ISO metric threads

Article no. 1091



Cutting data page 961



P	M	K	N	S	H
•		•	○		

P ≤ 1200 N/mm²

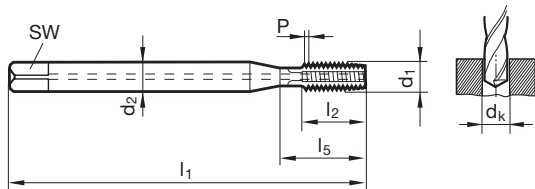

								Standard	DIN 371
								Article no.	1091
d1	P	d2	SW	dk	l1	l2	l5	Order no.	
M5	0.800	6.00	4.90	4.20	70.00	14.00	25.00	1091 5.000	
M6	1.000	6.00	4.90	5.00	80.00	16.00	30.00	1091 6.000	
M8	1.250	8.00	6.20	6.80	90.00	17.00	35.00	1091 8.000	
M10	1.500	10.00	8.00	8.50	100.00	20.00	39.00	1091 10.000	

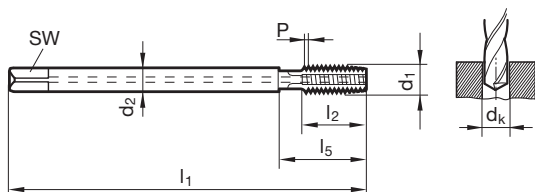

								Standard	DIN 376
								Article no.	4165
d1	P	d2	SW	dk	l1	l2	l5	Order no.	
M10	1.500	7.00	5.50	8.50	100.00	20.00	39.00	4165 10.000	
M12	1.750	9.00	7.00	10.20	110.00	24.00	49.00	4165 12.000	
M16	2.000	12.00	9.00	14.00	110.00	26.00	54.00	4165 16.000	
M20	2.500	16.00	12.00	17.50	140.00	32.00	62.00	4165 20.000	

Taps



Taps with coolant ducts for ISO metric threads

Article no. **1188**



Cutting data page 961



bright flute

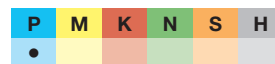

$P \leq 1200 \text{ N/mm}^2$

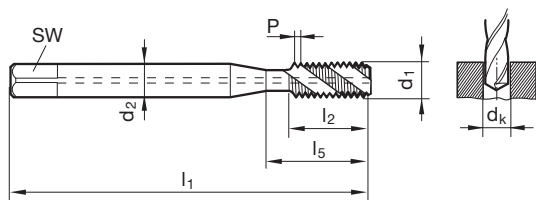

Standard

DIN 371

Article no.

1188

d1	d2 mm	SW mm	dk mm	l1 mm	l2 mm	l5 mm
M6	6.00	4.90	5.00	80.00	11.00	30.00
M8	8.00	6.20	6.80	90.00	14.00	35.00
M10	10.00	8.00	8.50	100.00	16.00	39.00

Order no.

1188 6.000

1188 8.000

1188 10.000

Taps

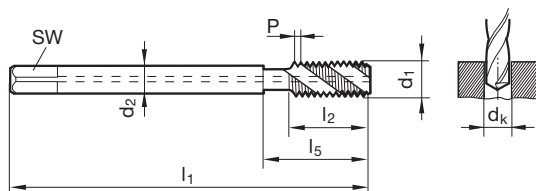

Standard

DIN 376

Article no.

1194

d1	d2 mm	SW mm	dk mm	l1 mm	l2 mm	l5 mm
M12	9.00	7.00	10.20	110.00	18.50	49.00
M14	11.00	9.00	12.00	110.00	20.00	53.00
M16	12.00	9.00	14.00	110.00	20.00	54.00
M20	16.00	12.00	17.50	140.00	25.00	62.00
M22	18.00	14.50	19.50	140.00	27.00	62.00
M24	18.00	14.50	21.00	160.00	30.00	73.00

Order no.

1194 12.000

1194 14.000

1194 16.000

1194 20.000

1194 22.000

1194 24.000



Taps for ISO metric threads

Article no. 843



Cutting data page 964

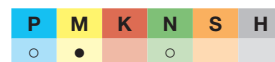

P ≤ 1000 N/mm²

Taps for ISO metric threads

Article no. 2896



Cutting data page 964

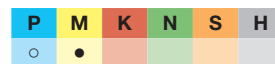

P ≤ 1000 N/mm²

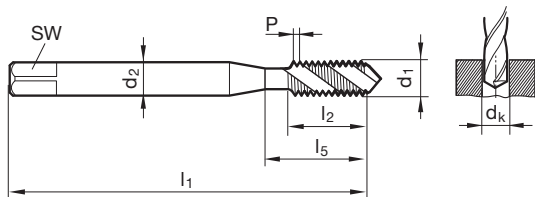

Standard
Article no.

DIN 371	
843	2896

Taps

d1	P mm	d2 mm	SW mm	dk mm	l1 mm	l2 mm	l5 mm
M2	0.400	2.80	2.10	1.60	45.00	4.50	13.50
M2,5	0.450	2.80	2.10	2.05	50.00	5.00	14.50
M3	0.500	3.50	2.70	2.50	56.00	6.00	18.00
M3,5	0.600	4.00	3.00	2.90	56.00	7.00	20.00
M4	0.700	4.50	3.40	3.30	63.00	7.50	21.00
M5	0.800	6.00	4.90	4.20	70.00	8.50	25.00
M6	1.000	6.00	4.90	5.00	80.00	11.00	30.00
M8	1.250	8.00	6.20	6.80	90.00	14.00	35.00
M10	1.500	10.00	8.00	8.50	100.00	16.00	39.00

Order no.	
843 2.000	2896 2.000
843 2.500	2896 2.500
843 3.000	2896 3.000
843 3.500	2896 3.500
843 4.000	2896 4.000
843 5.000	2896 5.000
843 6.000	2896 6.000
843 8.000	2896 8.000
843 10.000	2896 10.000

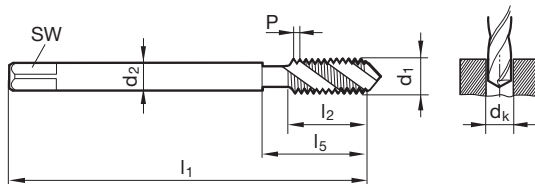

Standard
Article no.

DIN 376	
785	2895

d1	P mm	d2 mm	SW mm	dk mm	l1 mm	l2 mm	l5 mm
M12	1.750	9.00	7.00	10.20	110.00	18.50	49.00
M16	2.000	12.00	9.00	14.00	110.00	20.00	54.00
M20	2.500	16.00	12.00	17.50	140.00	25.00	62.00
M22	2.500	18.00	14.50	19.50	140.00	27.00	62.00
M24	3.000	18.00	14.50	21.00	160.00	30.00	73.00

Order no.	
785 12.000	2895 12.000
785 16.000	2895 16.000
785 20.000	2895 20.000
785 22.000	2895 22.000
785 24.000	2895 24.000



Taps for ISO metric threads

Article no. **814**



Cutting data page 964

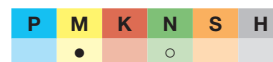

Taps for ISO metric threads

Article no. **2862**



Cutting data page 964

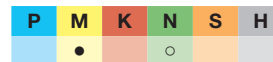

Taps

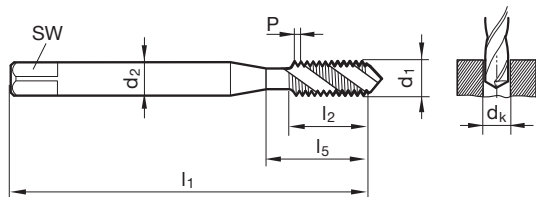

Standard
Article no.

DIN 371	
814	2862

d1	P	d2	SW	dk	l1	l2	l5
mm	mm	mm	mm	mm	mm	mm	mm
M3	0.500	3.50	2.70	2.50	56.00	6.00	18.00
M4	0.700	4.50	3.40	3.30	63.00	7.50	21.00
M5	0.800	6.00	4.90	4.20	70.00	8.50	25.00
M6	1.000	6.00	4.90	5.00	80.00	11.00	30.00
M8	1.250	8.00	6.20	6.80	90.00	14.00	35.00
M10	1.500	10.00	8.00	8.50	100.00	16.00	39.00

Order no.	
814 3.000	2862 3.000
814 4.000	2862 4.000
814 5.000	2862 5.000
814 6.000	2862 6.000
814 8.000	2862 8.000
814 10.000	2862 10.000

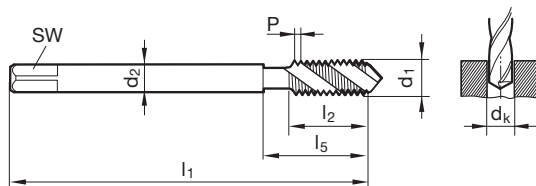

Standard
Article no.

DIN 376	
825	2863

d1	P	d2	SW	dk	l1	l2	l5
mm	mm	mm	mm	mm	mm	mm	mm
M12	1.750	9.00	7.00	10.20	110.00	18.50	49.00
M14	2.000	11.00	9.00	12.00	110.00	20.00	53.00
M16	2.000	12.00	9.00	14.00	110.00	20.00	54.00
M18	2.500	14.00	11.00	15.50	125.00	25.00	62.00
M20	2.500	16.00	12.00	17.50	140.00	25.00	62.00
M22	2.500	18.00	14.50	19.50	140.00	27.00	62.00
M24	3.000	18.00	14.50	21.00	160.00	30.00	73.00
M30	3.500	22.00	18.00	26.50	180.00	35.00	85.00

Order no.	
825 12.000	2863 12.000
825 14.000	2863 14.000
825 16.000	2863 16.000
825 18.000	2863 18.000
825 20.000	2863 20.000
825 22.000	2863 22.000
825 24.000	2863 24.000
825 30.000	2863 30.000



Taps for ISO metric threads

Article no. 761



Cutting data page 964



Synchronous tap

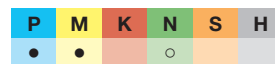

P ≤ 1000 N/mm²

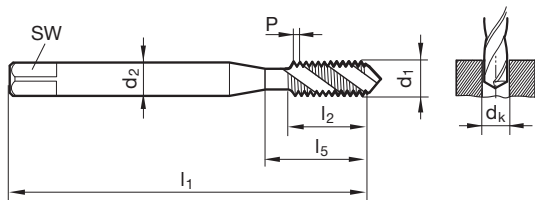

Standard	DIN 371
Article no.	761

d1	d2 mm	SW mm	dk mm	l1 mm	l2 mm	l5 mm
M3	3.50	2.70	2.50	56.00	2.50	18.00
M4	4.50	3.40	3.30	63.00	3.50	21.00
M5	6.00	4.90	4.20	70.00	4.00	25.00
M6	6.00	4.90	5.00	80.00	5.00	30.00
M8	8.00	6.20	6.80	90.00	6.30	35.00
M10	10.00	8.00	8.50	100.00	7.50	39.00

Order no.
761 3.000
761 4.000
761 5.000
761 6.000
761 8.000
761 10.000

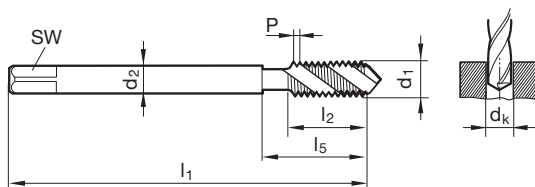

Standard	DIN 376
Article no.	763

d1	d2 mm	SW mm	dk mm	l1 mm	l2 mm	l5 mm
M12	9.00	7.00	10.20	110.00	8.80	49.00
M14	11.00	9.00	12.00	110.00	10.00	53.00
M16	12.00	9.00	14.00	110.00	10.00	54.00
M20	16.00	12.00	17.50	140.00	12.50	62.00

Order no.
763 12.000
763 14.000
763 16.000
763 20.000

Taps



Taps with coolant ducts for ISO metric threads

Article no. **1139**



Cutting data page 964



Synchronous tap

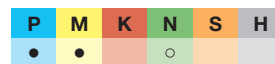

P ≤ 1000 N/mm²

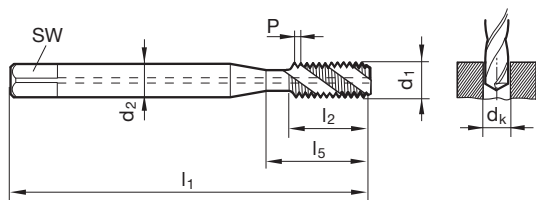

Standard **DIN 371**
Article no. **1139**

d1	d2 mm	SW mm	dk mm	l1 mm	l2 mm	l5 mm	Order no.
M5	6.00	4.90	4.20	70.00	4.00	25.00	1139 5.000
M6	6.00	4.90	5.00	80.00	5.00	30.00	1139 6.000
M8	8.00	6.20	6.80	90.00	6.30	35.00	1139 8.000
M10	10.00	8.00	8.50	100.00	7.50	39.00	1139 10.000

Taps

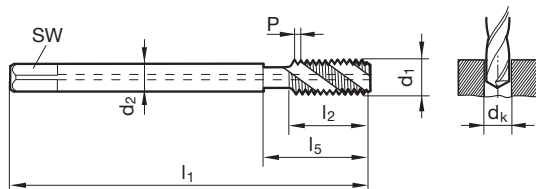

Standard **DIN 376**
Article no. **1142**

d1	d2 mm	SW mm	dk mm	l1 mm	l2 mm	l5 mm	Order no.
M12	9.00	7.00	10.20	110.00	8.80	49.00	1142 12.000
M14	11.00	9.00	12.00	110.00	10.00	53.00	1142 14.000
M16	12.00	9.00	14.00	110.00	10.00	54.00	1142 16.000
M20	16.00	12.00	17.50	140.00	12.50	62.00	1142 20.000



Taps with coolant ducts for ISO metric threads

Article no. 1890



Cutting data page 962

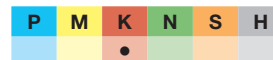

Taps with coolant ducts for ISO metric threads

Article no. 318



Cutting data page 962

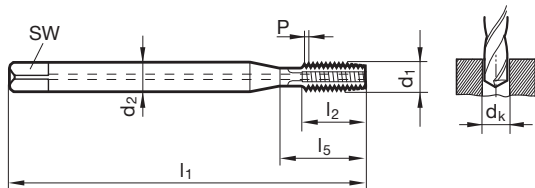
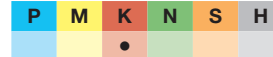

Standard
Article no.

DIN 371	
1890	318

d1	P mm	d2 mm	SW mm	dk mm	l1 mm	l2 mm	l5 mm
M5	0.800	6.00	4.90	4.20	70.00	14.00	25.00
M6	1.000	6.00	4.90	5.00	80.00	16.00	30.00
M8	1.250	8.00	6.20	6.80	90.00	17.00	35.00
M10	1.500	10.00	8.00	8.50	100.00	20.00	39.00

Order no.	
1890 5.000	318 5.000
1890 6.000	318 6.000
1890 8.000	318 8.000
1890 10.000	318 10.000

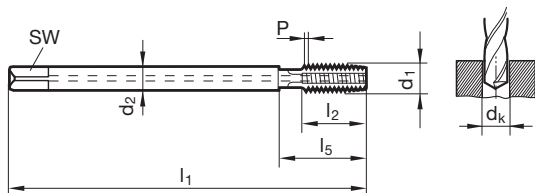

Standard
Article no.

DIN 376	
1897	319

d1	P mm	d2 mm	SW mm	dk mm	l1 mm	l2 mm	l5 mm
M12	1.750	9.00	7.00	10.20	110.00	24.00	49.00
M14	2.000	11.00	9.00	12.00	110.00	26.00	53.00
M16	2.000	12.00	9.00	14.00	110.00	26.00	54.00
M18	2.500	14.00	11.00	15.50	125.00	30.00	62.00
M20	2.500	16.00	12.00	17.50	140.00	32.00	62.00

Order no.	
1897 12.000	319 12.000
1897 14.000	319 14.000
1897 16.000	319 16.000
1897 18.000	319 18.000
1897 20.000	319 20.000

Taps



Taps with coolant ducts for ISO metric threads

Article no. **969**



Cutting data page 962-963



N ≥ 7% Si

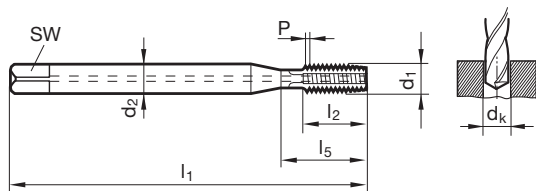

Standard **DIN 371**
Article no. **969**

d1	P mm	d2 mm	SW mm	dk mm	l1 mm	l2 mm	l5 mm	Order no.
M3	0.500	3.50	2.70	2.50	56.00	8.00	18.00	969 3.000
M4	0.700	4.50	3.40	3.30	63.00	10.00	21.00	969 4.000
M5	0.800	6.00	4.90	4.20	70.00	10.00	25.00	969 5.000
M6	1.000	6.00	4.90	5.00	80.00	12.00	30.00	969 6.000
M8	1.250	8.00	6.20	6.80	90.00	16.00	35.00	969 8.000
M10	1.500	10.00	8.00	8.50	100.00	18.00	39.00	969 10.000

Taps

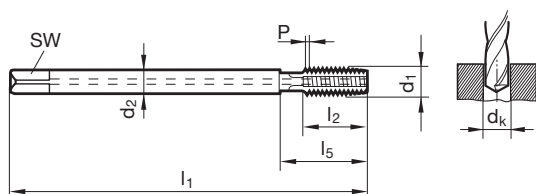

Standard **DIN 376**
Article no. **1883**

d1	P mm	d2 mm	SW mm	dk mm	l1 mm	l2 mm	l5 mm	Order no.
M12	1.750	9.00	7.00	10.20	110.00	18.00	49.00	1883 12.000
M14	2.000	11.00	9.00	12.00	110.00	20.00	53.00	1883 14.000
M16	2.000	12.00	9.00	14.00	110.00	20.00	54.00	1883 16.000
M18	2.500	14.00	11.00	15.50	125.00	25.00	62.00	1883 18.000
M20	2.500	16.00	12.00	17.50	140.00	25.00	62.00	1883 20.000



Taps with coolant ducts for ISO metric threads

Article no. 2506



Cutting data page 962

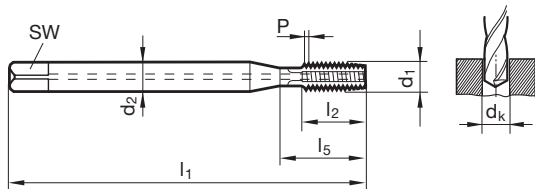
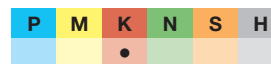

d1	P	d2	SW	dk	l1	l2	l5
mm	mm	mm	mm	mm	mm	mm	mm
M5	0.800	6.00	4.90	4.20	70.00	10.00	25.00
M6	1.000	6.00	4.90	5.00	80.00	12.00	30.00
M8	1.250	8.00	6.20	6.80	90.00	16.00	35.00
M10	1.500	10.00	8.00	8.50	100.00	18.00	39.00

Standard	DIN 371
Article no.	2506
Order no.	2506 5.000 2506 6.000 2506 8.000 2506 10.000

Taps with coolant ducts for ISO metric threads

Article no. 1008



Cutting data page 962-963

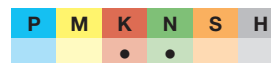

N ≥ 7% Si

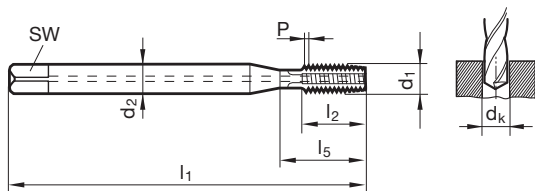

d1	P	d2	SW	dk	l1	l2	l5
mm	mm	mm	mm	mm	mm	mm	mm
M3	0.500	3.50	2.70	2.50	56.00	8.00	18.00
M4	0.700	4.50	3.40	3.30	63.00	10.00	21.00
M5	0.800	6.00	4.90	4.20	70.00	10.00	25.00
M6	1.000	6.00	4.90	5.00	80.00	12.00	30.00
M8	1.250	8.00	6.20	6.80	90.00	16.00	35.00
M10	1.500	10.00	8.00	8.50	100.00	18.00	39.00

Standard	DIN 371
Article no.	1008
Order no.	1008 3.000 1008 4.000 1008 5.000 1008 6.000 1008 8.000 1008 10.000

Taps



Taps for ISO metric threads

Article no. **800**



Cutting data page 963

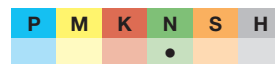

N = MS

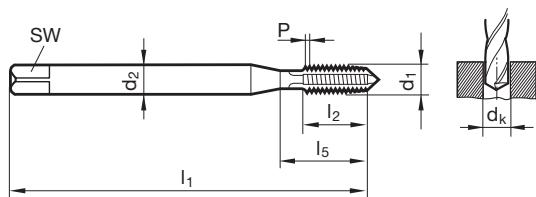

Standard **DIN 371**
Article no. **800**

d1	P mm	d2 mm	SW mm	dk mm	l1 mm	l2 mm	l5 mm	Order no.
M3	0.500	3.50	2.70	2.50	56.00	10.00	18.00	800 3.000
M4	0.700	4.50	3.40	3.30	63.00	12.00	21.00	800 4.000
M5	0.800	6.00	4.90	4.20	70.00	14.00	25.00	800 5.000
M6	1.000	6.00	4.90	5.00	80.00	16.00	30.00	800 6.000
M8	1.250	8.00	6.20	6.80	90.00	17.00	35.00	800 8.000
M10	1.500	10.00	8.00	8.50	100.00	20.00	39.00	800 10.000

Taps

Taps for ISO metric threads

Article no. **1084**



Cutting data page 963

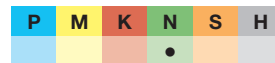

N = MS

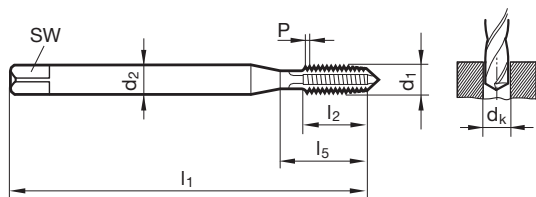

Standard **DIN 371**
Article no. **1084**

d1	P mm	d2 mm	SW mm	dk mm	l1 mm	l2 mm	l5 mm	Order no.
M3	0.500	3.50	2.70	2.50	56.00	10.00	18.00	1084 3.000
M4	0.700	4.50	3.40	3.30	63.00	12.00	21.00	1084 4.000
M5	0.800	6.00	4.90	4.20	70.00	14.00	25.00	1084 5.000
M6	1.000	6.00	4.90	5.00	80.00	16.00	30.00	1084 6.000
M8	1.250	8.00	6.20	6.80	90.00	17.00	35.00	1084 8.000
M10	1.500	10.00	8.00	8.50	100.00	20.00	39.00	1084 10.000



Taps for ISO metric threads

Article no. 812



Cutting data page 963

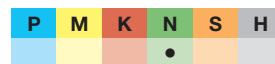

N ≤ 7% Si

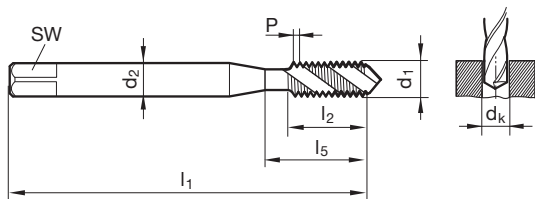

								Standard	DIN 371
								Article no.	812
d1	P	d2	SW	dk	l1	l2	l5	Order no.	
M1,6	0.350	2.50	2.10	1.25	40.00	6.40	6.40	812 1.600	
M2	0.400	2.80	2.10	1.60	45.00	4.50	13.50	812 2.000	
M2,2	0.450	2.80	2.10	1.75	45.00	5.00	14.50	812 2.200	
M2,5	0.450	2.80	2.10	2.05	50.00	5.00	14.50	812 2.500	
M2,6	0.450	2.80	2.10	2.15	50.00	5.00	14.50	812 2.600	
M3	0.500	3.50	2.70	2.50	56.00	6.00	18.00	812 3.000	
M3,5	0.600	4.00	3.00	2.90	56.00	7.00	20.00	812 3.500	
M4	0.700	4.50	3.40	3.30	63.00	7.50	21.00	812 4.000	
M5	0.800	6.00	4.90	4.20	70.00	8.50	25.00	812 5.000	
M6	1.000	6.00	4.90	5.00	80.00	11.00	30.00	812 6.000	
M8	1.250	8.00	6.20	6.80	90.00	14.00	35.00	812 8.000	
M10	1.500	10.00	8.00	8.50	100.00	16.00	39.00	812 10.000	

Taps

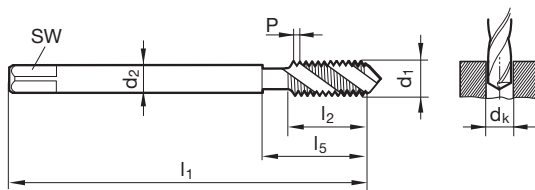

								Standard	DIN 376
								Article no.	824
d1	P	d2	SW	dk	l1	l2	l5	Order no.	
M3	0.500	2.20	1.80	2.50	56.00	6.00	18.00	824 3.000	
M4	0.700	2.80	2.10	3.30	63.00	7.50	21.00	824 4.000	
M5	0.800	3.50	2.70	4.20	70.00	8.50	25.00	824 5.000	
M6	1.000	4.50	3.40	5.00	80.00	11.00	30.00	824 6.000	
M8	1.250	6.00	4.90	6.80	90.00	14.00	35.00	824 8.000	
M10	1.500	7.00	5.50	8.50	100.00	16.00	39.00	824 10.000	
M12	1.750	9.00	7.00	10.20	110.00	18.50	49.00	824 12.000	
M14	2.000	11.00	9.00	12.00	110.00	20.00	53.00	824 14.000	
M16	2.000	12.00	9.00	14.00	110.00	20.00	54.00	824 16.000	
M18	2.500	14.00	11.00	15.50	125.00	25.00	62.00	824 18.000	
M20	2.500	16.00	12.00	17.50	140.00	25.00	62.00	824 20.000	



Taps for ISO metric threads

Article no. **4670**



Cutting data page 963

P	M	K	N	S	H
			●	○	

N ≤ 7% Si

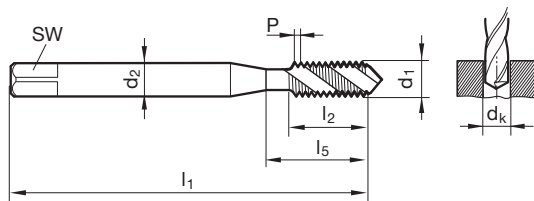

Standard	DIN 371/DIN 376
Article no.	4670

Taps

d1	P mm	d2 mm	SW mm	dk mm	l1 mm	l2 mm	l5 mm	Standard	Order no.
M2	0.400	2.80	2.10	1.60	45.00	4.50	13.50	DIN 371	4670 2.000
M2,5	0.450	2.80	2.10	2.05	50.00	5.00	14.50	DIN 371	4670 2.500
M3	0.500	3.50	2.70	2.50	56.00	6.00	18.00	DIN 371	4670 3.000
M4	0.700	4.50	3.40	3.30	63.00	7.50	21.00	DIN 371	4670 4.000
M5	0.800	6.00	4.90	4.20	70.00	8.50	25.00	DIN 371	4670 5.000
M6	1.000	6.00	4.90	5.00	80.00	11.00	30.00	DIN 371	4670 6.000
M8	1.250	8.00	6.20	6.80	90.00	14.00	35.00	DIN 371	4670 8.000
M10	1.500	10.00	8.00	8.50	100.00	16.00	39.00	DIN 371	4670 10.000
M12	1.750	9.00	7.00	10.20	110.00	18.50	49.00	DIN 376	4670 12.000
M14	2.000	11.00	9.00	12.00	110.00	20.00	53.00	DIN 376	4670 14.000
M16	2.000	12.00	9.00	14.00	110.00	20.00	54.00	DIN 376	4670 16.000

Taps for ISO metric threads

Article no. **4671**



with internal cooling ≥ M5

Cutting data page 963

P	M	K	N	S	H
			●	○	

N ≤ 7% Si

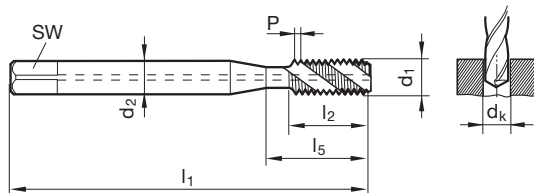

Standard	DIN 371/DIN 376
Article no.	4671

d1	P mm	d2 mm	SW mm	dk mm	l1 mm	l2 mm	l5 mm	Standard	Order no.
M2	0.400	2.80	2.10	1.60	45.00	4.50	13.50	DIN 371	4671 2.000
M2,5	0.450	2.80	2.10	2.05	50.00	5.00	14.50	DIN 371	4671 2.500
M3	0.500	3.50	2.70	2.50	56.00	6.00	18.00	DIN 371	4671 3.000
M4	0.700	4.50	3.40	3.30	63.00	7.50	21.00	DIN 371	4671 4.000
M5	0.800	6.00	4.90	4.20	70.00	8.50	25.00	DIN 371	4671 5.000
M6	1.000	6.00	4.90	5.00	80.00	11.00	30.00	DIN 371	4671 6.000
M8	1.250	8.00	6.20	6.80	90.00	14.00	35.00	DIN 371	4671 8.000
M10	1.500	10.00	8.00	8.50	100.00	16.00	39.00	DIN 371	4671 10.000
M12	1.750	9.00	7.00	10.20	110.00	18.50	49.00	DIN 376	4671 12.000
M14	2.000	11.00	9.00	12.00	110.00	20.00	53.00	DIN 376	4671 14.000
M16	2.000	12.00	9.00	14.00	110.00	20.00	54.00	DIN 376	4671 16.000



Taps with coolant ducts for ISO metric threads

Article no. 971



Cutting data page 963



with internal cooling ≥ M5

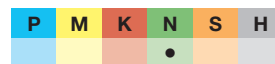

N ≥ 7% Si

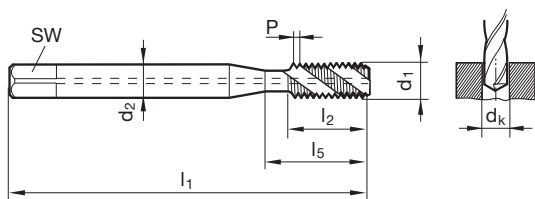

d1	P mm	d2 mm	SW mm	dk mm	l1 mm	l2 mm	l5 mm
M3	0.500	3.50	2.70	2.50	56.00	8.00	18.00
M4	0.700	4.50	3.40	3.30	63.00	10.00	21.00
M5	0.800	6.00	4.90	4.20	70.00	10.00	25.00
M6	1.000	6.00	4.90	5.00	80.00	12.00	30.00
M8	1.250	8.00	6.20	6.80	90.00	16.00	35.00
M10	1.500	10.00	8.00	8.50	100.00	18.00	39.00

Standard **DIN 371**
Article no. **971**

Order no.
971 3.000
971 4.000
971 5.000
971 6.000
971 8.000
971 10.000

Taps for ISO metric threads

Article no. 4673



Cutting data page 963



with internal cooling ≥ M5

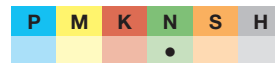

N ≥ 7% Si

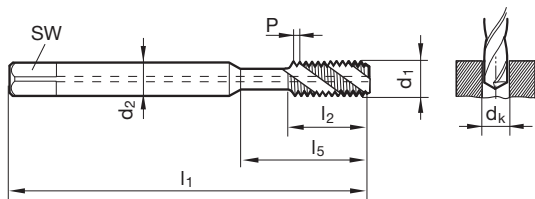

d1	P mm	d2 mm	SW mm	dk mm	l1 mm	l2 mm	l5 mm
M3	0.500	3.50	2.70	2.50	56.00	8.00	18.00
M4	0.700	4.50	3.40	3.30	63.00	10.00	21.00
M5	0.800	6.00	4.90	4.20	70.00	10.00	25.00
M6	1.000	6.00	4.90	5.00	80.00	12.00	30.00
M8	1.250	8.00	6.20	6.80	90.00	16.00	35.00
M10	1.500	10.00	8.00	8.50	100.00	18.00	39.00
M12	1.750	9.00	7.00	10.20	110.00	18.00	49.00
M14	2.000	11.00	9.00	12.00	110.00	20.00	53.00
M16	2.000	12.00	9.00	14.00	110.00	20.00	54.00

Standard **DIN 371/DIN 376**
Article no. **4673**

Order no.
4673 3.000
4673 4.000
4673 5.000
4673 6.000
4673 8.000
4673 10.000
4673 12.000
4673 14.000
4673 16.000

Taps



Blind holes

Taps for ISO metric threads

Article no. **4674**



Cutting data page 963



with internal cooling \geq M5

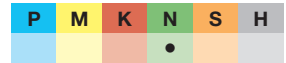

N \geq 7% Si

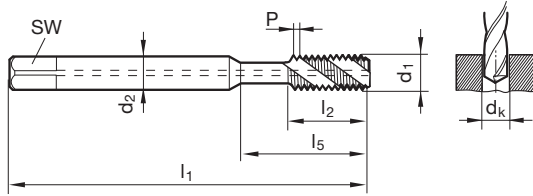

Standard **DIN 371/DIN 376**
Article no. **4674**

d1	P mm	d2 mm	SW mm	dk mm	l1 mm	l2 mm	l5 mm	Standard	Order no.
M3	0.500	3.50	2.70	2.50	56.00	8.00	18.00	DIN 371	4674 3.000
M4	0.700	4.50	3.40	3.30	63.00	10.00	21.00	DIN 371	4674 4.000
M5	0.800	6.00	4.90	4.20	70.00	10.00	25.00	DIN 371	4674 5.000
M6	1.000	6.00	4.90	5.00	80.00	12.00	30.00	DIN 371	4674 6.000
M8	1.250	8.00	6.20	6.80	90.00	16.00	35.00	DIN 371	4674 8.000
M10	1.500	10.00	8.00	8.50	100.00	18.00	39.00	DIN 371	4674 10.000
M12	1.750	9.00	7.00	10.20	110.00	18.00	49.00	DIN 376	4674 12.000
M14	2.000	11.00	9.00	12.00	110.00	20.00	53.00	DIN 376	4674 14.000
M16	2.000	12.00	9.00	14.00	110.00	20.00	54.00	DIN 376	4674 16.000

Taps

Taps for ISO metric threads

Article no. **2909**



Cutting data page 966-967

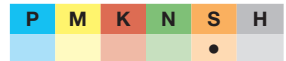

S = Ti

Taps for ISO metric threads

Article no. **2920**



Cutting data page 966-967

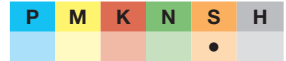

S = Ni

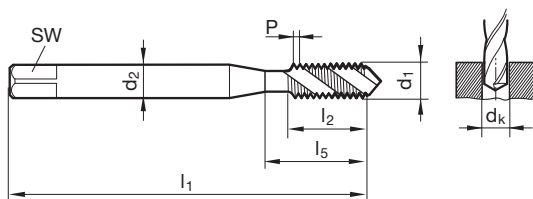

Standard **DIN 371/DIN 376**
Article no. **2909** | **2920**

d1	P mm	d2 mm	SW mm	dk mm	l1 mm	l2 mm	l5 mm	Standard	Order no.
M3	0.500	3.50	2.70	2.50	56.00	10.00	18.00	DIN 371	2909 3.000 2920 3.000
M4	0.700	4.50	3.40	3.30	63.00	12.00	21.00	DIN 371	2909 4.000 2920 4.000
M5	0.800	6.00	4.90	4.20	70.00	14.00	25.00	DIN 371	2909 5.000 2920 5.000
M6	1.000	6.00	4.90	5.00	80.00	16.00	30.00	DIN 371	2909 6.000 2920 6.000
M8	1.250	8.00	6.20	6.80	90.00	17.00	35.00	DIN 371	2909 8.000 2920 8.000
M10	1.500	10.00	8.00	8.50	100.00	20.00	39.00	DIN 371	2909 10.000 2920 10.000
M12	1.750	9.00	7.00	10.20	110.00	24.00	49.00	DIN 376	2909 12.000 2920 12.000
M16	2.000	12.00	9.00	14.00	110.00	26.00	54.00	DIN 376	2909 16.000 2920 16.000



Taps for ISO metric threads

Article no. 993



Cutting data page 959

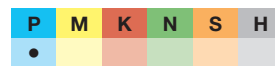

P ≤ 800 N/mm²

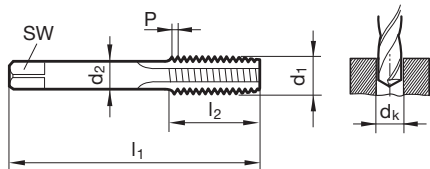

d1	P	d2	SW	dk	l1	l2	l5
	mm	mm	mm	mm	mm	mm	mm
M3	0.500	3.50	2.70	2.50	40.00	6.00	18.00
M4	0.700	4.50	3.40	3.30	45.00	7.50	21.00
M4,5	0.750	6.00	4.90	3.70	50.00	8.50	24.00
M5	0.800	6.00	4.90	4.20	50.00	8.50	24.00
M6	1.000	6.00	4.90	5.00	56.00	11.00	27.00
M8	1.250	6.00	4.90	6.80	63.00	14.00	32.00
M10	1.500	7.00	5.50	8.50	70.00	16.00	36.00
M12	1.750	9.00	7.00	10.20	75.00	18.50	40.00

Standard **DIN 352**
Article no. **993**

Order no.
993 3.000
993 4.000
993 4.500
993 5.000
993 6.000
993 8.000
993 10.000
993 12.000

Taps

Taps for ISO metric threads

Article no. 888



Cutting data page 959

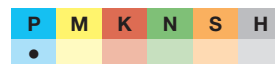

P ≤ 800 N/mm²

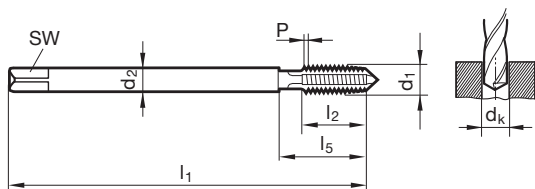

d1	P	d2	SW	dk	l1	l2	l5
	mm	mm	mm	mm	mm	mm	mm
M3	0.500	3.50	2.70	2.50	90.00	6.00	18.00
M4	0.700	4.50	3.40	3.30	125.00	7.50	21.00
M5	0.800	6.00	4.90	4.20	140.00	8.50	25.00
M6	1.000	6.00	4.90	5.00	160.00	11.00	30.00
M8	1.250	6.00	4.90	6.80	180.00	14.00	120.00
M10	1.500	7.00	5.50	8.50	200.00	16.00	140.00
M12	1.750	9.00	7.00	10.20	220.00	18.50	158.00
M14	2.000	11.00	9.00	12.00	220.00	20.00	160.00
M16	2.000	12.00	9.00	14.00	220.00	20.00	160.00
M20	2.500	16.00	12.00	17.50	280.00	25.00	217.00

Standard **Company std.**
Article no. **888**

Order no.
888 3.000
888 4.000
888 5.000
888 6.000
888 8.000
888 10.000
888 12.000
888 14.000
888 16.000
888 20.000



Taps for ISO metric fine threads

Article no. **833**



Cutting data page 959

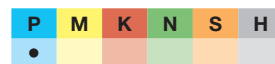

$P \leq 800 \text{ N/mm}^2$

Taps for ISO metric fine threads

Article no. **1971**



Cutting data page 959

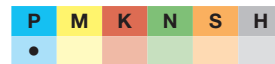

$P \leq 800 \text{ N/mm}^2$

Taps

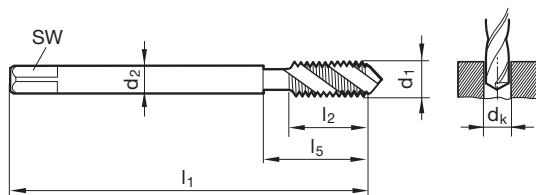

Standard
Article no.

DIN 374	
833	1971

d1	d2 mm	SW mm	dk mm	l1 mm	l2 mm	l5 mm	Order no.	
M6 x 0,75	4.50	3.40	5.20	80.00	8.00	30.00	833 6.004	1971 6.004
M8 x 1	6.00	4.90	7.00	90.00	11.00	35.00	833 8.005	1971 8.005
M10 x 1	7.00	5.50	9.00	90.00	11.00	35.00	833 10.005	1971 10.005
M10 x 1,25	7.00	5.50	8.80	100.00	14.00	39.00	833 10.006	1971 10.006
M12 x 1	9.00	7.00	11.00	100.00	11.00	40.00	833 12.005	1971 12.005
M12 x 1,25	9.00	7.00	10.80	100.00	15.00	40.00	833 12.006	1971 12.006
M12 x 1,5	9.00	7.00	10.50	100.00	15.00	40.00	833 12.007	1971 12.007
M14 x 1	11.00	9.00	13.00	100.00	11.00	40.00	833 14.005	1971 14.005
M14 x 1,5	11.00	9.00	12.50	100.00	15.00	40.00	833 14.007	1971 14.007
M16 x 1,5	12.00	9.00	14.50	100.00	15.00	44.00	833 16.007	1971 16.007
M18 x 1,5	14.00	11.00	16.50	110.00	16.00	44.00	833 18.007	1971 18.007
M20 x 1	16.00	12.00	19.00	125.00	12.00	44.00	833 20.005	1971 20.005
M20 x 1,5	16.00	12.00	18.50	125.00	16.00	44.00	833 20.007	1971 20.007
M22 x 1,5	18.00	14.50	20.50	125.00	16.00	44.00	833 22.007	1971 22.007
M24 x 1,5	18.00	14.50	22.50	140.00	16.00	48.00	833 24.007	1971 24.007
M24 x 2	18.00	14.50	22.00	140.00	22.00	48.00	833 24.008	1971 24.008
M30 x 1,5	22.00	18.00	28.50	150.00	20.00	53.00	833 30.007	1971 30.007
M30 x 2	22.00	18.00	28.00	150.00	20.00	53.00	833 30.008	1971 30.008



Taps for ISO metric fine threads

Article no. 834

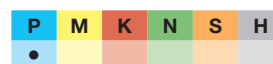

Cutting data page 959

P ≤ 800 N/mm²

Taps for ISO metric fine threads

Article no. 852

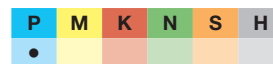
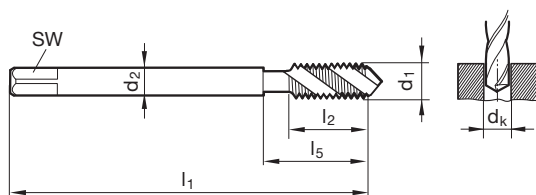

Cutting data page 959

P ≤ 800 N/mm²Standard
Article no.

DIN 374

834

852

Taps

d1	d2 mm	SW mm	dk mm	l1 mm	l2 mm	l5 mm	Order no.	
							834	852
M3 x 0,35	2.20	1.80	2.65	56.00	4.00	18.00	834 3.002	852 3.002
M3,5 x 0,35	2.50	2.10	3.15	56.00	4.00	20.00	834 3.502	852 3.502
M4 x 0,5	2.80	2.10	3.50	63.00	5.00	21.00	834 4.003	852 4.003
M5 x 0,5	3.50	2.70	4.50	70.00	5.00	25.00	834 5.003	852 5.003
M6 x 0,5	4.50	3.40	5.50	80.00	5.00	30.00	834 6.003	852 6.003
M6 x 0,75	4.50	3.40	5.20	80.00	8.00	30.00	834 6.004	852 6.004
M8 x 0,5	6.00	4.90	7.50	80.00	8.00	30.00		852 8.003
M8 x 0,75	6.00	4.90	7.20	80.00	8.00	30.00	834 8.004	852 8.004
M8 x 1	6.00	4.90	7.00	90.00	11.00	35.00	834 8.005	852 8.005
M10 x 0,75	7.00	5.50	9.20	90.00	11.00	35.00		852 10.004
M10 x 1	7.00	5.50	9.00	90.00	11.00	35.00	834 10.005	852 10.005
M10 x 1,25	7.00	5.50	8.80	100.00	14.00	39.00	834 10.006	852 10.006
M12 x 1	9.00	7.00	11.00	100.00	11.00	40.00	834 12.005	852 12.005
M12 x 1,25	9.00	7.00	10.80	100.00	15.00	40.00	834 12.006	852 12.006
M12 x 1,5	9.00	7.00	10.50	100.00	15.00	40.00	834 12.007	852 12.007
M14 x 1	11.00	9.00	13.00	100.00	11.00	40.00	834 14.005	852 14.005
M14 x 1,25	11.00	9.00	12.80	100.00	15.00	40.00	834 14.006	852 14.006
M14 x 1,5	11.00	9.00	12.50	100.00	15.00	40.00	834 14.007	852 14.007
M16 x 1	12.00	9.00	15.00	100.00	11.00	44.00	834 16.005	852 16.005
M16 x 1,5	12.00	9.00	14.50	100.00	15.00	44.00	834 16.007	852 16.007
M18 x 1	14.00	11.00	17.00	110.00	12.00	44.00	834 18.005	852 18.005
M18 x 1,5	14.00	11.00	16.50	110.00	16.00	44.00	834 18.007	852 18.007
M20 x 1	16.00	12.00	19.00	125.00	12.00	44.00		852 20.005
M20 x 1,5	16.00	12.00	18.50	125.00	16.00	44.00	834 20.007	852 20.007
M22 x 1,5	18.00	14.50	20.50	125.00	16.00	44.00	834 22.007	852 22.007
M24 x 1,5	18.00	14.50	22.50	140.00	16.00	48.00	834 24.007	852 24.007
M24 x 2	18.00	14.50	22.00	140.00	22.00	48.00	834 24.008	852 24.008
M26 x 1,5	18.00	14.50	24.50	140.00	20.00	50.00	834 26.007	
M27 x 1,5	20.00	16.00	25.50	140.00	20.00	53.00	834 27.007	
M27 x 2	20.00	16.00	25.00	140.00	20.00	53.00	834 27.008	
M30 x 1,5	22.00	18.00	28.50	150.00	20.00	53.00	834 30.007	852 30.007
M30 x 2	22.00	18.00	28.00	150.00	20.00	53.00	834 30.008	852 30.008



Taps for ISO metric fine threads

Article no. **4156**



Cutting data page 960

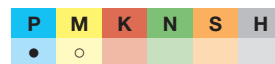

$P \leq 1000 \text{ N/mm}^2$

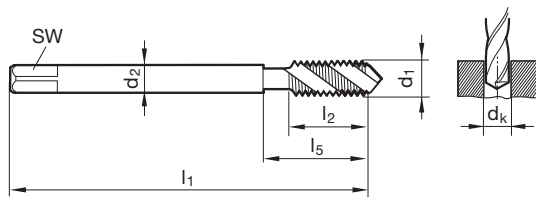

Standard **DIN 374**
Article no. **4156**

d1	d2 mm	SW mm	dk mm	l1 mm	l2 mm	l5 mm	Order no.
M8 x 1	6.00	4.90	7.00	90.00	11.00	35.00	4156 8.005
M10 x 1	7.00	5.50	9.00	90.00	11.00	35.00	4156 10.005
M10 x 1,25	7.00	5.50	8.80	100.00	14.00	39.00	4156 10.006
M12 x 1	9.00	7.00	11.00	100.00	11.00	40.00	4156 12.005
M12 x 1,5	9.00	7.00	10.50	100.00	15.00	40.00	4156 12.007
M14 x 1,5	11.00	9.00	12.50	100.00	15.00	40.00	4156 14.007
M16 x 1,5	12.00	9.00	14.50	100.00	15.00	44.00	4156 16.007

Taps

Taps for ISO metric fine threads

Article no. **4157**



Cutting data page 960

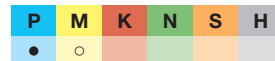

$P \leq 1000 \text{ N/mm}^2$

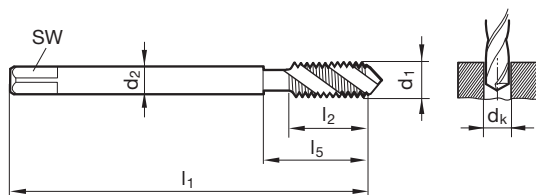

Standard **DIN 374**
Article no. **4157**

d1	d2 mm	SW mm	dk mm	l1 mm	l2 mm	l5 mm	Order no.
M8 x 1	6.00	4.90	7.00	90.00	11.00	35.00	4157 8.005
M10 x 1	7.00	5.50	9.00	90.00	11.00	35.00	4157 10.005
M10 x 1,25	7.00	5.50	8.80	100.00	14.00	39.00	4157 10.006
M12 x 1	9.00	7.00	11.00	100.00	11.00	40.00	4157 12.005
M12 x 1,5	9.00	7.00	10.50	100.00	15.00	40.00	4157 12.007
M14 x 1,5	11.00	9.00	12.50	100.00	15.00	40.00	4157 14.007
M16 x 1,5	12.00	9.00	14.50	100.00	15.00	44.00	4157 16.007

Taps for ISO metric fine threads

Article no. 2853

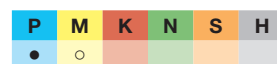

Cutting data page 960-961

P ≤ 1000 N/mm²

Taps for ISO metric fine threads

Article no. 4779

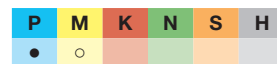

Cutting data page 960-961

P ≤ 1000 N/mm²

Taps for ISO metric fine threads

Article no. 1292

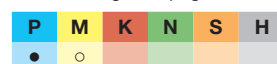
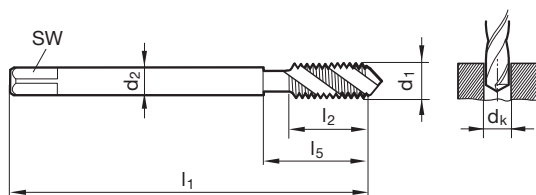

Cutting data page 960-961

P ≤ 1000 N/mm²

Standard

DIN 374

Article no.

2853

4779

1292

d1	d2 mm	SW mm	dk mm	l1 mm	l2 mm	l5 mm	Order no.
M5 x 0,5	3.50	2.70	4.50	70.00	5.00	25.00	2853 5.003 4779 5.003
M6 x 0,75	4.50	3.40	5.20	80.00	8.00	30.00	2853 6.004 4779 6.004
M8 x 1	6.00	4.90	7.00	90.00	11.00	35.00	2853 8.005 4779 8.005 1292 8.005
M10 x 1	7.00	5.50	9.00	90.00	11.00	35.00	2853 10.005 4779 10.005 1292 10.005
M10 x 1,25	7.00	5.50	8.80	100.00	14.00	39.00	2853 10.006 4779 10.006 1292 10.006
M12 x 1	9.00	7.00	11.00	100.00	11.00	40.00	2853 12.005 4779 12.005 1292 12.005
M12 x 1,25	9.00	7.00	10.80	100.00	15.00	40.00	2853 12.006 4779 12.006 1292 12.006
M12 x 1,5	9.00	7.00	10.50	100.00	15.00	40.00	2853 12.007 4779 12.007 1292 12.007
M14 x 1	11.00	9.00	13.00	100.00	11.00	40.00	2853 14.005 4779 14.005
M14 x 1,25	11.00	9.00	12.80	100.00	15.00	40.00	2853 14.006 4779 14.006 1292 14.006
M14 x 1,5	11.00	9.00	12.50	100.00	15.00	40.00	2853 14.007 4779 14.007 1292 14.007
M16 x 1	12.00	9.00	15.00	100.00	11.00	44.00	2853 16.005 4779 16.005
M16 x 1,5	12.00	9.00	14.50	100.00	15.00	44.00	2853 16.007 4779 16.007 1292 16.007
M18 x 1	14.00	11.00	17.00	110.00	12.00	44.00	2853 18.005 4779 18.005
M18 x 1,5	14.00	11.00	16.50	110.00	16.00	44.00	2853 18.007 4779 18.007 1292 18.007
M20 x 1,5	16.00	12.00	18.50	125.00	16.00	44.00	2853 20.007 4779 20.007 1292 20.007
M22 x 1,5	18.00	14.50	20.50	125.00	16.00	44.00	2853 22.007 4779 22.007 1292 22.007
M24 x 1,5	18.00	14.50	22.50	140.00	16.00	48.00	2853 24.007 4779 24.007 1292 24.007
M24 x 2	18.00	14.50	22.00	140.00	22.00	48.00	2853 24.008 4779 24.008 1292 24.008
M26 x 1,5	18.00	14.50	24.50	140.00	20.00	50.00	2853 26.007 4779 26.007
M27 x 1,5	20.00	16.00	25.50	140.00	20.00	53.00	2853 27.007 4779 27.007
M27 x 2	20.00	16.00	25.00	140.00	20.00	53.00	2853 27.008 4779 27.008
M28 x 1,5	20.00	16.00	26.50	140.00	20.00	53.00	2853 28.007 4779 28.007
M30 x 1,5	22.00	18.00	28.50	150.00	20.00	53.00	2853 30.007 4779 30.007
M30 x 2	22.00	18.00	28.00	150.00	20.00	53.00	2853 30.008 4779 30.008



Taps for ISO metric fine threads

Article no. **2999**



Cutting data page 960

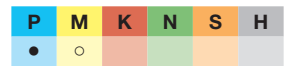

P ≤ 1000 N/mm²

Taps for ISO metric fine threads

Article no. **1049**



Cutting data page 960

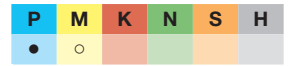

P ≤ 1000 N/mm²

Taps

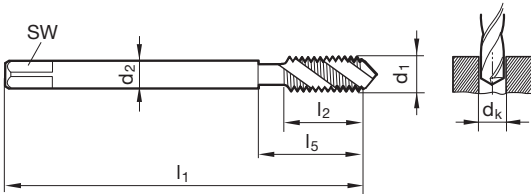

Standard
Article no.

DIN 374	
2999	1049

d1	d2 mm	SW mm	dk mm	l1 mm	l2 mm	l5 mm
M8 x 1	6.00	4.90	7.00	90.00	11.00	35.00
M10 x 1	7.00	5.50	9.00	90.00	11.00	35.00
M12 x 1	9.00	7.00	11.00	100.00	11.00	40.00
M12 x 1,25	9.00	7.00	10.80	100.00	15.00	40.00
M12 x 1,5	9.00	7.00	10.50	100.00	15.00	40.00
M14 x 1,5	11.00	9.00	12.50	100.00	15.00	40.00
M16 x 1,5	12.00	9.00	14.50	100.00	15.00	44.00
M18 x 1,5	14.00	11.00	16.50	110.00	16.00	44.00
M20 x 1,5	16.00	12.00	18.50	125.00	16.00	44.00

Order no.	
2999 8.005	1049 8.005
2999 10.005	1049 10.005
2999 12.005	1049 12.005
2999 12.006	1049 12.006
2999 12.007	1049 12.007
2999 14.007	1049 14.007
2999 16.007	1049 16.007
2999 18.007	1049 18.007
2999 20.007	1049 20.007

Taps for ISO metric fine threads

Article no. **273**



Cutting data page 960

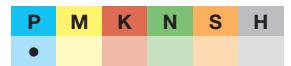

bright correction

P ≤ 1000 N/mm²

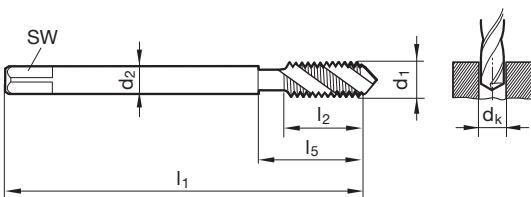

Standard
Article no.

DIN 374	
273	

d1	d2 mm	SW mm	dk mm	l1 mm	l2 mm	l5 mm
M10 x 1	7.00	5.50	9.00	90.00	11.00	35.00
M10 x 1,25	7.00	5.50	8.80	100.00	14.00	39.00
M12 x 1	9.00	7.00	11.00	100.00	11.00	40.00
M12 x 1,25	9.00	7.00	10.80	100.00	15.00	40.00
M12 x 1,5	9.00	7.00	10.50	100.00	15.00	40.00
M14 x 1,5	11.00	9.00	12.50	100.00	15.00	40.00
M16 x 1,5	12.00	9.00	14.50	100.00	15.00	44.00
M18 x 1,5	14.00	11.00	16.50	110.00	16.00	44.00
M20 x 1,5	16.00	12.00	18.50	125.00	16.00	44.00
M22 x 1,5	18.00	14.50	20.50	125.00	16.00	44.00
M24 x 1,5	18.00	14.50	22.50	140.00	16.00	48.00

Order no.	
273 10.005	
273 10.006	
273 12.005	
273 12.006	
273 12.007	
273 14.007	
273 16.007	
273 18.007	
273 20.007	
273 22.007	
273 24.007	



Taps for ISO metric fine threads

Article no. 2852

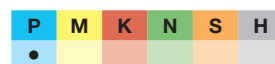

Cutting data page 961

P ≤ 1200 N/mm²

Taps for ISO metric fine threads

Article no. 4796

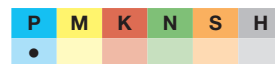
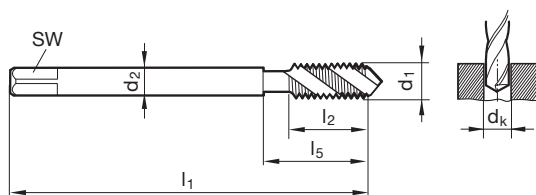

Cutting data page 961

P ≤ 1200 N/mm²Standard
Article no.

DIN 374

2852 4796

d1	d2 mm	SW mm	dk mm	l1 mm	l2 mm	l5 mm	Order no.	
M8 x 0,75	6.00	4.90	7.20	80.00	8.00	30.00	2852 8.004	4796 8.004
M8 x 1	6.00	4.90	7.00	90.00	11.00	35.00	2852 8.005	4796 8.005
M10 x 1	7.00	5.50	9.00	90.00	11.00	35.00	2852 10.005	4796 10.005
M12 x 1	9.00	7.00	11.00	100.00	11.00	40.00	2852 12.005	4796 12.005
M12 x 1,5	9.00	7.00	10.50	100.00	15.00	40.00	2852 12.007	4796 12.007
M14 x 1,5	11.00	9.00	12.50	100.00	15.00	40.00	2852 14.007	4796 14.007
M16 x 1,5	12.00	9.00	14.50	100.00	15.00	44.00	2852 16.007	4796 16.007
M20 x 1,5	16.00	12.00	18.50	125.00	16.00	44.00	2852 20.007	4796 20.007
M22 x 1,5	18.00	14.50	20.50	125.00	16.00	44.00	2852 22.007	4796 22.007
M24 x 1,5	18.00	14.50	22.50	140.00	16.00	48.00	2852 24.007	4796 24.007

Taps

Taps for ISO metric fine threads

Article no. 2988

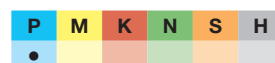

Cutting data page 961

P ≤ 1200 N/mm²

Taps for ISO metric fine threads

Article no. 2989

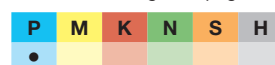
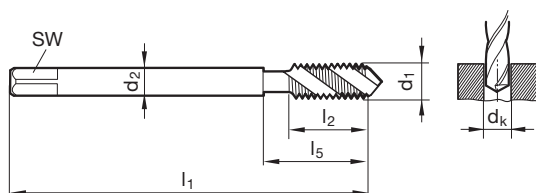

Cutting data page 961

P ≤ 1200 N/mm²Standard
Article no.

DIN 374

2988 2989

d1	d2 mm	SW mm	dk mm	l1 mm	l2 mm	l5 mm	Order no.	
M8 x 1	6.00	4.90	7.00	90.00	11.00	35.00	2988 8.005	2989 8.005
M10 x 1	7.00	5.50	9.00	90.00	11.00	35.00	2988 10.005	2989 10.005
M12 x 1,5	9.00	7.00	10.50	100.00	15.00	40.00	2988 12.007	2989 12.007
M14 x 1,5	11.00	9.00	12.50	100.00	15.00	40.00	2988 14.007	2989 14.007
M16 x 1,5	12.00	9.00	14.50	100.00	15.00	44.00	2988 16.007	2989 16.007
M18 x 1,5	14.00	11.00	16.50	110.00	16.00	44.00	2988 18.007	2989 18.007
M20 x 1,5	16.00	12.00	18.50	125.00	16.00	44.00	2988 20.007	2989 20.007

Taps with coolant ducts for ISO metric fine threads

Article no. **1090**



Cutting data page 961



$P \leq 1200 \text{ N/mm}^2$

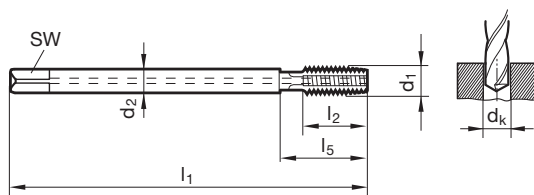

Standard **DIN 374**
Article no. **1090**

d1	d2 mm	SW mm	dk mm	l1 mm	l2 mm	l5 mm	Order no.
M5 x 0,5	3.50	2.70	4.50	70.00	10.00	25.00	1090 5.003
M6 x 0,5	4.50	3.40	5.50	80.00	13.00	30.00	1090 6.003
M6 x 0,75	4.50	3.40	5.20	80.00	13.00	30.00	1090 6.004
M8 x 0,75	6.00	4.90	7.20	80.00	14.00	30.00	1090 8.004
M8 x 1	6.00	4.90	7.00	90.00	17.00	35.00	1090 8.005
M10 x 1	7.00	5.50	9.00	90.00	16.00	35.00	1090 10.005
M10 x 1,25	7.00	5.50	8.80	100.00	20.00	39.00	1090 10.006
M12 x 1	9.00	7.00	11.00	100.00	20.00	40.00	1090 12.005
M12 x 1,25	9.00	7.00	10.80	100.00	20.00	40.00	1090 12.006
M12 x 1,5	9.00	7.00	10.50	100.00	20.00	40.00	1090 12.007
M14 x 1,5	11.00	9.00	12.50	100.00	20.00	40.00	1090 14.007
M16 x 1,5	12.00	9.00	14.50	100.00	22.00	44.00	1090 16.007

Taps

Taps with coolant ducts for ISO metric fine threads

Article no. **1007**



Cutting data page 961



$P \leq 1200 \text{ N/mm}^2$

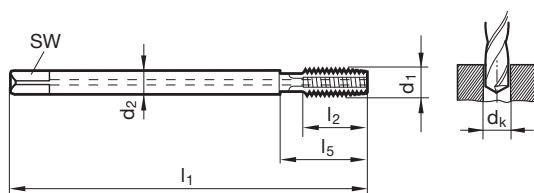

Standard **DIN 374**
Article no. **1007**

d1	d2 mm	SW mm	dk mm	l1 mm	l2 mm	l5 mm	Order no.
M5 x 0,5	3.50	2.70	4.50	70.00	10.00	25.00	1007 5.003
M6 x 0,5	4.50	3.40	5.50	80.00	13.00	30.00	1007 6.003
M8 x 1	6.00	4.90	7.00	90.00	17.00	35.00	1007 8.005
M9 x 1	7.00	5.50	8.00	90.00	16.00	35.00	1007 9.005
M10 x 1	7.00	5.50	9.00	90.00	16.00	35.00	1007 10.005
M10 x 1,25	7.00	5.50	8.80	100.00	20.00	39.00	1007 10.006
M12 x 1	9.00	7.00	11.00	100.00	20.00	40.00	1007 12.005
M12 x 1,25	9.00	7.00	10.80	100.00	20.00	40.00	1007 12.006
M12 x 1,5	9.00	7.00	10.50	100.00	20.00	40.00	1007 12.007
M14 x 1	11.00	9.00	13.00	100.00	20.00	40.00	1007 14.005
M14 x 1,25	11.00	9.00	12.80	100.00	20.00	40.00	1007 14.006
M14 x 1,5	11.00	9.00	12.50	100.00	20.00	40.00	1007 14.007
M16 x 1	12.00	9.00	15.00	100.00	22.00	44.00	1007 16.005
M16 x 1,5	12.00	9.00	14.50	100.00	22.00	44.00	1007 16.007

Taps with coolant ducts for ISO metric fine threads

Article no. 1200



Cutting data page 961

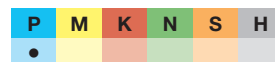
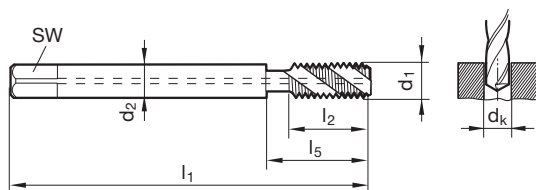

bright flute

 $P \leq 1200 \text{ N/mm}^2$ 

							Standard	DIN 374
							Article no.	1200
d1	d2	SW	dk	l1	l2	l5	Order no.	
mm	mm	mm	mm	mm	mm	mm		
M6 x 0,75	4.50	3.40	5.20	80.00	8.00	30.00	1200 6.004	
M8 x 0,75	6.00	4.90	7.20	80.00	8.00	30.00	1200 8.004	
M8 x 1	6.00	4.90	7.00	90.00	11.00	35.00	1200 8.005	
M9 x 1	7.00	5.50	8.00	90.00	11.00	35.00	1200 9.005	
M10 x 1	7.00	5.50	9.00	90.00	11.00	35.00	1200 10.005	
M12 x 1	9.00	7.00	11.00	100.00	11.00	40.00	1200 12.005	
M12 x 1,25	9.00	7.00	10.80	100.00	15.00	40.00	1200 12.006	
M12 x 1,5	9.00	7.00	10.50	100.00	15.00	40.00	1200 12.007	
M14 x 1,5	11.00	9.00	12.50	100.00	15.00	40.00	1200 14.007	
M16 x 1,5	12.00	9.00	14.50	100.00	15.00	44.00	1200 16.007	
M18 x 1,5	14.00	11.00	16.50	110.00	16.00	44.00	1200 18.007	
M20 x 1,5	16.00	12.00	18.50	125.00	16.00	44.00	1200 20.007	
M24 x 1,5	18.00	14.50	22.50	140.00	16.00	48.00	1200 24.007	

Taps



Taps for ISO metric fine threads

Article no. **1874**



Cutting data page 964

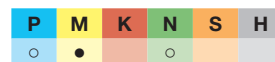

$P \leq 1000 \text{ N/mm}^2$

Taps for ISO metric fine threads

Article no. **2897**



Cutting data page 964

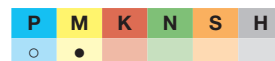

$P \leq 1000 \text{ N/mm}^2$

Taps

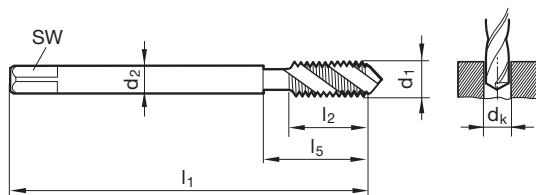

Standard
Article no.

DIN 374	
1874	2897

d1	d2 mm	SW mm	dk mm	l1 mm	l2 mm	l5 mm	Order no.	
M4 x 0,5	2.80	2.10	3.50	63.00	5.00	21.00	1874 4.003	2897 4.003
M5 x 0,5	3.50	2.70	4.50	70.00	5.00	25.00	1874 5.003	2897 5.003
M6 x 0,5	4.50	3.40	5.50	80.00	5.00	30.00	1874 6.003	2897 6.003
M6 x 0,75	4.50	3.40	5.20	80.00	8.00	30.00	1874 6.004	2897 6.004
M8 x 1	6.00	4.90	7.00	90.00	11.00	35.00	1874 8.005	2897 8.005
M10 x 1	7.00	5.50	9.00	90.00	11.00	35.00	1874 10.005	2897 10.005
M12 x 1	9.00	7.00	11.00	100.00	11.00	40.00	1874 12.005	2897 12.005
M12 x 1,5	9.00	7.00	10.50	100.00	15.00	40.00	1874 12.007	2897 12.007
M14 x 1,5	11.00	9.00	12.50	100.00	15.00	40.00	1874 14.007	2897 14.007
M16 x 1,5	12.00	9.00	14.50	100.00	15.00	44.00	1874 16.007	2897 16.007
M18 x 1,5	14.00	11.00	16.50	110.00	16.00	44.00	1874 18.007	2897 18.007
M20 x 1,5	16.00	12.00	18.50	125.00	16.00	44.00	1874 20.007	
M20 x 2	16.00	12.00	18.00	140.00	20.00	60.00	1874 20.008	2897 20.008
M22 x 1,5	18.00	14.50	20.50	125.00	16.00	44.00	1874 22.007	2897 22.007
M24 x 1,5	18.00	14.50	22.50	140.00	16.00	48.00	1874 24.007	2897 24.007



Taps for ISO metric fine threads

Article no. 4798



HSS-E VA R40 ISO2/6H R Cyl C 3xD

Cutting data page 964

P	M	K	N	S	H
	●		○		

Taps for ISO metric fine threads

Article no. 2864



HSS-E VA R40 ISO2/6H R Cyl C 3xD

Cutting data page 964

P	M	K	N	S	H
	●		○		

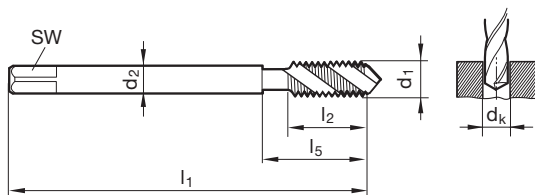

Standard
Article no.

DIN 374	
4798	2864

Taps

d1	d2 mm	SW mm	dk mm	l1 mm	l2 mm	l5 mm	Order no.	
M3 x 0,35	2.20	1.80	2.65	56.00	4.00	18.00	4798 3.002	2864 3.002
M4 x 0,5	2.80	2.10	3.50	63.00	5.00	21.00	4798 4.003	2864 4.003
M5 x 0,5	3.50	2.70	4.50	70.00	5.00	25.00	4798 5.003	2864 5.003
M6 x 0,5	4.50	3.40	5.50	80.00	5.00	30.00	4798 6.003	2864 6.003
M6 x 0,75	4.50	3.40	5.20	80.00	8.00	30.00	4798 6.004	2864 6.004
M8 x 0,5	6.00	4.90	7.50	80.00	8.00	30.00	4798 8.003	2864 8.003
M8 x 0,75	6.00	4.90	7.20	80.00	8.00	30.00	4798 8.004	2864 8.004
M8 x 1	6.00	4.90	7.00	90.00	11.00	35.00	4798 8.005	2864 8.005
M10 x 1	7.00	5.50	9.00	90.00	11.00	35.00	4798 10.005	2864 10.005
M12 x 1	9.00	7.00	11.00	100.00	11.00	40.00	4798 12.005	2864 12.005
M12 x 1,5	9.00	7.00	10.50	100.00	15.00	40.00	4798 12.007	2864 12.007
M14 x 1,5	11.00	9.00	12.50	100.00	15.00	40.00	4798 14.007	2864 14.007
M16 x 1,5	12.00	9.00	14.50	100.00	15.00	44.00	4798 16.007	2864 16.007
M18 x 1,5	14.00	11.00	16.50	110.00	16.00	44.00	4798 18.007	2864 18.007
M20 x 1,5	16.00	12.00	18.50	125.00	16.00	44.00	4798 20.007	2864 20.007
M22 x 1,5	18.00	14.50	20.50	125.00	16.00	44.00	4798 22.007	2864 22.007
M24 x 1,5	18.00	14.50	22.50	140.00	16.00	48.00	4798 24.007	2864 24.007

Taps for ISO metric fine threads

Article no. **764**



Synchronous tap

Cutting data page 964

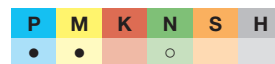

$P \leq 1000 \text{ N/mm}^2$

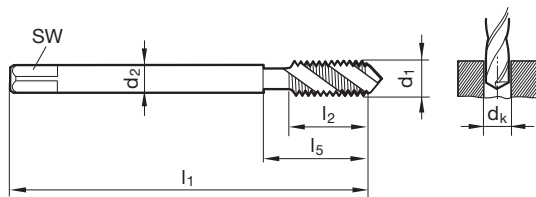

Standard

DIN 374

Article no.

764

d1	d2	SW	dk	l1	l2	l5
mm	mm	mm	mm	mm	mm	mm
M8 x 1	6.00	4.90	7.00	90.00	5.00	35.00
M10 x 1	7.00	5.50	9.00	90.00	5.00	35.00
M12 x 1	9.00	7.00	11.00	100.00	5.00	40.00
M12 x 1,5	9.00	7.00	10.50	100.00	7.50	40.00
M14 x 1,5	11.00	9.00	12.50	100.00	7.50	40.00
M16 x 1,5	12.00	9.00	14.50	100.00	7.50	44.00
M18 x 1,5	14.00	11.00	16.50	110.00	7.50	44.00
M20 x 1,5	16.00	12.00	18.50	125.00	7.50	44.00

Order no.

764 8.005
764 10.005
764 12.005
764 12.007
764 14.007
764 16.007
764 18.007
764 20.007

Taps

Taps with coolant ducts for ISO metric fine threads

Article no. **1144**



Synchronous tap

Cutting data page 964

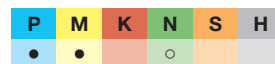

$P \leq 1000 \text{ N/mm}^2$

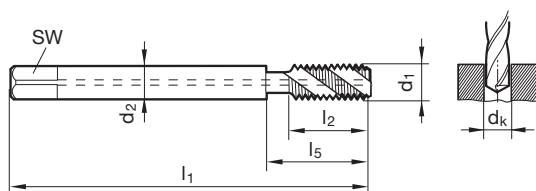

Standard

DIN 374

Article no.

1144

d1	d2	SW	dk	l1	l2	l5
mm	mm	mm	mm	mm	mm	mm
M8 x 1	6.00	4.90	7.00	90.00	5.00	35.00
M10 x 1	7.00	5.50	9.00	90.00	5.00	35.00
M12 x 1	9.00	7.00	11.00	100.00	5.00	40.00
M12 x 1,5	9.00	7.00	10.50	100.00	7.50	40.00
M14 x 1,5	11.00	9.00	12.50	100.00	7.50	40.00
M16 x 1,5	12.00	9.00	14.50	100.00	7.50	44.00
M18 x 1,5	14.00	11.00	16.50	110.00	7.50	44.00
M20 x 1,5	16.00	12.00	18.50	125.00	7.50	44.00

Order no.

1144 8.005
1144 10.005
1144 12.005
1144 12.007
1144 14.007
1144 16.007
1144 18.007
1144 20.007



Taps with coolant ducts for ISO metric fine threads

Article no. 1904



Cutting data page 962



Taps with coolant ducts for ISO metric fine threads

Article no. 347



Cutting data page 962

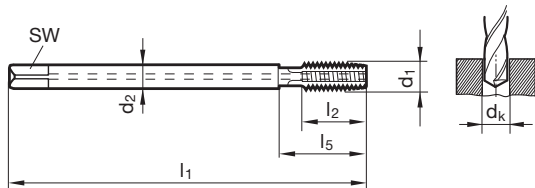

Standard
Article no.

DIN 374	
1904	347

Taps

d1	d2 mm	SW mm	dk mm	l1 mm	l2 mm	l5 mm
M8 x 1	6.00	4.90	7.00	90.00	17.00	35.00
M10 x 1	7.00	5.50	9.00	90.00	16.00	35.00
M12 x 1	9.00	7.00	11.00	100.00	20.00	40.00
M12 x 1,5	9.00	7.00	10.50	100.00	20.00	40.00
M14 x 1,5	11.00	9.00	12.50	100.00	20.00	40.00
M16 x 1,5	12.00	9.00	14.50	100.00	22.00	44.00
M18 x 1,5	14.00	11.00	16.50	110.00	25.00	44.00
M20 x 1,5	16.00	12.00	18.50	125.00	25.00	44.00
M22 x 1,5	18.00	14.50	20.50	125.00	25.00	44.00
M24 x 1,5	18.00	14.50	22.50	140.00	28.00	48.00

Order no.	
1904 8.005	347 8.005
1904 10.005	347 10.005
1904 12.005	347 12.005
1904 12.007	347 12.007
1904 14.007	347 14.007
1904 16.007	347 16.007
1904 18.007	347 18.007
1904 20.007	347 20.007
1904 22.007	347 22.007
1904 24.007	347 24.007



Taps with coolant ducts for ISO metric fine threads

Article no. **972**



Cutting data page 962-963



N ≥ 7% Si

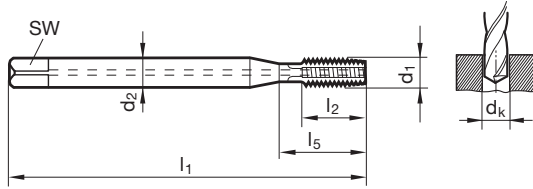

Standard **DIN 371**
Article no. **972**

d1	d2	SW	dk	l1	l2	l5	Order no.
M5 x 0,5	6.00	4.90	4.50	70.00	10.00	25.00	972 5.003
M8 x 1	8.00	6.20	7.00	90.00	16.00	35.00	972 8.005
M10 x 1	10.00	8.00	9.00	90.00	18.00	35.00	972 10.005

Taps

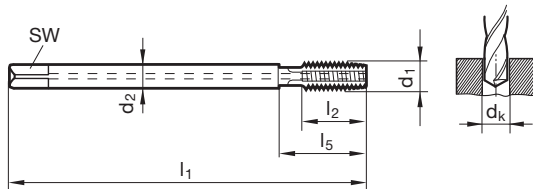

Standard **DIN 374**
Article no. **974**

d1	d2	SW	dk	l1	l2	l5	Order no.
M12 x 1,5	9.00	7.00	10.50	100.00	15.00	40.00	974 12.007
M14 x 1,5	11.00	9.00	12.50	100.00	15.00	40.00	974 14.007
M16 x 1,5	12.00	9.00	14.50	100.00	15.00	44.00	974 16.007
M18 x 1,5	14.00	11.00	16.50	110.00	15.00	44.00	974 18.007
M20 x 1,5	16.00	12.00	18.50	125.00	15.00	44.00	974 20.007

Taps with coolant ducts for ISO metric fine threads

Article no. **1009**



Cutting data page 962-963



N ≥ 7% Si

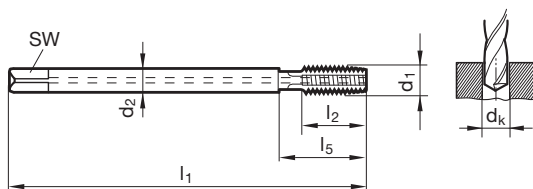

Standard **~DIN 371/~DIN 374**
Article no. **1009**

d1	d2	SW	dk	l1	l2	l5	Order no.
M10 x 1	10.00	8.00	9.00	90.00	18.00	35.00	DIN 371 1009 10.005
M12 x 1	9.00	7.00	11.00	100.00	15.00	40.00	DIN 374 1009 12.005
M12 x 1,5	9.00	7.00	10.50	100.00	15.00	40.00	DIN 374 1009 12.007
M14 x 1,5	11.00	9.00	12.50	100.00	15.00	40.00	DIN 374 1009 14.007
M16 x 1,5	12.00	9.00	14.50	100.00	15.00	44.00	DIN 374 1009 16.007

Taps with coolant ducts for ISO metric fine threads

Article no. 977

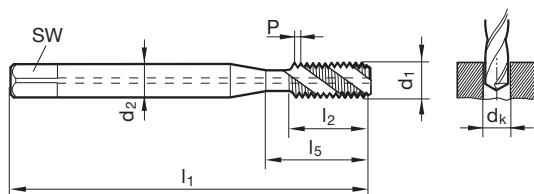

Cutting data page 963

with internal cooling \geq M5N \geq 7% Si

Standard

DIN 371

Article no.

977

d1	d2 mm	SW mm	dk mm	l1 mm	l2 mm	l5 mm	Order no.
M4 x 0,5	4.50	3.40	3.50	63.00	10.00	21.00	977 4.003
M5 x 0,5	6.00	4.90	4.50	70.00	10.00	25.00	977 5.003
M6 x 0,5	6.00	4.90	5.50	80.00	12.00	30.00	977 6.003
M8 x 1	8.00	6.20	7.00	90.00	16.00	35.00	977 8.005
M10 x 1	10.00	8.00	9.00	90.00	18.00	35.00	977 10.005

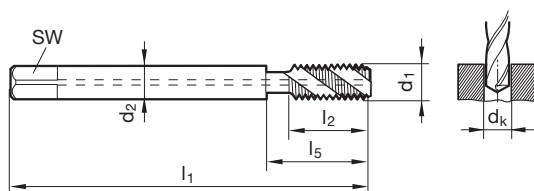

Standard

DIN 374

Article no.

978

d1	d2 mm	SW mm	dk mm	l1 mm	l2 mm	l5 mm	Order no.
M12 x 1,5	9.00	7.00	10.50	100.00	15.00	40.00	978 12.007
M14 x 1,5	11.00	9.00	12.50	100.00	15.00	40.00	978 14.007
M16 x 1,5	12.00	9.00	14.50	100.00	15.00	44.00	978 16.007
M18 x 1,5	14.00	11.00	16.50	110.00	15.00	44.00	978 18.007

Taps



Taps for ISO metric fine threads

Article no. **2910**



Cutting data page 966-967

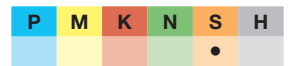

S = Ti

Taps for ISO metric fine threads

Article no. **2921**



Cutting data page 966-967

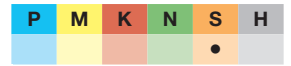

S = Ni

Taps

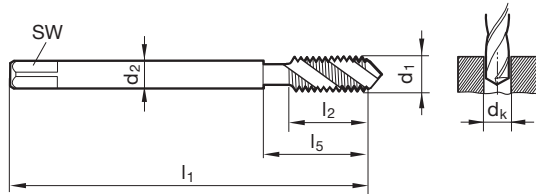

Standard
Article no.

DIN 371	
2910	2921

d1	d2 mm	SW mm	dk mm	l1 mm	l2 mm	l5 mm
M3 x 0,35	3.50	2.70	2.65	56.00	6.00	18.00
M4 x 0,5	4.50	3.40	3.50	63.00	7.50	21.00
M5 x 0,5	6.00	4.90	4.50	70.00	8.50	25.00
M6 x 0,5	6.00	4.90	5.50	80.00	11.00	30.00
M6 x 0,75	6.00	4.90	5.20	80.00	11.00	30.00
M8 x 0,5	8.00	6.20	7.50	80.00	14.00	30.00
M8 x 0,75	8.00	6.20	7.20	80.00	14.00	30.00
M8 x 1	8.00	6.20	7.00	90.00	14.00	35.00
M10 x 1	10.00	8.00	9.00	90.00	16.00	35.00
M10 x 1,25	10.00	8.00	8.80	100.00	20.00	39.00

Order no.	
2910 3.002	2921 3.002
2910 4.003	2921 4.003
2910 5.003	2921 5.003
2910 6.003	2921 6.003
2910 6.004	2921 6.004
2910 8.004	2921 8.004
2910 8.005	2921 8.005
2910 10.005	2921 10.005
	2921 10.006

Taps for UNC threads

Article no. 1978

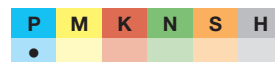
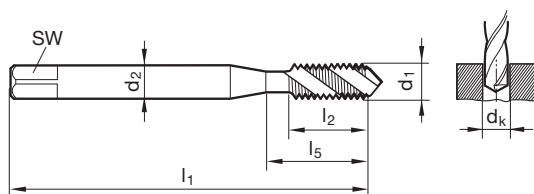

Cutting data page 959

 $P \leq 800 \text{ N/mm}^2$ 

Standard

~DIN 371

Article no.

1978

d1	d2 mm	SW mm	dk mm	l1 mm	l2 mm	l5 mm	Order no.
2 - 56	2.80	2.10	1.85	45.00	5.00	14.50	1978 2.184
3 - 48	2.80	2.10	2.10	50.00	6.00	14.50	1978 2.515
4 - 40	3.50	2.70	2.35	56.00	7.00	18.00	1978 2.845
5 - 40	3.50	2.70	2.65	56.00	7.00	18.00	1978 3.175
6 - 32	4.00	3.00	2.85	56.00	8.00	20.00	1978 3.505
8 - 32	4.50	3.40	3.50	63.00	8.00	21.00	1978 4.166
10 - 24	6.00	4.90	3.90	70.00	11.00	25.00	1978 4.826
12 - 24	6.00	4.90	4.50	80.00	11.00	30.00	1978 5.486
1/4 - 20	7.00	5.50	5.10	80.00	13.00	30.00	1978 6.350
5/16 - 18	8.00	6.20	6.60	90.00	14.00	35.00	1978 7.938
3/8 - 16	10.00	8.00	8.00	100.00	16.00	39.00	1978 9.525

Taps



Taps for UNC threads

Article no. **876**



Cutting data page 959

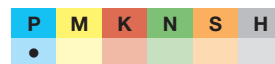

$P \leq 800 \text{ N/mm}^2$

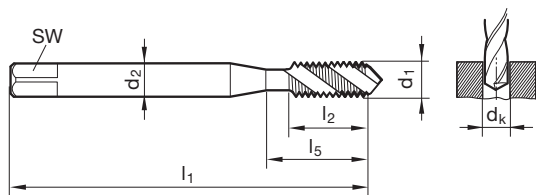

Standard **~DIN 371**

Article no. **876**

d1	d2 mm	SW mm	dk mm	l1 mm	l2 mm	l5 mm
2 - 56	2.80	2.10	1.85	45.00	5.00	14.50
4 - 40	3.50	2.70	2.35	56.00	7.00	18.00
6 - 32	4.00	3.00	2.85	56.00	8.00	20.00
8 - 32	4.50	3.40	3.50	63.00	8.00	21.00
10 - 24	6.00	4.90	3.90	70.00	11.00	25.00
12 - 24	6.00	4.90	4.50	80.00	11.00	30.00
1/4 - 20	7.00	5.50	5.10	80.00	13.00	30.00
5/16 - 18	8.00	6.20	6.60	90.00	14.00	35.00
3/8 - 16	10.00	8.00	8.00	100.00	16.00	39.00

Order no.

876 2.184
876 2.845
876 3.505
876 4.166
876 4.826
876 5.486
876 6.350
876 7.938
876 9.525

Taps

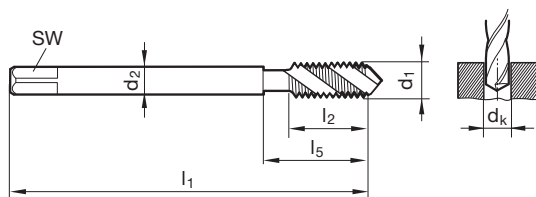

Standard **~DIN 376**

Article no. **881**

d1	d2 mm	SW mm	dk mm	l1 mm	l2 mm	l5 mm
7/16 - 14	8.00	6.20	9.40	100.00	18.00	42.00
1/2 - 13	9.00	7.00	10.80	110.00	20.00	49.00
9/16 - 12	11.00	9.00	12.20	110.00	21.00	53.00
5/8 - 11	12.00	9.00	13.50	110.00	24.00	53.00
3/4 - 10	14.00	11.00	16.50	125.00	25.00	62.00
7/8 - 9	18.00	14.50	19.50	140.00	28.00	62.00
1 - 8	18.00	14.50	22.25	160.00	32.00	73.00

Order no.

881 11.113
881 12.700
881 14.288
881 15.875
881 19.050
881 22.225
881 25.400

Taps for UNC threads

Article no. **2855**

Cutting data page 960

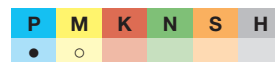
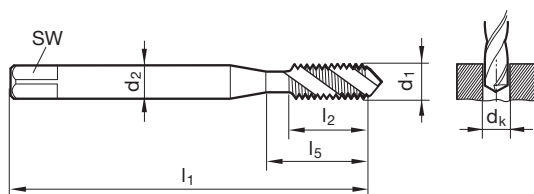
P ≤ 1000 N/mm²

Standard ~DIN 371

Article no. **2855**

d1	d2 mm	SW mm	dk mm	l1 mm	l2 mm	l5 mm	Order no.
4 - 40	3.50	2.70	2.35	56.00	7.00	18.00	2855 2.845
5 - 40	3.50	2.70	2.65	56.00	7.00	18.00	2855 3.175
6 - 32	4.00	3.00	2.85	56.00	8.00	20.00	2855 3.505
8 - 32	4.50	3.40	3.50	63.00	8.00	21.00	2855 4.166
10 - 24	6.00	4.90	3.90	70.00	11.00	25.00	2855 4.826
12 - 24	6.00	4.90	4.50	80.00	11.00	30.00	2855 5.486
1/4 - 20	7.00	5.50	5.10	80.00	13.00	30.00	2855 6.350
5/16 - 18	8.00	6.20	6.60	90.00	14.00	35.00	2855 7.938
3/8 - 16	10.00	8.00	8.00	100.00	16.00	39.00	2855 9.525

Taps

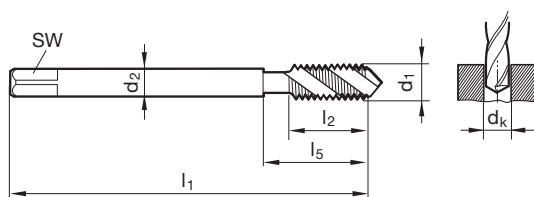

Standard ~DIN 376

Article no. **2857**

d1	d2 mm	SW mm	dk mm	l1 mm	l2 mm	l5 mm	Order no.
7/16 - 14	8.00	6.20	9.40	100.00	18.00	42.00	2857 11.113
1/2 - 13	9.00	7.00	10.80	110.00	20.00	49.00	2857 12.700
9/16 - 12	11.00	9.00	12.20	110.00	21.00	53.00	2857 14.288
5/8 - 11	12.00	9.00	13.50	110.00	24.00	53.00	2857 15.875
3/4 - 10	14.00	11.00	16.50	125.00	25.00	62.00	2857 19.050
7/8 - 9	18.00	14.50	19.50	140.00	28.00	62.00	2857 22.225
1 - 8	18.00	14.50	22.25	160.00	32.00	73.00	2857 25.400



Taps for UNC threads

Article no. **1837**



Cutting data page 960



bright correction

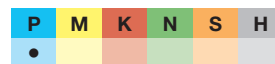

P ≤ 1000 N/mm²

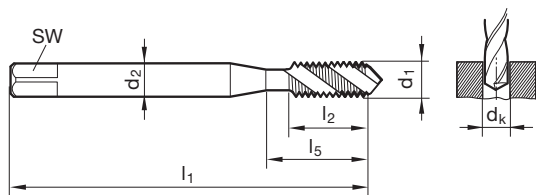

Standard

~DIN 371

Article no.

1837

d1	d2 mm	SW mm	dk mm	l1 mm	l2 mm	l5 mm
10 - 24	6.00	4.90	3.90	70.00	11.00	25.00
12 - 24	6.00	4.90	4.50	80.00	11.00	30.00
1/4 - 20	7.00	5.50	5.10	80.00	13.00	30.00
5/16 - 18	8.00	6.20	6.60	90.00	14.00	35.00
3/8 - 16	10.00	8.00	8.00	100.00	16.00	39.00

Order no.

1837 4.826

1837 5.486

1837 6.350

1837 7.938

1837 9.525

Taps



Taps for UNC threads

Article no. 1981



Cutting data page 964



P	M	K	N	S	H
	•		○		

Taps for UNC threads

Article no. 2865



Cutting data page 964



P	M	K	N	S	H
	•		○		

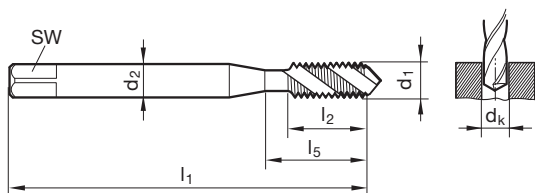

Standard
Article no.

~DIN 371	
1981	2865

Taps

d1	d2 mm	SW mm	dk mm	l1 mm	l2 mm	l5 mm
2 - 56	2.80	2.10	1.85	45.00	5.00	14.50
4 - 40	3.50	2.70	2.35	56.00	7.00	18.00
6 - 32	4.00	3.00	2.85	56.00	8.00	20.00
8 - 32	4.50	3.40	3.50	63.00	8.00	21.00
10 - 24	6.00	4.90	3.90	70.00	11.00	25.00
1/4 - 20	7.00	5.50	5.10	80.00	13.00	30.00
5/16 - 18	8.00	6.20	6.60	90.00	14.00	35.00
3/8 - 16	10.00	8.00	8.00	100.00	16.00	39.00

Order no.	
1981 2.184	2865 2.184
1981 2.845	2865 2.845
1981 3.505	2865 3.505
1981 4.166	2865 4.166
1981 4.826	2865 4.826
1981 6.350	2865 6.350
1981 7.938	2865 7.938
1981 9.525	2865 9.525

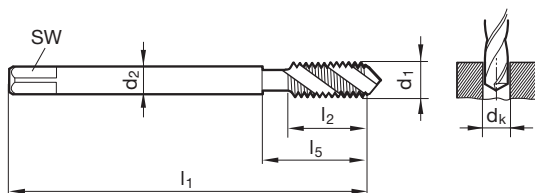

Standard
Article no.

~DIN 376	
1986	2866

d1	d2 mm	SW mm	dk mm	l1 mm	l2 mm	l5 mm
7/16 - 14	8.00	6.20	9.40	100.00	18.00	42.00
1/2 - 13	9.00	7.00	10.80	110.00	20.00	49.00
5/8 - 11	12.00	9.00	13.50	110.00	24.00	53.00
3/4 - 10	14.00	11.00	16.50	125.00	25.00	62.00
7/8 - 9	18.00	14.50	19.50	140.00	28.00	62.00

Order no.	
1986 11.113	2866 11.113
1986 12.700	2866 12.700
1986 15.875	2866 15.875
1986 19.050	2866 19.050
1986 22.225	2866 22.225



Taps with coolant ducts for UNC threads

Article no. **1085**



Cutting data page 962

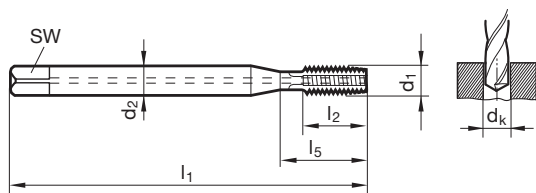

Standard **~DIN 371**
Article no. **1085**

d1	d2 mm	SW mm	dk mm	l1 mm	l2 mm	l5 mm
10 - 24	6.00	4.90	3.90	70.00	14.00	25.00
12 - 24	6.00	4.90	4.50	80.00	16.00	30.00
1/4 - 20	7.00	5.50	5.10	80.00	16.00	30.00
5/16 - 18	8.00	6.20	6.60	90.00	18.00	35.00
3/8 - 16	10.00	8.00	8.00	100.00	20.00	39.00

Order no.
1085 4.826
1085 5.486
1085 6.350
1085 7.938
1085 9.525

Taps

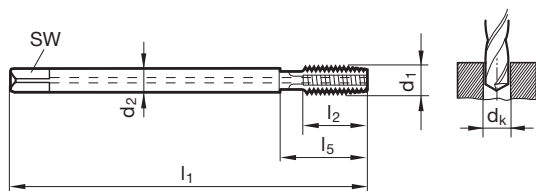

Standard **~DIN 376**
Article no. **1086**

d1	d2 mm	SW mm	dk mm	l1 mm	l2 mm	l5 mm
7/16 - 14	8.00	6.20	9.40	100.00	22.00	42.00
1/2 - 13	9.00	7.00	10.80	110.00	25.00	49.00
5/8 - 11	12.00	9.00	13.50	110.00	30.00	53.00
3/4 - 10	14.00	11.00	16.50	125.00	33.00	62.00
7/8 - 9	18.00	14.50	19.50	140.00	35.00	62.00

Order no.
1086 11.113
1086 12.700
1086 15.875
1086 19.050
1086 22.225



Taps for UNC threads

Article no. **2912**



HSS-E-PM C Ti R15 2BX R Cyl C 2xD

Cutting data page 966-967

P	M	K	N	S	H
				•	

S = Ti

Taps for UNC threads

Article no. **2922**



HSS-E-PM F Ni R10 2BX R Cyl C 2xD

Cutting data page 966-967

P	M	K	N	S	H
				•	

S = Ni

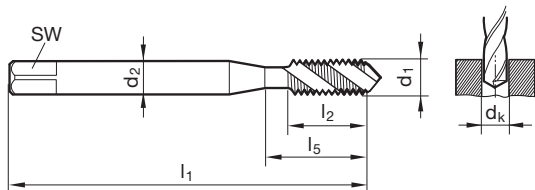

Standard
Article no.

~DIN 371/~DIN 376

2912 **2922**

Taps

d1	d2 mm	SW mm	dk mm	l1 mm	l2 mm	l5 mm		Order no.	
4 - 40	3.50	2.70	2.35	56.00	11.00	18.00	~DIN 371	2912 2.845	2922 2.845
5 - 40	3.50	2.70	2.65	56.00	11.00	18.00	~DIN 371	2912 3.175	2922 3.175
6 - 32	4.00	3.00	2.85	56.00	12.00	20.00	~DIN 371	2912 3.505	2922 3.505
8 - 32	4.50	3.40	3.50	63.00	12.00	21.00	~DIN 371	2912 4.166	2922 4.166
10 - 24	6.00	4.90	3.90	70.00	14.00	25.00	~DIN 371	2912 4.826	2922 4.826
12 - 24	6.00	4.90	4.50	80.00	16.00	30.00	~DIN 371	2912 5.486	2922 5.486
1/4 - 20	7.00	5.50	5.10	80.00	16.00	30.00	~DIN 371	2912 6.350	2922 6.350
5/16 - 18	8.00	6.20	6.60	90.00	18.00	35.00	~DIN 371	2912 7.938	2922 7.938
3/8 - 16	10.00	8.00	8.00	100.00	20.00	39.00	~DIN 371	2912 9.525	2922 9.525
7/16 - 14	8.00	6.20	9.40	100.00	22.00	42.00	~DIN 376	2912 11.113	2922 11.113
1/2 - 13	9.00	7.00	10.80	110.00	25.00	49.00	~DIN 376	2912 12.700	2922 12.700
5/8 - 11	12.00	9.00	13.50	110.00	30.00	53.00	~DIN 376	2912 15.875	2922 15.875



Taps for UNF threads

Article no. **1988**



Cutting data page 959

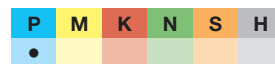

$P \leq 800 \text{ N/mm}^2$

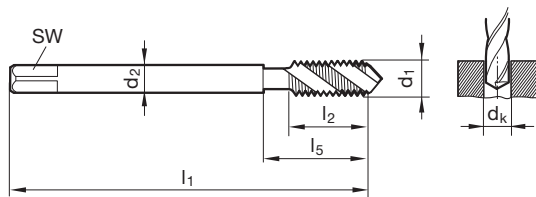

Standard **~DIN 374**
Article no. **1988**

d1	d2 mm	SW mm	dk mm	l1 mm	l2 mm	l5 mm	Order no.
1/4 - 28	4.50	3.40	5.50	80.00	9.50	30.00	1988 6.350
5/16 - 24	6.00	4.90	6.90	90.00	11.50	35.00	1988 7.938
3/8 - 24	7.00	5.50	8.50	90.00	11.50	35.00	1988 9.525
7/16 - 20	8.00	6.20	9.90	100.00	13.00	42.00	1988 11.113
1/2 - 20	9.00	7.00	11.50	100.00	13.00	40.00	1988 12.700
9/16 - 18	11.00	9.00	12.90	100.00	14.00	40.00	1988 14.288

Taps

Taps for UNF threads

Article no. **911**



Cutting data page 959

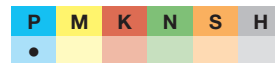

$P \leq 800 \text{ N/mm}^2$

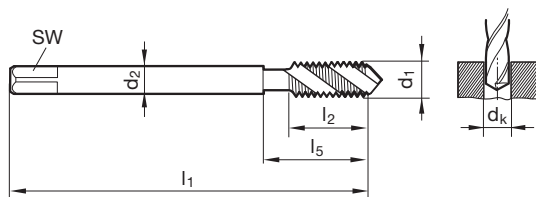

Standard **~DIN 374**
Article no. **911**

d1	d2 mm	SW mm	dk mm	l1 mm	l2 mm	l5 mm	Order no.
3 - 56	1.80	1.40	2.15	50.00	5.00	14.50	911 2.515
4 - 48	2.20	1.80	2.40	56.00	6.00	18.00	911 2.845
5 - 44	2.50	2.10	2.70	56.00	6.00	18.00	911 3.175
6 - 40	2.50	2.10	2.95	56.00	6.50	20.00	911 3.505
8 - 36	2.80	2.10	3.50	63.00	7.00	21.00	911 4.166
10 - 32	3.50	2.70	4.10	70.00	8.50	25.00	911 4.826
12 - 28	4.00	3.00	4.60	80.00	9.50	30.00	911 5.486
1/4 - 28	4.50	3.40	5.50	80.00	9.50	30.00	911 6.350
5/16 - 24	6.00	4.90	6.90	90.00	11.50	35.00	911 7.938
3/8 - 24	7.00	5.50	8.50	90.00	11.50	35.00	911 9.525
7/16 - 20	8.00	6.20	9.90	100.00	13.00	42.00	911 11.113
1/2 - 20	9.00	7.00	11.50	100.00	13.00	40.00	911 12.700
9/16 - 18	11.00	9.00	12.90	100.00	14.00	40.00	911 14.288
5/8 - 18	12.00	9.00	14.50	100.00	15.00	44.00	911 15.875
3/4 - 16	14.00	11.00	17.50	110.00	16.00	44.00	911 19.050
7/8 - 14	18.00	14.50	20.40	125.00	19.00	44.00	911 22.225
1 - 12	18.00	14.50	23.25	140.00	22.00	50.00	911 25.400

Taps for UNF threads

Article no. **2859**

Cutting data page 960

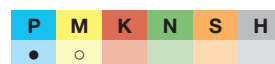
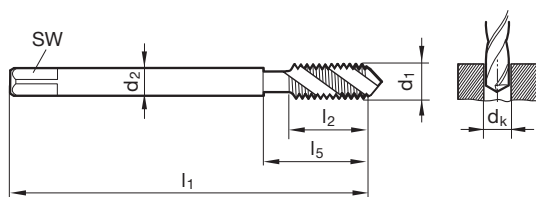
P ≤ 1000 N/mm²

Standard

~DIN 374

Article no.

2859

d1	d2 mm	SW mm	dk mm	l1 mm	l2 mm	l5 mm
10 - 32	3.50	2.70	4.10	70.00	8.50	25.00
1/4 - 28	4.50	3.40	5.50	80.00	9.50	30.00
5/16 - 24	6.00	4.90	6.90	90.00	11.50	35.00
3/8 - 24	7.00	5.50	8.50	90.00	11.50	35.00
7/16 - 20	8.00	6.20	9.90	100.00	13.00	42.00
1/2 - 20	9.00	7.00	11.50	100.00	13.00	40.00
5/8 - 18	12.00	9.00	14.50	100.00	15.00	44.00
7/8 - 14	18.00	14.50	20.40	125.00	19.00	44.00

Order no.

2859 4.826

2859 6.350

2859 7.938

2859 9.525

2859 11.113

2859 12.700

2859 15.875

2859 22.225

Taps

Taps for UNF threads

Article no. **1838**

bright correction

Cutting data page 960

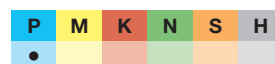
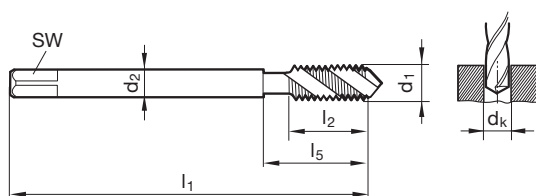
P ≤ 1000 N/mm²

Standard

~DIN 374

Article no.

1838

d1	d2 mm	SW mm	dk mm	l1 mm	l2 mm	l5 mm
10 - 32	3.50	2.70	4.10	70.00	8.50	25.00
1/4 - 28	4.50	3.40	5.50	80.00	9.50	30.00
5/16 - 24	6.00	4.90	6.90	90.00	11.50	35.00
3/8 - 24	7.00	5.50	8.50	90.00	11.50	35.00
7/16 - 20	8.00	6.20	9.90	100.00	13.00	42.00
1/2 - 20	9.00	7.00	11.50	100.00	13.00	40.00
5/8 - 18	12.00	9.00	14.50	100.00	15.00	44.00
7/8 - 14	18.00	14.50	20.40	125.00	19.00	44.00
1 - 12	18.00	14.50	23.25	140.00	22.00	50.00

Order no.

1838 4.826

1838 6.350

1838 7.938

1838 9.525

1838 11.113

1838 12.700

1838 15.875

1838 22.225

1838 25.400



Taps for UNF threads

Article no. **1991**



Cutting data page 964



P ≤ 1000 N/mm²

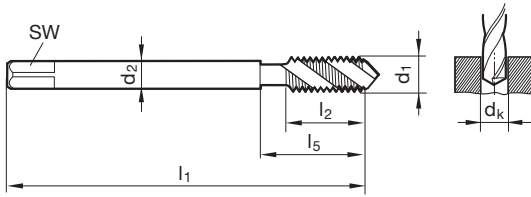

Standard

~DIN 374

Article no.

1991

Taps

	d1	d2	SW	dk	l1	l2	l5	Order no.
		mm	mm	mm	mm	mm	mm	
	10 - 32	3.50	2.70	4.10	70.00	8.50	25.00	1991 4.826
	1/4 - 28	4.50	3.40	5.50	80.00	9.50	30.00	1991 6.350
	5/16 - 24	6.00	4.90	6.90	90.00	11.50	35.00	1991 7.938
	3/8 - 24	7.00	5.50	8.50	90.00	11.50	35.00	1991 9.525
	7/16 - 20	8.00	6.20	9.90	100.00	13.00	42.00	1991 11.113
	1/2 - 20	9.00	7.00	11.50	100.00	13.00	40.00	1991 12.700
	5/8 - 18	12.00	9.00	14.50	100.00	15.00	44.00	1991 15.875



Taps for UNF threads

Article no. 2867



Cutting data page 964

HSS-E VAR40 2B R Cyl C 3xD

P	M	K	N	S	H
	•		○		

Taps for UNF threads

Article no. 2868



Cutting data page 964

HSS-E VAR40 2B R Cyl C 3xD

P	M	K	N	S	H
	•		○		

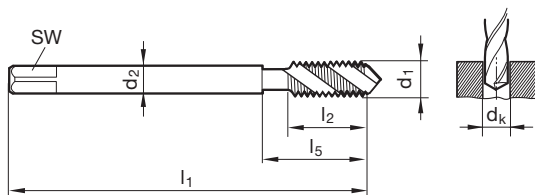

Standard Article no.

~DIN 374	
2867	2868

Taps

d1	d2 mm	SW mm	dk mm	l1 mm	l2 mm	l5 mm
10 - 32	3.50	2.70	4.10	70.00	8.50	25.00
12 - 28	4.00	3.00	4.60	80.00	9.50	30.00
1/4 - 28	4.50	3.40	5.50	80.00	9.50	30.00
5/16 - 24	6.00	4.90	6.90	90.00	11.50	35.00
3/8 - 24	7.00	5.50	8.50	90.00	11.50	35.00
7/16 - 20	8.00	6.20	9.90	100.00	13.00	42.00
1/2 - 20	9.00	7.00	11.50	100.00	13.00	40.00
5/8 - 18	12.00	9.00	14.50	100.00	15.00	44.00
7/8 - 14	18.00	14.50	20.40	125.00	19.00	44.00

Order no.	
2867 4.826	2868 4.826
2867 5.486	2868 5.486
2867 6.350	2868 6.350
2867 7.938	2868 7.938
2867 9.525	2868 9.525
2867 11.113	2868 11.113
2867 12.700	2868 12.700
2867 15.875	2868 15.875
2867 22.225	2868 22.225



Taps with coolant ducts for UNF threads

Article no. **1082**



Cutting data page 962

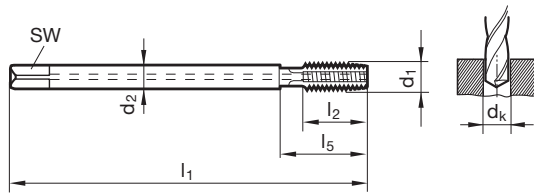

Standard

~DIN 374

Article no.

1082

Taps

d1	d2 mm	SW mm	dk mm	l1 mm	l2 mm	l5 mm	Order no.
10 - 32	3.50	2.70	4.10	70.00	14.00	25.00	1082 4.826
12 - 28	4.00	3.00	4.60	80.00	16.00	30.00	1082 5.486
1/4 - 28	4.50	3.40	5.50	80.00	16.00	30.00	1082 6.350
5/16 - 24	6.00	4.90	6.90	90.00	17.00	35.00	1082 7.938
3/8 - 24	7.00	5.50	8.50	90.00	18.00	35.00	1082 9.525
7/16 - 20	8.00	6.20	9.90	100.00	22.00	42.00	1082 11.113
1/2 - 20	9.00	7.00	11.50	100.00	20.00	40.00	1082 12.700
5/8 - 18	12.00	9.00	14.50	100.00	22.00	44.00	1082 15.875
3/4 - 16	14.00	11.00	17.50	110.00	25.00	44.00	1082 19.050
7/8 - 14	18.00	14.50	20.40	125.00	25.00	44.00	1082 22.225



Taps for UNF threads

Article no. **2914**



HSS-E-PM C Ti R15 2BX R Cyl C 2xD

Cutting data page 966-967

P	M	K	N	S	H
				•	

S = Ti

Taps for UNF threads

Article no. **2923**



HSS-E-PM F Ni R10 2BX R Cyl C 2xD

Cutting data page 966-967

P	M	K	N	S	H
				•	

S = Ni

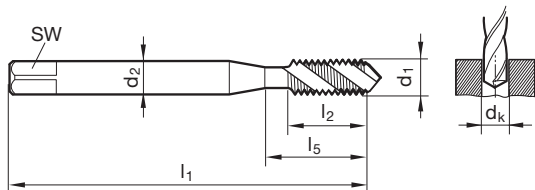

Standard
Article no.

~DIN 371/~DIN 374	
2914	2923

Taps

d1	d2 mm	SW mm	dk mm	l1 mm	l2 mm	l5 mm	Standard	Order no.	
4 - 48	3.50	2.70	2.40	56.00	10.00	18.00	~DIN 371	2914 2.845	2923 2.845
5 - 44	3.50	2.70	2.70	56.00	10.00	18.00	~DIN 371	2914 3.175	2923 3.175
6 - 40	4.00	3.00	2.95	56.00	11.00	20.00	~DIN 371	2914 3.505	2923 3.505
8 - 36	4.50	3.40	3.50	63.00	12.00	21.00	~DIN 371	2914 4.166	2923 4.166
10 - 32	6.00	4.90	4.10	70.00	14.00	25.00	~DIN 371	2914 4.826	2923 4.826
12 - 28	6.00	4.90	4.60	80.00	16.00	30.00	~DIN 371	2914 5.486	2923 5.486
1/4 - 28	7.00	5.50	5.50	80.00	16.00	30.00	~DIN 371	2914 6.350	2923 6.350
5/16 - 24	8.00	6.20	6.90	90.00	17.00	35.00	~DIN 371	2914 7.938	2923 7.938
3/8 - 24	10.00	8.00	8.50	90.00	18.00	35.00	~DIN 371	2914 9.525	2923 9.525
7/16 - 20	8.00	6.20	9.90	100.00	22.00	42.00	~DIN 374	2914 11.113	2923 11.113
1/2 - 20	9.00	7.00	11.50	100.00	20.00	40.00	~DIN 374	2914 12.700	2923 12.700
5/8 - 18	12.00	9.00	14.50	100.00	22.00	44.00	~DIN 374	2914 15.875	2923 15.875



Taps for BSP threads

Article no. **964**



Cutting data page 959

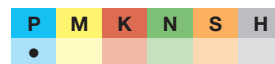

$P \leq 800 \text{ N/mm}^2$

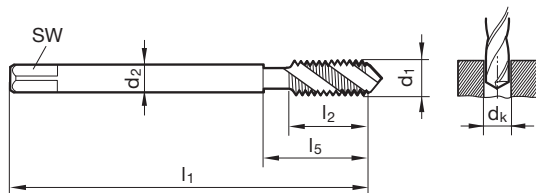

Standard **DIN 5156**
Article no. **964**

d1	P G/inch	d2 mm	SW mm	dk mm	l1 mm	l2 mm	l5 mm	Order no.
G1/8	28	7.00	5.50	8.80	90.00	11.00	35.00	964 9.728
G1/4	19	11.00	9.00	11.80	100.00	14.00	40.00	964 13.157
G3/8	19	12.00	9.00	15.25	100.00	14.00	44.00	964 16.662
G1/2	14	16.00	12.00	19.00	125.00	18.00	44.00	964 20.955
G3/4	14	20.00	16.00	24.50	140.00	20.00	53.00	964 26.441
G1	11	25.00	20.00	30.75	160.00	24.00	56.00	964 33.249

Taps

Taps for BSP threads

Article no. **965**



Cutting data page 959

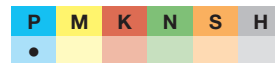

$P \leq 800 \text{ N/mm}^2$

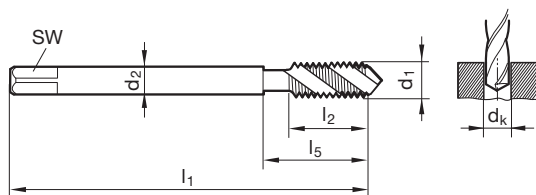

Standard **DIN 5156**
Article no. **965**

d1	P G/inch	d2 mm	SW mm	dk mm	l1 mm	l2 mm	l5 mm	Order no.
G1/8	28	7.00	5.50	8.80	90.00	11.00	35.00	965 9.728
G1/4	19	11.00	9.00	11.80	100.00	14.00	40.00	965 13.157
G3/8	19	12.00	9.00	15.25	100.00	14.00	44.00	965 16.662
G1/2	14	16.00	12.00	19.00	125.00	18.00	44.00	965 20.955
G3/4	14	20.00	16.00	24.50	140.00	20.00	53.00	965 26.441
G1	11	25.00	20.00	30.75	160.00	24.00	56.00	965 33.249
G1 1/4	11	32.00	24.00	39.50	170.00	25.00	57.00	965 41.910
G1 1/2	11	36.00	29.00	45.25	190.00	27.00	60.00	965 47.803



Taps for BSP threads

Article no. 4158

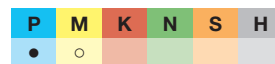
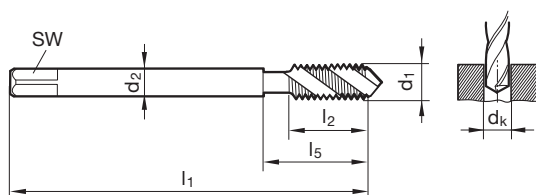

Cutting data page 960

P ≤ 1000 N/mm²

Standard

DIN 5156

Article no.

4158

d1	P G/inch	d2 mm	SW mm	dk mm	l1 mm	l2 mm	l5 mm	Order no.
G1/16	28	6.00	4.90	6.80	90.00	11.00	30.00	4158 7.723
G1/8	28	7.00	5.50	8.80	90.00	11.00	35.00	4158 9.728
G1/4	19	11.00	9.00	11.80	100.00	14.00	40.00	4158 13.157
G3/8	19	12.00	9.00	15.25	100.00	14.00	44.00	4158 16.662
G1/2	14	16.00	12.00	19.00	125.00	18.00	44.00	4158 20.955
G3/4	14	20.00	16.00	24.50	140.00	20.00	53.00	4158 26.441
G1	11	25.00	20.00	30.75	160.00	24.00	56.00	4158 33.249

Taps



Taps for BSP threads

Article no. **2861**



Cutting data page 960

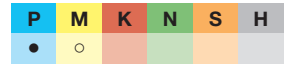

P ≤ 1000 N/mm²

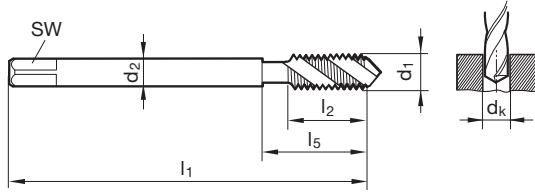

Standard **DIN 5156**
Article no. **2861**

Taps

d1	P G/inch	d2 mm	SW mm	dk mm	l1 mm	l2 mm	l5 mm	Order no.
G1/8	28	7.00	5.50	8.80	90.00	11.00	35.00	2861 9.728
G1/4	19	11.00	9.00	11.80	100.00	14.00	40.00	2861 13.157
G3/8	19	12.00	9.00	15.25	100.00	14.00	44.00	2861 16.662
G1/2	14	16.00	12.00	19.00	125.00	18.00	44.00	2861 20.955
G3/4	14	20.00	16.00	24.50	140.00	20.00	53.00	2861 26.441
G1	11	25.00	20.00	30.75	160.00	24.00	56.00	2861 33.249
G1 1/4	11	32.00	24.00	39.50	170.00	25.00	57.00	2861 41.910
G1 1/2	11	36.00	29.00	45.25	190.00	27.00	60.00	2861 47.803
G2	11	45.00	35.00	57.00	220.00	32.00	95.00	2861 59.614

Taps for BSP threads

Article no. **937**



Cutting data page 960

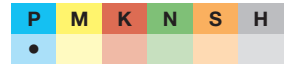

bright correction

P ≤ 1000 N/mm²

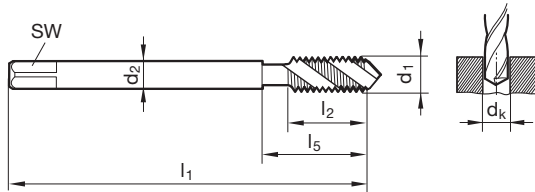

Standard **DIN 5156**
Article no. **937**

d1	P G/inch	d2 mm	SW mm	dk mm	l1 mm	l2 mm	l5 mm	Order no.
G1/8	28	7.00	5.50	8.80	90.00	11.00	35.00	937 9.728
G1/4	19	11.00	9.00	11.80	100.00	14.00	40.00	937 13.157
G3/8	19	12.00	9.00	15.25	100.00	14.00	44.00	937 16.662
G1/2	14	16.00	12.00	19.00	125.00	18.00	44.00	937 20.955
G3/4	14	20.00	16.00	24.50	140.00	20.00	53.00	937 26.441
G1	11	25.00	20.00	30.75	160.00	24.00	56.00	937 33.249

Taps for BSP threads

Article no. 4797

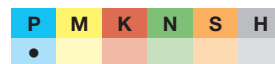
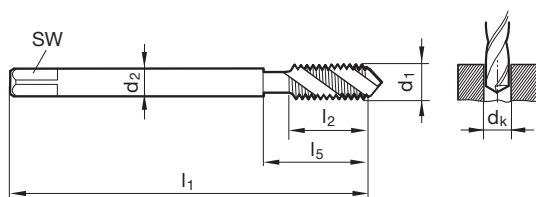

Cutting data page 961

P ≤ 1200 N/mm²

Standard

DIN 5156

Article no.

4797

d1	P G/inch	d2 mm	SW mm	dk mm	l1 mm	l2 mm	l5 mm	Order no.
G1/16	28	6.00	4.90	6.80	90.00	11.00	30.00	4797 7.723
G1/8	28	7.00	5.50	8.80	90.00	11.00	35.00	4797 9.728
G1/4	19	11.00	9.00	11.80	100.00	14.00	40.00	4797 13.157
G3/8	19	12.00	9.00	15.25	100.00	14.00	44.00	4797 16.662
G1/2	14	16.00	12.00	19.00	125.00	18.00	44.00	4797 20.955
G3/4	14	20.00	16.00	24.50	140.00	20.00	53.00	4797 26.441
G1	11	25.00	20.00	30.75	160.00	24.00	56.00	4797 33.249

Taps



Taps for BSP threads

Article no. **4799**



Cutting data page 964



P	M	K	N	S	H
	●		○		

Taps for BSP threads

Article no. **968**



Cutting data page 964



P	M	K	N	S	H
	●		○		

Taps

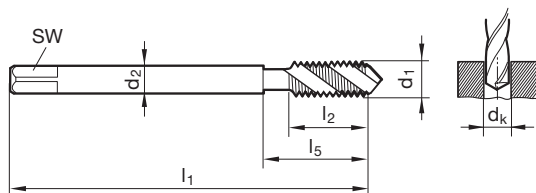

Standard
Article no.

DIN 5156

4799

968

d1	P G/inch	d2 mm	SW mm	dk mm	l1 mm	l2 mm	l5 mm
G1/16	28	6.00	4.90	6.80	90.00	11.00	30.00
G1/8	28	7.00	5.50	8.80	90.00	11.00	35.00
G1/4	19	11.00	9.00	11.80	100.00	14.00	40.00
G3/8	19	12.00	9.00	15.25	100.00	14.00	44.00
G1/2	14	16.00	12.00	19.00	125.00	18.00	44.00
G3/4	14	20.00	16.00	24.50	140.00	20.00	53.00
G1	11	25.00	20.00	30.75	160.00	24.00	56.00
G1 1/4	11	32.00	24.00	39.50	170.00	25.00	57.00
G1 1/2	11	36.00	29.00	45.25	190.00	27.00	60.00

Order no.

4799 7.723	968 7.723
4799 9.728	968 9.728
4799 13.157	968 13.157
4799 16.662	968 16.662
4799 20.955	968 20.955
4799 26.441	968 26.441
4799 33.249	968 33.249
4799 41.910	968 41.910
4799 47.803	968 47.803



Taps for BSP threads

Article no. 4159



Cutting data page 964



Synchronous tap

P	M	K	N	S	H
●	●	●	○		

P ≤ 1000 N/mm²

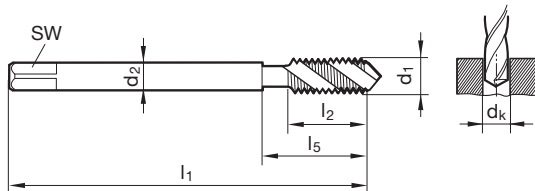

Standard	DIN 5156
Article no.	4159

d1	P	d2	SW	dk	l1	l2	l5	Order no.
	G/inch	mm	mm	mm	mm	mm	mm	
G1/8	28	7.00	5.50	8.80	90.00	4.50	35.00	4159 9.728
G1/4	19	11.00	9.00	11.80	100.00	6.70	40.00	4159 13.157
G3/8	19	12.00	9.00	15.25	100.00	6.70	44.00	4159 16.662
G1/2	14	16.00	12.00	19.00	125.00	9.10	44.00	4159 20.955

Taps

Taps for Rc (BSPT) threads

Article no. 4683



Cutting data page 961



P	M	K	N	S	H
●		●	○		

P ≤ 1200 N/mm²

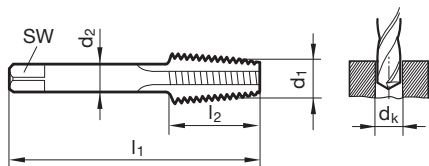

Standard	DIN 5156
Article no.	4683

d1	P	d2	SW	dk	l1	l2	l5	Order no.
	G/inch	mm	mm	mm	mm	mm	mm	
Rc1/8	28	7.00	5.50	8.20	90.00	18.00	35.00	4683 9.728
Rc1/4	19	11.00	9.00	10.85	100.00	20.00	40.00	4683 13.157
Rc3/8	19	12.00	9.00	14.30	100.00	22.00	44.00	4683 16.662
Rc1/2	14	16.00	12.00	17.80	125.00	25.00	44.00	4683 20.955
Rc3/4	14	20.00	16.00	23.20	140.00	28.00	53.00	4683 26.441
Rc1	11	25.00	20.00	29.20	160.00	30.00	56.00	4683 33.249



Taps for NPT threads

Article no. **1087**



Cutting data page 964

P	M	K	N	S	H
●	●	○	○		

P ≤ 1000 N/mm²

Taps for NPT threads

Article no. **1088**



Cutting data page 964

P	M	K	N	S	H
●	●	○	○		

P ≤ 1000 N/mm²

Taps

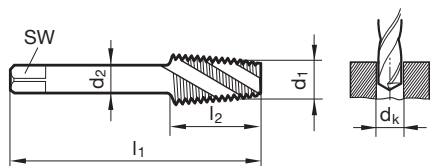

Standard
Article no.

Company std.

1087 1088

d1	P G/inch	d2 mm	SW mm	dk mm	l1 mm	l2 mm	l5 mm	Order no.	
1/16 NPT	27	8.00	6.20	6.25	90.00	14.00	27.00	1087 8.190	1088 8.190
1/8 NPT	27	11.00	9.00	8.50	90.00	15.00	29.00	1087 10.620	1088 10.620
1/4 NPT	18	14.00	11.00	11.20	100.00	21.00	40.00	1087 14.140	1088 14.140
3/8 NPT	18	16.00	12.00	14.40	110.00	21.00	35.00	1087 17.570	1088 17.570
1/2 NPT	14	18.00	14.50	18.00	125.00	27.00	44.00	1087 21.900	1088 21.900
3/4 NPT	14	22.00	18.00	23.40	140.00	27.00	52.00	1087 27.230	1088 27.230
1 NPT	11	25.00	20.00	29.10	170.00	32.00	53.00	1087 34.180	1088 34.180

Taps for NPTF threads

Article no. **4127**



Cutting data page 964

P	M	K	N	S	H
●	●	○	○		

P ≤ 1000 N/mm²

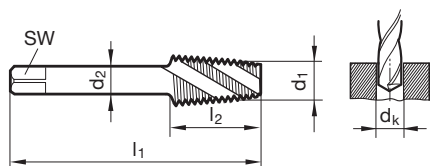

Standard
Article no.

Company std.

4127

d1	P G/inch	d2 mm	SW mm	dk mm	l1 mm	l2 mm	l5 mm	Order no.	
1/16 NPTF	27	8.00	6.20	6.25	90.00	14.00	27.00	4127 8.190	
1/8 NPTF	27	11.00	9.00	8.50	90.00	15.00	29.00	4127 10.620	
1/4 NPTF	18	14.00	11.00	11.20	100.00	21.00	40.00	4127 14.140	
3/8 NPTF	18	16.00	12.00	14.40	110.00	21.00	35.00	4127 17.570	
1/2 NPTF	14	18.00	14.50	18.00	125.00	27.00	44.00	4127 21.900	
3/4 NPTF	14	22.00	18.00	23.40	140.00	27.00	52.00	4127 27.230	
1 NPTF	11	25.00	20.00	29.10	170.00	32.00	53.00	4127 34.180	

Taps for EG threads

Article no. 1011

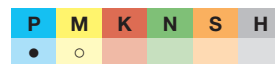
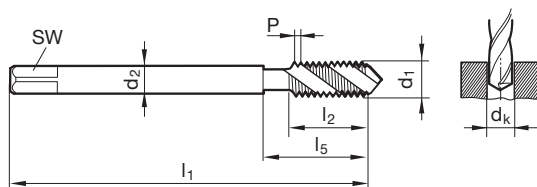

Cutting data page 960

P ≤ 1000 N/mm²

Standard

DIN 40435

Article no.

1011

d1	P	d2	SW	dk	l1	l2	l5	Order no.
mm	mm	mm	mm	mm	mm	mm	mm	
EG/STI M3	0.500	4.50	3.40	3.15	63.00	6.00	21.00	1011 3.000
EG/STI M4	0.700	6.00	4.90	4.20	70.00	7.50	25.00	1011 4.000
EG/STI M5	0.800	6.00	4.90	5.25	80.00	8.50	30.00	1011 5.000
EG/STI M6	1.000	8.00	6.20	6.30	90.00	11.00	35.00	1011 6.000
EG/STI M8	1.250	10.00	8.00	8.40	100.00	14.00	39.00	1011 8.000
EG/STI M10	1.500	9.00	7.00	10.50	100.00	16.00	40.00	1011 10.000
EG/STI M12	1.750	11.00	9.00	12.50	110.00	18.50	53.00	1011 12.000
EG/STI M14	2.000	12.00	9.00	14.50	110.00	20.00	54.00	1011 14.000
EG/STI M16	2.000	14.00	11.00	16.50	125.00	20.00	62.00	1011 16.000

Taps



Taps for MJ threads

Article no. **1061**



Cutting data page 966-967

P	M	K	N	S	H
				•	

S = Ti

Taps for MJ threads

Article no. **1065**



Cutting data page 966-967

P	M	K	N	S	H
				•	

S = Ni

Taps

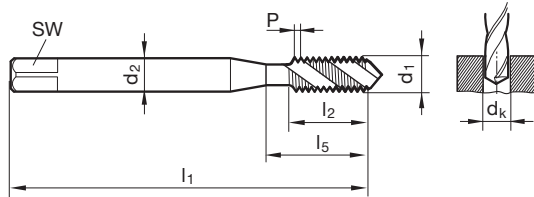

Standard
Article no.

DIN 371/DIN 376

1061	1065
-------------	-------------

d1	P mm	d2 mm	SW mm	dk mm	l1 mm	l2 mm	l5 mm	Standard	Order no.	
MJ3 x 0,5	0.500	3.50	2.70	2.60	56.00	10.00	18.00	DIN 371	1061 3.000	1065 3.000
MJ4 x 0,7	0.700	4.50	3.40	3.40	63.00	12.00	21.00	DIN 371	1061 4.000	1065 4.000
MJ5 x 0,8	0.800	6.00	4.90	4.30	70.00	14.00	25.00	DIN 371	1061 5.000	1065 5.000
MJ6 x 1,0	1.000	6.00	4.90	5.10	80.00	16.00	30.00	DIN 371	1061 6.000	1065 6.000
MJ8 x 1,25	1.250	8.00	6.20	6.90	90.00	17.00	35.00	DIN 371	1061 8.000	1065 8.000
MJ10 x 1,5	1.500	10.00	8.00	8.60	100.00	20.00	39.00	DIN 371	1061 10.000	1065 10.000
MJ12 x 1,5	1.750	9.00	7.00	10.40	110.00	24.00	49.00	DIN 376	1061 12.000	1065 12.000
MJ16 x 2,0	2.000	12.00	9.00	14.20	110.00	26.00	54.00	DIN 376	1061 16.000	1065 16.000

Taps for MJF threads

Article no. **1062**



Cutting data page 966-967

P	M	K	N	S	H
				•	

S = Ti

Taps for MJF threads

Article no. **1066**



Cutting data page 966-967

P	M	K	N	S	H
				•	

S = Ni

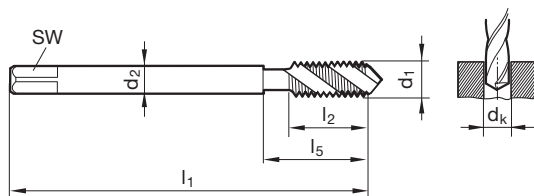

Standard
Article no.

DIN 371

1062	1066
-------------	-------------

d1	d2 mm	SW mm	dk mm	l1 mm	l2 mm	l5 mm	Standard	Order no.	
MJF6 x 0,5	6.00	4.90	5.60	80.00	11.00	30.00	DIN 371	1062 6.003	1066 6.003
MJF6 x 0,75	6.00	4.90	5.40	80.00	11.00	30.00	DIN 371	1062 6.004	1066 6.004
MJF8 x 0,5	8.00	6.20	7.60	80.00	14.00	30.00	DIN 371		1066 8.003
MJF8 x 0,75	8.00	6.20	7.40	80.00	14.00	30.00	DIN 371	1062 8.004	1066 8.004
MJF8 x 1,0	8.00	6.20	7.10	90.00	14.00	35.00	DIN 371	1062 8.005	1066 8.005
MJF10 x 1,0	10.00	8.00	9.10	90.00	16.00	35.00	DIN 371	1062 10.005	1066 10.005
MJF10 x 1,25	10.00	8.00	8.90	100.00	20.00	39.00	DIN 371	1062 10.006	1066 10.006

Taps for UNJC threads

Article no. 1063



Cutting data page 966-967

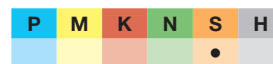

S = Ti

Taps for UNJC threads

Article no. 1067



Cutting data page 966-967

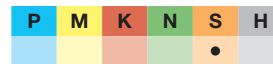

S = Ni

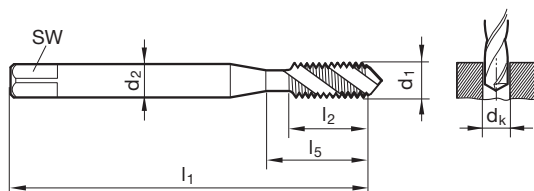
Standard
Article no.

~DIN 371/~DIN 376

1063 1067

d1	d2 mm	SW mm	dk mm	l1 mm	l2 mm	l5 mm	Standard	Order no.
6 - 32	4.00	3.00	2.85	56.00	12.00	20.00	~DIN 371	1063 3.505 1067 3.505
8 - 32	4.50	3.40	3.50	63.00	12.00	21.00	~DIN 371	1063 4.166 1067 4.166
10 - 24	6.00	4.90	3.90	70.00	14.00	25.00	~DIN 371	1063 4.826 1067 4.826
12 - 24	6.00	4.90	4.50	80.00	16.00	30.00	~DIN 371	1063 5.486 1067 5.486
1/4 - 20	7.00	5.50	5.10	80.00	16.00	30.00	~DIN 371	1063 6.350 1067 6.350
5/16 - 18	8.00	6.20	6.60	90.00	18.00	35.00	~DIN 371	1063 7.938 1067 7.938
3/8 - 16	10.00	8.00	8.00	100.00	20.00	39.00	~DIN 371	1063 9.525 1067 9.525
7/16 - 14	8.00	6.20	9.40	100.00	22.00	42.00	~DIN 376	1063 11.113 1067 11.113
1/2 - 13	9.00	7.00	10.80	110.00	25.00	49.00	~DIN 376	1063 12.700 1067 12.700
5/8 - 11	12.00	9.00	13.50	110.00	30.00	53.00	~DIN 376	1063 15.875 1067 15.875

Taps

Taps for UNJF threads

Article no. 1064



Cutting data page 966-967

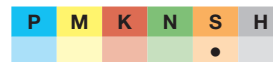

S = Ti

Taps for UNJF threads

Article no. 1068



Cutting data page 966-967

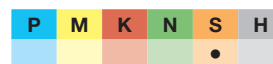

S = Ni

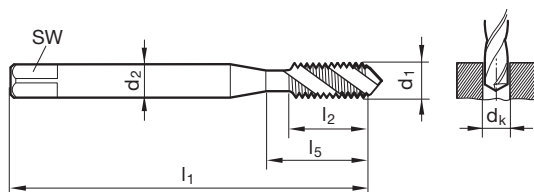
Standard
Article no.

~DIN 371/~DIN 374

1064 1068

d1	d2 mm	SW mm	dk mm	l1 mm	l2 mm	l5 mm	Standard	Order no.
6 - 40	4.00	3.00	2.95	56.00	11.00	20.00	~DIN 371	1064 3.505 1068 3.505
8 - 36	4.50	3.40	3.50	63.00	12.00	21.00	~DIN 371	1064 4.166 1068 4.166
10 - 32	6.00	4.90	4.10	70.00	14.00	25.00	~DIN 371	1064 4.826 1068 4.826
12 - 28	6.00	4.90	4.60	80.00	16.00	30.00	~DIN 371	1064 5.486 1068 5.486
1/4 - 28	7.00	5.50	5.50	80.00	16.00	30.00	~DIN 371	1064 6.350 1068 6.350
5/16 - 24	8.00	6.20	6.90	90.00	17.00	35.00	~DIN 371	1064 7.938 1068 7.938
3/8 - 24	10.00	8.00	8.50	100.00	18.00	39.00	~DIN 371	1064 9.525 1068 9.525
7/16 - 20	8.00	6.20	9.90	100.00	22.00	42.00	~DIN 374	1064 11.113 1068 11.113
1/2 - 20	9.00	7.00	11.50	100.00	20.00	40.00	~DIN 374	1064 12.700 1068 12.700
5/8 - 18	12.00	9.00	14.50	100.00	22.00	44.00	~DIN 374	1064 15.875 1068 15.875



Taps for ISO metric threads

Article no. **806**



Cutting data page 959

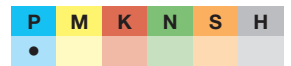

$P \leq 800 \text{ N/mm}^2$

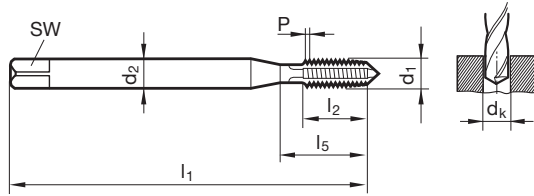

Standard **DIN 371**
Article no. **806**

Taps

d1	P mm	d2 mm	SW mm	dk mm	l1 mm	l2 mm	l5 mm	Order no.
M1	0.250	2.50	2.10	0.75	40.00	4.00	4.00	806 1.000
M1,2	0.250	2.50	2.10	0.95	40.00	4.80	4.80	806 1.200
M1,4	0.300	2.50	2.10	1.10	40.00	5.60	5.60	806 1.400
M1,6	0.350	2.50	2.10	1.25	40.00	6.40	6.40	806 1.600
M1,7	0.350	2.50	2.10	1.35	40.00	6.80	6.80	806 1.700
M1,8	0.350	2.50	2.10	1.45	40.00	7.30	7.30	806 1.800
M2	0.400	2.80	2.10	1.60	45.00	4.50	13.50	806 2.000
M2,2	0.450	2.80	2.10	1.75	45.00	5.00	14.50	806 2.200
M2,3	0.400	2.80	2.10	1.90	45.00	4.50	14.50	806 2.300
M2,5	0.450	2.80	2.10	2.05	50.00	5.00	14.50	806 2.500
M2,6	0.450	2.80	2.10	2.15	50.00	5.00	14.50	806 2.600
M3	0.500	3.50	2.70	2.50	56.00	6.00	18.00	806 3.000
M3,5	0.600	4.00	3.00	2.90	56.00	7.00	20.00	806 3.500
M4	0.700	4.50	3.40	3.30	63.00	7.50	21.00	806 4.000
M5	0.800	6.00	4.90	4.20	70.00	8.50	25.00	806 5.000
M6	1.000	6.00	4.90	5.00	80.00	11.00	30.00	806 6.000
M8	1.250	8.00	6.20	6.80	90.00	14.00	35.00	806 8.000
M10	1.500	10.00	8.00	8.50	100.00	16.00	39.00	806 10.000

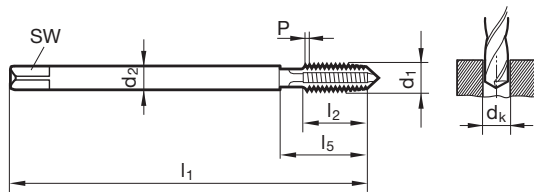

Standard **DIN 376**
Article no. **818**

d1	P mm	d2 mm	SW mm	dk mm	l1 mm	l2 mm	l5 mm	Order no.
M1,6	0.350	1.20	2.10	1.25	40.00	4.50	12.50	818 1.600
M1,7	0.350	1.20	2.10	1.35	40.00	4.50	12.50	818 1.700
M2	0.400	1.40	1.25	1.60	45.00	4.50	13.50	818 2.000
M2,5	0.450	1.80	1.40	2.05	50.00	5.00	14.50	818 2.500
M2,6	0.450	1.80	1.40	2.15	50.00	5.00	14.50	818 2.600
M3	0.500	2.20	1.80	2.50	56.00	6.00	18.00	818 3.000
M3,5	0.600	2.50	2.10	2.90	56.00	7.00	20.00	818 3.500
M4	0.700	2.80	2.10	3.30	63.00	7.50	21.00	818 4.000
M5	0.800	3.50	2.70	4.20	70.00	8.50	25.00	818 5.000
M6	1.000	4.50	3.40	5.00	80.00	11.00	30.00	818 6.000
M8	1.250	6.00	4.90	6.80	90.00	14.00	35.00	818 8.000
M10	1.500	7.00	5.50	8.50	100.00	16.00	39.00	818 10.000
M12	1.750	9.00	7.00	10.20	110.00	18.50	49.00	818 12.000
M14	2.000	11.00	9.00	12.00	110.00	20.00	53.00	818 14.000
M16	2.000	12.00	9.00	14.00	110.00	20.00	54.00	818 16.000
M18	2.500	14.00	11.00	15.50	125.00	25.00	62.00	818 18.000
M20	2.500	16.00	12.00	17.50	140.00	25.00	62.00	818 20.000
M22	2.500	18.00	14.50	19.50	140.00	27.00	62.00	818 22.000
M24	3.000	18.00	14.50	21.00	160.00	30.00	73.00	818 24.000
M27	3.000	20.00	16.00	24.00	160.00	30.00	73.00	818 27.000
M30	3.500	22.00	18.00	26.50	180.00	35.00	85.00	818 30.000
M36	4.000	28.00	22.00	32.00	200.00	40.00	102.00	818 36.000
M42	4.500	32.00	24.00	37.50	200.00	45.00	112.00	818 42.000
M48	5.000	36.00	29.00	43.00	250.00	50.00	127.00	818 48.000



Taps for ISO metric threads

Article no. **795**



Cutting data page 959

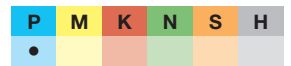

$P \leq 800 \text{ N/mm}^2$

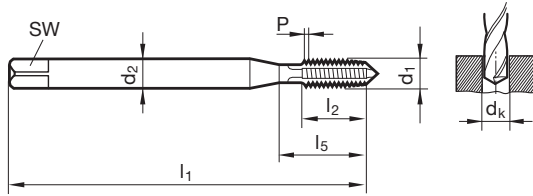

Standard	DIN 371
Article no.	795

d1	P mm	d2 mm	SW mm	dk mm	l1 mm	l2 mm	l5 mm	Order no.
M3	0.500	3.50	2.70	2.50	56.00	6.00	18.00	795 3.000
M4	0.700	4.50	3.40	3.30	63.00	7.50	21.00	795 4.000
M5	0.800	6.00	4.90	4.20	70.00	8.50	25.00	795 5.000
M6	1.000	6.00	4.90	5.00	80.00	11.00	30.00	795 6.000
M8	1.250	8.00	6.20	6.80	90.00	14.00	35.00	795 8.000
M10	1.500	10.00	8.00	8.50	100.00	16.00	39.00	795 10.000

Taps



Through- and blind holes

Taps for ISO metric threads

Article no. **807**



Cutting data page 962



Taps for ISO metric threads

Article no. **1918**



Cutting data page 962

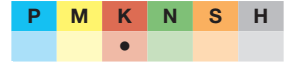

Taps

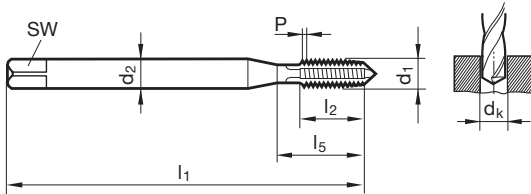

Standard
Article no.

DIN 371	
807	1918

d1	P mm	d2 mm	SW mm	dk mm	l1 mm	l2 mm	l5 mm
M3	0.500	3.50	2.70	2.50	56.00	10.00	18.00
M3,5	0.600	4.00	3.00	2.90	56.00	12.00	20.00
M4	0.700	4.50	3.40	3.30	63.00	12.00	21.00
M5	0.800	6.00	4.90	4.20	70.00	14.00	25.00
M6	1.000	6.00	4.90	5.00	80.00	16.00	30.00
M8	1.250	8.00	6.20	6.80	90.00	17.00	35.00
M10	1.500	10.00	8.00	8.50	100.00	20.00	39.00

Order no.	
807 3.000	1918 3.000
807 3.500	1918 3.500
807 4.000	1918 4.000
807 5.000	1918 5.000
807 6.000	1918 6.000
807 8.000	1918 8.000
807 10.000	1918 10.000

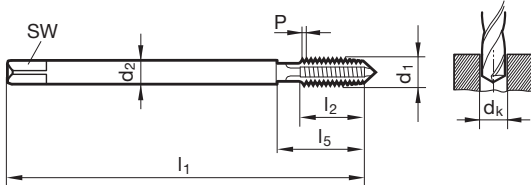

Standard
Article no.

DIN 376	
819	1919

d1	P mm	d2 mm	SW mm	dk mm	l1 mm	l2 mm	l5 mm
M3	0.500	2.20	1.80	2.50	56.00	10.00	18.00
M4	0.700	2.80	2.10	3.30	63.00	12.00	21.00
M5	0.800	3.50	2.70	4.20	70.00	14.00	25.00
M6	1.000	4.50	3.40	5.00	80.00	16.00	30.00
M8	1.250	6.00	4.90	6.80	90.00	17.00	35.00
M10	1.500	7.00	5.50	8.50	100.00	20.00	39.00
M12	1.750	9.00	7.00	10.20	110.00	24.00	49.00
M14	2.000	11.00	9.00	12.00	110.00	26.00	53.00
M16	2.000	12.00	9.00	14.00	110.00	26.00	54.00
M18	2.500	14.00	11.00	15.50	125.00	30.00	62.00
M20	2.500	16.00	12.00	17.50	140.00	32.00	62.00
M22	2.500	18.00	14.50	19.50	140.00	32.00	62.00
M24	3.000	18.00	14.50	21.00	160.00	36.00	73.00
M30	3.500	22.00	18.00	26.50	180.00	40.00	85.00

Order no.	
819 3.000	1919 3.000
819 4.000	1919 4.000
819 5.000	1919 5.000
819 6.000	1919 6.000
819 8.000	1919 8.000
819 10.000	1919 10.000
819 12.000	1919 12.000
819 14.000	1919 14.000
819 16.000	1919 16.000
819 18.000	1919 18.000
819 20.000	1919 20.000
819 22.000	1919 22.000
819 24.000	1919 24.000
819 30.000	1919 30.000



Taps for ISO metric threads

Article no. 1201



Cutting data page 965



for hard machining 45-55 HRC

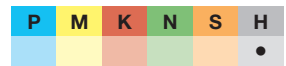

H = 45-55 HRC

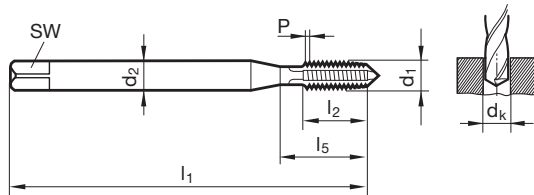

								Standard	DIN 371
								Article no.	1201
d1	P	d2	SW	dk	l1	l2	l5	Order no.	
M3	0.500	3.50	2.70	2.60	56.00	10.00	18.00	1201 3.000	
M4	0.700	4.50	3.40	3.40	63.00	12.00	21.00	1201 4.000	
M5	0.800	6.00	4.90	4.30	70.00	14.00	25.00	1201 5.000	
M6	1.000	6.00	4.90	5.10	80.00	16.00	30.00	1201 6.000	
M8	1.250	8.00	6.20	6.90	90.00	17.00	35.00	1201 8.000	
M10	1.500	10.00	8.00	8.60	100.00	20.00	39.00	1201 10.000	
M12	1.750	12.00	9.00	10.40	110.00	24.00	49.00	1201 12.000	
M14	2.000	14.00	11.00	12.10	110.00	26.00	53.00	1201 14.000	
M16	2.000	16.00	12.00	14.10	110.00	26.00	54.00	1201 16.000	

Taps

Taps for ISO metric threads

Article no. 2944



Cutting data page 965



for hard machining 55-62 HRC

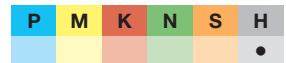

H = 55-62 HRC

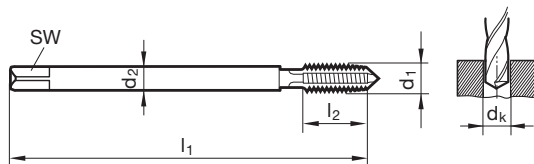

								Standard	~DIN 371
								Article no.	2944
d1	P	d2	SW	dk	l1	l2	l5	Order no.	
M3	0.500	3.50	2.70	2.60	56.00	12.00	12.00	2944 3.000	
M4	0.700	4.50	3.40	3.40	63.00	14.00	14.00	2944 4.000	
M5	0.800	6.00	4.90	4.30	70.00	17.00	17.00	2944 5.000	
M6	1.000	6.00	4.90	5.10	80.00	20.00	20.00	2944 6.000	
M8	1.250	8.00	6.20	6.90	90.00	20.00	20.00	2944 8.000	
M10	1.500	10.00	8.00	8.60	100.00	24.00	24.00	2944 10.000	
M12	1.750	12.00	9.00	10.40	110.00	28.00	28.00	2944 12.000	
M16	2.000	16.00	12.00	14.10	110.00	40.00	40.00	2944 16.000	



Taps for ISO metric fine threads

Article no. **830**



Cutting data page 959

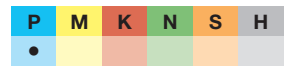

$P \leq 800 \text{ N/mm}^2$

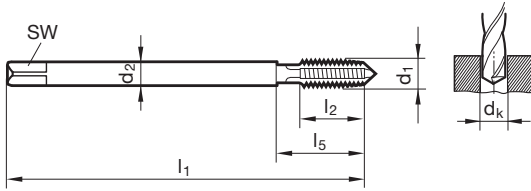

Standard

DIN 374

Article no.

830

Taps

d1	d2	SW	dk	l1	l2	l5	Order no.
							830 3.002
M3 x 0,35	2.20	1.80	2.65	56.00	4.00	18.00	830 3.002
M3,5 x 0,35	2.50	2.10	3.15	56.00	4.00	20.00	830 3.502
M4 x 0,5	2.80	2.10	3.50	63.00	5.00	21.00	830 4.003
M5 x 0,5	3.50	2.70	4.50	70.00	5.00	25.00	830 5.003
M6 x 0,5	4.50	3.40	5.50	80.00	5.00	30.00	830 6.003
M6 x 0,75	4.50	3.40	5.20	80.00	8.00	30.00	830 6.004
M7 x 0,75	5.50	4.30	6.20	80.00	8.00	30.00	830 7.004
M8 x 0,5	6.00	4.90	7.50	80.00	8.00	30.00	830 8.003
M8 x 0,75	6.00	4.90	7.20	80.00	8.00	30.00	830 8.004
M8 x 1	6.00	4.90	7.00	90.00	11.00	35.00	830 8.005
M9 x 1	7.00	5.50	8.00	90.00	11.00	35.00	830 9.005
M10 x 0,75	7.00	5.50	9.20	90.00	11.00	35.00	830 10.004
M10 x 1	7.00	5.50	9.00	90.00	11.00	35.00	830 10.005
M10 x 1,25	7.00	5.50	8.80	100.00	14.00	39.00	830 10.006
M11 x 1	8.00	6.20	10.00	90.00	11.00	33.00	830 11.005
M12 x 1	9.00	7.00	11.00	100.00	11.00	40.00	830 12.005
M12 x 1,25	9.00	7.00	10.80	100.00	15.00	40.00	830 12.006
M12 x 1,5	9.00	7.00	10.50	100.00	15.00	40.00	830 12.007
M14 x 1	11.00	9.00	13.00	100.00	11.00	40.00	830 14.005
M14 x 1,25	11.00	9.00	12.80	100.00	15.00	40.00	830 14.006
M14 x 1,5	11.00	9.00	12.50	100.00	15.00	40.00	830 14.007
M15 x 1	12.00	9.00	14.00	100.00	11.00	40.00	830 15.005
M16 x 1	12.00	9.00	15.00	100.00	11.00	44.00	830 16.005
M16 x 1,5	12.00	9.00	14.50	100.00	15.00	44.00	830 16.007
M18 x 1	14.00	11.00	17.00	110.00	12.00	44.00	830 18.005
M18 x 1,5	14.00	11.00	16.50	110.00	16.00	44.00	830 18.007
M18 x 2	14.00	11.00	16.00	125.00	20.00	58.00	830 18.008
M20 x 1	16.00	12.00	19.00	125.00	12.00	44.00	830 20.005
M20 x 1,5	16.00	12.00	18.50	125.00	16.00	44.00	830 20.007
M20 x 2	16.00	12.00	18.00	140.00	20.00	60.00	830 20.008
M22 x 1	18.00	14.50	21.00	125.00	12.00	44.00	830 22.005
M22 x 1,5	18.00	14.50	20.50	125.00	16.00	44.00	830 22.007
M22 x 2	18.00	14.50	20.00	140.00	22.00	62.00	830 22.008
M24 x 1,5	18.00	14.50	22.50	140.00	16.00	48.00	830 24.007
M24 x 2	18.00	14.50	22.00	140.00	22.00	48.00	830 24.008
M26 x 1,5	18.00	14.50	24.50	140.00	20.00	50.00	830 26.007
M27 x 1,5	20.00	16.00	25.50	140.00	20.00	53.00	830 27.007
M27 x 2	20.00	16.00	25.00	140.00	20.00	53.00	830 27.008
M28 x 1,5	20.00	16.00	26.50	140.00	20.00	53.00	830 28.007
M30 x 1,5	22.00	18.00	28.50	150.00	20.00	53.00	830 30.007
M30 x 2	22.00	18.00	28.00	150.00	20.00	53.00	830 30.008
M32 x 1,5	22.00	18.00	30.50	150.00	25.00	53.00	830 32.007
M35 x 1,5	28.00	22.00	33.50	170.00	25.00	56.00	830 35.007
M36 x 1,5	28.00	22.00	34.50	170.00	25.00	56.00	830 36.007
M38 x 1,5	28.00	22.00	36.50	170.00	25.00	56.00	830 38.007
M42 x 1,5	32.00	24.00	40.50	170.00	25.00	57.00	830 42.007



Taps for ISO metric fine threads

Article no. 829



Cutting data page 959

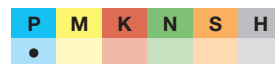

P ≤ 800 N/mm²

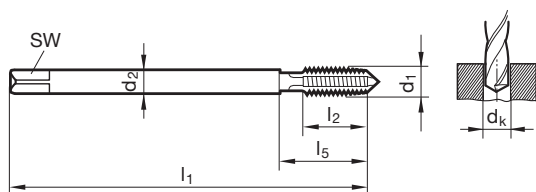

Standard **DIN 374**
Article no. **829**

d1	d2 mm	SW mm	dk mm	l1 mm	l2 mm	l5 mm	Order no.
M6 x 0,75	4.50	3.40	5.20	80.00	8.00	30.00	829 6.004
M8 x 1	6.00	4.90	7.00	90.00	11.00	35.00	829 8.005
M10 x 1	7.00	5.50	9.00	90.00	11.00	35.00	829 10.005
M10 x 1,25	7.00	5.50	8.80	100.00	14.00	39.00	829 10.006
M12 x 1,25	9.00	7.00	10.80	100.00	15.00	40.00	829 12.006
M12 x 1,5	9.00	7.00	10.50	100.00	15.00	40.00	829 12.007
M14 x 1,5	11.00	9.00	12.50	100.00	15.00	40.00	829 14.007
M16 x 1,5	12.00	9.00	14.50	100.00	15.00	44.00	829 16.007
M18 x 1,5	14.00	11.00	16.50	110.00	16.00	44.00	829 18.007
M20 x 1,5	16.00	12.00	18.50	125.00	16.00	44.00	829 20.007
M22 x 1,5	18.00	14.50	20.50	125.00	16.00	44.00	829 22.007
M25 x 1,5	18.00	14.50	23.50	140.00	20.00	50.00	829 25.007
M32 x 1,5	22.00	18.00	30.50	150.00	25.00	53.00	829 32.007
M40 x 1,5	32.00	24.00	38.50	170.00	25.00	57.00	829 40.007
M50 x 1,5	36.00	29.00	48.50	190.00	27.00	60.00	829 50.007
M63 x 1,5	50.00	39.00	61.50	275.00	25.00	62.00	829 63.007

Taps



Taps for ISO metric fine threads

Article no. **831**



Cutting data page 962



Taps for ISO metric fine threads

Article no. **169**



Cutting data page 962



Taps

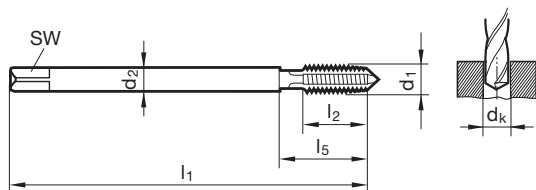

Standard
Article no.

DIN 374	
831	169

d1	d2 mm	SW mm	dk mm	l1 mm	l2 mm	l5 mm	Order no.	
M8 x 1	6.00	4.90	7.00	90.00	17.00	35.00	831 8.005	169 8.005
M10 x 1	7.00	5.50	9.00	90.00	16.00	35.00	831 10.005	169 10.005
M12 x 1	9.00	7.00	11.00	100.00	20.00	40.00	831 12.005	169 12.005
M12 x 1,5	9.00	7.00	10.50	100.00	20.00	40.00	831 12.007	169 12.007
M14 x 1,5	11.00	9.00	12.50	100.00	20.00	40.00	831 14.007	169 14.007
M16 x 1,5	12.00	9.00	14.50	100.00	22.00	44.00	831 16.007	169 16.007
M18 x 1,5	14.00	11.00	16.50	110.00	25.00	44.00	831 18.007	169 18.007
M20 x 1,5	16.00	12.00	18.50	125.00	25.00	44.00	831 20.007	169 20.007
M22 x 1,5	18.00	14.50	20.50	125.00	25.00	44.00	831 22.007	169 22.007
M24 x 1,5	18.00	14.50	22.50	140.00	28.00	48.00	831 24.007	169 24.007
M27 x 1,5	20.00	16.00	25.50	140.00	28.00	53.00	831 27.007	169 27.007
M30 x 1,5	22.00	18.00	28.50	150.00	28.00	53.00	831 30.007	169 30.007



Taps for ISO metric fine threads

Article no. 4161



Cutting data page 965



for hard machining 45-55 HRC

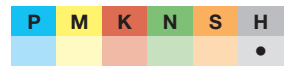

H = 45-55 HRC

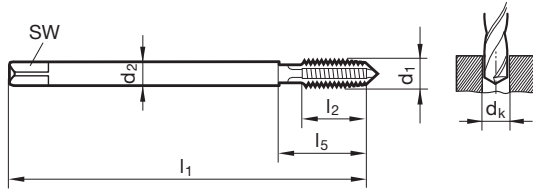

							Standard	~DIN 371
							Article no.	4161
d1	d2	SW	dk	l1	l2	l5	Order no.	
M6 x 0,75	6.00	4.90	5.30	80.00	13.00	30.00	4161 6.004	
M8 x 1	8.00	6.20	7.10	90.00	17.00	35.00	4161 8.005	
M10 x 1	10.00	8.00	9.10	90.00	16.00	35.00	4161 10.005	
M10 x 1,25	10.00	8.00	8.90	100.00	20.00	39.00	4161 10.006	
M12 x 1	12.00	9.00	11.10	100.00	20.00	40.00	4161 12.005	
M12 x 1,25	12.00	9.00	10.90	100.00	20.00	40.00	4161 12.006	
M12 x 1,5	12.00	9.00	10.60	100.00	20.00	40.00	4161 12.007	
M14 x 1,5	14.00	11.00	12.60	100.00	20.00	40.00	4161 14.007	
M16 x 1,5	16.00	12.00	14.60	100.00	22.00	44.00	4161 16.007	

Taps

Taps for ISO metric fine threads

Article no. 1161



Cutting data page 965



for hard machining 55-62 HRC

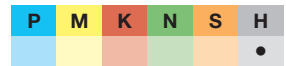

H = 55-62 HRC

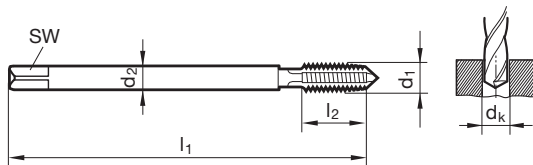

							Standard	~DIN 371
							Article no.	1161
d1	d2	SW	dk	l1	l2	l5	Order no.	
M6 x 0,5	6.00	4.90	5.60	80.00	15.00	15.00	1161 6.003	
M6 x 0,75	6.00	4.90	5.30	80.00	20.00	20.00	1161 6.004	
M8 x 1	8.00	6.20	7.10	90.00	18.00	18.00	1161 8.005	
M10 x 1	10.00	8.00	9.10	90.00	22.00	22.00	1161 10.005	
M10 x 1,25	10.00	8.00	8.90	100.00	28.00	28.00	1161 10.006	
M12 x 1	12.00	9.00	11.10	100.00	25.00	25.00	1161 12.005	
M12 x 1,25	12.00	9.00	10.90	100.00	28.00	28.00	1161 12.006	
M12 x 1,5	12.00	9.00	10.60	100.00	28.00	28.00	1161 12.007	
M14 x 1,5	14.00	11.00	12.60	100.00	30.00	30.00	1161 14.007	
M16 x 1,5	16.00	12.00	14.60	100.00	40.00	40.00	1161 16.007	



Through- and blind holes

Taps for UNC threads

Article no. **1977**



Cutting data page 959

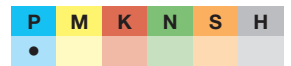

$P \leq 800 \text{ N/mm}^2$

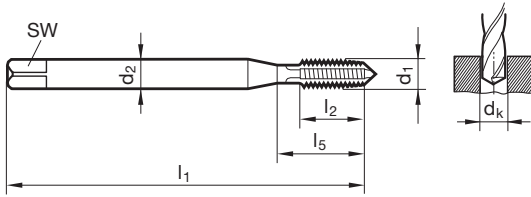

Standard

~DIN 371

Article no.

1977

Taps

	d1	d2	SW	dk	l1	l2	l5	Order no.
	mm	mm	mm	mm	mm	mm	mm	
	2 - 56	2.80	2.10	1.85	45.00	5.00	14.50	1977 2.184
	3 - 48	2.80	2.10	2.10	50.00	6.00	14.50	1977 2.515
	4 - 40	3.50	2.70	2.35	56.00	7.00	18.00	1977 2.845
	5 - 40	3.50	2.70	2.65	56.00	7.00	18.00	1977 3.175
	6 - 32	4.00	3.00	2.85	56.00	8.00	20.00	1977 3.505
	8 - 32	4.50	3.40	3.50	63.00	8.00	21.00	1977 4.166
	10 - 24	6.00	4.90	3.90	70.00	11.00	25.00	1977 4.826
	12 - 24	6.00	4.90	4.50	80.00	11.00	30.00	1977 5.486
	1/4 - 20	7.00	5.50	5.10	80.00	13.00	30.00	1977 6.350
	5/16 - 18	8.00	6.20	6.60	90.00	14.00	35.00	1977 7.938
	3/8 - 16	10.00	8.00	8.00	100.00	16.00	39.00	1977 9.525



Taps for UNC threads

Article no. 1979



Cutting data page 962

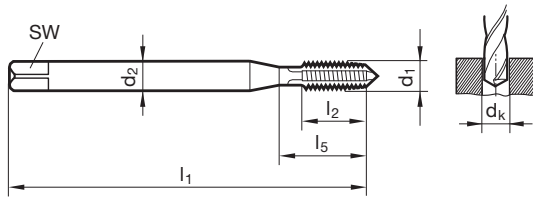

d1	d2 mm	SW mm	dk mm	l1 mm	l2 mm	l5 mm
2 - 56	2.80	2.10	1.85	45.00	9.00	14.50
3 - 48	2.80	2.10	2.10	50.00	9.00	14.50
4 - 40	3.50	2.70	2.35	56.00	11.00	18.00
5 - 40	3.50	2.70	2.65	56.00	11.00	18.00
6 - 32	4.00	3.00	2.85	56.00	12.00	20.00
8 - 32	4.50	3.40	3.50	63.00	12.00	21.00
10 - 24	6.00	4.90	3.90	70.00	14.00	25.00
12 - 24	6.00	4.90	4.50	80.00	16.00	30.00
1/4 - 20	7.00	5.50	5.10	80.00	16.00	30.00
5/16 - 18	8.00	6.20	6.60	90.00	18.00	35.00
3/8 - 16	10.00	8.00	8.00	100.00	20.00	39.00

Standard

~DIN 371

Article no.

1979

Order no.

1979 2.184
1979 2.515
1979 2.845
1979 3.175
1979 3.505
1979 4.166
1979 4.826
1979 5.486
1979 6.350
1979 7.938
1979 9.525

Taps

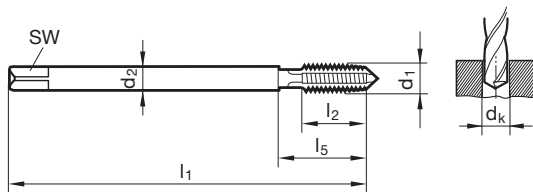

d1	d2 mm	SW mm	dk mm	l1 mm	l2 mm	l5 mm
7/16 - 14	8.00	6.20	9.40	100.00	22.00	42.00
1/2 - 13	9.00	7.00	10.80	110.00	25.00	49.00
9/16 - 12	11.00	9.00	12.20	110.00	28.00	53.00
5/8 - 11	12.00	9.00	13.50	110.00	30.00	53.00
3/4 - 10	14.00	11.00	16.50	125.00	33.00	62.00
7/8 - 9	18.00	14.50	19.50	140.00	35.00	62.00
1 - 8	18.00	14.50	22.25	160.00	38.00	73.00

Standard

~DIN 376

Article no.

1984

Order no.

1984 11.113
1984 12.700
1984 14.288
1984 15.875
1984 19.050
1984 22.225
1984 25.400



Taps for UNC threads

Article no. **4857**



Cutting data page 962

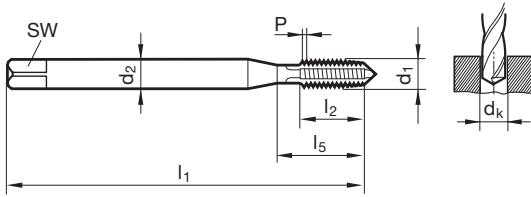
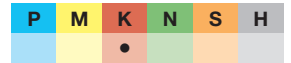

Standard

~DIN 371

Article no.

4857

Taps

d1	d2	SW	dk	l1	l2	l5	Order no.
							4857 2.184
2 - 56	2.80	2.10	1.85	45.00	9.00	14.50	4857 2.184
3 - 48	2.80	2.10	2.10	50.00	9.00	14.50	4857 2.515
4 - 40	3.50	2.70	2.35	56.00	11.00	18.00	4857 2.845
5 - 40	3.50	2.70	2.65	56.00	11.00	18.00	4857 3.175
6 - 32	4.00	3.00	2.85	56.00	12.00	20.00	4857 3.505
8 - 32	4.50	3.40	3.50	63.00	12.00	21.00	4857 4.166
10 - 24	6.00	4.90	3.90	70.00	14.00	25.00	4857 4.826
12 - 24	6.00	4.90	4.50	80.00	16.00	30.00	4857 5.486
1/4 - 20	7.00	5.50	5.10	80.00	16.00	30.00	4857 6.350
5/16 - 18	8.00	6.20	6.60	90.00	18.00	35.00	4857 7.938
3/8 - 16	10.00	8.00	8.00	100.00	20.00	39.00	4857 9.525
7/16 - 14	8.00	6.20	9.40	100.00	22.00	42.00	4857 11.113
1/2 - 13	9.00	7.00	10.80	110.00	25.00	49.00	4857 12.700
9/16 - 12	11.00	9.00	12.20	110.00	28.00	53.00	4857 14.288
5/8 - 11	12.00	9.00	13.50	110.00	30.00	53.00	4857 15.875
3/4 - 10	14.00	11.00	16.50	125.00	33.00	62.00	4857 19.050
7/8 - 9	18.00	14.50	19.50	140.00	35.00	62.00	4857 22.225
1 - 8	18.00	14.50	22.25	160.00	38.00	73.00	4857 25.400

Taps for UNF threads

Article no. 1987

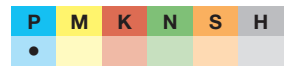
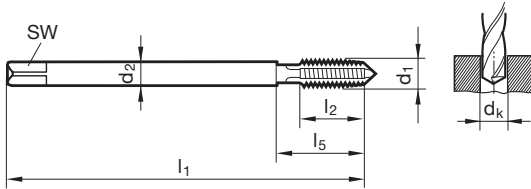

Cutting data page 959

 $P \leq 800 \text{ N/mm}^2$ 

Standard

~DIN 374

Article no.

1987

d1	d2 mm	SW mm	dk mm	l1 mm	l2 mm	l5 mm	Order no.
3 - 56	1.80	1.40	2.15	50.00	5.00	14.50	1987 2.515
4 - 48	2.20	1.80	2.40	56.00	6.00	18.00	1987 2.845
5 - 44	2.50	2.10	2.70	56.00	6.00	18.00	1987 3.175
6 - 40	2.50	2.10	2.95	56.00	6.50	20.00	1987 3.505
8 - 36	2.80	2.10	3.50	63.00	7.00	21.00	1987 4.166
10 - 32	3.50	2.70	4.10	70.00	8.50	25.00	1987 4.826
12 - 28	4.00	3.00	4.60	80.00	9.50	30.00	1987 5.486
1/4 - 28	4.50	3.40	5.50	80.00	9.50	30.00	1987 6.350
5/16 - 24	6.00	4.90	6.90	90.00	11.50	35.00	1987 7.938
3/8 - 24	7.00	5.50	8.50	90.00	11.50	35.00	1987 9.525
7/16 - 20	8.00	6.20	9.90	100.00	13.00	42.00	1987 11.113
1/2 - 20	9.00	7.00	11.50	100.00	13.00	40.00	1987 12.700
9/16 - 18	11.00	9.00	12.90	100.00	14.00	40.00	1987 14.288
5/8 - 18	12.00	9.00	14.50	100.00	15.00	44.00	1987 15.875
3/4 - 16	14.00	11.00	17.50	110.00	16.00	44.00	1987 19.050
7/8 - 14	18.00	14.50	20.40	125.00	19.00	44.00	1987 22.225
1 - 12	18.00	14.50	23.25	140.00	22.00	50.00	1987 25.400

Taps



Through- and blind holes

Taps for UNF threads

Article no. **1989**



Cutting data page 962

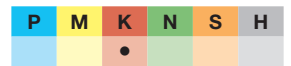

Taps for UNF threads

Article no. **4858**



Cutting data page 962

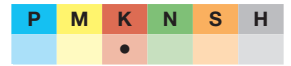

Taps

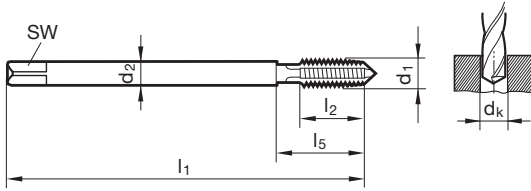

Standard
Article no.

~DIN 374

1989 **4858**

d1	d2 mm	SW mm	dk mm	l1 mm	l2 mm	l5 mm	Order no.	
1/4 - 28	4.50	3.40	5.50	80.00	16.00	30.00	1989 6.350	4858 6.350
5/16 - 24	6.00	4.90	6.90	90.00	17.00	35.00	1989 7.938	4858 7.938
3/8 - 24	7.00	5.50	8.50	90.00	18.00	35.00	1989 9.525	4858 9.525
7/16 - 20	8.00	6.20	9.90	100.00	22.00	42.00	1989 11.113	4858 11.113
1/2 - 20	9.00	7.00	11.50	100.00	20.00	40.00	1989 12.700	4858 12.700
9/16 - 18	11.00	9.00	12.90	100.00	22.00	40.00	1989 14.288	4858 14.288
3/4 - 16	14.00	11.00	17.50	110.00	25.00	44.00	1989 19.050	4858 19.050
7/8 - 14	18.00	14.50	20.40	125.00	25.00	44.00	1989 22.225	4858 22.225
1 - 12	18.00	14.50	23.25	140.00	28.00	50.00	1989 25.400	4858 25.400



Taps for BSP threads

Article no. 963



Cutting data page 959

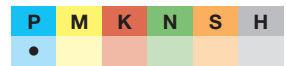

P ≤ 800 N/mm²

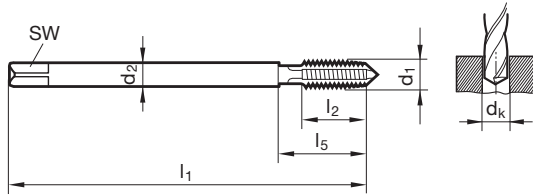

d1	P	d2	SW	dk	l1	l2	l5
	G/inch	mm	mm	mm	mm	mm	mm
G1/8	28	7.00	5.50	8.80	90.00	11.00	35.00
G1/4	19	11.00	9.00	11.80	100.00	14.00	40.00
G3/8	19	12.00	9.00	15.25	100.00	14.00	44.00
G1/2	14	16.00	12.00	19.00	125.00	18.00	44.00
G5/8	14	18.00	14.50	21.00	125.00	18.00	48.00
G3/4	14	20.00	16.00	24.50	140.00	20.00	53.00
G1	11	25.00	20.00	30.75	160.00	24.00	56.00
G1 1/4	11	32.00	24.00	39.50	170.00	25.00	57.00
G1 1/2	11	36.00	29.00	45.25	190.00	27.00	60.00
G2	11	45.00	35.00	57.00	220.00	32.00	95.00

Standard **DIN 5156**
Article no. **963**

Order no.
963 9.728
963 13.157
963 16.662
963 20.955
963 22.911
963 26.441
963 33.249
963 41.910
963 47.803
963 59.614

Taps

Taps for BSP threads

Article no. 961



Cutting data page 962

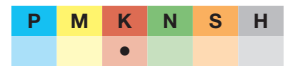

Taps for BSP threads

Article no. 4859



Cutting data page 962

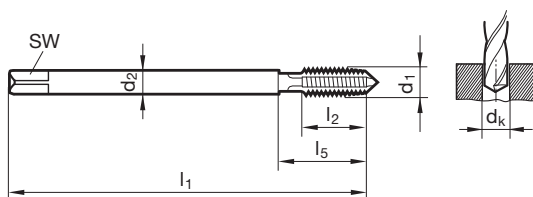

d1	P	d2	SW	dk	l1	l2	l5
	G/inch	mm	mm	mm	mm	mm	mm
G1/8	28	7.00	5.50	8.80	90.00	18.00	35.00
G1/4	19	11.00	9.00	11.80	100.00	20.00	40.00
G3/8	19	12.00	9.00	15.25	100.00	22.00	44.00
G1/2	14	16.00	12.00	19.00	125.00	25.00	44.00
G3/4	14	20.00	16.00	24.50	140.00	28.00	53.00
G1	11	25.00	20.00	30.75	160.00	30.00	56.00
G1 1/4	11	32.00	24.00	39.50	170.00	30.00	57.00
G1 1/2	11	36.00	29.00	45.25	190.00	32.00	60.00
G2	11	45.00	35.00	57.00	220.00	40.00	95.00

Standard **DIN 5156**
Article no. **961** | **4859**

Order no.	
961 9.728	4859 9.728
961 13.157	4859 13.157
961 16.662	4859 16.662
961 20.955	4859 20.955
961 26.441	4859 26.441
961 33.249	4859 33.249
961 41.910	4859 41.910
961 47.803	4859 47.803
961 59.614	4859 59.614



Taps for BSP threads

Article no. **4607**



Cutting data page 965

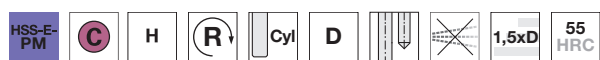

for hard machining 45-55 HRC

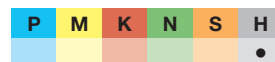

H = 55-62 HRC

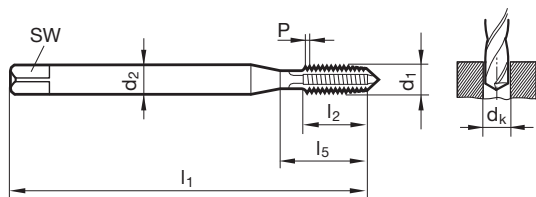

Standard	DIN 371
Article no.	4607

d1	P G/inch	d2 mm	SW mm	dk mm	l1 mm	l2 mm	l5 mm	Order no.
G1/8	28	10.00	8.00	8.90	100.00	19.00	39.00	4607 9.728
G1/4	19	14.00	11.00	11.90	110.00	28.00	49.00	4607 13.157
G3/8	19	16.00	12.00	15.35	125.00	28.00	54.00	4607 16.662
G1/2	14	20.00	16.00	19.00	140.00	35.00	62.00	4607 20.955

Taps

Taps for BSP threads

Article no. **4599**



Cutting data page 965

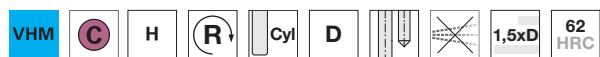

for hard machining 55-62 HRC

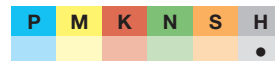

H = 55-62 HRC

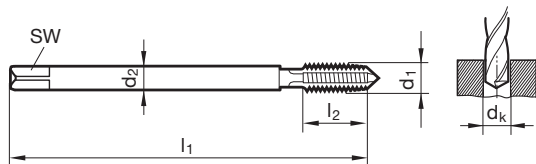

Standard	~DIN 371
Article no.	4599

d1	P G/inch	d2 mm	SW mm	dk mm	l1 mm	l2 mm	l5 mm	Order no.
G1/8	28	10.00	8.00	8.90	90.00	22.00	22.00	4599 9.728
G1/4	19	14.00	11.00	11.90	100.00	30.00	30.00	4599 13.157
G3/8	19	16.00	12.00	15.35	100.00	40.00	40.00	4599 16.662
G1/2	14	20.00	16.00	19.00	125.00	40.00	40.00	4599 20.955



Taps for NPT threads

Article no. 973



Cutting data page 959

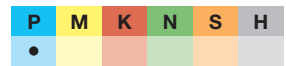

P ≤ 800 N/mm²

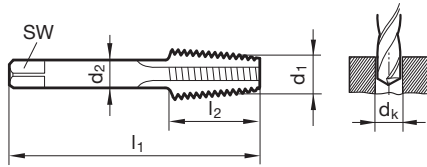

Standard								Company std.
Article no.								973
								Order no.
d1	P	d2	SW	dk	l1	l2	l5	
	G/inch	mm	mm	mm	mm	mm	mm	
1/16	27	6.00	4.90	6.15	56.00	14.00	27.00	973 8.190
1/8	27	7.00	5.50	8.40	63.00	15.00	29.00	973 10.620
1/4	18	11.00	9.00	11.10	63.00	21.00	33.00	973 14.140
3/8	18	12.00	9.00	14.30	70.00	21.00	35.00	973 17.570
1/2	14	16.00	12.00	17.90	80.00	27.00	41.00	973 21.900
3/4	14	20.00	16.00	23.30	100.00	27.00	42.00	973 27.230
1	11	25.00	20.00	29.00	110.00	32.00	53.00	973 34.180
1 1/4	11	32.00	24.00	37.70	125.00	33.00	54.50	973 42.900
1 1/2	11	36.00	29.00	43.70	140.00	33.00	56.00	973 48.940
2	11	36.00	29.00	55.60	160.00	33.00	63.00	973 61.000

Taps

Taps for PT threads

Article no. 979



Cutting data page 959

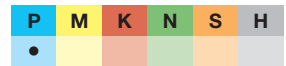

P ≤ 800 N/mm²

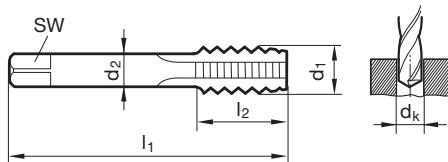

Standard								DIN 40432
Article no.								979
								Order no.
d1	P	d2	SW	dk	l1	l2	l5	
	G/inch	mm	mm	mm	mm	mm	mm	
PG7	20	9.00	7.00	11.40	70.00	22.00	35.00	979 12.500
PG9	18	12.00	9.00	14.00	70.00	22.00	35.00	979 15.200
PG11	18	14.00	11.00	17.30	80.00	22.00	40.00	979 18.600
PG13.5	18	16.00	12.00	19.00	80.00	22.00	40.00	979 20.400
PG16	18	18.00	14.50	21.30	80.00	22.00	40.00	979 22.500
PG21	16	22.00	18.00	26.90	90.00	22.00	42.00	979 28.300
PG29	16	28.00	22.00	35.50	100.00	25.00	45.00	979 37.000



Fluteless taps for ISO metric threads

Article no. **4487**



with oil grooves \geq M2 • \varnothing tolerance \leq M1.4 = 4HX

Cutting data page 958

P	M	K	N	S	H
•	•	•	•	•	

N \geq 7% Si

Fluteless taps for ISO metric threads

Article no. **4488**



Cutting data page 958

P	M	K	N	S	H
•	•	•	•	•	

N \geq 7% Si

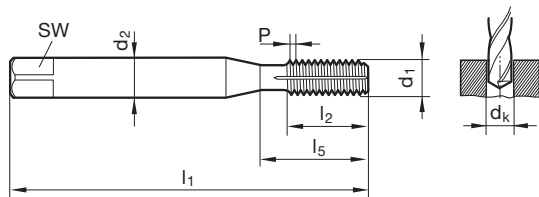

Fluteless taps

Standard
Article no.

~DIN 371/~DIN 376

4487 **4488**

d1	P mm	d2 mm	SW mm	dk mm	l1 mm	l2 mm	l5 mm	Standard	Order no.
M1	0.250	2.50	2.10	0.90	40.00	4.00	4.00	~DIN 371	4487 1.000
M1,2	0.250	2.50	2.10	1.10	40.00	4.80	4.80	~DIN 371	4487 1.200
M1,4	0.300	2.50	2.10	1.25	40.00	5.60	5.60	~DIN 371	4487 1.400
M1,6	0.350	2.50	2.10	1.45	40.00	6.40	6.40	~DIN 371	4487 1.600
M1,7	0.350	2.50	2.10	1.55	40.00	6.80	6.80	~DIN 371	4487 1.700
M1,8	0.350	2.50	2.10	1.65	40.00	7.30	7.30	~DIN 371	4487 1.800
M2	0.400	2.80	2.10	1.85	45.00	8.00	13.50	~DIN 371	4487 2.000 4488 2.000
M2,5	0.450	2.80	2.10	2.30	50.00	9.00	14.50	~DIN 371	4487 2.500 4488 2.500
M3	0.500	3.50	2.70	2.80	56.00	10.00	18.00	~DIN 371	4487 3.000 4488 3.000
M3,5	0.600	4.00	3.00	3.25	56.00	12.00	20.00	~DIN 371	4487 3.500
M4	0.700	4.50	3.40	3.70	63.00	12.00	21.00	~DIN 371	4487 4.000 4488 4.000
M4,5	0.750	6.00	4.90	4.20	70.00	14.00	25.00	~DIN 371	4487 4.500
M5	0.800	6.00	4.90	4.65	70.00	14.00	25.00	~DIN 371	4487 5.000 4488 5.000
M6	1.000	6.00	4.90	5.55	80.00	16.00	30.00	~DIN 371	4487 6.000 4488 6.000
M7	1.000	7.00	5.50	6.55	80.00	16.00	30.00	~DIN 371	4487 7.000
M8	1.250	8.00	6.20	7.40	90.00	17.00	35.00	~DIN 371	4487 8.000 4488 8.000
M9	1.250	9.00	7.00	8.40	90.00	17.00	35.00	~DIN 371	4487 9.000
M10	1.500	10.00	8.00	9.30	100.00	20.00	39.00	~DIN 371	4487 10.000 4488 10.000
M11	1.500	8.00	6.20	10.30	100.00	20.00	42.00	~DIN 376	4487 11.000
M12	1.750	9.00	7.00	11.20	110.00	24.00	49.00	~DIN 376	4487 12.000 4488 12.000
M14	2.000	11.00	9.00	13.10	110.00	26.00	53.00	~DIN 376	4487 14.000 4488 14.000
M16	2.000	12.00	9.00	15.10	110.00	26.00	54.00	~DIN 376	4487 16.000 4488 16.000
M20	2.500	16.00	12.00	18.90	140.00	32.00	62.00	~DIN 376	4487 20.000 4488 20.000



Fluteless taps for ISO metric threads

Article no. 4494



Cutting data page 958

P	M	K	N	S	H
•	•	•	•	•	

N ≥ 7% Si

Fluteless taps for ISO metric threads

Article no. 4703



Cutting data page 958

P	M	K	N	S	H
•	•	•	•	•	

N ≥ 7% Si

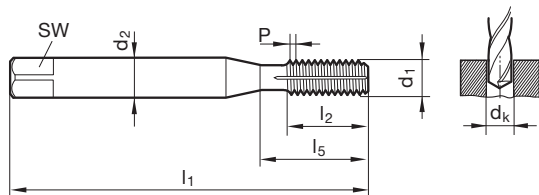

Standard
Article no.

~DIN 371/~DIN 376	
4494	4703

d1	P mm	d2 mm	SW mm	dk mm	l1 mm	l2 mm	l5 mm	Standard Article no.	Order no.	
M2	0.400	2.80	2.10	1.85	45.00	8.00	13.50	~DIN 371	4494 2.000	4703 2.000
M2,5	0.450	2.80	2.10	2.30	50.00	9.00	14.50	~DIN 371	4494 2.500	4703 2.500
M3	0.500	3.50	2.70	2.80	56.00	10.00	18.00	~DIN 371	4494 3.000	4703 3.000
M4	0.700	4.50	3.40	3.70	63.00	12.00	21.00	~DIN 371	4494 4.000	4703 4.000
M5	0.800	6.00	4.90	4.65	70.00	14.00	25.00	~DIN 371	4494 5.000	4703 5.000
M6	1.000	6.00	4.90	5.55	80.00	16.00	30.00	~DIN 371	4494 6.000	4703 6.000
M8	1.250	8.00	6.20	7.40	90.00	17.00	35.00	~DIN 371	4494 8.000	4703 8.000
M10	1.500	10.00	8.00	9.30	100.00	20.00	39.00	~DIN 371	4494 10.000	4703 10.000
M12	1.750	9.00	7.00	11.20	110.00	24.00	49.00	~DIN 376	4494 12.000	4703 12.000
M14	2.000	11.00	9.00	13.10	110.00	26.00	53.00	~DIN 376	4494 14.000	4703 14.000
M16	2.000	12.00	9.00	15.10	110.00	26.00	54.00	~DIN 376	4494 16.000	4703 16.000
M20	2.500	16.00	12.00	18.90	140.00	32.00	62.00	~DIN 376	4494 20.000	4703 20.000

Fluteless taps



Fluteless taps with coolant ducts for ISO metric threads

Article no. **4485**



Cutting data page 958

P	M	K	N	S	H
•	•	•	•	•	

N ≥ 7% Si

Fluteless taps with coolant ducts for ISO metric threads

Article no. **4705**



Cutting data page 958

P	M	K	N	S	H
•	•	•	•	•	

N ≥ 7% Si

Fluteless taps

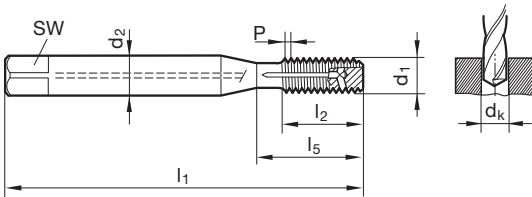

Standard
Article no.

~DIN 371/~DIN 376

4485 **4705**

d1	P mm	d2 mm	SW mm	dk mm	l1 mm	l2 mm	l5 mm		Order no.	
M5	0.800	6.00	4.90	4.65	70.00	8.50	25.00	~DIN 371	4485 5.000	4705 5.000
M6	1.000	6.00	4.90	5.55	80.00	11.00	30.00	~DIN 371	4485 6.000	4705 6.000
M8	1.250	8.00	6.20	7.40	90.00	14.00	35.00	~DIN 371	4485 8.000	4705 8.000
M10	1.500	10.00	8.00	9.30	100.00	16.00	39.00	~DIN 371	4485 10.000	4705 10.000
M12	1.750	9.00	7.00	11.20	110.00	18.50	49.00	~DIN 376	4485 12.000	4705 12.000
M14	2.000	11.00	9.00	13.10	110.00	20.00	53.00	~DIN 376	4485 14.000	4705 14.000
M16	2.000	12.00	9.00	15.10	110.00	20.00	54.00	~DIN 376	4485 16.000	4705 16.000
M20	2.500	16.00	12.00	18.90	140.00	25.00	62.00	~DIN 376	4485 20.000	4705 20.000

Fluteless taps with coolant ducts for ISO metric threads

Article no. **4483**



Cutting data page 958

P	M	K	N	S	H
•	•	•	•	•	

N ≥ 7% Si

Fluteless taps with coolant ducts for ISO metric threads

Article no. **4707**



Cutting data page 958

P	M	K	N	S	H
•	•	•	•	•	

N ≥ 7% Si

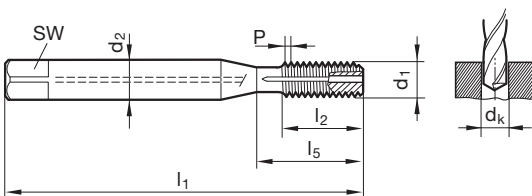

Standard
Article no.

~DIN 371/~DIN 376

4483 **4707**

d1	P mm	d2 mm	SW mm	dk mm	l1 mm	l2 mm	l5 mm		Order no.	
M5	0.800	6.00	4.90	4.65	70.00	8.50	25.00	~DIN 371	4483 5.000	4707 5.000
M6	1.000	6.00	4.90	5.55	80.00	11.00	30.00	~DIN 371	4483 6.000	4707 6.000
M8	1.250	8.00	6.20	7.40	90.00	14.00	35.00	~DIN 371	4483 8.000	4707 8.000
M10	1.500	10.00	8.00	9.30	100.00	16.00	39.00	~DIN 371	4483 10.000	4707 10.000
M12	1.750	9.00	7.00	11.20	110.00	18.50	49.00	~DIN 376	4483 12.000	4707 12.000
M14	2.000	11.00	9.00	13.10	110.00	20.00	53.00	~DIN 376	4483 14.000	4707 14.000
M16	2.000	12.00	9.00	15.10	110.00	20.00	54.00	~DIN 376	4483 16.000	4707 16.000
M20	2.500	16.00	12.00	18.90	140.00	25.00	62.00	~DIN 376	4483 20.000	4707 20.000



Fluteless taps for ISO metric fine threads

Article no. 4489



Cutting data page 958

P	M	K	N	S	H
•	•	•	•	•	

N ≥ 7% Si

Fluteless taps for ISO metric fine threads

Article no. 4490



Cutting data page 958

P	M	K	N	S	H
•	•	•	•	•	

N ≥ 7% Si

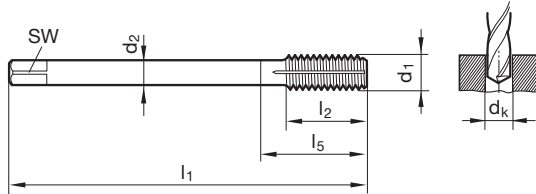

Standard
Article no.

~DIN 374	
4489	4490

d1	P mm	d2 mm	SW mm	dk mm	l1 mm	l2 mm	l5 mm	Order no.
M3 x 0,35	0.350	2.20	1.80	2.85	56.00	7.00	18.00	4489 3.002
M4 x 0,35	0.350	2.80	2.10	3.85	63.00	8.00	21.00	4489 4.002
M4 x 0,5	0.500	2.80	2.10	3.80	63.00	8.00	21.00	4489 4.003
M5 x 0,5	0.500	3.50	2.70	4.80	70.00	10.00	25.00	4489 5.003
M6 x 0,5	0.500	4.50	3.40	5.75	80.00	13.00	30.00	4489 6.003
M6 x 0,75	0.750	4.50	3.40	5.65	80.00	13.00	30.00	4489 6.004
M8 x 0,75	0.750	6.00	4.90	7.65	80.00	14.00	30.00	4489 8.004
M8 x 1	1.000	6.00	4.90	7.55	90.00	17.00	35.00	4489 8.005
M9 x 1	1.000	7.00	5.50	8.55	90.00	16.00	35.00	4489 9.005
M10 x 0,75	0.750	7.00	5.50	9.65	90.00	16.00	35.00	4489 10.004
M10 x 1	1.000	7.00	5.50	9.55	90.00	16.00	35.00	4489 10.005
M10 x 1,25	1.250	7.00	5.50	9.40	100.00	20.00	39.00	4489 10.006
M11 x 1	1.000	8.00	6.20	10.55	90.00	20.00	33.00	4489 11.005
M12 x 1	1.000	9.00	7.00	11.55	100.00	20.00	40.00	4489 12.005
M12 x 1,25	1.250	9.00	7.00	11.40	100.00	20.00	40.00	4489 12.006
M12 x 1,5	1.500	9.00	7.00	11.30	100.00	20.00	40.00	4489 12.007
M14 x 1	1.000	11.00	9.00	13.55	100.00	20.00	40.00	4489 14.005
M14 x 1,25	1.250	11.00	9.00	13.40	100.00	20.00	40.00	4489 14.006
M14 x 1,5	1.500	11.00	9.00	13.30	100.00	20.00	40.00	4489 14.007
M16 x 1	1.000	12.00	9.00	15.55	100.00	22.00	44.00	4489 16.005
M16 x 1,5	1.500	12.00	9.00	15.30	100.00	22.00	44.00	4489 16.007
M18 x 1	1.000	14.00	11.00	17.55	110.00	25.00	44.00	4489 18.005
M18 x 1,5	1.500	14.00	11.00	17.30	110.00	25.00	44.00	4489 18.007
M18 x 2	2.000	14.00	11.00	17.10	125.00	30.00	58.00	4489 18.008
M20 x 1	1.000	16.00	12.00	19.55	125.00	25.00	44.00	4489 20.005
M20 x 1,5	1.500	16.00	12.00	19.30	125.00	25.00	44.00	4489 20.007
M20 x 2	2.000	16.00	12.00	19.10	140.00	32.00	60.00	4489 20.008
M22 x 1	1.000	18.00	14.50	21.55	125.00	25.00	44.00	4489 22.005
M22 x 1,5	1.500	18.00	14.50	21.30	125.00	25.00	44.00	4489 22.007
M22 x 2	2.000	18.00	14.50	21.10	140.00	32.00	62.00	4489 22.008
M24 x 1	1.000	18.00	14.50	23.55	140.00	28.00	48.00	4489 24.005
M24 x 1,5	1.500	18.00	14.50	23.30	140.00	28.00	48.00	4489 24.007
M24 x 2	2.000	18.00	14.50	23.10	140.00	28.00	48.00	4489 24.008

Fluteless taps



Fluteless taps for ISO metric fine threads

Article no. **4495**



Cutting data page 958

P	M	K	N	S	H
•	•	•	•	•	

N ≥ 7% Si

Fluteless taps for ISO metric fine threads

Article no. **4704**



Cutting data page 958

P	M	K	N	S	H
•	•	•	•	•	

N ≥ 7% Si

Fluteless taps

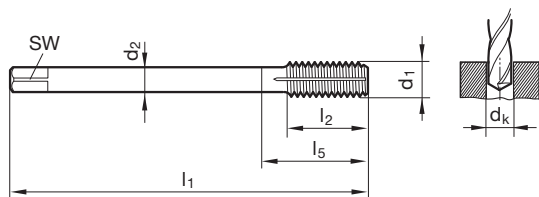

Standard
Article no.

~DIN 374	
4495	4704

d1	P mm	d2 mm	SW mm	dk mm	l1 mm	l2 mm	l5 mm
M8 x 1	1.000	6.00	4.90	7.55	90.00	17.00	35.00
M10 x 1	1.000	7.00	5.50	9.55	90.00	16.00	35.00
M10 x 1,25	1.250	7.00	5.50	9.40	100.00	20.00	39.00
M12 x 1,25	1.250	9.00	7.00	11.40	100.00	20.00	40.00
M12 x 1,5	1.500	9.00	7.00	11.30	100.00	20.00	40.00
M14 x 1,25	1.250	11.00	9.00	13.40	100.00	20.00	40.00
M14 x 1,5	1.500	11.00	9.00	13.30	100.00	20.00	40.00
M16 x 1,5	1.500	12.00	9.00	15.30	100.00	22.00	44.00
M20 x 1,5	1.500	16.00	12.00	19.30	125.00	25.00	44.00

Order no.	
4495 8.005	4704 8.005
4495 10.005	4704 10.005
4495 10.006	4704 10.006
4495 12.006	4704 12.006
4495 12.007	4704 12.007
4495 14.006	4704 14.006
4495 14.007	4704 14.007
4495 16.007	4704 16.007
4495 20.007	4704 20.007



Fluteless taps with coolant ducts for ISO metric fine threads

Article no. 4486



Cutting data page 958

P	M	K	N	S	H
•	•	•	•	•	

N ≥ 7% Si

Fluteless taps with coolant ducts for ISO metric fine threads

Article no. 4706



Cutting data page 958

P	M	K	N	S	H
•	•	•	•	•	

N ≥ 7% Si

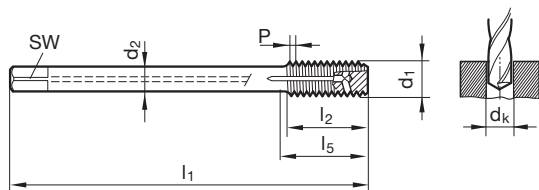

Standard
Article no.

~DIN 374	
4486	4706

d1	P	d2	SW	dk	l1	l2	l5
mm	mm	mm	mm	mm	mm	mm	mm
M8 x 1	1.000	6.00	4.90	7.55	90.00	11.00	35.00
M10 x 1	1.000	7.00	5.50	9.55	90.00	11.00	35.00
M10 x 1,25	1.250	7.00	5.50	9.40	100.00	14.00	39.00
M12 x 1,25	1.250	9.00	7.00	11.40	100.00	15.00	40.00
M12 x 1,5	1.500	9.00	7.00	11.30	100.00	15.00	40.00
M14 x 1,25	1.250	11.00	9.00	13.40	100.00	15.00	40.00
M14 x 1,5	1.500	11.00	9.00	13.30	100.00	15.00	40.00
M16 x 1,5	1.500	12.00	9.00	15.30	100.00	15.00	44.00
M20 x 1,5	1.500	16.00	12.00	19.30	125.00	16.00	44.00

Order no.	
4486 8.005	4706 8.005
4486 10.005	4706 10.005
4486 10.006	4706 10.006
4486 12.006	4706 12.006
4486 12.007	4706 12.007
4486 14.006	4706 14.006
4486 14.007	4706 14.007
4486 16.007	4706 16.007
4486 20.007	4706 20.007

Fluteless taps



Fluteless taps with coolant ducts for ISO metric fine threads

Article no. **4484**



Cutting data page 958

P	M	K	N	S	H
•	•	•	•	•	

N ≥ 7% Si

Fluteless taps with coolant ducts for ISO metric fine threads

Article no. **4708**



Cutting data page 958

P	M	K	N	S	H
•	•	•	•	•	

N ≥ 7% Si

Fluteless taps

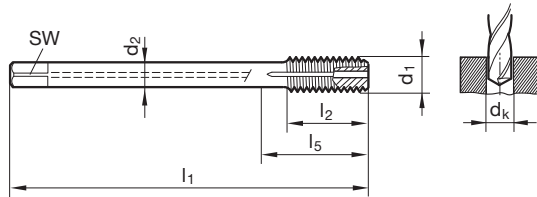

Standard
Article no.

~DIN 374	
4484	4708

d1	P mm	d2 mm	SW mm	dk mm	l1 mm	l2 mm	l5 mm
M8 x 1	1.000	6.00	4.90	7.55	90.00	11.00	35.00
M10 x 1	1.000	7.00	5.50	9.55	90.00	11.00	35.00
M10 x 1,25	1.250	7.00	5.50	9.40	100.00	14.00	39.00
M12 x 1,25	1.250	9.00	7.00	11.40	100.00	15.00	40.00
M12 x 1,5	1.500	9.00	7.00	11.30	100.00	15.00	40.00
M14 x 1,25	1.250	11.00	9.00	13.40	100.00	15.00	40.00
M14 x 1,5	1.500	11.00	9.00	13.30	100.00	15.00	40.00
M16 x 1,5	1.500	12.00	9.00	15.30	100.00	15.00	44.00
M20 x 1,5	1.500	16.00	12.00	19.30	125.00	16.00	44.00

Order no.	
4484 8.005	4708 8.005
4484 10.005	4708 10.005
4484 10.006	4708 10.006
4484 12.006	4708 12.006
4484 12.007	4708 12.007
4484 14.006	4708 14.006
4484 14.007	4708 14.007
4484 16.007	4708 16.007
4484 20.007	4708 20.007



Fluteless taps for UNC threads

Article no. 4491



Cutting data page 958



N ≥ 7% Si

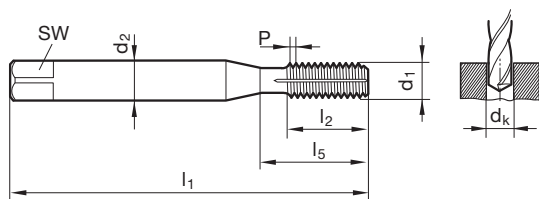

Standard ~DIN 371/~DIN 376

Article no. 4491

d1	d2 mm	SW mm	dk mm	l1 mm	l2 mm	l5 mm		Order no.
4 - 40	3.50	2.70	2.55	56.00	11.00	18.00	~DIN 371	4491 2.845
6 - 32	4.00	3.00	3.15	56.00	10.50	20.00	~DIN 371	4491 3.505
8 - 32	4.50	3.40	3.80	63.00	12.00	21.00	~DIN 371	4491 4.166
10 - 24	6.00	4.90	4.35	70.00	14.00	25.00	~DIN 371	4491 4.826
12 - 24	6.00	4.90	5.00	80.00	16.00	30.00	~DIN 371	4491 5.486
1/4 - 20	7.00	5.50	5.75	80.00	16.00	30.00	~DIN 371	4491 6.350
5/16 - 18	8.00	6.20	7.30	90.00	18.00	35.00	~DIN 371	4491 7.938
3/8 - 16	10.00	8.00	8.80	100.00	20.00	39.00	~DIN 371	4491 9.525
7/16 - 14	8.00	6.20	10.30	100.00	22.00	42.00	~DIN 376	4491 11.113
1/2 - 13	9.00	7.00	11.80	110.00	25.00	49.00	~DIN 376	4491 12.700
9/16 - 12	11.00	9.00	13.30	110.00	28.00	53.00	~DIN 376	4491 14.288
5/8 - 11	12.00	9.00	14.80	110.00	30.00	53.00	~DIN 376	4491 15.875
3/4 - 10	14.00	11.00	17.90	125.00	33.00	62.00	~DIN 376	4491 19.050

Fluteless taps

Fluteless taps for UNF threads

Article no. 4492



Cutting data page 958



N ≥ 7% Si

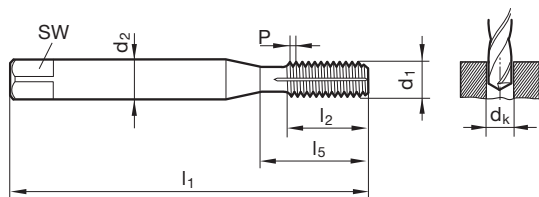

Standard ~DIN 371/~DIN 374

Article no. 4492

d1	d2 mm	SW mm	dk mm	l1 mm	l2 mm	l5 mm		Order no.
4 - 48	3.50	2.70	2.60	56.00	10.00	18.00	~DIN 371	4492 2.845
6 - 40	4.00	3.00	3.20	56.00	10.50	20.00	~DIN 371	4492 3.505
8 - 36	4.50	3.40	3.85	63.00	12.00	21.00	~DIN 371	4492 4.166
10 - 32	6.00	4.90	4.45	70.00	14.00	25.00	~DIN 371	4492 4.826
12 - 28	6.00	4.90	5.10	80.00	16.00	30.00	~DIN 371	4492 5.486
1/4 - 28	7.00	5.50	5.95	80.00	16.00	30.00	~DIN 371	4492 6.350
5/16 - 24	8.00	6.20	7.45	90.00	17.00	35.00	~DIN 371	4492 7.938
3/8 - 24	10.00	8.00	9.05	90.00	18.00	35.00	~DIN 371	4492 9.525
7/16 - 20	8.00	6.20	10.55	100.00	22.00	42.00	~DIN 374	4492 11.113
1/2 - 20	9.00	7.00	12.10	100.00	20.00	40.00	~DIN 374	4492 12.700
9/16 - 18	11.00	9.00	13.65	100.00	22.00	40.00	~DIN 374	4492 14.288
5/8 - 18	12.00	9.00	15.25	100.00	22.00	44.00	~DIN 374	4492 15.875
3/4 - 16	14.00	11.00	18.35	110.00	25.00	44.00	~DIN 374	4492 19.050



Fluteless taps for BSP threads

Article no. **4493**



Cutting data page 958



N ≥ 7% Si

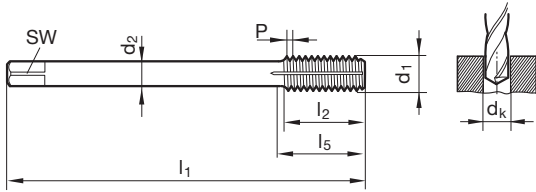

Standard
Article no.

DIN 2189

4493

d1	P	d2	SW	dk	l1	l2	l5	Order no.
	G/inch	mm	mm	mm	mm	mm	mm	
G1/8	28	7.00	5.50	9.30	90.00	18.00	35.00	4493 9.728
G1/4	19	11.00	9.00	12.50	100.00	20.00	40.00	4493 13.157
G3/8	19	12.00	9.00	16.00	100.00	22.00	44.00	4493 16.662
G1/2	14	16.00	12.00	20.00	125.00	25.00	44.00	4493 20.955

Fluteless taps



Fluteless taps for ISO metric threads

Article no. 921



Cutting data page 968



P	M	K	N	S	H
●	●	○	○		

Fluteless taps for ISO metric threads

Article no. 1255



Cutting data page 968



P	M	K	N	S	H
●	●	○	○		

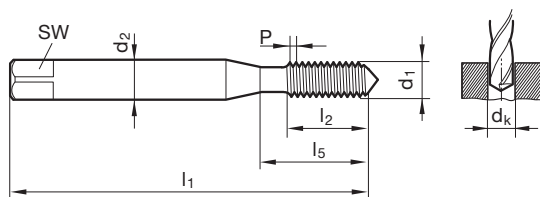

Standard	~DIN 371	
Article no.	921	1255

d1	P mm	d2 mm	SW mm	dk mm	l1 mm	l2 mm	l5 mm	Order no.	
M1	0.250	2.50	2.10	0.90	40.00	4.00	4.00	921 1.000	
M1,2	0.250	2.50	2.10	1.10	40.00	4.80	4.80	921 1.200	
M1,4	0.300	2.50	2.10	1.25	40.00	5.60	5.60	921 1.400	
M1,6	0.350	2.50	2.10	1.45	40.00	6.40	6.40	921 1.600	
M1,7	0.350	2.50	2.10	1.55	40.00	6.80	6.80	921 1.700	
M1,8	0.350	2.50	2.10	1.65	40.00	7.30	7.30	921 1.800	
M2	0.400	2.80	2.10	1.85	45.00	8.00	13.50	921 2.000	1255 2.000
M2,5	0.450	2.80	2.10	2.30	50.00	9.00	14.50	921 2.500	1255 2.500
M3	0.500	3.50	2.70	2.80	56.00	10.00	18.00	921 3.000	1255 3.000
M3,5	0.600	4.00	3.00	3.25	56.00	12.00	20.00	921 3.500	
M4	0.700	4.50	3.40	3.70	63.00	12.00	21.00	921 4.000	1255 4.000
M5	0.800	6.00	4.90	4.65	70.00	14.00	25.00	921 5.000	1255 5.000
M6	1.000	6.00	4.90	5.55	80.00	16.00	30.00	921 6.000	1255 6.000
M8	1.250	8.00	6.20	7.40	90.00	17.00	35.00	921 8.000	1255 8.000
M10	1.500	10.00	8.00	9.30	100.00	20.00	39.00	921 10.000	1255 10.000

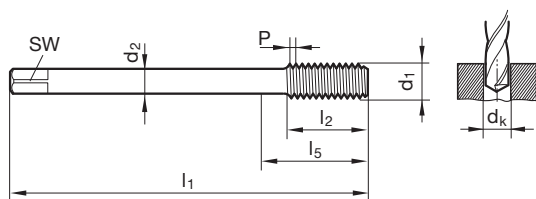

Standard	~DIN 376	
Article no.	925	1256

d1	P mm	d2 mm	SW mm	dk mm	l1 mm	l2 mm	l5 mm	Order no.	
M12	1.750	9.00	7.00	11.20	110.00	24.00	49.00	925 12.000	1256 12.000
M14	2.000	11.00	9.00	13.10	110.00	26.00	53.00	925 14.000	1256 14.000
M16	2.000	12.00	9.00	15.10	110.00	26.00	54.00	925 16.000	1256 16.000

Fluteless taps



Thread depth up to 1.5xD without oil grooves

Fluteless taps for ISO metric threads

Article no. **920**



Cutting data page 968



P	M	K	N	S	H
●	●	○	○	○	○

Fluteless taps for ISO metric threads

Article no. **903**



Cutting data page 968



P	M	K	N	S	H
●	●	○	○	○	○

Fluteless taps

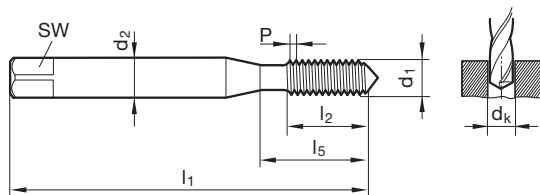

Standard	~DIN 371	
Article no.	920	903

d1	P mm	d2 mm	SW mm	dk mm	l1 mm	l2 mm	l5 mm	Order no.	
M2	0.400	2.80	2.10	1.85	45.00	8.00	13.50	920 2.000	903 2.000
M2,5	0.450	2.80	2.10	2.30	50.00	9.00	14.50	920 2.500	903 2.500
M3	0.500	3.50	2.70	2.80	56.00	10.00	18.00	920 3.000	903 3.000
M3,5	0.600	4.00	3.00	3.25	56.00	12.00	20.00	920 3.500	
M4	0.700	4.50	3.40	3.70	63.00	12.00	21.00	920 4.000	903 4.000
M5	0.800	6.00	4.90	4.65	70.00	14.00	25.00	920 5.000	903 5.000
M6	1.000	6.00	4.90	5.55	80.00	16.00	30.00	920 6.000	903 6.000
M8	1.250	8.00	6.20	7.40	90.00	17.00	35.00	920 8.000	903 8.000
M10	1.500	10.00	8.00	9.30	100.00	20.00	39.00	920 10.000	903 10.000

Fluteless taps with coolant ducts for ISO metric threads

Article no. **2518**



Cutting data page 968



P	M	K	N	S	H
●	○	○	○	○	○

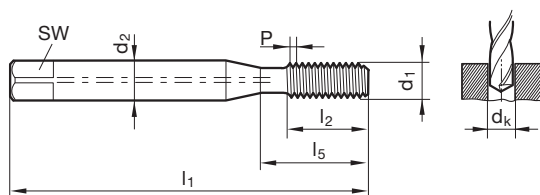

Standard	~DIN 371/~DIN 376
Article no.	2518

d1	P mm	d2 mm	SW mm	dk mm	l1 mm	l2 mm	l5 mm	Standard	Order no.
M5	0.800	6.00	4.90	4.65	70.00	8.50	25.00	~DIN 371	2518 5.000
M6	1.000	6.00	4.90	5.55	80.00	11.00	30.00	~DIN 371	2518 6.000
M8	1.250	8.00	6.20	7.40	90.00	14.00	35.00	~DIN 371	2518 8.000
M10	1.500	10.00	8.00	9.30	100.00	16.00	39.00	~DIN 371	2518 10.000
M12	1.750	9.00	7.00	11.20	110.00	18.50	49.00	~DIN 376	2518 12.000
M16	2.000	12.00	9.00	15.10	110.00	20.00	54.00	~DIN 376	2518 16.000



Fluteless taps for ISO metric threads

Article no. 1347



Cutting data page 968



Fluteless taps for ISO metric threads

Article no. 1565



Cutting data page 968

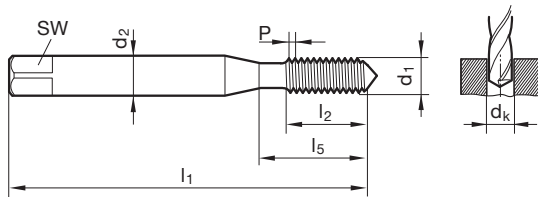

Standard
Article no.

~DIN 371	
1347	1565

d1	P mm	d2 mm	SW mm	dk mm	l1 mm	l2 mm	l5 mm
M2	0.400	2.80	2.10	1.85	45.00	8.00	13.50
M2,5	0.450	2.80	2.10	2.30	50.00	9.00	14.50
M3	0.500	3.50	2.70	2.80	56.00	10.00	18.00
M4	0.700	4.50	3.40	3.70	63.00	12.00	21.00
M5	0.800	6.00	4.90	4.65	70.00	14.00	25.00
M6	1.000	6.00	4.90	5.55	80.00	16.00	30.00
M8	1.250	8.00	6.20	7.40	90.00	17.00	35.00
M10	1.500	10.00	8.00	9.30	100.00	20.00	39.00

Order no.	
1347 2.000	1565 2.000
1347 2.500	1565 2.500
1347 3.000	1565 3.000
1347 4.000	1565 4.000
1347 5.000	1565 5.000
1347 6.000	1565 6.000
1347 8.000	1565 8.000
1347 10.000	1565 10.000

Fluteless taps



Thread depth up to 1.5xD without oil grooves

Fluteless taps for ISO metric fine threads

Article no. **929**



Cutting data page 968



P	M	K	N	S	H
●	●	○	○		

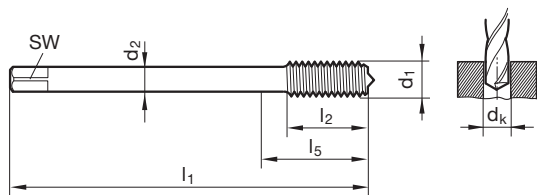

Standard **~DIN 374**

Article no. **929**

d1	d2 mm	SW mm	dk mm	l1 mm	l2 mm	l5 mm
M8 x 1	6.00	4.90	7.55	90.00	17.00	35.00
M10 x 1	7.00	5.50	9.55	90.00	16.00	35.00
M14 x 1,5	11.00	9.00	13.30	100.00	20.00	40.00

Order no.

929 8.005
929 10.005
929 14.007

Fluteless taps

Fluteless taps for BSP threads

Article no. **966**



Cutting data page 968



P	M	K	N	S	H
●	●	○	○		

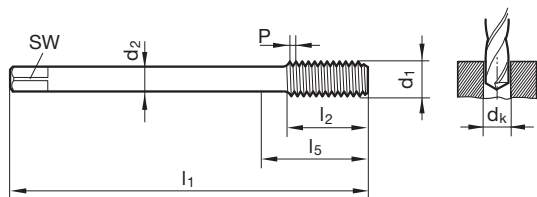

Standard **DIN 2189**

Article no. **966**

d1	P G/inch	d2 mm	SW mm	dk mm	l1 mm	l2 mm	l5 mm
G1/8	28	7.00	5.50	9.30	90.00	18.00	35.00
G1/4	19	11.00	9.00	12.50	100.00	20.00	40.00
G3/8	19	12.00	9.00	16.00	100.00	22.00	44.00
G1/2	14	16.00	12.00	20.00	125.00	25.00	44.00
G3/4	14	20.00	16.00	25.50	140.00	28.00	53.00
G1	11	25.00	20.00	32.00	160.00	30.00	56.00
G1 1/4	11	32.00	24.00	40.75	170.00	30.00	57.00

Order no.

966 9.728
966 13.157
966 16.662
966 20.955
966 26.441
966 33.249
966 41.910



Fluteless taps for ISO metric threads

Article no. 919



Cutting data page 968



P	M	K	N	S	H
●	●	○	○	○	○

Fluteless taps for ISO metric threads

Article no. 1587



Cutting data page 968



P	M	K	N	S	H
●	●	○	○	○	○

Fluteless taps for ISO metric threads

Article no. 1266



Cutting data page 968



P	M	K	N	S	H
●	●	○	○	○	○

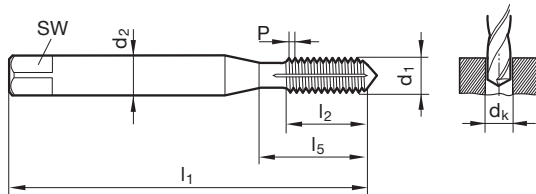

Standard	~DIN 371		
Article no.	919	1587	1266

d1	P	d2	SW	dk	l1	l2	l5	Order no.		
mm	mm	mm	mm	mm	mm	mm	mm			
M3	0.500	3.50	2.70	2.80	56.00	10.00	18.00	919 3.000	1587 3.000	1266 3.000
M3,5	0.600	4.00	3.00	3.25	56.00	12.00	20.00	919 3.500		
M4	0.700	4.50	3.40	3.70	63.00	12.00	21.00	919 4.000	1587 4.000	1266 4.000
M5	0.800	6.00	4.90	4.65	70.00	14.00	25.00	919 5.000	1587 5.000	1266 5.000
M6	1.000	6.00	4.90	5.55	80.00	16.00	30.00	919 6.000	1587 6.000	1266 6.000
M8	1.250	8.00	6.20	7.40	90.00	17.00	35.00	919 8.000	1587 8.000	1266 8.000
M10	1.500	10.00	8.00	9.30	100.00	20.00	39.00	919 10.000	1587 10.000	1266 10.000

Fluteless taps



Thread depth up to 3xD with oil grooves

Fluteless taps with coolant ducts for ISO metric threads

Article no. **923**



Cutting data page 968



P	M	K	N	S	H
●	●	○	○	○	○

Fluteless taps for ISO metric threads

Article no. **1589**



Cutting data page 968



P	M	K	N	S	H
●	○	○	○	○	○

Fluteless taps for ISO metric threads

Article no. **1267**



Cutting data page 968



P	M	K	N	S	H
●	●	○	○	○	○

Fluteless taps

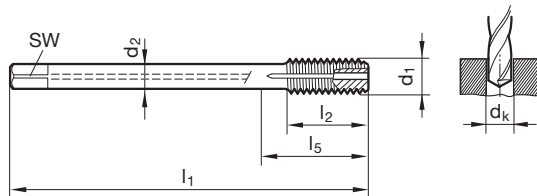

Standard	~DIN 376		
Article no.	923	1589	1267

d1	P	d2	SW	dk	l1	l2	l5	Order no.	
mm	mm	mm	mm	mm	mm	mm	mm		
M6	1.000	4.50	3.40	5.55	80.00	16.00	30.00	923 6.000	1589 6.000
M8	1.250	6.00	4.90	7.40	90.00	17.00	35.00	923 8.000	1589 8.000
M10	1.500	7.00	5.50	9.30	100.00	20.00	39.00	923 10.000	1589 10.000
M12	1.750	9.00	7.00	11.20	110.00	24.00	49.00	923 12.000	1589 12.000 1267 12.000
M14	2.000	11.00	9.00	13.10	110.00	26.00	53.00	923 14.000	1589 14.000
M16	2.000	12.00	9.00	15.10	110.00	26.00	54.00	923 16.000	1589 16.000 1267 16.000
M18	2.500	14.00	11.00	16.90	125.00	30.00	62.00	923 18.000	
M20	2.500	16.00	12.00	18.90	140.00	32.00	62.00	923 20.000	1589 20.000 1267 20.000
M22	2.500	18.00	14.50	20.90	140.00	32.00	62.00	923 22.000	
M24	3.000	18.00	14.50	22.70	160.00	36.00	73.00	923 24.000	
M27	3.000	20.00	16.00	25.70	160.00	36.00	73.00	923 27.000	
M30	3.500	22.00	18.00	28.50	180.00	40.00	85.00	923 30.000	
M33	3.500	25.00	20.00	31.50	180.00	40.00	91.00	923 33.000	
M36	4.000	28.00	22.00	34.30	200.00	50.00	102.00	923 36.000	
M39	4.000	32.00	24.00	37.30	200.00	50.00	107.00	923 39.000	



Fluteless taps for ISO metric threads

Article no. 918



Cutting data page 968



P	M	K	N	S	H
●	●	○	○	○	○

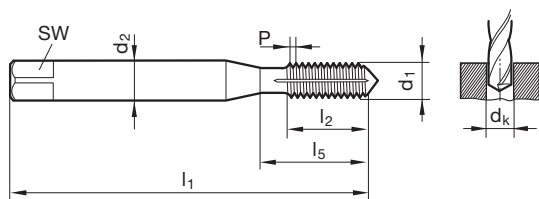

Standard ~DIN 371
Article no. 918

d1	P mm	d2 mm	SW mm	dk mm	l1 mm	l2 mm	l5 mm
M3	0.500	3.50	2.70	2.80	56.00	10.00	18.00
M3,5	0.600	4.00	3.00	3.25	56.00	12.00	20.00
M4	0.700	4.50	3.40	3.70	63.00	12.00	21.00
M5	0.800	6.00	4.90	4.65	70.00	14.00	25.00
M6	1.000	6.00	4.90	5.55	80.00	16.00	30.00
M8	1.250	8.00	6.20	7.40	90.00	17.00	35.00
M10	1.500	10.00	8.00	9.30	100.00	20.00	39.00

Order no.

918 3.000
918 3.500
918 4.000
918 5.000
918 6.000
918 8.000
918 10.000

Fluteless taps

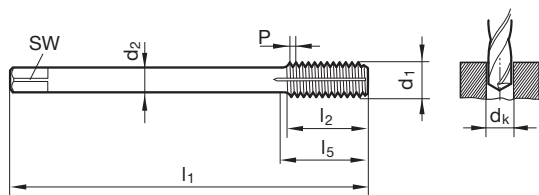

Standard ~DIN 376
Article no. 922

d1	P mm	d2 mm	SW mm	dk mm	l1 mm	l2 mm	l5 mm
M6	1.000	4.50	3.40	5.55	80.00	16.00	30.00
M8	1.250	6.00	4.90	7.40	90.00	17.00	35.00
M10	1.500	7.00	5.50	9.30	100.00	20.00	39.00
M12	1.750	9.00	7.00	11.20	110.00	24.00	49.00
M14	2.000	11.00	9.00	13.10	110.00	26.00	53.00
M16	2.000	12.00	9.00	15.10	110.00	26.00	54.00
M18	2.500	14.00	11.00	16.90	125.00	30.00	62.00
M20	2.500	16.00	12.00	18.90	140.00	32.00	62.00

Order no.

922 6.000
922 8.000
922 10.000
922 12.000
922 14.000
922 16.000
922 18.000
922 20.000



Thread depth up to 3xD with oil grooves

Fluteless taps for ISO metric threads

Article no. **1588**



Cutting data page 968

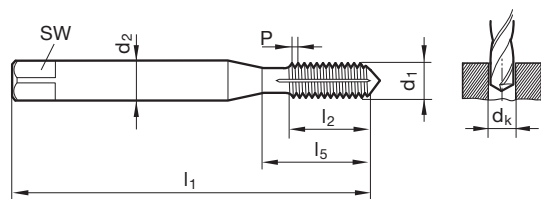
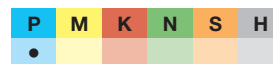

Standard **~DIN 371**
Article no. **1588**

d1	P	d2	SW	dk	l1	l2	l5	Order no.
mm	mm	mm	mm	mm	mm	mm	mm	
M3	0.500	3.50	2.70	2.80	56.00	10.00	18.00	1588 3.000
M4	0.700	4.50	3.40	3.70	63.00	12.00	21.00	1588 4.000
M5	0.800	6.00	4.90	4.65	70.00	14.00	25.00	1588 5.000
M6	1.000	6.00	4.90	5.55	80.00	16.00	30.00	1588 6.000
M8	1.250	8.00	6.20	7.40	90.00	17.00	35.00	1588 8.000
M10	1.500	10.00	8.00	9.30	100.00	20.00	39.00	1588 10.000

Fluteless taps



Fluteless taps with coolant ducts for ISO metric threads

Article no. **2442**



Cutting data page 968

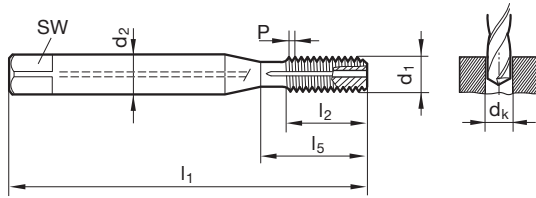
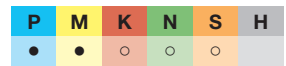

d1	P	d2	SW	dk	l1	l2	l5
mm	mm	mm	mm	mm	mm	mm	mm
M5	0.800	6.00	4.90	4.65	70.00	8.50	25.00
M6	1.000	6.00	4.90	5.55	80.00	11.00	30.00
M8	1.250	8.00	6.20	7.40	90.00	14.00	35.00
M10	1.500	10.00	8.00	9.30	100.00	16.00	39.00

Standard	~DIN 371
Article no.	2442
Order no.	2442 5.000
	2442 6.000
	2442 8.000
	2442 10.000

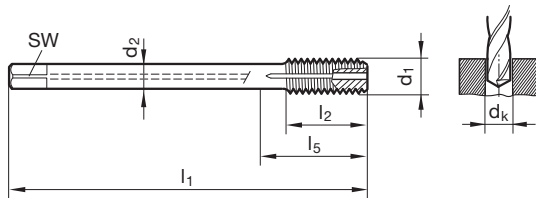

d1	P	d2	SW	dk	l1	l2	l5
mm	mm	mm	mm	mm	mm	mm	mm
M12	1.750	9.00	7.00	11.20	110.00	18.50	49.00
M14	2.000	11.00	9.00	13.10	110.00	20.00	53.00
M16	2.000	12.00	9.00	15.10	110.00	20.00	54.00

Standard	~DIN 376
Article no.	2444
Order no.	2444 12.000
	2444 14.000
	2444 16.000

Fluteless taps



Thread depth up to 3xD with oil grooves

Fluteless taps with coolant ducts for ISO metric threads

Article no. **2446**



Cutting data page 968



N ≥ 7% Si

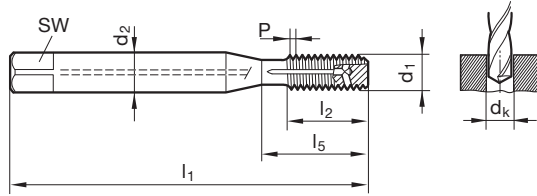

Standard **~DIN 371**
Article no. **2446**

d1	P mm	d2 mm	SW mm	dk mm	l1 mm	l2 mm	l5 mm	Order no.
M5	0.800	6.00	4.90	4.65	70.00	8.50	25.00	2446 5.000
M6	1.000	6.00	4.90	5.55	80.00	11.00	30.00	2446 6.000
M8	1.250	8.00	6.20	7.40	90.00	14.00	35.00	2446 8.000
M10	1.500	10.00	8.00	9.30	100.00	16.00	39.00	2446 10.000

Fluteless taps

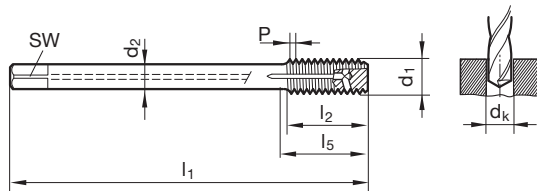

Standard **~DIN 376**
Article no. **2448**

d1	P mm	d2 mm	SW mm	dk mm	l1 mm	l2 mm	l5 mm	Order no.
M12	1.750	9.00	7.00	11.20	110.00	18.50	49.00	2448 12.000
M14	2.000	11.00	9.00	13.10	110.00	20.00	53.00	2448 14.000
M16	2.000	12.00	9.00	15.10	110.00	20.00	54.00	2448 16.000



Fluteless taps with coolant ducts for ISO metric threads

Article no. **2443**



Cutting data page 968



P	M	K	N	S	H
●	●	○	○	○	○

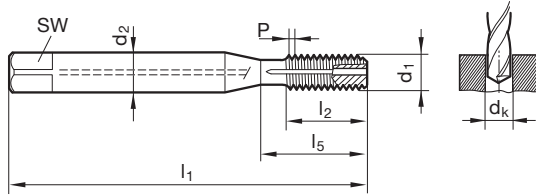

Standard	~DIN 371
Article no.	2443

d1	P	d2	SW	dk	l1	l2	l5	Order no.
mm	mm	mm	mm	mm	mm	mm	mm	
M5	0.800	6.00	4.90	4.65	70.00	8.50	25.00	2443 5.000
M6	1.000	6.00	4.90	5.55	80.00	11.00	30.00	2443 6.000
M8	1.250	8.00	6.20	7.40	90.00	14.00	35.00	2443 8.000
M10	1.500	10.00	8.00	9.30	100.00	16.00	39.00	2443 10.000

Fluteless taps with coolant ducts for ISO metric threads

Article no. **2447**



Cutting data page 968



P	M	K	N	S	H
●	●	○	●	○	○

N ≥ 7% Si

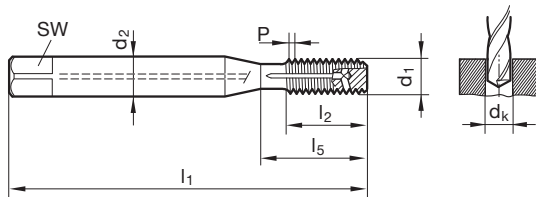

Standard	~DIN 371
Article no.	2447

d1	P	d2	SW	dk	l1	l2	l5	Order no.
mm	mm	mm	mm	mm	mm	mm	mm	
M5	0.800	6.00	4.90	4.65	70.00	8.50	25.00	2447 5.000
M6	1.000	6.00	4.90	5.55	80.00	11.00	30.00	2447 6.000
M8	1.250	8.00	6.20	7.40	90.00	14.00	35.00	2447 8.000
M10	1.500	10.00	8.00	9.30	100.00	16.00	39.00	2447 10.000

Fluteless taps



Thread depth up to 3xD with oil grooves

Fluteless taps with coolant ducts for ISO metric threads

Article no. **4143**



Cutting data page 968

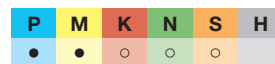

long design

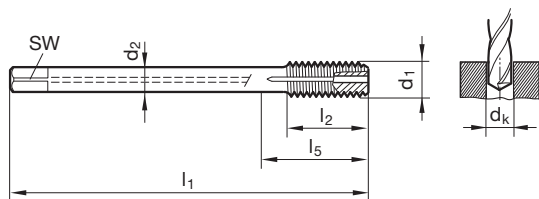

Standard Article no. **Company std. 4143**

d1	P	d2	SW	dk	l1	l2	l5	Order no.
M3	0.500	3.50	2.70	2.80	112.00	6.00	18.00	4143 3.000
M4	0.700	2.80	2.10	3.70	112.00	7.50	77.00	4143 4.000
M5	0.800	3.50	2.70	4.65	125.00	8.50	85.00	4143 5.000
M6	1.000	4.50	3.40	5.55	125.00	11.00	85.00	4143 6.000
M8	1.250	6.00	4.90	7.40	140.00	14.00	95.00	4143 8.000
M10	1.500	7.00	5.50	9.30	160.00	16.00	115.00	4143 10.000
M12	1.750	9.00	7.00	11.20	180.00	18.50	129.00	4143 12.000
M16	2.000	12.00	9.00	15.10	220.00	20.00	163.00	4143 16.000
M20	2.500	16.00	12.00	18.90	280.00	25.00	217.00	4143 20.000

Fluteless taps

Fluteless taps with coolant ducts for ISO metric threads

Article no. **1972**



Cutting data page 968

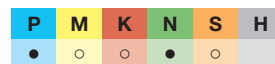

with internal cooling \geq M5

$N \geq 7\%$ Si

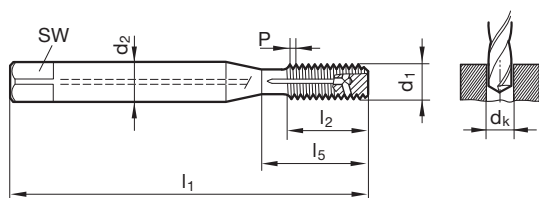

Standard Article no. **~DIN 371 1972**

d1	P	d2	SW	dk	l1	l2	l5	Order no.
M3	0.500	3.50	2.70	2.80	56.00	6.00	18.00	1972 3.000
M4	0.700	4.50	3.40	3.70	63.00	7.50	21.00	1972 4.000
M5	0.800	6.00	4.90	4.65	70.00	8.50	25.00	1972 5.000
M6	1.000	6.00	4.90	5.55	80.00	11.00	30.00	1972 6.000
M8	1.250	8.00	6.20	7.40	90.00	14.00	35.00	1972 8.000
M10	1.500	10.00	8.00	9.30	100.00	16.00	39.00	1972 10.000

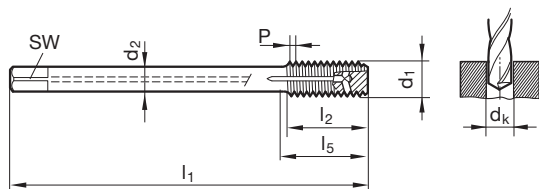

Standard Article no. **~DIN 376 1931**

d1	P	d2	SW	dk	l1	l2	l5	Order no.
M12	1.750	9.00	7.00	11.20	110.00	18.50	49.00	1931 12.000
M14	2.000	11.00	9.00	13.10	110.00	20.00	53.00	1931 14.000
M16	2.000	12.00	9.00	15.10	110.00	20.00	54.00	1931 16.000
M20	2.500	16.00	12.00	18.90	140.00	25.00	62.00	1931 20.000



Fluteless taps with coolant ducts for ISO metric threads

Article no. 1927



Cutting data page 968



with internal cooling \geq M5

P	M	K	N	S	H
●	○	○	●	○	○

N \geq 7% Si

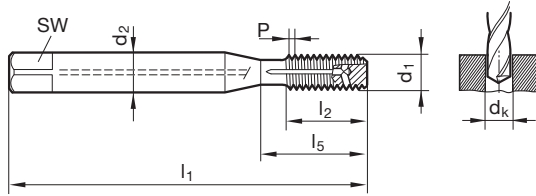

d1	P	d2	SW	dk	l1	l2	l5	Standard	Article no.	Order no.
M3	0.500	3.50	2.70	2.80	56.00	6.00	18.00	~DIN 371	1927	1927 3.000
M4	0.700	4.50	3.40	3.70	63.00	7.50	21.00			1927 4.000
M5	0.800	6.00	4.90	4.65	70.00	8.50	25.00			1927 5.000
M6	1.000	6.00	4.90	5.55	80.00	11.00	30.00			1927 6.000
M8	1.250	8.00	6.20	7.40	90.00	14.00	35.00			1927 8.000
M10	1.500	10.00	8.00	9.30	100.00	16.00	39.00			1927 10.000

Fluteless taps for ISO metric threads

Article no. 4676



Cutting data page 968

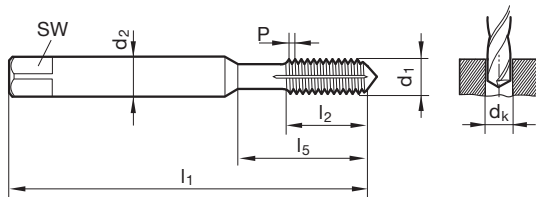

d1	P	d2	SW	dk	l1	l2	l5	Standard	Article no.	Order no.
M2	0.400	2.80	2.10	1.85	45.00	8.00	13.50	~DIN 371	4676	4676 2.000
M2,5	0.450	2.80	2.10	2.30	50.00	9.00	14.50	~DIN 371		4676 2.500
M3	0.500	3.50	2.70	2.80	56.00	10.00	18.00	~DIN 371		4676 3.000
M4	0.700	4.50	3.40	3.70	63.00	12.00	21.00	~DIN 371		4676 4.000
M5	0.800	6.00	4.90	4.65	70.00	14.00	25.00	~DIN 371		4676 5.000
M6	1.000	6.00	4.90	5.55	80.00	16.00	30.00	~DIN 371		4676 6.000
M8	1.250	8.00	6.20	7.40	90.00	17.00	35.00	~DIN 371		4676 8.000
M10	1.500	10.00	8.00	9.30	100.00	20.00	39.00	~DIN 371		4676 10.000
M12	1.750	9.00	7.00	11.20	110.00	24.00	49.00	~DIN 376		4676 12.000
M14	2.000	11.00	9.00	13.10	110.00	26.00	53.00	~DIN 376		4676 14.000
M16	2.000	12.00	9.00	15.10	110.00	26.00	54.00	~DIN 376		4676 16.000

Fluteless taps



Thread depth up to 3xD with oil grooves

Fluteless taps with coolant ducts for ISO metric threads

Article no. **2515**



Cutting data page 968

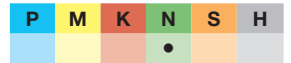

Fluteless taps with coolant ducts for ISO metric threads

Article no. **4146**



Cutting data page 968

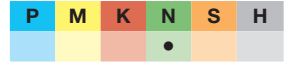

Fluteless taps

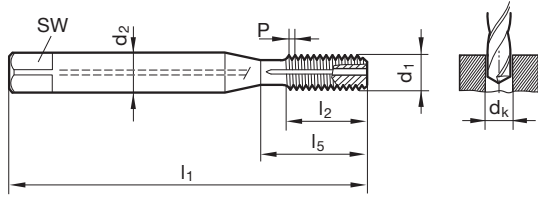

Standard
Article no.

~DIN 371/~DIN 376

2515 4146

d1	P mm	d2 mm	SW mm	dk mm	l1 mm	l2 mm	l5 mm		Order no.	
M5	0.800	6.00	4.90	4.65	70.00	8.50	25.00	~DIN 371	2515 5.000	4146 5.000
M6	1.000	6.00	4.90	5.55	80.00	11.00	30.00	~DIN 371	2515 6.000	4146 6.000
M8	1.250	8.00	6.20	7.40	90.00	14.00	35.00	~DIN 371	2515 8.000	4146 8.000
M10	1.500	10.00	8.00	9.30	100.00	16.00	39.00	~DIN 371	2515 10.000	4146 10.000
M12	1.750	9.00	7.00	11.20	110.00	18.50	49.00	~DIN 376	2515 12.000	4146 12.000
M16	2.000	12.00	9.00	15.10	110.00	20.00	54.00	~DIN 376	2515 16.000	4146 16.000
M20	2.500	16.00	12.00	18.90	140.00	25.00	62.00	~DIN 376	2515 20.000	4146 20.000



Fluteless taps for ISO metric threads

Article no. 4677



Cutting data page 968



with internal cooling \geq M5

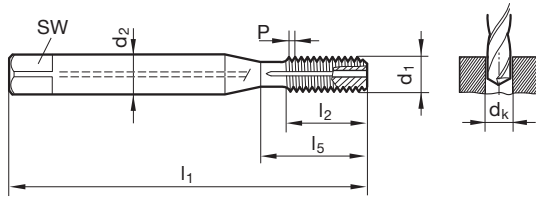

									Standard	~DIN 371/~DIN 376
									Article no.	4677
d1	P	d2	SW	dk	l1	l2	l5		Order no.	
M2	0.400	2.80	2.10	1.85	45.00	8.00	13.50	~DIN 371	4677 2.000	
M2,5	0.450	2.80	2.10	2.30	50.00	9.00	14.50	~DIN 371	4677 2.500	
M3	0.500	3.50	2.70	2.80	56.00	10.00	18.00	~DIN 371	4677 3.000	
M4	0.700	4.50	3.40	3.70	63.00	12.00	21.00	~DIN 371	4677 4.000	
M5	0.800	6.00	4.90	4.65	70.00	14.00	25.00	~DIN 371	4677 5.000	
M6	1.000	6.00	4.90	5.55	80.00	16.00	30.00	~DIN 371	4677 6.000	
M8	1.250	8.00	6.20	7.40	90.00	17.00	35.00	~DIN 371	4677 8.000	
M10	1.500	10.00	8.00	9.30	100.00	20.00	39.00	~DIN 371	4677 10.000	
M12	1.750	9.00	7.00	11.20	110.00	24.00	49.00	~DIN 376	4677 12.000	
M14	2.000	11.00	9.00	13.10	110.00	26.00	53.00	~DIN 376	4677 14.000	
M16	2.000	12.00	9.00	15.10	110.00	26.00	54.00	~DIN 376	4677 16.000	

Fluteless taps

Fluteless taps for ISO metric threads

Article no. 4678



Cutting data page 968



with internal cooling \geq M5

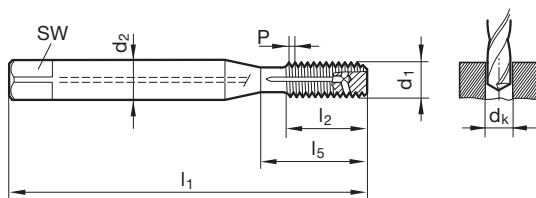

									Standard	~DIN 371/~DIN 376
									Article no.	4678
d1	P	d2	SW	dk	l1	l2	l5		Order no.	
M3	0.500	3.50	2.70	2.80	56.00	6.00	18.00	~DIN 371	4678 3.000	
M4	0.700	4.50	3.40	3.70	63.00	7.50	21.00	~DIN 371	4678 4.000	
M5	0.800	6.00	4.90	4.65	70.00	8.50	25.00	~DIN 371	4678 5.000	
M6	1.000	6.00	4.90	5.55	80.00	11.00	30.00	~DIN 371	4678 6.000	
M8	1.250	8.00	6.20	7.40	90.00	14.00	35.00	~DIN 371	4678 8.000	
M10	1.500	10.00	8.00	9.30	100.00	16.00	39.00	~DIN 371	4678 10.000	
M12	1.750	9.00	7.00	11.20	110.00	18.50	49.00	~DIN 376	4678 12.000	
M14	2.000	11.00	9.00	13.10	110.00	20.00	53.00	~DIN 376	4678 14.000	
M16	2.000	12.00	9.00	15.10	110.00	20.00	54.00	~DIN 376	4678 16.000	



Thread depth up to 3xD with oil grooves

Fluteless taps for ISO metric fine threads

Article no. **1275**



Cutting data page 968

P	M	K	N	S	H
●	●	○	○	○	○

Fluteless taps for ISO metric fine threads

Article no. **1268**



Cutting data page 968

P	M	K	N	S	H
●	●	○	○	○	○

Fluteless taps

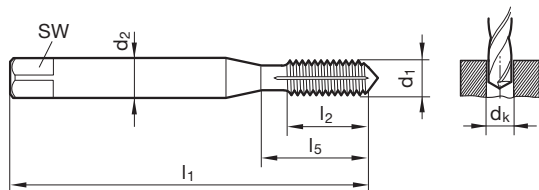

Standard
Article no.

~DIN 371	
1275	1268

d1	d2 mm	SW mm	dk mm	l1 mm	l2 mm	l5 mm
M6 x 0,75	6.00	4.90	5.65	80.00	13.00	30.00
M8 x 1	8.00	6.20	7.55	90.00	17.00	35.00
M10 x 1	10.00	8.00	9.55	90.00	16.00	35.00
M10 x 1,25	10.00	8.00	9.40	100.00	20.00	39.00

Order no.	
1275 6.004	
1275 8.005	1268 8.005
1275 10.005	1268 10.005
1275 10.006	1268 10.006

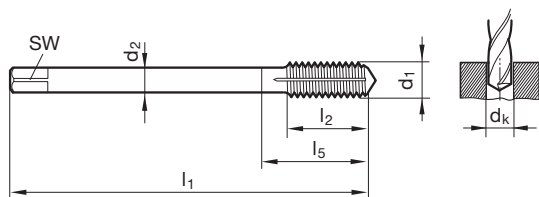

Standard
Article no.

~DIN 374	
927	1269

d1	d2 mm	SW mm	dk mm	l1 mm	l2 mm	l5 mm
M6 x 0,75	4.50	3.40	5.65	80.00	13.00	30.00
M8 x 0,75	6.00	4.90	7.65	80.00	14.00	30.00
M8 x 1	6.00	4.90	7.55	90.00	17.00	35.00
M10 x 1	7.00	5.50	9.55	90.00	16.00	35.00
M10 x 1,25	7.00	5.50	9.40	100.00	20.00	39.00
M12 x 1	9.00	7.00	11.55	100.00	20.00	40.00
M12 x 1,25	9.00	7.00	11.40	100.00	20.00	40.00
M12 x 1,5	9.00	7.00	11.30	100.00	20.00	40.00
M14 x 1	11.00	9.00	13.55	100.00	20.00	40.00
M14 x 1,5	11.00	9.00	13.30	100.00	20.00	40.00
M16 x 1	12.00	9.00	15.55	100.00	22.00	44.00
M16 x 1,5	12.00	9.00	15.30	100.00	22.00	44.00
M18 x 1	14.00	11.00	17.55	110.00	25.00	44.00
M18 x 1,5	14.00	11.00	17.30	110.00	25.00	44.00
M20 x 1	16.00	12.00	19.55	125.00	25.00	44.00
M20 x 1,5	16.00	12.00	19.30	125.00	25.00	44.00
M22 x 1,5	18.00	14.50	21.30	125.00	25.00	44.00
M24 x 1,5	18.00	14.50	23.30	140.00	28.00	48.00
M24 x 2	18.00	14.50	23.10	140.00	28.00	48.00

Order no.	
927 6.004	
927 8.004	
927 8.005	
927 10.005	
927 10.006	
927 12.005	1269 12.005
927 12.006	1269 12.006
927 12.007	
927 14.005	1269 14.005
927 14.007	1269 14.007
927 16.005	
927 16.007	1269 16.007
927 18.005	
927 18.007	1269 18.007
927 20.005	
927 20.007	1269 20.007
927 22.007	
927 24.007	
	1269 24.008



Fluteless taps for ISO metric fine threads

Article no. 1277



Cutting data page 968

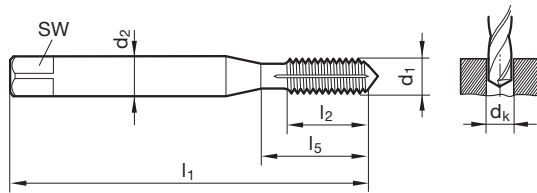

Standard ~DIN 371
Article no. 1277

d1	d2 mm	SW mm	dk mm	l1 mm	l2 mm	l5 mm
M8 x 1	8.00	6.20	7.55	90.00	17.00	35.00
M10 x 1	10.00	8.00	9.55	90.00	16.00	35.00

Order no.
1277 8.005
1277 10.005

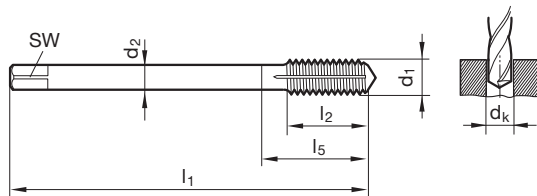

Standard ~DIN 374
Article no. 926

d1	d2 mm	SW mm	dk mm	l1 mm	l2 mm	l5 mm
M8 x 1	6.00	4.90	7.55	90.00	17.00	35.00
M10 x 1	7.00	5.50	9.55	90.00	16.00	35.00
M12 x 1	9.00	7.00	11.55	100.00	20.00	40.00
M12 x 1,5	9.00	7.00	11.30	100.00	20.00	40.00
M14 x 1,5	11.00	9.00	13.30	100.00	20.00	40.00
M16 x 1,5	12.00	9.00	15.30	100.00	22.00	44.00
M18 x 1,5	14.00	11.00	17.30	110.00	25.00	44.00
M20 x 1,5	16.00	12.00	19.30	125.00	25.00	44.00

Order no.
926 8.005
926 10.005
926 12.005
926 12.007
926 14.007
926 16.007
926 18.007
926 20.007

Fluteless taps



Thread depth up to 3xD with oil grooves

Fluteless taps with coolant ducts for ISO metric fine threads

Article no. **4145**



Cutting data page 968

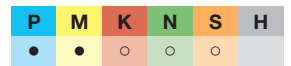

long design

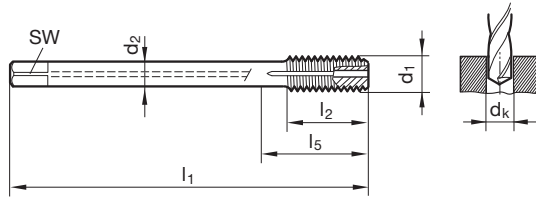

Standard
Article no.

Company std.
4145

	d1	d2	SW	dk	l1	l2	l5	Order no.
		mm	mm	mm	mm	mm	mm	
M8 x 1		6.00	4.90	7.55	140.00	14.00	95.00	4145 8.005
M10 x 1		7.00	5.50	9.55	160.00	16.00	115.00	4145 10.005
M10 x 1,25		7.00	5.50	9.40	160.00	16.00	115.00	4145 10.006
M12 x 1		9.00	7.00	11.55	180.00	18.50	129.00	4145 12.005
M12 x 1,5		9.00	7.00	11.30	180.00	18.50	129.00	4145 12.007
M14 x 1,5		11.00	9.00	13.30	220.00	20.00	163.00	4145 14.007
M16 x 1,5		12.00	9.00	15.30	220.00	20.00	163.00	4145 16.007

Fluteless taps



Fluteless taps with coolant ducts for ISO metric fine threads

Article no. 1581



Cutting data page 968



P	M	K	N	S	H
●	○	○	●	○	○

N ≥ 7% Si

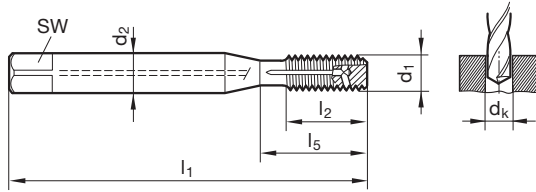

Standard	~DIN 371/~DIN 376
Article no.	1581

d1	d2 mm	SW mm	dk mm	l1 mm	l2 mm	l5 mm		Order no.
M10 x 1	10.00	8.00	9.55	90.00	11.00	35.00	~DIN 371	1581 10.005
M12 x 1	9.00	7.00	11.55	100.00	15.00	40.00	~DIN 374	1581 12.005
M12 x 1,5	9.00	7.00	11.30	100.00	15.00	40.00	~DIN 374	1581 12.007
M14 x 1	11.00	9.00	13.55	100.00	15.00	40.00	~DIN 374	1581 14.005
M14 x 1,25	11.00	9.00	13.40	100.00	15.00	40.00	~DIN 374	1581 14.006
M14 x 1,5	11.00	9.00	13.30	100.00	15.00	40.00	~DIN 374	1581 14.007
M16 x 1,5	12.00	9.00	15.30	100.00	15.00	44.00	~DIN 374	1581 16.007
M18 x 1,5	14.00	11.00	17.30	110.00	15.00	44.00	~DIN 374	1581 18.007
M20 x 1,5	16.00	12.00	19.30	125.00	15.00	44.00	~DIN 374	1581 20.007
M24 x 1,5	18.00	14.50	23.30	140.00	15.00	48.00	~DIN 374	1581 24.007

Fluteless taps



Thread depth up to 3xD with oil grooves

Fluteless taps with coolant ducts for ISO metric fine threads

Article no. **4147**



Cutting data page 968

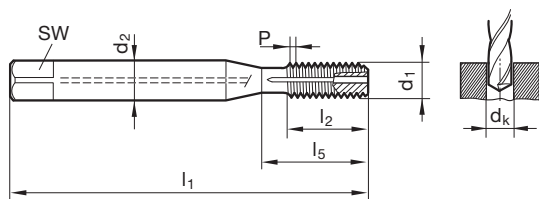
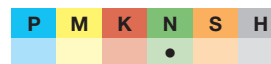

Standard ~DIN 371/~DIN 374
Article no. **4147**

d1	d2 mm	SW mm	dk mm	l1 mm	l2 mm	l5 mm		Order no.
M8 x 1	8.00	6.20	7.55	90.00	16.00	35.00	~DIN 371	4147 8.005
M10 x 1	10.00	8.00	9.55	90.00	16.00	35.00	~DIN 371	4147 10.005
M10 x 1,25	10.00	8.00	9.40	100.00	16.00	39.00	~DIN 371	4147 10.006
M12 x 1	9.00	7.00	11.55	100.00	16.00	40.00	~DIN 374	4147 12.005
M12 x 1,5	9.00	7.00	11.30	100.00	16.00	40.00	~DIN 374	4147 12.007
M14 x 1,5	11.00	9.00	13.30	100.00	16.00	40.00	~DIN 374	4147 14.007
M16 x 1,5	12.00	9.00	15.30	100.00	16.00	44.00	~DIN 374	4147 16.007

Fluteless taps



Fluteless taps for UNC threads

Article no. 1582



Cutting data page 968

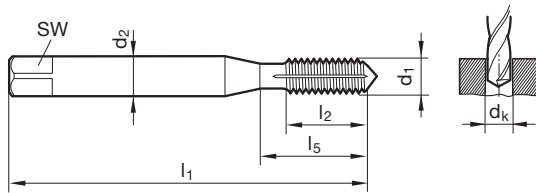

Standard ~DIN 371
Article no. 1582

d1	d2 mm	SW mm	dk mm	l1 mm	l2 mm	l5 mm
4 - 40	3.50	2.70	2.55	56.00	11.00	18.00
5 - 40	3.50	2.70	2.90	56.00	11.00	18.00
6 - 32	4.00	3.00	3.15	56.00	12.00	20.00
8 - 32	4.50	3.40	3.80	63.00	12.00	21.00
10 - 24	6.00	4.90	4.35	70.00	14.00	25.00
12 - 24	6.00	4.90	5.00	80.00	16.00	30.00
1/4 - 20	7.00	5.50	5.75	80.00	16.00	30.00
5/16 - 18	8.00	6.20	7.30	90.00	18.00	35.00
3/8 - 16	10.00	8.00	8.80	100.00	20.00	39.00

Order no.

1582 2.845
1582 3.175
1582 3.505
1582 4.166
1582 4.826
1582 5.486
1582 6.350
1582 7.938
1582 9.525

Fluteless taps

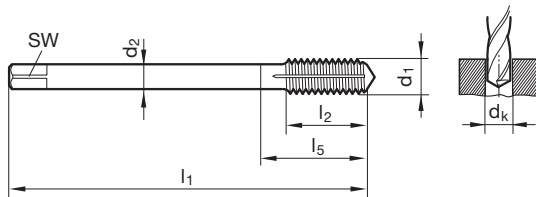

Standard ~DIN 376
Article no. 1583

d1	d2 mm	SW mm	dk mm	l1 mm	l2 mm	l5 mm
1/2 - 13	9.00	7.00	11.80	110.00	25.00	49.00
9/16 - 12	11.00	9.00	13.30	110.00	28.00	53.00
5/8 - 11	12.00	9.00	14.80	110.00	30.00	53.00
3/4 - 10	14.00	11.00	17.90	125.00	33.00	62.00

Order no.

1583 12.700
1583 14.288
1583 15.875
1583 19.050



Fluteless taps for UNF threads

Article no. **1584**



Cutting data page 968

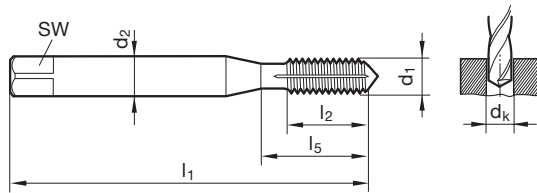

Standard

~DIN 371

Article no.

1584

Fluteless taps

d1	d2 mm	SW mm	dk mm	l1 mm	l2 mm	l5 mm
4 - 48	3.50	2.70	2.60	56.00	10.00	18.00
5 - 44	3.50	2.70	2.90	56.00	10.00	18.00
6 - 40	4.00	3.00	3.20	56.00	11.00	20.00
8 - 36	4.50	3.40	3.85	63.00	12.00	21.00
10 - 32	6.00	4.90	4.45	70.00	14.00	25.00
12 - 28	6.00	4.90	5.10	80.00	16.00	30.00
1/4 - 28	7.00	5.50	5.95	80.00	16.00	30.00
5/16 - 24	8.00	6.20	7.45	90.00	17.00	35.00
3/8 - 24	10.00	8.00	9.05	90.00	18.00	35.00

Order no.

1584 2.845
1584 3.175
1584 3.505
1584 4.166
1584 4.826
1584 5.486
1584 6.350
1584 7.938
1584 9.525

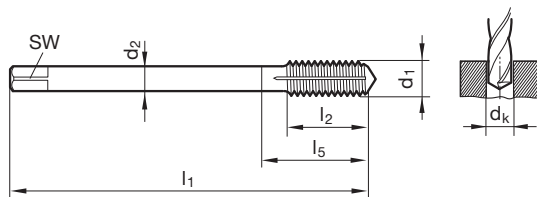

Standard

~DIN 374

Article no.

1585

d1	d2 mm	SW mm	dk mm	l1 mm	l2 mm	l5 mm
7/16 - 20	8.00	6.20	10.55	100.00	22.00	42.00
1/2 - 20	9.00	7.00	12.10	100.00	20.00	40.00
9/16 - 18	11.00	9.00	13.65	100.00	22.00	40.00
5/8 - 18	12.00	9.00	15.25	100.00	22.00	44.00
3/4 - 16	14.00	11.00	18.35	110.00	25.00	44.00

Order no.

1585 11.113
1585 12.700
1585 14.288
1585 15.875
1585 19.050



Fluteless taps for BSP threads

Article no. 1586



Cutting data page 968



P	M	K	N	S	H
•	•	○	○	○	

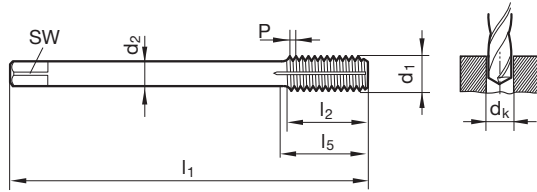

Standard	DIN 2189
Article no.	1586

d1	P G/inch	d2 mm	SW mm	dk mm	l1 mm	l2 mm	l5 mm	Order no.
G1/8	28	7.00	5.50	9.30	90.00	18.00	35.00	1586 9.728
G1/4	19	11.00	9.00	12.50	100.00	20.00	40.00	1586 13.157
G3/8	19	12.00	9.00	16.00	100.00	22.00	44.00	1586 16.662
G1/2	14	16.00	12.00	20.00	125.00	25.00	44.00	1586 20.955
G3/4	14	20.00	16.00	25.50	140.00	28.00	53.00	1586 26.441

Fluteless taps with coolant ducts for BSP threads

Article no. 4152



Cutting data page 968



P	M	K	N	S	H
			•		

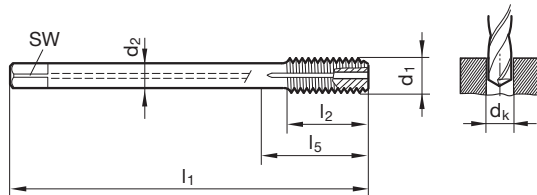

Standard	DIN 2189
Article no.	4152

d1	P G/inch	d2 mm	SW mm	dk mm	l1 mm	l2 mm	l5 mm	Order no.
G1/8	28	7.00	5.50	9.30	90.00	11.00	35.00	4152 9.728
G1/4	19	11.00	9.00	12.50	100.00	14.00	40.00	4152 13.157
G3/8	19	12.00	9.00	16.00	100.00	14.00	44.00	4152 16.662
G1/2	14	16.00	12.00	20.00	125.00	18.00	44.00	4152 20.955
G3/4	14	20.00	16.00	25.50	140.00	20.00	53.00	4152 26.441
G1	11	25.00	20.00	32.00	160.00	24.00	56.00	4152 33.249

Fluteless taps



Thread milling cutters without chamfer

Thread milling cutters

Thread milling cutters without chamfer for ISO metric threads

Article no. **4132**



Cutting data page 972



without chamfer

P	M	K	N	S	H
●	●	●	●	○	○

H = 55 HRC

Thread milling cutters without chamfer for ISO metric threads

Article no. **4133**



Cutting data page 972



without chamfer

P	M	K	N	S	H
●	●	●	●	○	○

H = 55 HRC

Thread milling cutters without chamfer for ISO metric threads

Article no. **3737**



Cutting data page 972



without chamfer

P	M	K	N	S	H
●	●	●	●	○	○

H = 55 HRC

Thread milling cutters without chamfer for ISO metric threads

Article no. **3743**



Cutting data page 972



without chamfer

P	M	K	N	S	H
●	●	●	●	○	○

H = 55 HRC

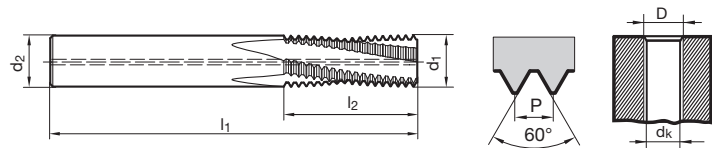

Standard
Article no.

Standard Article no.	Company std.			
	4132	4133	3737	3743
	Order no.			
			3737 3.000	
			3737 4.000	3743 4.000
			3737 5.000	3743 5.000
			3737 6.000	3743 6.000
	4132 6.000	4133 6.000	3737 6.000	3743 6.000
	4132 8.000	4133 8.000	3737 8.000	3743 8.000
			3737 8.005	3743 8.005
	4132 10.000	4133 10.000	3737 10.000	3743 10.000
			3737 10.005	3743 10.005
			3737 10.006	3743 10.006
	4132 12.000	4133 12.000	3737 12.000	3743 12.000
			3737 12.007	3743 12.007
	4132 14.000	4133 14.000	3737 14.000	3743 14.000
			3737 14.007	3743 14.007
	4132 16.000	4133 16.000	3737 16.000	3743 16.000
			3737 16.007	3743 16.007
	4132 20.000	4133 20.000	3737 20.000	3743 20.000
			3737 20.007	3743 20.007

D	P mm	d1 mm	d2 mm	dk mm	l1 mm	l2 mm	Z
M3	0.500	2.30	4.00	2.50	40.00	6.80	3
M4	0.700	3.00	6.00	3.30	48.00	8.80	3
M5	0.800	4.00	6.00	4.20	54.00	10.80	3
M6	1.000	4.80	6.00	5.00	54.00	13.50	3
M8	1.250	6.40	8.00	6.80	62.00	18.10	3
M8 x 1	1.000	6.40	8.00	7.00	62.00	17.50	3
M10	1.500	7.95	10.00	8.50	74.00	21.80	3
M10 x 1	1.000	7.95	10.00	9.00	74.00	21.50	3
M10 x 1,25	1.250	7.95	10.00	8.80	74.00	21.90	3
M12	1.750	9.95	10.00	10.20	74.00	25.40	4
M12 x 1,5	1.500	9.95	10.00	10.50	74.00	26.30	4
M14	2.000	11.20	12.00	12.00	90.00	31.00	4
M14 x 1,5	1.500	11.20	12.00	12.50	90.00	30.80	4
M16	2.000	12.80	14.00	14.00	90.00	35.00	4
M16 x 1,5	1.500	12.80	14.00	14.50	90.00	33.80	4
M20	2.500	14.95	16.00	17.50	102.00	41.30	4
M20 x 1,5	1.500	14.95	16.00	18.50	102.00	42.80	4



Thread milling cutters without chamfer for ISO metric threads

Article no. **3735**



without chamfer

Cutting data page 972

P	M	K	N	S	H
●	●	●	●	○	○

H = 55 HRC

Thread milling cutters without chamfer for ISO metric threads

Article no. **3740**



without chamfer

Cutting data page 972

P	M	K	N	S	H
●	●	●	●	○	○

H = 55 HRC

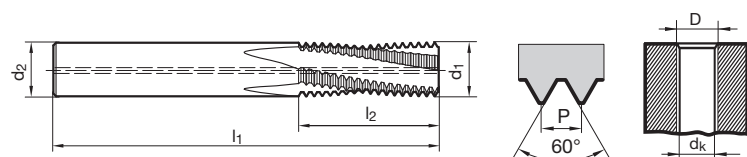

Standard
Article no.

Company std.	
3735	3740

D	P mm	d1 mm	d2 mm	dk mm	l1 mm	l2 mm	Z
M6	1.000	4.80	6.00	5.00	54.00	16.50	3
M8	1.250	6.40	8.00	6.80	62.00	21.90	3
M10	1.500	7.95	10.00	8.50	74.00	26.30	3
M12	1.750	9.95	10.00	10.20	74.00	32.40	4
M14	2.000	11.20	12.00	12.00	90.00	37.00	4
M16	2.000	12.80	14.00	14.00	90.00	43.00	4
M20	2.500	14.95	16.00	17.50	102.00	48.80	4

Order no.	
3735 6.000	3740 6.000
3735 8.000	3740 8.000
3735 10.000	3740 10.000
3735 12.000	3740 12.000
3735 14.000	3740 14.000
3735 16.000	3740 16.000
3735 20.000	3740 20.000

Thread milling cutters



Thread milling cutters without chamfer

Thread milling cutters without chamfer for UNC threads

Article no. **4134**



without chamfer

Cutting data page 972

P	M	K	N	S	H
●	●	●	●	○	○

H = 55 HRC

Thread milling cutters without chamfer for UNC threads

Article no. **4135**



without chamfer

Cutting data page 972

P	M	K	N	S	H
●	●	●	●	○	○

H = 55 HRC

Thread milling cutters

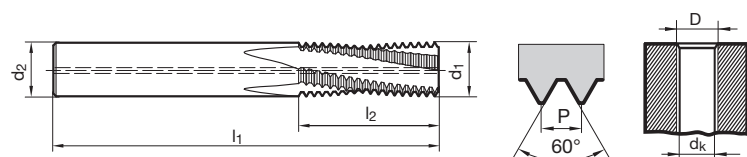

Standard
Article no.

Company std.	
4134	4135

D	d1 mm	d2 mm	dk mm	l1 mm	l2 mm	Z
10 - 24	3.40	6.00	3.90	54.00	11.10	3
12 - 24	4.10	6.00	4.50	54.00	12.20	3
1/4 - 20	4.70	6.00	5.10	54.00	14.60	3
5/16 - 18	6.10	8.00	6.60	64.00	17.60	3
3/8 - 16	7.60	8.00	8.00	64.00	21.40	3
7/16 - 14	9.00	10.00	9.40	74.00	24.50	3
1/2 - 13	9.95	10.00	10.80	74.00	28.30	4
9/16 - 12	11.40	12.00	12.20	90.00	30.70	4
5/8 - 11	12.70	14.00	13.50	90.00	35.80	4

Order no.	
4134 4.826	4135 4.826
4134 5.486	4135 5.486
4134 6.350	4135 6.350
4134 7.938	4135 7.938
4134 9.525	4135 9.525
4134 11.113	4135 11.113
4134 12.700	4135 12.700
4134 14.288	4135 14.288
4134 15.875	4135 15.875

Thread milling cutters without chamfer for UNF threads

Article no. **4136**



without chamfer

Cutting data page 972

P	M	K	N	S	H
●	●	●	●	○	○

H = 55 HRC

Thread milling cutters without chamfer for UNF threads

Article no. **4137**



without chamfer

Cutting data page 972

P	M	K	N	S	H
●	●	●	●	○	○

H = 55 HRC

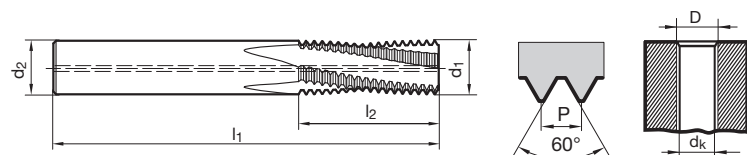

Standard
Article no.

Company std.	
4136	4137

D	d1 mm	d2 mm	dk mm	l1 mm	l2 mm	Z
10 - 32	3.80	6.00	4.10	54.00	11.50	3
12 - 28	4.30	6.00	4.60	54.00	12.20	3
1/4 - 28	5.10	6.00	5.50	54.00	14.10	3
5/16 - 24	6.30	8.00	6.90	64.00	17.50	3
3/8 - 24	7.80	8.00	8.50	64.00	20.60	3
7/16 - 20	9.40	10.00	9.90	74.00	24.80	3
1/2 - 20	9.95	10.00	11.50	74.00	27.30	4
9/16 - 18	11.40	12.00	12.90	90.00	30.30	4
5/8 - 18	12.70	14.00	14.50	90.00	33.20	4

Order no.	
4136 4.826	4137 4.826
4136 5.486	4137 5.486
4136 6.350	4137 6.350
4136 7.938	4137 7.938
4136 9.525	4137 9.525
4136 11.113	4137 11.113
4136 12.700	4137 12.700
4136 14.288	4137 14.288
4136 15.875	4137 15.875



Thread milling cutters without chamfer for BSP threads

Article no. 3745



without chamfer

Cutting data page 972

P	M	K	N	S	H
●	●	●	●	○	○

H = 55 HRC

Thread milling cutters without chamfer for BSP threads

Article no. 3748



without chamfer

Cutting data page 972

P	M	K	N	S	H
●	●	●	●	○	○

H = 55 HRC

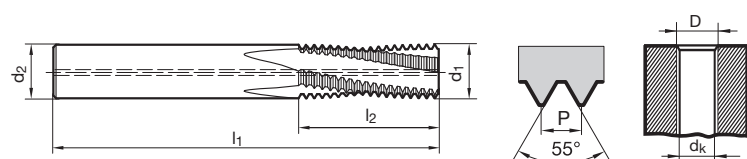

Standard
Article no.

Company std.	
3745	3748
Order no.	
3745 9.728	3748 9.728
3745 13.157	3748 13.157
3745 16.662	3748 16.662

D	P G/inch	d1 mm	d2 mm	dk mm	l1 mm	l2 mm	Z
G1/8	28	7.95	8.00	8.80	64.00	21.30	3
G1/4	19	10.50	12.00	11.80	90.00	28.70	4
G3/8	19	13.60	14.00	15.25	90.00	35.40	4

Thread milling cutters without chamfer for NPT threads

Article no. 3753



without chamfer

Cutting data page 972

P	M	K	N	S	H
●	●	●	●	●	○

H = 55 HRC

Thread milling cutters without chamfer for NPT threads

Article no. 3754



without chamfer

Cutting data page 972

P	M	K	N	S	H
●	●	●	●	○	○

H = 55 HRC

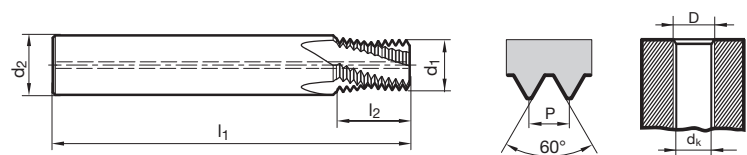

Standard
Article no.

Company std.	
3753	3754
Order no.	
3753 8.190	3754 8.190
3753 10.620	3754 10.620
3753 14.140	3754 14.140
3753 17.570	3754 17.570

D	P G/inch	d1 mm	d2 mm	dk mm	l1 mm	l2 mm	Z
1/16	27	5.90	8.00	6.15	54.00	9.90	3
1/8	27	7.30	8.00	8.40	64.00	9.90	3
1/4	18	9.95	12.00	11.10	72.00	19.00	4
3/8	18	12.50	14.00	14.30	80.00	14.80	4



Thread milling cutters with chamfer

Thread milling cutters with chamfer for ISO metric threads

Article no. **3526**



with chamfer

Cutting data page 972

P	M	K	N	S	H
•	•	•	•	•	○

H = 55 HRC

Thread milling cutters with chamfer for ISO metric threads

Article no. **3544**



with chamfer

Cutting data page 972

P	M	K	N	S	H
•	•	•	•	•	○

H = 55 HRC

Thread milling cutters

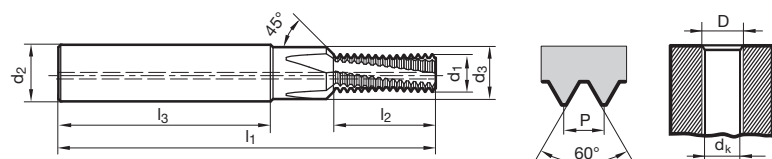

Standard
Article no.

Company std.	
3526	3544

D	P mm	d1 mm	d2 mm	d3 mm	dk mm	l1 mm	l3 mm	l2 mm	Z
M3	0.500	2.30	6.00	3.40	2.50	48.00	36.00	6.80	3
M4	0.700	3.00	6.00	4.50	3.30	48.00	36.00	8.80	3
M5	0.800	4.00	6.00	5.50	4.20	54.00	36.00	10.80	3
M6	1.000	4.80	8.00	6.60	5.00	62.00	36.00	13.50	3
M8	1.250	6.40	10.00	9.00	6.80	74.00	40.00	18.10	3
M10	1.500	7.95	12.00	11.00	8.50	80.00	45.00	21.80	4
M12	1.750	9.95	14.00	13.50	10.20	90.00	45.00	25.40	4
M14	2.000	11.20	16.00	15.50	12.00	102.00	48.00	31.00	4
M16	2.000	12.80	18.00	17.50	14.00	102.00	48.00	35.00	4
M20	2.500	14.50	20.00	21.50	17.50	125.00	50.00	41.30	4

Order no.	
3526 3.000	3544 3.000
3526 4.000	3544 4.000
3526 5.000	3544 5.000
3526 6.000	3544 6.000
3526 8.000	3544 8.000
3526 10.000	3544 10.000
3526 12.000	3544 12.000
3526 14.000	3544 14.000
3526 16.000	3544 16.000
3526 20.000	3544 20.000



Thread milling cutters with chamfer for ISO metric fine threads

Article no. 3528



with chamfer

Cutting data page 972

P	M	K	N	S	H
●	●	●	●	●	○

H = 55 HRC

Thread milling cutters with chamfer for ISO metric fine threads

Article no. 3546



with chamfer

Cutting data page 972

P	M	K	N	S	H
●	●	●	●	●	○

H = 55 HRC

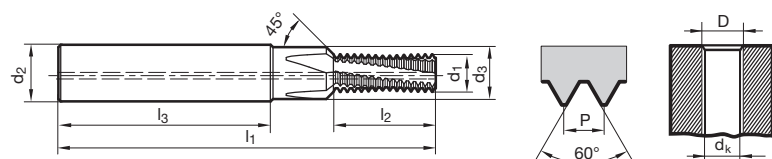

Standard Article no.

Company std.	
3528	3546

D	P mm	d1 mm	d2 mm	d3 mm	dk mm	l1 mm	l3 mm	l2 mm	Z	Order no.	
M4 x 0,5	0.500	3.00	6.00	4.50	3.50	48.00	36.00	8.80	3	3528 4.003	3546 4.003
M5 x 0,5	0.500	4.00	6.00	5.50	4.50	54.00	36.00	10.80	3	3528 5.003	3546 5.003
M6 x 0,5	0.500	4.80	8.00	6.60	5.50	62.00	36.00	12.80	3	3528 6.003	3546 6.003
M6 x 0,75	0.750	4.80	8.00	6.60	5.20	62.00	36.00	13.10	3	3528 6.004	3546 6.004
M8 x 0,75	0.750	6.40	10.00	9.00	7.20	74.00	40.00	16.90	3	3528 8.004	3546 8.004
M8 x 1	1.000	6.40	10.00	9.00	7.00	74.00	40.00	17.50	3	3528 8.005	3546 8.005
M10 x 1	1.000	7.95	12.00	11.00	9.00	80.00	45.00	21.50	4	3528 10.005	3546 10.005
M10 x 1,25	1.250	7.95	12.00	11.00	8.80	80.00	45.00	21.90	4	3528 10.006	3546 10.006
M12 x 1	1.000	9.95	14.00	13.50	11.00	90.00	45.00	25.50	4	3528 12.005	3546 12.005
M12 x 1,5	1.500	9.95	14.00	13.50	10.50	90.00	45.00	26.30	4	3528 12.007	3546 12.007
M14 x 1,5	1.500	11.20	16.00	15.50	12.50	102.00	48.00	30.80	4	3528 14.007	3546 14.007
M16 x 1,5	1.500	12.80	18.00	17.50	14.50	102.00	48.00	33.80	4	3528 16.007	3546 16.007

Thread milling cutters

Thread milling cutters with chamfer for BSP threads

Article no. 3515



with chamfer

Cutting data page 972

P	M	K	N	S	H
●	●	●	●	●	○

H = 55 HRC

Thread milling cutters with chamfer for BSP threads

Article no. 3533



with chamfer

Cutting data page 972

P	M	K	N	S	H
●	●	●	●	●	○

H = 55 HRC

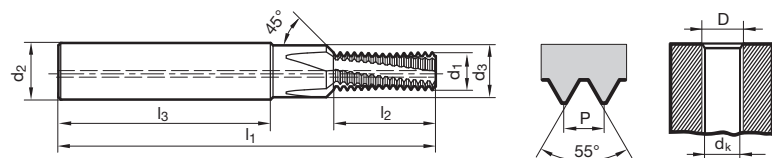

Standard Article no.

Company std.	
3515	3533

D	P G/inch	d1 mm	d2 mm	d3 mm	dk mm	l1 mm	l3 mm	l2 mm	Z	Order no.	
G1/8	28	7.95	12.00	11.00	8.80	80.00	45.00	21.30	4	3515 9.728	3533 9.728
G1/4	19	9.95	14.00	13.90	11.80	90.00	45.00	28.70	4	3515 13.157	3533 13.157
G3/8	19	13.60	18.00	17.50	15.25	102.00	48.00	35.40	4	3515 16.662	3533 16.662



Universal thread milling cutters for ISO metric threads

Article no. **3541**



Universal thread milling cutters for internal threads M/MF

Cutting data page 972

P	M	K	N	S	H
●	●	●	●	●	○

H = 55 HRC

Universal thread milling cutters for ISO metric threads

Article no. **3556**



Universal thread milling cutters for internal threads M/MF

Cutting data page 972

P	M	K	N	S	H
●	●	●	●	●	○

H = 55 HRC

Thread milling cutters

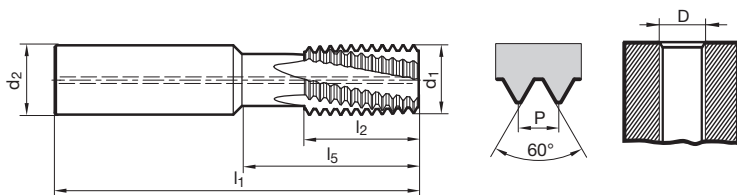

Standard
Article no.

Company std.	
3541	3556

P mm	D	d1 mm	d2 mm	l1 mm	l5 mm	l2 mm	Z
0.500	≥ 10	7.95	8.00	64.00	20.00	20.00	4
1.000	≥ 12	9.95	10.00	70.00	25.00	16.00	4
1.250	≥ 14	9.95	10.00	70.00	25.00	16.00	4
1.500	≥ 14	9.95	10.00	70.00	25.00	16.00	4
1.000	≥ 16	11.95	12.00	80.00	31.00	20.00	4
1.250	≥ 16	11.95	12.00	80.00	31.00	20.00	4
1.500	≥ 16	11.95	12.00	80.00	31.00	20.00	4
1.000	≥ 18	15.95	16.00	90.00	40.00	25.00	5
1.500	≥ 20	15.95	16.00	90.00	40.00	25.00	5
2.000	≥ 22	15.95	16.00	90.00	40.00	25.00	5
3.000	≥ 24	17.95	18.00	102.00	50.00	33.00	5
1.000	≥ 24	19.95	20.00	105.00	50.00	33.00	5
1.500	≥ 26	19.95	20.00	105.00	50.00	33.00	5
2.000	≥ 26	19.95	20.00	105.00	50.00	33.00	5
2.500	≥ 26	19.95	20.00	105.00	50.00	33.00	5
3.000	≥ 27	19.95	20.00	105.00	50.00	33.00	5
3.500	≥ 30	19.95	20.00	105.00	50.00	33.00	5

Order no.	
3541 8.050	3556 8.050
3541 10.100	3556 10.100
3541 10.125	3556 10.125
3541 10.150	3556 10.150
3541 12.100	3556 12.100
3541 12.125	3556 12.125
3541 12.150	3556 12.150
3541 16.100	3556 16.100
3541 16.150	3556 16.150
3541 16.200	3556 16.200
3541 18.300	3556 18.300
3541 20.100	3556 20.100
3541 20.150	3556 20.150
3541 20.200	3556 20.200
3541 20.250	3556 20.250
3541 20.300	3556 20.300
3541 20.350	3556 20.350



Universal thread milling cutters for UN threads

Article no. 3595



Universal thread milling cutters for internal threads

Cutting data page 972

P	M	K	N	S	H
●	●	●	●	●	○

H = 55 HRC

Universal thread milling cutters for UN threads

Article no. 3596



Universal thread milling cutters for internal threads

Cutting data page 972

P	M	K	N	S	H
●	●	●	●	●	○

H = 55 HRC

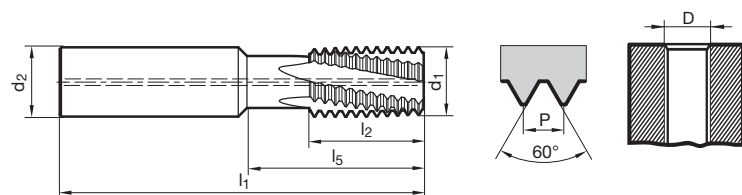

Standard
Article no.

Company std.	
3595	3596

P G/inch	D	d1 mm	d2 mm	l1 mm	l5 mm	l2 mm	Z
24	≥ 1/2	9.95	10.00	70.00	25.00	16.00	4
10	≥ 3/4	11.95	12.00	80.00	31.00	20.00	4
16	≥ 5/8	11.95	12.00	80.00	31.00	20.00	4
18	≥ 5/8	11.95	12.00	80.00	31.00	20.00	4
20	≥ 11/16	11.95	12.00	80.00	31.00	20.00	4
24	≥ 5/8	11.95	12.00	80.00	31.00	20.00	4
8	≥ 7/8	15.95	16.00	90.00	40.00	25.00	5
9	≥ 7/8	15.95	16.00	90.00	40.00	25.00	5
12	≥ 7/8	15.95	16.00	90.00	40.00	25.00	5
14	≥ 7/8	15.95	16.00	90.00	40.00	25.00	5
16	≥ 7/8	15.95	16.00	90.00	40.00	25.00	5
18	≥ 7/8	15.95	16.00	90.00	40.00	25.00	5
20	≥ 13/16	15.95	16.00	90.00	40.00	25.00	5
7	≥ 1	19.95	20.00	105.00	50.00	33.00	5
8	≥ 1	19.95	20.00	105.00	50.00	33.00	5
12	≥ 1	19.95	20.00	105.00	50.00	33.00	5
14	≥ 1	19.95	20.00	105.00	50.00	33.00	5
16	≥ 1	19.95	20.00	105.00	50.00	33.00	5

Order no.	
3595 10.240	3596 10.240
	3596 12.100
3595 12.160	3596 12.160
3595 12.180	3596 12.180
3595 12.200	3596 12.200
3595 12.240	3596 12.240
	3596 16.080
	3596 16.090
	3596 16.120
3595 16.140	3596 16.140
3595 16.160	3596 16.160
3595 16.180	3596 16.180
3595 16.200	3596 16.200
	3596 20.070
3595 20.080	3596 20.080
3595 20.120	3596 20.120
3595 20.140	3596 20.140
3595 20.160	3596 20.160

Thread milling cutters



Universal thread milling cutters for BSP threads

Article no. **3542**



Cutting data page 972



Universal thread milling cutters for internal and external threads

P	M	K	N	S	H
●	●	●	●	●	○

H = 55 HRC

Universal thread milling cutters for BSP threads

Article no. **3557**



Cutting data page 972



Universal thread milling cutters for internal and external threads

P	M	K	N	S	H
●	●	●	●	●	○

H = 55 HRC

Thread milling cutters

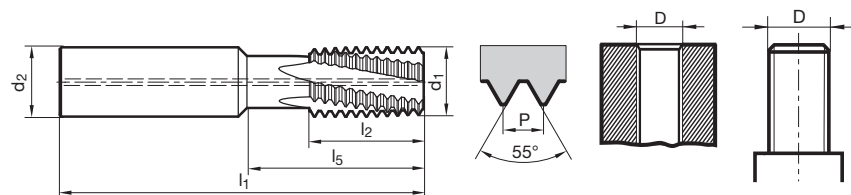

Standard
Article no.

Company std.

3542 **3557**

P	D	d1	d2	l1	l5	l2	Z
G/inch		mm	mm	mm	mm	mm	
19	≥ 1/4	9.95	10.00	70.00	25.00	16.00	4
14	≥ 1/2	15.95	16.00	90.00	40.00	25.00	5
11	≥ 1	19.95	20.00	105.00	50.00	33.00	5

Order no.

3542 10.190	3557 10.190
3542 16.140	3557 16.140
3542 20.110	3557 20.110

Universal thread milling cutters for NPT threads

Article no. **3768**



Cutting data page 972



Universal thread milling cutters for internal and external threads

P	M	K	N	S	H
●	●	●	●	●	○

H = 55 HRC

Universal thread milling cutters for NPT threads

Article no. **3769**



Cutting data page 972



Universal thread milling cutters for internal and external threads

P	M	K	N	S	H
●	●	●	●	●	○

H = 55 HRC

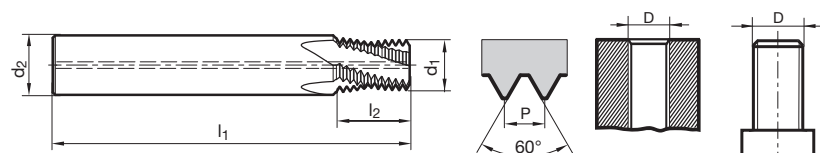

Standard
Article no.

Company std.

3768 **3769**

P	D	d1	d2	l1	l2	Z
G/inch		mm	mm	mm	mm	
14	≥ 1/2	14.50	16.00	90.00	19.05	5
11	≥ 1	18.50	20.00	90.00	23.19	5

Order no.

3768 21.900	3769 21.900
3768 34.180	3769 34.180



Universal thread milling cutters for Rc threads

Article no. 4770



Cutting data page 972



P	M	K	N	S	H
•	•	•	•	•	○

Universal thread milling cutters for internal and external threads

H = 55 HRC

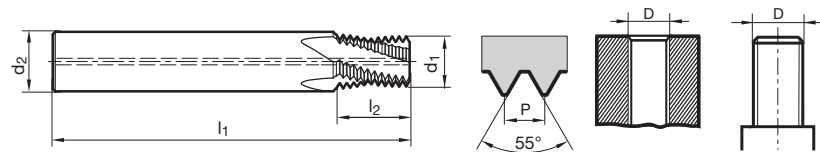

P G/inch	D	d1 mm	d2 mm	l1 mm	l2 mm	Z
28	Rc1/8	7.40	8.00	64.00	8.60	3
19	Rc1/4-Rc3/8	9.12	10.00	74.00	14.04	4
14	Rc1/2-Rc3/4	14.80	16.00	90.00	19.05	5
11	Rc 1-Rc 2	18.00	20.00	105.00	33.40	5

Standard Article no.	Company std.
	4770
Order no.	
	4770 9.728
	4770 13.157
	4770 20.955
	4770 33.249

External thread milling cutters for ISO metric threads

Article no. 4162



Cutting data page 972



P	M	K	N	S	H
•	•	•	•	•	○

Universal thread milling cutters for external threads M/MF

H = 55 HRC

External thread milling cutters for ISO metric threads

Article no. 4163



Cutting data page 972



P	M	K	N	S	H
•	•	•	•	•	○

Universal thread milling cutters for external threads M/MF

H = 55 HRC

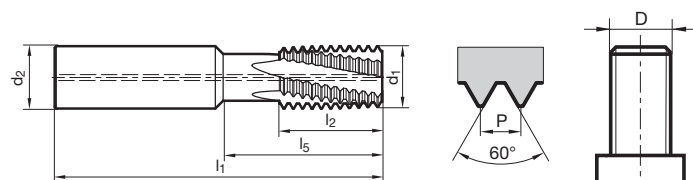

P mm	D	d1 mm	d2 mm	l1 mm	l5 mm	l2 mm	Z
0.500	≥ 3	9.95	10.00	70.00	25.00	16.00	4
0.700	≥ 4	9.95	10.00	70.00	25.00	16.00	4
0.750	≥ 5	9.95	10.00	70.00	25.00	16.00	4
0.800	≥ 5	9.95	10.00	70.00	25.00	16.00	4
1.000	≥ 6	11.95	12.00	80.00	31.00	20.00	4
1.250	≥ 8	11.95	12.00	80.00	31.00	20.00	4
1.500	≥ 10	11.95	12.00	80.00	31.00	20.00	4
1.500	≥ 10	15.95	16.00	90.00	40.00	25.00	5
1.750	≥ 12	15.95	16.00	90.00	40.00	25.00	5
2.000	≥ 14	15.95	16.00	90.00	40.00	25.00	5
2.500	≥ 18	15.95	16.00	90.00	40.00	25.00	5
3.000	≥ 24	19.95	20.00	105.00	50.00	33.00	5

Standard Article no.	Company std.	
	4162	4163
Order no.		
	4162 10.050	4163 10.050
		4163 10.070
	4162 10.075	4163 10.075
		4163 10.080
	4162 12.100	4163 12.100
	4162 12.125	4163 12.125
	4162 12.150	4163 12.150
	4162 16.150	4163 16.150
		4163 16.175
	4162 16.200	4163 16.200
	4162 16.250	4163 16.250
	4162 20.300	4163 20.300

Thread milling cutters



Micro thread milling cutters for ISO metric threads

Article no. **4226**



Cutting data page 972

P	M	K	N	S	H
•	•	•	•	•	○

H = 55 HRC

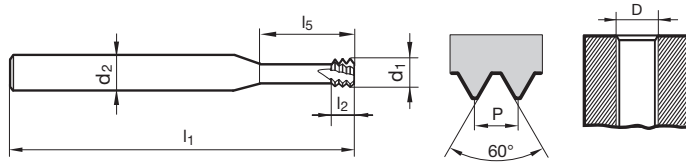

Standard	Company std.
Article no.	4226

D	P	d1	d2	l1	l2	l5	Z	Order no.
mm		mm	mm	mm	mm	mm		
M1,6	0.350	1.20	3.00	39.00	1.10	4.80	3	4226 1.600
M1,8	0.350	1.40	3.00	39.00	1.10	5.40	3	4226 1.800
M2	0.400	1.55	3.00	39.00	1.20	6.00	4	4226 2.000
M2,5	0.450	1.95	3.00	39.00	1.40	7.50	4	4226 2.500
M3	0.500	2.40	6.00	58.00	1.50	9.50	4	4226 3.000
M3,5	0.600	2.80	6.00	58.00	1.80	11.00	4	4226 3.500
M4	0.700	3.20	6.00	58.00	2.10	12.50	4	4226 4.000
M5	0.800	4.00	6.00	58.00	2.40	16.00	4	4226 5.000
M6	1.000	4.80	6.00	58.00	3.00	20.00	4	4226 6.000
M8	1.250	5.95	6.00	58.00	3.80	24.00	4	4226 8.000
M10	1.500	7.80	8.00	73.00	4.50	33.00	4	4226 10.000
M12	1.750	9.00	10.00	84.00	5.30	38.00	4	4226 12.000
M16	2.000	11.80	12.00	84.00	6.00	35.00	5	4226 16.000
M20	2.500	15.00	16.00	109.00	7.50	56.00	5	4226 20.000

Thread milling cutters

Micro thread milling cutters for UN threads

Article no. **4223**



Cutting data page 972

P	M	K	N	S	H
•	•	•	•	•	○

H = 55 HRC

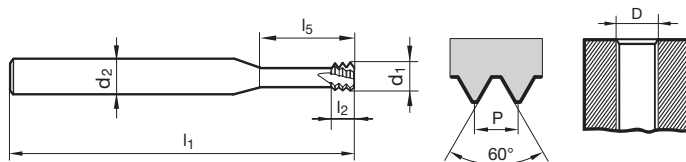

Standard	Company std.
Article no.	4223

D	P	d1	d2	l1	l2	l5	Z	Order no.
G/inch		mm	mm	mm	mm	mm		
UNF No 1	72	1.45	3.00	39.00	1.10	5.80	3	4223 1.853
UNC No 1+UNF No 2	64	1.40	3.00	39.00	1.20	6.00	3	4223 1.854
UNC No 2+UNF No 3	56	1.65	3.00	39.00	1.40	7.00	4	4223 2.184
UNC No 3+UNF No 4	48	1.90	3.00	39.00	1.60	8.00	4	4223 2.515
UNC No 4	40	2.10	6.00	58.00	1.90	9.00	4	4223 2.845
UNC No 5+UNF No 6	40	2.45	6.00	58.00	1.90	10.00	4	4223 3.175
UNC No 6	32	2.55	6.00	58.00	2.40	11.00	4	4223 3.505
UNF No 8	36	3.30	6.00	58.00	2.10	12.00	4	4223 4.165
UNC No 8	32	3.20	6.00	58.00	2.40	13.00	4	4223 4.166
UNF No10	32	3.70	6.00	58.00	2.40	15.00	4	4223 4.825
UNC No10+UNC No12	24	3.50	6.00	58.00	3.20	16.00	4	4223 4.826
UNF No12	28	4.20	6.00	58.00	2.70	16.00	4	4223 5.485
UNF 1/4	28	5.00	6.00	58.00	2.70	19.60	4	4223 6.349
UNC 1/4	20	4.75	6.00	58.00	3.80	20.00	4	4223 6.350
UNF 5/16+UNF 3/8	24	6.60	8.00	64.00	3.20	24.00	4	4223 7.937
UNC 5/16	18	6.00	6.00	58.00	4.20	23.00	4	4223 7.938
UNC 3/8	16	6.70	8.00	64.00	4.80	25.00	4	4223 9.525
UNF 7/16	20	8.00	8.00	64.00	3.80	34.60	4	4223 11.112
UNC 7/16	14	7.70	8.00	64.00	5.40	25.00	4	4223 11.113
UNF 1/2	20	9.95	10.00	73.00	3.80	31.00	4	4223 12.700
UNC 1/2	13	9.95	10.00	73.00	5.90	31.00	4	4223 12.701
UNF 5/8	18	12.00	12.00	84.00	4.20	35.00	4	4223 15.874
UNC 5/8	11	12.00	12.00	84.00	6.90	35.00	4	4223 15.875



Micro thread milling cutters for BSP-threads

Article no. 4228



Cutting data page 972



Thread milling cutters for internal and external threads

P	M	K	N	S	H
●	●	●	●	●	○

H = 55 HRC

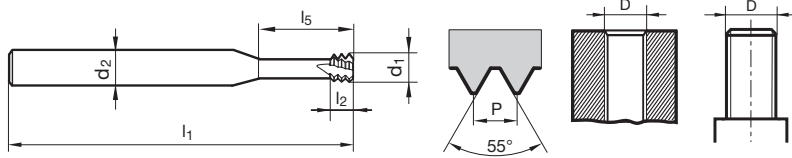

D	P	d1	d2	l1	l2	l5	Z
	G/inch	mm	mm	mm	mm	mm	
G1/16-G1/8	28	6.20	8.00	64.00	2.70	19.50	4
G1/4-G3/8	19	9.95	10.00	73.00	4.00	25.00	4
G1/2-G7/8	14	11.95	12.00	84.00	5.40	37.00	4
G1-G2	11	15.95	16.00	105.00	6.90	44.00	5

Standard Article no.	Company std. 4228
Order no.	4228 9.728 4228 16.662 4228 30.201 4228 59.614

Micro thread milling cutters for MJ threads

Article no. 4214



Cutting data page 972



with internal cooling ≥ MJ5

P	M	K	N	S	H
●	●	●	●	●	○

H = 55 HRC

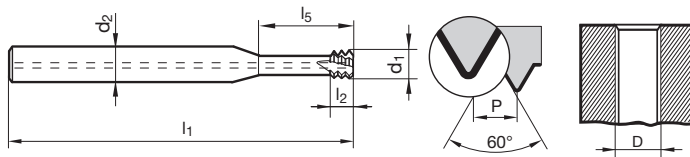

D	d1	d2	l1	l2	l5	Z
mm	mm	mm	mm	mm	mm	
MJ3	2.40	6.00	58.00	1.50	9.50	4
MJ4	3.20	6.00	58.00	2.10	12.50	4
MJ5	3.90	6.00	58.00	2.40	16.00	4
MJ6	4.80	6.00	58.00	3.00	19.00	4
MJ8	6.10	8.00	64.00	3.80	25.00	4
MJ10	7.95	8.00	73.00	4.50	33.00	4
MJ12	9.20	10.00	73.00	5.30	30.00	4
MJ16	10.80	12.00	84.00	6.00	35.00	5

Standard Article no.	Company std. 4214
Order no.	4214 3.000 4214 4.000 4214 5.000 4214 6.000 4214 8.000 4214 10.000 4214 12.000 4214 16.000

Thread milling cutters



Micro thread milling cutters for UNJ threads

Article no. **4215**



Cutting data page 972



with internal cooling \geq UNJF 1/4

P	M	K	N	S	H
•	•	•	•	•	○

H = 55 HRC

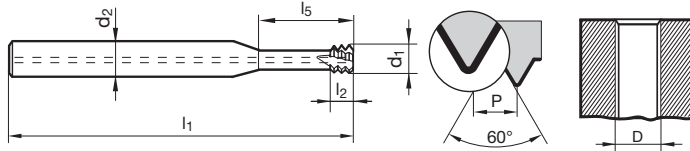

Standard Article no.	Company std.
	4215
	Order no.
	4215 3.505
	4215 4.166
	4215 4.826
	4215 6.349
	4215 6.350
	4215 7.937
	4215 7.938
	4215 9.525
	4215 11.112
	4215 11.113
	4215 12.700

D	P G/inch	d1 mm	d2 mm	l1 mm	l2 mm	l5 mm	Z
UNJC No 6	32	2.70	6.00	58.00	2.40	11.00	4
UNJC No 8+UNJF No10	32	3.30	6.00	58.00	2.40	14.00	4
UNJC No10+UNJF No12	24	3.70	6.00	58.00	3.20	15.00	4
UNJF 1/4	28	5.10	8.00	64.00	2.70	19.50	4
UNJC 1/4	20	4.90	6.00	58.00	3.80	19.50	4
UNJF 5/16+UNJF 3/8	24	6.70	8.00	64.00	3.20	24.00	4
UNJC 5/16+UNJF 9/16	18	6.15	8.00	64.00	4.20	24.00	4
UNJC 3/8+UNJF 3/4	16	6.90	8.00	64.00	4.80	26.00	4
UNJF 7/16	20	8.00	10.00	73.00	3.80	30.00	4
UNJC 7/16+UNJF 7/8	14	7.90	10.00	73.00	5.40	30.00	4
UNJC 1/2	13	9.40	10.00	73.00	5.90	30.00	4

Thread milling cutters

Micro thread milling cutters for ISO metric threads

Article no. **4225**



Cutting data page 972



P	M	K	N	S	H
•	•	•	•	•	○

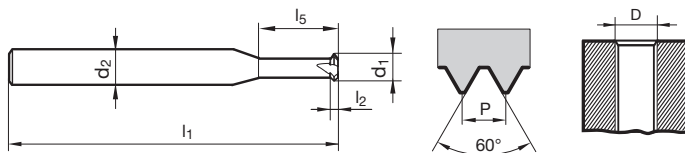

Standard Article no.	Company std.
	4225
	Order no.
	4225 1.100
	4225 1.200
	4225 1.800
	4225 2.400
	4225 3.000
	4225 4.500
	4225 7.000
	4225 10.000
	4225 14.000
	4225 20.000

D	Pmax. mm	d1 mm	d2 mm	l1 mm	l2 mm	l5 mm	Z
M1 - M1,1	0.250	0.70	3.00	39.00	0.25	3.40	3
M1,2	0.250	0.90	3.00	39.00	0.25	3.70	3
M1.4 - M1.8	0.350	1.05	3.00	39.00	0.40	3.80	3
M2 - M2.4	0.400	1.50	3.00	39.00	0.40	7.00	3
M2.5 - M3	0.500	2.00	3.00	39.00	0.50	9.00	4
M3.5 - M4.5	0.750	2.80	6.00	58.00	0.80	14.00	4
M5 - M7	1.000	4.00	6.00	58.00	1.00	19.00	4
M8 - M10	1.500	6.40	8.00	64.00	1.50	24.00	5
M12 - M14	2.000	9.00	12.00	84.00	1.80	36.00	5
M16 - M20	2.500	13.00	14.00	100.00	2.20	50.00	5



Micro thread milling cutters for ISO metric threads

Article no. 4227



for hard machining 45-65 HRC

Cutting data page 972

P	M	K	N	S	H
			○		●

H = 66 HRC

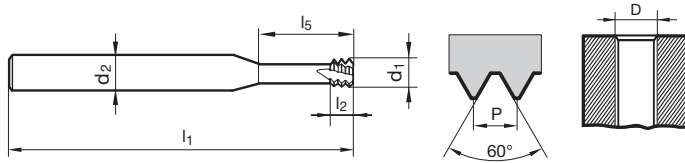

D	P	d1	d2	l1	l2	l5	Z
		mm		mm		mm	
M2	0.400	1.55	3.00	39.00	1.20	6.00	4
M2,5	0.450	1.95	3.00	39.00	1.40	7.50	4
M3	0.500	2.35	6.00	58.00	1.50	9.50	4
M4	0.700	3.10	6.00	58.00	2.10	12.50	4
M5	0.800	3.80	6.00	58.00	2.40	16.00	4
M6	1.000	4.80	6.00	58.00	3.00	20.00	4
M8	1.250	5.95	6.00	58.00	3.80	24.00	4
M10	1.500	7.80	8.00	64.00	4.50	23.00	4
M12	1.750	9.00	10.00	73.00	5.30	26.00	5
M16	2.000	11.80	12.00	90.00	6.00	40.00	5

Standard Article no.	Company std.
	4227
Order no.	
	4227 2.000
	4227 2.500
	4227 3.000
	4227 4.000
	4227 5.000
	4227 6.000
	4227 8.000
	4227 10.000
	4227 12.000
	4227 16.000

Thread milling cutters

Micro thread milling cutters for ISO metric threads

Article no. 4496



rotation-direction left-hand

Cutting data page 972

P	M	K	N	S	H
○				●	●

H = 66 HRC

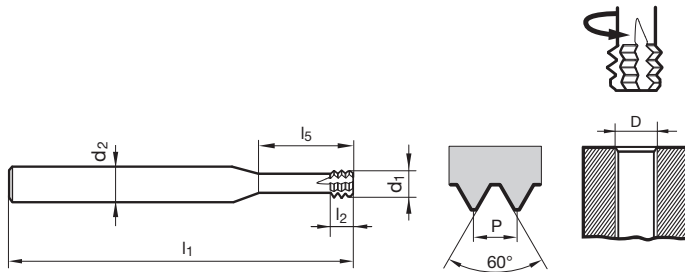

D	P	d1	d2	l1	l2	l5	Z
		mm		mm		mm	
M2	0.400	1.55	3.00	39.00	1.20	5.00	4
M2,5	0.450	1.95	3.00	39.00	1.40	6.50	4
M3	0.500	2.35	6.00	58.00	1.50	7.50	4
M3,5	0.600	2.80	6.00	58.00	1.80	9.00	4
M4	0.700	3.10	6.00	58.00	2.10	10.00	4
M5	0.800	3.80	6.00	58.00	2.40	12.50	4
M6	1.000	4.80	6.00	58.00	3.00	15.00	4
M8	1.250	5.95	6.00	58.00	3.80	20.00	5
M10	1.500	7.80	8.00	64.00	4.50	25.00	5
M12	1.750	9.00	10.00	73.00	5.30	30.00	6
M16	2.000	11.80	12.00	84.00	6.00	35.00	6

Standard Article no.	Company std.
	4496
Order no.	
	4496 2.000
	4496 2.500
	4496 3.000
	4496 3.500
	4496 4.000
	4496 5.000
	4496 6.000
	4496 8.000
	4496 10.000
	4496 12.000
	4496 16.000



Thread milling cutters with chamfer for ISO metric threads

Article no. **4000**



Cutting data page 969



with internal cooling \geq M4

P	M	K	N	S	H
●	●	●	○	○	

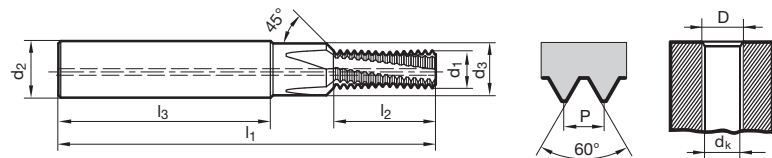

Standard
Article no.

Company std.
4000

Thread milling cutters

	D	P	d1	d2	d3	dk	l1	l3	l2	Z	Order no.
		mm	mm	mm	mm	mm	mm	mm	mm		
M3	0.500	2.30	6.00	3.40	2.50	48.00	36.00	6.80	5	4000 3.000	
M4	0.700	3.10	6.00	4.50	3.30	48.00	36.00	8.80	5	4000 4.000	
M4 x 0,5	0.500	3.10	6.00	4.50	3.50	48.00	36.00	8.80	5	4000 4.003	
M5	0.800	4.00	6.00	5.50	4.20	54.00	36.00	10.80	5	4000 5.000	
M5 x 0,5	0.500	4.00	6.00	5.50	4.50	54.00	36.00	10.80	5	4000 5.003	
M6	1.000	4.70	8.00	6.60	5.00	62.00	36.00	13.50	6	4000 6.000	
M6 x 0,5	0.500	4.70	8.00	6.60	5.50	62.00	36.00	12.80	6	4000 6.003	
M6 x 0,75	0.750	4.70	8.00	6.60	5.20	62.00	36.00	13.10	6	4000 6.004	
M8	1.250	6.30	10.00	9.00	6.80	74.00	40.00	18.10	7	4000 8.000	
M8 x 1	1.000	6.30	10.00	9.00	7.00	74.00	40.00	17.50	7	4000 8.005	
M10	1.500	7.80	12.00	11.00	8.50	80.00	45.00	21.80	7	4000 10.000	
M10 x 1	1.000	7.80	12.00	11.00	9.00	80.00	45.00	21.50	7	4000 10.005	
M10 x 1,25	1.250	7.80	12.00	11.00	8.80	80.00	45.00	21.90	7	4000 10.006	
M12	1.750	9.50	14.00	13.50	10.20	90.00	45.00	25.40	7	4000 12.000	
M12 x 1	1.000	9.50	14.00	13.50	11.00	90.00	45.00	25.50	7	4000 12.005	
M12 x 1,5	1.500	9.50	14.00	13.50	10.50	90.00	45.00	26.30	7	4000 12.007	
M14	2.000	10.80	16.00	15.50	12.00	102.00	48.00	31.00	7	4000 14.000	
M14 x 1,5	1.500	10.80	16.00	15.50	12.50	102.00	48.00	30.80	7	4000 14.007	
M16	2.000	12.70	18.00	17.50	14.00	102.00	48.00	35.00	8	4000 16.000	
M16 x 1,5	1.500	12.70	18.00	17.50	14.50	102.00	48.00	33.80	8	4000 16.007	



Micro thread milling cutters for ISO metric threads

Article no. 4001



Cutting data page 970



M1.6 - M3 with 2 cooling grooves • with internal cooling \geq M3.5 • rotation-direction left-hand

P	M	K	N	S	H
•	•	•	•	•	○

H = 55 HRC

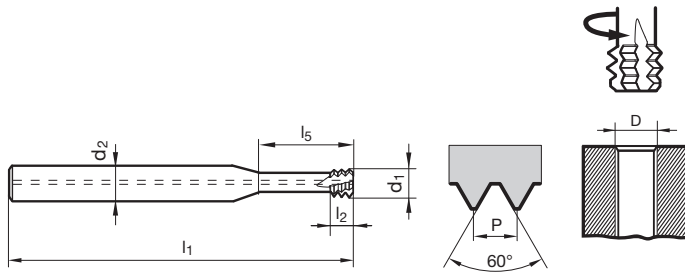

Standard	Company std.
Article no.	4001

D	P mm	d1 mm	d2 mm	l1 mm	l2 mm	l5 mm	Z	Order no.
M1,6	0.350	1.20	3.00	39.00	1.10	4.80	3	4001 1.600
M1,8	0.350	1.40	3.00	39.00	1.10	5.40	4	4001 1.800
M2	0.400	1.55	3.00	39.00	1.20	6.00	4	4001 2.000
M2,5	0.450	1.95	3.00	39.00	1.40	7.50	4	4001 2.500
M3	0.500	2.40	3.00	39.00	1.50	9.50	5	4001 3.000
M3,5	0.600	2.80	6.00	58.00	1.80	11.00	5	4001 3.500
M4	0.700	3.20	6.00	58.00	2.10	12.50	5	4001 4.000
M5	0.800	4.00	6.00	58.00	2.40	16.00	6	4001 5.000
M6	1.000	4.80	6.00	58.00	3.00	20.00	6	4001 6.000
M8	1.250	5.95	8.00	73.00	3.80	24.00	7	4001 8.000
M10	1.500	7.80	8.00	73.00	4.50	33.00	7	4001 10.000
M12	1.750	9.00	10.00	84.00	5.30	38.00	7	4001 12.000
M16	2.000	11.80	12.00	100.00	6.00	48.00	8	4001 16.000
M20	2.500	15.00	16.00	105.00	7.50	60.00	8	4001 20.000

Thread milling cutters



Cutting data page 971



with cooling grooves • rotation-direction left-hand

P	M	K	N	S	H
•	•	•	•	•	•

H = 66 HRC

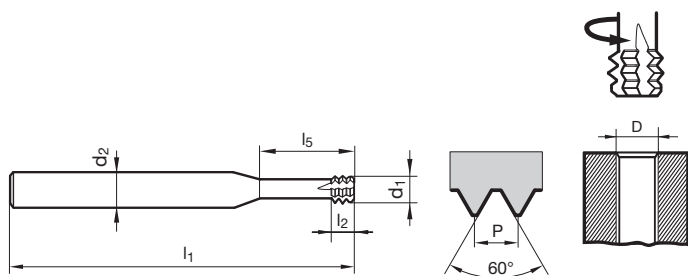

Thread milling cutters

Standard	Company std.
Article no.	4002

D	P	d1	d2	l1	l2	l5	Z	Order no.
	mm	mm	mm	mm	mm	mm		
M2	0.400	1.40	3.00	39.00	1.20	5.00	4	4002 2.000
M2,5	0.450	1.80	3.00	39.00	1.30	6.50	4	4002 2.500
M3	0.500	2.40	6.00	58.00	1.50	7.50	4	4002 3.000
M3,5	0.600	2.70	6.00	58.00	1.80	9.00	4	4002 3.500
M4	0.700	3.10	6.00	58.00	2.10	10.00	4	4002 4.000
M5	0.800	3.80	6.00	58.00	2.40	12.50	4	4002 5.000
M6x1/M8x1	1.000	4.60	8.00	64.00	3.00	15.00	4	4002 6.000
M5x0,5/M6x0,5	0.500	3.80	6.00	58.00	1.50	15.00	4	4002 6.003
M8x1,25/M10x1,25	1.250	6.20	8.00	64.00	3.60	20.00	4	4002 8.000
M6x0,75/M8x0,75	0.750	4.60	8.00	64.00	2.30	20.00	4	4002 8.004
M10x1,5/M12x1,5	1.500	7.50	10.00	73.00	4.50	25.00	4	4002 10.000
M12	1.750	9.00	10.00	73.00	5.20	30.00	4	4002 12.000
M10x1/M12x1	1.000	7.50	8.00	64.00	3.00	25.00	4	4002 12.005
M14x2/M16x2	2.000	11.50	12.00	90.00	6.00	40.00	4	4002 16.000
M14x1,5/M16x1,5	1.500	11.50	12.00	90.00	4.50	40.00	4	4002 16.007
M18x2,5/M20x2,5	2.500	14.50	16.00	105.00	7.50	50.00	4	4002 20.000



Circular drill thread milling cutters for UN threads

Article no. 4700



Cutting data page 971



with cooling grooves • rotation-direction left-hand

P	M	K	N	S	H
•	•	•	•	•	•

H = 66 HRC

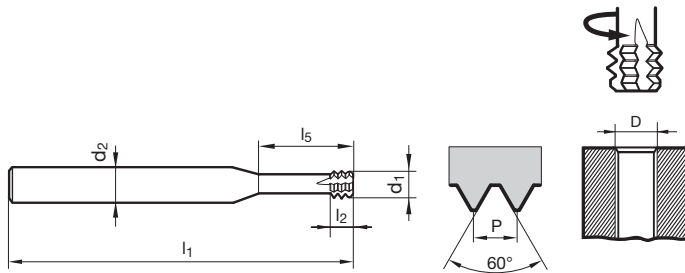

Standard Article no.	Company std.							
	4700							
	Order no.							
D	P	d1	d2	l1	l2	l5	Z	Order no.

UNF No 1	72	1.40	3.00	39.00	1.10	5.00	4	4700 1.853
UNC No 1+UNF No 2	64	1.40	3.00	39.00	1.20	5.00	4	4700 1.854
UNC No 2+UNF No 3	56	1.60	3.00	39.00	1.40	5.50	4	4700 2.184
UNC No 3+UNF No 4	48	1.90	3.00	39.00	1.60	6.50	4	4700 2.515
UNC No 4	40	2.10	6.00	58.00	1.90	7.50	4	4700 2.845
UNC No 5+UNF No 6	40	2.40	6.00	58.00	1.90	8.00	4	4700 3.175
UNC No 6	32	2.60	6.00	58.00	2.40	9.00	4	4700 3.505
UNF No 8	36	3.20	6.00	58.00	2.10	10.50	4	4700 4.165
UNC No 8	32	3.10	6.00	58.00	2.40	10.50	4	4700 4.166
UNF No10	32	3.60	6.00	58.00	2.40	12.50	4	4700 4.825
UNC No10+UNC No12	24	3.60	6.00	58.00	3.20	12.50	4	4700 4.826
UNF No12	28	4.10	6.00	58.00	2.70	14.00	4	4700 5.485
UNF 1/4	28	4.80	6.00	58.00	2.70	16.00	4	4700 6.349
UNC 1/4	20	4.80	6.00	58.00	3.80	16.00	4	4700 6.350
UNF 5/16+UNF 3/8	24	6.30	8.00	64.00	3.20	20.00	4	4700 7.937
UNC 5/16	18	6.30	8.00	64.00	4.20	20.00	4	4700 7.938
UNC 3/8	16	7.20	8.00	64.00	4.80	24.00	4	4700 9.525
UNF 7/16	20	8.30	10.00	73.00	3.80	28.00	4	4700 11.112
UNC 7/16	14	8.30	10.00	73.00	5.40	28.00	4	4700 11.113
UNF 1/2	20	9.70	10.00	73.00	3.80	31.00	4	4700 12.700
UNC 1/2	13	9.70	10.00	73.00	5.90	31.00	4	4700 12.701
UNF 5/8	18	11.80	12.00	90.00	4.20	40.00	4	4700 15.874
UNC 5/8	11	11.80	12.00	90.00	6.90	40.00	4	4700 15.875

Thread milling cutters

Circular drill thread milling cutters for BSP threads

Article no. 4780



Cutting data page 971



with cooling grooves • rotation-direction left-hand

P	M	K	N	S	H
•	•	•	•	•	•

H = 66 HRC

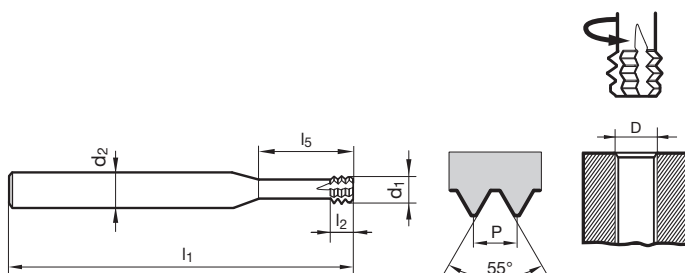

Standard Article no.	Company std.							
	4780							
	Order no.							
D	P	d1	d2	l1	l2	l5	Z	Order no.

G1/16-G1/8	28	6.10	8.00	64.00	2.70	24.00	4	4780 9.728
G1/4-G3/8	19	10.30	12.00	90.00	4.00	40.00	4	4780 16.662
G1/2-G5/8-G3/4	14	15.70	16.00	105.00	5.40	50.00	4	4780 26.441



Drill thread milling cutters for ISO metric threads

Article no. **3778**



Cutting data page 974

P	M	K	N	S	H
		○	●		

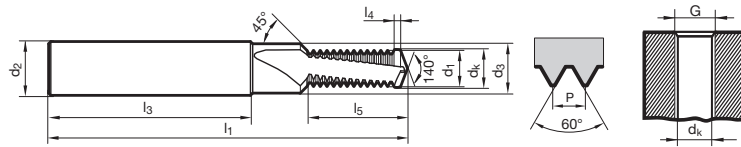

Standard
Article no.

Company std.
3778

D	P	d1	d2	d3	dk	l1	l3	l4	l5	Z
	mm	mm	mm	mm	mm	mm	mm	mm	mm	
M 3	0.500	2.40	6.00	3.40	2.50	48.00	36.00	0.50	7.00	2
M 4	0.700	3.20	6.00	4.50	3.30	48.00	36.00	0.70	9.00	2
M 5	0.800	4.00	6.00	5.50	4.20	54.00	36.00	0.80	11.20	2
M 6	1.000	4.75	8.00	6.60	5.00	62.00	36.00	1.00	13.90	2
M 8	1.250	6.35	10.00	9.00	6.80	74.00	40.00	1.25	18.70	2
M10	1.500	7.95	12.00	11.00	8.50	80.00	45.00	1.50	22.50	2
M12	1.750	9.95	14.00	13.50	10.20	90.00	45.00	1.50	26.10	2
M14	2.000	11.20	16.00	15.50	12.00	102.00	48.00	1.50	31.70	2
M16	2.000	13.20	18.00	17.50	14.00	102.00	48.00	1.50	36.00	2

Order no.
3778 3.000
3778 4.000
3778 5.000
3778 6.000
3778 8.000
3778 10.000
3778 12.000
3778 14.000
3778 16.000

Thread milling cutters

Drill thread milling cutters for ISO metric threads

Article no. **3779**



Cutting data page 974

P	M	K	N	S	H
		○	●		

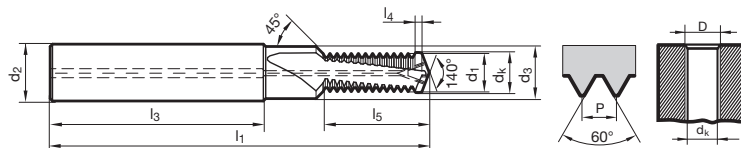

Standard
Article no.

Company std.
3779

D	P	d1	d2	d3	dk	l1	l3	l4	l5	Z
	mm	mm	mm	mm	mm	mm	mm	mm	mm	
M 4	0.700	3.20	6.00	4.50	3.30	48.00	36.00	0.70	9.00	2
M 5	0.800	4.00	6.00	5.50	4.20	54.00	36.00	0.80	11.20	2
M 6	1.000	4.75	8.00	6.60	5.00	62.00	36.00	1.00	13.90	2
M 8	1.250	6.35	10.00	9.00	6.80	74.00	40.00	1.25	18.70	2
M10	1.500	7.95	12.00	11.00	8.50	80.00	45.00	1.50	22.50	2
M12	1.750	9.95	14.00	13.50	10.20	90.00	45.00	1.50	26.10	2
M14	2.000	11.20	16.00	15.50	12.00	102.00	48.00	1.50	31.70	2
M16	2.000	13.20	18.00	17.50	14.00	102.00	48.00	1.50	36.00	2

Order no.
3779 4.000
3779 5.000
3779 6.000
3779 8.000
3779 10.000
3779 12.000
3779 14.000
3779 16.000



Drill thread milling cutters for ISO metric threads

Article no. 3783

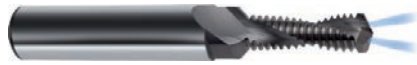

Cutting data page 974



P	M	K	N	S	H
		○	●		

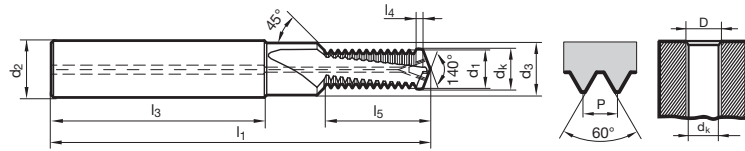

Standard
Article no.

Company std.
3783

D	P	d1	d2	d3	dk	l1	l3	l4	l5	Z
mm	mm	mm	mm	mm	mm	mm	mm	mm	mm	
M 4	0.700	3.20	6.00	4.50	3.30	48.00	36.00	0.70	11.10	2
M 5	0.800	4.00	6.00	5.50	4.20	54.00	36.00	0.80	13.60	2
M 6	1.000	4.75	8.00	6.60	5.00	62.00	36.00	1.00	16.90	2
M 8	1.250	6.35	10.00	9.00	6.80	74.00	40.00	1.25	22.50	2
M10	1.500	7.95	12.00	11.00	8.50	80.00	45.00	1.50	27.00	2
M12	1.750	9.95	14.00	13.50	10.20	90.00	45.00	1.50	31.40	2
M14	2.000	11.20	16.00	15.50	12.00	102.00	48.00	1.50	39.70	2
M16	2.000	13.20	18.00	17.50	14.00	102.00	48.00	1.50	46.00	2

Order no.
3783 4.000
3783 5.000
3783 6.000
3783 8.000
3783 10.000
3783 12.000
3783 14.000
3783 16.000

Thread milling cutters



Hand taps for ISO metric threads

Article no. **861**

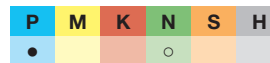

P ≤ 800 N/mm²

Hand taps, first tap

Article no. **862**



Hand taps, second tap

Article no. **863**



Hand taps, bottoming tap

Article no. **864**



Hand taps & dies

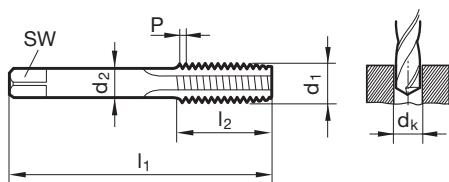

Standard
Description
Article no.

DIN 352

Set	V	M	F
861	862	863	864

Order no.			
861 1.000	862 1.000	863 1.000	864 1.000
861 1.200	862 1.200	863 1.200	864 1.200
861 1.400	862 1.400	863 1.400	864 1.400
861 1.600	862 1.600	863 1.600	864 1.600
861 1.800	862 1.800	863 1.800	864 1.800
861 2.000	862 2.000	863 2.000	864 2.000
861 2.300	862 2.300	863 2.300	864 2.300
861 2.500	862 2.500	863 2.500	864 2.500
861 3.000	862 3.000	863 3.000	864 3.000
861 3.500	862 3.500	863 3.500	864 3.500
861 4.000	862 4.000	863 4.000	864 4.000
861 4.500	862 4.500	863 4.500	864 4.500
861 5.000	862 5.000	863 5.000	864 5.000
861 6.000	862 6.000	863 6.000	864 6.000
861 7.000	862 7.000	863 7.000	864 7.000
861 8.000	862 8.000	863 8.000	864 8.000
861 9.000	862 9.000	863 9.000	864 9.000
861 10.000	862 10.000	863 10.000	864 10.000
861 11.000	862 11.000	863 11.000	864 11.000
861 12.000	862 12.000	863 12.000	864 12.000
861 14.000	862 14.000	863 14.000	864 14.000
861 16.000	862 16.000	863 16.000	864 16.000
861 18.000	862 18.000	863 18.000	864 18.000
861 20.000	862 20.000	863 20.000	864 20.000
861 22.000	862 22.000	863 22.000	864 22.000
861 24.000	862 24.000	863 24.000	864 24.000
861 27.000	862 27.000	863 27.000	864 27.000
861 30.000	862 30.000	863 30.000	864 30.000
861 36.000	862 36.000	863 36.000	864 36.000
861 42.000	862 42.000	863 42.000	864 42.000
861 45.000	862 45.000	863 45.000	864 45.000

d1	P	d2	SW	dk	l1	l2
	mm	mm	mm	mm	mm	mm
M1	0.250	2.50	2.10	0.75	32.00	5.50
M1,2	0.250	2.50	2.10	0.95	32.00	5.50
M1,4	0.300	2.50	2.10	1.10	32.00	7.00
M1,6	0.350	2.50	2.10	1.25	32.00	8.00
M1,8	0.350	2.50	2.10	1.45	32.00	8.00
M2	0.400	2.80	2.10	1.60	36.00	8.00
M2,3	0.400	2.80	2.10	1.90	36.00	9.00
M2,5	0.450	2.80	2.10	2.05	40.00	9.00
M3	0.500	3.50	2.70	2.50	40.00	10.00
M3,5	0.600	4.00	3.00	2.90	45.00	12.00
M4	0.700	4.50	3.40	3.30	45.00	12.00
M4,5	0.750	6.00	4.90	3.70	50.00	14.00
M5	0.800	6.00	4.90	4.20	50.00	14.00
M6	1.000	6.00	4.90	5.00	56.00	16.00
M7	1.000	6.00	4.90	6.00	56.00	16.00
M8	1.250	6.00	4.90	6.80	63.00	17.00
M9	1.250	7.00	5.50	7.80	63.00	17.00
M10	1.500	7.00	5.50	8.50	70.00	20.00
M11	1.500	8.00	6.20	9.50	70.00	20.00
M12	1.750	9.00	7.00	10.20	75.00	24.00
M14	2.000	11.00	9.00	12.00	80.00	26.00
M16	2.000	12.00	9.00	14.00	80.00	26.00
M18	2.500	14.00	11.00	15.50	95.00	30.00
M20	2.500	16.00	12.00	17.50	95.00	32.00
M22	2.500	18.00	14.50	19.50	100.00	32.00
M24	3.000	18.00	14.50	21.00	110.00	36.00
M27	3.000	20.00	16.00	24.00	110.00	36.00
M30	3.500	22.00	18.00	26.50	125.00	40.00
M36	4.000	28.00	22.00	32.00	150.00	50.00
M42	4.500	32.00	24.00	37.50	150.00	56.00
M45	4.500	36.00	29.00	40.50	160.00	58.00



Hand taps for ISO metric threads

Article no. 853



P	M	K	N	S	H
○	●	○	●		

P ≤ 1000 N/mm²

Hand taps, first tap

Article no. 854



Hand taps, second tap

Article no. 855



Hand taps, bottoming tap

Article no. 856

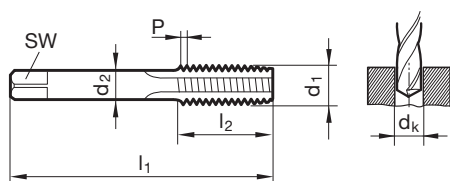

Standard	DIN 352			
Description	Set	V	M	F
Article no.	853	854	855	856

d1	P	d2	SW	dk	l1	l2	Order no.			
mm	mm	mm	mm	mm	mm	mm				
M2	0.400	2.80	2.10	1.60	36.00	8.00	853 2.000	854 2.000	855 2.000	856 2.000
M2,5	0.450	2.80	2.10	2.05	40.00	9.00	853 2.500	854 2.500	855 2.500	856 2.500
M3	0.500	3.50	2.70	2.50	40.00	10.00	853 3.000	854 3.000	855 3.000	856 3.000
M3,5	0.600	4.00	3.00	2.90	45.00	12.00	853 3.500	854 3.500	855 3.500	856 3.500
M4	0.700	4.50	3.40	3.30	45.00	12.00	853 4.000	854 4.000	855 4.000	856 4.000
M5	0.800	6.00	4.90	4.20	50.00	14.00	853 5.000	854 5.000	855 5.000	856 5.000
M6	1.000	6.00	4.90	5.00	56.00	16.00	853 6.000	854 6.000	855 6.000	856 6.000
M8	1.250	6.00	4.90	6.80	63.00	17.00	853 8.000	854 8.000	855 8.000	856 8.000
M10	1.500	7.00	5.50	8.50	70.00	20.00	853 10.000	854 10.000	855 10.000	856 10.000
M12	1.750	9.00	7.00	10.20	75.00	24.00	853 12.000	854 12.000	855 12.000	856 12.000
M16	2.000	12.00	9.00	14.00	80.00	26.00	853 16.000	854 16.000	855 16.000	856 16.000
M20	2.500	16.00	12.00	17.50	95.00	32.00	853 20.000	854 20.000	855 20.000	856 20.000

Hand taps & dies



Hand taps for ISO metric threads

Article no. **857**

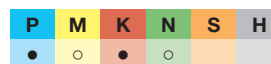

P ≤ 1200 N/mm²

Hand taps, first tap

Article no. **858**



Hand taps, second tap

Article no. **859**



Hand taps, bottoming tap

Article no. **860**



Hand taps & dies

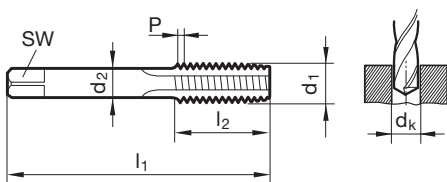

Standard	DIN 352			
Description	Set	V	M	F
Article no.	857	858	859	860

d1	P	d2	SW	dk	l1	l2	Order no.			
	mm	mm	mm	mm	mm	mm				
M2	0.400	2.80	2.10	1.60	36.00	8.00	857 2.000	858 2.000	859 2.000	860 2.000
M2,5	0.450	2.80	2.10	2.05	40.00	9.00	857 2.500	858 2.500	859 2.500	860 2.500
M3	0.500	3.50	2.70	2.50	40.00	10.00	857 3.000	858 3.000	859 3.000	860 3.000
M4	0.700	4.50	3.40	3.30	45.00	12.00	857 4.000	858 4.000	859 4.000	860 4.000
M5	0.800	6.00	4.90	4.20	50.00	14.00	857 5.000	858 5.000	859 5.000	860 5.000
M6	1.000	6.00	4.90	5.00	56.00	16.00	857 6.000	858 6.000	859 6.000	860 6.000
M8	1.250	6.00	4.90	6.80	63.00	17.00	857 8.000	858 8.000	859 8.000	860 8.000
M10	1.500	7.00	5.50	8.50	70.00	20.00	857 10.000	858 10.000	859 10.000	860 10.000
M12	1.750	9.00	7.00	10.20	75.00	24.00	857 12.000	858 12.000	859 12.000	860 12.000
M14	2.000	11.00	9.00	12.00	80.00	26.00	857 14.000	858 14.000	859 14.000	860 14.000
M16	2.000	12.00	9.00	14.00	80.00	26.00	857 16.000	858 16.000	859 16.000	860 16.000
M18	2.500	14.00	11.00	15.50	95.00	30.00	857 18.000	858 18.000	859 18.000	860 18.000
M20	2.500	16.00	12.00	17.50	95.00	32.00	857 20.000	858 20.000	859 20.000	860 20.000



Hand taps for ISO metric threads

Article no. 1818



P	M	K	N	S	H
●	○	●	○		

P ≤ 1200 N/mm²

Hand taps, first tap

Article no. 1819



Hand taps, second tap

Article no. 1820



Hand taps, bottoming tap

Article no. 1821

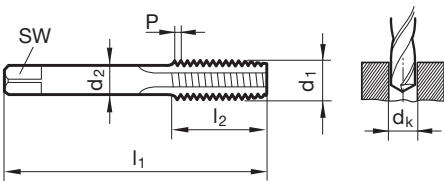

Standard
Description
Article no.

DIN 352

Set	V	M	F
1818	1819	1820	1821

Order no.

d1	P	d2	SW	dk	l1	l2	Order no.			
	mm	mm	mm	mm	mm	mm				
M3	0.500	3.50	2.70	2.50	40.00	10.00	1818 3.000	1819 3.000	1820 3.000	1821 3.000
M4	0.700	4.50	3.40	3.30	45.00	12.00	1818 4.000	1819 4.000	1820 4.000	1821 4.000
M5	0.800	6.00	4.90	4.20	50.00	14.00	1818 5.000	1819 5.000	1820 5.000	1821 5.000
M6	1.000	6.00	4.90	5.00	56.00	16.00	1818 6.000	1819 6.000	1820 6.000	1821 6.000
M8	1.250	6.00	4.90	6.80	63.00	17.00	1818 8.000	1819 8.000	1820 8.000	1821 8.000
M10	1.500	7.00	5.50	8.50	70.00	20.00	1818 10.000	1819 10.000	1820 10.000	1821 10.000
M12	1.750	9.00	7.00	10.20	75.00	24.00	1818 12.000	1819 12.000	1820 12.000	1821 12.000

Hand taps & dies



Hand taps for ISO metric fine threads

Article no. **884**



P ≤ 800 N/mm²

Hand taps, first tap

Article no. **885**



Hand taps, bottoming tap

Article no. **886**



Hand taps & dies

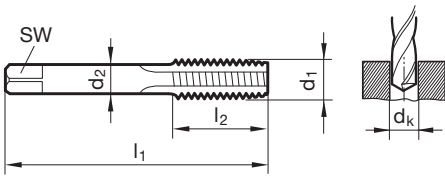

Standard
Description
Article no.

DIN 2181		
Set	V	F
884	885	886

d1	d2	SW	dk	l1	l2	Order no.		
M4 x 0,35	4.50	3.40	3.65	45.00	9.00	884 4.002	885 4.002	886 4.002
M4 x 0,5	4.50	3.40	3.50	45.00	9.00	884 4.003	885 4.003	886 4.003
M5 x 0,5	6.00	4.90	4.50	56.00	11.00	884 5.003	885 5.003	886 5.003
M6 x 0,5	6.00	4.90	5.50	56.00	12.00	884 6.003	885 6.003	886 6.003
M6 x 0,75	6.00	4.90	5.20	56.00	12.00	884 6.004	885 6.004	886 6.004
M7 x 0,75	6.00	4.90	6.20	56.00	14.00	884 7.004	885 7.004	886 7.004
M8 x 0,5	6.00	4.90	7.50	56.00	14.00	884 8.003	885 8.003	886 8.003
M8 x 0,75	6.00	4.90	7.20	56.00	14.00	884 8.004	885 8.004	886 8.004
M8 x 1	6.00	4.90	7.00	63.00	17.00	884 8.005	885 8.005	886 8.005
M9 x 1	7.00	5.50	8.00	63.00	17.00	884 9.005	885 9.005	886 9.005
M10 x 0,75	7.00	5.50	9.20	63.00	18.00	884 10.004	885 10.004	886 10.004
M10 x 1	7.00	5.50	9.00	63.00	18.00	884 10.005	885 10.005	886 10.005
M10 x 1,25	7.00	5.50	8.80	70.00	20.00	884 10.006	885 10.006	886 10.006
M12 x 1	9.00	7.00	11.00	70.00	18.00	884 12.005	885 12.005	886 12.005
M12 x 1,25	9.00	7.00	10.80	70.00	20.00	884 12.006	885 12.006	886 12.006
M12 x 1,5	9.00	7.00	10.50	70.00	20.00	884 12.007	885 12.007	886 12.007
M14 x 1	11.00	9.00	13.00	70.00	20.00	884 14.005	885 14.005	886 14.005
M14 x 1,25	11.00	9.00	12.80	70.00	20.00	884 14.006	885 14.006	886 14.006
M14 x 1,5	11.00	9.00	12.50	70.00	20.00	884 14.007	885 14.007	886 14.007
M15 x 1	12.00	9.00	14.00	70.00	20.00	884 15.005	885 15.005	886 15.005
M16 x 1	12.00	9.00	15.00	70.00	20.00	884 16.005	885 16.005	886 16.005
M16 x 1,5	12.00	9.00	14.50	70.00	20.00	884 16.007	885 16.007	886 16.007
M18 x 1	14.00	11.00	17.00	80.00	22.00	884 18.005	885 18.005	886 18.005
M18 x 1,5	14.00	11.00	16.50	80.00	22.00	884 18.007	885 18.007	886 18.007
M18 x 2	14.00	11.00	16.00	80.00	22.00	884 18.008	885 18.008	886 18.008
M20 x 1	16.00	12.00	19.00	80.00	22.00	884 20.005	885 20.005	886 20.005
M20 x 1,5	16.00	12.00	18.50	80.00	22.00	884 20.007	885 20.007	886 20.007
M20 x 2	16.00	12.00	18.00	80.00	22.00	884 20.008	885 20.008	886 20.008
M22 x 1	18.00	14.50	21.00	80.00	22.00	884 22.005	885 22.005	886 22.005
M22 x 1,5	18.00	14.50	20.50	80.00	22.00	884 22.007	885 22.007	886 22.007
M24 x 1	18.00	14.50	23.00	90.00	22.00	884 24.005		
M24 x 1,5	18.00	14.50	22.50	90.00	22.00	884 24.007	885 24.007	886 24.007
M24 x 2	18.00	14.50	22.00	90.00	22.00	884 24.008	885 24.008	886 24.008
M26 x 1,5	18.00	14.50	24.50	90.00	22.00	884 26.007	885 26.007	886 26.007
M27 x 1,5	20.00	16.00	25.50	90.00	22.00	884 27.007	885 27.007	886 27.007
M27 x 2	20.00	16.00	25.00	90.00	22.00	884 27.008	885 27.008	886 27.008
M30 x 1,5	22.00	18.00	28.50	90.00	22.00	884 30.007	885 30.007	886 30.007
M30 x 2	22.00	18.00	28.00	90.00	22.00	884 30.008	885 30.008	886 30.008
M35 x 1,5	28.00	22.00	33.50	100.00	25.00	884 35.007	885 35.007	886 35.007
M36 x 1,5	28.00	22.00	34.50	100.00	25.00	884 36.007	885 36.007	886 36.007



Hand taps for UNC threads

Article no. 981

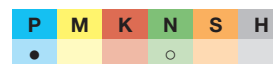

$P \leq 800 \text{ N/mm}^2$

Hand taps, first tap

Article no. 982



Hand taps, second tap

Article no. 983



Hand taps, bottoming tap

Article no. 984

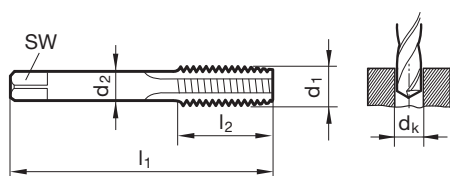

Standard
Description
Article no.

~DIN 352

Set	V	M	F
981	982	983	984

Order no.

981 2.184	982 2.184	983 2.184	984 2.184
981 2.845	982 2.845	983 2.845	984 2.845
981 3.175	982 3.175	983 3.175	984 3.175
981 3.505	982 3.505	983 3.505	984 3.505
981 4.166	982 4.166	983 4.166	984 4.166
981 4.826	982 4.826	983 4.826	984 4.826
981 5.486	982 5.486	983 5.486	984 5.486
981 6.350	982 6.350	983 6.350	984 6.350
981 7.938	982 7.938	983 7.938	984 7.938
981 9.525	982 9.525	983 9.525	984 9.525
981 11.113	982 11.113	983 11.113	984 11.113
981 12.700	982 12.700	983 12.700	984 12.700
981 14.288	982 14.288	983 14.288	984 14.288
981 15.875	982 15.875	983 15.875	984 15.875
981 19.050	982 19.050	983 19.050	984 19.050
981 22.225	982 22.225	983 22.225	984 22.225
981 25.400	982 25.400	983 25.400	984 25.400

d1	d2	SW	dk	l1	l2
	mm	mm	mm	mm	mm
2 - 56	2.80	2.10	1.85	36.00	9.00
4 - 40	3.50	2.70	2.35	40.00	11.00
5 - 40	3.50	2.70	2.65	40.00	11.00
6 - 32	4.00	3.00	2.85	45.00	12.00
8 - 32	4.50	3.40	3.50	45.00	12.00
10 - 24	6.00	4.90	3.90	50.00	14.00
12 - 24	6.00	4.90	4.50	56.00	16.00
1/4 - 20	6.00	4.90	5.10	56.00	16.00
5/16 - 18	6.00	4.90	6.60	63.00	18.00
3/8 - 16	7.00	5.50	8.00	70.00	20.00
7/16 - 14	8.00	6.20	9.40	70.00	22.00
1/2 - 13	9.00	7.00	10.80	75.00	25.00
9/16 - 12	11.00	9.00	12.20	80.00	28.00
5/8 - 11	12.00	9.00	13.50	80.00	30.00
3/4 - 10	14.00	11.00	16.50	95.00	33.00
7/8 - 9	18.00	14.50	19.50	100.00	35.00
1 - 8	18.00	14.50	22.25	110.00	38.00

Hand taps & dies



Hand taps

Hand taps for UNF threads

Article no. **985**



P ≤ 800 N/mm²

Hand taps, first tap

Article no. **986**



Hand taps, bottoming tap

Article no. **987**



Hand taps & dies

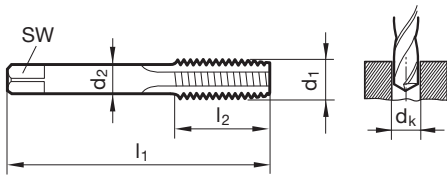

Standard

Description

Article no.

~DIN 2181		
Set	V	F
985	986	987

d1	d2 mm	SW mm	dk mm	l1 mm	l2 mm
10 - 32	6.00	4.90	4.10	50.00	14.00
1/4 - 28	6.00	4.90	5.50	56.00	17.00
5/16 - 24	6.00	4.90	6.90	63.00	17.00
3/8 - 24	7.00	5.50	8.50	63.00	18.00
7/16 - 20	8.00	6.20	9.90	70.00	18.00
1/2 - 20	9.00	7.00	11.50	70.00	20.00
9/16 - 18	11.00	9.00	12.90	70.00	20.00
5/8 - 18	12.00	9.00	14.50	70.00	20.00
3/4 - 16	14.00	11.00	17.50	80.00	22.00
7/8 - 14	18.00	14.50	20.40	80.00	22.00
1 - 12	18.00	14.50	23.25	90.00	22.00

Order no.		
985 4.826	986 4.826	987 4.826
985 6.350	986 6.350	987 6.350
985 7.938	986 7.938	987 7.938
985 9.525	986 9.525	987 9.525
985 11.113	986 11.113	987 11.113
985 12.700	986 12.700	987 12.700
985 14.288	986 14.288	987 14.288
985 15.875	986 15.875	987 15.875
985 19.050	986 19.050	987 19.050
985 22.225	986 22.225	987 22.225
985 25.400	986 25.400	987 25.400



Hand taps for BSP threads

Article no. **958**

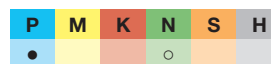

$P \leq 800 \text{ N/mm}^2$

Hand taps, first tap

Article no. **959**



Hand taps, bottoming tap

Article no. **960**

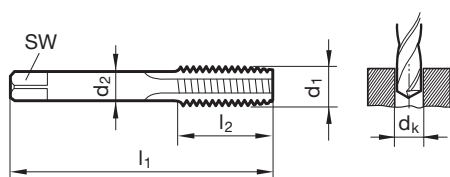

Standard	DIN 5157		
Description	Set	V	F
Article no.	958	959	960
	Order no.		
	958 9.728	959 9.728	960 9.728
	958 13.157	959 13.157	960 13.157
	958 16.662	959 16.662	960 16.662
	958 20.955	959 20.955	960 20.955
	958 22.911	959 22.911	960 22.911
	958 26.441	959 26.441	960 26.441
	958 33.249	959 33.249	960 33.249
	958 41.910	959 41.910	960 41.910
	958 44.323	959 44.323	960 44.323
	958 47.803	959 47.803	960 47.803
	958 53.746	959 53.746	960 53.746
	958 59.614	959 59.614	960 59.614

d1	P G/inch	d2 mm	SW mm	dk mm	l1 mm	l2 mm
G1/8	28	7.00	5.50	8.80	63.00	18.00
G1/4	19	11.00	9.00	11.80	70.00	20.00
G3/8	19	12.00	9.00	15.25	70.00	20.00
G1/2	14	16.00	12.00	19.00	80.00	22.00
G5/8	14	18.00	14.50	21.00	80.00	22.00
G3/4	14	20.00	16.00	24.50	90.00	22.00
G1	11	25.00	20.00	30.75	100.00	25.00
G1 1/4	11	32.00	24.00	39.50	125.00	40.00
G1 3/8	11	36.00	29.00	41.75	125.00	40.00
G1 1/2	11	36.00	29.00	45.25	140.00	40.00
G1 3/4	11	40.00	32.00	51.00	140.00	40.00
G2	11	45.00	35.00	57.00	160.00	40.00

Hand taps & dies



P ≤ 1000 N/mm²

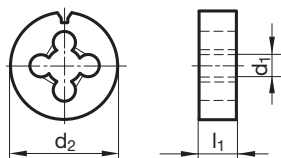

Standard	DIN EN 22568
Chamfer lead	1.75xP
Article no.	151

Hand taps & dies

d1	P mm	d2 mm	l1 mm	Workpiece Ø mm	Order no.
M1	0.250	16.00	5.00	0.97	151 1.000
M1,2	0.250	16.00	5.00	1.17	151 1.200
M1,4	0.300	16.00	5.00	1.36	151 1.400
M1,6	0.350	16.00	5.00	1.54	151 1.600
M2	0.400	16.00	5.00	1.94	151 2.000
M2,3	0.400	16.00	5.00	2.25	151 2.300
M2,5	0.450	16.00	5.00	2.43	151 2.500
M2,6	0.450	16.00	5.00	2.54	151 2.600
M3	0.500	20.00	5.00	2.92	151 3.000
M3,5	0.600	20.00	5.00	3.41	151 3.500
M4	0.700	20.00	5.00	3.91	151 4.000
M5	0.800	20.00	7.00	4.90	151 5.000
M6	1.000	20.00	7.00	5.88	151 6.000
M7	1.000	25.00	9.00	6.88	151 7.000
M8	1.250	25.00	9.00	7.87	151 8.000
M10	1.500	30.00	11.00	9.85	151 10.000
M12	1.750	38.00	14.00	11.83	151 12.000
M14	2.000	38.00	14.00	13.82	151 14.000
M16	2.000	45.00	18.00	15.82	151 16.000
M18	2.500	45.00	18.00	17.79	151 18.000
M20	2.500	45.00	18.00	19.79	151 20.000
M22	2.500	55.00	22.00	21.79	151 22.000
M24	3.000	55.00	22.00	23.77	151 24.000
M30	3.500	65.00	25.00	29.73	151 30.000



Dies for ISO metric threads

Article no. 152



P ≤ 1000 N/mm²

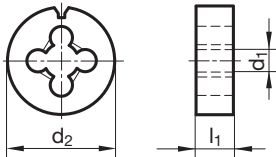

Standard	DIN EN 22568
Chamfer lead	1.75xP
Article no.	152

d1	P	d2	l1	Workpiece Ø	Order no.
mm	mm	mm	mm	mm	
M3	0.500	20.00	5.00	2.90	152 3.000
M3,5	0.600	20.00	5.00	3.40	152 3.500
M4	0.700	20.00	5.00	3.90	152 4.000
M5	0.800	20.00	7.00	4.90	152 5.000
M6	1.000	20.00	7.00	5.80	152 6.000
M7	1.000	25.00	9.00	6.80	152 7.000
M8	1.250	25.00	9.00	7.80	152 8.000
M9	1.250	25.00	9.00	8.80	152 9.000
M10	1.500	30.00	11.00	9.80	152 10.000
M12	1.750	38.00	14.00	11.80	152 12.000
M14	2.000	38.00	14.00	13.80	152 14.000
M16	2.000	45.00	18.00	15.80	152 16.000
M18	2.500	45.00	18.00	17.70	152 18.000
M20	2.500	45.00	18.00	19.70	152 20.000
M22	2.500	55.00	22.00	21.70	152 22.000
M24	3.000	55.00	22.00	23.70	152 24.000
M27	3.000	65.00	25.00	26.70	152 27.000
M30	3.500	65.00	25.00	29.70	152 30.000

Hand taps & dies

Dies for ISO metric threads

Article no. 130

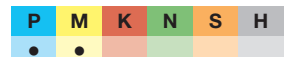

P ≤ 1200 N/mm²

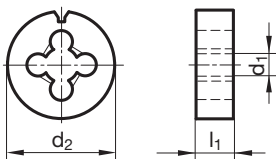

Standard	DIN EN 22568
Chamfer lead	1.75xP
Article no.	130

d1	P	d2	l1	Workpiece Ø	Order no.
mm	mm	mm	mm	mm	
M2	0.400	16.00	3.50	1.90	130 2.000
M2,5	0.450	16.00	5.00	2.40	130 2.500
M3	0.500	16.00	5.00	2.90	130 3.010
M3	0.500	20.00	5.00	2.90	130 3.020
M4	0.700	16.00	5.00	3.90	130 4.010
M4	0.700	20.00	5.00	3.90	130 4.020
M5	0.800	20.00	7.00	4.90	130 5.000
M6	1.000	20.00	7.00	5.80	130 6.000
M8	1.250	25.00	9.00	7.80	130 8.000
M10	1.500	30.00	11.00	9.80	130 10.000
M12	1.750	38.00	14.00	11.80	130 12.000
M14	2.000	38.00	14.00	13.80	130 14.000
M16	2.000	45.00	18.00	15.80	130 16.000
M20	2.500	45.00	18.00	19.70	130 20.000



Dies for ISO metric threads

Article no. **139**



P ≤ 1000 N/mm²

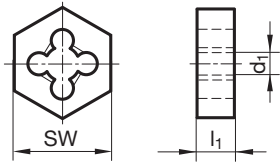

Standard	DIN 382
Chamfer lead	1.75xP
Article no.	139

Hand taps & dies

d1	P	SW	l1	Workpiece Ø	Order no.
mm	mm	mm	mm	mm	
M5	0.800	18.00	7.00	4.90	139 5.000
M6	1.000	18.00	7.00	5.88	139 6.000
M8	1.250	21.00	9.00	7.87	139 8.000
M10	1.500	27.00	11.00	9.85	139 10.000
M12	1.750	36.00	14.00	11.83	139 12.000
M16	2.000	41.00	18.00	15.82	139 16.000
M20	2.500	41.00	18.00	19.79	139 20.000
M24	3.000	50.00	22.00	23.77	139 24.000

Dies for ISO metric fine threads

Article no. 162

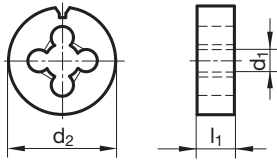
P ≤ 1000 N/mm²

Standard	DIN EN 22568
Chamfer lead	1.75xP
Article no.	162

d1	d2 mm	l1 mm	Workpiece Ø mm	Order no.
M3 x 0,35	20.00	5.00	2.90	162 3.002
M4 x 0,5	20.00	5.00	3.90	162 4.003
M5 x 0,5	20.00	5.00	4.90	162 5.003
M6 x 0,5	20.00	5.00	5.90	162 6.003
M6 x 0,75	20.00	7.00	5.90	162 6.004
M7 x 0,5	25.00	9.00	6.90	162 7.003
M7 x 0,75	25.00	9.00	6.90	162 7.004
M8 x 0,5	25.00	9.00	7.90	162 8.003
M8 x 0,75	25.00	9.00	7.90	162 8.004
M8 x 1	25.00	9.00	7.80	162 8.005
M9 x 0,75	25.00	9.00	8.90	162 9.004
M9 x 1	25.00	9.00	8.80	162 9.005
M10 x 0,75	30.00	11.00	9.90	162 10.004
M10 x 1	30.00	11.00	9.80	162 10.005
M10 x 1,25	30.00	11.00	9.80	162 10.006
M11 x 1	30.00	11.00	10.80	162 11.005
M12 X0.75	38.00	10.00	11.90	162 12.004
M12 x 1	38.00	10.00	11.80	162 12.005
M12 x 1,25	38.00	10.00	11.80	162 12.006
M12 x 1,5	38.00	10.00	11.80	162 12.007
M13 x 1	38.00	10.00	12.80	162 13.005
M14 x 1	38.00	10.00	13.80	162 14.005
M14 x 1,25	38.00	10.00	13.80	162 14.006
M14 x 1,5	38.00	10.00	13.80	162 14.007
M15 x 1	38.00	10.00	14.80	162 15.005
M16 x 1	45.00	14.00	15.80	162 16.005
M16 x 1,5	45.00	14.00	15.80	162 16.007
M17 x 1	45.00	14.00	16.80	162 17.005
M18 x 1	45.00	14.00	17.80	162 18.005
M18 x 1,5	45.00	14.00	17.80	162 18.007
M20 x 1	45.00	14.00	19.80	162 20.005
M20 x 1,5	45.00	14.00	19.80	162 20.007
M20 x 2	45.00	14.00	19.80	162 20.008
M22 x 1	55.00	16.00	21.80	162 22.005
M22 x 1,5	55.00	16.00	21.80	162 22.007
M22 x 2	55.00	16.00	21.80	162 22.008
M24 x 1,5	55.00	16.00	23.80	162 24.007
M24 x 2	55.00	16.00	23.80	162 24.008
M25 x 1,5	55.00	16.00	24.80	162 25.007
M26 x 1,5	55.00	16.00	25.80	162 26.007
M27 x 1,5	65.00	18.00	26.80	162 27.007
M27 x 2	65.00	18.00	26.80	162 27.008
M28 x 1,5	65.00	18.00	27.80	162 28.007
M30 x 1,5	65.00	18.00	29.80	162 30.007
M30 x 2	65.00	18.00	29.80	162 30.008



Dies for UNC threads

Article no. 182

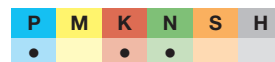
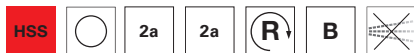
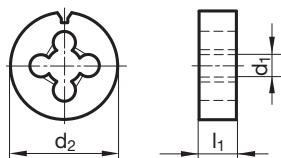
P ≤ 1000 N/mm²

Standard	DIN EN 22568
Chamfer lead	1.75xP
Article no.	182

Hand taps & dies

d1	d2 mm	l1 mm	Workpiece Ø mm	Order no.
8 - 32	20.00	7.00	4.07	182 4.166
10 - 24	20.00	7.00	4.71	182 4.826
1/4 - 20	20.00	7.00	6.22	182 6.350
5/16 - 18	25.00	9.00	7.80	182 7.938
3/8 - 16	30.00	11.00	9.37	182 9.525
7/16 - 14	30.00	11.00	10.95	182 11.113
1/2 - 13	38.00	14.00	12.52	182 12.700
5/8 - 11	45.00	18.00	15.68	182 15.875
3/4 - 10	45.00	18.00	18.84	182 19.050

Dies for UNF threads

Article no. 185

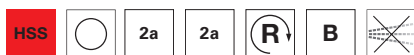
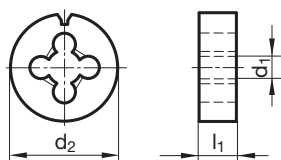
P ≤ 1000 N/mm²

Standard	DIN EN 22568
Chamfer lead	1.75xP
Article no.	185

d1	d2 mm	l1 mm	Workpiece Ø mm	Order no.
10 - 32	20.00	7.00	4.73	185 4.826
1/4 - 28	20.00	7.00	6.24	185 6.350
5/16 - 24	25.00	9.00	7.82	185 7.938
3/8 - 24	30.00	11.00	9.41	185 9.525
7/16 - 20	30.00	11.00	10.98	185 11.113
1/2 - 20	38.00	10.00	12.56	185 12.700
9/16 - 18	38.00	10.00	14.14	185 14.288
5/8 - 18	45.00	14.00	15.73	185 15.875
3/4 - 16	45.00	14.00	18.89	185 19.050
7/8 - 14	55.00	16.00	22.05	185 22.225

Dies for BSP threads

Article no. 175

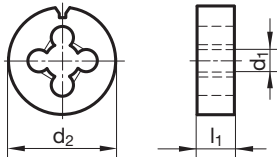
P ≤ 1000 N/mm²

Standard	DIN EN 24231
Chamfer lead	1.75xP
Article no.	175

d1	P G/inch	d2 mm	l1 mm	Workpiece Ø mm	Order no.
G1/8	28	30.00	11.00	9.62	175 9.728
G1/4	19	38.00	10.00	13.03	175 13.157
G3/8	19	45.00	14.00	16.54	175 16.662
G1/2	14	45.00	14.00	20.81	175 20.955
G3/4	14	55.00	16.00	26.30	175 26.441
G1	11	65.00	18.00	33.07	175 33.249

Dies for BSP threads

Article no. 176

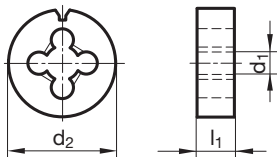
P ≤ 1000 N/mm²

Standard	DIN EN 24231
Chamfer lead	1.75xP
Article no.	176

d1	P G/inch	d2 mm	l1 mm	Workpiece Ø mm	Order no.
G1/8	28	30.00	11.00	9.62	176 9.728
G1/4	19	38.00	10.00	13.03	176 13.157
G3/8	19	45.00	14.00	16.54	176 16.662
G1/2	14	45.00	14.00	20.81	176 20.955
G5/8	14	55.00	16.00	22.77	176 22.911
G3/4	14	55.00	16.00	26.30	176 26.441
G7/8	14	65.00	18.00	30.06	176 30.201
G1	11	65.00	18.00	33.07	176 33.249
G1 1/4	11	75.00	20.00	41.73	176 41.910
G1 1/2	11	90.00	22.00	47.62	176 47.803
G2		105.00	22.00	59.43	176 59.614



Dies for R-threads BSPT

Article no. **198**



P ≤ 1000 N/mm²

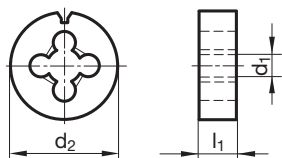

Standard	DIN EN 24230
Chamfer lead	1.75xP
Article no.	198

d1	P G/inch	d2 mm	l1 mm	Workpiece Ø mm	Order no.
R1/8	28	30.00	11.00	9.48	198 9.728
R1/4	19	38.00	14.00	12.78	198 13.157
R3/8	19	45.00	14.00	16.26	198 16.662
R1/2	14	45.00	18.00	20.44	198 20.955

Hand taps & dies

Dies for NPT threads

Article no. **191**



P ≤ 1000 N/mm²

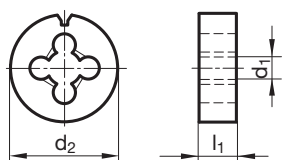

Standard	DIN EN 22568
Chamfer lead	1.75xP
Article no.	191

d1	P G/inch	d2 mm	l1 mm	Workpiece Ø mm	Order no.
1/8	27	30.00	11.00	9.93	191 10.620
1/4	18	38.00	14.00	13.18	191 14.140
3/8	18	45.00	14.00	16.60	191 17.570
1/2	14	45.00	18.00	20.63	191 21.900
3/4	14	55.00	22.00	25.95	191 27.230

CNC Gühro ThreadMill

FIND THE OPTIMAL CNC PROGRAMME

FOR YOUR THREAD MILLING CUTTER

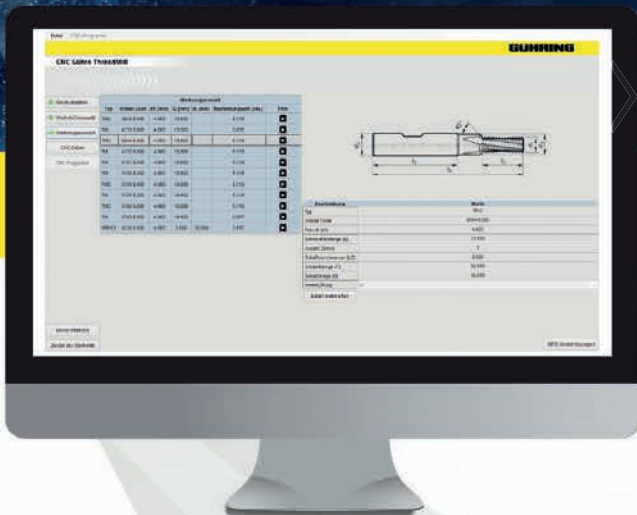

To the optimal CNC programme in five steps

- 1. Specify the thread data**
Select from all current thread standards
- 2. Select the material**
You are always referred to the optimal parameters
- 3. Select the tool**
Technical data, drawing, machining time and video simplify selection
- 4. Record CNC data**
Enter required milling strategy and parameters
- 5. Receive CNC programme with code and data sheet**
Programming data (Sinumerik, Haidenhain, Fancu, Philips, Mazatrol or Hurco) are imported and automatically recognised



High-performance taps and fluteless taps Pionex



Cutting data

Machining group	Taps				Fluteless taps
	Blind holes		Through-holes		
	HSS-E	HSS-E-PM	HSS-E	HSS-E-PM	HSS-E-PM
	A	A	S	S	C
v _c (m/min)					
P1.1.1 Unalloyed steel, annealed, 0.15 % C, Rm 420 N/mm ² , 125 HB	18	23	20	26	27
P1.1.2 Unalloyed steel, heat-treated, 0.15 % C, Rm 420 N/mm ² , 125 HB	18	23	20	26	27
P1.1.3 Unalloyed steel, annealed, 0.45 % C, Rm 640 N/mm ² , 190 HB	18	23	20	26	27
P1.1.4 Unalloyed steel, heat-treated, 0.45 % C, Rm 640 N/mm ² , 190 HB	18	23	20	26	27
P1.1.5 Unalloyed steel, heat-treated, 0.45 % C, Rm 850 N/mm ² , 250 HB	18	23	20	26	27
P1.1.6 Unalloyed steel, annealed, 0.75 % C, Rm 915 N/mm ² , 270 HB	15	20	17	22	27
P1.1.7 Unalloyed steel, heat-treated, 0.75 % C, Rm 1020 N/mm ² , 300 HB	13	16	14	18	27
P2.1.1 Low-alloy steel, annealed, Rm 610 N/mm ² , 180 HB	18	23	20	26	22
P2.1.2 Low-alloy steel, heat-treated, Rm 930 N/mm ² , 275 HB	15	20	17	22	22
P2.1.3 Low-alloy steel, heat-treated, Rm 1020 N/mm ² , 300 HB	13	16	14	18	22
P2.1.4 Low-alloy steel, heat-treated, Rm 1190 N/mm ² , 350 HB	11	14	12	15	22
P3.1.1 High-alloy steel and tool steel, annealed, Rm 680 N/mm ² , 200 HB	11	14	12	15	16
P3.1.2 High-alloy steel and tool steel, hardened and tempered, Rm 1100 N/mm ² , 325 HB	11	14	12	15	16
M1.1.1 Stainless steel, ferritic/martensitic, with machining additives	11	14	12	15	11
M1.1.2 Stainless steel, ferritic/martensitic, annealed, Rm 680 N/mm ² , 200 HB	11	14	12	15	11
M1.1.3 Stainless steel, ferritic/martensitic, heat-treated, Rm 810 N/mm ² , 240 HB	6	8	7	9	8
M2.1.1 Stainless steel, austenitic, quenched, 180 HB	4	5	4	5	7
M2.2.1 Duplex steel, high-strength stainless steels	3	4	3	4	
K1.1.1 Grey cast iron, pearlitic/ferritic, 180 HB	14	19	16	21	
K1.1.2 Grey cast iron, pearlitic/martensitic, 260 HB	14	19	16	21	
K1.2.1 Cast iron with spheroidal graphite, ferritic, 160 HB	14	19	16	21	27
K1.2.2 Cast iron with spheroidal graphite, pearlitic, 250 HB	14	19	16	21	27
K1.3.1 Malleable cast iron, ferritic, 130 HB	14	19	16	21	27
K1.3.2 Malleable cast iron, pearlitic, 230 HB	14	19	16	21	27
K2.1.1 Vermicular graphite cast iron (GJV)	9	11	10	12	22
K2.2.1 Austenitic-ferritic spheroidal graphite cast iron (ADI)	9	11	10	12	22
N1.1.1 Wrought aluminium alloys, non-hardened, 60 HB	25	33	28	36	17
N1.1.2 Wrought aluminium alloys, hardened, 100 HB	25	33	28	36	17
N2.1.1 Aluminium casting alloys, non-hardened, ≤ 12 % Si, 75 HB	20	26	22	29	33
N2.1.2 Aluminium casting alloys, hardened, ≤ 12 % Si, 90 HB	20	26	22	29	33
N2.1.3 Aluminium casting alloys, non-hardened, > 12 % Si, 130 HB	15	20	17	22	27
N3.1.1 Copper and copper alloys: Free-machining alloy, Pb > 1 %					
N3.1.2 Copper and copper alloys: CuZn, CuSnZn					
N3.1.3 Copper and copper alloys: CuSn, lead-free copper and copper electrolyte					
N4.1.1 Non-metallic materials: Duroplastics, fibre-reinforced plastics					
N4.1.2 Non-metallic materials: Hard rubber, wood, etc.					
N4.1.3 Non-metallic materials: Graphite					
S1.1.1 Heat-resistant alloys, Fe-based, annealed, 200 HB	2	2	2	2	4
S1.1.2 Heat-resistant alloys, Fe-based, hardened, 280 HB	2	2	2	2	4
S1.1.3 Heat-resistant alloys, Ni- or Co-based, annealed, 250 HB	2	2	2	2	4
S1.1.4 Heat-resistant alloys, Ni- or Co-based, hardened, 350 HB	2	2	2	2	4
S1.1.5 Heat-resistant alloys, Ni- or Co-based, cast, 320 HB	2	2	2	2	4
S2.1.1 Titanium alloys, pure titanium, Rm 400 N/mm ²	2	2	2	2	4
S2.1.2 Titanium alloys, Alpha and Beta alloys, hardened, Rm 1050 N/mm ²	2	2	2	2	4
H1.1.1 Hardened steel, hardened and tempered, < 55 HRC					
H1.1.2 Hardened steel, hardened and tempered, < 60 HRC					
H1.1.3 Hardened steel, hardened and tempered, > 60 HRC					
H2.1.1 Chilled cast iron, 400 HB					
H2.1.2 Chilled cast iron, hardened and tempered, < 55 HRC					

Taps ISO P ≤ 850 N/mm²

Machining group	Blind holes		Through-holes		Through-, blind holes
	HSS-E		HSS-E		HSS-E-PM
	○	Ⓢ	○	Ⓢ	○
v _c (m/min)					
P1.1.1 Unalloyed steel, annealed, 0.15 % C, Rm 420 N/mm ² , 125 HB	12	17	13	18	12
P1.1.2 Unalloyed steel, heat-treated, 0.15 % C, Rm 420 N/mm ² , 125 HB	12	17	13	18	12
P1.1.3 Unalloyed steel, annealed, 0.45 % C, Rm 640 N/mm ² , 190 HB	12	17	13	18	12
P1.1.4 Unalloyed steel, heat-treated, 0.45 % C, Rm 640 N/mm ² , 190 HB	12	17	13	18	12
P1.1.5 Unalloyed steel, heat-treated, 0.45 % C, Rm 850 N/mm ² , 250 HB	12	17	13	18	12
P1.1.6 Unalloyed steel, annealed, 0.75 % C, Rm 915 N/mm ² , 270 HB					
P1.1.7 Unalloyed steel, heat-treated, 0.75 % C, Rm 1020 N/mm ² , 300 HB					
P2.1.1 Low-alloy steel, annealed, Rm 610 N/mm ² , 180 HB					
P2.1.2 Low-alloy steel, heat-treated, Rm 930 N/mm ² , 275 HB					
P2.1.3 Low-alloy steel, heat-treated, Rm 1020 N/mm ² , 300 HB					
P2.1.4 Low-alloy steel, heat-treated, Rm 1190 N/mm ² , 350 HB					
P3.1.1 High-alloy steel and tool steel, annealed, Rm 680 N/mm ² , 200 HB					
P3.1.2 High-alloy steel and tool steel, hardened and tempered, Rm 1100 N/mm ² , 325 HB					
M1.1.1 Stainless steel, ferritic/martensitic, with machining additives					
M1.1.2 Stainless steel, ferritic/martensitic, annealed, Rm 680 N/mm ² , 200 HB					
M1.1.3 Stainless steel, ferritic/martensitic, heat-treated, Rm 810 N/mm ² , 240 HB					
M2.1.1 Stainless steel, austenitic, quenched, 180 HB					
M2.2.1 Duplex steel, high-strength stainless steels					
K1.1.1 Grey cast iron, pearlitic/ferritic, 180 HB					
K1.1.2 Grey cast iron, pearlitic/martensitic, 260 HB					
K1.2.1 Cast iron with spheroidal graphite, ferritic, 160 HB					
K1.2.2 Cast iron with spheroidal graphite, pearlitic, 250 HB					
K1.3.1 Malleable cast iron, ferritic, 130 HB					
K1.3.2 Malleable cast iron, pearlitic, 230 HB					
K2.1.1 Vermicular graphite cast iron (GJV)					
K2.2.1 Austenitic-ferritic spheroidal graphite cast iron (ADI)					
N1.1.1 Wrought aluminium alloys, non-hardened, 60 HB					
N1.1.2 Wrought aluminium alloys, hardened, 100 HB					
N2.1.1 Aluminium casting alloys, non-hardened, ≤ 12 % Si, 75 HB					
N2.1.2 Aluminium casting alloys, hardened, ≤ 12 % Si, 90 HB					
N2.1.3 Aluminium casting alloys, non-hardened, > 12 % Si, 130 HB					
N3.1.1 Copper and copper alloys: Free-machining alloy, Pb > 1 %					
N3.1.2 Copper and copper alloys: CuZn, CuSnZn					
N3.1.3 Copper and copper alloys: CuSn, lead-free copper and copper electrolyte					
N4.1.1 Non-metallic materials: Duroplastics, fibre-reinforced plastics					
N4.1.2 Non-metallic materials: Hard rubber, wood, etc.					
N4.1.3 Non-metallic materials: Graphite					
S1.1.1 Heat-resistant alloys, Fe-based, annealed, 200 HB					
S1.1.2 Heat-resistant alloys, Fe-based, hardened, 280 HB					
S1.1.3 Heat-resistant alloys, Ni- or Co-based, annealed, 250 HB					
S1.1.4 Heat-resistant alloys, Ni- or Co-based, hardened, 350 HB					
S1.1.5 Heat-resistant alloys, Ni- or Co-based, cast, 320 HB					
S2.1.1 Titanium alloys, pure titanium, Rm 400 N/mm ²					
S2.1.2 Titanium alloys, Alpha and Beta alloys, hardened, Rm 1050 N/mm ²					
H1.1.1 Hardened steel, hardened and tempered, < 55 HRC					
H1.1.2 Hardened steel, hardened and tempered, < 60 HRC					
H1.1.3 Hardened steel, hardened and tempered, > 60 HRC					
H2.1.1 Chilled cast iron, 400 HB					
H2.1.2 Chilled cast iron, hardened and tempered, < 55 HRC					



Taps ISO P ≤ 1020 N/mm², ISO M, ISO N



Cutting data

Machining group	Blind holes				Through-holes				
	HSS-E		HSS-E-PM		HSS-E		HSS-E-PM		VHM
	⊙	Ⓢ	Ⓒ	Ⓢ	⊙	Ⓢ	Ⓢ	Ⓒ	
	v _c (m/min)								
P1.1.1 Unalloyed steel, annealed, 0.15 % C, Rm 420 N/mm ² , 125 HB	14	17	17	22	15	18	24	46	
P1.1.2 Unalloyed steel, heat-treated, 0.15 % C, Rm 420 N/mm ² , 125 HB	14	17	17	22	15	18	24	46	
P1.1.3 Unalloyed steel, annealed, 0.45 % C, Rm 640 N/mm ² , 190 HB	14	17	17	22	15	18	24	46	
P1.1.4 Unalloyed steel, heat-treated, 0.45 % C, Rm 640 N/mm ² , 190 HB	14	17	17	22	15	18	24	46	
P1.1.5 Unalloyed steel, heat-treated, 0.45 % C, Rm 850 N/mm ² , 250 HB	14	17	17	22	15	18	24	46	
P1.1.6 Unalloyed steel, annealed, 0.75 % C, Rm 915 N/mm ² , 270 HB	12	14	14	19	13	16	20	39	
P1.1.7 Unalloyed steel, heat-treated, 0.75 % C, Rm 1020 N/mm ² , 300 HB	10	12	12	15	11	13	17	32	
P2.1.1 Low-alloy steel, annealed, Rm 610 N/mm ² , 180 HB	12	14	14	18	13	15	20	39	
P2.1.2 Low-alloy steel, heat-treated, Rm 930 N/mm ² , 275 HB	10	12	12	15	11	13	17	33	
P2.1.3 Low-alloy steel, heat-treated, Rm 1020 N/mm ² , 300 HB	8	10	10	13	9	11	14	27	
P2.1.4 Low-alloy steel, heat-treated, Rm 1190 N/mm ² , 350 HB									
P3.1.1 High-alloy steel and tool steel, annealed, Rm 680 N/mm ² , 200 HB									
P3.1.2 High-alloy steel and tool steel, hardened and tempered, Rm 1100 N/mm ² , 325 HB									
M1.1.1 Stainless steel, ferritic/martensitic, with machining additives	9	11	11	15	10	12	16		
M1.1.2 Stainless steel, ferritic/martensitic, annealed, Rm 680 N/mm ² , 200 HB	9	11	11	15	10	12	16		
M1.1.3 Stainless steel, ferritic/martensitic, heat-treated, Rm 810 N/mm ² , 240 HB	6	7	7	9	6	7	10		
M2.1.1 Stainless steel, austenitic, quenched, 180 HB	3	4	4	5	4	5	6		
M2.2.1 Duplex steel, high-strength stainless steels									
K1.1.1 Grey cast iron, pearlitic/ferritic, 180 HB									
K1.1.2 Grey cast iron, pearlitic/martensitic, 260 HB									
K1.2.1 Cast iron with spheroidal graphite, ferritic, 160 HB									
K1.2.2 Cast iron with spheroidal graphite, pearlitic, 250 HB									
K1.3.1 Malleable cast iron, ferritic, 130 HB									
K1.3.2 Malleable cast iron, pearlitic, 230 HB									
K2.1.1 Vermicular graphite cast iron (GJV)									
K2.2.1 Austenitic-ferritic spheroidal graphite cast iron (ADI)									
N1.1.1 Wrought aluminium alloys, non-hardened, 60 HB	16		20		18				
N1.1.2 Wrought aluminium alloys, hardened, 100 HB	16		20		18				
N2.1.1 Aluminium casting alloys, non-hardened, ≤ 12 % Si, 75 HB									
N2.1.2 Aluminium casting alloys, hardened, ≤ 12 % Si, 90 HB									
N2.1.3 Aluminium casting alloys, non-hardened, > 12 % Si, 130 HB									
N3.1.1 Copper and copper alloys: Free-machining alloy, Pb > 1 %									
N3.1.2 Copper and copper alloys: CuZn, CuSnZn	16				18				
N3.1.3 Copper and copper alloys: CuSn, lead-free copper and copper electrolyte									
N4.1.1 Non-metallic materials: Duroplastics, fibre-reinforced plastics									
N4.1.2 Non-metallic materials: Hard rubber, wood, etc.									
N4.1.3 Non-metallic materials: Graphite									
S1.1.1 Heat-resistant alloys, Fe-based, annealed, 200 HB									
S1.1.2 Heat-resistant alloys, Fe-based, hardened, 280 HB									
S1.1.3 Heat-resistant alloys, Ni- or Co-based, annealed, 250 HB									
S1.1.4 Heat-resistant alloys, Ni- or Co-based, hardened, 350 HB									
S1.1.5 Heat-resistant alloys, Ni- or Co-based, cast, 320 HB									
S2.1.1 Titanium alloys, pure titanium, Rm 400 N/mm ²									
S2.1.2 Titanium alloys, Alpha and Beta alloys, hardened, Rm 1050 N/mm ²									
H1.1.1 Hardened steel, hardened and tempered, < 55 HRC									
H1.1.2 Hardened steel, hardened and tempered, < 60 HRC									
H1.1.3 Hardened steel, hardened and tempered, > 60 HRC									
H2.1.1 Chilled cast iron, 400 HB									
H2.1.2 Chilled cast iron, hardened and tempered, < 55 HRC									

Taps ISO P 900 up to 1200 N/mm², ISO K, ISO N

Machining group	Blind holes					Through-holes			Through-, blind holes	
	HSS-E		HSS-E-PM			HSS-E		HSS-E-PM	HSS-E	HSS-E-PM
	●	●	●	●	●	●	●	●	●	●
	v _c (m/min)									
P1.1.1 Unalloyed steel, annealed, 0.15 % C, Rm 420 N/mm ² , 125 HB										
P1.1.2 Unalloyed steel, heat-treated, 0.15 % C, Rm 420 N/mm ² , 125 HB										
P1.1.3 Unalloyed steel, annealed, 0.45 % C, Rm 640 N/mm ² , 190 HB										
P1.1.4 Unalloyed steel, heat-treated, 0.45 % C, Rm 640 N/mm ² , 190 HB										
P1.1.5 Unalloyed steel, heat-treated, 0.45 % C, Rm 850 N/mm ² , 250 HB										
P1.1.6 Unalloyed steel, annealed, 0.75 % C, Rm 915 N/mm ² , 270 HB										
P1.1.7 Unalloyed steel, heat-treated, 0.75 % C, Rm 1020 N/mm ² , 300 HB										
P2.1.1 Low-alloy steel, annealed, Rm 610 N/mm ² , 180 HB										
P2.1.2 Low-alloy steel, heat-treated, Rm 930 N/mm ² , 275 HB	10	12	12	15	17	11	13	18	12	15
P2.1.3 Low-alloy steel, heat-treated, Rm 1020 N/mm ² , 300 HB	8	10	10	13	14	9	11	15	10	13
P2.1.4 Low-alloy steel, heat-treated, Rm 1190 N/mm ² , 350 HB	7	8	8	11	12	8	9	13	8	11
P3.1.1 High-alloy steel and tool steel, annealed, Rm 680 N/mm ² , 200 HB	6	7	7	9	9	6	7	10	7	9
P3.1.2 High-alloy steel and tool steel, hardened and tempered, Rm 1100 N/mm ² , 325 HB	6	7	7	9	9	6	7	10	7	9
M1.1.1 Stainless steel, ferritic/martensitic, with machining additives										
M1.1.2 Stainless steel, ferritic/martensitic, annealed, Rm 680 N/mm ² , 200 HB										
M1.1.3 Stainless steel, ferritic/martensitic, heat-treated, Rm 810 N/mm ² , 240 HB										
M2.1.1 Stainless steel, austenitic, quenched, 180 HB										
M2.2.1 Duplex steel, high-strength stainless steels										
K1.1.1 Grey cast iron, pearlitic/ferritic, 180 HB									19	25
K1.1.2 Grey cast iron, pearlitic/martensitic, 260 HB									19	25
K1.2.1 Cast iron with spheroidal graphite, ferritic, 160 HB									19	25
K1.2.2 Cast iron with spheroidal graphite, pearlitic, 250 HB									19	25
K1.3.1 Malleable cast iron, ferritic, 130 HB									19	25
K1.3.2 Malleable cast iron, pearlitic, 230 HB									19	25
K2.1.1 Vermicular graphite cast iron (GJV)									9	12
K2.2.1 Austenitic-ferritic spheroidal graphite cast iron (ADI)									9	12
N1.1.1 Wrought aluminium alloys, non-hardened, 60 HB										
N1.1.2 Wrought aluminium alloys, hardened, 100 HB										
N2.1.1 Aluminium casting alloys, non-hardened, ≤ 12 % Si, 75 HB									16	20
N2.1.2 Aluminium casting alloys, hardened, ≤ 12 % Si, 90 HB									16	20
N2.1.3 Aluminium casting alloys, non-hardened, > 12 % Si, 130 HB									12	15
N3.1.1 Copper and copper alloys: Free-machining alloy, Pb > 1 %										
N3.1.2 Copper and copper alloys: CuZn, CuSnZn										
N3.1.3 Copper and copper alloys: CuSn, lead-free copper and copper electrolyte										
N4.1.1 Non-metallic materials: Duroplastics, fibre-reinforced plastics										
N4.1.2 Non-metallic materials: Hard rubber, wood, etc.										
N4.1.3 Non-metallic materials: Graphite										
S1.1.1 Heat-resistant alloys, Fe-based, annealed, 200 HB										
S1.1.2 Heat-resistant alloys, Fe-based, hardened, 280 HB										
S1.1.3 Heat-resistant alloys, Ni- or Co-based, annealed, 250 HB										
S1.1.4 Heat-resistant alloys, Ni- or Co-based, hardened, 350 HB										
S1.1.5 Heat-resistant alloys, Ni- or Co-based, cast, 320 HB										
S2.1.1 Titanium alloys, pure titanium, Rm 400 N/mm ²										
S2.1.2 Titanium alloys, Alpha and Beta alloys, hardened, Rm 1050 N/mm ²										
H1.1.1 Hardened steel, hardened and tempered, < 55 HRC										
H1.1.2 Hardened steel, hardened and tempered, < 60 HRC										
H1.1.3 Hardened steel, hardened and tempered, > 60 HRC										
H2.1.1 Chilled cast iron, 400 HB										
H2.1.2 Chilled cast iron, hardened and tempered, < 55 HRC										



Taps ISO P 900 up to 1200 N/mm², ISO K, ISO N



Cutting data

Machining group	Through-, blind holes			
	HSS-E		VHM	
	○	⦿	○	⦿
v _c (m/min)				
P1.1.1 Unalloyed steel, annealed, 0.15 % C, Rm 420 N/mm ² , 125 HB				
P1.1.2 Unalloyed steel, heat-treated, 0.15 % C, Rm 420 N/mm ² , 125 HB				
P1.1.3 Unalloyed steel, annealed, 0.45 % C, Rm 640 N/mm ² , 190 HB				
P1.1.4 Unalloyed steel, heat-treated, 0.45 % C, Rm 640 N/mm ² , 190 HB				
P1.1.5 Unalloyed steel, heat-treated, 0.45 % C, Rm 850 N/mm ² , 250 HB				
P1.1.6 Unalloyed steel, annealed, 0.75 % C, Rm 915 N/mm ² , 270 HB				
P1.1.7 Unalloyed steel, heat-treated, 0.75 % C, Rm 1020 N/mm ² , 300 HB				
P2.1.1 Low-alloy steel, annealed, Rm 610 N/mm ² , 180 HB				
P2.1.2 Low-alloy steel, heat-treated, Rm 930 N/mm ² , 275 HB				
P2.1.3 Low-alloy steel, heat-treated, Rm 1020 N/mm ² , 300 HB				
P2.1.4 Low-alloy steel, heat-treated, Rm 1190 N/mm ² , 350 HB				
P3.1.1 High-alloy steel and tool steel, annealed, Rm 680 N/mm ² , 200 HB				
P3.1.2 High-alloy steel and tool steel, hardened and tempered, Rm 1100 N/mm ² , 325 HB				
M1.1.1 Stainless steel, ferritic/martensitic, with machining additives				
M1.1.2 Stainless steel, ferritic/martensitic, annealed, Rm 680 N/mm ² , 200 HB				
M1.1.3 Stainless steel, ferritic/martensitic, heat-treated, Rm 810 N/mm ² , 240 HB				
M2.1.1 Stainless steel, austenitic, quenched, 180 HB				
M2.2.1 Duplex steel, high-strength stainless steels				
K1.1.1 Grey cast iron, pearlitic/ferritic, 180 HB	16	20	34	51
K1.1.2 Grey cast iron, pearlitic/martensitic, 260 HB	16	20	34	51
K1.2.1 Cast iron with spheroidal graphite, ferritic, 160 HB	16	20	34	51
K1.2.2 Cast iron with spheroidal graphite, pearlitic, 250 HB	16	20	34	51
K1.3.1 Malleable cast iron, ferritic, 130 HB	16	20	34	51
K1.3.2 Malleable cast iron, pearlitic, 230 HB	16	20	34	51
K2.1.1 Vermicular graphite cast iron (GJV)		10	17	25
K2.2.1 Austenitic-ferritic spheroidal graphite cast iron (ADI)		10	17	25
N1.1.1 Wrought aluminium alloys, non-hardened, 60 HB				
N1.1.2 Wrought aluminium alloys, hardened, 100 HB				
N2.1.1 Aluminium casting alloys, non-hardened, ≤ 12 % Si, 75 HB				
N2.1.2 Aluminium casting alloys, hardened, ≤ 12 % Si, 90 HB				
N2.1.3 Aluminium casting alloys, non-hardened, > 12 % Si, 130 HB				
N3.1.1 Copper and copper alloys: Free-machining alloy, Pb > 1 %				
N3.1.2 Copper and copper alloys: CuZn, CuSnZn				
N3.1.3 Copper and copper alloys: CuSn, lead-free copper and copper electrolyte				
N4.1.1 Non-metallic materials: Duroplastics, fibre-reinforced plastics				
N4.1.2 Non-metallic materials: Hard rubber, wood, etc.				
N4.1.3 Non-metallic materials: Graphite				
S1.1.1 Heat-resistant alloys, Fe-based, annealed, 200 HB				
S1.1.2 Heat-resistant alloys, Fe-based, hardened, 280 HB				
S1.1.3 Heat-resistant alloys, Ni- or Co-based, annealed, 250 HB				
S1.1.4 Heat-resistant alloys, Ni- or Co-based, hardened, 350 HB				
S1.1.5 Heat-resistant alloys, Ni- or Co-based, cast, 320 HB				
S2.1.1 Titanium alloys, pure titanium, Rm 400 N/mm ²				
S2.1.2 Titanium alloys, Alpha and Beta alloys, hardened, Rm 1050 N/mm ²				
H1.1.1 Hardened steel, hardened and tempered, < 55 HRC				
H1.1.2 Hardened steel, hardened and tempered, < 60 HRC				
H1.1.3 Hardened steel, hardened and tempered, > 60 HRC				
H2.1.1 Chilled cast iron, 400 HB				
H2.1.2 Chilled cast iron, hardened and tempered, < 55 HRC				

Taps ISO N, ISO S



Machining group	Blind holes				Through-holes			
	HSS-E		VHM		HSS-E		VHM	
	○	⊙	○	⊙	○	⊙	○	⊙
v _c (m/min)								
P1.1.1 Unalloyed steel, annealed, 0.15 % C, Rm 420 N/mm ² , 125 HB								
P1.1.2 Unalloyed steel, heat-treated, 0.15 % C, Rm 420 N/mm ² , 125 HB								
P1.1.3 Unalloyed steel, annealed, 0.45 % C, Rm 640 N/mm ² , 190 HB								
P1.1.4 Unalloyed steel, heat-treated, 0.45 % C, Rm 640 N/mm ² , 190 HB								
P1.1.5 Unalloyed steel, heat-treated, 0.45 % C, Rm 850 N/mm ² , 250 HB								
P1.1.6 Unalloyed steel, annealed, 0.75 % C, Rm 915 N/mm ² , 270 HB								
P1.1.7 Unalloyed steel, heat-treated, 0.75 % C, Rm 1020 N/mm ² , 300 HB								
P2.1.1 Low-alloy steel, annealed, Rm 610 N/mm ² , 180 HB								
P2.1.2 Low-alloy steel, heat-treated, Rm 930 N/mm ² , 275 HB								
P2.1.3 Low-alloy steel, heat-treated, Rm 1020 N/mm ² , 300 HB								
P2.1.4 Low-alloy steel, heat-treated, Rm 1190 N/mm ² , 350 HB								
P3.1.1 High-alloy steel and tool steel, annealed, Rm 680 N/mm ² , 200 HB								
P3.1.2 High-alloy steel and tool steel, hardened and tempered, Rm 1100 N/mm ² , 325 HB								
M1.1.1 Stainless steel, ferritic/martensitic, with machining additives								
M1.1.2 Stainless steel, ferritic/martensitic, annealed, Rm 680 N/mm ² , 200 HB								
M1.1.3 Stainless steel, ferritic/martensitic, heat-treated, Rm 810 N/mm ² , 240 HB								
M2.1.1 Stainless steel, austenitic, quenched, 180 HB								
M2.2.1 Duplex steel, high-strength stainless steels								
K1.1.1 Grey cast iron, pearlitic/ferritic, 180 HB								
K1.1.2 Grey cast iron, pearlitic/martensitic, 260 HB								
K1.2.1 Cast iron with spheroidal graphite, ferritic, 160 HB								
K1.2.2 Cast iron with spheroidal graphite, pearlitic, 250 HB								
K1.3.1 Malleable cast iron, ferritic, 130 HB								
K1.3.2 Malleable cast iron, pearlitic, 230 HB								
K2.1.1 Vermicular graphite cast iron (GJV)								
K2.2.1 Austenitic-ferritic spheroidal graphite cast iron (ADI)								
N1.1.1 Wrought aluminium alloys, non-hardened, 60 HB	14	27			15	29		
N1.1.2 Wrought aluminium alloys, hardened, 100 HB	14	27			15	29		
N2.1.1 Aluminium casting alloys, non-hardened, ≤ 12 % Si, 75 HB	11	21	28	53	12	23	31	59
N2.1.2 Aluminium casting alloys, hardened, ≤ 12 % Si, 90 HB	11	21	28	53	12	23	31	59
N2.1.3 Aluminium casting alloys, non-hardened, > 12 % Si, 130 HB	8	16	21	40	9	18	23	44
N3.1.1 Copper and copper alloys: Free-machining alloy, Pb > 1 %	14	27			15	29		
N3.1.2 Copper and copper alloys: CuZn, CuSnZn	14	27			15	29		
N3.1.3 Copper and copper alloys: CuSn, lead-free copper and copper electrolyte	14	27			15	29		
N4.1.1 Non-metallic materials: Duroplastics, fibre-reinforced plastics								
N4.1.2 Non-metallic materials: Hard rubber, wood, etc.								
N4.1.3 Non-metallic materials: Graphite								
S1.1.1 Heat-resistant alloys, Fe-based, annealed, 200 HB								
S1.1.2 Heat-resistant alloys, Fe-based, hardened, 280 HB								
S1.1.3 Heat-resistant alloys, Ni- or Co-based, annealed, 250 HB								
S1.1.4 Heat-resistant alloys, Ni- or Co-based, hardened, 350 HB								
S1.1.5 Heat-resistant alloys, Ni- or Co-based, cast, 320 HB								
S2.1.1 Titanium alloys, pure titanium, Rm 400 N/mm ²		3				3		
S2.1.2 Titanium alloys, Alpha and Beta alloys, hardened, Rm 1050 N/mm ²		3				3		
H1.1.1 Hardened steel, hardened and tempered, < 55 HRC								
H1.1.2 Hardened steel, hardened and tempered, < 60 HRC								
H1.1.3 Hardened steel, hardened and tempered, > 60 HRC								
H2.1.1 Chilled cast iron, 400 HB								
H2.1.2 Chilled cast iron, hardened and tempered, < 55 HRC								



Taps ISO M, ISO P ≤ 1020 N/mm², ISO N



Cutting data

Machining group	Blind holes					Through-holes	
	HSS-E			HSS-E-PM		HSS-E	
	○	●	⦿	⦿	⦿	○	●
	v _c (m/min)						
P1.1.1 Unalloyed steel, annealed, 0.15 % C, Rm 420 N/mm ² , 125 HB	12	14	17	22	22	13	15
P1.1.2 Unalloyed steel, heat-treated, 0.15 % C, Rm 420 N/mm ² , 125 HB	12	14	17	22	22	13	15
P1.1.3 Unalloyed steel, annealed, 0.45 % C, Rm 640 N/mm ² , 190 HB	12	14	17	22	22	13	15
P1.1.4 Unalloyed steel, heat-treated, 0.45 % C, Rm 640 N/mm ² , 190 HB	12	14	17	22	22	13	15
P1.1.5 Unalloyed steel, heat-treated, 0.45 % C, Rm 850 N/mm ² , 250 HB	12	14	17	22	22	13	15
P1.1.6 Unalloyed steel, annealed, 0.75 % C, Rm 915 N/mm ² , 270 HB	10	12	14	19	19	11	13
P1.1.7 Unalloyed steel, heat-treated, 0.75 % C, Rm 1020 N/mm ² , 300 HB	8	10	12	15	15	9	11
P2.1.1 Low-alloy steel, annealed, Rm 610 N/mm ² , 180 HB	10	12	14	18	18	11	13
P2.1.2 Low-alloy steel, heat-treated, Rm 930 N/mm ² , 275 HB	9	10	12	15	15	9	11
P2.1.3 Low-alloy steel, heat-treated, Rm 1020 N/mm ² , 300 HB	7	8	10	13	13	8	9
P2.1.4 Low-alloy steel, heat-treated, Rm 1190 N/mm ² , 350 HB							
P3.1.1 High-alloy steel and tool steel, annealed, Rm 680 N/mm ² , 200 HB							
P3.1.2 High-alloy steel and tool steel, hardened and tempered, Rm 1100 N/mm ² , 325 HB							
M1.1.1 Stainless steel, ferritic/martensitic, with machining additives	8	9	11	15	15	9	10
M1.1.2 Stainless steel, ferritic/martensitic, annealed, Rm 680 N/mm ² , 200 HB	8	9	11	15	15	9	10
M1.1.3 Stainless steel, ferritic/martensitic, heat-treated, Rm 810 N/mm ² , 240 HB	5	6	7	9	9	5	6
M2.1.1 Stainless steel, austenitic, quenched, 180 HB	3	3	4	5	5	3	4
M2.2.1 Duplex steel, high-strength stainless steels							
K1.1.1 Grey cast iron, pearlitic/ferritic, 180 HB							
K1.1.2 Grey cast iron, pearlitic/martensitic, 260 HB							
K1.2.1 Cast iron with spheroidal graphite, ferritic, 160 HB							
K1.2.2 Cast iron with spheroidal graphite, pearlitic, 250 HB							
K1.3.1 Malleable cast iron, ferritic, 130 HB							
K1.3.2 Malleable cast iron, pearlitic, 230 HB							
K2.1.1 Vermicular graphite cast iron (GJV)							
K2.2.1 Austenitic-ferritic spheroidal graphite cast iron (ADI)							
N1.1.1 Wrought aluminium alloys, non-hardened, 60 HB	14	16			25	15	18
N1.1.2 Wrought aluminium alloys, hardened, 100 HB	14	16			25	15	18
N2.1.1 Aluminium casting alloys, non-hardened, ≤ 12 % Si, 75 HB							
N2.1.2 Aluminium casting alloys, hardened, ≤ 12 % Si, 90 HB							
N2.1.3 Aluminium casting alloys, non-hardened, > 12 % Si, 130 HB							
N3.1.1 Copper and copper alloys: Free-machining alloy, Pb > 1 %							
N3.1.2 Copper and copper alloys: CuZn, CuSnZn	14	16				15	18
N3.1.3 Copper and copper alloys: CuSn, lead-free copper and copper electrolyte							
N4.1.1 Non-metallic materials: Duroplastics, fibre-reinforced plastics							
N4.1.2 Non-metallic materials: Hard rubber, wood, etc.							
N4.1.3 Non-metallic materials: Graphite							
S1.1.1 Heat-resistant alloys, Fe-based, annealed, 200 HB							
S1.1.2 Heat-resistant alloys, Fe-based, hardened, 280 HB							
S1.1.3 Heat-resistant alloys, Ni- or Co-based, annealed, 250 HB							
S1.1.4 Heat-resistant alloys, Ni- or Co-based, hardened, 350 HB							
S1.1.5 Heat-resistant alloys, Ni- or Co-based, cast, 320 HB							
S2.1.1 Titanium alloys, pure titanium, Rm 400 N/mm ²							
S2.1.2 Titanium alloys, Alpha and Beta alloys, hardened, Rm 1050 N/mm ²							
H1.1.1 Hardened steel, hardened and tempered, < 55 HRC							
H1.1.2 Hardened steel, hardened and tempered, < 60 HRC							
H1.1.3 Hardened steel, hardened and tempered, > 60 HRC							
H2.1.1 Chilled cast iron, 400 HB							
H2.1.2 Chilled cast iron, hardened and tempered, < 55 HRC							

Taps ISO H



Machining group	Through-, blind holes	
	HSS-E-PM	VHM
v _c (m/min)		
P1.1.1 Unalloyed steel, annealed, 0.15 % C, Rm 420 N/mm ² , 125 HB		
P1.1.2 Unalloyed steel, heat-treated, 0.15 % C, Rm 420 N/mm ² , 125 HB		
P1.1.3 Unalloyed steel, annealed, 0.45 % C, Rm 640 N/mm ² , 190 HB		
P1.1.4 Unalloyed steel, heat-treated, 0.45 % C, Rm 640 N/mm ² , 190 HB		
P1.1.5 Unalloyed steel, heat-treated, 0.45 % C, Rm 850 N/mm ² , 250 HB		
P1.1.6 Unalloyed steel, annealed, 0.75 % C, Rm 915 N/mm ² , 270 HB		
P1.1.7 Unalloyed steel, heat-treated, 0.75 % C, Rm 1020 N/mm ² , 300 HB		
P2.1.1 Low-alloy steel, annealed, Rm 610 N/mm ² , 180 HB		
P2.1.2 Low-alloy steel, heat-treated, Rm 930 N/mm ² , 275 HB		
P2.1.3 Low-alloy steel, heat-treated, Rm 1020 N/mm ² , 300 HB		
P2.1.4 Low-alloy steel, heat-treated, Rm 1190 N/mm ² , 350 HB		
P3.1.1 High-alloy steel and tool steel, annealed, Rm 680 N/mm ² , 200 HB		
P3.1.2 High-alloy steel and tool steel, hardened and tempered, Rm 1100 N/mm ² , 325 HB		
M1.1.1 Stainless steel, ferritic/martensitic, with machining additives		
M1.1.2 Stainless steel, ferritic/martensitic, annealed, Rm 680 N/mm ² , 200 HB		
M1.1.3 Stainless steel, ferritic/martensitic, heat-treated, Rm 810 N/mm ² , 240 HB		
M2.1.1 Stainless steel, austenitic, quenched, 180 HB		
M2.2.1 Duplex steel, high-strength stainless steels		
K1.1.1 Grey cast iron, pearlitic/ferritic, 180 HB		
K1.1.2 Grey cast iron, pearlitic/martensitic, 260 HB		
K1.2.1 Cast iron with spheroidal graphite, ferritic, 160 HB		
K1.2.2 Cast iron with spheroidal graphite, pearlitic, 250 HB		
K1.3.1 Malleable cast iron, ferritic, 130 HB		
K1.3.2 Malleable cast iron, pearlitic, 230 HB		
K2.1.1 Vermicular graphite cast iron (GJV)		
K2.2.1 Austenitic-ferritic spheroidal graphite cast iron (ADI)		
N1.1.1 Wrought aluminium alloys, non-hardened, 60 HB		
N1.1.2 Wrought aluminium alloys, hardened, 100 HB		
N2.1.1 Aluminium casting alloys, non-hardened, ≤ 12 % Si, 75 HB		
N2.1.2 Aluminium casting alloys, hardened, ≤ 12 % Si, 90 HB		
N2.1.3 Aluminium casting alloys, non-hardened, > 12 % Si, 130 HB		
N3.1.1 Copper and copper alloys: Free-machining alloy, Pb > 1 %		
N3.1.2 Copper and copper alloys: CuZn, CuSnZn		
N3.1.3 Copper and copper alloys: CuSn, lead-free copper and copper electrolyte		
N4.1.1 Non-metallic materials: Duroplastics, fibre-reinforced plastics		
N4.1.2 Non-metallic materials: Hard rubber, wood, etc.		
N4.1.3 Non-metallic materials: Graphite		
S1.1.1 Heat-resistant alloys, Fe-based, annealed, 200 HB		
S1.1.2 Heat-resistant alloys, Fe-based, hardened, 280 HB		
S1.1.3 Heat-resistant alloys, Ni- or Co-based, annealed, 250 HB		
S1.1.4 Heat-resistant alloys, Ni- or Co-based, hardened, 350 HB		
S1.1.5 Heat-resistant alloys, Ni- or Co-based, cast, 320 HB		
S2.1.1 Titanium alloys, pure titanium, Rm 400 N/mm ²		
S2.1.2 Titanium alloys, Alpha and Beta alloys, hardened, Rm 1050 N/mm ²		
H1.1.1 Hardened steel, hardened and tempered, < 55 HRC	4	
H1.1.2 Hardened steel, hardened and tempered, < 60 HRC		2
H1.1.3 Hardened steel, hardened and tempered, > 60 HRC		2
H2.1.1 Chilled cast iron, 400 HB	18	35
H2.1.2 Chilled cast iron, hardened and tempered, < 55 HRC	4	8



Taps ISO S Nickel



Cutting data

Machining group	Blind holes	Through-holes	
	HSS-E-PM	HSS-E-PM	
	F	C	F
	v _c (m/min)		
P1.1.1 Unalloyed steel, annealed, 0.15 % C, Rm 420 N/mm ² , 125 HB			
P1.1.2 Unalloyed steel, heat-treated, 0.15 % C, Rm 420 N/mm ² , 125 HB			
P1.1.3 Unalloyed steel, annealed, 0.45 % C, Rm 640 N/mm ² , 190 HB			
P1.1.4 Unalloyed steel, heat-treated, 0.45 % C, Rm 640 N/mm ² , 190 HB			
P1.1.5 Unalloyed steel, heat-treated, 0.45 % C, Rm 850 N/mm ² , 250 HB			
P1.1.6 Unalloyed steel, annealed, 0.75 % C, Rm 915 N/mm ² , 270 HB			
P1.1.7 Unalloyed steel, heat-treated, 0.75 % C, Rm 1020 N/mm ² , 300 HB			
P2.1.1 Low-alloy steel, annealed, Rm 610 N/mm ² , 180 HB			
P2.1.2 Low-alloy steel, heat-treated, Rm 930 N/mm ² , 275 HB			
P2.1.3 Low-alloy steel, heat-treated, Rm 1020 N/mm ² , 300 HB			
P2.1.4 Low-alloy steel, heat-treated, Rm 1190 N/mm ² , 350 HB			
P3.1.1 High-alloy steel and tool steel, annealed, Rm 680 N/mm ² , 200 HB			
P3.1.2 High-alloy steel and tool steel, hardened and tempered, Rm 1100 N/mm ² , 325 HB			
M1.1.1 Stainless steel, ferritic/martensitic, with machining additives			
M1.1.2 Stainless steel, ferritic/martensitic, annealed, Rm 680 N/mm ² , 200 HB			
M1.1.3 Stainless steel, ferritic/martensitic, heat-treated, Rm 810 N/mm ² , 240 HB			
M2.1.1 Stainless steel, austenitic, quenched, 180 HB			
M2.2.1 Duplex steel, high-strength stainless steels			
K1.1.1 Grey cast iron, pearlitic/ferritic, 180 HB			
K1.1.2 Grey cast iron, pearlitic/martensitic, 260 HB			
K1.2.1 Cast iron with spheroidal graphite, ferritic, 160 HB			
K1.2.2 Cast iron with spheroidal graphite, pearlitic, 250 HB			
K1.3.1 Malleable cast iron, ferritic, 130 HB			
K1.3.2 Malleable cast iron, pearlitic, 230 HB			
K2.1.1 Vermicular graphite cast iron (GJV)			
K2.2.1 Austenitic-ferritic spheroidal graphite cast iron (ADI)			
N1.1.1 Wrought aluminium alloys, non-hardened, 60 HB			
N1.1.2 Wrought aluminium alloys, hardened, 100 HB			
N2.1.1 Aluminium casting alloys, non-hardened, ≤ 12 % Si, 75 HB			
N2.1.2 Aluminium casting alloys, hardened, ≤ 12 % Si, 90 HB			
N2.1.3 Aluminium casting alloys, non-hardened, > 12 % Si, 130 HB			
N3.1.1 Copper and copper alloys: Free-machining alloy, Pb > 1 %			
N3.1.2 Copper and copper alloys: CuZn, CuSnZn			
N3.1.3 Copper and copper alloys: CuSn, lead-free copper and copper electrolyte			
N4.1.1 Non-metallic materials: Duroplastics, fibre-reinforced plastics			
N4.1.2 Non-metallic materials: Hard rubber, wood, etc.			
N4.1.3 Non-metallic materials: Graphite			
S1.1.1 Heat-resistant alloys, Fe-based, annealed, 200 HB	2	2	2
S1.1.2 Heat-resistant alloys, Fe-based, hardened, 280 HB	2	2	2
S1.1.3 Heat-resistant alloys, Ni- or Co-based, annealed, 250 HB	2	2	2
S1.1.4 Heat-resistant alloys, Ni- or Co-based, hardened, 350 HB	2	2	2
S1.1.5 Heat-resistant alloys, Ni- or Co-based, cast, 320 HB	2	2	2
S2.1.1 Titanium alloys, pure titanium, Rm 400 N/mm ²			
S2.1.2 Titanium alloys, Alpha and Beta alloys, hardened, Rm 1050 N/mm ²			
H1.1.1 Hardened steel, hardened and tempered, < 55 HRC			
H1.1.2 Hardened steel, hardened and tempered, < 60 HRC			
H1.1.3 Hardened steel, hardened and tempered, > 60 HRC			
H2.1.1 Chilled cast iron, 400 HB			
H2.1.2 Chilled cast iron, hardened and tempered, < 55 HRC			

Taps ISO S Titanium



Machining group	Blind holes	Through-holes
	HSS-E-PM	HSS-E-PM
v_c (m/min)		
P1.1.1 Unalloyed steel, annealed, 0.15 % C, Rm 420 N/mm ² , 125 HB		
P1.1.2 Unalloyed steel, heat-treated, 0.15 % C, Rm 420 N/mm ² , 125 HB		
P1.1.3 Unalloyed steel, annealed, 0.45 % C, Rm 640 N/mm ² , 190 HB		
P1.1.4 Unalloyed steel, heat-treated, 0.45 % C, Rm 640 N/mm ² , 190 HB		
P1.1.5 Unalloyed steel, heat-treated, 0.45 % C, Rm 850 N/mm ² , 250 HB		
P1.1.6 Unalloyed steel, annealed, 0.75 % C, Rm 915 N/mm ² , 270 HB		
P1.1.7 Unalloyed steel, heat-treated, 0.75 % C, Rm 1020 N/mm ² , 300 HB		
P2.1.1 Low-alloy steel, annealed, Rm 610 N/mm ² , 180 HB		
P2.1.2 Low-alloy steel, heat-treated, Rm 930 N/mm ² , 275 HB		
P2.1.3 Low-alloy steel, heat-treated, Rm 1020 N/mm ² , 300 HB		
P2.1.4 Low-alloy steel, heat-treated, Rm 1190 N/mm ² , 350 HB		
P3.1.1 High-alloy steel and tool steel, annealed, Rm 680 N/mm ² , 200 HB		
P3.1.2 High-alloy steel and tool steel, hardened and tempered, Rm 1100 N/mm ² , 325 HB		
M1.1.1 Stainless steel, ferritic/martensitic, with machining additives		
M1.1.2 Stainless steel, ferritic/martensitic, annealed, Rm 680 N/mm ² , 200 HB		
M1.1.3 Stainless steel, ferritic/martensitic, heat-treated, Rm 810 N/mm ² , 240 HB		
M2.1.1 Stainless steel, austenitic, quenched, 180 HB		
M2.2.1 Duplex steel, high-strength stainless steels		
K1.1.1 Grey cast iron, pearlitic/ferritic, 180 HB		
K1.1.2 Grey cast iron, pearlitic/martensitic, 260 HB		
K1.2.1 Cast iron with spheroidal graphite, ferritic, 160 HB		
K1.2.2 Cast iron with spheroidal graphite, pearlitic, 250 HB		
K1.3.1 Malleable cast iron, ferritic, 130 HB		
K1.3.2 Malleable cast iron, pearlitic, 230 HB		
K2.1.1 Vermicular graphite cast iron (GJV)		
K2.2.1 Austenitic-ferritic spheroidal graphite cast iron (ADI)		
N1.1.1 Wrought aluminium alloys, non-hardened, 60 HB		
N1.1.2 Wrought aluminium alloys, hardened, 100 HB		
N2.1.1 Aluminium casting alloys, non-hardened, ≤ 12 % Si, 75 HB		
N2.1.2 Aluminium casting alloys, hardened, ≤ 12 % Si, 90 HB		
N2.1.3 Aluminium casting alloys, non-hardened, > 12 % Si, 130 HB		
N3.1.1 Copper and copper alloys: Free-machining alloy, Pb > 1 %		
N3.1.2 Copper and copper alloys: CuZn, CuSnZn		
N3.1.3 Copper and copper alloys: CuSn, lead-free copper and copper electrolyte		
N4.1.1 Non-metallic materials: Duroplastics, fibre-reinforced plastics		
N4.1.2 Non-metallic materials: Hard rubber, wood, etc.		
N4.1.3 Non-metallic materials: Graphite		
S1.1.1 Heat-resistant alloys, Fe-based, annealed, 200 HB		
S1.1.2 Heat-resistant alloys, Fe-based, hardened, 280 HB		
S1.1.3 Heat-resistant alloys, Ni- or Co-based, annealed, 250 HB		
S1.1.4 Heat-resistant alloys, Ni- or Co-based, hardened, 350 HB		
S1.1.5 Heat-resistant alloys, Ni- or Co-based, cast, 320 HB		
S2.1.1 Titanium alloys, pure titanium, Rm 400 N/mm ²	2	3
S2.1.2 Titanium alloys, Alpha and Beta alloys, hardened, Rm 1050 N/mm ²	2	3
H1.1.1 Hardened steel, hardened and tempered, < 55 HRC		
H1.1.2 Hardened steel, hardened and tempered, < 60 HRC		
H1.1.3 Hardened steel, hardened and tempered, > 60 HRC		
H2.1.1 Chilled cast iron, 400 HB		
H2.1.2 Chilled cast iron, hardened and tempered, < 55 HRC		



Fluteless taps



Cutting data

Machining group	HSS-E				HSS-E-PM	VHM		
	S	C	P	S	S	S	C	Cb
	v _c (m/min)							
P1.1.1 Unalloyed steel, annealed, 0.15 % C, Rm 420 N/mm ² , 125 HB	17	17	18		22	42	42	
P1.1.2 Unalloyed steel, heat-treated, 0.15 % C, Rm 420 N/mm ² , 125 HB	17	17	18		22	42	42	
P1.1.3 Unalloyed steel, annealed, 0.45 % C, Rm 640 N/mm ² , 190 HB	17	17	18		22	42	42	
P1.1.4 Unalloyed steel, heat-treated, 0.45 % C, Rm 640 N/mm ² , 190 HB	17	17	18		22	42	42	
P1.1.5 Unalloyed steel, heat-treated, 0.45 % C, Rm 850 N/mm ² , 250 HB	17	17	18		22	42	42	
P1.1.6 Unalloyed steel, annealed, 0.75 % C, Rm 915 N/mm ² , 270 HB	17	17	18		22	42	42	
P1.1.7 Unalloyed steel, heat-treated, 0.75 % C, Rm 1020 N/mm ² , 300 HB	17	17	18		22	42	42	
P2.1.1 Low-alloy steel, annealed, Rm 610 N/mm ² , 180 HB	13	13	14		17	34	34	
P2.1.2 Low-alloy steel, heat-treated, Rm 930 N/mm ² , 275 HB	13	13	14		17	34	34	
P2.1.3 Low-alloy steel, heat-treated, Rm 1020 N/mm ² , 300 HB	13	13	14		17	34	34	
P2.1.4 Low-alloy steel, heat-treated, Rm 1190 N/mm ² , 350 HB	13	13	14		17	34	34	
P3.1.1 High-alloy steel and tool steel, annealed, Rm 680 N/mm ² , 200 HB	10	10	11		13	25	25	
P3.1.2 High-alloy steel and tool steel, hardened and tempered, Rm 1100 N/mm ² , 325 HB	10	10	11		13	25	25	
M1.1.1 Stainless steel, ferritic/martensitic, with machining additives	7	7			9			
M1.1.2 Stainless steel, ferritic/martensitic, annealed, Rm 680 N/mm ² , 200 HB	7	7			9			
M1.1.3 Stainless steel, ferritic/martensitic, heat-treated, Rm 810 N/mm ² , 240 HB	5	5			7			
M2.1.1 Stainless steel, austenitic, quenched, 180 HB	4	4			5			
M2.2.1 Duplex steel, high-strength stainless steels								
K1.1.1 Grey cast iron, pearlitic/ferritic, 180 HB								
K1.1.2 Grey cast iron, pearlitic/martensitic, 260 HB								
K1.2.1 Cast iron with spheroidal graphite, ferritic, 160 HB	17	17			22	42	42	
K1.2.2 Cast iron with spheroidal graphite, pearlitic, 250 HB	17	17			22	42	42	
K1.3.1 Malleable cast iron, ferritic, 130 HB	17	17			22	42	42	
K1.3.2 Malleable cast iron, pearlitic, 230 HB	17	17			22	42	42	
K2.1.1 Vermicular graphite cast iron (GJV)	13	13			17	34	34	
K2.2.1 Austenitic-ferritic spheroidal graphite cast iron (ADI)	13	13			17	34	34	
N1.1.1 Wrought aluminium alloys, non-hardened, 60 HB		20		27				
N1.1.2 Wrought aluminium alloys, hardened, 100 HB		20		27				
N2.1.1 Aluminium casting alloys, non-hardened, ≤ 12 % Si, 75 HB	20	20		27	26	50	50	68
N2.1.2 Aluminium casting alloys, hardened, ≤ 12 % Si, 90 HB	20	20		27	26	50	50	68
N2.1.3 Aluminium casting alloys, non-hardened, > 12 % Si, 130 HB	17	17		23	22	42	42	57
N3.1.1 Copper and copper alloys: Free-machining alloy, Pb > 1 %								
N3.1.2 Copper and copper alloys: CuZn, CuSnZn				27				
N3.1.3 Copper and copper alloys: CuSn, lead-free copper and copper electrolyte				27				
N4.1.1 Non-metallic materials: Duroplastics, fibre-reinforced plastics								
N4.1.2 Non-metallic materials: Hard rubber, wood, etc.								
N4.1.3 Non-metallic materials: Graphite								
S1.1.1 Heat-resistant alloys, Fe-based, annealed, 200 HB	2	2			3			
S1.1.2 Heat-resistant alloys, Fe-based, hardened, 280 HB	2	2			3			
S1.1.3 Heat-resistant alloys, Ni- or Co-based, annealed, 250 HB	2	2			3			
S1.1.4 Heat-resistant alloys, Ni- or Co-based, hardened, 350 HB	2	2			3			
S1.1.5 Heat-resistant alloys, Ni- or Co-based, cast, 320 HB	2	2			3			
S2.1.1 Titanium alloys, pure titanium, Rm 400 N/mm ²	2	2		3	3			
S2.1.2 Titanium alloys, Alpha and Beta alloys, hardened, Rm 1050 N/mm ²	2	2		3	3			
H1.1.1 Hardened steel, hardened and tempered, < 55 HRC								
H1.1.2 Hardened steel, hardened and tempered, < 60 HRC								
H1.1.3 Hardened steel, hardened and tempered, > 60 HRC								
H2.1.1 Chilled cast iron, 400 HB								
H2.1.2 Chilled cast iron, hardened and tempered, < 55 HRC								



SC-Line Thread milling cutters SC-TMC



Machining group	v _c (m/min)	f _z (mm/z) with milling part-Ø (d1)										
		2	3	4	5	6	7	8	9	10	12	14
P1.1.1 Unalloyed steel, annealed, 0.15 % C, Rm 420 N/mm ² , 125 HB	100	0.010	0.015	0.020	0.020	0.020	0.025	0.025	0.030	0.030	0.035	0.035
P1.1.2 Unalloyed steel, heat-treated, 0.15 % C, Rm 420 N/mm ² , 125 HB	100	0.010	0.015	0.020	0.020	0.020	0.025	0.025	0.030	0.030	0.035	0.035
P1.1.3 Unalloyed steel, annealed, 0.45 % C, Rm 640 N/mm ² , 190 HB	100	0.010	0.015	0.020	0.020	0.020	0.025	0.025	0.030	0.030	0.035	0.035
P1.1.4 Unalloyed steel, heat-treated, 0.45 % C, Rm 640 N/mm ² , 190 HB	100	0.010	0.015	0.020	0.020	0.020	0.025	0.025	0.030	0.030	0.035	0.035
P1.1.5 Unalloyed steel, heat-treated, 0.45 % C, Rm 850 N/mm ² , 250 HB	100	0.010	0.015	0.020	0.020	0.020	0.025	0.025	0.030	0.030	0.035	0.035
P1.1.6 Unalloyed steel, annealed, 0.75 % C, Rm 915 N/mm ² , 270 HB	100	0.010	0.015	0.020	0.020	0.020	0.025	0.025	0.030	0.030	0.035	0.035
P1.1.7 Unalloyed steel, heat-treated, 0.75 % C, Rm 1020 N/mm ² , 300 HB	100	0.010	0.015	0.020	0.020	0.020	0.025	0.025	0.030	0.030	0.035	0.035
P2.1.1 Low-alloy steel, annealed, Rm 610 N/mm ² , 180 HB	90	0.010	0.015	0.020	0.020	0.020	0.025	0.025	0.030	0.030	0.035	0.035
P2.1.2 Low-alloy steel, heat-treated, Rm 930 N/mm ² , 275 HB	90	0.010	0.015	0.020	0.020	0.020	0.025	0.025	0.030	0.030	0.035	0.035
P2.1.3 Low-alloy steel, heat-treated, Rm 1020 N/mm ² , 300 HB	90	0.010	0.015	0.020	0.020	0.020	0.025	0.025	0.030	0.030	0.035	0.035
P2.1.4 Low-alloy steel, heat-treated, Rm 1190 N/mm ² , 350 HB	90	0.010	0.015	0.020	0.020	0.020	0.025	0.025	0.030	0.030	0.035	0.035
P3.1.1 High-alloy steel and tool steel, annealed, Rm 680 N/mm ² , 200 HB	80	0.010	0.015	0.020	0.020	0.020	0.025	0.025	0.030	0.030	0.035	0.035
P3.1.2 High-alloy steel and tool steel, hardened and tempered, Rm 1100 N/mm ² , 325 HB	80	0.010	0.015	0.020	0.020	0.020	0.025	0.025	0.030	0.030	0.035	0.035
M1.1.1 Stainless steel, ferritic/martensitic, with machining additives	60	0.010	0.010	0.015	0.015	0.020	0.020	0.020	0.025	0.025	0.030	0.030
M1.1.2 Stainless steel, ferritic/martensitic, annealed, Rm 680 N/mm ² , 200 HB	60	0.010	0.010	0.015	0.015	0.020	0.020	0.020	0.025	0.025	0.030	0.030
M1.1.3 Stainless steel, ferritic/martensitic, heat-treated, Rm 810 N/mm ² , 240 HB	60	0.010	0.010	0.015	0.015	0.020	0.020	0.020	0.025	0.025	0.030	0.030
M2.1.1 Stainless steel, austenitic, quenched, 180 HB	55	0.010	0.010	0.015	0.015	0.020	0.020	0.020	0.025	0.025	0.030	0.030
M2.2.1 Duplex steel, high-strength stainless steels	50	0.010	0.010	0.015	0.015	0.020	0.020	0.020	0.025	0.025	0.030	0.030
K1.1.1 Grey cast iron, pearlitic/ferritic, 180 HB	120	0.010	0.015	0.020	0.020	0.020	0.025	0.025	0.030	0.030	0.035	0.035
K1.1.2 Grey cast iron, pearlitic/martensitic, 260 HB	120	0.010	0.015	0.020	0.020	0.020	0.025	0.025	0.030	0.030	0.035	0.035
K1.2.1 Cast iron with spheroidal graphite, ferritic, 160 HB	100	0.010	0.015	0.020	0.020	0.020	0.025	0.025	0.030	0.030	0.035	0.035
K1.2.2 Cast iron with spheroidal graphite, pearlitic, 250 HB	100	0.010	0.015	0.020	0.020	0.020	0.025	0.025	0.030	0.030	0.035	0.035
K1.3.1 Malleable cast iron, ferritic, 130 HB	100	0.010	0.015	0.020	0.020	0.020	0.025	0.025	0.030	0.030	0.035	0.035
K1.3.2 Malleable cast iron, pearlitic, 230 HB	100	0.010	0.015	0.020	0.020	0.020	0.025	0.025	0.030	0.030	0.035	0.035
K2.1.1 Vermicular graphite cast iron (GJV)	90	0.010	0.015	0.020	0.020	0.020	0.025	0.025	0.030	0.030	0.035	0.035
K2.2.1 Austenitic-ferritic spheroidal graphite cast iron (ADI)	90	0.010	0.015	0.020	0.020	0.020	0.025	0.025	0.030	0.030	0.035	0.035
N1.1.1 Wrought aluminium alloys, non-hardened, 60 HB												
N1.1.2 Wrought aluminium alloys, hardened, 100 HB												
N2.1.1 Aluminium casting alloys, non-hardened, ≤ 12 % Si, 75 HB												
N2.1.2 Aluminium casting alloys, hardened, ≤ 12 % Si, 90 HB												
N2.1.3 Aluminium casting alloys, non-hardened, > 12 % Si, 130 HB												
N3.1.1 Copper and copper alloys: Free-machining alloy, Pb > 1 %	90	0.010	0.015	0.020	0.020	0.020	0.025	0.025	0.030	0.030	0.035	0.035
N3.1.2 Copper and copper alloys: CuZn, CuSnZn	90	0.010	0.015	0.020	0.020	0.020	0.025	0.025	0.030	0.030	0.035	0.035
N3.1.3 Copper and copper alloys: CuSn, lead-free copper and copper electrolyte	70	0.010	0.015	0.015	0.015	0.020	0.020	0.020	0.025	0.025	0.030	0.030
N4.1.1 Non-metallic materials: Duroplastics, fibre-reinforced plastics												
N4.1.2 Non-metallic materials: Hard rubber, wood, etc.												
N4.1.3 Non-metallic materials: Graphite												
S1.1.1 Heat-resistant alloys, Fe-based, annealed, 200 HB	55	0.010	0.010	0.015	0.015	0.020	0.020	0.020	0.025	0.025	0.030	0.030
S1.1.2 Heat-resistant alloys, Fe-based, hardened, 280 HB	55	0.010	0.010	0.015	0.015	0.020	0.020	0.020	0.025	0.025	0.030	0.030
S1.1.3 Heat-resistant alloys, Ni- or Co-based, annealed, 250 HB	55	0.010	0.010	0.015	0.015	0.020	0.020	0.020	0.025	0.025	0.030	0.030
S1.1.4 Heat-resistant alloys, Ni- or Co-based, hardened, 350 HB	55	0.010	0.010	0.015	0.015	0.020	0.020	0.020	0.025	0.025	0.030	0.030
S1.1.5 Heat-resistant alloys, Ni- or Co-based, cast, 320 HB	55	0.010	0.010	0.015	0.015	0.020	0.020	0.020	0.025	0.025	0.030	0.030
S2.1.1 Titanium alloys, pure titanium, Rm 400 N/mm ²	45	0.010	0.010	0.015	0.015	0.020	0.020	0.020	0.025	0.025	0.030	0.030
S2.1.2 Titanium alloys, Alpha and Beta alloys, hardened, Rm 1050 N/mm ²	45	0.010	0.010	0.015	0.015	0.020	0.020	0.020	0.025	0.025	0.030	0.030
H1.1.1 Hardened steel, hardened and tempered, < 55 HRC												
H1.1.2 Hardened steel, hardened and tempered, < 60 HRC												
H1.1.3 Hardened steel, hardened and tempered, > 60 HRC												
H2.1.1 Chilled cast iron, 400 HB												
H2.1.2 Chilled cast iron, hardened and tempered, < 55 HRC												

Cutting data



SC-Line Thread milling cutters SC-MTM3



Cutting data

Machining group	v _c (m/min)	f _z (mm/z) with milling part-Ø (d1)										
		1	2	3	4	5	6	8	10	12	14	16
P1.1.1 Unalloyed steel, annealed, 0.15 % C, Rm 420 N/mm ² , 125 HB	100	0.010	0.015	0.020	0.020	0.025	0.030	0.035	0.040	0.045	0.050	0.055
P1.1.2 Unalloyed steel, heat-treated, 0.15 % C, Rm 420 N/mm ² , 125 HB	100	0.010	0.015	0.020	0.020	0.025	0.030	0.035	0.040	0.045	0.050	0.055
P1.1.3 Unalloyed steel, annealed, 0.45 % C, Rm 640 N/mm ² , 190 HB	100	0.010	0.015	0.020	0.020	0.025	0.030	0.035	0.040	0.045	0.050	0.055
P1.1.4 Unalloyed steel, heat-treated, 0.45 % C, Rm 640 N/mm ² , 190 HB	100	0.010	0.015	0.020	0.020	0.025	0.030	0.035	0.040	0.045	0.050	0.055
P1.1.5 Unalloyed steel, heat-treated, 0.45 % C, Rm 850 N/mm ² , 250 HB	100	0.010	0.015	0.020	0.020	0.025	0.030	0.035	0.040	0.045	0.050	0.055
P1.1.6 Unalloyed steel, annealed, 0.75 % C, Rm 915 N/mm ² , 270 HB	100	0.010	0.015	0.020	0.020	0.025	0.030	0.035	0.040	0.045	0.050	0.055
P1.1.7 Unalloyed steel, heat-treated, 0.75 % C, Rm 1020 N/mm ² , 300 HB	100	0.010	0.015	0.020	0.020	0.025	0.030	0.035	0.040	0.045	0.050	0.055
P2.1.1 Low-alloy steel, annealed, Rm 610 N/mm ² , 180 HB	90	0.010	0.015	0.020	0.020	0.025	0.030	0.035	0.040	0.045	0.050	0.055
P2.1.2 Low-alloy steel, heat-treated, Rm 930 N/mm ² , 275 HB	90	0.010	0.015	0.020	0.020	0.025	0.030	0.035	0.040	0.045	0.050	0.055
P2.1.3 Low-alloy steel, heat-treated, Rm 1020 N/mm ² , 300 HB	90	0.010	0.015	0.020	0.020	0.025	0.030	0.035	0.040	0.045	0.050	0.055
P2.1.4 Low-alloy steel, heat-treated, Rm 1190 N/mm ² , 350 HB	90	0.010	0.015	0.020	0.020	0.025	0.030	0.035	0.040	0.045	0.050	0.055
P3.1.1 High-alloy steel and tool steel, annealed, Rm 680 N/mm ² , 200 HB	80	0.010	0.015	0.020	0.020	0.025	0.030	0.035	0.040	0.045	0.050	0.055
P3.1.2 High-alloy steel and tool steel, hardened and tempered, Rm 1100 N/mm ² , 325 HB	80	0.010	0.015	0.020	0.020	0.025	0.030	0.035	0.040	0.045	0.050	0.055
M1.1.1 Stainless steel, ferritic/martensitic, with machining additives	65	0.010	0.015	0.020	0.020	0.025	0.030	0.035	0.040	0.045	0.050	0.055
M1.1.2 Stainless steel, ferritic/martensitic, annealed, Rm 680 N/mm ² , 200 HB	65	0.010	0.015	0.020	0.020	0.025	0.030	0.035	0.040	0.045	0.050	0.055
M1.1.3 Stainless steel, ferritic/martensitic, heat-treated, Rm 810 N/mm ² , 240 HB	65	0.010	0.015	0.020	0.020	0.025	0.030	0.035	0.040	0.045	0.050	0.055
M2.1.1 Stainless steel, austenitic, quenched, 180 HB	60	0.010	0.015	0.020	0.020	0.025	0.030	0.035	0.040	0.045	0.050	0.055
M2.2.1 Duplex steel, high-strength stainless steels	55	0.010	0.015	0.020	0.020	0.025	0.030	0.035	0.040	0.045	0.050	0.055
K1.1.1 Grey cast iron, pearlitic/ferritic, 180 HB	140	0.010	0.015	0.020	0.025	0.030	0.035	0.040	0.045	0.055	0.060	0.065
K1.1.2 Grey cast iron, pearlitic/martensitic, 260 HB	140	0.010	0.015	0.020	0.025	0.030	0.035	0.040	0.045	0.055	0.060	0.065
K1.2.1 Cast iron with spheroidal graphite, ferritic, 160 HB	115	0.010	0.015	0.020	0.025	0.030	0.035	0.040	0.045	0.055	0.060	0.065
K1.2.2 Cast iron with spheroidal graphite, pearlitic, 250 HB	115	0.010	0.015	0.020	0.025	0.030	0.035	0.040	0.045	0.055	0.060	0.065
K1.3.1 Malleable cast iron, ferritic, 130 HB	115	0.010	0.015	0.020	0.025	0.030	0.035	0.040	0.045	0.055	0.060	0.065
K1.3.2 Malleable cast iron, pearlitic, 230 HB	115	0.010	0.015	0.020	0.025	0.030	0.035	0.040	0.045	0.055	0.060	0.065
K2.1.1 Vermicular graphite cast iron (GJV)	100	0.010	0.015	0.020	0.025	0.030	0.035	0.040	0.045	0.055	0.060	0.065
K2.2.1 Austenitic-ferritic spheroidal graphite cast iron (ADI)	100	0.010	0.015	0.020	0.025	0.030	0.035	0.040	0.045	0.055	0.060	0.065
N1.1.1 Wrought aluminium alloys, non-hardened, 60 HB	280	0.010	0.015	0.020	0.025	0.030	0.035	0.045	0.050	0.060	0.065	0.070
N1.1.2 Wrought aluminium alloys, hardened, 100 HB	280	0.010	0.015	0.020	0.025	0.030	0.035	0.045	0.050	0.060	0.065	0.070
N2.1.1 Aluminium casting alloys, non-hardened, ≤ 12 % Si, 75 HB	250	0.010	0.015	0.020	0.025	0.030	0.035	0.045	0.050	0.060	0.065	0.070
N2.1.2 Aluminium casting alloys, hardened, ≤ 12 % Si, 90 HB	250	0.010	0.015	0.020	0.025	0.030	0.035	0.045	0.050	0.060	0.065	0.070
N2.1.3 Aluminium casting alloys, non-hardened, > 12 % Si, 130 HB	250	0.010	0.015	0.020	0.025	0.030	0.035	0.045	0.050	0.060	0.065	0.070
N3.1.1 Copper and copper alloys: Free-machining alloy, Pb > 1 %	140	0.010	0.015	0.020	0.025	0.030	0.035	0.045	0.050	0.060	0.065	0.070
N3.1.2 Copper and copper alloys: CuZn, CuSnZn	140	0.010	0.015	0.020	0.025	0.030	0.035	0.045	0.050	0.060	0.065	0.070
N3.1.3 Copper and copper alloys: CuSn, lead-free copper and copper electrolyte	110	0.010	0.015	0.020	0.025	0.025	0.030	0.040	0.045	0.050	0.055	0.060
N4.1.1 Non-metallic materials: Duroplastics, fibre-reinforced plastics	300	0.010	0.015	0.020	0.025	0.030	0.035	0.045	0.050	0.060	0.065	0.070
N4.1.2 Non-metallic materials: Hard rubber, wood, etc.	300	0.010	0.015	0.020	0.025	0.030	0.035	0.045	0.050	0.060	0.065	0.070
N4.1.3 Non-metallic materials: Graphite	300	0.010	0.015	0.020	0.025	0.030	0.035	0.045	0.050	0.060	0.065	0.070
S1.1.1 Heat-resistant alloys, Fe-based, annealed, 200 HB	55	0.005	0.010	0.015	0.020	0.020	0.025	0.030	0.035	0.040	0.045	0.050
S1.1.2 Heat-resistant alloys, Fe-based, hardened, 280 HB	55	0.005	0.010	0.015	0.020	0.020	0.025	0.030	0.035	0.040	0.045	0.050
S1.1.3 Heat-resistant alloys, Ni- or Co-based, annealed, 250 HB	55	0.005	0.010	0.015	0.020	0.020	0.025	0.030	0.035	0.040	0.045	0.050
S1.1.4 Heat-resistant alloys, Ni- or Co-based, hardened, 350 HB	55	0.005	0.010	0.015	0.020	0.020	0.025	0.030	0.035	0.040	0.045	0.050
S1.1.5 Heat-resistant alloys, Ni- or Co-based, cast, 320 HB	55	0.005	0.010	0.015	0.020	0.020	0.025	0.030	0.035	0.040	0.045	0.050
S2.1.1 Titanium alloys, pure titanium, Rm 400 N/mm ²	40	0.005	0.010	0.015	0.020	0.020	0.025	0.030	0.035	0.040	0.045	0.050
S2.1.2 Titanium alloys, Alpha and Beta alloys, hardened, Rm 1050 N/mm ²	40	0.005	0.010	0.015	0.020	0.020	0.025	0.030	0.035	0.040	0.045	0.050
H1.1.1 Hardened steel, hardened and tempered, < 55 HRC	50	0.005	0.010	0.015	0.015	0.020	0.020	0.025	0.030	0.035	0.040	0.045
H1.1.2 Hardened steel, hardened and tempered, < 60 HRC	50	0.005	0.010	0.015	0.015	0.020	0.020	0.025	0.030	0.035	0.040	0.045
H1.1.3 Hardened steel, hardened and tempered, > 60 HRC	50	0.005	0.010	0.015	0.015	0.020	0.020	0.025	0.030	0.035	0.040	0.045
H2.1.1 Chilled cast iron, 400 HB												
H2.1.2 Chilled cast iron, hardened and tempered, < 55 HRC												

Circular thread milling cutters MTMH3-Z



Machining group	v _c (m/min)	f _z (mm/z) with milling part-Ø (d1)										
		1	2	3	4	5	6	7	8	10	14	16
P1.1.1 Unalloyed steel, annealed, 0.15 % C, Rm 420 N/mm ² , 125 HB	80	0.005	0.010	0.015	0.020	0.025	0.025	0.030	0.035	0.050	0.050	0.050
P1.1.2 Unalloyed steel, heat-treated, 0.15 % C, Rm 420 N/mm ² , 125 HB	80	0.005	0.010	0.015	0.020	0.025	0.025	0.030	0.035	0.050	0.050	0.050
P1.1.3 Unalloyed steel, annealed, 0.45 % C, Rm 640 N/mm ² , 190 HB	80	0.005	0.010	0.015	0.020	0.025	0.025	0.030	0.035	0.050	0.050	0.050
P1.1.4 Unalloyed steel, heat-treated, 0.45 % C, Rm 640 N/mm ² , 190 HB	80	0.005	0.010	0.015	0.020	0.025	0.025	0.030	0.035	0.050	0.050	0.050
P1.1.5 Unalloyed steel, heat-treated, 0.45 % C, Rm 850 N/mm ² , 250 HB	80	0.005	0.010	0.015	0.020	0.025	0.025	0.030	0.035	0.050	0.050	0.050
P1.1.6 Unalloyed steel, annealed, 0.75 % C, Rm 915 N/mm ² , 270 HB	80	0.005	0.010	0.015	0.020	0.025	0.025	0.030	0.035	0.050	0.050	0.050
P1.1.7 Unalloyed steel, heat-treated, 0.75 % C, Rm 1020 N/mm ² , 300 HB	80	0.005	0.010	0.015	0.020	0.025	0.025	0.030	0.035	0.050	0.050	0.050
P2.1.1 Low-alloy steel, annealed, Rm 610 N/mm ² , 180 HB	70	0.005	0.010	0.015	0.020	0.025	0.025	0.030	0.035	0.050	0.050	0.050
P2.1.2 Low-alloy steel, heat-treated, Rm 930 N/mm ² , 275 HB	70	0.005	0.010	0.015	0.020	0.025	0.025	0.030	0.035	0.050	0.050	0.050
P2.1.3 Low-alloy steel, heat-treated, Rm 1020 N/mm ² , 300 HB	70	0.005	0.010	0.015	0.020	0.025	0.025	0.030	0.035	0.050	0.050	0.050
P2.1.4 Low-alloy steel, heat-treated, Rm 1190 N/mm ² , 350 HB	70	0.005	0.010	0.015	0.020	0.025	0.025	0.030	0.035	0.050	0.050	0.050
P3.1.1 High-alloy steel and tool steel, annealed, Rm 680 N/mm ² , 200 HB	70	0.005	0.010	0.015	0.020	0.020	0.025	0.025	0.030	0.045	0.045	0.045
P3.1.2 High-alloy steel and tool steel, hardened and tempered, Rm 1100 N/mm ² , 325 HB	70	0.005	0.010	0.015	0.020	0.020	0.025	0.025	0.030	0.045	0.045	0.045
M1.1.1 Stainless steel, ferritic/martensitic, with machining additives	55	0.005	0.010	0.015	0.020	0.020	0.025	0.025	0.030	0.045	0.045	0.045
M1.1.2 Stainless steel, ferritic/martensitic, annealed, Rm 680 N/mm ² , 200 HB	55	0.005	0.010	0.015	0.020	0.020	0.025	0.025	0.030	0.045	0.045	0.045
M1.1.3 Stainless steel, ferritic/martensitic, heat-treated, Rm 810 N/mm ² , 240 HB	55	0.005	0.010	0.015	0.020	0.020	0.025	0.025	0.030	0.045	0.045	0.045
M2.1.1 Stainless steel, austenitic, quenched, 180 HB	50	0.005	0.010	0.010	0.015	0.015	0.020	0.020	0.025	0.035	0.035	0.035
M2.2.1 Duplex steel, high-strength stainless steels	45	0.005	0.010	0.010	0.015	0.015	0.020	0.020	0.025	0.035	0.035	0.035
K1.1.1 Grey cast iron, pearlitic/ferritic, 180 HB	80	0.005	0.010	0.015	0.020	0.025	0.025	0.030	0.035	0.050	0.050	0.050
K1.1.2 Grey cast iron, pearlitic/martensitic, 260 HB	80	0.005	0.010	0.015	0.020	0.025	0.025	0.030	0.035	0.050	0.050	0.050
K1.2.1 Cast iron with spheroidal graphite, ferritic, 160 HB	65	0.005	0.010	0.015	0.020	0.025	0.025	0.030	0.035	0.050	0.050	0.050
K1.2.2 Cast iron with spheroidal graphite, pearlitic, 250 HB	65	0.005	0.010	0.015	0.020	0.025	0.025	0.030	0.035	0.050	0.050	0.050
K1.3.1 Malleable cast iron, ferritic, 130 HB	65	0.005	0.010	0.015	0.020	0.025	0.025	0.030	0.035	0.050	0.050	0.050
K1.3.2 Malleable cast iron, pearlitic, 230 HB	65	0.005	0.010	0.015	0.020	0.025	0.025	0.030	0.035	0.050	0.050	0.050
K2.1.1 Vermicular graphite cast iron (GJV)	65	0.005	0.010	0.015	0.020	0.020	0.025	0.030	0.030	0.045	0.045	0.045
K2.2.1 Austenitic-ferritic spheroidal graphite cast iron (ADI)	65	0.005	0.010	0.015	0.020	0.020	0.025	0.030	0.030	0.045	0.045	0.045
N1.1.1 Wrought aluminium alloys, non-hardened, 60 HB	150	0.005	0.010	0.015	0.020	0.020	0.025	0.030	0.030	0.045	0.045	0.045
N1.1.2 Wrought aluminium alloys, hardened, 100 HB	150	0.005	0.010	0.015	0.020	0.020	0.025	0.030	0.030	0.045	0.045	0.045
N2.1.1 Aluminium casting alloys, non-hardened, ≤ 12 % Si, 75 HB	120	0.005	0.010	0.015	0.020	0.020	0.025	0.030	0.030	0.045	0.045	0.045
N2.1.2 Aluminium casting alloys, hardened, ≤ 12 % Si, 90 HB	120	0.005	0.010	0.015	0.020	0.020	0.025	0.030	0.030	0.045	0.045	0.045
N2.1.3 Aluminium casting alloys, non-hardened, > 12 % Si, 130 HB	120	0.005	0.010	0.015	0.020	0.020	0.025	0.030	0.030	0.045	0.045	0.045
N3.1.1 Copper and copper alloys: Free-machining alloy, Pb > 1 %	80	0.005	0.010	0.015	0.020	0.025	0.025	0.030	0.035	0.050	0.050	0.050
N3.1.2 Copper and copper alloys: CuZn, CuSnZn	80	0.005	0.010	0.015	0.020	0.025	0.025	0.030	0.035	0.050	0.050	0.050
N3.1.3 Copper and copper alloys: CuSn, lead-free copper and copper electrolyte	60	0.005	0.010	0.015	0.015	0.020	0.020	0.025	0.030	0.040	0.040	0.040
N4.1.1 Non-metallic materials: Duroplastics, fibre-reinforced plastics												
N4.1.2 Non-metallic materials: Hard rubber, wood, etc.												
N4.1.3 Non-metallic materials: Graphite												
S1.1.1 Heat-resistant alloys, Fe-based, annealed, 200 HB	45	0.005	0.010	0.015	0.020	0.020	0.025	0.025	0.030	0.045	0.045	0.045
S1.1.2 Heat-resistant alloys, Fe-based, hardened, 280 HB	45	0.005	0.010	0.015	0.020	0.020	0.025	0.025	0.030	0.045	0.045	0.045
S1.1.3 Heat-resistant alloys, Ni- or Co-based, annealed, 250 HB	45	0.005	0.010	0.015	0.020	0.020	0.025	0.025	0.030	0.045	0.045	0.045
S1.1.4 Heat-resistant alloys, Ni- or Co-based, hardened, 350 HB	45	0.005	0.010	0.015	0.020	0.020	0.025	0.025	0.030	0.045	0.045	0.045
S1.1.5 Heat-resistant alloys, Ni- or Co-based, cast, 320 HB	45	0.005	0.010	0.015	0.020	0.020	0.025	0.025	0.030	0.045	0.045	0.045
S2.1.1 Titanium alloys, pure titanium, Rm 400 N/mm ²	45	0.005	0.010	0.015	0.020	0.020	0.025	0.025	0.030	0.045	0.045	0.045
S2.1.2 Titanium alloys, Alpha and Beta alloys, hardened, Rm 1050 N/mm ²	45	0.005	0.010	0.015	0.020	0.020	0.025	0.025	0.030	0.045	0.045	0.045
H1.1.1 Hardened steel, hardened and tempered, < 55 HRC	40	0.005	0.010	0.015	0.020	0.020	0.025	0.025	0.030	0.045	0.045	0.045
H1.1.2 Hardened steel, hardened and tempered, < 60 HRC	40	0.005	0.010	0.015	0.020	0.020	0.025	0.025	0.030	0.045	0.045	0.045
H1.1.3 Hardened steel, hardened and tempered, > 60 HRC	40	0.005	0.010	0.015	0.020	0.020	0.025	0.025	0.030	0.045	0.045	0.045
H2.1.1 Chilled cast iron, 400 HB	30	0.005	0.010	0.015	0.015	0.020	0.025	0.025	0.030	0.040	0.040	0.040
H2.1.2 Chilled cast iron, hardened and tempered, < 55 HRC	30	0.005	0.010	0.015	0.015	0.020	0.025	0.025	0.030	0.040	0.040	0.040



Thread milling cutters

Micro thread milling cutters MTM, thread milling cutters without/with chamfer TM/TMC, universal thread milling cutters TMU



Cutting data

Machining group	v_c (m/min)
P1.1.1 Unalloyed steel, annealed, 0.15 % C, Rm 420 N/mm ² , 125 HB	90
P1.1.2 Unalloyed steel, heat-treated, 0.15 % C, Rm 420 N/mm ² , 125 HB	90
P1.1.3 Unalloyed steel, annealed, 0.45 % C, Rm 640 N/mm ² , 190 HB	90
P1.1.4 Unalloyed steel, heat-treated, 0.45 % C, Rm 640 N/mm ² , 190 HB	90
P1.1.5 Unalloyed steel, heat-treated, 0.45 % C, Rm 850 N/mm ² , 250 HB	90
P1.1.6 Unalloyed steel, annealed, 0.75 % C, Rm 915 N/mm ² , 270 HB	90
P1.1.7 Unalloyed steel, heat-treated, 0.75 % C, Rm 1020 N/mm ² , 300 HB	90
P2.1.1 Low-alloy steel, annealed, Rm 610 N/mm ² , 180 HB	80
P2.1.2 Low-alloy steel, heat-treated, Rm 930 N/mm ² , 275 HB	80
P2.1.3 Low-alloy steel, heat-treated, Rm 1020 N/mm ² , 300 HB	80
P2.1.4 Low-alloy steel, heat-treated, Rm 1190 N/mm ² , 350 HB	80
P3.1.1 High-alloy steel and tool steel, annealed, Rm 680 N/mm ² , 200 HB	70
P3.1.2 High-alloy steel and tool steel, hardened and tempered, Rm 1100 N/mm ² , 325 HB	70
M1.1.1 Stainless steel, ferritic/martensitic, with machining additives	60
M1.1.2 Stainless steel, ferritic/martensitic, annealed, Rm 680 N/mm ² , 200 HB	60
M1.1.3 Stainless steel, ferritic/martensitic, heat-treated, Rm 810 N/mm ² , 240 HB	60
M2.1.1 Stainless steel, austenitic, quenched, 180 HB	45
M2.2.1 Duplex steel, high-strength stainless steels	40
K1.1.1 Grey cast iron, pearlitic/ferritic, 180 HB	120
K1.1.2 Grey cast iron, pearlitic/martensitic, 260 HB	120
K1.2.1 Cast iron with spheroidal graphite, ferritic, 160 HB	100
K1.2.2 Cast iron with spheroidal graphite, pearlitic, 250 HB	100
K1.3.1 Malleable cast iron, ferritic, 130 HB	100
K1.3.2 Malleable cast iron, pearlitic, 230 HB	100
K2.1.1 Vermicular graphite cast iron (GJV)	80
K2.2.1 Austenitic-ferritic spheroidal graphite cast iron (ADI)	80
N1.1.1 Wrought aluminium alloys, non-hardened, 60 HB	250
N1.1.2 Wrought aluminium alloys, hardened, 100 HB	250
N2.1.1 Aluminium casting alloys, non-hardened, ≤ 12 % Si, 75 HB	230
N2.1.2 Aluminium casting alloys, hardened, ≤ 12 % Si, 90 HB	230
N2.1.3 Aluminium casting alloys, non-hardened, > 12 % Si, 130 HB	230
N3.1.1 Copper and copper alloys: Free-machining alloy, Pb > 1 %	130
N3.1.2 Copper and copper alloys: CuZn, CuSnZn	130
N3.1.3 Copper and copper alloys: CuSn, lead-free copper and copper electrolyte	100
N4.1.1 Non-metallic materials: Duroplastics, fibre-reinforced plastics	300
N4.1.2 Non-metallic materials: Hard rubber, wood, etc.	300
N4.1.3 Non-metallic materials: Graphite	300
S1.1.1 Heat-resistant alloys, Fe-based, annealed, 200 HB	55
S1.1.2 Heat-resistant alloys, Fe-based, hardened, 280 HB	55
S1.1.3 Heat-resistant alloys, Ni- or Co-based, annealed, 250 HB	55
S1.1.4 Heat-resistant alloys, Ni- or Co-based, hardened, 350 HB	55
S1.1.5 Heat-resistant alloys, Ni- or Co-based, cast, 320 HB	55
S2.1.1 Titanium alloys, pure titanium, Rm 400 N/mm ²	45
S2.1.2 Titanium alloys, Alpha and Beta alloys, hardened, Rm 1050 N/mm ²	45
H1.1.1 Hardened steel, hardened and tempered, < 55 HRC	50
H1.1.2 Hardened steel, hardened and tempered, < 60 HRC	50
H1.1.3 Hardened steel, hardened and tempered, > 60 HRC	50
H2.1.1 Chilled cast iron, 400 HB	45
H2.1.2 Chilled cast iron, hardened and tempered, < 55 HRC	45



Drill thread milling cutters DTMC



Cutting data

Machining group	v _c (m/min)	M3		M4 / M4x0.5	
		f _b (mm/rev)	f _z (mm)	f _b (mm/rev)	f _z (mm)
P1.1.1 Unalloyed steel, annealed. 0.15 % C. Rm 420 N/mm ² . 125 HB					
P1.1.2 Unalloyed steel, heat-treated. 0.15 % C. Rm 420 N/mm ² . 125 HB					
P1.1.3 Unalloyed steel, annealed. 0.45 % C. Rm 640 N/mm ² . 190 HB					
P1.1.4 Unalloyed steel, heat-treated. 0.45 % C. Rm 640 N/mm ² . 190 HB					
P1.1.5 Unalloyed steel, heat-treated. 0.45 % C. Rm 850 N/mm ² . 250 HB					
P1.1.6 Unalloyed steel, annealed. 0.75 % C. Rm 915 N/mm ² . 270 HB					
P1.1.7 Unalloyed steel, heat-treated. 0.75 % C. Rm 1020 N/mm ² . 300 HB					
P2.1.1 Low-alloy steel, annealed. Rm 610 N/mm ² . 180 HB					
P2.1.2 Low-alloy steel, heat-treated. Rm 930 N/mm ² . 275 HB					
P2.1.3 Low-alloy steel, heat-treated. Rm 1020 N/mm ² . 300 HB					
P2.1.4 Low-alloy steel, heat-treated. Rm 1190 N/mm ² . 350 HB					
P3.1.1 High-alloy steel and tool steel, annealed. Rm 680 N/mm ² . 200 HB					
P3.1.2 High-alloy steel and tool steel, hardened and tempered. Rm 1100 N/mm ² . 325 HB					
M1.1.1 Stainless steel, ferritic/martensitic, with machining additives					
M1.1.2 Stainless steel, ferritic/martensitic, annealed. Rm 680 N/mm ² . 200 HB					
M1.1.3 Stainless steel, ferritic/martensitic, heat-treated. Rm 810 N/mm ² . 240 HB					
M2.1.1 Stainless steel, austenitic, quenched. 180 HB					
M2.2.1 Duplex steel, high-strength stainless steels					
K1.1.1 Grey cast iron, pearlitic/ferritic. 180 HB	110	0.055	0.015	0.065	0.015
K1.1.2 Grey cast iron, pearlitic/martensitic. 260 HB	110	0.055	0.015	0.065	0.015
K1.2.1 Cast iron with spheroidal graphite, ferritic. 160 HB	90	0.055	0.015	0.065	0.015
K1.2.2 Cast iron with spheroidal graphite, pearlitic. 250 HB	90	0.055	0.015	0.065	0.015
K1.3.1 Malleable cast iron, ferritic. 130 HB	90	0.055	0.015	0.065	0.015
K1.3.2 Malleable cast iron, pearlitic. 230 HB	90	0.055	0.015	0.065	0.015
K2.1.1 Vermicular graphite cast iron (GJV)					
K2.2.1 Austenitic-ferritic spheroidal graphite cast iron (ADI)					
N1.1.1 Wrought aluminium alloys, non-hardened. 60 HB	250	0.060	0.020	0.070	0.025
N1.1.2 Wrought aluminium alloys, hardened. 100 HB	250	0.060	0.020	0.070	0.025
N2.1.1 Aluminium casting alloys, non-hardened. ≤ 12 % Si. 75 HB	230	0.060	0.020	0.070	0.025
N2.1.2 Aluminium casting alloys, hardened. ≤ 12 % Si. 90 HB	230	0.060	0.020	0.070	0.025
N2.1.3 Aluminium casting alloys, non-hardened. > 12 % Si. 130 HB	230	0.060	0.020	0.070	0.025
N3.1.1 Copper and copper alloys: Free-machining alloy. Pb > 1 %	130	0.045	0.015	0.050	0.020
N3.1.2 Copper and copper alloys: CuZn. CuSnZn	130	0.045	0.015	0.050	0.020
N3.1.3 Copper and copper alloys: CuSn. lead-free copper and copper electrolyte					
N4.1.1 Non-metallic materials: Duroplastics, fibre-reinforced plastics	300	0.050	0.025	0.060	0.030
N4.1.2 Non-metallic materials: Hard rubber, wood, etc.	300	0.050	0.025	0.060	0.030
N4.1.3 Non-metallic materials: Graphite	300	0.050	0.025	0.060	0.030
S1.1.1 Heat-resistant alloys, Fe-based, annealed. 200 HB					
S1.1.2 Heat-resistant alloys, Fe-based, hardened. 280 HB					
S1.1.3 Heat-resistant alloys, Ni- or Co-based, annealed. 250 HB					
S1.1.4 Heat-resistant alloys, Ni- or Co-based, hardened. 350 HB					
S1.1.5 Heat-resistant alloys, Ni- or Co-based, cast. 320 HB					
S2.1.1 Titanium alloys, pure titanium. Rm 400 N/mm ²					
S2.1.2 Titanium alloys, Alpha and Beta alloys, hardened. Rm 1050 N/mm ²					
H1.1.1 Hardened steel, hardened and tempered. < 55 HRC					
H1.1.2 Hardened steel, hardened and tempered. < 60 HRC					
H1.1.3 Hardened steel, hardened and tempered. > 60 HRC					
H2.1.1 Chilled cast iron. 400 HB					
H2.1.2 Chilled cast iron, hardened and tempered. < 55 HRC					



Reaming tools

An all-round success

Innovative reamers
for every diameter range

GÜHRING

Page

984	High-performance reamers HR 500
995	Carbide reamers
1002	HSS-E reamers
1029	HSS reamers



ALL-ROUNDER
High degree of material flexibility

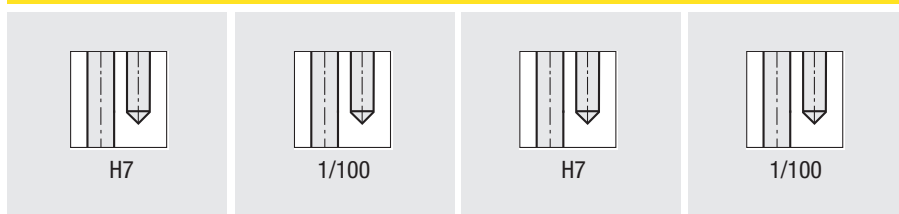

Solid carbide **HSS-E**

P Steel, high-alloy steel



NC machine reamers
e.g. # 6017
p. 995



NC machine reamers
e.g. # 6018
p. 996



NC machine reamers
e.g. # 490
p. 1002



NC machine reamers
e.g. # 455
p. 1002

M Stainless steel



NC machine reamers
e.g. # 6017
p. 995



NC machine reamers
e.g. # 6018
p. 996

K Grey cast iron, spheroidal graphite iron and malleable cast iron



NC machine reamers
e.g. # 6017
p. 995



NC machine reamers
e.g. # 6018
p. 996



NC machine reamers
e.g. # 490
p. 1002



NC machine reamers
e.g. # 455
p. 1002

N Aluminium, magnesium, non-ferrous metals



NC machine reamers
e.g. # 1449
p. 995



NC machine reamers
e.g. # 1427
p. 996



NC machine reamers
e.g. # 490
p. 1002



NC machine reamers
e.g. # 455
p. 1002

S Special, super and titanium alloy



NC machine reamers
e.g. # 6017
p. 995



NC machine reamers
e.g. # 6018
p. 996

H Chilled cast iron, hardened steel



NC machine reamers
e.g. # 6017
p. 995



NC machine reamers
e.g. # 6018
p. 996



















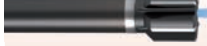
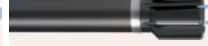

Didn't find what you were looking for?

Enter very specific requirements into our online Gühring Navigator and you will receive precise tool recommendations – cutting values included.

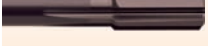

SPECIALIST

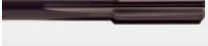
Maximum tool life, minimum cycle time

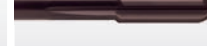
H7		H7		1/100		1/100		H7		H7		
Solid carbide						Cermet						
												
HR 500 S e.g. # 1685 p. 984	HR 500 D e.g. # 1686 p. 984	HR 500 S e.g. # 1675 p. 985	HR 500 D e.g. # 1676 p. 985	HR 500 GS e.g. # 1682 p. 991	HR 500 GD e.g. # 1683 p. 991							
												
HR 500 S e.g. # 1685 p. 984	HR 500 D e.g. # 1686 p. 984	HR 500 S e.g. # 1675 p. 985	HR 500 D e.g. # 1676 p. 985									
												
HR 500 Guss S e.g. # 1036 p. 988	HR 500 Guss D e.g. # 1037 p. 988							HR 500 GS e.g. # 1682 p. 991	HR 500 GD e.g. # 1683 p. 991			
												
HR 500 Alu S e.g. # 1678 p. 989	HR 500 Alu D e.g. # 1679 p. 989											
												
HR 500 S e.g. # 1685 p. 984	HR 500 D e.g. # 1686 p. 984	HR 500 S e.g. # 1675 p. 985	HR 500 D e.g. # 1676 p. 985									
												
HR 500 S e.g. # 1685 p. 984	HR 500 D e.g. # 1686 p. 984	HR 500 S e.g. # 1675 p. 985	HR 500 D e.g. # 1676 p. 985									

Reaming tools



High-performance reamers HR 500

P	M	K	N	S	H	Tool illustration	Shank form	Tolerance on Ø	Standard	Hole type	Tool material	Surface	d1/mm	Article no.	Page
•	•	○	○	•	•		HA	H7	WN		VHM	a	2.000 - 20.000	1685	984
•	•	○	○	•	•		HA	H7	WN		VHM	a	2.000 - 20.000	1686	984
•	•	○	○	•	•		HA	+0,005	WN		VHM	a	1.970 - 12.030	1675	985
•	•	○	○	•	•		HA	+0,005	WN		VHM	a	1.970 - 12.030	1676	985
•	•	○	○	•	•		HA	H7	WN		VHM	a	14.000 - 42.000	1548	987
•	•	○	○	•	•		HA	H7	WN		VHM	a	14.000 - 42.000	1549	987
	•						HA	H7	WN		VHM	Y	3.000 - 20.000	1036	988
	•						HA	H7	WN		VHM	Y	3.000 - 20.000	1037	988
		•					HA	H7	WN		VHM	Cb	4.000 - 20.000	1678	989
		•					HA	H7	WN		VHM	Cb	4.000 - 20.000	1679	989
○	•	•	○	○			HA	H7	WN		HM	a	22.000 - 40.000	1680	990
○	•	•	○	○			HA	H7	WN		HM	a	22.000 - 40.000	1681	990
•	•						HA	H7	WN		Cermet	○	6.000 - 40.000	1682	991
•	•						HA	H7	WN		Cermet	○	6.000 - 40.000	1683	991
○	•	•	○	•			-HA	H7	WN		HM	a	41.000 - 76.000	1038	992
○	•	•	○	•			-HA	H7	WN		HM	a	41.000 - 76.000	1039	992
•	•						-HA	H7	WN		Cermet	○	41.000 - 76.000	1040	993
•	•						-HA	H7	WN		Cermet	○	41.000 - 76.000	1041	993
HSK-A hydraulic chucks, overlength															
							HSK-A		WN			○		4290	994

Reaming tools



P	M	K	N	S	H	Tool illustration	Shank form	Tolerance on Ø	Standard	Hole type	Tool material	Surface	d1/mm	Article no.	Page
NC machine reamers															
●	○	●	●	○			HA	H7	WN		VHM	○	3.000 - 12.000	1449	995
●	●	○	●				HA	H7	WN		VHM	Ⓜ	3.000 - 20.000	6017	995
●	○	●	●	○		 1/100	HA	+0,004 +0,005	WN		VHM	○	0.980 - 12.050	1427	996
●	●	○	●			 1/100	HA	+0,004 +0,005	WN		VHM	Ⓜ	0.980 - 12.050	6018	996
Machine reamers															
●	○	●	●	○			Cyl	H7	~DIN 8050		HM	○	5.000 - 20.000	717	997
●	○	●	●	○			Cyl	H7	~DIN 8050		HM	○	5.000 - 20.000	718	997
●	○	●	●	○			Cyl	H7	~DIN 8093		HM	○	1.000 - 20.000	1408	998
●	○	●	●	○			Cyl	H7	~DIN 8093		HM	○	1.000 - 20.000	1409	998
●	○	●	●	○			MK	H7	~DIN 8094		HM	○	5.000 - 40.000	1410	999
●	○	●	●	○			MK	H7	~DIN 8094		HM	○	5.000 - 40.000	1411	999
Machine reamers															
●	○	●	●	○			Cyl	H7	~DIN 8090		HM	○	4.000 - 15.000	674	1000
●	○	●	●	○			Cyl	H7	~DIN 8090		HM	○	3.000 - 20.000	1407	1000
Expanding machine reamers															
●	○	●	●	○			Cyl	H7	WN		HM	○	8.000 - 20.000	749	1001
●	○	●	●	○			MK	H7	WN		HM	○	8.000 - 38.000	740	1001

Reaming tools



P	M	K	N	S	H	Tool illustration	Shank form	Tolerance on Ø	Standard	Hole type	Tool material	Surface	d1/mm	Article no.	Page
NC machine reamers															
•	○	•	•	•			HA	H7	DIN 212-3		HSS-E	○	1.500 - 20.000	490	1002
•	○	•	•	•			HA	+0,004 +0,005	DIN 212-3		HSS-E	○	1.000 - 12.030	455	1002
Machine reamers															
•	○	•	•	•			Cyl	H7	DIN 212-1		HSS-E	○	1.000 - 3.500	401	1004
•	○	•	•	•			Cyl	H7	DIN 212-1		HSS-E	○	1.000 - 3.700	402	1004
•	○	•	•	•			Cyl	H7	DIN 212-2		HSS-E	○	4.000 - 20.000	440	1005
•	○	•	○	•			Cyl	H7	DIN 212-2		HSS-E	Ⓢ	4.000 - 20.000	641	1005
•	○	•	•	•			Cyl	H7	DIN 212-2		HSS-E	○	3.800 - 20.000	468	1006
•	○	•	•	•			Cyl	+0,004 +0,005	DIN 212-1		HSS-E	○	0.950 - 12.050	496	1007
•	○	•	•	•			MK	H7	DIN 208		HSS-E	○	3.000 - 50.000	404	1014
•	○	•	•	•			MK	H7	DIN 208		HSS-E	○	3.000 - 50.000	405	1014
Machine reamers with internal cooling															
•	○	•	•	•			Cyl	H7	DIN 212-2		HSS-E	○	5.000 - 20.000	1431	1015
Machine reamers															
•	○	•	•	•			Cyl	H7	DIN 8089		HSS-E	○	4.000 - 20.000	488	1016
•	○	•	•	•			Cyl	H7	DIN 8089		HSS-E	○	4.000 - 20.000	489	1016
•	○	•	•	•			Cyl	+0,004 +0,005	DIN 8089		HSS-E	○	3.760 - 12.050	497	1017
Quick helix reamers															
•	○	•	•	○			Cyl	H7	DIN 212-1		HSS-E	○	1.000 - 3.500	403	1023
•	○	•	•	○			Cyl	H7	DIN 212-2		HSS-E	○	4.000 - 20.000	469	1023
•	○	•	•	○			MK	H7	DIN 208		HSS-E	○	3.000 - 32.000	406	1024
Bridge reamers															
•	•	•	○				MK		DIN 311		HSS	●	6.400 - 37.000	414	1025
Machine bottoming reamers															
•	○	•	•	○			Cyl	H7	WN		HSS-E	○	2.500 - 12.000	419	1026
Stepped machine reamers															
•	○	•	•	○			MK	H7	WN		HSS-E	○	5.000 - 20.000	431	1026
Shell reamers															
•	○	•	•	•				H7	DIN 219		HSS-E	●	25.000 - 75.000	408	1027
Arbors, complete															
							MK		DIN 217				13.000 - 50.000	1438	1027



P	M	K	N	S	H	Tool illustration	Shank form	Tolerance on Ø	Standard	Hole type	Tool material	Surface	d1/mm	Article no.	Page
Machine taper reamers															
•	○	•	•	○			Cyl		DIN 2179		HSS-E	○	1.000 - 12.000	410	1028
•	○	•	•	○			MK		DIN 2180		HSS-E	○	5.000 - 50.000	411	1028
Hand taper reamers															
•	•	•	•				Cyl		DIN 9		HSS	○	2.000 - 40.000	429	1029
•	•	•	•				Cyl		WN		HSS	○	3.000 - 10.000	1433	1029
Hand reamers															
•	•	•	•				Cyl	H7	DIN 206		HSS	○	2.000 - 49.000	412	1030
•	•	•	•				Cyl	H7	DIN 206		HSS	○	1.000 - 48.000	413	1030
Adjustable hand reamers															
•	•	•	•				Cyl		DIN 859		HSS	○	4.000 - 59.000	415	1031
Expanding hand reamers															
•	•	•	•				Cyl	H7	WN		HSS	○	6.400 - 80.000	416	1032
Replacement blades for expanding hand reamers															
•	•	•	•						WN		HSS	○	6.400 - 80.000	417	1032

Reaming tools



High-performance reamers HR 500

High-performance reamers

Article no. **1685**



Cutting data page 1034



P	M	K	N	S	H
●	●	○	○	●	●

extremely unequal flute spacing • central internal coolant supply, outlet on the face • H7 series in accordance with DIN 1420 • intermediate dimensions of Ø1.97–20.1 mm possible • for clamping in hydraulic and shrink fit chucks

High-performance reamers

Article no. **1686**



Cutting data page 1034



P	M	K	N	S	H
●	●	○	○	●	●

extremely unequal flute spacing • central internal coolant supply, outlet via oil grooves on shank • H7 series in accordance with DIN 1420 • intermediate dimensions of Ø1.97–20.1 mm possible • for clamping in hydraulic and shrink fit chucks

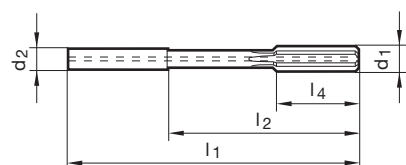

Solid carbide high-performance reamers HR 500

Article no.

1685

1686

d1 mm	d2 h6 mm	l1 mm	l2 mm	l4 mm	Z	Order no.	
2.00	4.00	50.0	22.0	8.0	4	1685 2.000	1686 2.000
2.50	4.00	50.0	22.0	8.0	4	1685 2.500	1686 2.500
3.00	4.00	68.0	40.0	12.0	4	1685 3.000	1686 3.000
3.50	4.00	68.0	40.0	12.0	4	1685 3.500	1686 3.500
4.00	4.00	68.0	40.0	12.0	4	1685 4.000	1686 4.000
4.50	6.00	76.0	40.0	12.0	4	1685 4.500	1686 4.500
5.00	6.00	76.0	40.0	12.0	4	1685 5.000	1686 5.000
5.50	6.00	76.0	40.0	12.0	4	1685 5.500	1686 5.500
6.00	6.00	76.0	40.0	12.0	4	1685 6.000	1686 6.000
6.50	8.00	101.0	65.0	16.0	6	1685 6.500	1686 6.500
7.00	8.00	101.0	65.0	16.0	6	1685 7.000	1686 7.000
7.50	8.00	101.0	65.0	16.0	6	1685 7.500	1686 7.500
8.00	8.00	101.0	65.0	16.0	6	1685 8.000	1686 8.000
8.50	10.00	101.0	61.0	19.0	6	1685 8.500	1686 8.500
9.00	10.00	101.0	61.0	19.0	6	1685 9.000	1686 9.000
9.50	10.00	101.0	61.0	19.0	6	1685 9.500	1686 9.500
10.00	10.00	101.0	61.0	19.0	6	1685 10.000	1686 10.000
10.50	12.00	130.0	85.0	19.0	6	1685 10.500	1686 10.500
11.00	12.00	130.0	85.0	19.0	6	1685 11.000	1686 11.000
11.50	12.00	130.0	85.0	19.0	6	1685 11.500	1686 11.500
12.00	12.00	130.0	85.0	19.0	6	1685 12.000	1686 12.000
13.00	14.00	130.0	85.0	22.0	6	1685 13.000	1686 13.000
14.00	14.00	130.0	85.0	22.0	6	1685 14.000	1686 14.000
15.00	16.00	150.0	102.0	22.0	6	1685 15.000	1686 15.000
16.00	16.00	150.0	102.0	22.0	6	1685 16.000	1686 16.000
17.00	18.00	150.0	102.0	25.0	6	1685 17.000	1686 17.000
18.00	18.00	150.0	102.0	25.0	6	1685 18.000	1686 18.000
19.00	20.00	150.0	100.0	25.0	6	1685 19.000	1686 19.000
20.00	20.00	150.0	100.0	25.0	6	1685 20.000	1686 20.000



High-performance reamers

Article no. **1675**

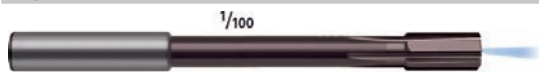

Cutting data page 1034

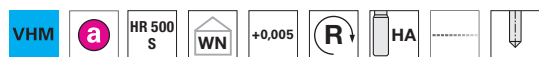

P	M	K	N	S	H
●	●	○	○	●	●

extremely unequal flute spacing • central internal coolant supply, outlet on the face • 1/100 dimension • intermediate dimensions of Ø1.97–20.1 mm possible • for clamping in hydraulic and shrink fit chucks

High-performance reamers

Article no. **1676**



Cutting data page 1034

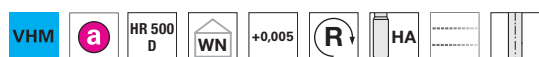

P	M	K	N	S	H
●	●	○	○	●	●

extremely unequal flute spacing • central internal coolant supply, outlet via oil grooves on shank • 1/100 dimension • intermediate dimensions of Ø1.97–20.1 mm possible • for clamping in hydraulic and shrink fit chucks

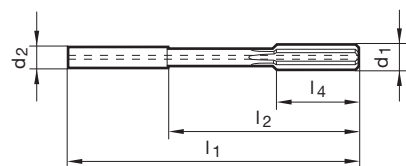

Article no. **1675** **1676**

d1 mm	d2 h6 mm	l1 mm	l2 mm	l4 mm	Z	Order no.
1.97	4.00	50.0	22.0	8.0	4	1675 1.970 1676 1.970
1.98	4.00	50.0	22.0	8.0	4	1675 1.980 1676 1.980
1.99	4.00	50.0	22.0	8.0	4	1675 1.990 1676 1.990
2.00	4.00	50.0	22.0	8.0	4	1675 2.000 1676 2.000
2.01	4.00	50.0	22.0	8.0	4	1675 2.010 1676 2.010
2.02	4.00	50.0	22.0	8.0	4	1675 2.020 1676 2.020
2.03	4.00	50.0	22.0	8.0	4	1675 2.030 1676 2.030
2.97	4.00	68.0	40.0	12.0	4	1675 2.970 1676 2.970
2.98	4.00	68.0	40.0	12.0	4	1675 2.980 1676 2.980
2.99	4.00	68.0	40.0	12.0	4	1675 2.990 1676 2.990
3.00	4.00	68.0	40.0	12.0	4	1675 3.000 1676 3.000
3.01	4.00	68.0	40.0	12.0	4	1675 3.010 1676 3.010
3.02	4.00	68.0	40.0	12.0	4	1675 3.020 1676 3.020
3.03	4.00	68.0	40.0	12.0	4	1675 3.030 1676 3.030
3.97	4.00	68.0	40.0	12.0	4	1675 3.970 1676 3.970
3.98	4.00	68.0	40.0	12.0	4	1675 3.980 1676 3.980
3.99	4.00	68.0	40.0	12.0	4	1675 3.990 1676 3.990
4.00	4.00	68.0	40.0	12.0	4	1675 4.000 1676 4.000
4.01	4.00	68.0	40.0	12.0	4	1675 4.010 1676 4.010
4.02	4.00	68.0	40.0	12.0	4	1675 4.020 1676 4.020
4.03	4.00	68.0	40.0	12.0	4	1675 4.030 1676 4.030
4.97	6.00	76.0	40.0	12.0	4	1675 4.970 1676 4.970
4.98	6.00	76.0	40.0	12.0	4	1675 4.980 1676 4.980
4.99	6.00	76.0	40.0	12.0	4	1675 4.990 1676 4.990
5.00	6.00	76.0	40.0	12.0	4	1675 5.000 1676 5.000
5.01	6.00	76.0	40.0	12.0	4	1675 5.010 1676 5.010
5.02	6.00	76.0	40.0	12.0	4	1675 5.020 1676 5.020
5.03	6.00	76.0	40.0	12.0	4	1675 5.030 1676 5.030
5.97	6.00	76.0	40.0	12.0	4	1675 5.970 1676 5.970
5.98	6.00	76.0	40.0	12.0	4	1675 5.980 1676 5.980
5.99	6.00	76.0	40.0	12.0	4	1675 5.990 1676 5.990
6.00	6.00	76.0	40.0	12.0	4	1675 6.000 1676 6.000
6.01	6.00	76.0	40.0	12.0	4	1675 6.010 1676 6.010
6.02	6.00	76.0	40.0	12.0	4	1675 6.020 1676 6.020
6.03	6.00	76.0	40.0	12.0	4	1675 6.030 1676 6.030
7.00	8.00	101.0	65.0	16.0	6	1675 7.000 1676 7.000
7.97	8.00	101.0	65.0	16.0	6	1675 7.970 1676 7.970
7.98	8.00	101.0	65.0	16.0	6	1675 7.980 1676 7.980
7.99	8.00	101.0	65.0	16.0	6	1675 7.990 1676 7.990
8.00	8.00	101.0	65.0	16.0	6	1675 8.000 1676 8.000
8.01	8.00	101.0	65.0	16.0	6	1675 8.010 1676 8.010
8.02	8.00	101.0	65.0	16.0	6	1675 8.020 1676 8.020
8.03	8.00	101.0	65.0	16.0	6	1675 8.030 1676 8.030
9.00	10.00	101.0	61.0	19.0	6	1675 9.000 1676 9.000
9.97	10.00	101.0	61.0	19.0	6	1675 9.970 1676 9.970
9.98	10.00	101.0	61.0	19.0	6	1675 9.980 1676 9.980
9.99	10.00	101.0	61.0	19.0	6	1675 9.990 1676 9.990
10.00	10.00	101.0	61.0	19.0	6	1675 10.000 1676 10.000

Solid carbide high-performance reamers HR 500



High-performance reamers HR 500

d1 mm	d2 h6 mm	l1 mm	l2 mm	l4 mm	Z	Article no.	
						1675	1676
10.01	10.00	101.0	61.0	19.0	6	Order no.	
10.02	10.00	101.0	61.0	19.0	6	1675 10.010	1676 10.010
10.03	10.00	101.0	61.0	19.0	6	1675 10.020	1676 10.020
11.00	12.00	130.0	85.0	19.0	6	1675 10.030	1676 10.030
11.97	12.00	130.0	85.0	19.0	6	1675 11.000	1676 11.000
11.98	12.00	130.0	85.0	19.0	6	1675 11.970	1676 11.970
11.99	12.00	130.0	85.0	19.0	6	1675 11.980	1676 11.980
12.00	12.00	130.0	85.0	19.0	6	1675 11.990	1676 11.990
12.01	12.00	130.0	85.0	19.0	6	1675 12.000	1676 12.000
12.02	12.00	130.0	85.0	19.0	6	1675 12.010	1676 12.010
12.03	12.00	130.0	85.0	19.0	6	1675 12.020	1676 12.020
						1675 12.030	1676 12.030

Solid carbide high-performance reamers HR 500



High-performance reamers

Article no. 1548



Cutting data page 1035



P	M	K	N	S	H
●	●	○	○	●	●

extremely unequal flute spacing • central internal coolant supply, outlet on the face • H7 series in accordance with DIN 1420 • intermediate dimensions of Ø11.9–42.1 mm possible • use shrink fit extension art. no. 4719 for increased projection

High-performance reamers

Article no. 1549



Cutting data page 1035



P	M	K	N	S	H
●	●	○	○	●	●

spiral point • extremely unequal flute spacing • central internal coolant supply, radial outlet • H7 series in accordance with DIN 1420 • intermediate dimensions of Ø11.9–42.1 mm possible • use shrink fit extension art. no. 4719 for increased projection

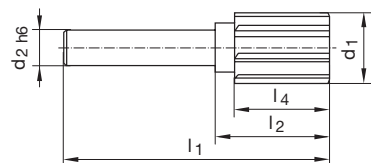

Article no. 1548 1549

d1 mm	d2 h6 mm	l1 mm	l2 mm	l4 mm	Z	Order no.
14.00	6.00	66.0	30.0	25.0	8	1548 14.000 1549 14.000
15.00	6.00	66.0	30.0	25.0	8	1548 15.000 1549 15.000
16.00	8.00	66.0	30.0	25.0	8	1548 16.000 1549 16.000
18.00	8.00	66.0	30.0	25.0	8	1548 18.000 1549 18.000
20.00	10.00	70.0	30.0	25.0	8	1548 20.000 1549 20.000
22.00	10.00	70.0	30.0	25.0	8	1548 22.000 1549 22.000
24.00	12.00	75.0	30.0	25.0	8	1548 24.000 1549 24.000
25.00	12.00	75.0	30.0	25.0	8	1548 25.000 1549 25.000
26.00	12.00	75.0	30.0	25.0	8	1548 26.000 1549 26.000
28.00	12.00	75.0	30.0	25.0	8	1548 28.000 1549 28.000
30.00	16.00	78.0	30.0	25.0	8	1548 30.000 1549 30.000
32.00	16.00	78.0	30.0	25.0	8	1548 32.000 1549 32.000
34.00	20.00	80.0	30.0	25.0	8	1548 34.000 1549 34.000
36.00	20.00	80.0	30.0	25.0	8	1548 36.000 1549 36.000
38.00	20.00	80.0	30.0	25.0	8	1548 38.000 1549 38.000
40.00	20.00	80.0	30.0	25.0	8	1548 40.000 1549 40.000
42.00	20.00	80.0	30.0	25.0	8	1548 42.000 1549 42.000

Solid carbide high-performance reamers HR 500



High-performance reamers HR 500

High-performance reamers

Article no. **1036**



Cutting data page 1036



extremely unequal flute spacing • central internal coolant supply, outlet on the face • H7 series in accordance with DIN 1420 • intermediate dimensions of Ø1.97–20.1 mm possible • for clamping in hydraulic and shrink fit chucks

High-performance reamers

Article no. **1037**



Cutting data page 1036



extremely unequal flute spacing • central internal coolant supply, outlet via oil grooves on shank • H7 series in accordance with DIN 1420 • intermediate dimensions of Ø1.97–20.1 mm possible • for clamping in hydraulic and shrink fit chucks

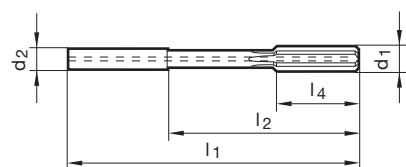

Article no.

1036

1037

d1 mm	d2 h6 mm	l1 mm	l2 mm	l4 mm	Z	Order no.	
						1036	1037
3.00	4.00	68.0	40.0	12.0	6	1036 3.000	1037 3.000
4.00	4.00	68.0	40.0	12.0	6	1036 4.000	1037 4.000
5.00	6.00	76.0	40.0	12.0	6	1036 5.000	1037 5.000
6.00	6.00	76.0	40.0	12.0	6	1036 6.000	1037 6.000
7.00	8.00	101.0	65.0	16.0	8	1036 7.000	1037 7.000
8.00	8.00	101.0	65.0	16.0	8	1036 8.000	1037 8.000
9.00	10.00	101.0	61.0	19.0	8	1036 9.000	1037 9.000
10.00	10.00	101.0	61.0	19.0	8	1036 10.000	1037 10.000
11.00	12.00	130.0	85.0	19.0	8	1036 11.000	1037 11.000
12.00	12.00	130.0	85.0	19.0	8	1036 12.000	1037 12.000
13.00	14.00	130.0	85.0	22.0	8	1036 13.000	1037 13.000
14.00	14.00	130.0	85.0	22.0	8	1036 14.000	1037 14.000
15.00	16.00	150.0	102.0	22.0	8	1036 15.000	1037 15.000
16.00	16.00	150.0	102.0	22.0	8	1036 16.000	1037 16.000
17.00	18.00	150.0	102.0	25.0	8	1036 17.000	1037 17.000
18.00	18.00	150.0	102.0	25.0	8	1036 18.000	1037 18.000
19.00	20.00	150.0	100.0	25.0	8	1036 19.000	1037 19.000
20.00	20.00	150.0	100.0	25.0	8	1036 20.000	1037 20.000

Solid carbide high-performance reamers HR 500



High-performance reamers

Article no. **1678**



Cutting data page 1037

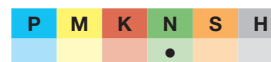

extremely unequal flute spacing • central internal coolant supply, outlet on the face • H7 series in accordance with DIN 1420 • intermediate dimensions of $\varnothing 1.97\text{--}20.1$ mm possible • for clamping in hydraulic and shrink fit chucks

High-performance reamers

Article no. **1679**



Cutting data page 1037

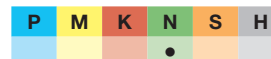

extremely unequal flute spacing • central internal coolant supply, outlet via oil grooves on shank • H7 series in accordance with DIN 1420 • intermediate dimensions of $\varnothing 1.97\text{--}20.1$ mm possible • for clamping in hydraulic and shrink fit chucks

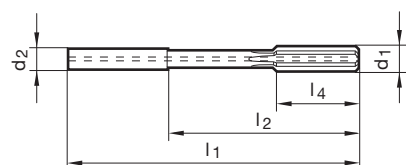

Article no.

1678

1679

d1 mm	d2 h6 mm	l1 mm	l2 mm	l4 mm	Z	Order no.	
4.00	4.00	68.0	40.0	12.0	4	1678 4.000	1679 4.000
5.00	6.00	76.0	40.0	12.0	4	1678 5.000	1679 5.000
6.00	6.00	76.0	40.0	12.0	4	1678 6.000	1679 6.000
7.00	8.00	101.0	65.0	16.0	6	1678 7.000	1679 7.000
8.00	8.00	101.0	65.0	16.0	6	1678 8.000	1679 8.000
10.00	10.00	101.0	61.0	19.0	6	1678 10.000	1679 10.000
12.00	12.00	130.0	85.0	19.0	6	1678 12.000	1679 12.000
14.00	14.00	130.0	85.0	22.0	6	1678 14.000	1679 14.000
16.00	16.00	150.0	102.0	22.0	6	1678 16.000	1679 16.000
18.00	18.00	150.0	102.0	25.0	6	1678 18.000	1679 18.000
20.00	20.00	150.0	100.0	25.0	6	1678 20.000	1679 20.000

Solid carbide high-performance reamers HR 500



High-performance reamers HR 500

High-performance reamers

Article no. 1680



Cutting data page 1038



P	M	K	N	S	H
○	●	●	○	○	

carbide-tipped • extremely unequal flute spacing • central internal coolant supply, outlet on the face • H7 series in accordance with DIN 1420 • intermediate dimensions of Ø20.1–40.1 mm possible • NC-compliant design

High-performance reamers

Article no. 1681



Cutting data page 1038



P	M	K	N	S	H
○	●	●	○	○	

carbide-tipped • extremely unequal flute spacing • central internal coolant supply, outlet via oil grooves on shank • H7 series in accordance with DIN 1420 • intermediate dimensions of Ø20.1–40.1 mm possible • NC-compliant design

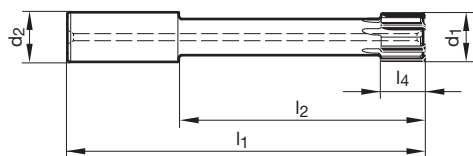

Article no.

1680

1681

d1 mm	d2 h6 mm	l1 mm	l2 mm	l4 mm	Z	Order no.	
						1680	1681
22.00	20.00	160.0	110.0	22.0	6	1680 22.000	1681 22.000
24.00	25.00	180.0	124.0	22.0	6	1680 24.000	1681 24.000
25.00	25.00	180.0	124.0	22.0	6	1680 25.000	1681 25.000
26.00	25.00	180.0	124.0	22.0	6	1680 26.000	1681 26.000
28.00	25.00	180.0	124.0	25.0	6	1680 28.000	1681 28.000
30.00	25.00	180.0	124.0	25.0	6	1680 30.000	1681 30.000
32.00	32.00	200.0	140.0	25.0	6	1680 32.000	1681 32.000
34.00	32.00	200.0	140.0	25.0	6	1680 34.000	1681 34.000
36.00	32.00	200.0	140.0	25.0	8	1680 36.000	1681 36.000
38.00	32.00	200.0	140.0	25.0	8	1680 38.000	1681 38.000
40.00	32.00	200.0	140.0	25.0	8	1680 40.000	1681 40.000

Solid carbide high-performance reamers HR 500



High-performance reamers

Article no. **1682**



CM-assembled • extremely unequal flute spacing • central internal coolant supply, outlet on the face • H7 series in accordance with DIN 1420 • intermediate dimensions of Ø5.9–40.1 mm possible • NC-compliant design

Cutting data page 1039

P	M	K	N	S	H
•		•			

High-performance reamers

Article no. **1683**



CM-assembled • extremely unequal flute spacing • central internal coolant supply, outlet via oil grooves on shank • H7 series in accordance with DIN 1420 • intermediate dimensions of Ø5.9–40.1 mm possible • NC-compliant design

Cutting data page 1039

P	M	K	N	S	H
•		•			

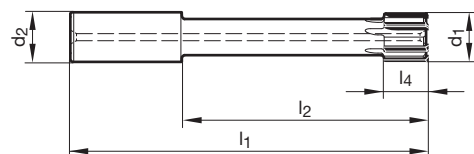

Article no.

1682

1683

d1 mm	d2 h6 mm	l1 mm	l2 mm	l4 mm	Z	Order no.	
6.00	6.00	76.0	40.0	12.0	4	1682 6.000	1683 6.000
8.00	8.00	101.0	65.0	16.0	4	1682 8.000	1683 8.000
10.00	10.00	101.0	61.0	16.0	4	1682 10.000	1683 10.000
12.00	12.00	130.0	85.0	16.0	4	1682 12.000	1683 12.000
14.00	14.00	130.0	85.0	16.0	6	1682 14.000	1683 14.000
16.00	16.00	150.0	102.0	19.0	6	1682 16.000	1683 16.000
18.00	18.00	150.0	102.0	19.0	6	1682 18.000	1683 18.000
20.00	20.00	150.0	100.0	22.0	6	1682 20.000	1683 20.000
22.00	20.00	160.0	110.0	22.0	6	1682 22.000	1683 22.000
24.00	25.00	180.0	124.0	22.0	6	1682 24.000	1683 24.000
25.00	25.00	180.0	124.0	22.0	6	1682 25.000	1683 25.000
26.00	25.00	180.0	124.0	22.0	6	1682 26.000	1683 26.000
28.00	25.00	180.0	124.0	25.0	6	1682 28.000	1683 28.000
30.00	25.00	180.0	124.0	25.0	6	1682 30.000	1683 30.000
32.00	32.00	200.0	140.0	25.0	6	1682 32.000	1683 32.000
33.00	32.00	200.0	140.0	25.0	6		1683 33.000
34.00	32.00	200.0	140.0	25.0	6	1682 34.000	1683 34.000
36.00	32.00	200.0	140.0	25.0	8	1682 36.000	1683 36.000
38.00	32.00	200.0	140.0	25.0	8	1682 38.000	1683 38.000
40.00	32.00	200.0	140.0	25.0	8	1682 40.000	1683 40.000

Solid carbide high-performance reamers HR 500



High-performance reamers HR 500

High-performance reamers

Article no. 1038



Cutting data page 1040



carbide-tipped • extremely unequal flute spacing • central internal coolant supply, diffuser disc outlet • H7 series in accordance with DIN 1420 • intermediate dimensions of Ø40–76.2 mm possible • for increased projection, use hydraulic chuck art. no. 4290 • available as semi-standard

High-performance reamers

Article no. 1039



Cutting data page 1040



carbide-tipped • extremely unequal flute spacing • central internal coolant supply, diffuser disc outlet • H7 series in accordance with DIN 1420 • intermediate dimensions of Ø40–76.2 mm possible • for increased projection, use hydraulic chuck art. no. 4290 • available as semi-standard

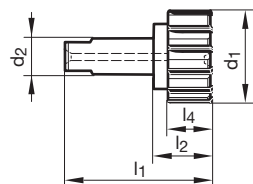

Solid carbide high-performance reamers HR 500

Article no.

1038

1039

d1 mm	d2 h6 mm	l1 mm	l2 mm	l4 mm	Z	Order no.	
						1038	1039
41.00	25.00	90.0	35.1	25.0	8	1038 41.000	1039 41.000
42.00	25.00	90.0	35.1	25.0	8	1038 42.000	1039 42.000
44.00	25.00	90.0	35.1	25.0	8	1038 44.000	1039 44.000
46.00	25.00	90.0	35.1	25.0	8	1038 46.000	1039 46.000
47.00	25.00	90.0	35.1	25.0	8	1038 47.000	1039 47.000
48.00	25.00	90.0	35.1	25.0	8	1038 48.000	1039 48.000
50.00	25.00	90.0	35.1	25.0	8	1038 50.000	1039 50.000
52.00	25.00	90.0	35.1	25.0	8	1038 52.000	1039 52.000
53.00	25.00	90.0	35.1	25.0	8	1038 53.000	1039 53.000
54.00	25.00	90.0	35.1	25.0	8	1038 54.000	1039 54.000
56.00	25.00	90.0	35.1	25.0	8	1038 56.000	1039 56.000
58.00	25.00	90.0	35.1	25.0	8	1038 58.000	1039 58.000
59.00	32.00	95.0	36.1	25.0	8	1038 59.000	1039 59.000
60.00	32.00	95.0	36.1	25.0	8	1038 60.000	1039 60.000
62.00	32.00	95.0	36.1	25.0	8	1038 62.000	1039 62.000
64.00	32.00	95.0	36.1	25.0	8	1038 64.000	1039 64.000
65.00	32.00	95.0	36.1	25.0	8	1038 65.000	1039 65.000
66.00	32.00	95.0	36.1	25.0	10	1038 66.000	1039 66.000
68.00	32.00	95.0	36.1	25.0	10	1038 68.000	1039 68.000
70.00	32.00	95.0	36.1	25.0	10	1038 70.000	1039 70.000
71.00	32.00	95.0	36.1	25.0	10	1038 71.000	1039 71.000
72.00	32.00	95.0	36.1	25.0	10	1038 72.000	1039 72.000
74.00	32.00	95.0	36.1	25.0	10	1038 74.000	1039 74.000
76.00	32.00	95.0	36.1	25.0	10	1038 76.000	1039 76.000



High-performance reamers

Article no. **1040**



Cutting data page 1041



P	M	K	N	S	H
•		•			

CM-assembled • extremely unequal flute spacing • central internal coolant supply, diffuser disc outlet • H7 series in accordance with DIN 1420 • intermediate dimensions of Ø40–76.2 mm possible • for increased projection, use hydraulic chuck art. no. 4290 • available as semi-standard

High-performance reamers

Article no. **1041**



Cutting data page 1041



P	M	K	N	S	H
•		•			

CM-assembled • extremely unequal flute spacing • central internal coolant supply, diffuser disc outlet • H7 series in accordance with DIN 1420 • intermediate dimensions of Ø40–76.2 mm possible • for increased projection, use hydraulic chuck art. no. 4290 • available as semi-standard

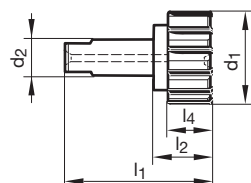

Article no.

1040

1041

d1 mm	d2 h6 mm	l1 mm	l2 mm	l4 mm	Z	Order no.	
41.00	25.00	90.0	35.1	25.0	8	1040 41.000	1041 41.000
42.00	25.00	90.0	35.1	25.0	8	1040 42.000	1041 42.000
44.00	25.00	90.0	35.1	25.0	8	1040 44.000	1041 44.000
46.00	25.00	90.0	35.1	25.0	8	1040 46.000	1041 46.000
47.00	25.00	90.0	35.1	25.0	8	1040 47.000	1041 47.000
48.00	25.00	90.0	35.1	25.0	8	1040 48.000	1041 48.000
50.00	25.00	90.0	35.1	25.0	8	1040 50.000	1041 50.000
52.00	25.00	90.0	35.1	25.0	8	1040 52.000	1041 52.000
53.00	25.00	90.0	35.1	25.0	8	1040 53.000	1041 53.000
54.00	25.00	90.0	35.1	25.0	8	1040 54.000	1041 54.000
56.00	25.00	90.0	35.1	25.0	8	1040 56.000	1041 56.000
58.00	25.00	90.0	35.1	25.0	8	1040 58.000	1041 58.000
59.00	32.00	95.0	36.1	25.0	8	1040 59.000	1041 59.000
60.00	32.00	95.0	36.1	25.0	8	1040 60.000	1041 60.000
62.00	32.00	95.0	36.1	25.0	8	1040 62.000	1041 62.000
64.00	32.00	95.0	36.1	25.0	8	1040 64.000	1041 64.000
65.00	32.00	95.0	36.1	25.0	8	1040 65.000	1041 65.000
66.00	32.00	95.0	36.1	25.0	10	1040 66.000	1041 66.000
68.00	32.00	95.0	36.1	25.0	10	1040 68.000	1041 68.000
70.00	32.00	95.0	36.1	25.0	10	1040 70.000	1041 70.000
71.00	32.00	95.0	36.1	25.0	10	1040 71.000	1041 71.000
72.00	32.00	95.0	36.1	25.0	10	1040 72.000	1041 72.000
74.00	32.00	95.0	36.1	25.0	10	1040 74.000	1041 74.000
76.00	32.00	95.0	36.1	25.0	10	1040 76.000	1041 76.000

Solid carbide high-performance reamers HR 500



HSK-A hydraulic chucks, overlength

Article no. **4290**



Product information:

- for high-performance reamers HR 500 GT with tang
- before clamping, position the reamer in the driver in the rotation direction

Scope of delivery:

- incl. setting screw (1) art. no. 4900
- order hexagon clamping key art. no. 4912 separately
- order coolant supply set, article no. 4949, separately

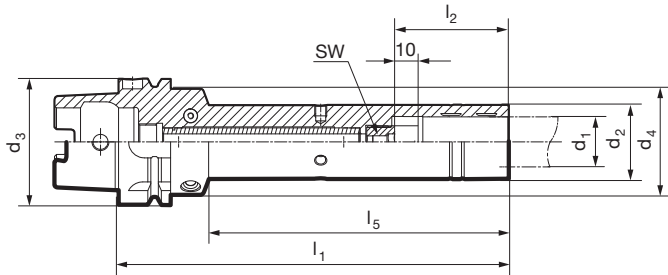

Solid carbide high-performance reamers HR 500

Article no.

4290

d3	d1 h6 mm	d2 mm	d4 mm	l1 mm	l2 mm	l5 mm	SW mm	kg	Order no.
HSK-A 63	25.00	37.00	53.00	120.00	57.00	75.00	5.0	0.4	4290 25.263
HSK-A 63	25.00	37.00	53.00	195.00	57.00	150.00	5.0	1.9	4290 25.063
HSK-A 63	25.00	37.00	53.00	295.00	57.00	250.00	5.0	2.8	4290 25.163
HSK-A 63	32.00	44.00	53.00	120.00	61.00	75.00	5.0	0.7	4290 32.263
HSK-A 63	32.00	44.00	53.00	195.00	61.00	150.00	5.0	7.3	4290 32.063
HSK-A 63	32.00	44.00	53.00	295.00	61.00	250.00	5.0	3.4	4290 32.163



NC machine reamers

Article no. 1449



Cutting data page 1042-1043



P	M	K	N	S	H
●	○	●	○	○	○

unequal – extremely unequal pitch • external internal coolant supply, no outlet • H7 series in accordance with DIN 1420
 • intermediate dimensions of Ø0.8–20.1 mm possible • chamfer lead can also be used for blind holes, to do this, remove chips • NC-compliant design

NC machine reamers

Article no. 6017



Cutting data page 1042-1043



P	M	K	N	S	H
●	●	●	○	●	○

unequal – extremely unequal pitch • external internal coolant supply, no outlet • H7 series in accordance with DIN 1420
 • intermediate dimensions of Ø0.8–20.1 mm possible • chamfer lead can also be used for blind holes, to do this, remove chips • NC-compliant design

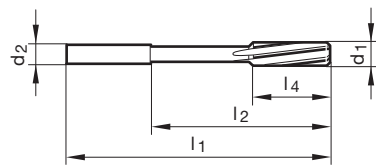

Article no.

1449

6017

Article no.

1449

6017

d1	d2	h6	l1	l2	l4	Z	Order no.		d1	d2	h6	l1	l2	l4	Z	Order no.	
3.00	4.00	64.0	36.0	17.0	6	1449 3.000	6017 3.000	8.40	10.00	117.0	80.0	33.0	6	1449 8.400	6017 8.400		
3.10	4.00	68.0	40.0	18.0	6	1449 3.100	6017 3.100	8.50	10.00	117.0	80.0	33.0	6	1449 8.500	6017 8.500		
3.20	4.00	68.0	40.0	18.0	6	1449 3.200	6017 3.200	8.60	10.00	117.0	80.0	33.0	6	1449 8.600	6017 8.600		
3.30	4.00	68.0	40.0	18.0	6	1449 3.300	6017 3.300	8.70	10.00	125.0	86.0	36.0	6	1449 8.700	6017 8.700		
3.40	4.00	74.0	46.0	20.0	6	1449 3.400	6017 3.400	8.80	10.00	125.0	86.0	36.0	6	1449 8.800	6017 8.800		
3.50	4.00	74.0	46.0	20.0	6	1449 3.500	6017 3.500	8.90	10.00	125.0	86.0	36.0	6	1449 8.900	6017 8.900		
3.60	4.00	74.0	46.0	20.0	6	1449 3.600	6017 3.600	9.00	10.00	125.0	86.0	36.0	6	1449 9.000	6017 9.000		
3.70	4.00	74.0	46.0	20.0	6	1449 3.700	6017 3.700	9.10	10.00	125.0	86.0	36.0	6	1449 9.100	6017 9.100		
3.80	4.00	77.0	45.0	21.0	6	1449 3.800	6017 3.800	9.20	10.00	125.0	86.0	36.0	6	1449 9.200	6017 9.200		
3.90	4.00	77.0	45.0	21.0	6	1449 3.900	6017 3.900	9.30	10.00	125.0	86.0	36.0	6	1449 9.300	6017 9.300		
4.00	4.00	77.0	49.0	21.0	6	1449 4.000	6017 4.000	9.40	10.00	125.0	86.0	36.0	6	1449 9.400	6017 9.400		
4.10	6.00	82.0	53.0	23.0	6	1449 4.100	6017 4.100	9.50	10.00	125.0	86.0	36.0	6	1449 9.500	6017 9.500		
4.20	6.00	82.0	53.0	23.0	6	1449 4.200	6017 4.200	9.60	10.00	125.0	86.0	36.0	6	1449 9.600	6017 9.600		
4.30	6.00	82.0	53.0	23.0	6	1449 4.300	6017 4.300	9.70	10.00	133.0	92.0	38.0	6	1449 9.700	6017 9.700		
4.40	6.00	82.0	53.0	23.0	6	1449 4.400	6017 4.400	9.80	10.00	133.0	92.0	38.0	6	1449 9.800	6017 9.800		
4.50	6.00	82.0	53.0	23.0	6	1449 4.500	6017 4.500	9.90	10.00	133.0	93.0	38.0	6	1449 9.900	6017 9.900		
4.60	6.00	82.0	53.0	23.0	6	1449 4.600	6017 4.600	10.00	10.00	133.0	93.0	38.0	6	1449 10.000	6017 10.000		
4.70	6.00	82.0	53.0	23.0	6	1449 4.700	6017 4.700	10.10	10.00	133.0	93.0	38.0	6	1449 10.100	6017 10.100		
4.80	6.00	93.0	62.0	26.0	6	1449 4.800	6017 4.800	10.20	10.00	133.0	92.0	38.0	6	1449 10.200	6017 10.200		
4.90	6.00	93.0	62.0	26.0	6	1449 4.900	6017 4.900	10.30	10.00	133.0	93.0	38.0	6	1449 10.300	6017 10.300		
5.00	6.00	93.0	62.0	26.0	6	1449 5.000	6017 5.000	10.40	10.00	133.0	93.0	38.0	6	1449 10.400	6017 10.400		
5.10	6.00	93.0	62.0	26.0	6	1449 5.100	6017 5.100	10.50	10.00	133.0	93.0	38.0	6	1449 10.500	6017 10.500		
5.20	6.00	93.0	62.0	26.0	6	1449 5.200	6017 5.200	10.60	10.00	133.0	93.0	38.0	6	1449 10.600	6017 10.600		
5.30	6.00	93.0	62.0	26.0	6	1449 5.300	6017 5.300	10.70	10.00	142.0	102.0	41.0	6	1449 10.700	6017 10.700		
5.40	6.00	93.0	60.1	26.0	6	1449 5.400	6017 5.400	10.80	10.00	142.0	102.0	41.0	6	1449 10.800	6017 10.800		
5.50	6.00	93.0	60.2	26.0	6	1449 5.500	6017 5.500	10.90	10.00	142.0	102.0	41.0	6	1449 10.900	6017 10.900		
5.60	6.00	93.0	60.2	26.0	6	1449 5.600	6017 5.600	11.00	10.00	142.0	102.0	41.0	6	1449 11.000	6017 11.000		
5.70	6.00	93.0	60.2	26.0	6	1449 5.700	6017 5.700	11.10	10.00	142.0	102.0	41.0	6	1449 11.100	6017 11.100		
5.80	6.00	93.0	60.3	26.0	6	1449 5.800	6017 5.800	11.20	10.00	142.0	102.0	41.0	6	1449 11.200	6017 11.200		
5.90	6.00	93.0	60.3	26.0	6	1449 5.900	6017 5.900	11.30	10.00	142.0	102.0	41.0	6	1449 11.300	6017 11.300		
6.00	6.00	93.0	60.3	26.0	6	1449 6.000	6017 6.000	11.40	10.00	142.0	102.0	41.0	6	1449 11.400	6017 11.400		
6.10	8.00	101.0	67.0	28.0	6	1449 6.100	6017 6.100	11.50	10.00	142.0	102.0	41.0	6	1449 11.500	6017 11.500		
6.20	8.00	101.0	67.0	28.0	6	1449 6.200	6017 6.200	11.60	10.00	142.0	102.0	41.0	6	1449 11.600	6017 11.600		
6.30	8.00	101.0	67.0	28.0	6	1449 6.300	6017 6.300	11.70	10.00	142.0	102.0	41.0	6	1449 11.700	6017 11.700		
6.40	8.00	101.0	67.0	28.0	6	1449 6.400	6017 6.400	11.80	10.00	142.0	102.0	41.0	6	1449 11.800	6017 11.800		
6.50	8.00	101.0	67.0	28.0	6	1449 6.500	6017 6.500	11.90	12.00	151.0	112.0	44.0	6	1449 11.900	6017 11.900		
6.60	8.00	101.0	67.0	28.0	6	1449 6.600	6017 6.600	12.00	12.00	151.0	106.0	44.0	6	1449 12.000	6017 12.000		
6.70	8.00	101.0	67.0	28.0	6	1449 6.700	6017 6.700	13.00	14.00	160.0	116.0	44.0	6	6017 13.000			
6.80	8.00	109.0	73.0	31.0	6	1449 6.800	6017 6.800	14.00	14.00	160.0	115.0	47.0	6	6017 14.000			
6.90	8.00	109.0	73.0	31.0	6	1449 6.900	6017 6.900	15.00	16.00	170.0	122.0	50.0	6	6017 15.000			
7.00	8.00	109.0	73.0	31.0	6	1449 7.000	6017 7.000	16.00	16.00	170.0	122.0	52.0	6	6017 16.000			
7.10	8.00	109.0	73.0	31.0	6	1449 7.100	6017 7.100	17.00	18.00	182.0	132.0	52.0	6	6017 17.000			
7.20	8.00	109.0	73.0	31.0	6	1449 7.200	6017 7.200	18.00	18.00	182.0	134.0	52.0	6	6017 18.000			
7.30	8.00	109.0	73.0	31.0	6	1449 7.300	6017 7.300	19.00	20.00	195.0	139.0	52.0	6	6017 19.000			
7.40	8.00	109.0	73.0	31.0	6	1449 7.400	6017 7.400	20.00	20.00	195.0	145.0	52.0	6	6017 20.000			
7.50	8.00	109.0	73.0	31.0	6	1449 7.500	6017 7.500										
7.60	8.00	109.0	73.0	31.0	6	1449 7.600	6017 7.600										
7.70	8.00	117.0	79.0	33.0	6	1449 7.700	6017 7.700										
7.80	8.00	117.0	79.0	33.0	6	1449 7.800	6017 7.800										
7.90	8.00	117.0	79.0	33.0	6	1449 7.900	6017 7.900										
8.00	8.00	117.0	81.0	33.0	6	1449 8.000	6017 8.000										
8.10	10.00	117.0	80.0	33.0	6	1449 8.100	6017 8.100										
8.20	10.00	117.0	80.0	33.0	6	1449 8.200	6017 8.200										
8.30	10.00	117.0	80.0	33.0	6	1449 8.300	6017 8.300										

Carbide machine reamers



NC machine reamers

Article no. 1427

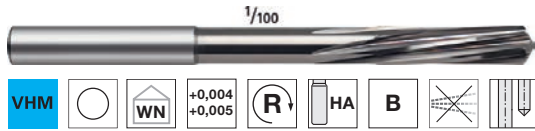

Cutting data page 1042-1043

P	M	K	N	S	H
●	○	●	●	○	

unequal – extremely unequal pitch • external internal coolant supply, no outlet • 1/100 dimension • intermediate dimensions of Ø0.8–20.1 mm possible • chamfer lead can also be used for blind holes, to do this, remove chips • NC-compliant design

NC machine reamers

Article no. 6018

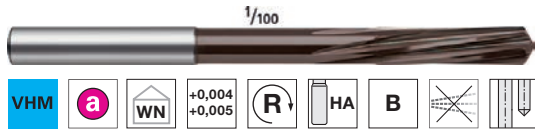

Cutting data page 1042-1043

P	M	K	N	S	H
●	●	●	○	●	

unequal – extremely unequal pitch • external internal coolant supply, no outlet • 1/100 dimension • intermediate dimensions of Ø0.8–20.1 mm possible • chamfer lead can also be used for blind holes, to do this, remove chips • NC-compliant design

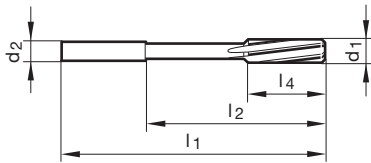

Carbide machine reamers

Article no. 1427							Article no. 6018										
d1 mm	d2 mm	h6 mm	l1 mm	l2 mm	l4 mm	Z	Order no.	Order no.	d1 mm	d2 mm	h6 mm	l1 mm	l2 mm	l4 mm	Z	Order no.	Order no.
0.98	4.00	50.0	22.0	6.0	6.0	3	1427 0.980	6018 0.980	5.01	6.00	93.0	62.0	26.0	6	6	1427 5.010	6018 5.010
0.99	4.00	50.0	22.0	6.0	6.0	3	1427 0.990	6018 0.990	5.02	6.00	93.0	62.0	26.0	6	6	1427 5.020	6018 5.020
1.00	4.00	50.0	22.0	6.0	6.0	3	1427 1.000	6018 1.000	5.03	6.00	93.0	62.0	26.0	6	6	1427 5.030	6018 5.030
1.01	4.00	50.0	22.0	6.0	6.0	3	1427 1.010	6018 1.010	5.97	6.00	93.0	60.3	26.0	6	6	1427 5.970	6018 5.970
1.02	4.00	50.0	22.0	6.0	6.0	3	1427 1.020	6018 1.020	5.98	6.00	93.0	60.3	26.0	6	6	1427 5.980	6018 5.980
1.03	4.00	50.0	22.0	9.0	9.0	3	1427 1.030	6018 1.030	5.99	6.00	93.0	60.3	26.0	6	6	1427 5.990	6018 5.990
1.48	4.00	50.0	22.0	9.0	9.0	3	1427 1.480	6018 1.480	6.00	6.00	93.0	60.3	26.0	6	6	1427 6.000	6018 6.000
1.49	4.00	50.0	22.0	9.0	9.0	3	1427 1.490	6018 1.490	6.01	6.00	93.0	60.3	26.0	6	6	1427 6.010	6018 6.010
1.50	4.00	50.0	22.0	9.0	9.0	3	1427 1.500	6018 1.500	6.02	6.00	93.0	60.3	26.0	6	6	1427 6.020	6018 6.020
1.51	4.00	50.0	22.0	9.0	9.0	3	1427 1.510	6018 1.510	6.03	6.00	93.0	60.3	26.0	6	6	1427 6.030	6018 6.030
1.52	4.00	50.0	22.0	9.0	9.0	3	1427 1.520	6018 1.520	7.00	8.00	109.0	73.0	31.0	6	6	1427 7.000	6018 7.000
1.53	4.00	50.0	22.0	9.0	9.0	3	1427 1.530	6018 1.530	7.97	8.00	117.0	79.0	33.0	6	6	1427 7.970	6018 7.970
1.98	4.00	50.0	22.0	12.0	12.0	4	1427 1.980	6018 1.980	7.98	8.00	117.0	79.0	33.0	6	6	1427 7.980	6018 7.980
1.99	4.00	50.0	22.0	12.0	12.0	4	1427 1.990	6018 1.990	7.99	8.00	117.0	79.0	33.0	6	6	1427 7.990	6018 7.990
2.00	4.00	50.0	22.0	12.0	12.0	4	1427 2.000	6018 2.000	8.00	8.00	117.0	81.0	33.0	6	6	1427 8.000	6018 8.000
2.01	4.00	50.0	22.0	12.0	12.0	4	1427 2.010	6018 2.010	8.01	8.00	117.0	79.0	33.0	6	6	1427 8.010	6018 8.010
2.02	4.00	50.0	22.0	12.0	12.0	4	1427 2.020	6018 2.020	8.02	8.00	117.0	79.0	33.0	6	6	1427 8.020	6018 8.020
2.03	4.00	50.0	22.0	12.0	12.0	4	1427 2.030	6018 2.030	8.03	8.00	117.0	79.0	33.0	6	6	1427 8.030	6018 8.030
2.48	4.00	60.0	32.0	16.0	16.0	4	1427 2.480	6018 2.480	8.04	8.00	117.0	79.0	33.0	6	6	1427 8.040	6018 8.040
2.49	4.00	60.0	32.0	16.0	16.0	4	1427 2.490	6018 2.490	9.00	10.00	125.0	86.0	36.0	6	6	1427 9.000	6018 9.000
2.50	4.00	60.0	32.0	16.0	16.0	4	1427 2.500	6018 2.500	9.97	10.00	133.0	93.0	38.0	6	6	1427 9.970	6018 9.970
2.51	4.00	60.0	32.0	16.0	16.0	4	1427 2.510	6018 2.510	9.98	10.00	133.0	93.0	38.0	6	6	1427 9.980	6018 9.980
2.52	4.00	60.0	32.0	16.0	16.0	4	1427 2.520	6018 2.520	9.99	10.00	133.0	93.0	38.0	6	6	1427 9.990	6018 9.990
2.53	4.00	60.0	32.0	16.0	16.0	4	1427 2.530	6018 2.530	10.00	10.00	133.0	93.0	38.0	6	6	1427 10.000	6018 10.000
2.97	4.00	64.0	36.0	17.0	17.0	6	1427 2.970	6018 2.970	10.01	10.00	133.0	93.0	38.0	6	6	1427 10.010	6018 10.010
2.98	4.00	64.0	36.0	17.0	17.0	6	1427 2.980	6018 2.980	10.02	10.00	133.0	93.0	38.0	6	6	1427 10.020	6018 10.020
2.99	4.00	64.0	36.0	17.0	17.0	6	1427 2.990	6018 2.990	10.03	10.00	133.0	93.0	38.0	6	6	1427 10.030	6018 10.030
3.00	4.00	64.0	36.0	17.0	17.0	6	1427 3.000	6018 3.000	10.04	10.00	133.0	93.0	38.0	6	6	1427 10.040	6018 10.040
3.01	4.00	64.0	36.0	17.0	17.0	6	1427 3.010	6018 3.010	10.05	10.00	133.0	93.0	38.0	6	6	1427 10.050	6018 10.050
3.02	4.00	64.0	36.0	17.0	17.0	6	1427 3.020	6018 3.020	11.97	12.00	151.0	112.0	44.0	6	6	1427 11.970	6018 11.970
3.03	4.00	64.0	36.0	17.0	17.0	6	1427 3.030	6018 3.030	11.98	12.00	151.0	112.0	44.0	6	6	1427 11.980	6018 11.980
3.97	4.00	77.0	45.0	21.0	21.0	6	1427 3.970	6018 3.970	11.99	12.00	151.0	112.0	44.0	6	6	1427 11.990	6018 11.990
3.98	4.00	77.0	45.0	21.0	21.0	6	1427 3.980	6018 3.980	12.00	12.00	151.0	106.0	44.0	6	6	1427 12.000	6018 12.000
3.99	4.00	77.0	45.0	21.0	21.0	6	1427 3.990	6018 3.990	12.01	12.00	151.0	112.0	44.0	6	6	1427 12.010	6018 12.010
4.00	4.00	77.0	49.0	21.0	21.0	6	1427 4.000	6018 4.000	12.02	12.00	151.0	112.0	44.0	6	6	1427 12.020	6018 12.020
4.01	4.00	77.0	45.0	21.0	21.0	6	1427 4.010	6018 4.010	12.03	12.00	151.0	112.0	44.0	6	6	1427 12.030	6018 12.030
4.02	4.00	77.0	45.0	21.0	21.0	6	1427 4.020	6018 4.020	12.04	12.00	151.0	112.0	44.0	6	6	1427 12.040	6018 12.040
4.03	4.00	77.0	45.0	21.0	21.0	6	1427 4.030	6018 4.030	12.05	12.00	151.0	112.0	44.0	6	6	1427 12.050	6018 12.050
4.97	6.00	93.0	62.0	26.0	26.0	6	1427 4.970	6018 4.970									
4.98	6.00	93.0	62.0	26.0	26.0	6	1427 4.980	6018 4.980									
4.99	6.00	93.0	62.0	26.0	26.0	6	1427 4.990	6018 4.990									
5.00	6.00	93.0	62.0	26.0	26.0	6	1427 5.000	6018 5.000									



Machine reamers

Article no. 717



Cutting data page 1044



P	M	K	N	S	H
●	○	●	●	○	○

extremely unequal flute spacing • external internal coolant supply, no outlet • H7 series in accordance with DIN 1420
 • monolithic, brazed • shank tolerance ≤ h9

Machine reamers

Article no. 718



Cutting data page 1044



P	M	K	N	S	H
●	○	●	●	○	○

extremely unequal flute spacing • external internal coolant supply, no outlet • H7 series in accordance with DIN 1420
 • monolithic, brazed • shank tolerance ≤ h9

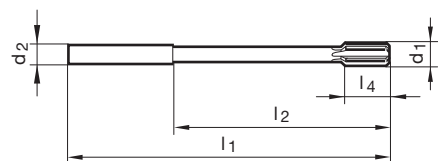

Article no. 717 718

d1 mm	d2 h6 mm	l1 mm	l2 mm	l4 mm	Z	Order no.	
5.00	5.00	86.0	52.0	12.0	6	717 5.000	718 5.000
5.85	5.60	93.0	57.0	12.0	6	717 5.850	
6.00	5.60	93.0	57.0	12.0	6	717 6.000	718 6.000
7.00	7.10	109.0	69.0	16.0	6	717 7.000	718 7.000
8.00	8.00	117.0	75.0	16.0	6	717 8.000	718 8.000
9.00	9.00	125.0	81.0	19.0	6	717 9.000	718 9.000
10.00	10.00	133.0	87.0	12.0	6	717 10.000	718 10.000
11.00	10.00	142.0	96.0	12.0	6	717 11.000	718 11.000
12.00	10.00	151.0	105.0	12.0	6	717 12.000	718 12.000
12.35	10.00	151.0	105.0	12.0	6		718 12.350
13.00	10.00	151.0	105.0	12.0	6	717 13.000	718 13.000
14.00	12.00	160.0	110.0	16.0	6	717 14.000	718 14.000
15.00	12.00	162.0	112.0	16.0	6	717 15.000	718 15.000
16.00	12.00	170.0	120.0	19.0	6	717 16.000	718 16.000
17.00	14.00	175.0	123.0	19.0	6	717 17.000	718 17.000
18.00	14.00	182.0	130.0	19.0	6	717 18.000	718 18.000
18.89	16.00	189.0	131.0	19.0	6	717 18.890	
19.00	16.00	189.0	131.0	19.0	6		718 19.000
20.00	16.00	195.0	137.0	19.0	6	717 20.000	718 20.000

Carbide machine reamers



Machine reamers

Article no. **1408**



Cutting data page 1044



unequal – extremely unequal pitch • external internal coolant supply, no outlet • H7 series in accordance with DIN 1420
 • monolithic, brazed • shank tolerance $\leq h9$

Machine reamers

Article no. **1409**



Cutting data page 1044



unequal – extremely unequal pitch • external internal coolant supply, no outlet • H7 series in accordance with DIN 1420
 • monolithic, brazed • shank tolerance $\leq h9$

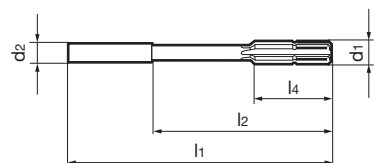

Carbide machine reamers

Article no.

1408

1409

d1 mm	d2 h6 mm	l1 mm	l2 mm	l4 mm	Z	Order no.	
1.00	1.00	34.0	15.0	5.5	3	1408 1.000	1409 1.000
1.20	1.20	38.0	16.5	7.5	3	1408 1.200	1409 1.200
1.40	1.40	40.0	18.0	8.0	3	1408 1.400	1409 1.400
1.50	1.50	40.0	18.0	8.0	3	1408 1.500	1409 1.500
1.60	1.60	43.0	20.0	9.0	3	1408 1.600	1409 1.600
1.80	1.80	46.0	22.0	10.0	4	1408 1.800	1409 1.800
2.00	2.00	49.0	24.0	11.0	4	1408 2.000	1409 2.000
2.20	2.20	53.0	25.0	12.0	4	1408 2.200	1409 2.200
2.50	2.50	57.0	29.0	14.0	4	1408 2.500	1409 2.500
2.80	2.80	61.0	33.0	15.0	4	1408 2.800	1409 2.800
3.00	3.00	61.0	33.0	15.0	6	1408 3.000	1409 3.000
3.20	3.20	65.0	37.0	16.0	6	1408 3.200	1409 3.200
3.50	3.50	70.0	42.0	18.0	6	1408 3.500	1409 3.500
4.00	4.00	75.0	43.0	19.0	6	1408 4.000	1409 4.000
4.50	4.50	80.0	47.0	21.0	6	1408 4.500	1409 4.500
5.00	5.00	86.0	52.0	23.0	6	1408 5.000	1409 5.000
5.50	5.60	93.0	57.0	26.0	6	1408 5.500	1409 5.500
6.00	5.60	93.0	57.0	26.0	6	1408 6.000	1409 6.000
6.50	6.30	101.0	63.0	28.0	6	1408 6.500	1409 6.500
7.00	7.10	109.0	69.0	31.0	6	1408 7.000	1409 7.000
7.50	7.10	109.0	69.0	31.0	6	1408 7.500	1409 7.500
8.00	8.00	117.0	75.0	33.0	6	1408 8.000	1409 8.000
8.50	8.00	117.0	75.0	33.0	6	1408 8.500	1409 8.500
8.72	9.00	125.0	81.0	36.0	6	1408 8.720	
9.00	9.00	125.0	81.0	36.0	6	1408 9.000	1409 9.000
9.50	9.00	125.0	81.0	36.0	6	1408 9.500	1409 9.500
10.00	10.00	133.0	87.0	38.0	6	1408 10.000	1409 10.000
10.50	10.00	133.0	87.0	38.0	6	1408 10.500	1409 10.500
11.00	10.00	142.0	96.0	41.0	6	1408 11.000	1409 11.000
12.00	10.00	151.0	105.0	44.0	6	1408 12.000	1409 12.000
12.35	10.00	151.0	105.0	44.0	6	1408 12.350	
13.00	10.00	151.0	105.0	44.0	6	1408 13.000	1409 13.000
14.00	12.00	160.0	110.0	47.0	6	1408 14.000	1409 14.000
15.00	12.00	162.0	112.0	50.0	6		1409 15.000
16.00	12.00	170.0	120.0	52.0	6	1408 16.000	1409 16.000
17.00	14.00	175.0	123.0	54.0	6	1408 17.000	1409 17.000
18.00	14.00	182.0	130.0	56.0	6	1408 18.000	1409 18.000
19.00	16.00	189.0	131.0	58.0	6	1408 19.000	1409 19.000
20.00	16.00	195.0	137.0	60.0	6	1408 20.000	1409 20.000



Machine reamers

Article no. 1410



Cutting data page 1044



P	M	K	N	S	H
●	○	●	●	○	

unequal – extremely unequal pitch • external internal coolant supply, no outlet • H7 series in accordance with DIN 1420
• monolithic, brazed

Machine reamers

Article no. 1411



Cutting data page 1044



P	M	K	N	S	H
●	○	●	●	○	

unequal – extremely unequal pitch • external internal coolant supply, no outlet • H7 series in accordance with DIN 1420
• monolithic, brazed

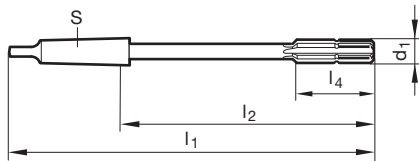

Article no.

1410

1411

d1 mm	S	l1 mm	l2 mm	l4 mm	Z	Order no.	
						1410	1411
5.00	MK-1	133.0	67.5	23.0	6	1410 5.000	1411 5.000
6.00	MK-1	138.0	72.5	26.0	6	1410 6.000	1411 6.000
7.00	MK-1	150.0	84.5	31.0	6	1410 7.000	1411 7.000
8.00	MK-1	156.0	90.5	33.0	6	1410 8.000	1411 8.000
9.00	MK-1	162.0	96.5	36.0	6	1410 9.000	1411 9.000
10.00	MK-1	168.0	102.5	38.0	6	1410 10.000	1411 10.000
11.00	MK-1	175.0	109.5	41.0	6	1410 11.000	1411 11.000
12.00	MK-1	182.0	116.5	44.0	6	1410 12.000	1411 12.000
13.00	MK-1	182.0	116.5	44.0	6	1410 13.000	1411 13.000
14.00	MK-1	189.0	123.5	47.0	6	1410 14.000	1411 14.000
15.00	MK-2	204.0	124.0	50.0	6	1410 15.000	1411 15.000
16.00	MK-2	210.0	130.0	52.0	6	1410 16.000	1411 16.000
17.00	MK-2	214.0	134.0	54.0	6	1410 17.000	1411 17.000
18.00	MK-2	219.0	139.0	56.0	6	1410 18.000	1411 18.000
19.00	MK-2	223.0	143.0	58.0	6	1410 19.000	1411 19.000
20.00	MK-2	228.0	148.0	60.0	6	1410 20.000	1411 20.000
21.00	MK-2	232.0	152.0	62.0	6	1410 21.000	1411 21.000
22.00	MK-2	237.0	157.0	64.0	6	1410 22.000	1411 22.000
23.00	MK-2	241.0	161.0	66.0	6	1410 23.000	1411 23.000
24.00	MK-3	268.0	169.0	68.0	8	1410 24.000	1411 24.000
25.00	MK-3	268.0	169.0	68.0	8	1410 25.000	1411 25.000
26.00	MK-3	273.0	174.0	70.0	8	1410 26.000	1411 26.000
27.00	MK-3	277.0	178.0	71.0	8	1410 27.000	1411 27.000
28.00	MK-3	277.0	178.0	71.0	8	1410 28.000	1411 28.000
30.00	MK-3	281.0	182.0	73.0	8	1410 30.000	1411 30.000
32.00	MK-4	317.0	193.0	77.0	8	1410 32.000	1411 32.000
34.00	MK-4	321.0	197.0	78.0	8		1411 34.000
35.00	MK-4	321.0	197.0	78.0	8		1411 35.000
36.00	MK-4	325.0	201.0	79.0	8		1411 36.000
38.00	MK-4	329.0	205.0	81.0	8	1410 38.000	1411 38.000
40.00	MK-4	329.0	205.0	81.0	8	1410 40.000	1411 40.000

Carbide machine reamers



Carbide reamers

Machine reamers

Article no. **674**



Cutting data page 1045



P	M	K	N	S	H
●	○	●	●	○	

unequal – extremely unequal pitch • external internal coolant supply, no outlet • H7 series in accordance with DIN 1420
 • monolithic, brazed • shank tolerance ≤ h9

Machine reamers

Article no. **1407**



Cutting data page 1045



P	M	K	N	S	H
●	○	●	●	○	

unequal – extremely unequal pitch • external internal coolant supply, no outlet • H7 series in accordance with DIN 1420
 • monolithic, brazed • shank tolerance ≤ h9

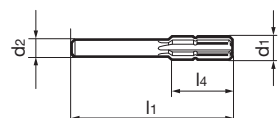

Carbide machine reamers

Article no.

674

1407

d1 mm	d2 h8 mm	l1 mm	l4 mm	Z	Order no.
3.00	2.50	56	20	6	1407 3.000
3.20	2.80	56	20	6	1407 3.200
3.50	3.00	56	20	6	1407 3.500
4.00	3.55	56	20	6	674 4.000 1407 4.000
4.50	4.00	63	22	6	674 4.500 1407 4.500
5.00	4.00	63	22	6	674 5.000 1407 5.000
5.50	5.00	63	22	6	674 5.500 1407 5.500
6.00	5.00	63	22	6	674 6.000 1407 6.000
6.50	5.00	63	22	6	674 6.500 1407 6.500
7.00	6.30	71	25	6	674 7.000 1407 7.000
7.50	6.30	71	25	6	1407 7.500
8.00	6.30	71	25	6	674 8.000 1407 8.000
8.50	6.30	71	25	6	674 8.500
9.00	8.00	71	25	6	674 9.000 1407 9.000
10.00	8.00	71	25	6	674 10.000 1407 10.000
10.50	8.00	71	25	6	674 10.500 1407 10.500
11.00	10.00	80	28	6	674 11.000 1407 11.000
11.50	10.00	80	28	6	674 11.500 1407 11.500
12.00	10.00	80	28	6	674 12.000 1407 12.000
12.50	10.00	80	28	6	674 12.500
13.50	12.50	90	32	6	674 13.500 1407 13.500
14.00	12.50	90	32	6	674 14.000 1407 14.000
15.00	12.50	90	32	6	674 15.000 1407 15.000
15.50	12.50	90	32	6	1407 15.500
16.00	12.50	90	32	6	1407 16.000
17.00	12.50	90	32	6	1407 17.000
19.00	16.00	100	36	6	1407 19.000
20.00	16.00	100	36	6	1407 20.000



Expanding machine reamers

Article no. 749



Cutting data page 1046



carbide-tipped • external internal coolant supply, no outlet • H7 series in accordance with DIN 1420 • fine adjustment via expansion screw

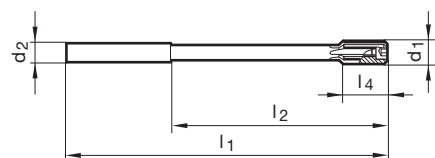

Article no.

749

d1 mm	d2 h6 mm	l1 mm	l2 mm	l4 mm	Z	Order no.
8.00	8.00	117.0	75.0	12.0	4	749 8.000
9.00	10.00	125.0	79.0	12.0	6	749 9.000
10.00	10.00	133.0	87.0	12.0	6	749 10.000
11.00	10.00	142.0	96.0	12.0	6	749 11.000
12.00	10.00	151.0	105.0	12.0	6	749 12.000
13.00	10.00	151.0	105.0	12.0	6	749 13.000
14.00	12.00	160.0	110.0	16.0	6	749 14.000
15.00	12.00	162.0	112.0	16.0	6	749 15.000
16.00	12.00	170.0	120.0	19.0	6	749 16.000
18.00	14.00	182.0	130.0	19.0	6	749 18.000
19.00	16.00	189.0	189.0	19.0	6	749 19.000
20.00	16.00	195.0	137.0	19.0	6	749 20.000

Expanding machine reamers

Article no. 740



Cutting data page 1046



carbide-tipped • external internal coolant supply, no outlet • H7 series in accordance with DIN 1420 • fine adjustment via expansion screw

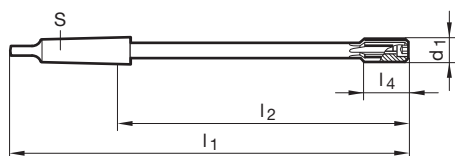

Article no.

740

d1 mm	S	l1 mm	l2 mm	l4 mm	Z	Order no.
8.00	MK-1	156.0	90.5	12.0	4	740 8.000
9.00	MK-1	162.0	96.5	12.0	6	740 9.000
10.00	MK-1	168.0	102.5	12.0	6	740 10.000
11.00	MK-1	175.0	109.5	12.0	6	740 11.000
12.00	MK-1	182.0	116.5	12.0	6	740 12.000
14.00	MK-1	189.0	123.5	16.0	6	740 14.000
15.00	MK-2	204.0	124.0	16.0	6	740 15.000
16.00	MK-2	210.0	130.0	19.0	6	740 16.000
19.00	MK-2	223.0	143.0	19.0	6	740 19.000
20.00	MK-2	228.0	148.0	19.0	6	740 20.000
22.00	MK-2	237.0	157.0	22.0	6	740 22.000
25.00	MK-3	268.0	169.0	22.0	6	740 25.000
28.00	MK-3	277.0	178.0	25.0	6	740 28.000
30.00	MK-3	281.0	182.0	25.0	6	740 30.000
34.00	MK-4	321.0	197.0	25.0	8	740 34.000
38.00	MK-4	329.0	205.0	25.0	8	740 38.000



NC machine reamers

Article no. **490**



Cutting data page 1047



> Ø 3.75 mm with internal centres on both ends • ≤ Ø 3.75 mm with external centres on both ends • chamfer lead can also be used for blind holes, to do this, remove chips

NC machine reamers

Article no. **455**

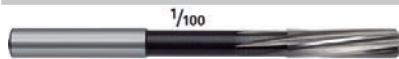

Cutting data page 1047



manufacturing tolerance: ≤ Ø 5.50 mm: 0.000/+0.004 • > Ø 5.50 mm: 0.000/+0.005 • ≤ Ø 3.75 mm with external centres on both ends • > Ø 3.75 mm with internal centres on both ends • chamfer lead can also be used for blind holes, to do this, remove chips

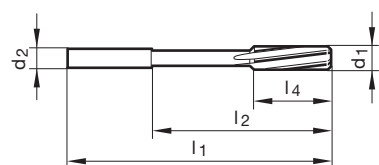

HSS-E machine reamers

Article no. 490							Article no. 455						
d1 mm	d2 mm	h6 mm	l1 mm	l2 mm	l4 mm	Z	Order no.						
1.00	1.00		34.0	15.0	5.5	3	455 1.000						
1.01	1.00		34.0	15.0	5.5	3	455 1.010						
1.02	1.00		34.0	15.0	5.5	3	455 1.020						
1.03	1.00		34.0	15.0	5.5	3	455 1.030						
1.50	2.00		40.0	18.0	8.0	3	490 1.500	455 1.500					
1.51	2.00		43.0	20.0	9.0	3	455 1.510						
1.52	2.00		43.0	20.0	9.0	3	455 1.520						
1.53	2.00		43.0	20.0	9.0	3	455 1.530						
1.60	2.00		43.0	20.0	9.0	3	490 1.600						
1.70	2.00		43.0	20.0	9.0	3	490 1.700						
1.80	2.00		46.0	22.0	10.0	4	490 1.800						
1.90	2.00		46.0	22.0	10.0	4	490 1.900						
1.97	2.00		49.0	24.0	11.0	4	455 1.970						
1.98	2.00		49.0	24.0	11.0	4	455 1.980						
1.99	2.00		49.0	24.0	11.0	4	455 1.990						
2.00	2.00		49.0	24.0	11.0	4	490 2.000	455 2.000					
2.01	2.00		49.0	24.0	11.0	4	455 2.010						
2.02	2.00		49.0	24.0	11.0	4	455 2.020						
2.03	2.00		49.0	24.0	11.0	4	455 2.030						
2.10	2.00		49.0	24.0	11.0	4	490 2.100						
2.20	3.00		53.0	25.0	12.0	4	490 2.200						
2.30	3.00		53.0	25.0	12.0	4	490 2.300						
2.40	3.00		57.0	29.0	14.0	4	490 2.400						
2.47	3.00		57.0	29.0	14.0	4	455 2.470						
2.48	3.00		57.0	29.0	14.0	4	455 2.480						
2.49	3.00		57.0	29.0	14.0	4	455 2.490						
2.50	3.00		57.0	29.0	14.0	4	490 2.500	455 2.500					
2.51	3.00		57.0	29.0	14.0	4	455 2.510						
2.52	3.00		57.0	29.0	14.0	4	455 2.520						
2.53	3.00		57.0	29.0	14.0	4	455 2.530						
2.60	3.00		57.0	29.0	14.0	4	490 2.600						
2.70	3.00		61.0	33.0	15.0	6	490 2.700						
2.80	3.00		61.0	33.0	15.0	6	490 2.800						
2.90	3.00		61.0	33.0	15.0	6	490 2.900						
2.97	3.00		61.0	33.0	15.0	6	455 2.970						
2.98	3.00		61.0	33.0	15.0	6	455 2.980						
2.99	3.00		61.0	33.0	15.0	6	455 2.990						
3.00	3.00		61.0	33.0	15.0	6	490 3.000	455 3.000					
3.01	4.00		65.0	37.0	16.0	6	455 3.010						
3.02	4.00		65.0	37.0	16.0	6	455 3.020						
3.03	4.00		65.0	37.0	16.0	6	455 3.030						
3.10	4.00		65.0	37.0	16.0	6	490 3.100						
3.20	4.00		65.0	37.0	16.0	6	490 3.200						
3.30	4.00		65.0	37.0	16.0	6	490 3.300						
3.40	4.00		70.0	42.0	18.0	6	490 3.400						
3.50	4.00		70.0	42.0	18.0	6	490 3.500						
3.60	4.00		70.0	42.0	18.0	6	490 3.600						
3.70	4.00		70.0	42.0	18.0	6	490 3.700						
3.80	4.00		75.0	47.0	19.0	6	490 3.800						
3.90	4.00		75.0	47.0	19.0	6	490 3.900						
3.97	4.00		75.0	47.0	19.0	6	455 3.970						
3.98	4.00		75.0	47.0	19.0	6	455 3.980						
3.99	4.00		75.0	47.0	19.0	6	455 3.990						
4.00	4.00		75.0	47.0	19.0	6	490 4.000	455 4.000					
4.01	4.00		75.0	47.0	19.0	6	455 4.010						
4.02	4.00		75.0	47.0	19.0	6	455 4.020						
4.03	4.00		75.0	47.0	19.0	6	455 4.030						
4.10	4.00		75.0	47.0	19.0	6	490 4.100						
4.20	4.00		75.0	47.0	19.0	6	490 4.200						
4.30	5.00		80.0	52.0	21.0	6	490 4.300						
4.40	5.00		80.0	52.0	21.0	6	490 4.400						
4.50	5.00		80.0	52.0	21.0	6	490 4.500						
4.60	5.00		80.0	52.0	21.0	6	490 4.600						
4.70	5.00		80.0	52.0	21.0	6	490 4.700						
4.80	5.00		86.0	58.0	23.0	6	490 4.800						
4.90	5.00		86.0	58.0	23.0	6	490 4.900						
4.97	5.00		86.0	58.0	23.0	6	455 4.970						
4.98	5.00		86.0	58.0	23.0	6	455 4.980						
4.99	5.00		86.0	58.0	23.0	6	455 4.990						
5.00	5.00		86.0	58.0	23.0	6	490 5.000	455 5.000					
5.01	5.00		86.0	58.0	23.0	6	455 5.010						
5.02	5.00		86.0	58.0	23.0	6	455 5.020						
5.03	5.00		86.0	58.0	23.0	6	455 5.030						
5.10	5.00		86.0	58.0	23.0	6	490 5.100						
5.20	5.00		86.0	58.0	23.0	6	490 5.200						
5.30	5.00		86.0	58.0	23.0	6	490 5.300						
5.40	6.00		93.0	57.0	26.0	6	490 5.400						
5.50	6.00		93.0	57.0	26.0	6	490 5.500						
5.60	6.00		93.0	57.0	26.0	6	490 5.600						
5.70	6.00		93.0	57.0	26.0	6	490 5.700						
5.80	6.00		93.0	57.0	26.0	6	490 5.800						
5.90	6.00		93.0	57.0	26.0	6	490 5.900						
5.97	6.00		93.0	57.0	26.0	6	455 5.970						
5.98	6.00		93.0	57.0	26.0	6	455 5.980						
5.99	6.00		93.0	57.0	26.0	6	455 5.990						
6.00	6.00		93.0	57.0	26.0	6	490 6.000	455 6.000					
6.01	6.00		101.0	65.0	28.0	6	455 6.010						
6.02	6.00		101.0	65.0	28.0	6	455 6.020						
6.03	6.00		101.0	65.0	28.0	6	455 6.030						
6.10	6.00		101.0	65.0	28.0	6	490 6.100						
6.20	6.00		101.0	65.0	28.0	6	490 6.200						
6.30	6.00		101.0	65.0	28.0	6	490 6.300						
6.40	6.00		101.0	65.0	28.0	6	490 6.400						
6.50	6.00		101.0	65.0	28.0	6	490 6.500						
6.60	6.00		101.0	65.0	28.0	6	490 6.600						
6.70	6.00		101.0	65.0	28.0	6	490 6.700						
6.80	8.00		109.0	73.0	31.0	6	490 6.800						
6.90	8.00		109.0	73.0	31.0	6	490 6.900						
7.00	8.00		109.0	73.0	31.0	6	490 7.000						
7.10	8.00		109.0	73.0	31.0	6	490 7.100						
7.20	8.00		109.0	73.0	31.0	6	490 7.200						
7.30	8.00		109.0	73.0	31.0	6	490 7.300						
7.40	8.00		109.0	73.0	31.0	6	490 7.400						
7.50	8.00		109.0	73.0	31.0	6	490 7.500						
7.60	8.00		117.0	81.0	33.0	6	490 7.600						
7.70	8.00		117.0	81.0	33.0	6	490 7.700						
7.80	8.00		117.0	81.0	33.0	6	490 7.800						
7.90	8.00		117.0	81.0	33.0	6	490 7.900						



Article no.						490	455	Article no.						490	455
d1 mm	d2 h6 mm	l1 mm	l2 mm	l4 mm	Z	Order no.		d1 mm	d2 h6 mm	l1 mm	l2 mm	l4 mm	Z	Order no.	
7.97	8.00	117.0	81.0	33.0	6		455 7.970	9.98	10.00	133.0	93.0	38.0	6		455 9.980
7.98	8.00	117.0	81.0	33.0	6		455 7.980	9.99	10.00	133.0	93.0	38.0	6		455 9.990
7.99	8.00	117.0	81.0	33.0	6		455 7.990	10.00	10.00	133.0	93.0	38.0	6	490 10.000	455 10.000
8.00	8.00	117.0	81.0	33.0	6	490 8.000	455 8.000	10.01	10.00	133.0	93.0	38.0	6		455 10.010
8.01	8.00	117.0	81.0	33.0	6		455 8.010	10.02	10.00	133.0	93.0	38.0	6		455 10.020
8.02	8.00	117.0	81.0	33.0	6		455 8.020	10.03	10.00	133.0	93.0	38.0	6		455 10.030
8.03	8.00	117.0	81.0	33.0	6		455 8.030	11.00	10.00	142.0	102.0	41.0	6	490 11.000	
8.10	8.00	117.0	81.0	33.0	6	490 8.100		11.97	10.00	151.0	111.0	44.0	6		455 11.970
8.20	8.00	117.0	81.0	33.0	6	490 8.200		11.98	10.00	151.0	111.0	44.0	6		455 11.980
8.30	8.00	117.0	81.0	33.0	6	490 8.300		11.99	10.00	151.0	111.0	44.0	6		455 11.990
8.40	8.00	117.0	81.0	33.0	6	490 8.400		12.00	10.00	151.0	111.0	44.0	6	490 12.000	455 12.000
8.50	8.00	117.0	81.0	33.0	6	490 8.500		12.01	10.00	151.0	111.0	44.0	6		455 12.010
8.60	10.00	125.0	85.0	36.0	6	490 8.600		12.02	10.00	151.0	111.0	44.0	6		455 12.020
8.70	10.00	125.0	85.0	36.0	6	490 8.700		12.03	10.00	151.0	111.0	44.0	6		455 12.030
8.80	10.00	125.0	85.0	36.0	6	490 8.800		13.00	10.00	151.0	111.0	44.0	6	490 13.000	
8.90	10.00	125.0	85.0	36.0	6	490 8.900		14.00	14.00	160.0	115.0	47.0	8	490 14.000	
9.00	10.00	125.0	85.0	36.0	6	490 9.000	455 9.000	15.00	14.00	162.0	117.0	50.0	8	490 15.000	
9.01	10.00	125.0	85.0	36.0	6		455 9.010	16.00	14.00	170.0	125.0	52.0	8	490 16.000	
9.02	10.00	125.0	85.0	36.0	6		455 9.020	17.00	14.00	175.0	130.0	54.0	8	490 17.000	
9.03	10.00	125.0	85.0	36.0	6		455 9.030	18.00	14.00	182.0	137.0	56.0	8	490 18.000	
9.10	10.00	125.0	85.0	36.0	6	490 9.100		19.00	16.00	189.0	141.0	58.0	8	490 19.000	
9.20	10.00	125.0	85.0	36.0	6	490 9.200		20.00	16.00	195.0	147.0	60.0	8	490 20.000	
9.30	10.00	125.0	85.0	36.0	6	490 9.300									
9.40	10.00	125.0	85.0	36.0	6	490 9.400									
9.50	10.00	125.0	85.0	36.0	6	490 9.500									
9.60	10.00	133.0	93.0	38.0	6	490 9.600									
9.70	10.00	133.0	93.0	38.0	6	490 9.700									
9.80	10.00	133.0	93.0	38.0	6	490 9.800									
9.90	10.00	133.0	93.0	38.0	6	490 9.900									
9.97	10.00	133.0	93.0	38.0	6		455 9.970								



Machine reamers

Article no. **401**



Cutting data page 1048



P	M	K	N	S	H
•	○	•	•	•	

≤ Ø 3.75 mm with external centres on both ends • > Ø 3.75 mm with internal centres on both ends

Machine reamers

Article no. **402**



Cutting data page 1048



P	M	K	N	S	H
•	○	•	•	•	

≤ Ø 3.75 mm with external centres on both ends • > Ø 3.75 mm with internal centres on both ends

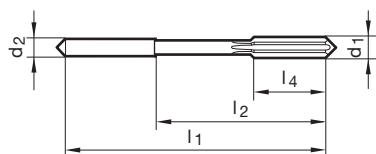

HSS-E machine reamers

Article no.							401	402	Article no.							401	402
d1 mm	d2 h9 mm	l1 mm	l2 mm	l4 mm	Z	Order no.		d1 mm	d2 h9 mm	l1 mm	l2 mm	l4 mm	Z	Order no.			
1.00	1.00	34.0	15.0	5.5	3	401 1.000	402 1.000	2.80	2.80	61.0	33.0	15.0	6	401 2.800	402 2.800		
1.10	1.10	36.0	15.5	6.5	3		402 1.100	2.90	3.00	61.0	33.0	15.0	6		402 2.900		
1.20	1.20	38.0	16.5	7.5	3	401 1.200	402 1.200	3.00	3.00	61.0	33.0	15.0	6	401 3.000	402 3.000		
1.30	1.30	38.0	16.5	7.5	3		402 1.300	3.10	3.20	65.0	37.0	16.0	6		402 3.100		
1.40	1.40	40.0	18.0	8.0	3	401 1.400	402 1.400	3.20	3.20	65.0	37.0	16.0	6	401 3.200	402 3.200		
1.50	1.50	40.0	18.0	8.0	3	401 1.500	402 1.500	3.30	3.20	65.0	37.0	16.0	6		402 3.300		
1.60	1.60	43.0	20.0	9.0	3	401 1.600	402 1.600	3.40	3.50	70.0	42.0	18.0	6		402 3.400		
1.70	1.70	43.0	20.0	9.0	3		402 1.700	3.50	3.50	70.0	42.0	18.0	6	401 3.500	402 3.500		
1.80	1.80	46.0	22.0	10.0	4	401 1.800	402 1.800	3.60	3.50	70.0	42.0	18.0	6		402 3.600		
1.90	1.90	46.0	22.0	10.0	4		402 1.900	3.70	3.50	70.0	42.0	18.0	6		402 3.700		
2.00	2.00	49.0	24.0	11.0	4	401 2.000	402 2.000										
2.10	2.10	49.0	24.0	11.0	4		402 2.100										
2.20	2.20	53.0	25.0	12.0	4	401 2.200	402 2.200										
2.30	2.30	53.0	25.0	12.0	4		402 2.300										
2.40	2.50	57.0	29.0	14.0	4		402 2.400										
2.50	2.50	57.0	29.0	14.0	4	401 2.500	402 2.500										
2.60	2.50	57.0	29.0	14.0	4		402 2.600										
2.70	2.80	61.0	33.0	15.0	6		402 2.700										



Machine reamers

Article no. 440



Cutting data page 1048-1049



≤ Ø 3.75 mm with external centres on both ends • > Ø 3.75 mm with internal centres on both ends

Machine reamers

Article no. 641



Cutting data page 1048-1049



≤ Ø 3.75 mm with external centres on both ends • > Ø 3.75 mm with internal centres on both ends

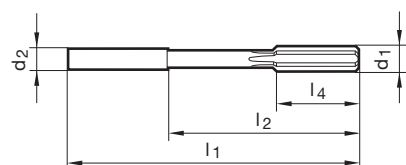

Article no. 440							Article no. 641						
d1 mm	d2 h9 mm	l1 mm	l2 mm	l4 mm	Z	Order no.	d1 mm	d2 h9 mm	l1 mm	l2 mm	l4 mm	Z	Order no.
4.00	4.00	75.0	47.0	19.0	6	440 4.000	10.50	10.00	133.0	93.0	38.0	6	440 10.500
4.50	4.50	80.0	52.0	21.0	6	440 4.500	11.00	10.00	142.0	102.0	41.0	6	440 11.000 641 11.000
5.00	5.00	86.0	58.0	23.0	6	440 5.000 641 5.000	11.50	10.00	142.0	102.0	41.0	6	440 11.500
5.50	5.60	93.0	57.0	26.0	6	440 5.500 641 5.500	12.00	10.00	151.0	111.0	44.0	6	440 12.000 641 12.000
6.00	5.60	93.0	57.0	26.0	6	440 6.000 641 6.000	13.00	10.00	151.0	111.0	44.0	6	440 13.000 641 13.000
6.50	6.30	101.0	65.0	28.0	6	440 6.500 641 6.500	14.00	12.50	160.0	115.0	47.0	8	440 14.000 641 14.000
7.00	7.10	109.0	73.0	31.0	6	440 7.000 641 7.000	15.00	12.50	162.0	117.0	50.0	8	440 15.000 641 15.000
8.00	8.00	117.0	81.0	33.0	6	440 8.000 641 8.000	16.00	12.50	170.0	125.0	52.0	8	440 16.000 641 16.000
8.50	8.00	117.0	81.0	33.0	6	440 8.500	17.00	14.00	175.0	130.0	54.0	8	440 17.000
9.00	9.00	125.0	85.0	36.0	6	440 9.000 641 9.000	18.00	14.00	182.0	137.0	56.0	8	440 18.000 641 18.000
9.50	9.00	125.0	85.0	36.0	6	440 9.500	19.00	16.00	189.0	141.0	58.0	8	440 19.000
10.00	10.00	133.0	93.0	38.0	6	440 10.000 641 10.000	20.00	16.00	195.0	147.0	60.0	8	440 20.000 641 20.000

HSS-E machine reamers



Machine reamers

Article no. **468**



Cutting data page 1048



≤ Ø 3.75 mm with external centres on both ends • > Ø 3.75 mm with internal centres on both ends

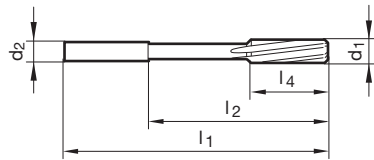

HSS-E machine reamers

Article no. 468							Article no. 468								
d1	d2	h9	l1	l2	l4	Z	Order no.	d1	d2	h9	l1	l2	l4	Z	Order no.
3.80	4.00	75.0	47.0	19.0	19.0	6	468 3.800	8.00	8.00	117.0	81.0	33.0	6	468 8.000	
3.90	4.00	75.0	47.0	19.0	19.0	6	468 3.900	8.10	8.00	117.0	81.0	33.0	6	468 8.100	
4.00	4.00	75.0	47.0	19.0	19.0	6	468 4.000	8.20	8.00	117.0	81.0	33.0	6	468 8.200	
4.10	4.00	75.0	47.0	19.0	19.0	6	468 4.100	8.30	8.00	117.0	81.0	33.0	6	468 8.300	
4.20	4.00	75.0	47.0	19.0	19.0	6	468 4.200	8.40	8.00	117.0	81.0	33.0	6	468 8.400	
4.30	4.50	80.0	52.0	21.0	21.0	6	468 4.300	8.50	8.00	117.0	81.0	33.0	6	468 8.500	
4.40	4.50	80.0	52.0	21.0	21.0	6	468 4.400	8.60	9.00	125.0	85.0	36.0	6	468 8.600	
4.50	4.50	80.0	52.0	21.0	21.0	6	468 4.500	8.70	9.00	125.0	85.0	36.0	6	468 8.700	
4.60	4.50	80.0	52.0	21.0	21.0	6	468 4.600	8.80	9.00	125.0	85.0	36.0	6	468 8.800	
4.70	4.50	80.0	52.0	21.0	21.0	6	468 4.700	8.90	9.00	125.0	85.0	36.0	6	468 8.900	
4.80	5.00	86.0	58.0	23.0	23.0	6	468 4.800	9.00	9.00	125.0	85.0	36.0	6	468 9.000	
4.90	5.00	86.0	58.0	23.0	23.0	6	468 4.900	9.10	9.00	125.0	85.0	36.0	6	468 9.100	
5.00	5.00	86.0	58.0	23.0	23.0	6	468 5.000	9.20	9.00	125.0	85.0	36.0	6	468 9.200	
5.10	5.00	86.0	58.0	23.0	23.0	6	468 5.100	9.30	9.00	125.0	85.0	36.0	6	468 9.300	
5.20	5.00	86.0	58.0	23.0	23.0	6	468 5.200	9.40	9.00	125.0	85.0	36.0	6	468 9.400	
5.30	5.00	86.0	58.0	23.0	23.0	6	468 5.300	9.50	9.00	125.0	85.0	36.0	6	468 9.500	
5.40	5.60	93.0	57.0	26.0	26.0	6	468 5.400	9.60	10.00	133.0	93.0	38.0	6	468 9.600	
5.50	5.60	93.0	57.0	26.0	26.0	6	468 5.500	9.70	10.00	133.0	93.0	38.0	6	468 9.700	
5.60	5.60	93.0	57.0	26.0	26.0	6	468 5.600	9.80	10.00	133.0	93.0	38.0	6	468 9.800	
5.70	5.60	93.0	57.0	26.0	26.0	6	468 5.700	9.90	10.00	133.0	93.0	38.0	6	468 9.900	
5.80	5.60	93.0	57.0	26.0	26.0	6	468 5.800	10.00	10.00	133.0	93.0	38.0	6	468 10.000	
5.90	5.60	93.0	57.0	26.0	26.0	6	468 5.900	10.10	10.00	133.0	93.0	38.0	6	468 10.100	
6.00	5.60	93.0	57.0	26.0	26.0	6	468 6.000	10.20	10.00	133.0	93.0	38.0	6	468 10.200	
6.10	6.30	101.0	65.0	28.0	28.0	6	468 6.100	10.30	10.00	133.0	93.0	38.0	6	468 10.300	
6.20	6.30	101.0	65.0	28.0	28.0	6	468 6.200	10.40	10.00	133.0	93.0	38.0	6	468 10.400	
6.30	6.30	101.0	65.0	28.0	28.0	6	468 6.300	10.70	10.00	142.0	102.0	41.0	6	468 10.700	
6.40	6.30	101.0	65.0	28.0	28.0	6	468 6.400	10.80	10.00	142.0	102.0	41.0	6	468 10.800	
6.50	6.30	101.0	65.0	28.0	28.0	6	468 6.500	11.00	10.00	142.0	102.0	41.0	6	468 11.000	
6.60	6.30	101.0	65.0	28.0	28.0	6	468 6.600	11.50	10.00	142.0	102.0	41.0	6	468 11.500	
6.70	6.30	101.0	65.0	28.0	28.0	6	468 6.700	11.90	10.00	151.0	111.0	44.0	6	468 11.900	
6.80	7.10	109.0	73.0	31.0	31.0	6	468 6.800	12.00	10.00	151.0	111.0	44.0	6	468 12.000	
6.90	7.10	109.0	73.0	31.0	31.0	6	468 6.900	13.00	10.00	151.0	111.0	44.0	6	468 13.000	
7.00	7.10	109.0	73.0	31.0	31.0	6	468 7.000	14.00	12.50	160.0	115.0	47.0	8	468 14.000	
7.10	7.10	109.0	73.0	31.0	31.0	6	468 7.100	15.00	12.50	162.0	117.0	50.0	8	468 15.000	
7.20	7.10	109.0	73.0	31.0	31.0	6	468 7.200	16.00	12.50	170.0	125.0	52.0	8	468 16.000	
7.30	7.10	109.0	73.0	31.0	31.0	6	468 7.300	17.00	14.00	175.0	130.0	54.0	8	468 17.000	
7.40	7.10	109.0	73.0	31.0	31.0	6	468 7.400	18.00	14.00	182.0	137.0	56.0	8	468 18.000	
7.50	7.10	109.0	73.0	31.0	31.0	6	468 7.500	19.00	16.00	189.0	141.0	58.0	8	468 19.000	
7.60	8.00	117.0	81.0	33.0	33.0	6	468 7.600	20.00	16.00	195.0	147.0	60.0	8	468 20.000	
7.70	8.00	117.0	81.0	33.0	33.0	6	468 7.700								
7.80	8.00	117.0	81.0	33.0	33.0	6	468 7.800								
7.90	8.00	117.0	81.0	33.0	33.0	6	468 7.900								



Machine reamers

Article no. 496



Cutting data page 1048



manufacturing tolerance: ≤ Ø 5.50 mm: 0.000/+0.004 • > Ø 5.50 mm: 0.000/+0.005 • ≤ Ø 3.75 mm with external centres on both ends • > Ø 3.75 mm with internal centres on both ends • Ø in increments of 0.01 mm

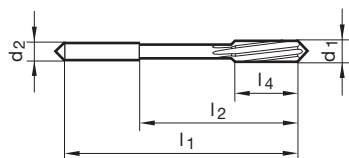

Article no. 496							Article no. 496								
d1	d2	h9	l1	l2	l4	Z	Order no.	d1	d2	h9	l1	l2	l4	Z	Order no.
mm	mm	mm	mm	mm	mm			mm	mm	mm	mm	mm	mm		
0.95	1.00	34.0	15.0	5.5	3	496 0.950	1.61	1.60	43.0	20.0	9.0	3	496 1.610		
0.96	1.00	34.0	15.0	5.5	3	496 0.960	1.62	1.60	43.0	20.0	9.0	3	496 1.620		
0.97	1.00	34.0	15.0	5.5	3	496 0.970	1.63	1.60	43.0	20.0	9.0	3	496 1.630		
0.98	1.00	34.0	15.0	5.5	3	496 0.980	1.64	1.60	43.0	20.0	9.0	3	496 1.640		
0.99	1.00	34.0	15.0	5.5	3	496 0.990	1.65	1.60	43.0	20.0	9.0	3	496 1.650		
1.00	1.00	34.0	15.0	5.5	3	496 1.000	1.66	1.60	43.0	20.0	9.0	3	496 1.660		
1.01	1.00	34.0	15.0	5.5	3	496 1.010	1.67	1.60	43.0	20.0	9.0	3	496 1.670		
1.02	1.00	34.0	15.0	5.5	3	496 1.020	1.68	1.60	43.0	20.0	9.0	3	496 1.680		
1.03	1.00	34.0	15.0	5.5	3	496 1.030	1.69	1.60	43.0	20.0	9.0	3	496 1.690		
1.04	1.00	34.0	15.0	5.5	3	496 1.040	1.70	1.60	43.0	20.0	9.0	3	496 1.700		
1.05	1.00	34.0	15.0	5.5	3	496 1.050	1.71	1.80	46.0	22.0	10.0	4	496 1.710		
1.06	1.00	34.0	15.0	5.5	3	496 1.060	1.72	1.80	46.0	22.0	10.0	4	496 1.720		
1.07	1.10	36.0	15.5	6.5	3	496 1.070	1.73	1.80	46.0	22.0	10.0	4	496 1.730		
1.08	1.10	36.0	15.5	6.5	3	496 1.080	1.74	1.80	46.0	22.0	10.0	4	496 1.740		
1.09	1.10	36.0	15.5	6.5	3	496 1.090	1.75	1.80	46.0	22.0	10.0	4	496 1.750		
1.10	1.10	36.0	15.5	6.5	3	496 1.100	1.76	1.80	46.0	22.0	10.0	4	496 1.760		
1.11	1.10	36.0	15.5	6.5	3	496 1.110	1.77	1.80	46.0	22.0	10.0	4	496 1.770		
1.12	1.10	36.0	15.5	6.5	3	496 1.120	1.78	1.80	46.0	22.0	10.0	4	496 1.780		
1.13	1.10	36.0	15.5	6.5	3	496 1.130	1.79	1.80	46.0	22.0	10.0	4	496 1.790		
1.14	1.10	36.0	15.5	6.5	3	496 1.140	1.80	1.80	46.0	22.0	10.0	4	496 1.800		
1.15	1.10	36.0	15.5	6.5	3	496 1.150	1.81	1.80	46.0	22.0	10.0	4	496 1.810		
1.16	1.10	36.0	15.5	6.5	3	496 1.160	1.82	1.80	46.0	22.0	10.0	4	496 1.820		
1.17	1.10	36.0	15.5	6.5	3	496 1.170	1.83	1.80	46.0	22.0	10.0	4	496 1.830		
1.18	1.10	36.0	15.5	6.5	3	496 1.180	1.84	1.80	46.0	22.0	10.0	4	496 1.840		
1.19	1.20	38.0	16.5	7.5	3	496 1.190	1.85	1.80	46.0	22.0	10.0	4	496 1.850		
1.20	1.20	38.0	16.5	7.5	3	496 1.200	1.86	1.80	46.0	22.0	10.0	4	496 1.860		
1.21	1.20	38.0	16.5	7.5	3	496 1.210	1.87	1.80	46.0	22.0	10.0	4	496 1.870		
1.22	1.20	38.0	16.5	7.5	3	496 1.220	1.88	1.80	46.0	22.0	10.0	4	496 1.880		
1.23	1.20	38.0	16.5	7.5	3	496 1.230	1.89	1.80	46.0	22.0	10.0	4	496 1.890		
1.24	1.20	38.0	16.5	7.5	3	496 1.240	1.90	1.80	46.0	22.0	10.0	4	496 1.900		
1.25	1.20	38.0	16.5	7.5	3	496 1.250	1.91	2.00	49.0	24.0	11.0	4	496 1.910		
1.26	1.20	38.0	16.5	7.5	3	496 1.260	1.92	2.00	49.0	24.0	11.0	4	496 1.920		
1.27	1.20	38.0	16.5	7.5	3	496 1.270	1.93	2.00	49.0	24.0	11.0	4	496 1.930		
1.28	1.20	38.0	16.5	7.5	3	496 1.280	1.94	2.00	49.0	24.0	11.0	4	496 1.940		
1.29	1.20	38.0	16.5	7.5	3	496 1.290	1.95	2.00	49.0	24.0	11.0	4	496 1.950		
1.30	1.20	38.0	16.5	7.5	3	496 1.300	1.96	2.00	49.0	24.0	11.0	4	496 1.960		
1.31	1.20	38.0	16.5	7.5	3	496 1.310	1.97	2.00	49.0	24.0	11.0	4	496 1.970		
1.32	1.20	38.0	16.5	7.5	3	496 1.320	1.98	2.00	49.0	24.0	11.0	4	496 1.980		
1.33	1.40	40.0	18.0	8.0	3	496 1.330	1.99	2.00	49.0	24.0	11.0	4	496 1.990		
1.34	1.40	40.0	18.0	8.0	3	496 1.340	2.00	2.00	49.0	24.0	11.0	4	496 2.000		
1.35	1.40	40.0	18.0	8.0	3	496 1.350	2.01	2.00	49.0	24.0	11.0	4	496 2.010		
1.36	1.40	40.0	18.0	8.0	3	496 1.360	2.02	2.00	49.0	24.0	11.0	4	496 2.020		
1.37	1.40	40.0	18.0	8.0	3	496 1.370	2.03	2.00	49.0	24.0	11.0	4	496 2.030		
1.38	1.40	40.0	18.0	8.0	3	496 1.380	2.04	2.00	49.0	24.0	11.0	4	496 2.040		
1.39	1.40	40.0	18.0	8.0	3	496 1.390	2.05	2.00	49.0	24.0	11.0	4	496 2.050		
1.40	1.40	40.0	18.0	8.0	3	496 1.400	2.06	2.00	49.0	24.0	11.0	4	496 2.060		
1.41	1.40	40.0	18.0	8.0	3	496 1.410	2.07	2.00	49.0	24.0	11.0	4	496 2.070		
1.42	1.50	40.0	18.0	8.0	3	496 1.420	2.08	2.00	49.0	24.0	11.0	4	496 2.080		
1.43	1.50	40.0	18.0	8.0	3	496 1.430	2.09	2.00	49.0	24.0	11.0	4	496 2.090		
1.44	1.50	40.0	18.0	8.0	3	496 1.440	2.10	2.00	49.0	24.0	11.0	4	496 2.100		
1.45	1.50	40.0	18.0	8.0	3	496 1.450	2.11	2.00	49.0	24.0	11.0	4	496 2.110		
1.46	1.50	40.0	18.0	8.0	3	496 1.460	2.12	2.00	49.0	24.0	11.0	4	496 2.120		
1.47	1.50	40.0	18.0	8.0	3	496 1.470	2.13	2.20	53.0	25.0	12.0	4	496 2.130		
1.48	1.50	40.0	18.0	8.0	3	496 1.480	2.14	2.20	53.0	25.0	12.0	4	496 2.140		
1.49	1.50	40.0	18.0	8.0	3	496 1.490	2.15	2.20	53.0	25.0	12.0	4	496 2.150		
1.50	1.50	40.0	18.0	8.0	3	496 1.500	2.16	2.20	53.0	25.0	12.0	4	496 2.160		
1.51	1.60	43.0	20.0	9.0	3	496 1.510	2.17	2.20	53.0	25.0	12.0	4	496 2.170		
1.52	1.60	43.0	20.0	9.0	3	496 1.520	2.18	2.20	53.0	25.0	12.0	4	496 2.180		
1.53	1.60	43.0	20.0	9.0	3	496 1.530	2.19	2.20	53.0	25.0	12.0	4	496 2.190		
1.54	1.60	43.0	20.0	9.0	3	496 1.540	2.20	2.20	53.0	25.0	12.0	4	496 2.200		
1.55	1.60	43.0	20.0	9.0	3	496 1.550	2.21	2.20	53.0	25.0	12.0	4	496 2.210		
1.56	1.60	43.0	20.0	9.0	3	496 1.560	2.22	2.20	53.0	25.0	12.0	4	496 2.220		
1.57	1.60	43.0	20.0	9.0	3	496 1.570	2.23	2.20	53.0	25.0	12.0	4	496 2.230		
1.58	1.60	43.0	20.0	9.0	3	496 1.580	2.24	2.20	53.0	25.0	12.0	4	496 2.240		
1.59	1.60	43.0	20.0	9.0	3	496 1.590	2.25	2.20	53.0	25.0	12.0	4	496 2.250		
1.60	1.60	43.0	20.0	9.0	3	496 1.600	2.26	2.20	53.0	25.0	12.0	4	496 2.260		

HSS-E machine reamers



HSS-E reamers

Machine reamers

Article no. **404**



Cutting data page 1048



P	M	K	N	S	H
●	○	●	●	●	

Ø 3.00 mm cutting side with with external centre, shank end with internal centering • > Ø 3.00 mm with internal centres on both ends • ≤ Ø 4.00 mm to company standard

Machine reamers

Article no. **405**



Cutting data page 1048



P	M	K	N	S	H
●	○	●	●	●	

Ø 3.00 mm cutting side with with external centre, shank end with internal centering • > Ø 3.00 mm with internal centres on both ends • ≤ Ø 4.00 mm to company standard

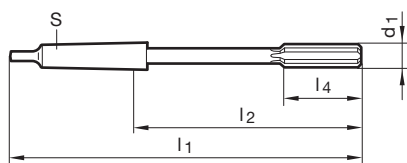

Article no.

404

405

Article no.

404

405

HSS-E machine reamers

d1 mm	S	l1 mm	l2 mm	l4 mm	Z	Order no.		d1 mm	S	l1 mm	l2 mm	l4 mm	Z	Order no.	
						404	405							404	405
3.00	MK-1	115.0	49.5	15.0	6	404 3.000	405 3.000	24.00	MK-3	268.0	169.0	68.0	8	404 24.000	405 24.000
4.00	MK-1	125.0	59.5	19.0	6	404 4.000	405 4.000	25.00	MK-3	268.0	169.0	68.0	8	404 25.000	405 25.000
5.00	MK-1	133.0	67.5	23.0	6	404 5.000	405 5.000	26.00	MK-3	273.0	174.0	70.0	8	404 26.000	405 26.000
6.00	MK-1	138.0	72.5	26.0	6	404 6.000	405 6.000	27.00	MK-3	277.0	178.0	71.0	10	404 27.000	405 27.000
7.00	MK-1	150.0	84.5	31.0	6	404 7.000	405 7.000	28.00	MK-3	277.0	178.0	71.0	10	404 28.000	405 28.000
7.50	MK-1	150.0	84.5	31.0	6	404 7.500		29.00	MK-3	281.0	182.0	73.0	10	404 29.000	405 29.000
8.00	MK-1	156.0	90.5	33.0	6	404 8.000	405 8.000	30.00	MK-3	281.0	182.0	73.0	10	404 30.000	405 30.000
9.00	MK-1	162.0	96.5	36.0	6	404 9.000	405 9.000	31.00	MK-3	285.0	186.0	75.0	10	404 31.000	405 31.000
9.80	MK-1	168.0	102.5	38.0	6	404 9.800		32.00	MK-4	317.0	193.0	77.0	10	404 32.000	405 32.000
10.00	MK-1	168.0	102.5	38.0	6	404 10.000	405 10.000	33.00	MK-4	317.0	193.0	77.0	10		405 33.000
11.00	MK-1	175.0	109.5	41.0	6	404 11.000	405 11.000	34.00	MK-4	321.0	197.0	78.0	10	404 34.000	405 34.000
12.00	MK-1	182.0	116.5	44.0	6	404 12.000	405 12.000	35.00	MK-4	321.0	197.0	78.0	10	404 35.000	405 35.000
13.00	MK-1	182.0	116.5	44.0	6	404 13.000	405 13.000	36.00	MK-4	325.0	201.0	79.0	10	404 36.000	405 36.000
14.00	MK-1	189.0	123.5	47.0	8	404 14.000	405 14.000	37.00	MK-4	325.0	201.0	79.0	10	404 37.000	405 37.000
15.00	MK-2	204.0	124.0	50.0	8	404 15.000	405 15.000	38.00	MK-4	329.0	205.0	81.0	10	404 38.000	405 38.000
15.70	MK-2	210.0	130.0	52.0	8	404 15.700		40.00	MK-4	329.0	205.0	81.0	10	404 40.000	405 40.000
16.00	MK-2	210.0	130.0	52.0	8	404 16.000	405 16.000	42.00	MK-4	333.0	209.0	82.0	12	404 42.000	405 42.000
17.00	MK-2	214.0	134.0	54.0	8	404 17.000	405 17.000	44.00	MK-4	336.0	212.0	83.0	12	404 44.000	405 44.000
18.00	MK-2	219.0	139.0	56.0	8	404 18.000	405 18.000	45.00	MK-4	336.0	212.0	83.0	12	404 45.000	405 45.000
19.00	MK-2	223.0	143.0	58.0	8	404 19.000	405 19.000	46.00	MK-4	340.0	216.0	84.0	12	404 46.000	405 46.000
20.00	MK-2	228.0	148.0	60.0	8	404 20.000	405 20.000	47.00	MK-4	340.0	216.0	84.0	12	404 47.000	405 47.000
21.00	MK-2	232.0	152.0	62.0	8	404 21.000	405 21.000	48.00	MK-4	344.0	220.0	86.0	12	404 48.000	405 48.000
22.00	MK-2	237.0	157.0	64.0	8	404 22.000	405 22.000	50.00	MK-4	344.0	220.0	86.0	12	404 50.000	405 50.000
23.00	MK-2	241.0	161.0	66.0	8	404 23.000	405 23.000								



Machine reamers with internal cooling

Article no. 1431



Cutting data page 1048



P	M	K	N	S	H
•	○	•	•	•	

≤ Ø 3.75 mm with external centres on both ends • > Ø 3.75 mm with internal centres on both ends

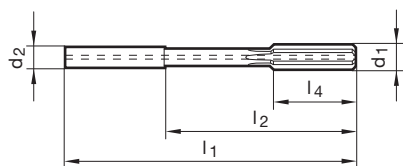

Article no. 1431

d1 mm	D mm	l1 mm	l2 mm	l4 mm	Z	Order no.
5.00	5.00	86.0	58.0	23.0	6	1431 5.000
5.50	5.60	93.0	57.0	26.0	6	1431 5.500
6.00	5.60	93.0	57.0	26.0	6	1431 6.000
6.50	6.30	101.0	65.0	28.0	6	1431 6.500
8.00	8.00	117.0	81.0	33.0	6	1431 8.000
9.50	9.00	125.0	85.0	36.0	6	1431 9.500
10.00	10.00	133.0	93.0	38.0	6	1431 10.000
11.50	10.00	142.0	102.0	41.0	6	1431 11.500
12.00	10.00	151.0	111.0	44.0	6	1431 12.000
14.00	12.50	160.0	115.0	47.0	8	1431 14.000
16.00	12.50	170.0	125.0	52.0	8	1431 16.000
17.00	14.00	175.0	130.0	54.0	8	1431 17.000
19.00	16.00	189.0	141.0	58.0	8	1431 19.000
20.00	16.00	195.0	147.0	60.0	8	1431 20.000

HSS-E machine reamers



Machine reamers

Article no. **488**



Cutting data page 1050



P	M	K	N	S	H
•	○	•	•	•	

≤ Ø 3.75 mm with external centres on both ends • > Ø 3.75 mm with internal centres on both ends

Machine reamers

Article no. **489**



Cutting data page 1050



P	M	K	N	S	H
•	○	•	•	•	

≤ Ø 3.75 mm with external centres on both ends • > Ø 3.75 mm with internal centres on both ends

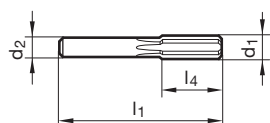

HSS-E machine reamers

Article no. 488						Article no. 489					
d1 mm	d2 h8 mm	l1 mm	l4 mm	Z	Order no.	d1 mm	d2 h8 mm	l1 mm	l4 mm	Z	Order no.
4.00	3.55	56.0	20.0	6	488 4.000 489 4.000	14.00	12.50	90.0	32.0	8	488 14.000 489 14.000
4.50	4.00	63.0	22.0	6	488 4.500 489 4.500	15.00	12.50	90.0	32.0	8	488 15.000 489 15.000
5.00	4.00	63.0	22.0	6	488 5.000 489 5.000	16.00	12.50	90.0	32.0	8	488 16.000 489 16.000
5.50	5.00	63.0	22.0	6	488 5.500 489 5.500	17.00	12.50	90.0	32.0	8	488 17.000 489 17.000
6.00	5.00	63.0	22.0	6	488 6.000 489 6.000	18.00	16.00	100.0	36.0	8	488 18.000 489 18.000
6.50	5.00	63.0	22.0	6	488 6.500 489 6.500	19.00	16.00	100.0	36.0	8	488 19.000 489 19.000
7.00	6.30	71.0	25.0	6	488 7.000 489 7.000	20.00	16.00	100.0	36.0	8	488 20.000 489 20.000
7.50	6.30	71.0	25.0	6	488 7.500 489 7.500						
8.00	6.30	71.0	25.0	6	488 8.000 489 8.000						
8.50	6.30	71.0	25.0	6	488 8.500 489 8.500						
9.00	8.00	71.0	25.0	6	488 9.000 489 9.000						
9.50	8.00	71.0	25.0	6	488 9.500						
10.00	8.00	71.0	25.0	6	488 10.000 489 10.000						
10.50	8.00	71.0	25.0	6	488 10.500 489 10.500						
11.00	10.00	80.0	28.0	6	488 11.000 489 11.000						
11.50	10.00	80.0	28.0	6	488 11.500 489 11.500						
12.00	10.00	80.0	28.0	6	488 12.000 489 12.000						
13.00	10.00	80.0	28.0	6	488 13.000 489 13.000						



Machine reamers

Article no. 497



Cutting data page 1050

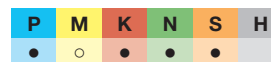

manufacturing tolerance: ≤ Ø 5.50 mm: 0.000/+0.004 • > Ø 5.50 mm: 0.000/+0.005 • Ø in increments of 0.01 mm • ≤ Ø 3.75 mm with external centres on both ends • > Ø 3.75 mm with internal centres on both ends

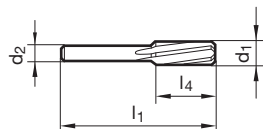

Article no. 497							Article no. 497						
d1 mm	d2 h8 mm	l1 mm	l5 mm	l4 mm	Z	Order no.	d1 mm	d2 h8 mm	l1 mm	l5 mm	l4 mm	Z	Order no.
3.76	3.55	56.0	32.0	20.0	6	497 3.760	4.42	4.00	63.0	34.0	22.0	6	497 4.420
3.77	3.55	56.0	32.0	20.0	6	497 3.770	4.43	4.00	63.0	34.0	22.0	6	497 4.430
3.78	3.55	56.0	32.0	20.0	6	497 3.780	4.44	4.00	63.0	34.0	22.0	6	497 4.440
3.79	3.55	56.0	32.0	20.0	6	497 3.790	4.45	4.00	63.0	34.0	22.0	6	497 4.450
3.80	3.55	56.0	32.0	20.0	6	497 3.800	4.46	4.00	63.0	34.0	22.0	6	497 4.460
3.81	3.55	56.0	32.0	20.0	6	497 3.810	4.47	4.00	63.0	34.0	22.0	6	497 4.470
3.82	3.55	56.0	32.0	20.0	6	497 3.820	4.48	4.00	63.0	34.0	22.0	6	497 4.480
3.83	3.55	56.0	32.0	20.0	6	497 3.830	4.49	4.00	63.0	34.0	22.0	6	497 4.490
3.84	3.55	56.0	32.0	20.0	6	497 3.840	4.50	4.00	63.0	34.0	22.0	6	497 4.500
3.85	3.55	56.0	32.0	20.0	6	497 3.850	4.51	4.00	63.0	34.0	22.0	6	497 4.510
3.86	3.55	56.0	32.0	20.0	6	497 3.860	4.52	4.00	63.0	34.0	22.0	6	497 4.520
3.87	3.55	56.0	32.0	20.0	6	497 3.870	4.53	4.00	63.0	34.0	22.0	6	497 4.530
3.88	3.55	56.0	32.0	20.0	6	497 3.880	4.54	4.00	63.0	34.0	22.0	6	497 4.540
3.89	3.55	56.0	32.0	20.0	6	497 3.890	4.55	4.00	63.0	34.0	22.0	6	497 4.550
3.90	3.55	56.0	32.0	20.0	6	497 3.900	4.56	4.00	63.0	34.0	22.0	6	497 4.560
3.91	3.55	56.0	32.0	20.0	6	497 3.910	4.57	4.00	63.0	34.0	22.0	6	497 4.570
3.92	3.55	56.0	32.0	20.0	6	497 3.920	4.58	4.00	63.0	34.0	22.0	6	497 4.580
3.93	3.55	56.0	32.0	20.0	6	497 3.930	4.59	4.00	63.0	34.0	22.0	6	497 4.590
3.94	3.55	56.0	32.0	20.0	6	497 3.940	4.60	4.00	63.0	34.0	22.0	6	497 4.600
3.95	3.55	56.0	32.0	20.0	6	497 3.950	4.61	4.00	63.0	34.0	22.0	6	497 4.610
3.96	3.55	56.0	32.0	20.0	6	497 3.960	4.62	4.00	63.0	34.0	22.0	6	497 4.620
3.97	3.55	56.0	32.0	20.0	6	497 3.970	4.63	4.00	63.0	34.0	22.0	6	497 4.630
3.98	3.55	56.0	32.0	20.0	6	497 3.980	4.64	4.00	63.0	34.0	22.0	6	497 4.640
3.99	3.55	56.0	32.0	20.0	6	497 3.990	4.65	4.00	63.0	34.0	22.0	6	497 4.650
4.00	3.55	56.0	32.0	20.0	6	497 4.000	4.66	4.00	63.0	34.0	22.0	6	497 4.660
4.01	3.55	56.0	32.0	20.0	6	497 4.010	4.67	4.00	63.0	34.0	22.0	6	497 4.670
4.02	3.55	56.0	32.0	20.0	6	497 4.020	4.68	4.00	63.0	34.0	22.0	6	497 4.680
4.03	3.55	56.0	32.0	20.0	6	497 4.030	4.69	4.00	63.0	34.0	22.0	6	497 4.690
4.04	3.55	56.0	32.0	20.0	6	497 4.040	4.70	4.00	63.0	34.0	22.0	6	497 4.700
4.05	3.55	56.0	32.0	20.0	6	497 4.050	4.71	4.00	63.0	34.0	22.0	6	497 4.710
4.06	3.55	56.0	32.0	20.0	6	497 4.060	4.72	4.00	63.0	34.0	22.0	6	497 4.720
4.07	3.55	56.0	32.0	20.0	6	497 4.070	4.73	4.00	63.0	34.0	22.0	6	497 4.730
4.08	3.55	56.0	32.0	20.0	6	497 4.080	4.74	4.00	63.0	34.0	22.0	6	497 4.740
4.09	3.55	56.0	32.0	20.0	6	497 4.090	4.75	4.00	63.0	34.0	22.0	6	497 4.750
4.10	3.55	56.0	32.0	20.0	6	497 4.100	4.76	4.00	63.0	34.0	22.0	6	497 4.760
4.11	3.55	56.0	32.0	20.0	6	497 4.110	4.77	4.00	63.0	34.0	22.0	6	497 4.770
4.12	3.55	56.0	32.0	20.0	6	497 4.120	4.78	4.00	63.0	34.0	22.0	6	497 4.780
4.13	3.55	56.0	32.0	20.0	6	497 4.130	4.79	4.00	63.0	34.0	22.0	6	497 4.790
4.14	3.55	56.0	32.0	20.0	6	497 4.140	4.80	4.00	63.0	34.0	22.0	6	497 4.800
4.15	3.55	56.0	32.0	20.0	6	497 4.150	4.81	4.00	63.0	34.0	22.0	6	497 4.810
4.16	3.55	56.0	32.0	20.0	6	497 4.160	4.82	4.00	63.0	34.0	22.0	6	497 4.820
4.17	3.55	56.0	32.0	20.0	6	497 4.170	4.83	4.00	63.0	34.0	22.0	6	497 4.830
4.18	3.55	56.0	32.0	20.0	6	497 4.180	4.84	4.00	63.0	34.0	22.0	6	497 4.840
4.19	3.55	56.0	32.0	20.0	6	497 4.190	4.85	4.00	63.0	34.0	22.0	6	497 4.850
4.20	3.55	56.0	32.0	20.0	6	497 4.200	4.86	4.00	63.0	34.0	22.0	6	497 4.860
4.21	3.55	56.0	32.0	20.0	6	497 4.210	4.87	4.00	63.0	34.0	22.0	6	497 4.870
4.22	3.55	56.0	32.0	20.0	6	497 4.220	4.88	4.00	63.0	34.0	22.0	6	497 4.880
4.23	3.55	56.0	32.0	20.0	6	497 4.230	4.89	4.00	63.0	34.0	22.0	6	497 4.890
4.24	3.55	56.0	32.0	20.0	6	497 4.240	4.90	4.00	63.0	34.0	22.0	6	497 4.900
4.25	3.55	56.0	32.0	20.0	6	497 4.250	4.91	4.00	63.0	34.0	22.0	6	497 4.910
4.26	4.00	63.0	34.0	22.0	6	497 4.260	4.92	4.00	63.0	34.0	22.0	6	497 4.920
4.27	4.00	63.0	34.0	22.0	6	497 4.270	4.93	4.00	63.0	34.0	22.0	6	497 4.930
4.28	4.00	63.0	34.0	22.0	6	497 4.280	4.94	4.00	63.0	34.0	22.0	6	497 4.940
4.29	4.00	63.0	34.0	22.0	6	497 4.290	4.95	4.00	63.0	34.0	22.0	6	497 4.950
4.30	4.00	63.0	34.0	22.0	6	497 4.300	4.96	4.00	63.0	34.0	22.0	6	497 4.960
4.31	4.00	63.0	34.0	22.0	6	497 4.310	4.97	4.00	63.0	34.0	22.0	6	497 4.970
4.32	4.00	63.0	34.0	22.0	6	497 4.320	4.98	4.00	63.0	34.0	22.0	6	497 4.980
4.33	4.00	63.0	34.0	22.0	6	497 4.330	4.99	4.00	63.0	34.0	22.0	6	497 4.990
4.34	4.00	63.0	34.0	22.0	6	497 4.340	5.00	4.00	63.0	34.0	22.0	6	497 5.000
4.35	4.00	63.0	34.0	22.0	6	497 4.350	5.01	4.00	63.0	34.0	22.0	6	497 5.010
4.36	4.00	63.0	34.0	22.0	6	497 4.360	5.02	4.00	63.0	34.0	22.0	6	497 5.020
4.37	4.00	63.0	34.0	22.0	6	497 4.370	5.03	4.00	63.0	34.0	22.0	6	497 5.030
4.38	4.00	63.0	34.0	22.0	6	497 4.380	5.04	4.00	63.0	34.0	22.0	6	497 5.040
4.39	4.00	63.0	34.0	22.0	6	497 4.390	5.05	4.00	63.0	34.0	22.0	6	497 5.050
4.40	4.00	63.0	34.0	22.0	6	497 4.400	5.06	4.00	63.0	34.0	22.0	6	497 5.060
4.41	4.00	63.0	34.0	22.0	6	497 4.410	5.07	4.00	63.0	34.0	22.0	6	497 5.070

HSS-E machine reamers



Article no.							497							Article no.							497						
d1 mm	d2 h8 mm	l1 mm	l5 mm	l4 mm	Z	Order no.	d1 mm	d2 h8 mm	l1 mm	l5 mm	l4 mm	Z	Order no.	d1 mm	d2 h8 mm	l1 mm	l5 mm	l4 mm	Z	Order no.							
11.80	10.00	80.0	43.0	28.0	6	497 11.800	11.98	10.00	80.0	43.0	28.0	6	497 11.980														
11.81	10.00	80.0	43.0	28.0	6	497 11.810	11.99	10.00	80.0	43.0	28.0	6	497 11.990														
11.82	10.00	80.0	43.0	28.0	6	497 11.820	12.00	10.00	80.0	43.0	28.0	6	497 12.000														
11.83	10.00	80.0	43.0	28.0	6	497 11.830	12.01	10.00	80.0	43.0	28.0	6	497 12.010														
11.84	10.00	80.0	43.0	28.0	6	497 11.840	12.02	10.00	80.0	43.0	28.0	6	497 12.020														
11.85	10.00	80.0	43.0	28.0	6	497 11.850	12.03	10.00	80.0	43.0	28.0	6	497 12.030														
11.86	10.00	80.0	43.0	28.0	6	497 11.860	12.04	10.00	80.0	43.0	28.0	6	497 12.040														
11.87	10.00	80.0	43.0	28.0	6	497 11.870	12.05	10.00	80.0	43.0	28.0	6	497 12.050														
11.88	10.00	80.0	43.0	28.0	6	497 11.880																					
11.89	10.00	80.0	43.0	28.0	6	497 11.890																					
11.90	10.00	80.0	43.0	28.0	6	497 11.900																					
11.91	10.00	80.0	43.0	28.0	6	497 11.910																					
11.92	10.00	80.0	43.0	28.0	6	497 11.920																					
11.93	10.00	80.0	43.0	28.0	6	497 11.930																					
11.94	10.00	80.0	43.0	28.0	6	497 11.940																					
11.95	10.00	80.0	43.0	28.0	6	497 11.950																					
11.96	10.00	80.0	43.0	28.0	6	497 11.960																					
11.97	10.00	80.0	43.0	28.0	6	497 11.970																					



Quick helix reamers

Article no. 403



Cutting data page 1051



P	M	K	N	S	H
•			•	○	

≤ Ø 3.75 mm with external centres on both ends • > Ø 3.75 mm with internal centres on both ends

Quick helix reamers

Article no. 469



Cutting data page 1051



P	M	K	N	S	H
•			•	○	

≤ Ø 3.75 mm with external centres on both ends • > Ø 3.75 mm with internal centres on both ends

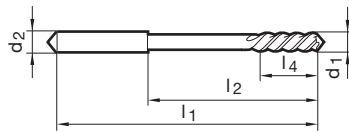

Article no. 403 469

d1 mm	D mm	l1 mm	l2 mm	l4 mm	Z	Order no.
1.00	1.00	34.0	15.0	5.5	2	403 1.000
1.20	1.20	38.0	16.5	7.5	2	403 1.200
1.40	1.40	40.0	18.0	8.0	2	403 1.400
1.50	1.50	40.0	18.0	8.0	2	403 1.500
1.60	1.60	43.0	20.0	9.0	2	403 1.600
1.80	1.80	46.0	22.0	10.0	2	403 1.800
2.00	2.00	49.0	24.0	11.0	3	403 2.000
2.20	2.20	53.0	25.0	12.0	3	403 2.200
2.50	2.50	57.0	29.0	14.0	3	403 2.500
2.80	2.80	61.0	33.0	15.0	3	403 2.800
3.00	3.00	61.0	33.0	15.0	3	403 3.000
3.20	3.20	65.0	37.0	16.0	3	403 3.200
3.50	3.50	70.0	42.0	18.0	3	403 3.500
4.00	4.00	75.0	47.0	19.0	3	469 4.000
4.50	4.50	80.0	52.0	21.0	3	469 4.500
5.00	5.00	86.0	58.0	23.0	3	469 5.000
5.50	5.60	93.0	57.0	26.0	3	469 5.500
6.00	5.60	93.0	57.0	26.0	3	469 6.000
6.50	6.30	101.0	65.0	28.0	3	469 6.500
7.00	7.10	109.0	73.0	31.0	3	469 7.000
8.00	8.00	117.0	81.0	33.0	3	469 8.000
8.50	8.00	117.0	81.0	33.0	3	469 8.500
9.00	9.00	125.0	85.0	36.0	3	469 9.000
9.50	9.00	125.0	85.0	36.0	3	469 9.500
10.00	10.00	133.0	93.0	38.0	3	469 10.000
11.00	10.00	142.0	102.0	41.0	3	469 11.000
12.00	10.00	151.0	111.0	44.0	3	469 12.000
13.00	10.00	151.0	111.0	44.0	3	469 13.000
14.00	12.50	160.0	115.0	47.0	3	469 14.000
15.00	12.50	162.0	117.0	50.0	3	469 15.000
16.00	12.50	170.0	125.0	52.0	3	469 16.000
17.00	14.00	175.0	130.0	54.0	3	469 17.000
18.00	14.00	182.0	137.0	56.0	3	469 18.000
20.00	16.00	195.0	147.0	60.0	3	469 20.000

HSS-E machine reamers



Quick helix reamers

Article no. **406**



Cutting data page 1051



P	M	K	N	S	H
•			•	○	

Ø 3.00 mm cutting side with with external centre, shank end with internal centering • > Ø 3.00 mm with internal centres on both ends • ≤ Ø 4.00 mm to company standard

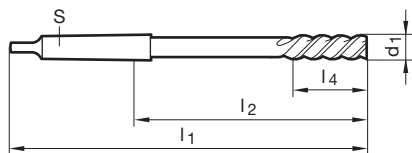

Article no.

406

d1 mm	S	l1 mm	l2 mm	l4 mm	Z	Order no.
3.00	MK-1	115.0	49.5	15.0	3	406 3.000
4.00	MK-1	125.0	59.5	19.0	3	406 4.000
5.00	MK-1	133.0	67.5	23.0	3	406 5.000
6.00	MK-1	138.0	72.5	26.0	3	406 6.000
7.00	MK-1	150.0	84.5	31.0	3	406 7.000
8.00	MK-1	156.0	90.5	33.0	3	406 8.000
9.00	MK-1	162.0	96.5	36.0	3	406 9.000
10.00	MK-1	168.0	102.5	38.0	3	406 10.000
11.00	MK-1	175.0	109.5	41.0	3	406 11.000
12.00	MK-1	182.0	116.5	44.0	3	406 12.000
13.00	MK-1	182.0	116.5	44.0	3	406 13.000
14.00	MK-1	189.0	123.5	47.0	3	406 14.000
15.00	MK-2	204.0	124.0	50.0	3	406 15.000
16.00	MK-2	210.0	130.0	52.0	3	406 16.000
17.00	MK-2	214.0	134.0	54.0	3	406 17.000
18.00	MK-2	219.0	139.0	56.0	3	406 18.000
19.00	MK-2	223.0	143.0	58.0	3	406 19.000
20.00	MK-2	228.0	148.0	60.0	3	406 20.000
21.00	MK-2	232.0	152.0	62.0	3	406 21.000
22.00	MK-2	237.0	157.0	64.0	3	406 22.000
23.00	MK-2	241.0	161.0	66.0	3	406 23.000
24.00	MK-3	268.0	169.0	68.0	3	406 24.000
25.00	MK-3	268.0	169.0	68.0	3	406 25.000
26.00	MK-3	273.0	174.0	70.0	3	406 26.000
27.00	MK-3	277.0	178.0	71.0	3	406 27.000
28.00	MK-3	277.0	178.0	71.0	3	406 28.000
29.00	MK-3	281.0	182.0	73.0	3	406 29.000
30.00	MK-3	281.0	182.0	73.0	3	406 30.000
31.00	MK-3	285.0	186.0	75.0	3	406 31.000
32.00	MK-4	317.0	193.0	77.0	3	406 32.000

HSS-E machine reamers



Bridge reamers

Article no. 414



Cutting data page 1052



P	M	K	N	S	H
•		•	•	○	

1:10 on taper lead length • manufacturing tolerance k11 • with internal centres on both ends

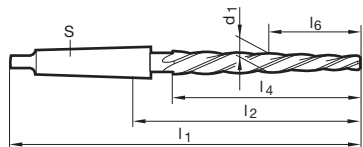

Article no.

414

d1 mm	S	l1 mm	l2 mm	l4 mm	l6 mm	Z	Order no.
6.40	MK-1	151.0	85.5	75.0		4	414 6.400
7.40	MK-1	156.0	90.5	80.0		4	414 7.400
8.40	MK-1	161.0	95.5	85.0		4	414 8.400
9.50	MK-1	166.0	100.5	90.0		4	414 9.500
10.00	MK-1	171.0	105.5	95.0		4	414 10.000
11.00	MK-1	176.0	110.5	100.0		4	414 11.000
12.00	MK-2	199.0	119.0	105.0		4	414 12.000
13.00	MK-2	199.0	119.0	105.0		4	414 13.000
14.00	MK-2	209.0	129.0	115.0		5	414 14.000
15.00	MK-2	219.0	139.0	125.0		5	414 15.000
16.00	MK-2	229.0	149.0	135.0		5	414 16.000
17.00	MK-3	251.0	152.0	135.0		5	414 17.000
18.00	MK-3	261.0	162.0	145.0		5	414 18.000
19.00	MK-3	261.0	162.0	145.0		5	414 19.000
20.00	MK-3	271.0	172.0	155.0		5	414 20.000
21.00	MK-3	271.0	172.0	155.0		5	414 21.000
22.00	MK-3	281.0	182.0	165.0		5	414 22.000
23.00	MK-3	281.0	182.0	165.0		5	414 23.000
24.00	MK-3	296.0	197.0	180.0		5	414 24.000
25.00	MK-3	296.0	197.0	180.0		5	414 25.000
26.00	MK-3	296.0	197.0	180.0		5	414 26.000
27.00	MK-3	311.0	212.0	195.0		5	414 27.000
28.00	MK-3	311.0	212.0	195.0		5	414 28.000
30.00	MK-3	311.0	212.0	195.0		5	414 30.000
31.00	MK-3	326.0	227.0	210.0		5	414 31.000
32.00	MK-4	354.0	230.0	210.0		5	414 32.000
34.00	MK-4	364.0	240.0	220.0		5	414 34.000
37.00	MK-4	364.0	240.0	220.0		5	414 37.000

HSS-E machine reamers



Machine bottoming reamers

Article no. **419**



Cutting data page 1053



P	M	K	N	S	H
●	○	●	●	○	○

Stable reamer to correct position errors during pre-machining or to produce accurate gauges.

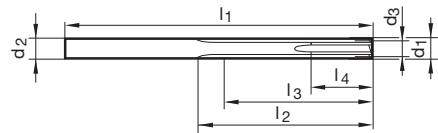

Article no. **419**

d1 mm	d2 mm	int. Ø mm	l1 mm	l2 mm	l3 mm	l4 mm	Z	Order no.
2.50	2.50		57.0	37.0	33.0	12.0	4	419 2.500
3.00	3.00	1.50	61.0	37.0	33.0	12.0	6	419 3.000
3.50	3.50	1.50	70.0	44.0	39.0	12.0	6	419 3.500
4.00	4.00	1.70	75.0	48.0	44.0	16.0	6	419 4.000
4.50	4.50	1.70	80.0	52.0	48.0	16.0	6	419 4.500
5.00	5.00	1.70	86.0	59.0	53.0	20.0	6	419 5.000
6.00	6.00	2.00	93.0	65.0	59.0	20.0	6	419 6.000
7.00	7.00	2.50	109.0	75.0	69.0	22.0	6	419 7.000
8.00	8.00	3.00	117.0	81.0	71.0	24.0	6	419 8.000
9.00	9.00	3.50	125.0	87.0	77.0	24.0	6	419 9.000
10.00	10.00	4.50	133.0	94.0	84.0	26.0	6	419 10.000
11.00	11.00	4.50	142.0	99.0	89.0	26.0	6	419 11.000
12.00	12.00	4.50	151.0	106.0	96.0	26.0	6	419 12.000

HSS-E machine reamers

Stepped machine reamers

Article no. **431**



Cutting data page 1054



with internal centres on both ends

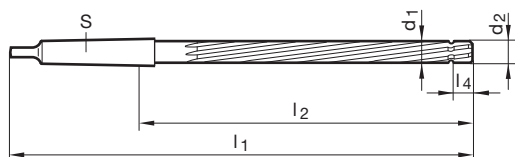

Article no. **431**

d1 mm	S	d5 mm	l1 mm	l2 mm	l4 mm	Z	Order no.
5.00	MK-1	4.92	165	103	10	6	431 5.000
6.00	MK-1	5.92	165	103	10	6	431 6.000
8.00	MK-1	7.92	205	143	10	6	431 8.000
10.00	MK-1	9.90	230	168	12	6	431 10.000
12.00	MK-1	11.90	230	168	12	6	431 12.000
14.00	MK-1	13.90	230	168	12	8	431 14.000
16.00	MK-2	15.90	250	175	12	8	431 16.000
20.00	MK-2	19.90	260	185	15	8	431 20.000



Shell reamers

Article no. 408



Cutting data page 1055



P	M	K	N	S	H
●	○	●	●	●	●

The shell reamers have a mounting hole with a 1:30 taper and a transverse groove in accordance with DIN 138.

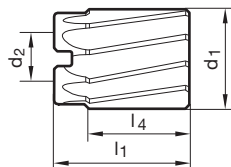

Article no. 408

d1 mm	d2 mm	l1 mm	l4 mm	Z	Order no.
25.00	13.00	45	32	8	408 25.000
26.00	13.00	45	32	8	408 26.000
27.00	13.00	45	32	8	408 27.000
28.00	13.00	45	32	8	408 28.000
30.00	13.00	45	32	8	408 30.000
31.00	16.00	50	36	10	408 31.000
32.00	16.00	50	36	10	408 32.000
33.00	16.00	50	36	10	408 33.000
34.00	16.00	50	36	10	408 34.000
35.00	16.00	50	36	10	408 35.000
36.00	19.00	56	40	10	408 36.000
38.00	19.00	56	40	10	408 38.000
40.00	19.00	56	40	10	408 40.000
42.00	19.00	56	40	10	408 42.000
44.00	22.00	63	45	12	408 44.000
45.00	22.00	63	45	12	408 45.000
50.00	22.00	63	45	12	408 50.000
52.00	27.00	71	50	12	408 52.000
55.00	27.00	71	50	12	408 55.000
58.00	27.00	71	50	12	408 58.000
60.00	27.00	71	50	12	408 60.000
62.00	32.00	80	56	14	408 62.000
70.00	32.00	80	56	14	408 70.000
75.00	40.00	90	63	14	408 75.000

HSS-E machine reamers

Arbors, complete

Article no. 1438

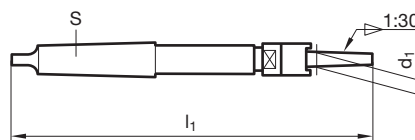

Article no. 1438

d1 mm	S	l1 mm	Order no.
13	MK-3	250	1438 13.000
16	MK-3	261	1438 16.000
19	MK-4	298	1438 19.000
22	MK-4	312	1438 22.000
27	MK-5	359	1438 27.000
32	MK-5	376	1438 32.000
40	MK-5	396	1438 40.000
50	MK-5	416	1438 50.000



Machine taper reamers

Article no. **410**



Cutting data page 1056



P	M	K	N	S	H
●	○	●	●	○	○

with 1:50 taper for reaming holes for taper pins to DIN 1, 258, 7977 and 7978 • $\leq \varnothing 4.00$ mm with external centres on both ends • $> \varnothing 4.00$ mm with internal centres on both ends • $\leq \varnothing 1.50$ mm to company standard • with tang to DIN 1809

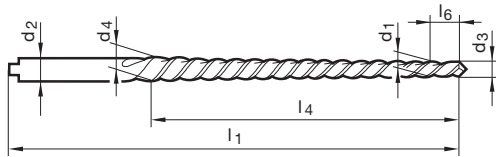

Article no. **410**

d1 mm	d2 mm	d3 mm	d4 mm	l1 mm	l4 mm	l6 mm	Z	Order no.
1.00	1.40	0.90	1.46	60.00	33.00	5.00	2	410 1.000
1.50	2.10	1.40	2.14	70.00	37.00	5.00	2	410 1.500
2.00	3.15	1.90	2.86	86.00	48.00	5.00	3	410 2.000
2.50	3.15	2.40	3.36	86.00	48.00	5.00	3	410 2.500
3.00	4.00	2.90	4.06	100.00	58.00	5.00	3	410 3.000
4.00	5.00	3.90	5.26	112.00	68.00	5.00	3	410 4.000
5.00	6.30	4.90	6.36	122.00	73.00	5.00	3	410 5.000
6.00	8.00	5.90	8.00	160.00	105.00	5.00	3	410 6.000
6.50	8.50	6.40	8.78	188.00	119.00	5.00	3	410 6.500
8.00	10.00	7.90	10.80	207.00	145.00	5.00	3	410 8.000
10.00	12.50	9.90	13.40	245.00	175.00	5.00	3	410 10.000
12.00	16.00	11.80	16.00	290.00	210.00	10.00	3	410 12.000

HSS-Taper reamers

Machine taper reamers

Article no. **411**



Cutting data page 1056



P	M	K	N	S	H
●	○	●	●	○	○

with 1:50 taper for reaming holes for taper pins to DIN 1, 258, 7977 and 7978 • with internal centres on both ends • $\varnothing 13.00$ and 14.00 mm to company standard

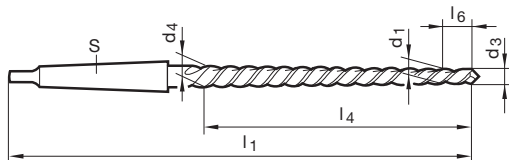

Article no. **411**

d1 mm	S	d3 mm	d4 mm	l1 mm	l4 mm	l6 mm	Z	Order no.
5.00	MK-1	4.90	6.36	155.00	73.00	5.00	3	411 5.000
6.00	MK-1	5.90	8.00	187.00	105.00	5.00	3	411 6.000
8.00	MK-1	7.90	10.80	227.00	145.00	5.00	3	411 8.000
10.00	MK-1	9.90	13.40	257.00	175.00	5.00	3	411 10.000
12.00	MK-2	11.80	16.00	315.00	210.00	10.00	3	411 12.000
13.00	MK-2	12.80	16.68	295.00	194.00	10.00	3	411 13.000
14.00	MK-2	13.80	17.68	295.00	194.00	10.00	3	411 14.000
16.00	MK-2	15.80	20.40	335.00	230.00	10.00	3	411 16.000
20.00	MK-3	19.80	24.80	377.00	250.00	10.00	3	411 20.000
25.00	MK-3	24.70	30.70	427.00	300.00	15.00	3	411 25.000
30.00	MK-4	29.70	36.10	475.00	320.00	15.00	4	411 30.000
40.00	MK-4	39.70	46.50	495.00	340.00	15.00	6	411 40.000
50.00	MK-5	49.70	56.90	550.00	360.00	15.00	8	411 50.000



Hand taper reamers

Article no. 429



with 1:50 taper for reaming holes for taper pins • with square to DIN 10 • Ø 3.50/4.50/5.50/6.50/7.00/9.00/13.00 and 14.00mm to company standard

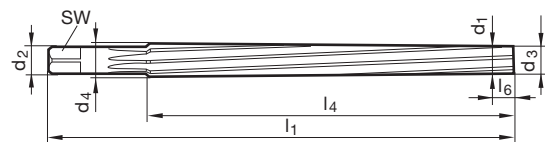

Article no. 429

d1 mm	d2 mm	d3 mm	d4 mm	l1 mm	l4 mm	l6 mm	SW mm	Z	Order no.
2.00	3.15	1.90	2.86	68.0	48.0	5.0	2.4	3	429 2.000
3.00	4.00	2.90	4.06	80.0	58.0	5.0	3.0	5	429 3.000
3.50	4.50	3.40	4.66	87.0	63.0	5.0	3.4	5	429 3.500
4.00	5.00	3.90	5.26	93.0	68.0	5.0	3.8	5	429 4.000
4.50	5.60	4.40	5.80	95.0	70.0	5.0	4.3	5	429 4.500
5.00	6.30	4.90	6.36	100.0	73.0	5.0	4.9	5	429 5.000
5.50	7.10	5.40	7.20	118.0	90.0	5.0	5.5	6	429 5.500
6.00	8.00	5.90	8.00	135.0	105.0	5.0	6.2	6	429 6.000
6.50	8.00	6.40	8.60	140.0	110.0	5.0	6.2	6	429 6.500
7.00	9.00	6.90	9.40	160.0	125.0	5.0	7.0	6	429 7.000
8.00	10.00	7.90	10.80	180.0	145.0	5.0	8.0	6	429 8.000
9.00	11.20	8.90	12.10	195.0	160.0	5.0	9.0	6	429 9.000
10.00	12.50	9.90	13.40	215.0	175.0	5.0	10.0	6	429 10.000
12.00	14.00	11.80	16.00	255.0	210.0	10.0	11.0	8	429 12.000
13.00	16.00	12.80	17.00	255.0	210.0	10.0	12.0	8	429 13.000
14.00	16.00	13.80	18.00	255.0	210.0	10.0	12.0	8	429 14.000
16.00	18.00	15.80	20.40	280.0	230.0	10.0	14.5	8	429 16.000
20.00	22.40	19.80	24.80	310.0	250.0	10.0	18.0	8	429 20.000
25.00	28.00	24.70	30.70	370.0	300.0	15.0	22.0	10	429 25.000
30.00	31.50	29.70	36.10	400.0	320.0	15.0	24.0	10	429 30.000
40.00	40.00	39.70	46.50	430.0	340.0	15.0	32.0	12	429 40.000

HSS Taper reamers

Hand taper reamers

Article no. 1433



with 1:10 taper for reaming tapered pre-machined holes • with square to DIN 10

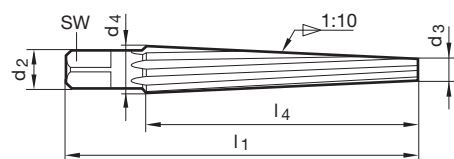

Article no. 1433

d2 mm	d3 mm	d4 mm	l1 mm	l4 mm	SW mm	Z	Order no.
8.00	3.00	10.00	100.0	70.0	6.2	5	1433 3.000
13.00	5.00	15.00	140.0	100.0	10.0	7	1433 5.000
21.00	10.00	25.00	195.0	150.0	16.0	9	1433 10.000



Hand reamers

Article no. **412**



with square to DIN 10 • $\leq \varnothing 3.75$ mm with external centres on both ends • $> \varnothing 3.75$ mm with internal centres on both ends • ≤ 1.75 mm to company standard

Hand reamers

Article no. **413**

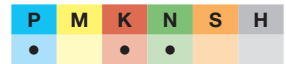

with square to DIN 10 • $\leq \varnothing 3.75$ mm with external centres on both ends • $> \varnothing 3.75$ mm with internal centres on both ends • ≤ 1.75 mm to company standard

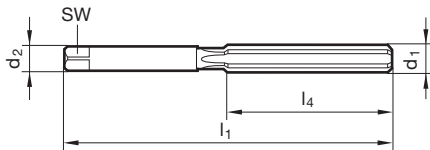

HSS hand reamers

Article no. 412							Article no. 413						
d1 mm	d2 mm	l1 mm	l4 mm	SW mm	Z	Order no.	d1 mm	d2 mm	l1 mm	l4 mm	SW mm	Z	Order no.
1.00	1.00	34.00	13.00		3	413 1.000	16.50	16.50	175.00	87.00	13.00	8	412 16.500 413 16.500
1.40	1.40	41.00	20.00	1.12	3	413 1.400	17.00	17.00	175.00	87.00	13.00	8	412 17.000 413 17.000
1.50	1.50	41.00	20.00	1.12	3	413 1.500	17.50	17.50	188.00	93.00	14.50	8	412 17.500 413 17.500
1.60	1.60	44.00	21.00	1.25	3	413 1.600	18.00	18.00	188.00	93.00	14.50	8	412 18.000 413 18.000
2.00	2.00	50.00	25.00	1.60	4	412 2.000 413 2.000	18.50	18.50	188.00	93.00	14.50	8	412 18.500 413 18.500
2.20	2.20	54.00	27.00	1.80	4	412 2.200 413 2.200	19.00	19.00	188.00	93.00	14.50	8	412 19.000 413 19.000
2.50	2.50	58.00	29.00	2.10	4	412 2.500 413 2.500	19.50	19.50	201.00	100.00	16.00	8	412 19.500 413 19.500
2.80	2.80	62.00	31.00	2.10	6	413 2.800	20.00	20.00	201.00	100.00	16.00	8	412 20.000 413 20.000
3.00	3.00	62.00	31.00	2.40	6	412 3.000 413 3.000	21.00	21.00	201.00	100.00	16.00	8	412 21.000 413 21.000
3.20	3.20	66.00	33.00	2.40	6	413 3.200	22.00	22.00	215.00	107.00	18.00	8	412 22.000 413 22.000
3.50	3.50	71.00	35.00	2.70	6	412 3.500 413 3.500	23.00	23.00	215.00	107.00	18.00	8	412 23.000 413 23.000
4.00	4.00	76.00	38.00	3.00	6	412 4.000 413 4.000	24.00	24.00	231.00	115.00	18.00	8	412 24.000 413 24.000
4.50	4.50	81.00	41.00	3.40	6	412 4.500 413 4.500	25.00	25.00	231.00	115.00	20.00	8	412 25.000 413 25.000
5.00	5.00	87.00	44.00	3.80	6	412 5.000 413 5.000	26.00	26.00	231.00	115.00	20.00	8	412 26.000 413 26.000
5.50	5.50	93.00	47.00	4.30	6	412 5.500 413 5.500	27.00	27.00	247.00	124.00	22.00	10	412 27.000 413 27.000
6.00	6.00	93.00	47.00	4.90	6	412 6.000 413 6.000	28.00	28.00	247.00	124.00	22.00	10	412 28.000 413 28.000
6.50	6.50	100.00	50.00	4.90	6	412 6.500 413 6.500	30.00	30.00	247.00	124.00	24.00	10	412 30.000 413 30.000
7.00	7.00	107.00	54.00	5.50	6	412 7.000 413 7.000	31.00	31.00	265.00	133.00	24.00	10	412 31.000 413 31.000
7.50	7.50	107.00	54.00	6.20	6	412 7.500 413 7.500	32.00	32.00	265.00	133.00	24.00	10	412 32.000 413 32.000
8.00	8.00	115.00	58.00	6.20	6	412 8.000 413 8.000	33.00	33.00	265.00	133.00	26.00	10	412 33.000 413 33.000
8.50	8.50	115.00	58.00	7.00	6	412 8.500 413 8.500	34.00	34.00	284.00	142.00	26.00	10	412 34.000 413 34.000
9.00	9.00	124.00	62.00	7.00	6	412 9.000 413 9.000	35.00	35.00	284.00	142.00	29.00	10	412 35.000 413 35.000
9.50	9.50	124.00	62.00	8.00	6	412 9.500 413 9.500	37.00	37.00	284.00	142.00	29.00	10	412 37.000 413 37.000
10.00	10.00	133.00	66.00	8.00	6	412 10.000 413 10.000	38.00	38.00	305.00	152.00	29.00	10	412 38.000 413 38.000
10.50	10.50	133.00	66.00	8.00	6	412 10.500 413 10.500	39.00	39.00	305.00	152.00	32.00	10	412 39.000 413 39.000
11.00	11.00	142.00	71.00	9.00	6	412 11.000 413 11.000	40.00	40.00	305.00	152.00	32.00	10	412 40.000 413 40.000
11.50	11.50	142.00	71.00	9.00	6	412 11.500 413 11.500	43.00	43.00	326.00	163.00	35.00	12	412 43.000 413 43.000
12.00	12.00	152.00	76.00	9.00	6	412 12.000 413 12.000	44.00	44.00	326.00	163.00	35.00	12	412 44.000 413 44.000
12.50	12.50	152.00	76.00	10.00	6	412 12.500 413 12.500	45.00	45.00	326.00	163.00	35.00	12	412 45.000 413 45.000
13.00	13.00	152.00	76.00	10.00	6	412 13.000 413 13.000	48.00	48.00	347.00	174.00	39.00	12	412 48.000 413 48.000
13.50	13.50	163.00	81.00	11.00	8	412 13.500 413 13.500	49.00	49.00	347.00	174.00	39.00	12	412 49.000 413 49.000
14.00	14.00	163.00	81.00	11.00	8	412 14.000 413 14.000							
14.50	14.50	163.00	81.00	11.00	8	412 14.500 413 14.500							
15.00	15.00	163.00	81.00	12.00	8	412 15.000 413 15.000							
15.50	15.50	175.00	87.00	12.00	8	412 15.500 413 15.500							
16.00	16.00	175.00	87.00	12.00	8	412 16.000 413 16.000							



Adjustable hand reamers

Article no. 415



with square to DIN 10 • with internal centres on both ends

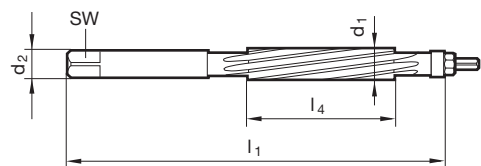

Article no. **415**

d1 mm	d2 mm	l1 mm	l4 mm	SW mm	Z	Order no.
4.00	4.00	76.0	24.0	3.0	6	415 4.000
5.00	5.00	87.0	30.0	3.8	6	415 5.000
5.50	5.50	93.0	33.0	4.3	6	415 5.500
6.00	6.00	93.0	33.0	4.9	6	415 6.000
6.50	6.50	100.0	34.0	4.9	6	415 6.500
7.00	7.00	107.0	38.0	5.5	9	415 7.000
7.50	7.50	107.0	38.0	6.2	9	415 7.500
8.00	8.00	115.0	42.0	6.2	9	415 8.000
8.50	8.50	115.0	42.0	7.0	9	415 8.500
9.00	9.00	124.0	46.0	7.0	9	415 9.000
9.50	9.50	124.0	46.0	8.0	9	415 9.500
10.00	10.00	133.0	50.0	8.0	9	415 10.000
10.50	10.50	133.0	50.0	8.0	9	415 10.500
11.00	11.00	142.0	51.0	9.0	9	415 11.000
11.50	11.50	142.0	51.0	9.0	9	415 11.500
12.00	12.00	152.0	56.0	9.0	9	415 12.000
12.50	12.50	152.0	56.0	10.0	9	415 12.500
13.00	13.00	152.0	56.0	10.0	9	415 13.000
13.50	13.50	163.0	61.0	11.0	9	415 13.500
14.00	14.00	163.0	61.0	11.0	9	415 14.000
15.00	15.00	163.0	61.0	12.0	9	415 15.000
16.00	16.00	175.0	67.0	12.0	9	415 16.000
17.00	17.00	175.0	67.0	13.0	9	415 17.000
18.00	18.00	188.0	68.0	14.5	9	415 18.000
19.00	19.00	188.0	68.0	14.5	9	415 19.000
20.00	20.00	201.0	75.0	16.0	9	415 20.000
21.00	21.00	201.0	75.0	16.0	9	415 21.000
22.00	22.00	215.0	82.0	18.0	12	415 22.000
23.00	23.00	215.0	82.0	18.0	12	415 23.000
24.00	24.00	231.0	85.0	18.0	12	415 24.000
25.00	25.00	231.0	85.0	20.0	12	415 25.000
27.00	27.00	247.0	94.0	22.0	12	415 27.000
28.00	28.00	247.0	94.0	22.0	12	415 28.000
29.00	29.00	247.0	94.0	22.0	12	415 29.000
30.00	30.00	247.0	94.0	24.0	12	415 30.000
31.00	31.00	265.0	99.0	24.0	12	415 31.000
32.00	32.00	265.0	99.0	24.0	12	415 32.000
33.00	33.00	265.0	99.0	26.0	12	415 33.000
35.00	35.00	284.0	108.0	29.0	12	415 35.000
38.00	38.00	305.0	111.0	29.0	12	415 38.000
40.00	40.00	305.0	111.0	32.0	12	415 40.000
41.00	41.00	305.0	111.0	32.0	12	415 41.000
43.00	43.00	326.0	120.0	35.0	12	415 43.000
45.00	45.00	326.0	120.0	35.0	12	415 45.000
47.00	47.00	326.0	120.0	39.0	12	415 47.000
49.00	49.00	347.0	131.0	39.0	12	415 49.000
51.00	51.00	347.0	131.0	39.0	16	415 51.000
54.00	54.00	367.0	131.0	44.0	16	415 54.000
55.00	55.00	367.0	131.0	44.0	16	415 55.000
58.00	58.00	367.0	131.0	44.0	16	415 58.000
59.00	59.00	367.0	131.0	49.0	16	415 59.000

HSS hand reamers



Expanding hand reamers

Article no. **416**



with large adjustment range • with square to DIN 10 • with internal centres on both ends

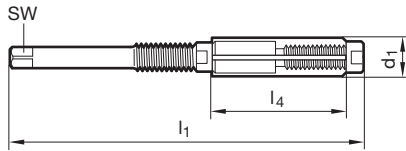

Article no. **416**

d1 mm	Ø-range	l1 mm	l4 mm	SW mm	Z	Order no.
6.40	6,40-7,20	110.0	32.0	3.0	4	416 6.400
7.20	7,20-8,00	110.0	32.0	3.4	4	416 7.200
8.00	8,00-9,00	115.0	34.0	3.8	5	416 8.000
9.00	9,00-10,00	115.0	34.0	4.3	5	416 9.000
10.00	10,00-11,00	115.0	34.0	4.9	5	416 10.000
11.00	11,00-12,00	125.0	35.0	4.9	5	416 11.000
12.00	12,00-13,50	135.0	41.0	6.2	5	416 12.000
13.50	13,50-15,50	146.0	50.0	7.0	5	416 13.500
15.50	15,50-18,00	166.0	60.0	8.0	5	416 15.500
18.00	18,00-21,00	178.0	65.0	9.0	5	416 18.000
21.00	21,00-24,00	195.0	76.0	11.0	5	416 21.000
24.00	24,00-27,50	218.0	82.0	12.0	5	416 24.000
27.50	27,50-31,50	245.0	86.0	14.5	5	416 27.500
31.50	31,50-37,00	280.0	98.0	18.0	6	416 31.500
37.00	37,00-45,00	325.0	108.0	20.0	6	416 37.000
45.00	45,00-55,00	370.0	118.0	26.0	6	416 45.000
55.00	55,00-67,00	400.0	125.0	32.0	6	416 55.000
67.00	67,00-80,00	435.0	140.0	39.0	8	416 67.000
80.00	80,00-95,00	475.0	155.0	49.0	8	416 80.000

HSS hand reamers

Replacement blades for expanding hand reamers

Article no. **417**

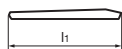

Article no. **417**

d1 mm	Ø-range	l1 mm	Order no.
6.40	6,40-7,20	32.0	417 6.400
7.20	7,20-8,00	32.0	417 7.200
8.00	8,00-9,00	34.0	417 8.000
9.00	9,00-10,00	34.0	417 9.000
10.00	10,00-11,00	34.0	417 10.000
11.00	11,00-12,00	35.0	417 11.000
12.00	12,00-13,50	41.0	417 12.000
13.50	13,50-15,50	50.0	417 13.500
15.50	15,50-18,00	60.0	417 15.500
18.00	18,00-21,00	65.0	417 18.000
21.00	21,00-24,00	76.0	417 21.000
24.00	24,00-27,50	82.0	417 24.000
27.50	27,50-31,50	86.0	417 27.500
31.50	31,50-37,00	98.0	417 31.500
37.00	37,00-45,00	108.0	417 37.000
45.00	45,00-55,00	118.0	417 45.000
55.00	55,00-67,00	125.0	417 55.000
65.00	65,01-67,00	140.0	417 65.000
67.00	67,00-80,00	140.0	417 67.000
80.00	80,00-95,00	155.0	417 80.000

ROO
LBO
RTH



HR 500

**HIGH-PERFORMANCE REAMER FOR RELIABLE
AND SIGNIFICANTLY SHORTER PROCESSES**

- Universally usable in unhardened and hardened materials up to 65 HRC
- Create perfect fits with process reliability
- High-performance reaming with internal cooling in H7 tolerance or in 0.01 increments possible



HR 500



Cutting data

Machining group	a V _c (m/min)	f (mm/rev) with nom. Ø									
		2	3	4	6	8	10	12	14	16	20
P1.1.1 Unalloyed steel, annealed, 0.15 % C, Rm 420 N/mm ² , 125 HB	180	0.30	0.50	0.65	1.20	1.55	1.90	2.05	2.15	2.30	2.50
P1.1.2 Unalloyed steel, heat-treated, 0.15 % C, Rm 420 N/mm ² , 125 HB	180	0.30	0.50	0.65	1.20	1.55	1.90	2.05	2.15	2.30	2.50
P1.1.3 Unalloyed steel, annealed, 0.45 % C, Rm 640 N/mm ² , 190 HB	180	0.30	0.50	0.65	1.20	1.55	1.90	2.05	2.15	2.30	2.50
P1.1.4 Unalloyed steel, heat-treated, 0.45 % C, Rm 640 N/mm ² , 190 HB	180	0.30	0.50	0.65	1.20	1.55	1.90	2.05	2.15	2.30	2.50
P1.1.5 Unalloyed steel, heat-treated, 0.45 % C, Rm 850 N/mm ² , 250 HB	162	0.30	0.50	0.65	1.20	1.55	1.90	2.05	2.15	2.30	2.50
P1.1.6 Unalloyed steel, annealed, 0.75 % C, Rm 915 N/mm ² , 270 HB	162	0.30	0.50	0.65	1.20	1.55	1.90	2.05	2.15	2.30	2.50
P1.1.7 Unalloyed steel, heat-treated, 0.75 % C, Rm 1020 N/mm ² , 300 HB	144	0.30	0.50	0.65	1.20	1.55	1.90	2.05	2.15	2.30	2.50
P2.1.1 Low-alloy steel, annealed, Rm 610 N/mm ² , 180 HB	180	0.30	0.45	0.60	1.15	1.45	1.75	1.90	2.05	2.15	2.35
P2.1.2 Low-alloy steel, heat-treated, Rm 930 N/mm ² , 275 HB	180	0.30	0.45	0.60	1.15	1.45	1.75	1.90	2.05	2.15	2.35
P2.1.3 Low-alloy steel, heat-treated, Rm 1020 N/mm ² , 300 HB	180	0.30	0.45	0.60	1.15	1.45	1.75	1.90	2.05	2.15	2.35
P2.1.4 Low-alloy steel, heat-treated, Rm 1190 N/mm ² , 350 HB	121	0.30	0.45	0.60	1.15	1.45	1.75	1.90	2.05	2.15	2.35
P3.1.1 High-alloy steel and tool steel, annealed, Rm 680 N/mm ² , 200 HB	180	0.25	0.40	0.60	1.05	1.35	1.65	1.80	1.90	2.00	2.20
P3.1.2 High-alloy steel and tool steel, hardened and tempered, Rm 1100 N/mm ² , 325 HB	121	0.25	0.40	0.60	1.05	1.35	1.65	1.80	1.90	2.00	2.20
M1.1.1 Stainless steel, ferritic/martensitic, with machining additives	80	0.10	0.20	0.25	0.45	0.60	0.70	0.75	0.80	0.85	0.95
M1.1.2 Stainless steel, ferritic/martensitic, annealed, Rm 680 N/mm ² , 200 HB	62	0.10	0.20	0.25	0.45	0.60	0.70	0.75	0.80	0.85	0.95
M1.1.3 Stainless steel, ferritic/martensitic, heat-treated, Rm 810 N/mm ² , 240 HB	62	0.10	0.20	0.25	0.45	0.60	0.70	0.75	0.80	0.85	0.95
M2.1.1 Stainless steel, austenitic, quenched, 180 HB	80	0.10	0.20	0.25	0.45	0.60	0.70	0.75	0.80	0.85	0.95
M2.2.1 Duplex steel, high-strength stainless steels	50	0.10	0.20	0.25	0.45	0.60	0.70	0.75	0.80	0.85	0.95
K1.1.1 Grey cast iron, pearlitic/ferritic, 180 HB	80	0.25	0.35	0.50	0.90	1.15	1.40	1.55	1.65	1.70	1.90
K1.1.2 Grey cast iron, pearlitic/martensitic, 260 HB	72	0.25	0.35	0.50	0.90	1.15	1.40	1.55	1.65	1.70	1.90
K1.2.1 Cast iron with spheroidal graphite, ferritic, 160 HB	96	0.25	0.35	0.50	0.90	1.15	1.40	1.55	1.65	1.70	1.90
K1.2.2 Cast iron with spheroidal graphite, pearlitic, 250 HB	96	0.25	0.35	0.50	0.90	1.15	1.40	1.55	1.65	1.70	1.90
K1.3.1 Malleable cast iron, ferritic, 130 HB	80	0.25	0.35	0.50	0.90	1.15	1.40	1.55	1.65	1.70	1.90
K1.3.2 Malleable cast iron, pearlitic, 230 HB	72	0.25	0.35	0.50	0.90	1.15	1.40	1.55	1.65	1.70	1.90
K2.1.1 Vermicular graphite cast iron (GJV)											
K2.2.1 Austenitic-ferritic spheroidal graphite cast iron (ADI)											
N1.1.1 Wrought aluminium alloys, non-hardened, 60 HB											
N1.1.2 Wrought aluminium alloys, hardened, 100 HB											
N2.1.1 Aluminium casting alloys, non-hardened, ≤ 12 % Si, 75 HB											
N2.1.2 Aluminium casting alloys, hardened, ≤ 12 % Si, 90 HB											
N2.1.3 Aluminium casting alloys, non-hardened, > 12 % Si, 130 HB											
N3.1.1 Copper and copper alloys: Free-machining alloy, Pb > 1 %											
N3.1.2 Copper and copper alloys: CuZn, CuSnZn											
N3.1.3 Copper and copper alloys: CuSn, lead-free copper and copper electrolyte											
N4.1.1 Non-metallic materials: Duroplastics, fibre-reinforced plastics	80	0.25	0.35	0.50	0.90	1.15	1.40	1.55	1.65	1.70	1.90
N4.1.2 Non-metallic materials: Hard rubber, wood, etc.	80	0.25	0.35	0.50	0.90	1.15	1.40	1.55	1.65	1.70	1.90
N4.1.3 Non-metallic materials: Graphite	48	0.25	0.35	0.50	0.90	1.15	1.40	1.55	1.65	1.70	1.90
S1.1.1 Heat-resistant alloys, Fe-based, annealed, 200 HB	40	0.10	0.20	0.25	0.45	0.60	0.70	0.75	0.80	0.85	0.95
S1.1.2 Heat-resistant alloys, Fe-based, hardened, 280 HB	40	0.10	0.20	0.25	0.45	0.60	0.70	0.75	0.80	0.85	0.95
S1.1.3 Heat-resistant alloys, Ni- or Co-based, annealed, 250 HB	40	0.10	0.20	0.25	0.45	0.60	0.70	0.75	0.80	0.85	0.95
S1.1.4 Heat-resistant alloys, Ni- or Co-based, hardened, 350 HB	40	0.10	0.20	0.25	0.45	0.60	0.70	0.75	0.80	0.85	0.95
S1.1.5 Heat-resistant alloys, Ni- or Co-based, cast, 320 HB	40	0.10	0.20	0.25	0.45	0.60	0.70	0.75	0.80	0.85	0.95
S2.1.1 Titanium alloys, pure titanium, Rm 400 N/mm ²	40	0.10	0.20	0.25	0.45	0.60	0.70	0.75	0.80	0.85	0.95
S2.1.2 Titanium alloys, Alpha and Beta alloys, hardened, Rm 1050 N/mm ²	40	0.10	0.20	0.25	0.45	0.60	0.70	0.75	0.80	0.85	0.95
H1.1.1 Hardened steel, hardened and tempered, < 55 HRC	30	0.05	0.10	0.15	0.25	0.30	0.40	0.40	0.45	0.45	0.50
H1.1.2 Hardened steel, hardened and tempered, < 60 HRC	24	0.05	0.10	0.15	0.25	0.30	0.40	0.40	0.45	0.45	0.50
H1.1.3 Hardened steel, hardened and tempered, > 60 HRC	15	0.05	0.10	0.15	0.25	0.30	0.40	0.40	0.45	0.45	0.50
H2.1.1 Chilled cast iron, 400 HB	40	0.10	0.20	0.25	0.45	0.60	0.70	0.75	0.80	0.85	0.95
H2.1.2 Chilled cast iron, hardened and tempered, < 55 HRC	40	0.10	0.20	0.25	0.45	0.60	0.70	0.75	0.80	0.85	0.95



HR 500 T



Machining group	a V _c (m/min)	f (mm/rev) with nom. Ø									
		14	16	18	20	22	24	28	32	38	42
P1.1.1 Unalloyed steel, annealed, 0.15 % C, Rm 420 N/mm ² , 125 HB	180	2.15	2.30	2.40	2.50	2.60	2.70	2.90	3.05	3.25	3.40
P1.1.2 Unalloyed steel, heat-treated, 0.15 % C, Rm 420 N/mm ² , 125 HB	180	2.15	2.30	2.40	2.50	2.60	2.70	2.90	3.05	3.25	3.40
P1.1.3 Unalloyed steel, annealed, 0.45 % C, Rm 640 N/mm ² , 190 HB	180	2.15	2.30	2.40	2.50	2.60	2.70	2.90	3.05	3.25	3.40
P1.1.4 Unalloyed steel, heat-treated, 0.45 % C, Rm 640 N/mm ² , 190 HB	180	2.15	2.30	2.40	2.50	2.60	2.70	2.90	3.05	3.25	3.40
P1.1.5 Unalloyed steel, heat-treated, 0.45 % C, Rm 850 N/mm ² , 250 HB	162	2.15	2.30	2.40	2.50	2.60	2.70	2.90	3.05	3.25	3.40
P1.1.6 Unalloyed steel, annealed, 0.75 % C, Rm 915 N/mm ² , 270 HB	162	2.15	2.30	2.40	2.50	2.60	2.70	2.90	3.05	3.25	3.40
P1.1.7 Unalloyed steel, heat-treated, 0.75 % C, Rm 1020 N/mm ² , 300 HB	144	2.15	2.30	2.40	2.50	2.60	2.70	2.90	3.05	3.25	3.40
P2.1.1 Low-alloy steel, annealed, Rm 610 N/mm ² , 180 HB	180	2.05	2.15	2.25	2.35	2.45	2.55	2.70	2.85	3.05	3.20
P2.1.2 Low-alloy steel, heat-treated, Rm 930 N/mm ² , 275 HB	180	2.05	2.15	2.25	2.35	2.45	2.55	2.70	2.85	3.05	3.20
P2.1.3 Low-alloy steel, heat-treated, Rm 1020 N/mm ² , 300 HB	180	2.05	2.15	2.25	2.35	2.45	2.55	2.70	2.85	3.05	3.20
P2.1.4 Low-alloy steel, heat-treated, Rm 1190 N/mm ² , 350 HB	121	2.05	2.15	2.25	2.35	2.45	2.55	2.70	2.85	3.05	3.20
P3.1.1 High-alloy steel and tool steel, annealed, Rm 680 N/mm ² , 200 HB	180	1.90	2.00	2.10	2.20	2.30	2.35	2.50	2.65	2.85	3.00
P3.1.2 High-alloy steel and tool steel, hardened and tempered, Rm 1100 N/mm ² , 325 HB	121	1.90	2.00	2.10	2.20	2.30	2.35	2.50	2.65	2.85	3.00
M1.1.1 Stainless steel, ferritic/martensitic, with machining additives	80	0.80	0.85	0.90	0.95	1.00	1.00	1.10	1.15	1.25	1.30
M1.1.2 Stainless steel, ferritic/martensitic, annealed, Rm 680 N/mm ² , 200 HB	62	0.80	0.85	0.90	0.95	1.00	1.00	1.10	1.15	1.25	1.30
M1.1.3 Stainless steel, ferritic/martensitic, heat-treated, Rm 810 N/mm ² , 240 HB	62	0.80	0.85	0.90	0.95	1.00	1.00	1.10	1.15	1.25	1.30
M2.1.1 Stainless steel, austenitic, quenched, 180 HB	80	0.80	0.85	0.90	0.95	1.00	1.00	1.10	1.15	1.25	1.30
M2.2.1 Duplex steel, high-strength stainless steels	50	0.80	0.85	0.90	0.95	1.00	1.00	1.10	1.15	1.25	1.30
K1.1.1 Grey cast iron, pearlitic/ferritic, 180 HB	80	1.65	1.70	1.80	1.90	1.95	2.05	2.15	2.30	2.45	2.55
K1.1.2 Grey cast iron, pearlitic/martensitic, 260 HB	72	1.65	1.70	1.80	1.90	1.95	2.05	2.15	2.30	2.45	2.55
K1.2.1 Cast iron with spheroidal graphite, ferritic, 160 HB	96	1.65	1.70	1.80	1.90	1.95	2.05	2.15	2.30	2.45	2.55
K1.2.2 Cast iron with spheroidal graphite, pearlitic, 250 HB	96	1.65	1.70	1.80	1.90	1.95	2.05	2.15	2.30	2.45	2.55
K1.3.1 Malleable cast iron, ferritic, 130 HB	80	1.65	1.70	1.80	1.90	1.95	2.05	2.15	2.30	2.45	2.55
K1.3.2 Malleable cast iron, pearlitic, 230 HB	72	1.65	1.70	1.80	1.90	1.95	2.05	2.15	2.30	2.45	2.55
K2.1.1 Vermicular graphite cast iron (GJV)											
K2.2.1 Austenitic-ferritic spheroidal graphite cast iron (ADI)											
N1.1.1 Wrought aluminium alloys, non-hardened, 60 HB											
N1.1.2 Wrought aluminium alloys, hardened, 100 HB											
N2.1.1 Aluminium casting alloys, non-hardened, ≤ 12 % Si, 75 HB											
N2.1.2 Aluminium casting alloys, hardened, ≤ 12 % Si, 90 HB											
N2.1.3 Aluminium casting alloys, non-hardened, > 12 % Si, 130 HB											
N3.1.1 Copper and copper alloys: Free-machining alloy, Pb > 1 %											
N3.1.2 Copper and copper alloys: CuZn, CuSnZn											
N3.1.3 Copper and copper alloys: CuSn, lead-free copper and copper electrolyte											
N4.1.1 Non-metallic materials: Duroplastics, fibre-reinforced plastics	80	1.65	1.70	1.80	1.90	1.95	2.05	2.15	2.30	2.45	2.55
N4.1.2 Non-metallic materials: Hard rubber, wood, etc.	80	1.65	1.70	1.80	1.90	1.95	2.05	2.15	2.30	2.45	2.55
N4.1.3 Non-metallic materials: Graphite	48	1.65	1.70	1.80	1.90	1.95	2.05	2.15	2.30	2.45	2.55
S1.1.1 Heat-resistant alloys, Fe-based, annealed, 200 HB	40	0.80	0.85	0.90	0.95	1.00	1.00	1.10	1.15	1.25	1.30
S1.1.2 Heat-resistant alloys, Fe-based, hardened, 280 HB	40	0.80	0.85	0.90	0.95	1.00	1.00	1.10	1.15	1.25	1.30
S1.1.3 Heat-resistant alloys, Ni- or Co-based, annealed, 250 HB	40	0.80	0.85	0.90	0.95	1.00	1.00	1.10	1.15	1.25	1.30
S1.1.4 Heat-resistant alloys, Ni- or Co-based, hardened, 350 HB	40	0.80	0.85	0.90	0.95	1.00	1.00	1.10	1.15	1.25	1.30
S1.1.5 Heat-resistant alloys, Ni- or Co-based, cast, 320 HB	40	0.80	0.85	0.90	0.95	1.00	1.00	1.10	1.15	1.25	1.30
S2.1.1 Titanium alloys, pure titanium, Rm 400 N/mm ²	40	0.80	0.85	0.90	0.95	1.00	1.00	1.10	1.15	1.25	1.30
S2.1.2 Titanium alloys, Alpha and Beta alloys, hardened, Rm 1050 N/mm ²	40	0.80	0.85	0.90	0.95	1.00	1.00	1.10	1.15	1.25	1.30
H1.1.1 Hardened steel, hardened and tempered, < 55 HRC	30	0.45	0.45	0.50	0.50	0.50	0.55	0.60	0.60	0.65	0.70
H1.1.2 Hardened steel, hardened and tempered, < 60 HRC	24	0.45	0.45	0.50	0.50	0.50	0.55	0.60	0.60	0.65	0.70
H1.1.3 Hardened steel, hardened and tempered, > 60 HRC	15	0.45	0.45	0.50	0.50	0.50	0.55	0.60	0.60	0.65	0.70
H2.1.1 Chilled cast iron, 400 HB	40	0.80	0.85	0.90	0.95	1.00	1.00	1.10	1.15	1.25	1.30
H2.1.2 Chilled cast iron, hardened and tempered, < 55 HRC	40	0.80	0.85	0.90	0.95	1.00	1.00	1.10	1.15	1.25	1.30

Cutting data



HR 500 Cast



Cutting data

Machining group	V _c (m/min)	f (mm/rev) with nom. Ø								
		3	4	6	8	10	12	14	16	20
P1.1.1 Unalloyed steel, annealed, 0.15 % C, Rm 420 N/mm ² , 125 HB										
P1.1.2 Unalloyed steel, heat-treated, 0.15 % C, Rm 420 N/mm ² , 125 HB										
P1.1.3 Unalloyed steel, annealed, 0.45 % C, Rm 640 N/mm ² , 190 HB										
P1.1.4 Unalloyed steel, heat-treated, 0.45 % C, Rm 640 N/mm ² , 190 HB										
P1.1.5 Unalloyed steel, heat-treated, 0.45 % C, Rm 850 N/mm ² , 250 HB										
P1.1.6 Unalloyed steel, annealed, 0.75 % C, Rm 915 N/mm ² , 270 HB										
P1.1.7 Unalloyed steel, heat-treated, 0.75 % C, Rm 1020 N/mm ² , 300 HB										
P2.1.1 Low-alloy steel, annealed, Rm 610 N/mm ² , 180 HB										
P2.1.2 Low-alloy steel, heat-treated, Rm 930 N/mm ² , 275 HB										
P2.1.3 Low-alloy steel, heat-treated, Rm 1020 N/mm ² , 300 HB										
P2.1.4 Low-alloy steel, heat-treated, Rm 1190 N/mm ² , 350 HB										
P3.1.1 High-alloy steel and tool steel, annealed, Rm 680 N/mm ² , 200 HB										
P3.1.2 High-alloy steel and tool steel, hardened and tempered, Rm 1100 N/mm ² , 325 HB										
M1.1.1 Stainless steel, ferritic/martensitic, with machining additives										
M1.1.2 Stainless steel, ferritic/martensitic, annealed, Rm 680 N/mm ² , 200 HB										
M1.1.3 Stainless steel, ferritic/martensitic, heat-treated, Rm 810 N/mm ² , 240 HB										
M2.1.1 Stainless steel, austenitic, quenched, 180 HB										
M2.2.1 Duplex steel, high-strength stainless steels										
K1.1.1 Grey cast iron, pearlitic/ferritic, 180 HB	200	0.55	0.75	1.35	1.75	2.15	2.30	2.45	2.60	2.85
K1.1.2 Grey cast iron, pearlitic/martensitic, 260 HB	200	0.55	0.75	1.35	1.75	2.15	2.30	2.45	2.60	2.85
K1.2.1 Cast iron with spheroidal graphite, ferritic, 160 HB	220	0.20	0.25	0.45	0.60	0.70	0.75	0.80	0.85	0.95
K1.2.2 Cast iron with spheroidal graphite, pearlitic, 250 HB	220	0.20	0.25	0.45	0.60	0.70	0.75	0.80	0.85	0.95
K1.3.1 Malleable cast iron, ferritic, 130 HB	100	0.20	0.25	0.45	0.60	0.70	0.75	0.80	0.85	0.95
K1.3.2 Malleable cast iron, pearlitic, 230 HB	80	0.20	0.25	0.45	0.60	0.70	0.75	0.80	0.85	0.95
K2.1.1 Vermicular graphite cast iron (GJV)	80	0.35	0.50	0.90	1.15	1.40	1.55	1.65	1.70	1.90
K2.2.1 Austenitic-ferritic spheroidal graphite cast iron (ADI)	80	0.35	0.50	0.90	1.15	1.40	1.55	1.65	1.70	1.90
N1.1.1 Wrought aluminium alloys, non-hardened, 60 HB										
N1.1.2 Wrought aluminium alloys, hardened, 100 HB										
N2.1.1 Aluminium casting alloys, non-hardened, ≤ 12 % Si, 75 HB										
N2.1.2 Aluminium casting alloys, hardened, ≤ 12 % Si, 90 HB										
N2.1.3 Aluminium casting alloys, non-hardened, > 12 % Si, 130 HB										
N3.1.1 Copper and copper alloys: Free-machining alloy, Pb > 1 %										
N3.1.2 Copper and copper alloys: CuZn, CuSnZn										
N3.1.3 Copper and copper alloys: CuSn, lead-free copper and copper electrolyte										
N4.1.1 Non-metallic materials: Duroplastics, fibre-reinforced plastics										
N4.1.2 Non-metallic materials: Hard rubber, wood, etc.										
N4.1.3 Non-metallic materials: Graphite										
S1.1.1 Heat-resistant alloys, Fe-based, annealed, 200 HB										
S1.1.2 Heat-resistant alloys, Fe-based, hardened, 280 HB										
S1.1.3 Heat-resistant alloys, Ni- or Co-based, annealed, 250 HB										
S1.1.4 Heat-resistant alloys, Ni- or Co-based, hardened, 350 HB										
S1.1.5 Heat-resistant alloys, Ni- or Co-based, cast, 320 HB										
S2.1.1 Titanium alloys, pure titanium, Rm 400 N/mm ²										
S2.1.2 Titanium alloys, Alpha and Beta alloys, hardened, Rm 1050 N/mm ²										
H1.1.1 Hardened steel, hardened and tempered, < 55 HRC										
H1.1.2 Hardened steel, hardened and tempered, < 60 HRC										
H1.1.3 Hardened steel, hardened and tempered, > 60 HRC										
H2.1.1 Chilled cast iron, 400 HB										
H2.1.2 Chilled cast iron, hardened and tempered, < 55 HRC										



HR 500 Alu



Machining group	C _B (m/min)	f (mm/rev) with nom. Ø								
		3	4	6	8	10	12	14	16	20
P1.1.1 Unalloyed steel, annealed, 0.15 % C, Rm 420 N/mm ² , 125 HB										
P1.1.2 Unalloyed steel, heat-treated, 0.15 % C, Rm 420 N/mm ² , 125 HB										
P1.1.3 Unalloyed steel, annealed, 0.45 % C, Rm 640 N/mm ² , 190 HB										
P1.1.4 Unalloyed steel, heat-treated, 0.45 % C, Rm 640 N/mm ² , 190 HB										
P1.1.5 Unalloyed steel, heat-treated, 0.45 % C, Rm 850 N/mm ² , 250 HB										
P1.1.6 Unalloyed steel, annealed, 0.75 % C, Rm 915 N/mm ² , 270 HB										
P1.1.7 Unalloyed steel, heat-treated, 0.75 % C, Rm 1020 N/mm ² , 300 HB										
P2.1.1 Low-alloy steel, annealed, Rm 610 N/mm ² , 180 HB										
P2.1.2 Low-alloy steel, heat-treated, Rm 930 N/mm ² , 275 HB										
P2.1.3 Low-alloy steel, heat-treated, Rm 1020 N/mm ² , 300 HB										
P2.1.4 Low-alloy steel, heat-treated, Rm 1190 N/mm ² , 350 HB										
P3.1.1 High-alloy steel and tool steel, annealed, Rm 680 N/mm ² , 200 HB										
P3.1.2 High-alloy steel and tool steel, hardened and tempered, Rm 1100 N/mm ² , 325 HB										
M1.1.1 Stainless steel, ferritic/martensitic, with machining additives										
M1.1.2 Stainless steel, ferritic/martensitic, annealed, Rm 680 N/mm ² , 200 HB										
M1.1.3 Stainless steel, ferritic/martensitic, heat-treated, Rm 810 N/mm ² , 240 HB										
M2.1.1 Stainless steel, austenitic, quenched, 180 HB										
M2.2.1 Duplex steel, high-strength stainless steels										
K1.1.1 Grey cast iron, pearlitic/ferritic, 180 HB										
K1.1.2 Grey cast iron, pearlitic/martensitic, 260 HB										
K1.2.1 Cast iron with spheroidal graphite, ferritic, 160 HB										
K1.2.2 Cast iron with spheroidal graphite, pearlitic, 250 HB										
K1.3.1 Malleable cast iron, ferritic, 130 HB										
K1.3.2 Malleable cast iron, pearlitic, 230 HB										
K2.1.1 Vermicular graphite cast iron (GJV)										
K2.2.1 Austenitic-ferritic spheroidal graphite cast iron (ADI)										
N1.1.1 Wrought aluminium alloys, non-hardened, 60 HB	220	0.55	0.75	1.35	1.75	2.15	2.30	2.45	2.60	2.85
N1.1.2 Wrought aluminium alloys, hardened, 100 HB	220	0.55	0.75	1.35	1.75	2.15	2.30	2.45	2.60	2.85
N2.1.1 Aluminium casting alloys, non-hardened, ≤ 12 % Si, 75 HB	220	0.55	0.75	1.35	1.75	2.15	2.30	2.45	2.60	2.85
N2.1.2 Aluminium casting alloys, hardened, ≤ 12 % Si, 90 HB	200	0.55	0.75	1.35	1.75	2.15	2.30	2.45	2.60	2.85
N2.1.3 Aluminium casting alloys, non-hardened, > 12 % Si, 130 HB	200	0.55	0.75	1.35	1.75	2.15	2.30	2.45	2.60	2.85
N3.1.1 Copper and copper alloys: Free-machining alloy, Pb > 1 %										
N3.1.2 Copper and copper alloys: CuZn, CuSnZn										
N3.1.3 Copper and copper alloys: CuSn, lead-free copper and copper electrolyte										
N4.1.1 Non-metallic materials: Duroplastics, fibre-reinforced plastics										
N4.1.2 Non-metallic materials: Hard rubber, wood, etc.										
N4.1.3 Non-metallic materials: Graphite										
S1.1.1 Heat-resistant alloys, Fe-based, annealed, 200 HB										
S1.1.2 Heat-resistant alloys, Fe-based, hardened, 280 HB										
S1.1.3 Heat-resistant alloys, Ni- or Co-based, annealed, 250 HB										
S1.1.4 Heat-resistant alloys, Ni- or Co-based, hardened, 350 HB										
S1.1.5 Heat-resistant alloys, Ni- or Co-based, cast, 320 HB										
S2.1.1 Titanium alloys, pure titanium, Rm 400 N/mm ²										
S2.1.2 Titanium alloys, Alpha and Beta alloys, hardened, Rm 1050 N/mm ²										
H1.1.1 Hardened steel, hardened and tempered, < 55 HRC										
H1.1.2 Hardened steel, hardened and tempered, < 60 HRC										
H1.1.3 Hardened steel, hardened and tempered, > 60 HRC										
H2.1.1 Chilled cast iron, 400 HB										
H2.1.2 Chilled cast iron, hardened and tempered, < 55 HRC										

Cutting data



HR 500 G, Carbide-tipped



Cutting data

Machining group	a v _c (m/min)	f (mm/rev) with nom. Ø				
		22	26	30	35	40
P1.1.1 Unalloyed steel, annealed, 0.15 % C, Rm 420 N/mm ² , 125 HB	30	1.00	1.05	1.10	1.20	1.25
P1.1.2 Unalloyed steel, heat-treated, 0.15 % C, Rm 420 N/mm ² , 125 HB	30	1.00	1.05	1.10	1.20	1.25
P1.1.3 Unalloyed steel, annealed, 0.45 % C, Rm 640 N/mm ² , 190 HB	30	1.00	1.05	1.10	1.20	1.25
P1.1.4 Unalloyed steel, heat-treated, 0.45 % C, Rm 640 N/mm ² , 190 HB	30	1.00	1.05	1.10	1.20	1.25
P1.1.5 Unalloyed steel, heat-treated, 0.45 % C, Rm 850 N/mm ² , 250 HB	27	1.00	1.05	1.10	1.20	1.25
P1.1.6 Unalloyed steel, annealed, 0.75 % C, Rm 915 N/mm ² , 270 HB	27	1.00	1.05	1.10	1.20	1.25
P1.1.7 Unalloyed steel, heat-treated, 0.75 % C, Rm 1020 N/mm ² , 300 HB	24	1.00	1.05	1.10	1.20	1.25
P2.1.1 Low-alloy steel, annealed, Rm 610 N/mm ² , 180 HB	30	1.00	1.05	1.10	1.20	1.25
P2.1.2 Low-alloy steel, heat-treated, Rm 930 N/mm ² , 275 HB	30	1.00	1.05	1.10	1.20	1.25
P2.1.3 Low-alloy steel, heat-treated, Rm 1020 N/mm ² , 300 HB	30	1.00	1.05	1.10	1.20	1.25
P2.1.4 Low-alloy steel, heat-treated, Rm 1190 N/mm ² , 350 HB	20	1.00	1.05	1.10	1.20	1.25
P3.1.1 High-alloy steel and tool steel, annealed, Rm 680 N/mm ² , 200 HB	30	1.00	1.05	1.10	1.20	1.25
P3.1.2 High-alloy steel and tool steel, hardened and tempered, Rm 1100 N/mm ² , 325 HB	20	1.00	1.05	1.10	1.20	1.25
M1.1.1 Stainless steel, ferritic/martensitic, with machining additives	40	1.00	1.05	1.10	1.20	1.25
M1.1.2 Stainless steel, ferritic/martensitic, annealed, Rm 680 N/mm ² , 200 HB	31	1.00	1.05	1.10	1.20	1.25
M1.1.3 Stainless steel, ferritic/martensitic, heat-treated, Rm 810 N/mm ² , 240 HB	31	1.00	1.05	1.10	1.20	1.25
M2.1.1 Stainless steel, austenitic, quenched, 180 HB	20	1.00	1.05	1.10	1.20	1.25
M2.2.1 Duplex steel, high-strength stainless steels	13	1.00	1.05	1.10	1.20	1.25
K1.1.1 Grey cast iron, pearlitic/ferritic, 180 HB	60	1.95	2.10	2.25	2.35	2.50
K1.1.2 Grey cast iron, pearlitic/martensitic, 260 HB	54	1.95	2.10	2.25	2.35	2.50
K1.2.1 Cast iron with spheroidal graphite, ferritic, 160 HB	72	1.95	2.10	2.25	2.35	2.50
K1.2.2 Cast iron with spheroidal graphite, pearlitic, 250 HB	72	1.95	2.10	2.25	2.35	2.50
K1.3.1 Malleable cast iron, ferritic, 130 HB	60	1.95	2.10	2.25	2.35	2.50
K1.3.2 Malleable cast iron, pearlitic, 230 HB	54	1.95	2.10	2.25	2.35	2.50
K2.1.1 Vermicular graphite cast iron (GJV)						
K2.2.1 Austenitic-ferritic spheroidal graphite cast iron (ADI)						
N1.1.1 Wrought aluminium alloys, non-hardened, 60 HB						
N1.1.2 Wrought aluminium alloys, hardened, 100 HB						
N2.1.1 Aluminium casting alloys, non-hardened, ≤ 12 % Si, 75 HB						
N2.1.2 Aluminium casting alloys, hardened, ≤ 12 % Si, 90 HB						
N2.1.3 Aluminium casting alloys, non-hardened, > 12 % Si, 130 HB						
N3.1.1 Copper and copper alloys: Free-machining alloy, Pb > 1 %						
N3.1.2 Copper and copper alloys: CuZn, CuSnZn						
N3.1.3 Copper and copper alloys: CuSn, lead-free copper and copper electrolyte						
N4.1.1 Non-metallic materials: Duroplastics, fibre-reinforced plastics	80	1.00	1.05	1.10	1.20	1.25
N4.1.2 Non-metallic materials: Hard rubber, wood, etc.	80	1.00	1.05	1.10	1.20	1.25
N4.1.3 Non-metallic materials: Graphite	48	1.00	1.05	1.10	1.20	1.25
S1.1.1 Heat-resistant alloys, Fe-based, annealed, 200 HB	20	0.50	0.55	0.60	0.65	0.65
S1.1.2 Heat-resistant alloys, Fe-based, hardened, 280 HB	20	0.50	0.55	0.60	0.65	0.65
S1.1.3 Heat-resistant alloys, Ni- or Co-based, annealed, 250 HB	20	0.50	0.55	0.60	0.65	0.65
S1.1.4 Heat-resistant alloys, Ni- or Co-based, hardened, 350 HB	20	0.50	0.55	0.60	0.65	0.65
S1.1.5 Heat-resistant alloys, Ni- or Co-based, cast, 320 HB	20	0.50	0.55	0.60	0.65	0.65
S2.1.1 Titanium alloys, pure titanium, Rm 400 N/mm ²	20	0.50	0.55	0.60	0.65	0.65
S2.1.2 Titanium alloys, Alpha and Beta alloys, hardened, Rm 1050 N/mm ²	20	0.50	0.55	0.60	0.65	0.65
H1.1.1 Hardened steel, hardened and tempered, < 55 HRC						
H1.1.2 Hardened steel, hardened and tempered, < 60 HRC						
H1.1.3 Hardened steel, hardened and tempered, > 60 HRC						
H2.1.1 Chilled cast iron, 400 HB						
H2.1.2 Chilled cast iron, hardened and tempered, < 55 HRC						



HR 500 G, Cermet-tipped



Machining group	V _c (m/min)	f (mm/rev) with nom. Ø									
		6	8	10	14	18	20	26	30	35	40
P1.1.1 Unalloyed steel, annealed, 0.15 % C, Rm 420 N/mm ² , 125 HB	130	0.90	1.15	1.40	1.65	1.80	1.90	2.10	2.25	2.35	2.50
P1.1.2 Unalloyed steel, heat-treated, 0.15 % C, Rm 420 N/mm ² , 125 HB	130	0.90	1.15	1.40	1.65	1.80	1.90	2.10	2.25	2.35	2.50
P1.1.3 Unalloyed steel, annealed, 0.45 % C, Rm 640 N/mm ² , 190 HB	130	0.90	1.15	1.40	1.65	1.80	1.90	2.10	2.25	2.35	2.50
P1.1.4 Unalloyed steel, heat-treated, 0.45 % C, Rm 640 N/mm ² , 190 HB	130	0.90	1.15	1.40	1.65	1.80	1.90	2.10	2.25	2.35	2.50
P1.1.5 Unalloyed steel, heat-treated, 0.45 % C, Rm 850 N/mm ² , 250 HB	117	0.90	1.15	1.40	1.65	1.80	1.90	2.10	2.25	2.35	2.50
P1.1.6 Unalloyed steel, annealed, 0.75 % C, Rm 915 N/mm ² , 270 HB	117	0.90	1.15	1.40	1.65	1.80	1.90	2.10	2.25	2.35	2.50
P1.1.7 Unalloyed steel, heat-treated, 0.75 % C, Rm 1020 N/mm ² , 300 HB	104	0.90	1.15	1.40	1.65	1.80	1.90	2.10	2.25	2.35	2.50
P2.1.1 Low-alloy steel, annealed, Rm 610 N/mm ² , 180 HB	130	0.90	1.15	1.40	1.65	1.80	1.90	2.10	2.25	2.35	2.50
P2.1.2 Low-alloy steel, heat-treated, Rm 930 N/mm ² , 275 HB	130	0.90	1.15	1.40	1.65	1.80	1.90	2.10	2.25	2.35	2.50
P2.1.3 Low-alloy steel, heat-treated, Rm 1020 N/mm ² , 300 HB	130	0.90	1.15	1.40	1.65	1.80	1.90	2.10	2.25	2.35	2.50
P2.1.4 Low-alloy steel, heat-treated, Rm 1190 N/mm ² , 350 HB	87	0.90	1.15	1.40	1.65	1.80	1.90	2.10	2.25	2.35	2.50
P3.1.1 High-alloy steel and tool steel, annealed, Rm 680 N/mm ² , 200 HB	130	0.90	1.15	1.40	1.65	1.80	1.90	2.10	2.25	2.35	2.50
P3.1.2 High-alloy steel and tool steel, hardened and tempered, Rm 1100 N/mm ² , 325 HB	87	0.90	1.15	1.40	1.65	1.80	1.90	2.10	2.25	2.35	2.50
M1.1.1 Stainless steel, ferritic/martensitic, with machining additives											
M1.1.2 Stainless steel, ferritic/martensitic, annealed, Rm 680 N/mm ² , 200 HB											
M1.1.3 Stainless steel, ferritic/martensitic, heat-treated, Rm 810 N/mm ² , 240 HB											
M2.1.1 Stainless steel, austenitic, quenched, 180 HB											
M2.2.1 Duplex steel, high-strength stainless steels											
K1.1.1 Grey cast iron, pearlitic/ferritic, 180 HB											
K1.1.2 Grey cast iron, pearlitic/martensitic, 260 HB											
K1.2.1 Cast iron with spheroidal graphite, ferritic, 160 HB	160	0.60	0.80	0.95	1.10	1.20	1.25	1.40	1.50	1.60	1.65
K1.2.2 Cast iron with spheroidal graphite, pearlitic, 250 HB	160	0.60	0.80	0.95	1.10	1.20	1.25	1.40	1.50	1.60	1.65
K1.3.1 Malleable cast iron, ferritic, 130 HB											
K1.3.2 Malleable cast iron, pearlitic, 230 HB											
K2.1.1 Vermicular graphite cast iron (GJV)											
K2.2.1 Austenitic-ferritic spheroidal graphite cast iron (ADI)											
N1.1.1 Wrought aluminium alloys, non-hardened, 60 HB											
N1.1.2 Wrought aluminium alloys, hardened, 100 HB											
N2.1.1 Aluminium casting alloys, non-hardened, ≤ 12 % Si, 75 HB											
N2.1.2 Aluminium casting alloys, hardened, ≤ 12 % Si, 90 HB											
N2.1.3 Aluminium casting alloys, non-hardened, > 12 % Si, 130 HB											
N3.1.1 Copper and copper alloys: Free-machining alloy, Pb > 1 %											
N3.1.2 Copper and copper alloys: CuZn, CuSnZn											
N3.1.3 Copper and copper alloys: CuSn, lead-free copper and copper electrolyte											
N4.1.1 Non-metallic materials: Duroplastics, fibre-reinforced plastics											
N4.1.2 Non-metallic materials: Hard rubber, wood, etc.											
N4.1.3 Non-metallic materials: Graphite											
S1.1.1 Heat-resistant alloys, Fe-based, annealed, 200 HB											
S1.1.2 Heat-resistant alloys, Fe-based, hardened, 280 HB											
S1.1.3 Heat-resistant alloys, Ni- or Co-based, annealed, 250 HB											
S1.1.4 Heat-resistant alloys, Ni- or Co-based, hardened, 350 HB											
S1.1.5 Heat-resistant alloys, Ni- or Co-based, cast, 320 HB											
S2.1.1 Titanium alloys, pure titanium, Rm 400 N/mm ²											
S2.1.2 Titanium alloys, Alpha and Beta alloys, hardened, Rm 1050 N/mm ²											
H1.1.1 Hardened steel, hardened and tempered, < 55 HRC											
H1.1.2 Hardened steel, hardened and tempered, < 60 HRC											
H1.1.3 Hardened steel, hardened and tempered, > 60 HRC											
H2.1.1 Chilled cast iron, 400 HB											
H2.1.2 Chilled cast iron, hardened and tempered, < 55 HRC											

Cutting data



HR 500 GT, Carbide-tipped



Cutting data

Machining group	a V _c (m/min)	f (mm/rev) with nom. Ø									
		40	45	50	55	60	65	70	75	80	
P1.1.1 Unalloyed steel, annealed, 0.15 % C, Rm 420 N/mm ² , 125 HB	30	1.25	1.30	1.35	1.45	1.50	1.55	1.60	1.60	1.65	
P1.1.2 Unalloyed steel, heat-treated, 0.15 % C, Rm 420 N/mm ² , 125 HB	30	1.25	1.30	1.35	1.45	1.50	1.55	1.60	1.60	1.65	
P1.1.3 Unalloyed steel, annealed, 0.45 % C, Rm 640 N/mm ² , 190 HB	30	1.25	1.30	1.35	1.45	1.50	1.55	1.60	1.60	1.65	
P1.1.4 Unalloyed steel, heat-treated, 0.45 % C, Rm 640 N/mm ² , 190 HB	30	1.25	1.30	1.35	1.45	1.50	1.55	1.60	1.60	1.65	
P1.1.5 Unalloyed steel, heat-treated, 0.45 % C, Rm 850 N/mm ² , 250 HB	27	1.25	1.30	1.35	1.45	1.50	1.55	1.60	1.60	1.65	
P1.1.6 Unalloyed steel, annealed, 0.75 % C, Rm 915 N/mm ² , 270 HB	27	1.25	1.30	1.35	1.45	1.50	1.55	1.60	1.60	1.65	
P1.1.7 Unalloyed steel, heat-treated, 0.75 % C, Rm 1020 N/mm ² , 300 HB	24	1.25	1.30	1.35	1.45	1.50	1.55	1.60	1.60	1.65	
P2.1.1 Low-alloy steel, annealed, Rm 610 N/mm ² , 180 HB	30	1.25	1.30	1.35	1.45	1.50	1.55	1.60	1.60	1.65	
P2.1.2 Low-alloy steel, heat-treated, Rm 930 N/mm ² , 275 HB	30	1.25	1.30	1.35	1.45	1.50	1.55	1.60	1.60	1.65	
P2.1.3 Low-alloy steel, heat-treated, Rm 1020 N/mm ² , 300 HB	30	1.25	1.30	1.35	1.45	1.50	1.55	1.60	1.60	1.65	
P2.1.4 Low-alloy steel, heat-treated, Rm 1190 N/mm ² , 350 HB	20	1.25	1.30	1.35	1.45	1.50	1.55	1.60	1.60	1.65	
P3.1.1 High-alloy steel and tool steel, annealed, Rm 680 N/mm ² , 200 HB	30	1.25	1.30	1.35	1.45	1.50	1.55	1.60	1.60	1.65	
P3.1.2 High-alloy steel and tool steel, hardened and tempered, Rm 1100 N/mm ² , 325 HB	20	1.25	1.30	1.35	1.45	1.50	1.55	1.60	1.60	1.65	
M1.1.1 Stainless steel, ferritic/martensitic, with machining additives	40	1.25	1.30	1.35	1.45	1.50	1.55	1.60	1.60	1.65	
M1.1.2 Stainless steel, ferritic/martensitic, annealed, Rm 680 N/mm ² , 200 HB	31	1.25	1.30	1.35	1.45	1.50	1.55	1.60	1.60	1.65	
M1.1.3 Stainless steel, ferritic/martensitic, heat-treated, Rm 810 N/mm ² , 240 HB	31	1.25	1.30	1.35	1.45	1.50	1.55	1.60	1.60	1.65	
M2.1.1 Stainless steel, austenitic, quenched, 180 HB	20	1.25	1.30	1.35	1.45	1.50	1.55	1.60	1.60	1.65	
M2.2.1 Duplex steel, high-strength stainless steels	13	1.25	1.30	1.35	1.45	1.50	1.55	1.60	1.60	1.65	
K1.1.1 Grey cast iron, pearlitic/ferritic, 180 HB	60	2.50	2.65	2.75	2.85	2.95	3.05	3.15	3.25	3.35	
K1.1.2 Grey cast iron, pearlitic/martensitic, 260 HB	54	2.50	2.65	2.75	2.85	2.95	3.05	3.15	3.25	3.35	
K1.2.1 Cast iron with spheroidal graphite, ferritic, 160 HB	72	2.50	2.65	2.75	2.85	2.95	3.05	3.15	3.25	3.35	
K1.2.2 Cast iron with spheroidal graphite, pearlitic, 250 HB	72	2.50	2.65	2.75	2.85	2.95	3.05	3.15	3.25	3.35	
K1.3.1 Malleable cast iron, ferritic, 130 HB	60	2.50	2.65	2.75	2.85	2.95	3.05	3.15	3.25	3.35	
K1.3.2 Malleable cast iron, pearlitic, 230 HB	54	2.50	2.65	2.75	2.85	2.95	3.05	3.15	3.25	3.35	
K2.1.1 Vermicular graphite cast iron (GJV)											
K2.2.1 Austenitic-ferritic spheroidal graphite cast iron (ADI)											
N1.1.1 Wrought aluminium alloys, non-hardened, 60 HB											
N1.1.2 Wrought aluminium alloys, hardened, 100 HB											
N2.1.1 Aluminium casting alloys, non-hardened, ≤ 12 % Si, 75 HB											
N2.1.2 Aluminium casting alloys, hardened, ≤ 12 % Si, 90 HB											
N2.1.3 Aluminium casting alloys, non-hardened, > 12 % Si, 130 HB											
N3.1.1 Copper and copper alloys: Free-machining alloy, Pb > 1 %											
N3.1.2 Copper and copper alloys: CuZn, CuSnZn											
N3.1.3 Copper and copper alloys: CuSn, lead-free copper and copper electrolyte											
N4.1.1 Non-metallic materials: Duroplastics, fibre-reinforced plastics	80	1.25	1.30	1.35	1.45	1.50	1.55	1.60	1.60	1.65	
N4.1.2 Non-metallic materials: Hard rubber, wood, etc.	80	1.25	1.30	1.35	1.45	1.50	1.55	1.60	1.60	1.65	
N4.1.3 Non-metallic materials: Graphite	48	1.25	1.30	1.35	1.45	1.50	1.55	1.60	1.60	1.65	
S1.1.1 Heat-resistant alloys, Fe-based, annealed, 200 HB	20	0.65	0.70	0.75	0.75	0.80	0.80	0.85	0.85	0.90	
S1.1.2 Heat-resistant alloys, Fe-based, hardened, 280 HB	20	0.65	0.70	0.75	0.75	0.80	0.80	0.85	0.85	0.90	
S1.1.3 Heat-resistant alloys, Ni- or Co-based, annealed, 250 HB	20	0.65	0.70	0.75	0.75	0.80	0.80	0.85	0.85	0.90	
S1.1.4 Heat-resistant alloys, Ni- or Co-based, hardened, 350 HB	20	0.65	0.70	0.75	0.75	0.80	0.80	0.85	0.85	0.90	
S1.1.5 Heat-resistant alloys, Ni- or Co-based, cast, 320 HB	20	0.65	0.70	0.75	0.75	0.80	0.80	0.85	0.85	0.90	
S2.1.1 Titanium alloys, pure titanium, Rm 400 N/mm ²	20	0.65	0.70	0.75	0.75	0.80	0.80	0.85	0.85	0.90	
S2.1.2 Titanium alloys, Alpha and Beta alloys, hardened, Rm 1050 N/mm ²	20	0.65	0.70	0.75	0.75	0.80	0.80	0.85	0.85	0.90	
H1.1.1 Hardened steel, hardened and tempered, < 55 HRC											
H1.1.2 Hardened steel, hardened and tempered, < 60 HRC											
H1.1.3 Hardened steel, hardened and tempered, > 60 HRC											
H2.1.1 Chilled cast iron, 400 HB											
H2.1.2 Chilled cast iron, hardened and tempered, < 55 HRC											



HR 500 GT, Cermet-tipped



Machining group	V _c (m/min)	f (mm/rev) with nom. Ø									
		40	45	50	55	60	65	70	75	80	
P1.1.1 Unalloyed steel, annealed, 0.15 % C, Rm 420 N/mm ² , 125 HB	130	2.50	2.65	2.75	2.85	2.95	3.05	3.15	3.25	3.35	
P1.1.2 Unalloyed steel, heat-treated, 0.15 % C, Rm 420 N/mm ² , 125 HB	130	2.50	2.65	2.75	2.85	2.95	3.05	3.15	3.25	3.35	
P1.1.3 Unalloyed steel, annealed, 0.45 % C, Rm 640 N/mm ² , 190 HB	130	2.50	2.65	2.75	2.85	2.95	3.05	3.15	3.25	3.35	
P1.1.4 Unalloyed steel, heat-treated, 0.45 % C, Rm 640 N/mm ² , 190 HB	130	2.50	2.65	2.75	2.85	2.95	3.05	3.15	3.25	3.35	
P1.1.5 Unalloyed steel, heat-treated, 0.45 % C, Rm 850 N/mm ² , 250 HB	117	2.50	2.65	2.75	2.85	2.95	3.05	3.15	3.25	3.35	
P1.1.6 Unalloyed steel, annealed, 0.75 % C, Rm 915 N/mm ² , 270 HB	117	2.50	2.65	2.75	2.85	2.95	3.05	3.15	3.25	3.35	
P1.1.7 Unalloyed steel, heat-treated, 0.75 % C, Rm 1020 N/mm ² , 300 HB	104	2.50	2.65	2.75	2.85	2.95	3.05	3.15	3.25	3.35	
P2.1.1 Low-alloy steel, annealed, Rm 610 N/mm ² , 180 HB	130	2.50	2.65	2.75	2.85	2.95	3.05	3.15	3.25	3.35	
P2.1.2 Low-alloy steel, heat-treated, Rm 930 N/mm ² , 275 HB	130	2.50	2.65	2.75	2.85	2.95	3.05	3.15	3.25	3.35	
P2.1.3 Low-alloy steel, heat-treated, Rm 1020 N/mm ² , 300 HB	130	2.50	2.65	2.75	2.85	2.95	3.05	3.15	3.25	3.35	
P2.1.4 Low-alloy steel, heat-treated, Rm 1190 N/mm ² , 350 HB	87	2.50	2.65	2.75	2.85	2.95	3.05	3.15	3.25	3.35	
P3.1.1 High-alloy steel and tool steel, annealed, Rm 680 N/mm ² , 200 HB	130	2.50	2.65	2.75	2.85	2.95	3.05	3.15	3.25	3.35	
P3.1.2 High-alloy steel and tool steel, hardened and tempered, Rm 1100 N/mm ² , 325 HB	87	2.50	2.65	2.75	2.85	2.95	3.05	3.15	3.25	3.35	
M1.1.1 Stainless steel, ferritic/martensitic, with machining additives											
M1.1.2 Stainless steel, ferritic/martensitic, annealed, Rm 680 N/mm ² , 200 HB											
M1.1.3 Stainless steel, ferritic/martensitic, heat-treated, Rm 810 N/mm ² , 240 HB											
M2.1.1 Stainless steel, austenitic, quenched, 180 HB											
M2.2.1 Duplex steel, high-strength stainless steels											
K1.1.1 Grey cast iron, pearlitic/ferritic, 180 HB											
K1.1.2 Grey cast iron, pearlitic/martensitic, 260 HB											
K1.2.1 Cast iron with spheroidal graphite, ferritic, 160 HB	160	1.25	1.30	1.35	1.45	1.50	1.55	1.60	1.60	1.65	
K1.2.2 Cast iron with spheroidal graphite, pearlitic, 250 HB	160	1.25	1.30	1.35	1.45	1.50	1.55	1.60	1.60	1.65	
K1.3.1 Malleable cast iron, ferritic, 130 HB											
K1.3.2 Malleable cast iron, pearlitic, 230 HB											
K2.1.1 Vermicular graphite cast iron (GJV)											
K2.2.1 Austenitic-ferritic spheroidal graphite cast iron (ADI)											
N1.1.1 Wrought aluminium alloys, non-hardened, 60 HB											
N1.1.2 Wrought aluminium alloys, hardened, 100 HB											
N2.1.1 Aluminium casting alloys, non-hardened, ≤ 12 % Si, 75 HB											
N2.1.2 Aluminium casting alloys, hardened, ≤ 12 % Si, 90 HB											
N2.1.3 Aluminium casting alloys, non-hardened, > 12 % Si, 130 HB											
N3.1.1 Copper and copper alloys: Free-machining alloy, Pb > 1 %											
N3.1.2 Copper and copper alloys: CuZn, CuSnZn											
N3.1.3 Copper and copper alloys: CuSn, lead-free copper and copper electrolyte											
N4.1.1 Non-metallic materials: Duroplastics, fibre-reinforced plastics											
N4.1.2 Non-metallic materials: Hard rubber, wood, etc.											
N4.1.3 Non-metallic materials: Graphite											
S1.1.1 Heat-resistant alloys, Fe-based, annealed, 200 HB											
S1.1.2 Heat-resistant alloys, Fe-based, hardened, 280 HB											
S1.1.3 Heat-resistant alloys, Ni- or Co-based, annealed, 250 HB											
S1.1.4 Heat-resistant alloys, Ni- or Co-based, hardened, 350 HB											
S1.1.5 Heat-resistant alloys, Ni- or Co-based, cast, 320 HB											
S2.1.1 Titanium alloys, pure titanium, Rm 400 N/mm ²											
S2.1.2 Titanium alloys, Alpha and Beta alloys, hardened, Rm 1050 N/mm ²											
H1.1.1 Hardened steel, hardened and tempered, < 55 HRC											
H1.1.2 Hardened steel, hardened and tempered, < 60 HRC											
H1.1.3 Hardened steel, hardened and tempered, > 60 HRC											
H2.1.1 Chilled cast iron, 400 HB											
H2.1.2 Chilled cast iron, hardened and tempered, < 55 HRC											

Cutting data



NC machine reamers, bright



Machining group	V _c (m/min)	f (mm/rev) with nom. Ø										
		1	2	3	4	6	8	10	12	14	16	20
P1.1.1 Unalloyed steel, annealed, 0.15 % C, Rm 420 N/mm ² , 125 HB	18	0.03	0.05	0.10	0.10	0.25	0.30	0.35	0.40	0.40	0.45	0.45
P1.1.2 Unalloyed steel, heat-treated, 0.15 % C, Rm 420 N/mm ² , 125 HB	18	0.03	0.05	0.10	0.10	0.25	0.30	0.35	0.40	0.40	0.45	0.45
P1.1.3 Unalloyed steel, annealed, 0.45 % C, Rm 640 N/mm ² , 190 HB	18	0.03	0.05	0.10	0.10	0.25	0.30	0.35	0.40	0.40	0.45	0.45
P1.1.4 Unalloyed steel, heat-treated, 0.45 % C, Rm 640 N/mm ² , 190 HB	18	0.03	0.05	0.10	0.10	0.25	0.30	0.35	0.40	0.40	0.45	0.45
P1.1.5 Unalloyed steel, heat-treated, 0.45 % C, Rm 850 N/mm ² , 250 HB	16	0.03	0.05	0.10	0.10	0.25	0.30	0.35	0.40	0.40	0.45	0.45
P1.1.6 Unalloyed steel, annealed, 0.75 % C, Rm 915 N/mm ² , 270 HB	16	0.03	0.05	0.10	0.10	0.25	0.30	0.35	0.40	0.40	0.45	0.45
P1.1.7 Unalloyed steel, heat-treated, 0.75 % C, Rm 1020 N/mm ² , 300 HB	14	0.03	0.05	0.10	0.10	0.25	0.30	0.35	0.40	0.40	0.45	0.45
P2.1.1 Low-alloy steel, annealed, Rm 610 N/mm ² , 180 HB	14	0.02	0.05	0.10	0.10	0.20	0.25	0.30	0.30	0.35	0.35	0.40
P2.1.2 Low-alloy steel, heat-treated, Rm 930 N/mm ² , 275 HB	14	0.02	0.05	0.10	0.10	0.20	0.25	0.30	0.30	0.35	0.35	0.40
P2.1.3 Low-alloy steel, heat-treated, Rm 1020 N/mm ² , 300 HB	14	0.02	0.05	0.10	0.10	0.20	0.25	0.30	0.30	0.35	0.35	0.40
P2.1.4 Low-alloy steel, heat-treated, Rm 1190 N/mm ² , 350 HB	9	0.02	0.05	0.10	0.10	0.20	0.25	0.30	0.30	0.35	0.35	0.40
P3.1.1 High-alloy steel and tool steel, annealed, Rm 680 N/mm ² , 200 HB	12	0.02	0.05	0.10	0.10	0.20	0.25	0.30	0.30	0.35	0.35	0.40
P3.1.2 High-alloy steel and tool steel, hardened and tempered, Rm 1100 N/mm ² , 325 HB	8	0.02	0.05	0.10	0.10	0.20	0.25	0.30	0.30	0.35	0.35	0.40
M1.1.1 Stainless steel, ferritic/martensitic, with machining additives	8	0.02	0.05	0.10	0.10	0.20	0.25	0.30	0.30	0.35	0.35	0.40
M1.1.2 Stainless steel, ferritic/martensitic, annealed, Rm 680 N/mm ² , 200 HB	6	0.02	0.05	0.10	0.10	0.20	0.25	0.30	0.30	0.35	0.35	0.40
M1.1.3 Stainless steel, ferritic/martensitic, heat-treated, Rm 810 N/mm ² , 240 HB	6	0.02	0.05	0.10	0.10	0.20	0.25	0.30	0.30	0.35	0.35	0.40
M2.1.1 Stainless steel, austenitic, quenched, 180 HB	6	0.02	0.05	0.10	0.10	0.20	0.25	0.30	0.30	0.35	0.35	0.40
M2.2.1 Duplex steel, high-strength stainless steels	4	0.02	0.05	0.10	0.10	0.20	0.25	0.30	0.30	0.35	0.35	0.40
K1.1.1 Grey cast iron, pearlitic/ferritic, 180 HB	20	0.02	0.05	0.10	0.10	0.20	0.25	0.30	0.30	0.35	0.35	0.40
K1.1.2 Grey cast iron, pearlitic/martensitic, 260 HB	18	0.02	0.05	0.10	0.10	0.20	0.25	0.30	0.30	0.35	0.35	0.40
K1.2.1 Cast iron with spheroidal graphite, ferritic, 160 HB	24	0.02	0.05	0.10	0.10	0.20	0.25	0.30	0.30	0.35	0.35	0.40
K1.2.2 Cast iron with spheroidal graphite, pearlitic, 250 HB	24	0.02	0.05	0.10	0.10	0.20	0.25	0.30	0.30	0.35	0.35	0.40
K1.3.1 Malleable cast iron, ferritic, 130 HB	20	0.02	0.05	0.10	0.10	0.20	0.25	0.30	0.30	0.35	0.35	0.40
K1.3.2 Malleable cast iron, pearlitic, 230 HB	18	0.02	0.05	0.10	0.10	0.20	0.25	0.30	0.30	0.35	0.35	0.40
K2.1.1 Vermicular graphite cast iron (GJV)	16	0.02	0.05	0.10	0.10	0.20	0.25	0.30	0.30	0.35	0.35	0.40
K2.2.1 Austenitic-ferritic spheroidal graphite cast iron (ADI)	12	0.02	0.05	0.10	0.10	0.20	0.25	0.30	0.30	0.35	0.35	0.40
N1.1.1 Wrought aluminium alloys, non-hardened, 60 HB	30	0.03	0.05	0.10	0.15	0.30	0.35	0.45	0.45	0.50	0.55	0.60
N1.1.2 Wrought aluminium alloys, hardened, 100 HB	30	0.03	0.05	0.10	0.15	0.30	0.35	0.45	0.45	0.50	0.55	0.60
N2.1.1 Aluminium casting alloys, non-hardened, ≤ 12 % Si, 75 HB	40	0.03	0.05	0.10	0.10	0.25	0.30	0.35	0.40	0.40	0.45	0.45
N2.1.2 Aluminium casting alloys, hardened, ≤ 12 % Si, 90 HB	30	0.03	0.05	0.10	0.10	0.25	0.30	0.35	0.40	0.40	0.45	0.45
N2.1.3 Aluminium casting alloys, non-hardened, > 12 % Si, 130 HB	30	0.03	0.05	0.10	0.10	0.25	0.30	0.35	0.40	0.40	0.45	0.45
N3.1.1 Copper and copper alloys: Free-machining alloy, Pb > 1 %	25	0.03	0.05	0.10	0.10	0.25	0.30	0.35	0.40	0.40	0.45	0.45
N3.1.2 Copper and copper alloys: CuZn, CuSnZn	25	0.03	0.05	0.10	0.10	0.25	0.30	0.35	0.40	0.40	0.45	0.45
N3.1.3 Copper and copper alloys: CuSn, lead-free copper and copper electrolyte	25	0.03	0.05	0.10	0.10	0.25	0.30	0.35	0.40	0.40	0.45	0.45
N4.1.1 Non-metallic materials: Duroplastics, fibre-reinforced plastics	20	0.03	0.05	0.10	0.15	0.30	0.35	0.45	0.45	0.50	0.55	0.60
N4.1.2 Non-metallic materials: Hard rubber, wood, etc.	20	0.03	0.05	0.10	0.15	0.30	0.35	0.45	0.45	0.50	0.55	0.60
N4.1.3 Non-metallic materials: Graphite	12	0.03	0.05	0.10	0.15	0.30	0.35	0.45	0.45	0.50	0.55	0.60
S1.1.1 Heat-resistant alloys, Fe-based, annealed, 200 HB	6	0.02	0.05	0.10	0.10	0.20	0.25	0.30	0.30	0.35	0.35	0.40
S1.1.2 Heat-resistant alloys, Fe-based, hardened, 280 HB	6	0.02	0.05	0.10	0.10	0.20	0.25	0.30	0.30	0.35	0.35	0.40
S1.1.3 Heat-resistant alloys, Ni- or Co-based, annealed, 250 HB	6	0.02	0.05	0.10	0.10	0.20	0.25	0.30	0.30	0.35	0.35	0.40
S1.1.4 Heat-resistant alloys, Ni- or Co-based, hardened, 350 HB	6	0.02	0.05	0.10	0.10	0.20	0.25	0.30	0.30	0.35	0.35	0.40
S1.1.5 Heat-resistant alloys, Ni- or Co-based, cast, 320 HB	6	0.02	0.05	0.10	0.10	0.20	0.25	0.30	0.30	0.35	0.35	0.40
S2.1.1 Titanium alloys, pure titanium, Rm 400 N/mm ²	10	0.02	0.05	0.10	0.10	0.20	0.25	0.30	0.30	0.35	0.35	0.40
S2.1.2 Titanium alloys, Alpha and Beta alloys, hardened, Rm 1050 N/mm ²	10	0.02	0.05	0.10	0.10	0.20	0.25	0.30	0.30	0.35	0.35	0.40
H1.1.1 Hardened steel, hardened and tempered, < 55 HRC												
H1.1.2 Hardened steel, hardened and tempered, < 60 HRC												
H1.1.3 Hardened steel, hardened and tempered, > 60 HRC												
H2.1.1 Chilled cast iron, 400 HB												
H2.1.2 Chilled cast iron, hardened and tempered, < 55 HRC												

Cutting data



NC machine reamers, TiAlN-nanoA



Machining group	a V _c (m/min)	f (mm/rev) with nom. Ø										
		1	2	3	4	6	8	10	12	14	16	20
P1.1.1 Unalloyed steel, annealed, 0.15 % C, Rm 420 N/mm ² , 125 HB	22	0.03	0.05	0.10	0.10	0.25	0.30	0.35	0.40	0.40	0.45	0.45
P1.1.2 Unalloyed steel, heat-treated, 0.15 % C, Rm 420 N/mm ² , 125 HB	22	0.03	0.05	0.10	0.10	0.25	0.30	0.35	0.40	0.40	0.45	0.45
P1.1.3 Unalloyed steel, annealed, 0.45 % C, Rm 640 N/mm ² , 190 HB	22	0.03	0.05	0.10	0.10	0.25	0.30	0.35	0.40	0.40	0.45	0.45
P1.1.4 Unalloyed steel, heat-treated, 0.45 % C, Rm 640 N/mm ² , 190 HB	22	0.03	0.05	0.10	0.10	0.25	0.30	0.35	0.40	0.40	0.45	0.45
P1.1.5 Unalloyed steel, heat-treated, 0.45 % C, Rm 850 N/mm ² , 250 HB	20	0.03	0.05	0.10	0.10	0.25	0.30	0.35	0.40	0.40	0.45	0.45
P1.1.6 Unalloyed steel, annealed, 0.75 % C, Rm 915 N/mm ² , 270 HB	20	0.03	0.05	0.10	0.10	0.25	0.30	0.35	0.40	0.40	0.45	0.45
P1.1.7 Unalloyed steel, heat-treated, 0.75 % C, Rm 1020 N/mm ² , 300 HB	18	0.03	0.05	0.10	0.10	0.25	0.30	0.35	0.40	0.40	0.45	0.45
P2.1.1 Low-alloy steel, annealed, Rm 610 N/mm ² , 180 HB	18	0.02	0.05	0.10	0.10	0.20	0.25	0.30	0.30	0.35	0.35	0.40
P2.1.2 Low-alloy steel, heat-treated, Rm 930 N/mm ² , 275 HB	18	0.02	0.05	0.10	0.10	0.20	0.25	0.30	0.30	0.35	0.35	0.40
P2.1.3 Low-alloy steel, heat-treated, Rm 1020 N/mm ² , 300 HB	18	0.02	0.05	0.10	0.10	0.20	0.25	0.30	0.30	0.35	0.35	0.40
P2.1.4 Low-alloy steel, heat-treated, Rm 1190 N/mm ² , 350 HB	12	0.02	0.05	0.10	0.10	0.20	0.25	0.30	0.30	0.35	0.35	0.40
P3.1.1 High-alloy steel and tool steel, annealed, Rm 680 N/mm ² , 200 HB	16	0.02	0.05	0.10	0.10	0.20	0.25	0.30	0.30	0.35	0.35	0.40
P3.1.2 High-alloy steel and tool steel, hardened and tempered, Rm 1100 N/mm ² , 325 HB	11	0.02	0.05	0.10	0.10	0.20	0.25	0.30	0.30	0.35	0.35	0.40
M1.1.1 Stainless steel, ferritic/martensitic, with machining additives	12	0.02	0.05	0.10	0.10	0.20	0.25	0.30	0.30	0.35	0.35	0.40
M1.1.2 Stainless steel, ferritic/martensitic, annealed, Rm 680 N/mm ² , 200 HB	9	0.02	0.05	0.10	0.10	0.20	0.25	0.30	0.30	0.35	0.35	0.40
M1.1.3 Stainless steel, ferritic/martensitic, heat-treated, Rm 810 N/mm ² , 240 HB	9	0.02	0.05	0.10	0.10	0.20	0.25	0.30	0.30	0.35	0.35	0.40
M2.1.1 Stainless steel, austenitic, quenched, 180 HB	10	0.02	0.05	0.10	0.10	0.20	0.25	0.30	0.30	0.35	0.35	0.40
M2.2.1 Duplex steel, high-strength stainless steels	6	0.02	0.05	0.10	0.10	0.20	0.25	0.30	0.30	0.35	0.35	0.40
K1.1.1 Grey cast iron, pearlitic/ferritic, 180 HB	24	0.02	0.05	0.10	0.10	0.20	0.25	0.30	0.30	0.35	0.35	0.40
K1.1.2 Grey cast iron, pearlitic/martensitic, 260 HB	22	0.02	0.05	0.10	0.10	0.20	0.25	0.30	0.30	0.35	0.35	0.40
K1.2.1 Cast iron with spheroidal graphite, ferritic, 160 HB	29	0.02	0.05	0.10	0.10	0.20	0.25	0.30	0.30	0.35	0.35	0.40
K1.2.2 Cast iron with spheroidal graphite, pearlitic, 250 HB	29	0.02	0.05	0.10	0.10	0.20	0.25	0.30	0.30	0.35	0.35	0.40
K1.3.1 Malleable cast iron, ferritic, 130 HB	24	0.02	0.05	0.10	0.10	0.20	0.25	0.30	0.30	0.35	0.35	0.40
K1.3.2 Malleable cast iron, pearlitic, 230 HB	22	0.02	0.05	0.10	0.10	0.20	0.25	0.30	0.30	0.35	0.35	0.40
K2.1.1 Vermicular graphite cast iron (GJV)	20	0.02	0.05	0.10	0.10	0.20	0.25	0.30	0.30	0.35	0.35	0.40
K2.2.1 Austenitic-ferritic spheroidal graphite cast iron (ADI)	15	0.02	0.05	0.10	0.10	0.20	0.25	0.30	0.30	0.35	0.35	0.40
N1.1.1 Wrought aluminium alloys, non-hardened, 60 HB	34	0.03	0.05	0.10	0.15	0.30	0.35	0.45	0.45	0.50	0.55	0.60
N1.1.2 Wrought aluminium alloys, hardened, 100 HB	34	0.03	0.05	0.10	0.15	0.30	0.35	0.45	0.45	0.50	0.55	0.60
N2.1.1 Aluminium casting alloys, non-hardened, ≤ 12 % Si, 75 HB	44	0.03	0.05	0.10	0.10	0.25	0.30	0.35	0.40	0.40	0.45	0.45
N2.1.2 Aluminium casting alloys, hardened, ≤ 12 % Si, 90 HB	33	0.03	0.05	0.10	0.10	0.25	0.30	0.35	0.40	0.40	0.45	0.45
N2.1.3 Aluminium casting alloys, non-hardened, > 12 % Si, 130 HB	33	0.03	0.05	0.10	0.10	0.25	0.30	0.35	0.40	0.40	0.45	0.45
N3.1.1 Copper and copper alloys: Free-machining alloy, Pb > 1 %	29	0.03	0.05	0.10	0.10	0.25	0.30	0.35	0.40	0.40	0.45	0.45
N3.1.2 Copper and copper alloys: CuZn, CuSnZn	29	0.03	0.05	0.10	0.10	0.25	0.30	0.35	0.40	0.40	0.45	0.45
N3.1.3 Copper and copper alloys: CuSn, lead-free copper and copper electrolyte	29	0.03	0.05	0.10	0.10	0.25	0.30	0.35	0.40	0.40	0.45	0.45
N4.1.1 Non-metallic materials: Duroplastics, fibre-reinforced plastics	24	0.03	0.05	0.10	0.15	0.30	0.35	0.45	0.45	0.50	0.55	0.60
N4.1.2 Non-metallic materials: Hard rubber, wood, etc.	24	0.03	0.05	0.10	0.15	0.30	0.35	0.45	0.45	0.50	0.55	0.60
N4.1.3 Non-metallic materials: Graphite	14	0.03	0.05	0.10	0.15	0.30	0.35	0.45	0.45	0.50	0.55	0.60
S1.1.1 Heat-resistant alloys, Fe-based, annealed, 200 HB	10	0.02	0.05	0.10	0.10	0.20	0.25	0.30	0.30	0.35	0.35	0.40
S1.1.2 Heat-resistant alloys, Fe-based, hardened, 280 HB	10	0.02	0.05	0.10	0.10	0.20	0.25	0.30	0.30	0.35	0.35	0.40
S1.1.3 Heat-resistant alloys, Ni- or Co-based, annealed, 250 HB	10	0.02	0.05	0.10	0.10	0.20	0.25	0.30	0.30	0.35	0.35	0.40
S1.1.4 Heat-resistant alloys, Ni- or Co-based, hardened, 350 HB	10	0.02	0.05	0.10	0.10	0.20	0.25	0.30	0.30	0.35	0.35	0.40
S1.1.5 Heat-resistant alloys, Ni- or Co-based, cast, 320 HB	10	0.02	0.05	0.10	0.10	0.20	0.25	0.30	0.30	0.35	0.35	0.40
S2.1.1 Titanium alloys, pure titanium, Rm 400 N/mm ²	14	0.02	0.05	0.10	0.10	0.20	0.25	0.30	0.30	0.35	0.35	0.40
S2.1.2 Titanium alloys, Alpha and Beta alloys, hardened, Rm 1050 N/mm ²	14	0.02	0.05	0.10	0.10	0.20	0.25	0.30	0.30	0.35	0.35	0.40
H1.1.1 Hardened steel, hardened and tempered, < 55 HRC												
H1.1.2 Hardened steel, hardened and tempered, < 60 HRC												
H1.1.3 Hardened steel, hardened and tempered, > 60 HRC												
H2.1.1 Chilled cast iron, 400 HB												
H2.1.2 Chilled cast iron, hardened and tempered, < 55 HRC												



Machine reamers



Cutting data

Machining group	V _c (m/min)	f (mm/rev) with nom. Ø											
		1	2	3	4	6	8	10	14	18	22	30	40
P1.1.1 Unalloyed steel, annealed, 0.15 % C, Rm 420 N/mm ² , 125 HB	18	0.02	0.05	0.05	0.10	0.15	0.20	0.25	0.25	0.30	0.35	0.35	0.40
P1.1.2 Unalloyed steel, heat-treated, 0.15 % C, Rm 420 N/mm ² , 125 HB	18	0.02	0.05	0.05	0.10	0.15	0.20	0.25	0.25	0.30	0.35	0.35	0.40
P1.1.3 Unalloyed steel, annealed, 0.45 % C, Rm 640 N/mm ² , 190 HB	18	0.02	0.05	0.05	0.10	0.15	0.20	0.25	0.25	0.30	0.35	0.35	0.40
P1.1.4 Unalloyed steel, heat-treated, 0.45 % C, Rm 640 N/mm ² , 190 HB	18	0.02	0.05	0.05	0.10	0.15	0.20	0.25	0.25	0.30	0.35	0.35	0.40
P1.1.5 Unalloyed steel, heat-treated, 0.45 % C, Rm 850 N/mm ² , 250 HB	16	0.02	0.05	0.05	0.10	0.15	0.20	0.25	0.25	0.30	0.35	0.35	0.40
P1.1.6 Unalloyed steel, annealed, 0.75 % C, Rm 915 N/mm ² , 270 HB	16	0.02	0.05	0.05	0.10	0.15	0.20	0.25	0.25	0.30	0.35	0.35	0.40
P1.1.7 Unalloyed steel, heat-treated, 0.75 % C, Rm 1020 N/mm ² , 300 HB	14	0.02	0.05	0.05	0.10	0.15	0.20	0.25	0.25	0.30	0.35	0.35	0.40
P2.1.1 Low-alloy steel, annealed, Rm 610 N/mm ² , 180 HB	14	0.02	0.05	0.05	0.10	0.15	0.20	0.25	0.25	0.30	0.35	0.35	0.40
P2.1.2 Low-alloy steel, heat-treated, Rm 930 N/mm ² , 275 HB	14	0.02	0.05	0.05	0.10	0.15	0.20	0.25	0.25	0.30	0.35	0.35	0.40
P2.1.3 Low-alloy steel, heat-treated, Rm 1020 N/mm ² , 300 HB	14	0.02	0.05	0.05	0.10	0.15	0.20	0.25	0.25	0.30	0.35	0.35	0.40
P2.1.4 Low-alloy steel, heat-treated, Rm 1190 N/mm ² , 350 HB	9	0.02	0.05	0.05	0.10	0.15	0.20	0.25	0.25	0.30	0.35	0.35	0.40
P3.1.1 High-alloy steel and tool steel, annealed, Rm 680 N/mm ² , 200 HB	12	0.02	0.05	0.05	0.10	0.15	0.20	0.25	0.25	0.30	0.35	0.35	0.40
P3.1.2 High-alloy steel and tool steel, hardened and tempered, Rm 1100 N/mm ² , 325 HB	8	0.02	0.05	0.05	0.10	0.15	0.20	0.25	0.25	0.30	0.35	0.35	0.40
M1.1.1 Stainless steel, ferritic/martensitic, with machining additives	8	0.02	0.05	0.05	0.10	0.15	0.20	0.25	0.25	0.30	0.35	0.35	0.40
M1.1.2 Stainless steel, ferritic/martensitic, annealed, Rm 680 N/mm ² , 200 HB	6	0.02	0.05	0.05	0.10	0.15	0.20	0.25	0.25	0.30	0.35	0.35	0.40
M1.1.3 Stainless steel, ferritic/martensitic, heat-treated, Rm 810 N/mm ² , 240 HB	6	0.02	0.05	0.05	0.10	0.15	0.20	0.25	0.25	0.30	0.35	0.35	0.40
M2.1.1 Stainless steel, austenitic, quenched, 180 HB	6	0.02	0.05	0.05	0.10	0.15	0.20	0.25	0.25	0.30	0.35	0.35	0.40
M2.2.1 Duplex steel, high-strength stainless steels	4	0.02	0.05	0.05	0.10	0.15	0.20	0.25	0.25	0.30	0.35	0.35	0.40
K1.1.1 Grey cast iron, pearlitic/ferritic, 180 HB	20	0.02	0.05	0.05	0.10	0.15	0.20	0.25	0.25	0.30	0.35	0.35	0.40
K1.1.2 Grey cast iron, pearlitic/martensitic, 260 HB	18	0.02	0.05	0.05	0.10	0.15	0.20	0.25	0.25	0.30	0.35	0.35	0.40
K1.2.1 Cast iron with spheroidal graphite, ferritic, 160 HB	24	0.02	0.05	0.05	0.10	0.15	0.20	0.25	0.25	0.30	0.35	0.35	0.40
K1.2.2 Cast iron with spheroidal graphite, pearlitic, 250 HB	24	0.02	0.05	0.05	0.10	0.15	0.20	0.25	0.25	0.30	0.35	0.35	0.40
K1.3.1 Malleable cast iron, ferritic, 130 HB	20	0.02	0.05	0.05	0.10	0.15	0.20	0.25	0.25	0.30	0.35	0.35	0.40
K1.3.2 Malleable cast iron, pearlitic, 230 HB	18	0.02	0.05	0.05	0.10	0.15	0.20	0.25	0.25	0.30	0.35	0.35	0.40
K2.1.1 Vermicular graphite cast iron (GJV)	16	0.02	0.05	0.05	0.10	0.15	0.20	0.25	0.25	0.30	0.35	0.35	0.40
K2.2.1 Austenitic-ferritic spheroidal graphite cast iron (ADI)	12	0.02	0.05	0.05	0.10	0.15	0.20	0.25	0.25	0.30	0.35	0.35	0.40
N1.1.1 Wrought aluminium alloys, non-hardened, 60 HB	30	0.03	0.05	0.10	0.15	0.25	0.30	0.40	0.45	0.50	0.50	0.60	0.65
N1.1.2 Wrought aluminium alloys, hardened, 100 HB	30	0.03	0.05	0.10	0.15	0.25	0.30	0.40	0.45	0.50	0.50	0.60	0.65
N2.1.1 Aluminium casting alloys, non-hardened, ≤ 12 % Si, 75 HB	40	0.02	0.05	0.10	0.10	0.20	0.25	0.30	0.35	0.40	0.40	0.45	0.50
N2.1.2 Aluminium casting alloys, hardened, ≤ 12 % Si, 90 HB	30	0.02	0.05	0.10	0.10	0.20	0.25	0.30	0.35	0.40	0.40	0.45	0.50
N2.1.3 Aluminium casting alloys, non-hardened, > 12 % Si, 130 HB	30	0.02	0.05	0.10	0.10	0.20	0.25	0.30	0.35	0.40	0.40	0.45	0.50
N3.1.1 Copper and copper alloys: Free-machining alloy, Pb > 1 %	25	0.02	0.05	0.10	0.10	0.20	0.25	0.30	0.35	0.40	0.40	0.45	0.50
N3.1.2 Copper and copper alloys: CuZn, CuSnZn	25	0.02	0.05	0.10	0.10	0.20	0.25	0.30	0.35	0.40	0.40	0.45	0.50
N3.1.3 Copper and copper alloys: CuSn, lead-free copper and copper electrolyte	25	0.02	0.05	0.10	0.10	0.20	0.25	0.30	0.35	0.40	0.40	0.45	0.50
N4.1.1 Non-metallic materials: Duroplastics, fibre-reinforced plastics	20	0.03	0.05	0.10	0.15	0.25	0.30	0.40	0.45	0.50	0.50	0.60	0.65
N4.1.2 Non-metallic materials: Hard rubber, wood, etc.	20	0.03	0.05	0.10	0.15	0.25	0.30	0.40	0.45	0.50	0.50	0.60	0.65
N4.1.3 Non-metallic materials: Graphite	12	0.03	0.05	0.10	0.15	0.25	0.30	0.40	0.45	0.50	0.50	0.60	0.65
S1.1.1 Heat-resistant alloys, Fe-based, annealed, 200 HB	6	0.02	0.05	0.05	0.10	0.15	0.20	0.25	0.25	0.30	0.35	0.35	0.40
S1.1.2 Heat-resistant alloys, Fe-based, hardened, 280 HB	6	0.02	0.05	0.05	0.10	0.15	0.20	0.25	0.25	0.30	0.35	0.35	0.40
S1.1.3 Heat-resistant alloys, Ni- or Co-based, annealed, 250 HB	6	0.02	0.05	0.05	0.10	0.15	0.20	0.25	0.25	0.30	0.35	0.35	0.40
S1.1.4 Heat-resistant alloys, Ni- or Co-based, hardened, 350 HB	6	0.02	0.05	0.05	0.10	0.15	0.20	0.25	0.25	0.30	0.35	0.35	0.40
S1.1.5 Heat-resistant alloys, Ni- or Co-based, cast, 320 HB	6	0.02	0.05	0.05	0.10	0.15	0.20	0.25	0.25	0.30	0.35	0.35	0.40
S2.1.1 Titanium alloys, pure titanium, Rm 400 N/mm ²	10	0.02	0.05	0.05	0.10	0.15	0.20	0.25	0.25	0.30	0.35	0.35	0.40
S2.1.2 Titanium alloys, Alpha and Beta alloys, hardened, Rm 1050 N/mm ²	10	0.02	0.05	0.05	0.10	0.15	0.20	0.25	0.25	0.30	0.35	0.35	0.40
H1.1.1 Hardened steel, hardened and tempered, < 55 HRC													
H1.1.2 Hardened steel, hardened and tempered, < 60 HRC													
H1.1.3 Hardened steel, hardened and tempered, > 60 HRC													
H2.1.1 Chilled cast iron, 400 HB													
H2.1.2 Chilled cast iron, hardened and tempered, < 55 HRC													



Machine reamers



Machining group	V _c (m/min)	f (mm/rev) with nom. Ø							
		3	4	6	8	10	12	14	16
P1.1.1 Unalloyed steel, annealed, 0.15 % C, Rm 420 N/mm ² , 125 HB	20	0.05	0.10	0.15	0.20	0.25	0.25	0.25	0.30
P1.1.2 Unalloyed steel, heat-treated, 0.15 % C, Rm 420 N/mm ² , 125 HB	20	0.05	0.10	0.15	0.20	0.25	0.25	0.25	0.30
P1.1.3 Unalloyed steel, annealed, 0.45 % C, Rm 640 N/mm ² , 190 HB	20	0.05	0.10	0.15	0.20	0.25	0.25	0.25	0.30
P1.1.4 Unalloyed steel, heat-treated, 0.45 % C, Rm 640 N/mm ² , 190 HB	20	0.05	0.10	0.15	0.20	0.25	0.25	0.25	0.30
P1.1.5 Unalloyed steel, heat-treated, 0.45 % C, Rm 850 N/mm ² , 250 HB	18	0.05	0.10	0.15	0.20	0.25	0.25	0.25	0.30
P1.1.6 Unalloyed steel, annealed, 0.75 % C, Rm 915 N/mm ² , 270 HB	18	0.05	0.10	0.15	0.20	0.25	0.25	0.25	0.30
P1.1.7 Unalloyed steel, heat-treated, 0.75 % C, Rm 1020 N/mm ² , 300 HB	16	0.05	0.10	0.15	0.20	0.25	0.25	0.25	0.30
P2.1.1 Low-alloy steel, annealed, Rm 610 N/mm ² , 180 HB	16	0.05	0.10	0.15	0.20	0.25	0.25	0.25	0.30
P2.1.2 Low-alloy steel, heat-treated, Rm 930 N/mm ² , 275 HB	16	0.05	0.10	0.15	0.20	0.25	0.25	0.25	0.30
P2.1.3 Low-alloy steel, heat-treated, Rm 1020 N/mm ² , 300 HB	16	0.05	0.10	0.15	0.20	0.25	0.25	0.25	0.30
P2.1.4 Low-alloy steel, heat-treated, Rm 1190 N/mm ² , 350 HB	11	0.05	0.10	0.15	0.20	0.25	0.25	0.25	0.30
P3.1.1 High-alloy steel and tool steel, annealed, Rm 680 N/mm ² , 200 HB	14	0.05	0.10	0.15	0.20	0.25	0.25	0.25	0.30
P3.1.2 High-alloy steel and tool steel, hardened and tempered, Rm 1100 N/mm ² , 325 HB	9	0.05	0.10	0.15	0.20	0.25	0.25	0.25	0.30
M1.1.1 Stainless steel, ferritic/martensitic, with machining additives	8	0.05	0.10	0.15	0.20	0.25	0.25	0.25	0.30
M1.1.2 Stainless steel, ferritic/martensitic, annealed, Rm 680 N/mm ² , 200 HB	6	0.05	0.10	0.15	0.20	0.25	0.25	0.25	0.30
M1.1.3 Stainless steel, ferritic/martensitic, heat-treated, Rm 810 N/mm ² , 240 HB	6	0.05	0.10	0.15	0.20	0.25	0.25	0.25	0.30
M2.1.1 Stainless steel, austenitic, quenched, 180 HB	6	0.05	0.10	0.15	0.20	0.25	0.25	0.25	0.30
M2.2.1 Duplex steel, high-strength stainless steels	4	0.05	0.10	0.15	0.20	0.25	0.25	0.25	0.30
K1.1.1 Grey cast iron, pearlitic/ferritic, 180 HB	20	0.05	0.10	0.15	0.20	0.25	0.25	0.25	0.30
K1.1.2 Grey cast iron, pearlitic/martensitic, 260 HB	18	0.05	0.10	0.15	0.20	0.25	0.25	0.25	0.30
K1.2.1 Cast iron with spheroidal graphite, ferritic, 160 HB	24	0.05	0.10	0.15	0.20	0.25	0.25	0.25	0.30
K1.2.2 Cast iron with spheroidal graphite, pearlitic, 250 HB	24	0.05	0.10	0.15	0.20	0.25	0.25	0.25	0.30
K1.3.1 Malleable cast iron, ferritic, 130 HB	20	0.05	0.10	0.15	0.20	0.25	0.25	0.25	0.30
K1.3.2 Malleable cast iron, pearlitic, 230 HB	18	0.05	0.10	0.15	0.20	0.25	0.25	0.25	0.30
K2.1.1 Vermicular graphite cast iron (GJV)	16	0.05	0.10	0.15	0.20	0.25	0.25	0.25	0.30
K2.2.1 Austenitic-ferritic spheroidal graphite cast iron (ADI)	12	0.05	0.10	0.15	0.20	0.25	0.25	0.25	0.30
N1.1.1 Wrought aluminium alloys, non-hardened, 60 HB	30	0.10	0.15	0.25	0.30	0.40	0.40	0.45	0.45
N1.1.2 Wrought aluminium alloys, hardened, 100 HB	30	0.10	0.15	0.25	0.30	0.40	0.40	0.45	0.45
N2.1.1 Aluminium casting alloys, non-hardened, ≤ 12 % Si, 75 HB	40	0.10	0.10	0.20	0.25	0.30	0.30	0.35	0.35
N2.1.2 Aluminium casting alloys, hardened, ≤ 12 % Si, 90 HB	30	0.10	0.10	0.20	0.25	0.30	0.30	0.35	0.35
N2.1.3 Aluminium casting alloys, non-hardened, > 12 % Si, 130 HB	30	0.10	0.10	0.20	0.25	0.30	0.30	0.35	0.35
N3.1.1 Copper and copper alloys: Free-machining alloy, Pb > 1 %	35	0.10	0.10	0.20	0.25	0.30	0.30	0.35	0.35
N3.1.2 Copper and copper alloys: CuZn, CuSnZn	35	0.10	0.10	0.20	0.25	0.30	0.30	0.35	0.35
N3.1.3 Copper and copper alloys: CuSn, lead-free copper and copper electrolyte	35	0.10	0.10	0.20	0.25	0.30	0.30	0.35	0.35
N4.1.1 Non-metallic materials: Duroplastics, fibre-reinforced plastics	12	0.10	0.15	0.25	0.30	0.40	0.40	0.45	0.45
N4.1.2 Non-metallic materials: Hard rubber, wood, etc.	12	0.10	0.15	0.25	0.30	0.40	0.40	0.45	0.45
N4.1.3 Non-metallic materials: Graphite	7	0.10	0.15	0.25	0.30	0.40	0.40	0.45	0.45
S1.1.1 Heat-resistant alloys, Fe-based, annealed, 200 HB	6	0.05	0.10	0.15	0.20	0.25	0.25	0.25	0.30
S1.1.2 Heat-resistant alloys, Fe-based, hardened, 280 HB	6	0.05	0.10	0.15	0.20	0.25	0.25	0.25	0.30
S1.1.3 Heat-resistant alloys, Ni- or Co-based, annealed, 250 HB	6	0.05	0.10	0.15	0.20	0.25	0.25	0.25	0.30
S1.1.4 Heat-resistant alloys, Ni- or Co-based, hardened, 350 HB	6	0.05	0.10	0.15	0.20	0.25	0.25	0.25	0.30
S1.1.5 Heat-resistant alloys, Ni- or Co-based, cast, 320 HB	6	0.05	0.10	0.15	0.20	0.25	0.25	0.25	0.30
S2.1.1 Titanium alloys, pure titanium, Rm 400 N/mm ²	10	0.05	0.10	0.15	0.20	0.25	0.25	0.25	0.30
S2.1.2 Titanium alloys, Alpha and Beta alloys, hardened, Rm 1050 N/mm ²	10	0.05	0.10	0.15	0.20	0.25	0.25	0.25	0.30
H1.1.1 Hardened steel, hardened and tempered, < 55 HRC									
H1.1.2 Hardened steel, hardened and tempered, < 60 HRC									
H1.1.3 Hardened steel, hardened and tempered, > 60 HRC									
H2.1.1 Chilled cast iron, 400 HB									
H2.1.2 Chilled cast iron, hardened and tempered, < 55 HRC									



Expanding machine reamers



Cutting data

Machining group	V _c (m/min)	f (mm/rev) with nom. Ø							
		8	10	12	14	16	20	25	30
P1.1.1 Unalloyed steel, annealed, 0.15 % C, Rm 420 N/mm ² , 125 HB	14	0.20	0.25	0.25	0.25	0.30	0.30	0.35	0.35
P1.1.2 Unalloyed steel, heat-treated, 0.15 % C, Rm 420 N/mm ² , 125 HB	14	0.20	0.25	0.25	0.25	0.30	0.30	0.35	0.35
P1.1.3 Unalloyed steel, annealed, 0.45 % C, Rm 640 N/mm ² , 190 HB	14	0.20	0.25	0.25	0.25	0.30	0.30	0.35	0.35
P1.1.4 Unalloyed steel, heat-treated, 0.45 % C, Rm 640 N/mm ² , 190 HB	14	0.20	0.25	0.25	0.25	0.30	0.30	0.35	0.35
P1.1.5 Unalloyed steel, heat-treated, 0.45 % C, Rm 850 N/mm ² , 250 HB	13	0.20	0.25	0.25	0.25	0.30	0.30	0.35	0.35
P1.1.6 Unalloyed steel, annealed, 0.75 % C, Rm 915 N/mm ² , 270 HB	13	0.20	0.25	0.25	0.25	0.30	0.30	0.35	0.35
P1.1.7 Unalloyed steel, heat-treated, 0.75 % C, Rm 1020 N/mm ² , 300 HB	11	0.20	0.25	0.25	0.25	0.30	0.30	0.35	0.35
P2.1.1 Low-alloy steel, annealed, Rm 610 N/mm ² , 180 HB	12	0.20	0.25	0.25	0.25	0.30	0.30	0.35	0.35
P2.1.2 Low-alloy steel, heat-treated, Rm 930 N/mm ² , 275 HB	12	0.20	0.25	0.25	0.25	0.30	0.30	0.35	0.35
P2.1.3 Low-alloy steel, heat-treated, Rm 1020 N/mm ² , 300 HB	12	0.20	0.25	0.25	0.25	0.30	0.30	0.35	0.35
P2.1.4 Low-alloy steel, heat-treated, Rm 1190 N/mm ² , 350 HB	8	0.20	0.25	0.25	0.25	0.30	0.30	0.35	0.35
P3.1.1 High-alloy steel and tool steel, annealed, Rm 680 N/mm ² , 200 HB	10	0.20	0.25	0.25	0.25	0.30	0.30	0.35	0.35
P3.1.2 High-alloy steel and tool steel, hardened and tempered, Rm 1100 N/mm ² , 325 HB	7	0.20	0.25	0.25	0.25	0.30	0.30	0.35	0.35
M1.1.1 Stainless steel, ferritic/martensitic, with machining additives	8	0.20	0.25	0.25	0.25	0.30	0.30	0.35	0.35
M1.1.2 Stainless steel, ferritic/martensitic, annealed, Rm 680 N/mm ² , 200 HB	6	0.20	0.25	0.25	0.25	0.30	0.30	0.35	0.35
M1.1.3 Stainless steel, ferritic/martensitic, heat-treated, Rm 810 N/mm ² , 240 HB	6	0.20	0.25	0.25	0.25	0.30	0.30	0.35	0.35
M2.1.1 Stainless steel, austenitic, quenched, 180 HB	6	0.20	0.25	0.25	0.25	0.30	0.30	0.35	0.35
M2.2.1 Duplex steel, high-strength stainless steels	4	0.20	0.25	0.25	0.25	0.30	0.30	0.35	0.35
K1.1.1 Grey cast iron, pearlitic/ferritic, 180 HB	20	0.20	0.25	0.25	0.25	0.30	0.30	0.35	0.35
K1.1.2 Grey cast iron, pearlitic/martensitic, 260 HB	18	0.20	0.25	0.25	0.25	0.30	0.30	0.35	0.35
K1.2.1 Cast iron with spheroidal graphite, ferritic, 160 HB	24	0.20	0.25	0.25	0.25	0.30	0.30	0.35	0.35
K1.2.2 Cast iron with spheroidal graphite, pearlitic, 250 HB	24	0.20	0.25	0.25	0.25	0.30	0.30	0.35	0.35
K1.3.1 Malleable cast iron, ferritic, 130 HB	20	0.20	0.25	0.25	0.25	0.30	0.30	0.35	0.35
K1.3.2 Malleable cast iron, pearlitic, 230 HB	18	0.20	0.25	0.25	0.25	0.30	0.30	0.35	0.35
K2.1.1 Vermicular graphite cast iron (GJV)	16	0.20	0.25	0.25	0.25	0.30	0.30	0.35	0.35
K2.2.1 Austenitic-ferritic spheroidal graphite cast iron (ADI)	12	0.20	0.25	0.25	0.25	0.30	0.30	0.35	0.35
N1.1.1 Wrought aluminium alloys, non-hardened, 60 HB	25	0.25	0.30	0.30	0.35	0.35	0.40	0.45	0.45
N1.1.2 Wrought aluminium alloys, hardened, 100 HB	25	0.25	0.30	0.30	0.35	0.35	0.40	0.45	0.45
N2.1.1 Aluminium casting alloys, non-hardened, ≤ 12 % Si, 75 HB	35	0.25	0.30	0.30	0.35	0.35	0.40	0.45	0.45
N2.1.2 Aluminium casting alloys, hardened, ≤ 12 % Si, 90 HB	26	0.25	0.30	0.30	0.35	0.35	0.40	0.45	0.45
N2.1.3 Aluminium casting alloys, non-hardened, > 12 % Si, 130 HB	26	0.25	0.30	0.30	0.35	0.35	0.40	0.45	0.45
N3.1.1 Copper and copper alloys: Free-machining alloy, Pb > 1 %	20	0.25	0.30	0.30	0.35	0.35	0.40	0.45	0.45
N3.1.2 Copper and copper alloys: CuZn, CuSnZn	20	0.25	0.30	0.30	0.35	0.35	0.40	0.45	0.45
N3.1.3 Copper and copper alloys: CuSn, lead-free copper and copper electrolyte	20	0.25	0.30	0.30	0.35	0.35	0.40	0.45	0.45
N4.1.1 Non-metallic materials: Duroplastics, fibre-reinforced plastics	16	0.30	0.40	0.40	0.45	0.45	0.50	0.55	0.60
N4.1.2 Non-metallic materials: Hard rubber, wood, etc.	16	0.30	0.40	0.40	0.45	0.45	0.50	0.55	0.60
N4.1.3 Non-metallic materials: Graphite	10	0.30	0.40	0.40	0.45	0.45	0.50	0.55	0.60
S1.1.1 Heat-resistant alloys, Fe-based, annealed, 200 HB	6	0.20	0.25	0.25	0.25	0.30	0.30	0.35	0.35
S1.1.2 Heat-resistant alloys, Fe-based, hardened, 280 HB	6	0.20	0.25	0.25	0.25	0.30	0.30	0.35	0.35
S1.1.3 Heat-resistant alloys, Ni- or Co-based, annealed, 250 HB	6	0.20	0.25	0.25	0.25	0.30	0.30	0.35	0.35
S1.1.4 Heat-resistant alloys, Ni- or Co-based, hardened, 350 HB	6	0.20	0.25	0.25	0.25	0.30	0.30	0.35	0.35
S1.1.5 Heat-resistant alloys, Ni- or Co-based, cast, 320 HB	6	0.20	0.25	0.25	0.25	0.30	0.30	0.35	0.35
S2.1.1 Titanium alloys, pure titanium, Rm 400 N/mm ²	8	0.20	0.25	0.25	0.25	0.30	0.30	0.35	0.35
S2.1.2 Titanium alloys, Alpha and Beta alloys, hardened, Rm 1050 N/mm ²	8	0.20	0.25	0.25	0.25	0.30	0.30	0.35	0.35
H1.1.1 Hardened steel, hardened and tempered, < 55 HRC									
H1.1.2 Hardened steel, hardened and tempered, < 60 HRC									
H1.1.3 Hardened steel, hardened and tempered, > 60 HRC									
H2.1.1 Chilled cast iron, 400 HB									
H2.1.2 Chilled cast iron, hardened and tempered, < 55 HRC									



NC machine reamers



Machining group	V _c (m/min)	f (mm/rev) with nom. Ø											
		1	2	3	4	5	6	8	10	12	14	16	20
P1.1.1 Unalloyed steel, annealed, 0.15 % C, Rm 420 N/mm ² , 125 HB	14	0.03	0.06	0.09	0.10	0.20	0.25	0.30	0.35	0.40	0.40	0.45	0.45
P1.1.2 Unalloyed steel, heat-treated, 0.15 % C, Rm 420 N/mm ² , 125 HB	14	0.03	0.06	0.09	0.10	0.20	0.25	0.30	0.35	0.40	0.40	0.45	0.45
P1.1.3 Unalloyed steel, annealed, 0.45 % C, Rm 640 N/mm ² , 190 HB	14	0.03	0.06	0.09	0.10	0.20	0.25	0.30	0.35	0.40	0.40	0.45	0.45
P1.1.4 Unalloyed steel, heat-treated, 0.45 % C, Rm 640 N/mm ² , 190 HB	14	0.03	0.06	0.09	0.10	0.20	0.25	0.30	0.35	0.40	0.40	0.45	0.45
P1.1.5 Unalloyed steel, heat-treated, 0.45 % C, Rm 850 N/mm ² , 250 HB	13	0.03	0.06	0.09	0.10	0.20	0.25	0.30	0.35	0.40	0.40	0.45	0.45
P1.1.6 Unalloyed steel, annealed, 0.75 % C, Rm 915 N/mm ² , 270 HB	13	0.03	0.06	0.09	0.10	0.20	0.25	0.30	0.35	0.40	0.40	0.45	0.45
P1.1.7 Unalloyed steel, heat-treated, 0.75 % C, Rm 1020 N/mm ² , 300 HB	11	0.03	0.06	0.09	0.10	0.20	0.25	0.30	0.35	0.40	0.40	0.45	0.45
P2.1.1 Low-alloy steel, annealed, Rm 610 N/mm ² , 180 HB	10	0.02	0.05	0.08	0.10	0.15	0.20	0.25	0.30	0.30	0.35	0.35	0.40
P2.1.2 Low-alloy steel, heat-treated, Rm 930 N/mm ² , 275 HB	10	0.02	0.05	0.08	0.10	0.15	0.20	0.25	0.30	0.30	0.35	0.35	0.40
P2.1.3 Low-alloy steel, heat-treated, Rm 1020 N/mm ² , 300 HB	10	0.02	0.05	0.08	0.10	0.15	0.20	0.25	0.30	0.30	0.35	0.35	0.40
P2.1.4 Low-alloy steel, heat-treated, Rm 1190 N/mm ² , 350 HB	7	0.02	0.05	0.08	0.10	0.15	0.20	0.25	0.30	0.30	0.35	0.35	0.40
P3.1.1 High-alloy steel and tool steel, annealed, Rm 680 N/mm ² , 200 HB	10	0.02	0.05	0.08	0.10	0.15	0.20	0.25	0.30	0.30	0.35	0.35	0.40
P3.1.2 High-alloy steel and tool steel, hardened and tempered, Rm 1100 N/mm ² , 325 HB	7	0.02	0.05	0.08	0.10	0.15	0.20	0.25	0.30	0.30	0.35	0.35	0.40
M1.1.1 Stainless steel, ferritic/martensitic, with machining additives	6	0.03	0.06	0.09	0.10	0.20	0.25	0.30	0.35	0.40	0.40	0.45	0.45
M1.1.2 Stainless steel, ferritic/martensitic, annealed, Rm 680 N/mm ² , 200 HB	5	0.03	0.06	0.09	0.10	0.20	0.25	0.30	0.35	0.40	0.40	0.45	0.45
M1.1.3 Stainless steel, ferritic/martensitic, heat-treated, Rm 810 N/mm ² , 240 HB	5	0.03	0.06	0.09	0.10	0.20	0.25	0.30	0.35	0.40	0.40	0.45	0.45
M2.1.1 Stainless steel, austenitic, quenched, 180 HB	4	0.03	0.06	0.09	0.10	0.20	0.25	0.30	0.35	0.40	0.40	0.45	0.45
M2.2.1 Duplex steel, high-strength stainless steels	3	0.03	0.06	0.09	0.10	0.20	0.25	0.30	0.35	0.40	0.40	0.45	0.45
K1.1.1 Grey cast iron, pearlitic/ferritic, 180 HB	14	0.02	0.05	0.08	0.10	0.15	0.20	0.25	0.30	0.30	0.35	0.35	0.40
K1.1.2 Grey cast iron, pearlitic/martensitic, 260 HB	13	0.02	0.05	0.08	0.10	0.15	0.20	0.25	0.30	0.30	0.35	0.35	0.40
K1.2.1 Cast iron with spheroidal graphite, ferritic, 160 HB	17	0.02	0.05	0.08	0.10	0.15	0.20	0.25	0.30	0.30	0.35	0.35	0.40
K1.2.2 Cast iron with spheroidal graphite, pearlitic, 250 HB	17	0.02	0.05	0.08	0.10	0.15	0.20	0.25	0.30	0.30	0.35	0.35	0.40
K1.3.1 Malleable cast iron, ferritic, 130 HB	14	0.02	0.05	0.08	0.10	0.15	0.20	0.25	0.30	0.30	0.35	0.35	0.40
K1.3.2 Malleable cast iron, pearlitic, 230 HB	13	0.02	0.05	0.08	0.10	0.15	0.20	0.25	0.30	0.30	0.35	0.35	0.40
K2.1.1 Vermicular graphite cast iron (GJV)	8	0.02	0.05	0.08	0.10	0.15	0.20	0.25	0.30	0.30	0.35	0.35	0.40
K2.2.1 Austenitic-ferritic spheroidal graphite cast iron (ADI)	6	0.02	0.05	0.08	0.10	0.15	0.20	0.25	0.30	0.30	0.35	0.35	0.40
N1.1.1 Wrought aluminium alloys, non-hardened, 60 HB	18	0.03	0.07	0.11	0.15	0.25	0.30	0.35	0.45	0.45	0.50	0.55	0.60
N1.1.2 Wrought aluminium alloys, hardened, 100 HB	18	0.03	0.07	0.11	0.15	0.25	0.30	0.35	0.45	0.45	0.50	0.55	0.60
N2.1.1 Aluminium casting alloys, non-hardened, ≤ 12 % Si, 75 HB	20	0.03	0.06	0.09	0.10	0.20	0.25	0.30	0.35	0.40	0.40	0.45	0.45
N2.1.2 Aluminium casting alloys, hardened, ≤ 12 % Si, 90 HB	15	0.03	0.06	0.09	0.10	0.20	0.25	0.30	0.35	0.40	0.40	0.45	0.45
N2.1.3 Aluminium casting alloys, non-hardened, > 12 % Si, 130 HB	15	0.03	0.06	0.09	0.10	0.20	0.25	0.30	0.35	0.40	0.40	0.45	0.45
N3.1.1 Copper and copper alloys: Free-machining alloy, Pb > 1 %	18	0.03	0.06	0.09	0.10	0.20	0.25	0.30	0.35	0.40	0.40	0.45	0.45
N3.1.2 Copper and copper alloys: CuZn, CuSnZn	18	0.03	0.06	0.09	0.10	0.20	0.25	0.30	0.35	0.40	0.40	0.45	0.45
N3.1.3 Copper and copper alloys: CuSn, lead-free copper and copper electrolyte	18	0.03	0.06	0.09	0.10	0.20	0.25	0.30	0.35	0.40	0.40	0.45	0.45
N4.1.1 Non-metallic materials: Duroplastics, fibre-reinforced plastics	12	0.03	0.07	0.11	0.15	0.25	0.30	0.35	0.45	0.45	0.50	0.55	0.60
N4.1.2 Non-metallic materials: Hard rubber, wood, etc.	12	0.03	0.07	0.11	0.15	0.25	0.30	0.35	0.45	0.45	0.50	0.55	0.60
N4.1.3 Non-metallic materials: Graphite	7	0.03	0.07	0.11	0.15	0.25	0.30	0.35	0.45	0.45	0.50	0.55	0.60
S1.1.1 Heat-resistant alloys, Fe-based, annealed, 200 HB	4	0.02	0.05	0.08	0.10	0.15	0.20	0.25	0.30	0.30	0.35	0.35	0.40
S1.1.2 Heat-resistant alloys, Fe-based, hardened, 280 HB	4	0.02	0.05	0.08	0.10	0.15	0.20	0.25	0.30	0.30	0.35	0.35	0.40
S1.1.3 Heat-resistant alloys, Ni- or Co-based, annealed, 250 HB	4	0.02	0.05	0.08	0.10	0.15	0.20	0.25	0.30	0.30	0.35	0.35	0.40
S1.1.4 Heat-resistant alloys, Ni- or Co-based, hardened, 350 HB	4	0.02	0.05	0.08	0.10	0.15	0.20	0.25	0.30	0.30	0.35	0.35	0.40
S1.1.5 Heat-resistant alloys, Ni- or Co-based, cast, 320 HB	4	0.02	0.05	0.08	0.10	0.15	0.20	0.25	0.30	0.30	0.35	0.35	0.40
S2.1.1 Titanium alloys, pure titanium, Rm 400 N/mm ²	4	0.02	0.05	0.08	0.10	0.15	0.20	0.25	0.30	0.30	0.35	0.35	0.40
S2.1.2 Titanium alloys, Alpha and Beta alloys, hardened, Rm 1050 N/mm ²	4	0.02	0.05	0.08	0.10	0.15	0.20	0.25	0.30	0.30	0.35	0.35	0.40
H1.1.1 Hardened steel, hardened and tempered, < 55 HRC													
H1.1.2 Hardened steel, hardened and tempered, < 60 HRC													
H1.1.3 Hardened steel, hardened and tempered, > 60 HRC													
H2.1.1 Chilled cast iron, 400 HB													
H2.1.2 Chilled cast iron, hardened and tempered, < 55 HRC													



Machine reamers, bright



Cutting data

Machining group	V _c (m/min)	f (mm/rev) with nom. Ø											
		1	3	5	8	10	12	14	16	20	30	40	50
P1.1.1 Unalloyed steel, annealed, 0.15 % C, Rm 420 N/mm ² , 125 HB	14	0.02	0.10	0.15	0.25	0.30	0.30	0.35	0.35	0.40	0.45	0.50	0.55
P1.1.2 Unalloyed steel, heat-treated, 0.15 % C, Rm 420 N/mm ² , 125 HB	14	0.02	0.10	0.15	0.25	0.30	0.30	0.35	0.35	0.40	0.45	0.50	0.55
P1.1.3 Unalloyed steel, annealed, 0.45 % C, Rm 640 N/mm ² , 190 HB	14	0.02	0.10	0.15	0.25	0.30	0.30	0.35	0.35	0.40	0.45	0.50	0.55
P1.1.4 Unalloyed steel, heat-treated, 0.45 % C, Rm 640 N/mm ² , 190 HB	14	0.02	0.10	0.15	0.25	0.30	0.30	0.35	0.35	0.40	0.45	0.50	0.55
P1.1.5 Unalloyed steel, heat-treated, 0.45 % C, Rm 850 N/mm ² , 250 HB	13	0.02	0.10	0.15	0.25	0.30	0.30	0.35	0.35	0.40	0.45	0.50	0.55
P1.1.6 Unalloyed steel, annealed, 0.75 % C, Rm 915 N/mm ² , 270 HB	13	0.02	0.10	0.15	0.25	0.30	0.30	0.35	0.35	0.40	0.45	0.50	0.55
P1.1.7 Unalloyed steel, heat-treated, 0.75 % C, Rm 1020 N/mm ² , 300 HB	11	0.02	0.10	0.15	0.25	0.30	0.30	0.35	0.35	0.40	0.45	0.50	0.55
P2.1.1 Low-alloy steel, annealed, Rm 610 N/mm ² , 180 HB	10	0.02	0.05	0.15	0.20	0.25	0.25	0.25	0.30	0.30	0.35	0.40	0.45
P2.1.2 Low-alloy steel, heat-treated, Rm 930 N/mm ² , 275 HB	10	0.02	0.05	0.15	0.20	0.25	0.25	0.25	0.30	0.30	0.35	0.40	0.45
P2.1.3 Low-alloy steel, heat-treated, Rm 1020 N/mm ² , 300 HB	10	0.02	0.05	0.15	0.20	0.25	0.25	0.25	0.30	0.30	0.35	0.40	0.45
P2.1.4 Low-alloy steel, heat-treated, Rm 1190 N/mm ² , 350 HB	7	0.02	0.05	0.15	0.20	0.25	0.25	0.25	0.30	0.30	0.35	0.40	0.45
P3.1.1 High-alloy steel and tool steel, annealed, Rm 680 N/mm ² , 200 HB	10	0.02	0.05	0.15	0.20	0.25	0.25	0.25	0.30	0.30	0.35	0.40	0.45
P3.1.2 High-alloy steel and tool steel, hardened and tempered, Rm 1100 N/mm ² , 325 HB	7	0.02	0.05	0.15	0.20	0.25	0.25	0.25	0.30	0.30	0.35	0.40	0.45
M1.1.1 Stainless steel, ferritic/martensitic, with machining additives	6	0.02	0.10	0.15	0.25	0.30	0.30	0.35	0.35	0.40	0.45	0.50	0.55
M1.1.2 Stainless steel, ferritic/martensitic, annealed, Rm 680 N/mm ² , 200 HB	5	0.02	0.10	0.15	0.25	0.30	0.30	0.35	0.35	0.40	0.45	0.50	0.55
M1.1.3 Stainless steel, ferritic/martensitic, heat-treated, Rm 810 N/mm ² , 240 HB	5	0.02	0.10	0.15	0.25	0.30	0.30	0.35	0.35	0.40	0.45	0.50	0.55
M2.1.1 Stainless steel, austenitic, quenched, 180 HB	4	0.02	0.10	0.15	0.25	0.30	0.30	0.35	0.35	0.40	0.45	0.50	0.55
M2.2.1 Duplex steel, high-strength stainless steels	3	0.02	0.10	0.15	0.25	0.30	0.30	0.35	0.35	0.40	0.45	0.50	0.55
K1.1.1 Grey cast iron, pearlitic/ferritic, 180 HB	14	0.02	0.05	0.15	0.20	0.25	0.25	0.25	0.30	0.30	0.35	0.40	0.45
K1.1.2 Grey cast iron, pearlitic/martensitic, 260 HB	13	0.02	0.05	0.15	0.20	0.25	0.25	0.25	0.30	0.30	0.35	0.40	0.45
K1.2.1 Cast iron with spheroidal graphite, ferritic, 160 HB	17	0.02	0.05	0.15	0.20	0.25	0.25	0.25	0.30	0.30	0.35	0.40	0.45
K1.2.2 Cast iron with spheroidal graphite, pearlitic, 250 HB	17	0.02	0.05	0.15	0.20	0.25	0.25	0.25	0.30	0.30	0.35	0.40	0.45
K1.3.1 Malleable cast iron, ferritic, 130 HB	14	0.02	0.05	0.15	0.20	0.25	0.25	0.25	0.30	0.30	0.35	0.40	0.45
K1.3.2 Malleable cast iron, pearlitic, 230 HB	13	0.02	0.05	0.15	0.20	0.25	0.25	0.25	0.30	0.30	0.35	0.40	0.45
K2.1.1 Vermicular graphite cast iron (GJV)	8	0.02	0.05	0.15	0.20	0.25	0.25	0.25	0.30	0.30	0.35	0.40	0.45
K2.2.1 Austenitic-ferritic spheroidal graphite cast iron (ADI)	6	0.02	0.05	0.15	0.20	0.25	0.25	0.25	0.30	0.30	0.35	0.40	0.45
N1.1.1 Wrought aluminium alloys, non-hardened, 60 HB	18	0.03	0.10	0.20	0.30	0.40	0.40	0.45	0.45	0.50	0.60	0.65	0.75
N1.1.2 Wrought aluminium alloys, hardened, 100 HB	18	0.03	0.10	0.20	0.30	0.40	0.40	0.45	0.45	0.50	0.60	0.65	0.75
N2.1.1 Aluminium casting alloys, non-hardened, ≤ 12 % Si, 75 HB	20	0.02	0.10	0.15	0.25	0.30	0.30	0.35	0.35	0.40	0.45	0.50	0.55
N2.1.2 Aluminium casting alloys, hardened, ≤ 12 % Si, 90 HB	15	0.02	0.10	0.15	0.25	0.30	0.30	0.35	0.35	0.40	0.45	0.50	0.55
N2.1.3 Aluminium casting alloys, non-hardened, > 12 % Si, 130 HB	15	0.02	0.10	0.15	0.25	0.30	0.30	0.35	0.35	0.40	0.45	0.50	0.55
N3.1.1 Copper and copper alloys: Free-machining alloy, Pb > 1 %	18	0.02	0.10	0.15	0.25	0.30	0.30	0.35	0.35	0.40	0.45	0.50	0.55
N3.1.2 Copper and copper alloys: CuZn, CuSnZn	18	0.02	0.10	0.15	0.25	0.30	0.30	0.35	0.35	0.40	0.45	0.50	0.55
N3.1.3 Copper and copper alloys: CuSn, lead-free copper and copper electrolyte	18	0.02	0.10	0.15	0.25	0.30	0.30	0.35	0.35	0.40	0.45	0.50	0.55
N4.1.1 Non-metallic materials: Duroplastics, fibre-reinforced plastics	12	0.03	0.10	0.20	0.30	0.40	0.40	0.45	0.45	0.50	0.60	0.65	0.75
N4.1.2 Non-metallic materials: Hard rubber, wood, etc.	12	0.03	0.10	0.20	0.30	0.40	0.40	0.45	0.45	0.50	0.60	0.65	0.75
N4.1.3 Non-metallic materials: Graphite	7	0.03	0.10	0.20	0.30	0.40	0.40	0.45	0.45	0.50	0.60	0.65	0.75
S1.1.1 Heat-resistant alloys, Fe-based, annealed, 200 HB	4	0.02	0.05	0.15	0.20	0.25	0.25	0.25	0.30	0.30	0.35	0.40	0.45
S1.1.2 Heat-resistant alloys, Fe-based, hardened, 280 HB	4	0.02	0.05	0.15	0.20	0.25	0.25	0.25	0.30	0.30	0.35	0.40	0.45
S1.1.3 Heat-resistant alloys, Ni- or Co-based, annealed, 250 HB	4	0.02	0.05	0.15	0.20	0.25	0.25	0.25	0.30	0.30	0.35	0.40	0.45
S1.1.4 Heat-resistant alloys, Ni- or Co-based, hardened, 350 HB	4	0.02	0.05	0.15	0.20	0.25	0.25	0.25	0.30	0.30	0.35	0.40	0.45
S1.1.5 Heat-resistant alloys, Ni- or Co-based, cast, 320 HB	4	0.02	0.05	0.15	0.20	0.25	0.25	0.25	0.30	0.30	0.35	0.40	0.45
S2.1.1 Titanium alloys, pure titanium, Rm 400 N/mm ²	4	0.02	0.05	0.15	0.20	0.25	0.25	0.25	0.30	0.30	0.35	0.40	0.45
S2.1.2 Titanium alloys, Alpha and Beta alloys, hardened, Rm 1050 N/mm ²	4	0.02	0.05	0.15	0.20	0.25	0.25	0.25	0.30	0.30	0.35	0.40	0.45
H1.1.1 Hardened steel, hardened and tempered, < 55 HRC													
H1.1.2 Hardened steel, hardened and tempered, < 60 HRC													
H1.1.3 Hardened steel, hardened and tempered, > 60 HRC													
H2.1.1 Chilled cast iron, 400 HB													
H2.1.2 Chilled cast iron, hardened and tempered, < 55 HRC													



Machine reamers, TiN



Machining group	S V _c (m/min)	f (mm/rev) with nom. Ø									
		4	5	6	8	10	12	14	16	18	20
P1.1.1 Unalloyed steel, annealed, 0.15 % C, Rm 420 N/mm ² , 125 HB	16	0.10	0.15	0.20	0.25	0.30	0.30	0.35	0.35	0.40	0.40
P1.1.2 Unalloyed steel, heat-treated, 0.15 % C, Rm 420 N/mm ² , 125 HB	16	0.10	0.15	0.20	0.25	0.30	0.30	0.35	0.35	0.40	0.40
P1.1.3 Unalloyed steel, annealed, 0.45 % C, Rm 640 N/mm ² , 190 HB	16	0.10	0.15	0.20	0.25	0.30	0.30	0.35	0.35	0.40	0.40
P1.1.4 Unalloyed steel, heat-treated, 0.45 % C, Rm 640 N/mm ² , 190 HB	16	0.10	0.15	0.20	0.25	0.30	0.30	0.35	0.35	0.40	0.40
P1.1.5 Unalloyed steel, heat-treated, 0.45 % C, Rm 850 N/mm ² , 250 HB	14	0.10	0.15	0.20	0.25	0.30	0.30	0.35	0.35	0.40	0.40
P1.1.6 Unalloyed steel, annealed, 0.75 % C, Rm 915 N/mm ² , 270 HB	14	0.10	0.15	0.20	0.25	0.30	0.30	0.35	0.35	0.40	0.40
P1.1.7 Unalloyed steel, heat-treated, 0.75 % C, Rm 1020 N/mm ² , 300 HB	13	0.10	0.15	0.20	0.25	0.30	0.30	0.35	0.35	0.40	0.40
P2.1.1 Low-alloy steel, annealed, Rm 610 N/mm ² , 180 HB	12	0.10	0.15	0.15	0.20	0.25	0.25	0.25	0.30	0.30	0.30
P2.1.2 Low-alloy steel, heat-treated, Rm 930 N/mm ² , 275 HB	12	0.10	0.15	0.15	0.20	0.25	0.25	0.25	0.30	0.30	0.30
P2.1.3 Low-alloy steel, heat-treated, Rm 1020 N/mm ² , 300 HB	12	0.10	0.15	0.15	0.20	0.25	0.25	0.25	0.30	0.30	0.30
P2.1.4 Low-alloy steel, heat-treated, Rm 1190 N/mm ² , 350 HB	8	0.10	0.15	0.15	0.20	0.25	0.25	0.25	0.30	0.30	0.30
P3.1.1 High-alloy steel and tool steel, annealed, Rm 680 N/mm ² , 200 HB	12	0.10	0.15	0.15	0.20	0.25	0.25	0.25	0.30	0.30	0.30
P3.1.2 High-alloy steel and tool steel, hardened and tempered, Rm 1100 N/mm ² , 325 HB	8	0.10	0.15	0.15	0.20	0.25	0.25	0.25	0.30	0.30	0.30
M1.1.1 Stainless steel, ferritic/martensitic, with machining additives	8	0.10	0.15	0.20	0.25	0.30	0.30	0.35	0.35	0.40	0.40
M1.1.2 Stainless steel, ferritic/martensitic, annealed, Rm 680 N/mm ² , 200 HB	6	0.10	0.15	0.20	0.25	0.30	0.30	0.35	0.35	0.40	0.40
M1.1.3 Stainless steel, ferritic/martensitic, heat-treated, Rm 810 N/mm ² , 240 HB	6	0.10	0.15	0.20	0.25	0.30	0.30	0.35	0.35	0.40	0.40
M2.1.1 Stainless steel, austenitic, quenched, 180 HB	6	0.10	0.15	0.20	0.25	0.30	0.30	0.35	0.35	0.40	0.40
M2.2.1 Duplex steel, high-strength stainless steels	4	0.10	0.15	0.20	0.25	0.30	0.30	0.35	0.35	0.40	0.40
K1.1.1 Grey cast iron, pearlitic/ferritic, 180 HB	16	0.10	0.15	0.15	0.20	0.25	0.25	0.25	0.30	0.30	0.30
K1.1.2 Grey cast iron, pearlitic/martensitic, 260 HB	14	0.10	0.15	0.15	0.20	0.25	0.25	0.25	0.30	0.30	0.30
K1.2.1 Cast iron with spheroidal graphite, ferritic, 160 HB	19	0.10	0.15	0.15	0.20	0.25	0.25	0.25	0.30	0.30	0.30
K1.2.2 Cast iron with spheroidal graphite, pearlitic, 250 HB	19	0.10	0.15	0.15	0.20	0.25	0.25	0.25	0.30	0.30	0.30
K1.3.1 Malleable cast iron, ferritic, 130 HB	16	0.10	0.15	0.15	0.20	0.25	0.25	0.25	0.30	0.30	0.30
K1.3.2 Malleable cast iron, pearlitic, 230 HB	14	0.10	0.15	0.15	0.20	0.25	0.25	0.25	0.30	0.30	0.30
K2.1.1 Vermicular graphite cast iron (GJV)	10	0.10	0.15	0.15	0.20	0.25	0.25	0.25	0.30	0.30	0.30
K2.2.1 Austenitic-ferritic spheroidal graphite cast iron (ADI)	8	0.10	0.15	0.15	0.20	0.25	0.25	0.25	0.30	0.30	0.30
N1.1.1 Wrought aluminium alloys, non-hardened, 60 HB	20	0.15	0.20	0.25	0.30	0.40	0.40	0.45	0.45	0.50	0.50
N1.1.2 Wrought aluminium alloys, hardened, 100 HB	20	0.15	0.20	0.25	0.30	0.40	0.40	0.45	0.45	0.50	0.50
N2.1.1 Aluminium casting alloys, non-hardened, ≤ 12 % Si, 75 HB	22	0.10	0.15	0.20	0.25	0.30	0.30	0.35	0.35	0.40	0.40
N2.1.2 Aluminium casting alloys, hardened, ≤ 12 % Si, 90 HB	17	0.10	0.15	0.20	0.25	0.30	0.30	0.35	0.35	0.40	0.40
N2.1.3 Aluminium casting alloys, non-hardened, > 12 % Si, 130 HB	17	0.10	0.15	0.20	0.25	0.30	0.30	0.35	0.35	0.40	0.40
N3.1.1 Copper and copper alloys: Free-machining alloy, Pb > 1 %	18	0.10	0.20	0.25	0.30	0.35	0.40	0.40	0.45	0.45	0.45
N3.1.2 Copper and copper alloys: CuZn, CuSnZn	18	0.10	0.20	0.25	0.30	0.35	0.40	0.40	0.45	0.45	0.45
N3.1.3 Copper and copper alloys: CuSn, lead-free copper and copper electrolyte	18	0.10	0.20	0.25	0.30	0.35	0.40	0.40	0.45	0.45	0.45
N4.1.1 Non-metallic materials: Duroplastics, fibre-reinforced plastics	14	0.15	0.20	0.25	0.30	0.40	0.40	0.45	0.45	0.50	0.50
N4.1.2 Non-metallic materials: Hard rubber, wood, etc.	14	0.15	0.20	0.25	0.30	0.40	0.40	0.45	0.45	0.50	0.50
N4.1.3 Non-metallic materials: Graphite	8	0.15	0.20	0.25	0.30	0.40	0.40	0.45	0.45	0.50	0.50
S1.1.1 Heat-resistant alloys, Fe-based, annealed, 200 HB	6	0.10	0.15	0.15	0.20	0.25	0.25	0.25	0.30	0.30	0.30
S1.1.2 Heat-resistant alloys, Fe-based, hardened, 280 HB	6	0.10	0.15	0.15	0.20	0.25	0.25	0.25	0.30	0.30	0.30
S1.1.3 Heat-resistant alloys, Ni- or Co-based, annealed, 250 HB	6	0.10	0.15	0.15	0.20	0.25	0.25	0.25	0.30	0.30	0.30
S1.1.4 Heat-resistant alloys, Ni- or Co-based, hardened, 350 HB	6	0.10	0.15	0.15	0.20	0.25	0.25	0.25	0.30	0.30	0.30
S1.1.5 Heat-resistant alloys, Ni- or Co-based, cast, 320 HB	6	0.10	0.15	0.15	0.20	0.25	0.25	0.25	0.30	0.30	0.30
S2.1.1 Titanium alloys, pure titanium, Rm 400 N/mm ²	6	0.10	0.15	0.15	0.20	0.25	0.25	0.25	0.30	0.30	0.30
S2.1.2 Titanium alloys, Alpha and Beta alloys, hardened, Rm 1050 N/mm ²	6	0.10	0.15	0.15	0.20	0.25	0.25	0.25	0.30	0.30	0.30
H1.1.1 Hardened steel, hardened and tempered, < 55 HRC											
H1.1.2 Hardened steel, hardened and tempered, < 60 HRC											
H1.1.3 Hardened steel, hardened and tempered, > 60 HRC											
H2.1.1 Chilled cast iron, 400 HB											
H2.1.2 Chilled cast iron, hardened and tempered, < 55 HRC											



Machine reamers



Cutting data

Machining group	V _c (m/min)	f (mm/rev) with nom. Ø									
		4	5	6	8	10	12	14	16	18	20
P1.1.1 Unalloyed steel, annealed, 0.15 % C, Rm 420 N/mm ² , 125 HB	15	0.10	0.15	0.15	0.20	0.25	0.25	0.25	0.30	0.30	0.30
P1.1.2 Unalloyed steel, heat-treated, 0.15 % C, Rm 420 N/mm ² , 125 HB	15	0.10	0.15	0.15	0.20	0.25	0.25	0.25	0.30	0.30	0.30
P1.1.3 Unalloyed steel, annealed, 0.45 % C, Rm 640 N/mm ² , 190 HB	15	0.10	0.15	0.15	0.20	0.25	0.25	0.25	0.30	0.30	0.30
P1.1.4 Unalloyed steel, heat-treated, 0.45 % C, Rm 640 N/mm ² , 190 HB	15	0.10	0.15	0.15	0.20	0.25	0.25	0.25	0.30	0.30	0.30
P1.1.5 Unalloyed steel, heat-treated, 0.45 % C, Rm 850 N/mm ² , 250 HB	14	0.10	0.15	0.15	0.20	0.25	0.25	0.25	0.30	0.30	0.30
P1.1.6 Unalloyed steel, annealed, 0.75 % C, Rm 915 N/mm ² , 270 HB	14	0.10	0.15	0.15	0.20	0.25	0.25	0.25	0.30	0.30	0.30
P1.1.7 Unalloyed steel, heat-treated, 0.75 % C, Rm 1020 N/mm ² , 300 HB	12	0.10	0.15	0.15	0.20	0.25	0.25	0.25	0.30	0.30	0.30
P2.1.1 Low-alloy steel, annealed, Rm 610 N/mm ² , 180 HB	11	0.10	0.15	0.15	0.20	0.25	0.25	0.25	0.30	0.30	0.30
P2.1.2 Low-alloy steel, heat-treated, Rm 930 N/mm ² , 275 HB	11	0.10	0.15	0.15	0.20	0.25	0.25	0.25	0.30	0.30	0.30
P2.1.3 Low-alloy steel, heat-treated, Rm 1020 N/mm ² , 300 HB	11	0.10	0.15	0.15	0.20	0.25	0.25	0.25	0.30	0.30	0.30
P2.1.4 Low-alloy steel, heat-treated, Rm 1190 N/mm ² , 350 HB	7	0.10	0.15	0.15	0.20	0.25	0.25	0.25	0.30	0.30	0.30
P3.1.1 High-alloy steel and tool steel, annealed, Rm 680 N/mm ² , 200 HB	11	0.10	0.15	0.15	0.20	0.25	0.25	0.25	0.30	0.30	0.30
P3.1.2 High-alloy steel and tool steel, hardened and tempered, Rm 1100 N/mm ² , 325 HB	7	0.10	0.15	0.15	0.20	0.25	0.25	0.25	0.30	0.30	0.30
M1.1.1 Stainless steel, ferritic/martensitic, with machining additives	7	0.10	0.15	0.15	0.20	0.25	0.25	0.25	0.30	0.30	0.30
M1.1.2 Stainless steel, ferritic/martensitic, annealed, Rm 680 N/mm ² , 200 HB	5	0.10	0.15	0.15	0.20	0.25	0.25	0.25	0.30	0.30	0.30
M1.1.3 Stainless steel, ferritic/martensitic, heat-treated, Rm 810 N/mm ² , 240 HB	5	0.10	0.15	0.15	0.20	0.25	0.25	0.25	0.30	0.30	0.30
M2.1.1 Stainless steel, austenitic, quenched, 180 HB	5	0.10	0.15	0.15	0.20	0.25	0.25	0.25	0.30	0.30	0.30
M2.2.1 Duplex steel, high-strength stainless steels	3	0.10	0.15	0.15	0.20	0.25	0.25	0.25	0.30	0.30	0.30
K1.1.1 Grey cast iron, pearlitic/ferritic, 180 HB	15	0.10	0.15	0.15	0.20	0.25	0.25	0.25	0.30	0.30	0.30
K1.1.2 Grey cast iron, pearlitic/martensitic, 260 HB	14	0.10	0.15	0.15	0.20	0.25	0.25	0.25	0.30	0.30	0.30
K1.2.1 Cast iron with spheroidal graphite, ferritic, 160 HB	18	0.10	0.15	0.15	0.20	0.25	0.25	0.25	0.30	0.30	0.30
K1.2.2 Cast iron with spheroidal graphite, pearlitic, 250 HB	18	0.10	0.15	0.15	0.20	0.25	0.25	0.25	0.30	0.30	0.30
K1.3.1 Malleable cast iron, ferritic, 130 HB	15	0.10	0.15	0.15	0.20	0.25	0.25	0.25	0.30	0.30	0.30
K1.3.2 Malleable cast iron, pearlitic, 230 HB	14	0.10	0.15	0.15	0.20	0.25	0.25	0.25	0.30	0.30	0.30
K2.1.1 Vermicular graphite cast iron (GJV)	9	0.10	0.15	0.15	0.20	0.25	0.25	0.25	0.30	0.30	0.30
K2.2.1 Austenitic-ferritic spheroidal graphite cast iron (ADI)	7	0.10	0.15	0.15	0.20	0.25	0.25	0.25	0.30	0.30	0.30
N1.1.1 Wrought aluminium alloys, non-hardened, 60 HB	19	0.15	0.20	0.25	0.30	0.40	0.40	0.45	0.45	0.50	0.50
N1.1.2 Wrought aluminium alloys, hardened, 100 HB	19	0.15	0.20	0.25	0.30	0.40	0.40	0.45	0.45	0.50	0.50
N2.1.1 Aluminium casting alloys, non-hardened, ≤ 12 % Si, 75 HB	21	0.10	0.15	0.20	0.25	0.30	0.30	0.35	0.35	0.40	0.40
N2.1.2 Aluminium casting alloys, hardened, ≤ 12 % Si, 90 HB	16	0.10	0.15	0.20	0.25	0.30	0.30	0.35	0.35	0.40	0.40
N2.1.3 Aluminium casting alloys, non-hardened, > 12 % Si, 130 HB	16	0.10	0.15	0.20	0.25	0.30	0.30	0.35	0.35	0.40	0.40
N3.1.1 Copper and copper alloys: Free-machining alloy, Pb > 1 %	19	0.10	0.15	0.20	0.25	0.30	0.30	0.35	0.35	0.40	0.40
N3.1.2 Copper and copper alloys: CuZn, CuSnZn	19	0.10	0.15	0.20	0.25	0.30	0.30	0.35	0.35	0.40	0.40
N3.1.3 Copper and copper alloys: CuSn, lead-free copper and copper electrolyte	19	0.10	0.15	0.20	0.25	0.30	0.30	0.35	0.35	0.40	0.40
N4.1.1 Non-metallic materials: Duroplastics, fibre-reinforced plastics	13	0.15	0.20	0.25	0.30	0.40	0.40	0.45	0.45	0.50	0.50
N4.1.2 Non-metallic materials: Hard rubber, wood, etc.	13	0.15	0.20	0.25	0.30	0.40	0.40	0.45	0.45	0.50	0.50
N4.1.3 Non-metallic materials: Graphite	8	0.15	0.20	0.25	0.30	0.40	0.40	0.45	0.45	0.50	0.50
S1.1.1 Heat-resistant alloys, Fe-based, annealed, 200 HB	5	0.10	0.15	0.15	0.20	0.25	0.25	0.25	0.30	0.30	0.30
S1.1.2 Heat-resistant alloys, Fe-based, hardened, 280 HB	5	0.10	0.15	0.15	0.20	0.25	0.25	0.25	0.30	0.30	0.30
S1.1.3 Heat-resistant alloys, Ni- or Co-based, annealed, 250 HB	5	0.10	0.15	0.15	0.20	0.25	0.25	0.25	0.30	0.30	0.30
S1.1.4 Heat-resistant alloys, Ni- or Co-based, hardened, 350 HB	5	0.10	0.15	0.15	0.20	0.25	0.25	0.25	0.30	0.30	0.30
S1.1.5 Heat-resistant alloys, Ni- or Co-based, cast, 320 HB	5	0.10	0.15	0.15	0.20	0.25	0.25	0.25	0.30	0.30	0.30
S2.1.1 Titanium alloys, pure titanium, Rm 400 N/mm ²	5	0.10	0.15	0.15	0.20	0.25	0.25	0.25	0.30	0.30	0.30
S2.1.2 Titanium alloys, Alpha and Beta alloys, hardened, Rm 1050 N/mm ²	5	0.10	0.15	0.15	0.20	0.25	0.25	0.25	0.30	0.30	0.30
H1.1.1 Hardened steel, hardened and tempered, < 55 HRC											
H1.1.2 Hardened steel, hardened and tempered, < 60 HRC											
H1.1.3 Hardened steel, hardened and tempered, > 60 HRC											
H2.1.1 Chilled cast iron, 400 HB											
H2.1.2 Chilled cast iron, hardened and tempered, < 55 HRC											



Quick helix reamers



Machining group	V _c (m/min)	f (mm/rev) with nom. Ø											
		1	3	5	6	8	10	12	14	16	20	25	32
P1.1.1 Unalloyed steel, annealed, 0.15 % C, Rm 420 N/mm ² , 125 HB	14	0.02	0.05	0.15	0.15	0.20	0.25	0.25	0.25	0.30	0.30	0.35	0.40
P1.1.2 Unalloyed steel, heat-treated, 0.15 % C, Rm 420 N/mm ² , 125 HB	14	0.02	0.05	0.15	0.15	0.20	0.25	0.25	0.25	0.30	0.30	0.35	0.40
P1.1.3 Unalloyed steel, annealed, 0.45 % C, Rm 640 N/mm ² , 190 HB	14	0.02	0.05	0.15	0.15	0.20	0.25	0.25	0.25	0.30	0.30	0.35	0.40
P1.1.4 Unalloyed steel, heat-treated, 0.45 % C, Rm 640 N/mm ² , 190 HB	14	0.02	0.05	0.15	0.15	0.20	0.25	0.25	0.25	0.30	0.30	0.35	0.40
P1.1.5 Unalloyed steel, heat-treated, 0.45 % C, Rm 850 N/mm ² , 250 HB	13	0.02	0.05	0.15	0.15	0.20	0.25	0.25	0.25	0.30	0.30	0.35	0.40
P1.1.6 Unalloyed steel, annealed, 0.75 % C, Rm 915 N/mm ² , 270 HB	13	0.02	0.05	0.15	0.15	0.20	0.25	0.25	0.25	0.30	0.30	0.35	0.40
P1.1.7 Unalloyed steel, heat-treated, 0.75 % C, Rm 1020 N/mm ² , 300 HB	11	0.02	0.05	0.15	0.15	0.20	0.25	0.25	0.25	0.30	0.30	0.35	0.40
P2.1.1 Low-alloy steel, annealed, Rm 610 N/mm ² , 180 HB	10	0.02	0.05	0.15	0.15	0.20	0.25	0.25	0.25	0.30	0.30	0.35	0.40
P2.1.2 Low-alloy steel, heat-treated, Rm 930 N/mm ² , 275 HB	10	0.02	0.05	0.15	0.15	0.20	0.25	0.25	0.25	0.30	0.30	0.35	0.40
P2.1.3 Low-alloy steel, heat-treated, Rm 1020 N/mm ² , 300 HB	10	0.02	0.05	0.15	0.15	0.20	0.25	0.25	0.25	0.30	0.30	0.35	0.40
P2.1.4 Low-alloy steel, heat-treated, Rm 1190 N/mm ² , 350 HB	7	0.02	0.05	0.15	0.15	0.20	0.25	0.25	0.25	0.30	0.30	0.35	0.40
P3.1.1 High-alloy steel and tool steel, annealed, Rm 680 N/mm ² , 200 HB													
P3.1.2 High-alloy steel and tool steel, hardened and tempered, Rm 1100 N/mm ² , 325 HB													
M1.1.1 Stainless steel, ferritic/martensitic, with machining additives													
M1.1.2 Stainless steel, ferritic/martensitic, annealed, Rm 680 N/mm ² , 200 HB													
M1.1.3 Stainless steel, ferritic/martensitic, heat-treated, Rm 810 N/mm ² , 240 HB													
M2.1.1 Stainless steel, austenitic, quenched, 180 HB													
M2.2.1 Duplex steel, high-strength stainless steels													
K1.1.1 Grey cast iron, pearlitic/ferritic, 180 HB													
K1.1.2 Grey cast iron, pearlitic/martensitic, 260 HB													
K1.2.1 Cast iron with spheroidal graphite, ferritic, 160 HB													
K1.2.2 Cast iron with spheroidal graphite, pearlitic, 250 HB													
K1.3.1 Malleable cast iron, ferritic, 130 HB													
K1.3.2 Malleable cast iron, pearlitic, 230 HB													
K2.1.1 Vermicular graphite cast iron (GJV)													
K2.2.1 Austenitic-ferritic spheroidal graphite cast iron (ADI)													
N1.1.1 Wrought aluminium alloys, non-hardened, 60 HB	18	0.03	0.10	0.20	0.25	0.30	0.40	0.40	0.45	0.45	0.50	0.55	0.60
N1.1.2 Wrought aluminium alloys, hardened, 100 HB	18	0.03	0.10	0.20	0.25	0.30	0.40	0.40	0.45	0.45	0.50	0.55	0.60
N2.1.1 Aluminium casting alloys, non-hardened, ≤ 12 % Si, 75 HB	20	0.03	0.10	0.20	0.25	0.30	0.40	0.40	0.45	0.45	0.50	0.55	0.60
N2.1.2 Aluminium casting alloys, hardened, ≤ 12 % Si, 90 HB	15	0.03	0.10	0.20	0.25	0.30	0.40	0.40	0.45	0.45	0.50	0.55	0.60
N2.1.3 Aluminium casting alloys, non-hardened, > 12 % Si, 130 HB	15	0.03	0.10	0.20	0.25	0.30	0.40	0.40	0.45	0.45	0.50	0.55	0.60
N3.1.1 Copper and copper alloys: Free-machining alloy, Pb > 1 %													
N3.1.2 Copper and copper alloys: CuZn, CuSnZn													
N3.1.3 Copper and copper alloys: CuSn, lead-free copper and copper electrolyte													
N4.1.1 Non-metallic materials: Duroplastics, fibre-reinforced plastics	12	0.03	0.10	0.20	0.25	0.30	0.40	0.40	0.45	0.45	0.50	0.55	0.60
N4.1.2 Non-metallic materials: Hard rubber, wood, etc.	12	0.03	0.10	0.20	0.25	0.30	0.40	0.40	0.45	0.45	0.50	0.55	0.60
N4.1.3 Non-metallic materials: Graphite	7	0.03	0.10	0.20	0.25	0.30	0.40	0.40	0.45	0.45	0.50	0.55	0.60
S1.1.1 Heat-resistant alloys, Fe-based, annealed, 200 HB	5	0.02	0.05	0.15	0.15	0.20	0.25	0.25	0.25	0.30	0.30	0.35	0.40
S1.1.2 Heat-resistant alloys, Fe-based, hardened, 280 HB	5	0.02	0.05	0.15	0.15	0.20	0.25	0.25	0.25	0.30	0.30	0.35	0.40
S1.1.3 Heat-resistant alloys, Ni- or Co-based, annealed, 250 HB	5	0.02	0.05	0.15	0.15	0.20	0.25	0.25	0.25	0.30	0.30	0.35	0.40
S1.1.4 Heat-resistant alloys, Ni- or Co-based, hardened, 350 HB	5	0.02	0.05	0.15	0.15	0.20	0.25	0.25	0.25	0.30	0.30	0.35	0.40
S1.1.5 Heat-resistant alloys, Ni- or Co-based, cast, 320 HB	5	0.02	0.05	0.15	0.15	0.20	0.25	0.25	0.25	0.30	0.30	0.35	0.40
S2.1.1 Titanium alloys, pure titanium, Rm 400 N/mm ²													
S2.1.2 Titanium alloys, Alpha and Beta alloys, hardened, Rm 1050 N/mm ²													
H1.1.1 Hardened steel, hardened and tempered, < 55 HRC													
H1.1.2 Hardened steel, hardened and tempered, < 60 HRC													
H1.1.3 Hardened steel, hardened and tempered, > 60 HRC													
H2.1.1 Chilled cast iron, 400 HB													
H2.1.2 Chilled cast iron, hardened and tempered, < 55 HRC													



Bridge reamers



Cutting data

Machining group	V _c (m/min)	f (mm/rev) with nom. Ø											
		6.4	10	12	14	16	18	20	22	24	28	32	37
P1.1.1 Unalloyed steel, annealed, 0.15 % C, Rm 420 N/mm ² , 125 HB	12	0.20	0.30	0.30	0.35	0.35	0.40	0.40	0.40	0.40	0.45	0.50	0.50
P1.1.2 Unalloyed steel, heat-treated, 0.15 % C, Rm 420 N/mm ² , 125 HB	12	0.20	0.30	0.30	0.35	0.35	0.40	0.40	0.40	0.40	0.45	0.50	0.50
P1.1.3 Unalloyed steel, annealed, 0.45 % C, Rm 640 N/mm ² , 190 HB	12	0.20	0.30	0.30	0.35	0.35	0.40	0.40	0.40	0.40	0.45	0.50	0.50
P1.1.4 Unalloyed steel, heat-treated, 0.45 % C, Rm 640 N/mm ² , 190 HB	12	0.20	0.30	0.30	0.35	0.35	0.40	0.40	0.40	0.40	0.45	0.50	0.50
P1.1.5 Unalloyed steel, heat-treated, 0.45 % C, Rm 850 N/mm ² , 250 HB	11	0.20	0.30	0.30	0.35	0.35	0.40	0.40	0.40	0.40	0.45	0.50	0.50
P1.1.6 Unalloyed steel, annealed, 0.75 % C, Rm 915 N/mm ² , 270 HB	11	0.20	0.30	0.30	0.35	0.35	0.40	0.40	0.40	0.40	0.45	0.50	0.50
P1.1.7 Unalloyed steel, heat-treated, 0.75 % C, Rm 1020 N/mm ² , 300 HB	10	0.20	0.30	0.30	0.35	0.35	0.40	0.40	0.40	0.40	0.45	0.50	0.50
P2.1.1 Low-alloy steel, annealed, Rm 610 N/mm ² , 180 HB	10	0.20	0.30	0.30	0.35	0.35	0.40	0.40	0.40	0.40	0.45	0.50	0.50
P2.1.2 Low-alloy steel, heat-treated, Rm 930 N/mm ² , 275 HB	10	0.20	0.30	0.30	0.35	0.35	0.40	0.40	0.40	0.40	0.45	0.50	0.50
P2.1.3 Low-alloy steel, heat-treated, Rm 1020 N/mm ² , 300 HB	10	0.20	0.30	0.30	0.35	0.35	0.40	0.40	0.40	0.40	0.45	0.50	0.50
P2.1.4 Low-alloy steel, heat-treated, Rm 1190 N/mm ² , 350 HB	7	0.20	0.30	0.30	0.35	0.35	0.40	0.40	0.40	0.40	0.45	0.50	0.50
P3.1.1 High-alloy steel and tool steel, annealed, Rm 680 N/mm ² , 200 HB	8	0.15	0.25	0.25	0.25	0.30	0.30	0.30	0.35	0.35	0.35	0.40	0.40
P3.1.2 High-alloy steel and tool steel, hardened and tempered, Rm 1100 N/mm ² , 325 HB	5	0.15	0.25	0.25	0.25	0.30	0.30	0.30	0.35	0.35	0.35	0.40	0.40
M1.1.1 Stainless steel, ferritic/martensitic, with machining additives													
M1.1.2 Stainless steel, ferritic/martensitic, annealed, Rm 680 N/mm ² , 200 HB													
M1.1.3 Stainless steel, ferritic/martensitic, heat-treated, Rm 810 N/mm ² , 240 HB													
M2.1.1 Stainless steel, austenitic, quenched, 180 HB													
M2.2.1 Duplex steel, high-strength stainless steels													
K1.1.1 Grey cast iron, pearlitic/ferritic, 180 HB	12	0.15	0.25	0.25	0.25	0.30	0.30	0.30	0.35	0.35	0.35	0.40	0.40
K1.1.2 Grey cast iron, pearlitic/martensitic, 260 HB	11	0.15	0.25	0.25	0.25	0.30	0.30	0.30	0.35	0.35	0.35	0.40	0.40
K1.2.1 Cast iron with spheroidal graphite, ferritic, 160 HB	14	0.15	0.25	0.25	0.25	0.30	0.30	0.30	0.35	0.35	0.35	0.40	0.40
K1.2.2 Cast iron with spheroidal graphite, pearlitic, 250 HB	14	0.15	0.25	0.25	0.25	0.30	0.30	0.30	0.35	0.35	0.35	0.40	0.40
K1.3.1 Malleable cast iron, ferritic, 130 HB	12	0.15	0.25	0.25	0.25	0.30	0.30	0.30	0.35	0.35	0.35	0.40	0.40
K1.3.2 Malleable cast iron, pearlitic, 230 HB	11	0.15	0.25	0.25	0.25	0.30	0.30	0.30	0.35	0.35	0.35	0.40	0.40
K2.1.1 Vermicular graphite cast iron (GJV)													
K2.2.1 Austenitic-ferritic spheroidal graphite cast iron (ADI)													
N1.1.1 Wrought aluminium alloys, non-hardened, 60 HB													
N1.1.2 Wrought aluminium alloys, hardened, 100 HB													
N2.1.1 Aluminium casting alloys, non-hardened, ≤ 12 % Si, 75 HB	18	0.25	0.40	0.40	0.45	0.45	0.50	0.50	0.50	0.55	0.60	0.60	0.65
N2.1.2 Aluminium casting alloys, hardened, ≤ 12 % Si, 90 HB	14	0.25	0.40	0.40	0.45	0.45	0.50	0.50	0.50	0.55	0.60	0.60	0.65
N2.1.3 Aluminium casting alloys, non-hardened, > 12 % Si, 130 HB	14	0.25	0.40	0.40	0.45	0.45	0.50	0.50	0.50	0.55	0.60	0.60	0.65
N3.1.1 Copper and copper alloys: Free-machining alloy, Pb > 1 %	16	0.20	0.30	0.30	0.35	0.35	0.40	0.40	0.40	0.40	0.45	0.50	0.50
N3.1.2 Copper and copper alloys: CuZn, CuSnZn	16	0.20	0.30	0.30	0.35	0.35	0.40	0.40	0.40	0.40	0.45	0.50	0.50
N3.1.3 Copper and copper alloys: CuSn, lead-free copper and copper electrolyte	16	0.20	0.30	0.30	0.35	0.35	0.40	0.40	0.40	0.40	0.45	0.50	0.50
N4.1.1 Non-metallic materials: Duroplastics, fibre-reinforced plastics													
N4.1.2 Non-metallic materials: Hard rubber, wood, etc.													
N4.1.3 Non-metallic materials: Graphite													
S1.1.1 Heat-resistant alloys, Fe-based, annealed, 200 HB	4	0.15	0.25	0.25	0.25	0.30	0.30	0.30	0.35	0.35	0.35	0.40	0.40
S1.1.2 Heat-resistant alloys, Fe-based, hardened, 280 HB	4	0.15	0.25	0.25	0.25	0.30	0.30	0.30	0.35	0.35	0.35	0.40	0.40
S1.1.3 Heat-resistant alloys, Ni- or Co-based, annealed, 250 HB	4	0.15	0.25	0.25	0.25	0.30	0.30	0.30	0.35	0.35	0.35	0.40	0.40
S1.1.4 Heat-resistant alloys, Ni- or Co-based, hardened, 350 HB	4	0.15	0.25	0.25	0.25	0.30	0.30	0.30	0.35	0.35	0.35	0.40	0.40
S1.1.5 Heat-resistant alloys, Ni- or Co-based, cast, 320 HB	4	0.15	0.25	0.25	0.25	0.30	0.30	0.30	0.35	0.35	0.35	0.40	0.40
S2.1.1 Titanium alloys, pure titanium, Rm 400 N/mm ²	3	0.15	0.25	0.25	0.25	0.30	0.30	0.30	0.35	0.35	0.35	0.40	0.40
S2.1.2 Titanium alloys, Alpha and Beta alloys, hardened, Rm 1050 N/mm ²	3	0.15	0.25	0.25	0.25	0.30	0.30	0.30	0.35	0.35	0.35	0.40	0.40
H1.1.1 Hardened steel, hardened and tempered, < 55 HRC													
H1.1.2 Hardened steel, hardened and tempered, < 60 HRC													
H1.1.3 Hardened steel, hardened and tempered, > 60 HRC													
H2.1.1 Chilled cast iron, 400 HB													
H2.1.2 Chilled cast iron, hardened and tempered, < 55 HRC													



Machine bottoming reamers



Machining group	V _c (m/min)	f (mm/rev) with nom. Ø							
		3	4	5	6	7	8	10	12
P1.1.1 Unalloyed steel, annealed, 0.15 % C, Rm 420 N/mm ² , 125 HB	14	0.05	0.10	0.15	0.15	0.15	0.20	0.25	0.25
P1.1.2 Unalloyed steel, heat-treated, 0.15 % C, Rm 420 N/mm ² , 125 HB	14	0.05	0.10	0.15	0.15	0.15	0.20	0.25	0.25
P1.1.3 Unalloyed steel, annealed, 0.45 % C, Rm 640 N/mm ² , 190 HB	14	0.05	0.10	0.15	0.15	0.15	0.20	0.25	0.25
P1.1.4 Unalloyed steel, heat-treated, 0.45 % C, Rm 640 N/mm ² , 190 HB	14	0.05	0.10	0.15	0.15	0.15	0.20	0.25	0.25
P1.1.5 Unalloyed steel, heat-treated, 0.45 % C, Rm 850 N/mm ² , 250 HB	13	0.05	0.10	0.15	0.15	0.15	0.20	0.25	0.25
P1.1.6 Unalloyed steel, annealed, 0.75 % C, Rm 915 N/mm ² , 270 HB	13	0.05	0.10	0.15	0.15	0.15	0.20	0.25	0.25
P1.1.7 Unalloyed steel, heat-treated, 0.75 % C, Rm 1020 N/mm ² , 300 HB	11	0.05	0.10	0.15	0.15	0.15	0.20	0.25	0.25
P2.1.1 Low-alloy steel, annealed, Rm 610 N/mm ² , 180 HB	10	0.05	0.10	0.15	0.15	0.15	0.20	0.25	0.25
P2.1.2 Low-alloy steel, heat-treated, Rm 930 N/mm ² , 275 HB	10	0.05	0.10	0.15	0.15	0.15	0.20	0.25	0.25
P2.1.3 Low-alloy steel, heat-treated, Rm 1020 N/mm ² , 300 HB	10	0.05	0.10	0.15	0.15	0.15	0.20	0.25	0.25
P2.1.4 Low-alloy steel, heat-treated, Rm 1190 N/mm ² , 350 HB	7	0.05	0.10	0.15	0.15	0.15	0.20	0.25	0.25
P3.1.1 High-alloy steel and tool steel, annealed, Rm 680 N/mm ² , 200 HB	8	0.05	0.10	0.15	0.15	0.15	0.20	0.25	0.25
P3.1.2 High-alloy steel and tool steel, hardened and tempered, Rm 1100 N/mm ² , 325 HB	5	0.05	0.10	0.15	0.15	0.15	0.20	0.25	0.25
M1.1.1 Stainless steel, ferritic/martensitic, with machining additives	6	0.05	0.10	0.15	0.15	0.15	0.20	0.25	0.25
M1.1.2 Stainless steel, ferritic/martensitic, annealed, Rm 680 N/mm ² , 200 HB	5	0.05	0.10	0.15	0.15	0.15	0.20	0.25	0.25
M1.1.3 Stainless steel, ferritic/martensitic, heat-treated, Rm 810 N/mm ² , 240 HB	5	0.05	0.10	0.15	0.15	0.15	0.20	0.25	0.25
M2.1.1 Stainless steel, austenitic, quenched, 180 HB	4	0.05	0.10	0.15	0.15	0.15	0.20	0.25	0.25
M2.2.1 Duplex steel, high-strength stainless steels	3	0.05	0.10	0.15	0.15	0.15	0.20	0.25	0.25
K1.1.1 Grey cast iron, pearlitic/ferritic, 180 HB	12	0.05	0.10	0.15	0.15	0.15	0.20	0.25	0.25
K1.1.2 Grey cast iron, pearlitic/martensitic, 260 HB	11	0.05	0.10	0.15	0.15	0.15	0.20	0.25	0.25
K1.2.1 Cast iron with spheroidal graphite, ferritic, 160 HB	14	0.05	0.10	0.15	0.15	0.15	0.20	0.25	0.25
K1.2.2 Cast iron with spheroidal graphite, pearlitic, 250 HB	14	0.05	0.10	0.15	0.15	0.15	0.20	0.25	0.25
K1.3.1 Malleable cast iron, ferritic, 130 HB	12	0.05	0.10	0.15	0.15	0.15	0.20	0.25	0.25
K1.3.2 Malleable cast iron, pearlitic, 230 HB	11	0.05	0.10	0.15	0.15	0.15	0.20	0.25	0.25
K2.1.1 Vermicular graphite cast iron (GJV)									
K2.2.1 Austenitic-ferritic spheroidal graphite cast iron (ADI)									
N1.1.1 Wrought aluminium alloys, non-hardened, 60 HB	20	0.10	0.10	0.15	0.20	0.20	0.25	0.30	0.30
N1.1.2 Wrought aluminium alloys, hardened, 100 HB	20	0.10	0.10	0.15	0.20	0.20	0.25	0.30	0.30
N2.1.1 Aluminium casting alloys, non-hardened, ≤ 12 % Si, 75 HB	20	0.05	0.10	0.15	0.15	0.15	0.20	0.25	0.25
N2.1.2 Aluminium casting alloys, hardened, ≤ 12 % Si, 90 HB	15	0.05	0.10	0.15	0.15	0.15	0.20	0.25	0.25
N2.1.3 Aluminium casting alloys, non-hardened, > 12 % Si, 130 HB	15	0.05	0.10	0.15	0.15	0.15	0.20	0.25	0.25
N3.1.1 Copper and copper alloys: Free-machining alloy, Pb > 1 %	14	0.05	0.10	0.15	0.15	0.15	0.20	0.25	0.25
N3.1.2 Copper and copper alloys: CuZn, CuSnZn	14	0.05	0.10	0.15	0.15	0.15	0.20	0.25	0.25
N3.1.3 Copper and copper alloys: CuSn, lead-free copper and copper electrolyte	14	0.05	0.10	0.15	0.15	0.15	0.20	0.25	0.25
N4.1.1 Non-metallic materials: Duroplastics, fibre-reinforced plastics	12	0.10	0.15	0.20	0.25	0.30	0.30	0.40	0.40
N4.1.2 Non-metallic materials: Hard rubber, wood, etc.	12	0.10	0.15	0.20	0.25	0.30	0.30	0.40	0.40
N4.1.3 Non-metallic materials: Graphite	7	0.10	0.15	0.20	0.25	0.30	0.30	0.40	0.40
S1.1.1 Heat-resistant alloys, Fe-based, annealed, 200 HB	4	0.05	0.10	0.15	0.15	0.15	0.20	0.25	0.25
S1.1.2 Heat-resistant alloys, Fe-based, hardened, 280 HB	4	0.05	0.10	0.15	0.15	0.15	0.20	0.25	0.25
S1.1.3 Heat-resistant alloys, Ni- or Co-based, annealed, 250 HB	4	0.05	0.10	0.15	0.15	0.15	0.20	0.25	0.25
S1.1.4 Heat-resistant alloys, Ni- or Co-based, hardened, 350 HB	4	0.05	0.10	0.15	0.15	0.15	0.20	0.25	0.25
S1.1.5 Heat-resistant alloys, Ni- or Co-based, cast, 320 HB	4	0.05	0.10	0.15	0.15	0.15	0.20	0.25	0.25
S2.1.1 Titanium alloys, pure titanium, Rm 400 N/mm ²	3	0.05	0.10	0.15	0.15	0.15	0.20	0.25	0.25
S2.1.2 Titanium alloys, Alpha and Beta alloys, hardened, Rm 1050 N/mm ²	3	0.05	0.10	0.15	0.15	0.15	0.20	0.25	0.25
H1.1.1 Hardened steel, hardened and tempered, < 55 HRC									
H1.1.2 Hardened steel, hardened and tempered, < 60 HRC									
H1.1.3 Hardened steel, hardened and tempered, > 60 HRC									
H2.1.1 Chilled cast iron, 400 HB									
H2.1.2 Chilled cast iron, hardened and tempered, < 55 HRC									



Stepped machine reamers



Cutting data

Machining group	V _c (m/min)	f (mm/rev) with nom. Ø							
		5	6	8	10	12	14	16	20
P1.1.1 Unalloyed steel, annealed, 0.15 % C, Rm 420 N/mm ² , 125 HB	12	0.15	0.20	0.25	0.30	0.30	0.35	0.35	0.40
P1.1.2 Unalloyed steel, heat-treated, 0.15 % C, Rm 420 N/mm ² , 125 HB	12	0.15	0.20	0.25	0.30	0.30	0.35	0.35	0.40
P1.1.3 Unalloyed steel, annealed, 0.45 % C, Rm 640 N/mm ² , 190 HB	12	0.15	0.20	0.25	0.30	0.30	0.35	0.35	0.40
P1.1.4 Unalloyed steel, heat-treated, 0.45 % C, Rm 640 N/mm ² , 190 HB	12	0.15	0.20	0.25	0.30	0.30	0.35	0.35	0.40
P1.1.5 Unalloyed steel, heat-treated, 0.45 % C, Rm 850 N/mm ² , 250 HB	11	0.15	0.20	0.25	0.30	0.30	0.35	0.35	0.40
P1.1.6 Unalloyed steel, annealed, 0.75 % C, Rm 915 N/mm ² , 270 HB	11	0.15	0.20	0.25	0.30	0.30	0.35	0.35	0.40
P1.1.7 Unalloyed steel, heat-treated, 0.75 % C, Rm 1020 N/mm ² , 300 HB	10	0.15	0.20	0.25	0.30	0.30	0.35	0.35	0.40
P2.1.1 Low-alloy steel, annealed, Rm 610 N/mm ² , 180 HB	10	0.15	0.15	0.20	0.25	0.25	0.25	0.30	0.30
P2.1.2 Low-alloy steel, heat-treated, Rm 930 N/mm ² , 275 HB	10	0.15	0.15	0.20	0.25	0.25	0.25	0.30	0.30
P2.1.3 Low-alloy steel, heat-treated, Rm 1020 N/mm ² , 300 HB	10	0.15	0.15	0.20	0.25	0.25	0.25	0.30	0.30
P2.1.4 Low-alloy steel, heat-treated, Rm 1190 N/mm ² , 350 HB	7	0.15	0.15	0.20	0.25	0.25	0.25	0.30	0.30
P3.1.1 High-alloy steel and tool steel, annealed, Rm 680 N/mm ² , 200 HB	8	0.15	0.15	0.20	0.25	0.25	0.25	0.30	0.30
P3.1.2 High-alloy steel and tool steel, hardened and tempered, Rm 1100 N/mm ² , 325 HB	5	0.15	0.15	0.20	0.25	0.25	0.25	0.30	0.30
M1.1.1 Stainless steel, ferritic/martensitic, with machining additives	6	0.15	0.15	0.20	0.25	0.25	0.25	0.30	0.30
M1.1.2 Stainless steel, ferritic/martensitic, annealed, Rm 680 N/mm ² , 200 HB	5	0.15	0.15	0.20	0.25	0.25	0.25	0.30	0.30
M1.1.3 Stainless steel, ferritic/martensitic, heat-treated, Rm 810 N/mm ² , 240 HB	5	0.15	0.15	0.20	0.25	0.25	0.25	0.30	0.30
M2.1.1 Stainless steel, austenitic, quenched, 180 HB	4	0.15	0.15	0.20	0.25	0.25	0.25	0.30	0.30
M2.2.1 Duplex steel, high-strength stainless steels	3	0.15	0.15	0.20	0.25	0.25	0.25	0.30	0.30
K1.1.1 Grey cast iron, pearlitic/ferritic, 180 HB	14	0.15	0.15	0.20	0.25	0.25	0.25	0.30	0.30
K1.1.2 Grey cast iron, pearlitic/martensitic, 260 HB	13	0.15	0.15	0.20	0.25	0.25	0.25	0.30	0.30
K1.2.1 Cast iron with spheroidal graphite, ferritic, 160 HB	17	0.15	0.15	0.20	0.25	0.25	0.25	0.30	0.30
K1.2.2 Cast iron with spheroidal graphite, pearlitic, 250 HB	17	0.15	0.15	0.20	0.25	0.25	0.25	0.30	0.30
K1.3.1 Malleable cast iron, ferritic, 130 HB	14	0.15	0.15	0.20	0.25	0.25	0.25	0.30	0.30
K1.3.2 Malleable cast iron, pearlitic, 230 HB	13	0.15	0.15	0.20	0.25	0.25	0.25	0.30	0.30
K2.1.1 Vermicular graphite cast iron (GJV)									
K2.2.1 Austenitic-ferritic spheroidal graphite cast iron (ADI)									
N1.1.1 Wrought aluminium alloys, non-hardened, 60 HB	18	0.20	0.25	0.30	0.40	0.40	0.45	0.45	0.50
N1.1.2 Wrought aluminium alloys, hardened, 100 HB	18	0.20	0.25	0.30	0.40	0.40	0.45	0.45	0.50
N2.1.1 Aluminium casting alloys, non-hardened, ≤ 12 % Si, 75 HB	22	0.20	0.25	0.30	0.40	0.40	0.45	0.45	0.50
N2.1.2 Aluminium casting alloys, hardened, ≤ 12 % Si, 90 HB	17	0.20	0.25	0.30	0.40	0.40	0.45	0.45	0.50
N2.1.3 Aluminium casting alloys, non-hardened, > 12 % Si, 130 HB	17	0.20	0.25	0.30	0.40	0.40	0.45	0.45	0.50
N3.1.1 Copper and copper alloys: Free-machining alloy, Pb > 1 %	16	0.20	0.25	0.30	0.40	0.40	0.45	0.45	0.50
N3.1.2 Copper and copper alloys: CuZn, CuSnZn	16	0.20	0.25	0.30	0.40	0.40	0.45	0.45	0.50
N3.1.3 Copper and copper alloys: CuSn, lead-free copper and copper electrolyte	16	0.20	0.25	0.30	0.40	0.40	0.45	0.45	0.50
N4.1.1 Non-metallic materials: Duroplastics, fibre-reinforced plastics	12	0.20	0.25	0.30	0.40	0.40	0.45	0.45	0.50
N4.1.2 Non-metallic materials: Hard rubber, wood, etc.	12	0.20	0.25	0.30	0.40	0.40	0.45	0.45	0.50
N4.1.3 Non-metallic materials: Graphite	7	0.20	0.25	0.30	0.40	0.40	0.45	0.45	0.50
S1.1.1 Heat-resistant alloys, Fe-based, annealed, 200 HB	5	0.15	0.15	0.20	0.25	0.25	0.25	0.30	0.30
S1.1.2 Heat-resistant alloys, Fe-based, hardened, 280 HB	5	0.15	0.15	0.20	0.25	0.25	0.25	0.30	0.30
S1.1.3 Heat-resistant alloys, Ni- or Co-based, annealed, 250 HB	5	0.15	0.15	0.20	0.25	0.25	0.25	0.30	0.30
S1.1.4 Heat-resistant alloys, Ni- or Co-based, hardened, 350 HB	5	0.15	0.15	0.20	0.25	0.25	0.25	0.30	0.30
S1.1.5 Heat-resistant alloys, Ni- or Co-based, cast, 320 HB	5	0.15	0.15	0.20	0.25	0.25	0.25	0.30	0.30
S2.1.1 Titanium alloys, pure titanium, Rm 400 N/mm ²	4	0.15	0.15	0.20	0.25	0.25	0.25	0.30	0.30
S2.1.2 Titanium alloys, Alpha and Beta alloys, hardened, Rm 1050 N/mm ²	4	0.15	0.15	0.20	0.25	0.25	0.25	0.30	0.30
H1.1.1 Hardened steel, hardened and tempered, < 55 HRC									
H1.1.2 Hardened steel, hardened and tempered, < 60 HRC									
H1.1.3 Hardened steel, hardened and tempered, > 60 HRC									
H2.1.1 Chilled cast iron, 400 HB									
H2.1.2 Chilled cast iron, hardened and tempered, < 55 HRC									



Shell reamers



Machining group	V _c (m/min)	f (mm/rev) with nom. Ø								
		25	30	35	40	45	50	55	60	75
P1.1.1 Unalloyed steel, annealed, 0.15 % C, Rm 420 N/mm ² , 125 HB	16	0.35	0.35	0.40	0.40	0.45	0.45	0.50	0.50	0.55
P1.1.2 Unalloyed steel, heat-treated, 0.15 % C, Rm 420 N/mm ² , 125 HB	16	0.35	0.35	0.40	0.40	0.45	0.45	0.50	0.50	0.55
P1.1.3 Unalloyed steel, annealed, 0.45 % C, Rm 640 N/mm ² , 190 HB	16	0.35	0.35	0.40	0.40	0.45	0.45	0.50	0.50	0.55
P1.1.4 Unalloyed steel, heat-treated, 0.45 % C, Rm 640 N/mm ² , 190 HB	16	0.35	0.35	0.40	0.40	0.45	0.45	0.50	0.50	0.55
P1.1.5 Unalloyed steel, heat-treated, 0.45 % C, Rm 850 N/mm ² , 250 HB	14	0.35	0.35	0.40	0.40	0.45	0.45	0.50	0.50	0.55
P1.1.6 Unalloyed steel, annealed, 0.75 % C, Rm 915 N/mm ² , 270 HB	14	0.35	0.35	0.40	0.40	0.45	0.45	0.50	0.50	0.55
P1.1.7 Unalloyed steel, heat-treated, 0.75 % C, Rm 1020 N/mm ² , 300 HB	13	0.35	0.35	0.40	0.40	0.45	0.45	0.50	0.50	0.55
P2.1.1 Low-alloy steel, annealed, Rm 610 N/mm ² , 180 HB	10	0.35	0.35	0.40	0.40	0.45	0.45	0.50	0.50	0.55
P2.1.2 Low-alloy steel, heat-treated, Rm 930 N/mm ² , 275 HB	10	0.35	0.35	0.40	0.40	0.45	0.45	0.50	0.50	0.55
P2.1.3 Low-alloy steel, heat-treated, Rm 1020 N/mm ² , 300 HB	10	0.35	0.35	0.40	0.40	0.45	0.45	0.50	0.50	0.55
P2.1.4 Low-alloy steel, heat-treated, Rm 1190 N/mm ² , 350 HB	7	0.35	0.35	0.40	0.40	0.45	0.45	0.50	0.50	0.55
P3.1.1 High-alloy steel and tool steel, annealed, Rm 680 N/mm ² , 200 HB	8	0.35	0.35	0.40	0.40	0.45	0.45	0.50	0.50	0.55
P3.1.2 High-alloy steel and tool steel, hardened and tempered, Rm 1100 N/mm ² , 325 HB	5	0.35	0.35	0.40	0.40	0.45	0.45	0.50	0.50	0.55
M1.1.1 Stainless steel, ferritic/martensitic, with machining additives	6	0.35	0.35	0.40	0.40	0.45	0.45	0.50	0.50	0.55
M1.1.2 Stainless steel, ferritic/martensitic, annealed, Rm 680 N/mm ² , 200 HB	5	0.35	0.35	0.40	0.40	0.45	0.45	0.50	0.50	0.55
M1.1.3 Stainless steel, ferritic/martensitic, heat-treated, Rm 810 N/mm ² , 240 HB	5	0.35	0.35	0.40	0.40	0.45	0.45	0.50	0.50	0.55
M2.1.1 Stainless steel, austenitic, quenched, 180 HB	4	0.35	0.35	0.40	0.40	0.45	0.45	0.50	0.50	0.55
M2.2.1 Duplex steel, high-strength stainless steels	3	0.35	0.35	0.40	0.40	0.45	0.45	0.50	0.50	0.55
K1.1.1 Grey cast iron, pearlitic/ferritic, 180 HB	14	0.35	0.35	0.40	0.40	0.45	0.45	0.50	0.50	0.55
K1.1.2 Grey cast iron, pearlitic/martensitic, 260 HB	13	0.35	0.35	0.40	0.40	0.45	0.45	0.50	0.50	0.55
K1.2.1 Cast iron with spheroidal graphite, ferritic, 160 HB	17	0.35	0.35	0.40	0.40	0.45	0.45	0.50	0.50	0.55
K1.2.2 Cast iron with spheroidal graphite, pearlitic, 250 HB	17	0.35	0.35	0.40	0.40	0.45	0.45	0.50	0.50	0.55
K1.3.1 Malleable cast iron, ferritic, 130 HB	14	0.35	0.35	0.40	0.40	0.45	0.45	0.50	0.50	0.55
K1.3.2 Malleable cast iron, pearlitic, 230 HB	13	0.35	0.35	0.40	0.40	0.45	0.45	0.50	0.50	0.55
K2.1.1 Vermicular graphite cast iron (GJV)	8	0.35	0.35	0.40	0.40	0.45	0.45	0.50	0.50	0.55
K2.2.1 Austenitic-ferritic spheroidal graphite cast iron (ADI)	6	0.35	0.35	0.40	0.40	0.45	0.45	0.50	0.50	0.55
N1.1.1 Wrought aluminium alloys, non-hardened, 60 HB	18	0.45	0.45	0.50	0.50	0.55	0.55	0.60	0.60	0.70
N1.1.2 Wrought aluminium alloys, hardened, 100 HB	18	0.45	0.45	0.50	0.50	0.55	0.55	0.60	0.60	0.70
N2.1.1 Aluminium casting alloys, non-hardened, ≤ 12 % Si, 75 HB	20	0.45	0.45	0.50	0.50	0.55	0.55	0.60	0.60	0.70
N2.1.2 Aluminium casting alloys, hardened, ≤ 12 % Si, 90 HB	15	0.45	0.45	0.50	0.50	0.55	0.55	0.60	0.60	0.70
N2.1.3 Aluminium casting alloys, non-hardened, > 12 % Si, 130 HB	15	0.45	0.45	0.50	0.50	0.55	0.55	0.60	0.60	0.70
N3.1.1 Copper and copper alloys: Free-machining alloy, Pb > 1 %	18	0.45	0.45	0.50	0.50	0.55	0.55	0.60	0.60	0.70
N3.1.2 Copper and copper alloys: CuZn, CuSnZn	18	0.45	0.45	0.50	0.50	0.55	0.55	0.60	0.60	0.70
N3.1.3 Copper and copper alloys: CuSn, lead-free copper and copper electrolyte	18	0.45	0.45	0.50	0.50	0.55	0.55	0.60	0.60	0.70
N4.1.1 Non-metallic materials: Duroplastics, fibre-reinforced plastics	12	0.45	0.45	0.50	0.50	0.55	0.55	0.60	0.60	0.70
N4.1.2 Non-metallic materials: Hard rubber, wood, etc.	12	0.45	0.45	0.50	0.50	0.55	0.55	0.60	0.60	0.70
N4.1.3 Non-metallic materials: Graphite	7	0.45	0.45	0.50	0.50	0.55	0.55	0.60	0.60	0.70
S1.1.1 Heat-resistant alloys, Fe-based, annealed, 200 HB	4	0.35	0.35	0.40	0.40	0.45	0.45	0.50	0.50	0.55
S1.1.2 Heat-resistant alloys, Fe-based, hardened, 280 HB	4	0.35	0.35	0.40	0.40	0.45	0.45	0.50	0.50	0.55
S1.1.3 Heat-resistant alloys, Ni- or Co-based, annealed, 250 HB	4	0.35	0.35	0.40	0.40	0.45	0.45	0.50	0.50	0.55
S1.1.4 Heat-resistant alloys, Ni- or Co-based, hardened, 350 HB	4	0.35	0.35	0.40	0.40	0.45	0.45	0.50	0.50	0.55
S1.1.5 Heat-resistant alloys, Ni- or Co-based, cast, 320 HB	4	0.35	0.35	0.40	0.40	0.45	0.45	0.50	0.50	0.55
S2.1.1 Titanium alloys, pure titanium, Rm 400 N/mm ²	4	0.35	0.35	0.40	0.40	0.45	0.45	0.50	0.50	0.55
S2.1.2 Titanium alloys, Alpha and Beta alloys, hardened, Rm 1050 N/mm ²	4	0.35	0.35	0.40	0.40	0.45	0.45	0.50	0.50	0.55
H1.1.1 Hardened steel, hardened and tempered, < 55 HRC										
H1.1.2 Hardened steel, hardened and tempered, < 60 HRC										
H1.1.3 Hardened steel, hardened and tempered, > 60 HRC										
H2.1.1 Chilled cast iron, 400 HB										
H2.1.2 Chilled cast iron, hardened and tempered, < 55 HRC										



Machine taper reamers



Cutting data

Machining group	V _c (m/min)	f (mm/rev) with nom. Ø											
		1	3	5	8	10	12	14	16	20	30	40	50
P1.1.1 Unalloyed steel, annealed, 0.15 % C, Rm 420 N/mm ² , 125 HB	8	0.02	0.05	0.15	0.20	0.25	0.25	0.25	0.30	0.30	0.35	0.40	0.45
P1.1.2 Unalloyed steel, heat-treated, 0.15 % C, Rm 420 N/mm ² , 125 HB	8	0.02	0.05	0.15	0.20	0.25	0.25	0.25	0.30	0.30	0.35	0.40	0.45
P1.1.3 Unalloyed steel, annealed, 0.45 % C, Rm 640 N/mm ² , 190 HB	8	0.02	0.05	0.15	0.20	0.25	0.25	0.25	0.30	0.30	0.35	0.40	0.45
P1.1.4 Unalloyed steel, heat-treated, 0.45 % C, Rm 640 N/mm ² , 190 HB	8	0.02	0.05	0.15	0.20	0.25	0.25	0.25	0.30	0.30	0.35	0.40	0.45
P1.1.5 Unalloyed steel, heat-treated, 0.45 % C, Rm 850 N/mm ² , 250 HB	7	0.02	0.05	0.15	0.20	0.25	0.25	0.25	0.30	0.30	0.35	0.40	0.45
P1.1.6 Unalloyed steel, annealed, 0.75 % C, Rm 915 N/mm ² , 270 HB	7	0.02	0.05	0.15	0.20	0.25	0.25	0.25	0.30	0.30	0.35	0.40	0.45
P1.1.7 Unalloyed steel, heat-treated, 0.75 % C, Rm 1020 N/mm ² , 300 HB	6	0.02	0.05	0.15	0.20	0.25	0.25	0.25	0.30	0.30	0.35	0.40	0.45
P2.1.1 Low-alloy steel, annealed, Rm 610 N/mm ² , 180 HB	8	0.02	0.05	0.15	0.20	0.25	0.25	0.25	0.30	0.30	0.35	0.40	0.45
P2.1.2 Low-alloy steel, heat-treated, Rm 930 N/mm ² , 275 HB	8	0.02	0.05	0.15	0.20	0.25	0.25	0.25	0.30	0.30	0.35	0.40	0.45
P2.1.3 Low-alloy steel, heat-treated, Rm 1020 N/mm ² , 300 HB	8	0.02	0.05	0.15	0.20	0.25	0.25	0.25	0.30	0.30	0.35	0.40	0.45
P2.1.4 Low-alloy steel, heat-treated, Rm 1190 N/mm ² , 350 HB	5	0.02	0.05	0.15	0.20	0.25	0.25	0.25	0.30	0.30	0.35	0.40	0.45
P3.1.1 High-alloy steel and tool steel, annealed, Rm 680 N/mm ² , 200 HB	6	0.02	0.05	0.15	0.20	0.25	0.25	0.25	0.30	0.30	0.35	0.40	0.45
P3.1.2 High-alloy steel and tool steel, hardened and tempered, Rm 1100 N/mm ² , 325 HB	4	0.02	0.05	0.15	0.20	0.25	0.25	0.25	0.30	0.30	0.35	0.40	0.45
M1.1.1 Stainless steel, ferritic/martensitic, with machining additives	6	0.02	0.05	0.15	0.20	0.25	0.25	0.25	0.30	0.30	0.35	0.40	0.45
M1.1.2 Stainless steel, ferritic/martensitic, annealed, Rm 680 N/mm ² , 200 HB	5	0.02	0.05	0.15	0.20	0.25	0.25	0.25	0.30	0.30	0.35	0.40	0.45
M1.1.3 Stainless steel, ferritic/martensitic, heat-treated, Rm 810 N/mm ² , 240 HB	5	0.02	0.05	0.15	0.20	0.25	0.25	0.25	0.30	0.30	0.35	0.40	0.45
M2.1.1 Stainless steel, austenitic, quenched, 180 HB	6	0.02	0.05	0.15	0.20	0.25	0.25	0.25	0.30	0.30	0.35	0.40	0.45
M2.2.1 Duplex steel, high-strength stainless steels	4	0.02	0.05	0.15	0.20	0.25	0.25	0.25	0.30	0.30	0.35	0.40	0.45
K1.1.1 Grey cast iron, pearlitic/ferritic, 180 HB	8	0.02	0.05	0.15	0.20	0.25	0.25	0.25	0.30	0.30	0.35	0.40	0.45
K1.1.2 Grey cast iron, pearlitic/martensitic, 260 HB	7	0.02	0.05	0.15	0.20	0.25	0.25	0.25	0.30	0.30	0.35	0.40	0.45
K1.2.1 Cast iron with spheroidal graphite, ferritic, 160 HB	10	0.02	0.05	0.15	0.20	0.25	0.25	0.25	0.30	0.30	0.35	0.40	0.45
K1.2.2 Cast iron with spheroidal graphite, pearlitic, 250 HB	10	0.02	0.05	0.15	0.20	0.25	0.25	0.25	0.30	0.30	0.35	0.40	0.45
K1.3.1 Malleable cast iron, ferritic, 130 HB	8	0.02	0.05	0.15	0.20	0.25	0.25	0.25	0.30	0.30	0.35	0.40	0.45
K1.3.2 Malleable cast iron, pearlitic, 230 HB	7	0.02	0.05	0.15	0.20	0.25	0.25	0.25	0.30	0.30	0.35	0.40	0.45
K2.1.1 Vermicular graphite cast iron (GJV)	6	0.02	0.05	0.15	0.20	0.25	0.25	0.25	0.30	0.30	0.35	0.40	0.45
K2.2.1 Austenitic-ferritic spheroidal graphite cast iron (ADI)	5	0.02	0.05	0.15	0.20	0.25	0.25	0.25	0.30	0.30	0.35	0.40	0.45
N1.1.1 Wrought aluminium alloys, non-hardened, 60 HB	8	0.03	0.10	0.20	0.30	0.40	0.40	0.45	0.45	0.50	0.60	0.65	0.75
N1.1.2 Wrought aluminium alloys, hardened, 100 HB	8	0.03	0.10	0.20	0.30	0.40	0.40	0.45	0.45	0.50	0.60	0.65	0.75
N2.1.1 Aluminium casting alloys, non-hardened, ≤ 12 % Si, 75 HB	8	0.03	0.10	0.20	0.30	0.40	0.40	0.45	0.45	0.50	0.60	0.65	0.75
N2.1.2 Aluminium casting alloys, hardened, ≤ 12 % Si, 90 HB	6	0.03	0.10	0.20	0.30	0.40	0.40	0.45	0.45	0.50	0.60	0.65	0.75
N2.1.3 Aluminium casting alloys, non-hardened, > 12 % Si, 130 HB	6	0.03	0.10	0.20	0.30	0.40	0.40	0.45	0.45	0.50	0.60	0.65	0.75
N3.1.1 Copper and copper alloys: Free-machining alloy, Pb > 1 %	8	0.02	0.10	0.15	0.25	0.30	0.30	0.35	0.35	0.40	0.45	0.50	0.55
N3.1.2 Copper and copper alloys: CuZn, CuSnZn	8	0.02	0.10	0.15	0.25	0.30	0.30	0.35	0.35	0.40	0.45	0.50	0.55
N3.1.3 Copper and copper alloys: CuSn, lead-free copper and copper electrolyte	8	0.02	0.10	0.15	0.25	0.30	0.30	0.35	0.35	0.40	0.45	0.50	0.55
N4.1.1 Non-metallic materials: Duroplastics, fibre-reinforced plastics	8	0.02	0.10	0.15	0.25	0.30	0.30	0.35	0.35	0.40	0.45	0.50	0.55
N4.1.2 Non-metallic materials: Hard rubber, wood, etc.	8	0.02	0.10	0.15	0.25	0.30	0.30	0.35	0.35	0.40	0.45	0.50	0.55
N4.1.3 Non-metallic materials: Graphite	5	0.02	0.10	0.15	0.25	0.30	0.30	0.35	0.35	0.40	0.45	0.50	0.55
S1.1.1 Heat-resistant alloys, Fe-based, annealed, 200 HB	6	0.02	0.05	0.15	0.20	0.25	0.25	0.25	0.30	0.30	0.35	0.40	0.45
S1.1.2 Heat-resistant alloys, Fe-based, hardened, 280 HB	6	0.02	0.05	0.15	0.20	0.25	0.25	0.25	0.30	0.30	0.35	0.40	0.45
S1.1.3 Heat-resistant alloys, Ni- or Co-based, annealed, 250 HB	6	0.02	0.05	0.15	0.20	0.25	0.25	0.25	0.30	0.30	0.35	0.40	0.45
S1.1.4 Heat-resistant alloys, Ni- or Co-based, hardened, 350 HB	6	0.02	0.05	0.15	0.20	0.25	0.25	0.25	0.30	0.30	0.35	0.40	0.45
S1.1.5 Heat-resistant alloys, Ni- or Co-based, cast, 320 HB	6	0.02	0.05	0.15	0.20	0.25	0.25	0.25	0.30	0.30	0.35	0.40	0.45
S2.1.1 Titanium alloys, pure titanium, Rm 400 N/mm ²													
S2.1.2 Titanium alloys, Alpha and Beta alloys, hardened, Rm 1050 N/mm ²													
H1.1.1 Hardened steel, hardened and tempered, < 55 HRC													
H1.1.2 Hardened steel, hardened and tempered, < 60 HRC													
H1.1.3 Hardened steel, hardened and tempered, > 60 HRC													
H2.1.1 Chilled cast iron, 400 HB													
H2.1.2 Chilled cast iron, hardened and tempered, < 55 HRC													

Digital Services

made by **GÜHRING**



scan me



Our services make your job easier:
Innovative software solutions automate your procurement processes,
avoid system failures and discover potential savings in your production.
This reduces your process costs and saves you time and money in your daily work.
In addition, we provide you with all the data and information you need for your machining
and share our expertise with you in the form of training sessions.
And if you need assistance, we offer immediate help on different digital channels.

For more information about our services and availability in your country, please contact us.





Countersinking and deburring tools

Burr-free and happy

Quick, clean and fully automated:
This saves you precious
machining time

GÜHRING

Page

1064	Countersinks
1082	Counterbores
1089	Deburring tools



P	M	K	N	S	H	Tool illustration	Shank form	Standard	Form	Cutting direction	Tool material	Surface	d1/mm	Article no.	Page
90° Countersinks SpyroTec															
●	●	●	○	●			Cyl	DIN 335	C	R	HSCO	A	6.300 - 40.000	5500	1064
●	●	●	○	●			3	DIN 335	C	R	HSCO	A	6.300 - 40.000	5501	1064
●	○	○	○	○			Cyl	WN	C	R	HSS	A	6.300 - 31.000	5503	1065
90° Countersink sets SpyroTec															
●	●	●	○	●			Cyl	DIN 335	C	R	HSCO	A		5538	1066
●	●	●	○	●			3	DIN 335	C	R	HSCO	A		5539	1066
90° Countersinks															
●	○	●	○	○			Cyl	DIN 335	C	R	HSS	○	4.300 - 31.000	476	1067
●	○	●	○	○			Cyl	DIN 335	C	R	HSS	S	5.000 - 31.000	327	1068
●	○	●	○	○			Cyl	DIN 335	C	R	HSS	A	4.300 - 31.000	1326	1068
●	○	●	○	○			Cyl	DIN 335	A	R	HSS	○ ^{>0} _{8,00}	8.000 - 20.000	474	1069
●	○	●	○	○			MK	DIN 335	D	R	HSS	○	15.000 - 100.000	477	1070
●	○	●	○	○			MK	DIN 335	D	R	HSS	S	25.000 - 50.000	328	1070
●	○	●	○	○			MK	DIN 335	B	R	HSS	○	16.000 - 100.000	475	1069
90° Countersink sets															
●	○	●	○	○			Cyl	DIN 335	C	R	HSS	○		498	1071
●	○	●	○	○			Cyl	DIN 335	C	R	HSS	S		499	1071
90° Countersinks for fine tolerances															
●	○	●	○	○			Cyl	DIN 1866		R	HSS	○	2.000 - 19.000	436	1072
90° Countersinks for medium tolerances															
●	○	●	○	○			Cyl	DIN 1866		R	HSS	○	6.600 - 21.500	437	1072
90° Countersinks for tapping size holes															
●	○	●	○	○			Cyl	DIN 1866		R	HSS	○	6.000 - 19.000	438	1073

Countersinking and deburring tools



P	M	K	N	S	H	Tool illustration	Shank form	Standard	Form	Cutting direction	Tool material	Surface	d1/mm	Article no.	Page
60° Countersinks SpyroTec															
•	•	•	○	○			Cyl	DIN 334	C	R	HSS	A	6.300 - 25.000	5670	1074
•	•	•	○	○			3	DIN 334	C	R	HSS	A	6.300 - 25.000	5671	1074
60° Countersink sets SpyroTec															
•	•	•	○	○			Cyl	DIN 334	C	R	HSS	A		5672	1075
•	•	•	○	○			3	DIN 334	C	R	HSS	A		5673	1075
60° Countersinks															
•	○	•	•	○			Cyl	DIN 334	C	R	HSS	○	6.300 - 25.000	472	1076
•	○	•	•	○			Cyl	DIN 334	A	R	HSS	○ ^{>Ø} _{8,00}	8.000 - 20.000	470	1076
•	○	•	•	○			MK	DIN 334	D	R	HSS	○	16.000 - 80.000	473	1077
•	○	•	•	○			MK	DIN 334	B	R	HSS	○	16.000 - 100.000	471	1077
82° Countersinks SpyroTec															
•	•	•	○	•			Cyl	WN	C	R	HSCO	A	6.350 - 31.750	5674	1078
•	•	•	○	•			3	WN	C	R	HSCO	A	6.350 - 31.750	5675	1078
82° Countersink sets SpyroTec															
•	•	•	○	•			Cyl	WN	C	R	HSCO	A		5676	1079
•	•	•	○	•			3	WN	C	R	HSCO	A		5677	1079
120° Countersinks															
•	○	•	•	•			Cyl	WN	C	R	HSS	○	16.000 - 16.000	480	1080
•	○	•	•	○			Cyl	DIN 347	A	R	HSS	○ ^{>Ø} _{8,00}	8.000 - 20.000	478	1080
•	○	•	•	○			MK	WN	D	R	HSS	○	25.000 - 40.000	481	1081

Countersinking and deburring tools



P	M	K	N	S	H	Tool illustration	Shank form	Standard	Form	Cutting direction	Tool material	Surface	d1/mm	Article no.	Page
Counterbores with fixed pilots for fine tolerances															
●	○	●	●	○			Cyl	DIN 373		R	HSS	○	2.500 - 20.000	482	1082
●	○	●	○	○			Cyl	DIN 373		R	HSS	Ⓢ	6.000 - 20.000	324	1082
●	○	●	●	○			MK	WN		R	HSS	●	20.000 - 40.000	485	1083
Counterbores with fixed pilots for medium tolerances															
●	○	●	●	○			Cyl	DIN 373		R	HSS	○	6.000 - 20.000	483	1084
●	○	●	○	○			Cyl	DIN 373		R	HSS	Ⓢ	6.000 - 18.000	325	1084
●	○	●	●	○			MK	WN		R	HSS	●	18.000 - 40.000	486	1085
Counterbores with fixed pilots for tapping size holes															
●	○	●	●	○			Cyl	DIN 373		R	HSS	○	6.000 - 20.000	484	1086
Counterbores with hole for detachable pilot															
●	○	●	●	○			MK	DIN 375		R	HSS	●	15.000 - 40.000	463	1087
Detach. pilot for fine tolerances															
							Cyl	DIN 1868			HSS	○	8.400 - 25.000	464	1087
Detach. pilot for medial tolerances															
							Cyl	DIN 1868			HSS	○	9.000 - 26.000	465	1088
Counterbores with fixed pilots for tapping size holes															
							Cyl	DIN 1868			HSS	○	6.800 - 21.000	466	1088



P	M	K	N	S	H	Tool illustration	Shank form	Standard	Form	Cutting direction	Tool material	Surface	d1/mm	Article no.	Page
Deburring forks															
•	•	•	○	○	○		HA	WN		R	VHM	○	2.000 - 8.000	4101	1089
•	•	•	○	○	○		Cyl	WN		R	VHM	○	2.000 - 8.000	4100	1089
Deburring reamers															
•	•	•	○	•	○		HA	WN		R	VHM	ⓐ	2.970 - 11.970	4103	1090



90° Countersinks SpyroTec

Article no. **5500**



Cutting data page 1092



P	M	K	N	S	H
•	•	•	○	•	•

3 different convex cutting edges • low-vibration cutting • for round and chatter-free countersinking • considerably lower feed force required • for universal application

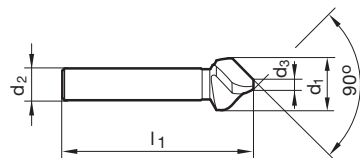

Article no. **5500**

d1 mm	d2 mm	d3 mm	l1 mm	Z	Order no.
6.30	5.00	1.5	45.0	3	5500 6.300
8.00	6.00	2.0	50.0	3	5500 8.000
8.30	6.00	2.0	50.0	3	5500 8.300
10.00	6.00	2.5	50.0	3	5500 10.000
10.40	6.00	2.5	50.0	3	5500 10.400
11.50	8.00	2.8	56.0	3	5500 11.500
12.40	8.00	2.8	56.0	3	5500 12.400
15.00	10.00	3.2	60.0	3	5500 15.000
16.50	10.00	3.2	60.0	3	5500 16.500
19.00	10.00	3.5	63.0	3	5500 19.000
20.50	10.00	3.5	63.0	3	5500 20.500
23.00	10.00	3.8	67.0	3	5500 23.000
25.00	10.00	3.8	67.0	3	5500 25.000
31.00	12.00	4.2	71.0	3	5500 31.000
40.00	12.00	10.0	75.0	3	5500 40.000

90° Countersinks SpyroTec

Article no. **5501**



Cutting data page 1092



P	M	K	N	S	H
•	•	•	○	•	•

3 different convex cutting edges • 3-flats on shank prevent slipping in the chuck • perfect for hand drills • low-vibration cutting • for round and chatter-free countersinking • considerably lower feed force required • for universal application

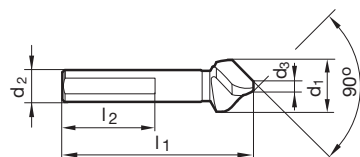

Article no. **5501**

d1 mm	d2 mm	d3 mm	l1 mm	l2 mm	Z	Order no.
6.30	5.00	1.50	45.0	30.0	3	5501 6.300
8.00	6.00	2.00	50.0	30.0	3	5501 8.000
8.30	6.00	2.00	50.0	30.0	3	5501 8.300
10.00	6.00	2.50	50.0	30.0	3	5501 10.000
10.40	6.00	2.50	50.0	30.0	3	5501 10.400
11.50	8.00	2.80	56.0	30.0	3	5501 11.500
12.40	8.00	2.80	56.0	30.0	3	5501 12.400
15.00	10.00	3.20	60.0	30.0	3	5501 15.000
16.50	10.00	3.20	60.0	30.0	3	5501 16.500
19.00	10.00	3.50	63.0	30.0	3	5501 19.000
20.50	10.00	3.50	63.0	30.0	3	5501 20.500
23.00	10.00	3.80	67.0	30.0	3	5501 23.000
25.00	10.00	3.80	67.0	30.0	3	5501 25.000
31.00	12.00	4.20	71.0	30.0	3	5501 31.000
40.00	12.00	10.00	75.0	30.0	3	5501 40.000



90° Countersinks SpyroTec

Article no. 5503



Cutting data page 1092



P	M	K	N	S	H
●	○	●	○	○	○

long version for recessed machining points • 3 different convex cutting edges • low-vibration cutting • for round and chatter-free countersinking • considerably lower feed force required • for universal application

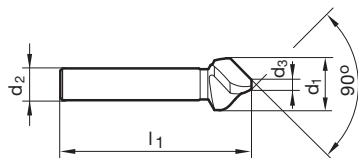

Article no.

5503

d1 mm	d2 mm	d3 mm	l1 mm	Z	Order no.
6.30	5.00	1.5	104.0	3	5503 6.300
8.30	6.00	2.0	105.0	3	5503 8.300
10.40	6.00	2.5	107.0	3	5503 10.400
12.40	8.00	2.8	108.0	3	5503 12.400
16.50	10.00	3.2	111.0	3	5503 16.500
20.50	10.00	3.5	114.0	3	5503 20.500
25.00	10.00	3.8	118.0	3	5503 25.000
31.00	12.00	4.2	140.0	3	5503 31.000



90° Countersink sets SpyroTec

Article no. **5538**



Cutting data page 1092



consisting of art. no. 5500 • 3 different convex cutting edges • low-vibration cutting • for round and chatter-free countersinking • considerably lower feed force required • for universal application

Article no. **5538**

Ø-range mm	Pieces/set	Order no.
6.3/8.3/10.4/12.4/16.5/20.5	6	5538 1.000
6.3/10.4/16.5/20.5/25.0	5	5538 2.000

90° Countersink sets SpyroTec

Article no. **5539**

Countersinking tools



Cutting data page 1092



consisting of art. no. 5501 • 3 different convex cutting edges • 3-flats on shank prevent slipping in the chuck • perfect for hand drills • low-vibration cutting • for round and chatter-free countersinking • considerably lower feed force required • for universal application

Article no. **5539**

Ø-range mm	Pieces/set	Order no.
6.3/8.3/10.4/12.4/16.5/20.5	6	5539 1.000
6.3/10.4/16.5/20.5/25.0	5	5539 2.000



90° Countersinks

Article no. 476



Cutting data page 1093



radial relieved • 3-fluted

P	M	K	N	S	H
•	○	•	•	○	

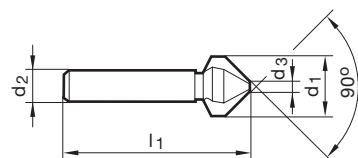

Article no.

476

d1 mm	d2 mm	d3 mm	l1 mm	Z	Order no.
4.30	4.00	1.3	40.0	3	476 4.300
5.00	4.00	1.5	40.0	3	476 5.000
5.30	4.00	1.5	40.0	3	476 5.300
5.80	5.00	1.5	45.0	3	476 5.800
6.00	5.00	1.5	45.0	3	476 6.000
6.30	5.00	1.5	45.0	3	476 6.300
7.00	6.00	1.8	50.0	3	476 7.000
7.30	6.00	1.8	50.0	3	476 7.300
8.00	6.00	2.0	50.0	3	476 8.000
8.30	6.00	2.0	50.0	3	476 8.300
9.40	6.00	2.2	50.0	3	476 9.400
10.00	6.00	2.5	50.0	3	476 10.000
10.40	6.00	2.5	50.0	3	476 10.400
11.50	8.00	2.8	56.0	3	476 11.500
12.40	8.00	2.8	56.0	3	476 12.400
13.40	8.00	2.9	56.0	3	476 13.400
15.00	10.00	3.2	60.0	3	476 15.000
16.50	10.00	3.2	60.0	3	476 16.500
19.00	10.00	3.5	63.0	3	476 19.000
20.50	10.00	3.5	63.0	3	476 20.500
23.00	10.00	3.8	67.0	3	476 23.000
25.00	10.00	3.8	67.0	3	476 25.000
26.00	10.00	3.8	67.0	3	476 26.000
28.00	12.00	4.0	71.0	3	476 28.000
30.00	12.00	4.2	71.0	3	476 30.000
31.00	12.00	4.2	71.0	3	476 31.000



90° Countersinks

Article no. **327**



Cutting data page 1093



radial relieved • 3-fluted

P	M	K	N	S	H
●	○	●	○	○	

90° Countersinks

Article no. **1326**



Cutting data page 1093



radial relieved • 3-fluted

P	M	K	N	S	H
●	○	●	○	○	

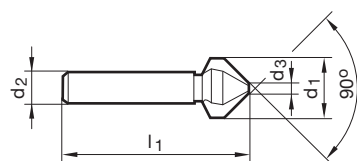

Article no.

327

1326

d1 mm	d2 mm	d3 mm	l1 mm	Z	Order no.	
					327	1326
4.30	4.00	1.3	40.0	3		1326 4.300
5.00	4.00	1.5	40.0	3	327 5.000	1326 5.000
5.30	4.00	1.5	40.0	3		1326 5.300
5.80	5.00	1.5	45.0	3		1326 5.800
6.00	5.00	1.5	45.0	3		1326 6.000
6.30	5.00	1.5	45.0	3	327 6.300	1326 6.300
7.00	6.00	1.8	50.0	3		1326 7.000
7.30	6.00	1.8	50.0	3		1326 7.300
8.00	6.00	2.0	50.0	3	327 8.000	1326 8.000
8.30	6.00	2.0	50.0	3	327 8.300	1326 8.300
9.40	6.00	2.2	50.0	3	327 9.400	1326 9.400
10.00	6.00	2.5	50.0	3	327 10.000	1326 10.000
10.40	6.00	2.5	50.0	3	327 10.400	1326 10.400
11.50	8.00	2.8	56.0	3	327 11.500	1326 11.500
12.40	8.00	2.8	56.0	3	327 12.400	1326 12.400
13.40	8.00	2.9	56.0	3	327 13.400	1326 13.400
15.00	10.00	3.2	60.0	3	327 15.000	1326 15.000
16.50	10.00	3.2	60.0	3	327 16.500	1326 16.500
19.00	10.00	3.5	63.0	3		1326 19.000
20.50	10.00	3.5	63.0	3	327 20.500	1326 20.500
23.00	10.00	3.8	67.0	3		1326 23.000
25.00	10.00	3.8	67.0	3	327 25.000	1326 25.000
26.00	10.00	3.8	67.0	3		1326 26.000
28.00	12.00	4.0	71.0	3		1326 28.000
30.00	12.00	4.2	71.0	3	327 30.000	1326 30.000
31.00	12.00	4.2	71.0	3	327 31.000	1326 31.000

Countersinking tools



90° Countersinks

Article no. 474



Cutting data page 1093

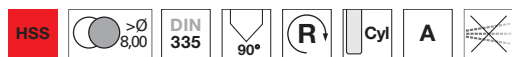

straight-fluted • with relief-ground • multi-fluted

P	M	K	N	S	H
•	○	•	•	○	

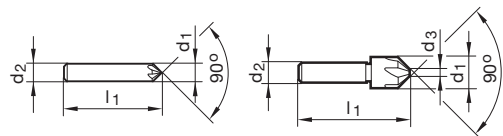

Article no. 474

d1 mm	d2 mm	d3 mm	l1 mm	Z
8.00	8.00		48.0	5
12.50	8.00	2.0	48.0	5
16.00	10.00	3.2	56.0	7
20.00	10.00	5.0	60.0	7

Order no.
474 8.000
474 12.500
474 16.000
474 20.000

90° Countersinks

Article no. 475



Cutting data page 1093



straight-fluted • multi-fluted • with relief-ground • Ø 100.00 mm to company standard

P	M	K	N	S	H
•	○	•	•	○	

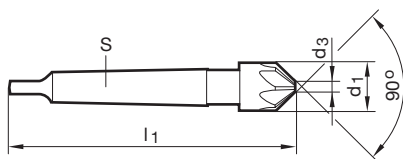

Article no. 475

d1 mm	S	d3 mm	l1 mm	Z
16.00	MK-1	3.2	95.0	7
20.00	MK-2	5.0	106.0	7
25.00	MK-2	7.0	118.0	9
31.50	MK-2	9.0	122.0	9
40.00	MK-3	12.0	150.0	11
50.00	MK-3	16.0	155.0	13
63.00	MK-4	20.0	185.0	15
80.00	MK-4	25.0	196.0	17
100.00	MK-4	31.5	212.0	17

Order no.
475 16.000
475 20.000
475 25.000
475 31.500
475 40.000
475 50.000
475 63.000
475 80.000
475 100.000

Countersinking tools



90° Countersinks

Article no. **477**



Cutting data page 1093



P	M	K	N	S	H
●	○	●	○	○	○

radial relieved • 3-fluted • Ø 100.00 mm to company standard

90° Countersinks

Article no. **328**



Cutting data page 1093

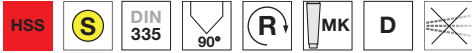

P	M	K	N	S	H
●	○	●	○	○	○

radial relieved • 3-fluted • Ø 100.00 mm to company standard

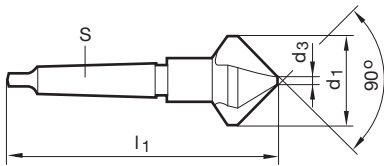

Article no.

477

328

d1 mm	S	d3 mm	l1 mm	Z	Order no.
15.00	MK-1	3.2	85.0	3	477 15.000
16.50	MK-1	3.2	85.0	3	477 16.500
19.00	MK-2	3.5	100.0	3	477 19.000
20.50	MK-2	3.5	100.0	3	477 20.500
23.00	MK-2	3.8	106.0	3	477 23.000
25.00	MK-2	3.8	106.0	3	477 25.000 328 25.000
26.00	MK-2	3.8	106.0	3	477 26.000
28.00	MK-2	4.0	112.0	3	477 28.000
30.00	MK-2	4.2	112.0	3	477 30.000
31.00	MK-2	4.2	112.0	3	477 31.000 328 31.000
34.00	MK-2	4.5	118.0	3	477 34.000
37.00	MK-2	4.8	118.0	3	477 37.000 328 37.000
40.00	MK-3	10.0	140.0	3	477 40.000 328 40.000
50.00	MK-3	14.0	150.0	3	477 50.000 328 50.000
63.00	MK-4	16.0	180.0	3	477 63.000
80.00	MK-4	22.0	190.0	3	477 80.000
100.00	MK-4	28.0	200.0	3	477 100.000



90° Countersink sets

Article no. 498



Cutting data page 1093



radial relieved • 3-fluted

P	M	K	N	S	H
●	○	●	●	○	○

Article no. 498

Ø-range mm	Pieces/set	Order no.
6.3/8.3/10.4/12.4/16.5/20.5	6	498 7.000

90° Countersink sets

Article no. 499



Cutting data page 1093



radial relieved • 3-fluted

P	M	K	N	S	H
●	○	●	○	○	○

Article no. 499

Ø-range mm	Pieces/set	Order no.
6.3/8.3/10.4/12.4/16.5/20.5	6	499 7.000



90° Countersinks for fine tolerances

Article no. **436**



Cutting data page 1093



P	M	K	N	S	H
●	○	●	●	○	○

with fixed pilot • for through-holes • Ø 19.00 mm to company standard

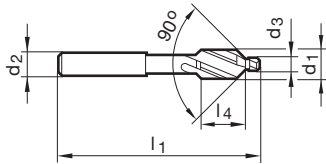

Article no. **436**

d1 mm	d3 mm	d2 mm	l1 mm	l6 mm	G	Z	Order no.
2.00	1.10	2.00	45.0	7.0	M 1	2	436 2.000
2.50	1.30	2.50	45.0	7.0	M 1.2	2	436 2.500
2.80	1.50	2.80	45.0	7.0	M 1.4	2	436 2.800
3.30	1.70	3.30	56.0	10.0	M 1.6	2	436 3.300
3.80	2.00	3.80	56.0	10.0	M 1.8	2	436 3.800
4.30	2.20	4.30	56.0	10.0	M 2	2	436 4.300
5.00	2.70	5.00	56.0	10.0	M 2.5	2	436 5.000
6.00	3.20	5.00	71.0	14.0	M 3	3	436 6.000
8.00	4.30	5.00	71.0	14.0	M 4	3	436 8.000
10.00	5.30	8.00	80.0	18.0	M 5	3	436 10.000
11.50	6.40	8.00	80.0	18.0	M 6	3	436 11.500
15.00	8.40	12.50	100.0	22.0	M 8	3	436 15.000
19.00	10.50	12.50	100.0	22.0	M 10	3	436 19.000

90° Countersinks for medium tolerances

Article no. **437**



Cutting data page 1093



P	M	K	N	S	H
●	○	●	●	○	○

with fixed pilot • for through-holes • Ø 21.50 mm to company standard

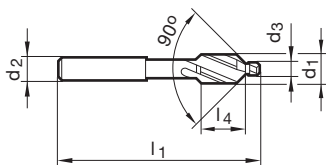

Article no. **437**

d1 mm	d3 mm	d2 mm	l1 mm	l6 mm	G	Z	Order no.
6.60	3.40	5.00	71.0	14.0	M 3	3	437 6.600
9.00	4.50	8.00	80.0	18.0	M 4	3	437 9.000
11.00	5.50	8.00	80.0	18.0	M 5	3	437 11.000
13.00	6.60	12.50	100.0	22.0	M 6	3	437 13.000
17.20	9.00	12.50	100.0	22.0	M 8	3	437 17.200
21.50	11.00	12.50	100.0	22.0	M10	3	437 21.500



90° Countersinks for tapping size holes

Article no. 438



Cutting data page 1093

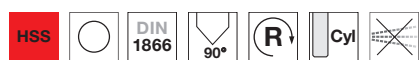

with fixed pilot • Ø 19.00 mm to company standard

P	M	K	N	S	H
•	○	•	•	○	

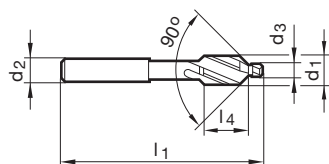

Article no.

438

d1 mm	d3 mm	d2 mm	l1 mm	l6 mm	G	Z	Order no.
6.00	2.50	5.00	71.0	14.0	M 3	3	438 6.000
8.00	3.30	5.00	71.0	14.0	M 4	3	438 8.000
10.00	4.20	8.00	80.0	18.0	M 5	3	438 10.000
11.50	5.00	8.00	80.0	18.0	M 6	3	438 11.500
15.00	6.80	12.50	100.0	22.0	M 8	3	438 15.000
19.00	8.50	12.50	100.0	22.0	M10	3	438 19.000



60° Countersinks SpyroTec

Article no. **5670**



3 different convex cutting edges • low-vibration cutting • for round and chatter-free countersinking • considerably lower feed force required • for universal application

Cutting data page 1092

P	M	K	N	S	H
●	●	●	○	○	○

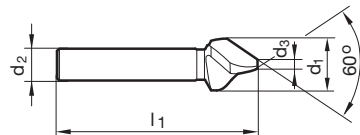

Article no.

5670

d1 mm	d2 mm	d3 mm	l1 mm	Z
6.30	5.00	1.6	45.0	3
8.00	6.00	2.0	50.0	3
10.00	6.00	3.2	56.0	3
12.50	8.00	3.2	56.0	3
16.00	10.00	4.0	63.0	3
20.00	10.00	5.0	67.0	3
25.00	10.00	6.3	71.0	3

Order no.
5670 6.300
5670 8.000
5670 10.000
5670 12.500
5670 16.000
5670 20.000
5670 25.000

60° Countersinks SpyroTec

Article no. **5671**



3-flats on shank prevent slipping in the chuck • 3 different convex cutting edges • perfect for hand drills • low-vibration cutting • for round and chatter-free countersinking • considerably lower feed force required • for universal application

Cutting data page 1092

P	M	K	N	S	H
●	●	●	○	○	○

Countersinking tools

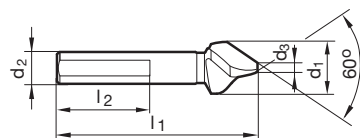

Article no.

5671

d1 mm	d2 mm	d3 mm	l1 mm	l2 mm	Z
6.30	5.00	1.60	45.0	30.0	3
8.00	6.00	2.00	50.0	30.0	3
10.00	6.00	3.20	56.0	30.0	3
12.50	8.00	3.20	56.0	30.0	3
16.00	10.00	4.00	63.0	30.0	3
20.00	10.00	5.00	67.0	30.0	3
25.00	10.00	6.30	71.0	30.0	3

Order no.
5671 6.300
5671 8.000
5671 10.000
5671 12.500
5671 16.000
5671 20.000
5671 25.000



60° Countersink sets SpyroTec

Article no. 5672



Cutting data page 1092



P	M	K	N	S	H
●	●	●	○	○	

consisting of art. no. 5670 • 3 different convex cutting edges • low-vibration cutting • for round and chatter-free countersinking • considerably lower feed force required • for universal application

Article no. **5672**

Ø-range mm	Pieces/set	Order no.
6.3/8.0/10.0/12.5/16.0/20.0	6	5672 1.000

60° Countersink sets SpyroTec

Article no. 5673



Cutting data page 1092



P	M	K	N	S	H
●	●	●	○	○	

consisting of art. no. 5671 • 3 different convex cutting edges • 3-flats on shank prevent slipping in the chuck • perfect for hand drills • low-vibration cutting • for round and chatter-free countersinking • considerably lower feed force required • for universal application

Article no. **5673**

Ø-range mm	Pieces/set	Order no.
6.3/8.0/10.0/12.5/16.0/20.0	6	5673 1.000



60° Countersinks

Article no. **472**



Cutting data page 1093



3-fluted • radial relieved

P	M	K	N	S	H
•	○	•	•	○	○

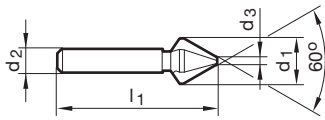

Article no. **472**

d1 mm	d2 mm	d3 mm	l1 mm	Z	Order no.
6.30	5.00	1.6	45.0	3	472 6.300
8.00	6.00	2.0	50.0	3	472 8.000
12.50	8.00	3.2	56.0	3	472 12.500
16.00	10.00	4.0	63.0	3	472 16.000
20.00	10.00	5.0	67.0	3	472 20.000
25.00	10.00	6.3	71.0	3	472 25.000

60° Countersinks

Article no. **470**



Cutting data page 1093

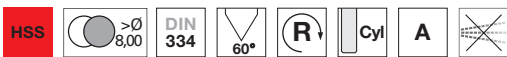

multi-fluted • straight-fluted • with relief-ground

P	M	K	N	S	H
•	○	•	•	○	○

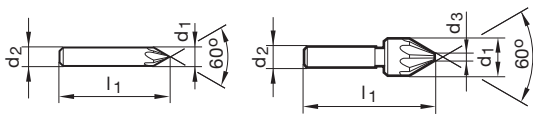

Article no. **470**

d1 mm	d2 mm	d3 mm	l1 mm	Z	Order no.
8.00	8.00		50.0	5	470 8.000
12.50	8.00	2.0	50.0	5	470 12.500
16.00	10.00	3.2	60.0	7	470 16.000
20.00	10.00	5.0	63.0	7	470 20.000



60° Countersinks

Article no. 473



3-fluted • radial relieved

Cutting data page 1093

P	M	K	N	S	H
•	○	•	•	○	

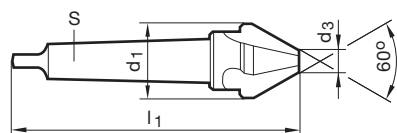

Article no.

473

d1 mm	S	d3 mm	l1 mm	Z	Order no.
16.00	MK-1	4.0	90.0	3	473 16.000
20.00	MK-2	5.0	106.0	3	473 20.000
25.00	MK-2	6.3	112.0	3	473 25.000
31.50	MK-2	10.0	118.0	3	473 31.500
40.00	MK-3	12.5	150.0	3	473 40.000
50.00	MK-3	16.0	160.0	3	473 50.000
63.00	MK-4	20.0	190.0	3	473 63.000
80.00	MK-4	25.0	200.0	3	473 80.000

60° Countersinks

Article no. 471



multi-fluted • straight-fluted • with relief-ground • Ø 100.00 mm to company standard

Cutting data page 1093

P	M	K	N	S	H
•	○	•	•	○	

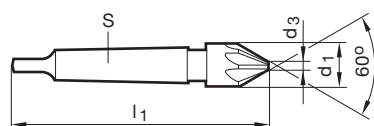

Article no.

471

d1 mm	S	d3 mm	l1 mm	Z	Order no.
16.00	MK-1	3.2	100.0	7	471 16.000
25.00	MK-2	7.0	125.0	9	471 25.000
31.50	MK-2	9.0	132.0	9	471 31.500
40.00	MK-3	12.0	160.0	11	471 40.000
50.00	MK-3	16.0	170.0	13	471 50.000
100.00	MK-4	31.5	224.0	17	471 100.000



82° Countersinks SpyroTec

Article no. **5674**



Cutting data page 1092



P	M	K	N	S	H
•	•	•	○	•	•

3 different convex cutting edges • low-vibration cutting • for round and chatter-free countersinking • considerably lower feed force required • for universal application

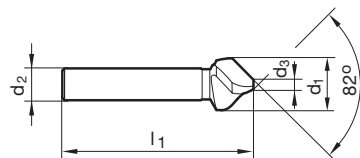

Article no. **5674**

d1 mm	d2 mm	d3 mm	l1 mm	Z	Order no.
6.35	6.35	1.5	50.8	3	5674 6.350
7.93	6.35	2.0	50.8	3	5674 7.938
9.52	6.35	2.2	50.8	3	5674 9.525
12.70	9.52	3.8	57.1	3	5674 12.700
15.87	9.52	4.5	57.1	3	5674 15.875
19.05	12.70	5.3	69.8	3	5674 19.050
22.22	12.70	5.8	69.8	3	5674 22.225
25.40	12.70	6.3	69.8	3	5674 25.400
31.75	12.70	9.4	76.2	3	5674 31.750

82° Countersinks SpyroTec

Article no. **5675**



Cutting data page 1092



P	M	K	N	S	H
•	•	•	○	•	•

3 different convex cutting edges • 3-flats on shank prevent slipping in the chuck • perfect for hand drills • low-vibration cutting • for round and chatter-free countersinking • considerably lower feed force required • for universal application

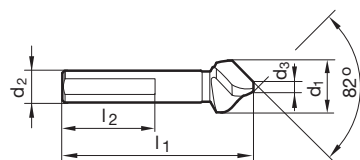

Article no. **5675**

d1 mm	d2 mm	d3 mm	l1 mm	l2 mm	Z	Order no.
6.35	6.35	1.52	50.8	30.0	3	5675 6.350
7.93	6.35	2.03	50.8	30.0	3	5675 7.938
9.52	6.35	2.29	50.8	30.0	3	5675 9.525
12.70	9.52	3.81	57.1	30.0	3	5675 12.700
15.87	9.52	4.57	57.1	30.0	3	5675 15.875
19.05	12.70	5.33	69.8	30.0	3	5675 19.050
22.22	12.70	5.84	69.8	30.0	3	5675 22.225
25.40	12.70	6.35	69.8	30.0	3	5675 25.400
31.75	12.70	9.40	76.2	30.0	3	5675 31.750



82° Countersink sets SpyroTec

Article no. 5676



Cutting data page 1092



P	M	K	N	S	H
•	•	•	○	•	

consisting of art. no. 5674 • 3 different convex cutting edges • low-vibration cutting processes
 • for round and chatter-free countersinking • considerably lower feed force required • for universal application

Article no. **5676**

Ø-range mm	Pieces/set	Order no.
1/4, 5/16, 3/8, 1/2, 5/8, 3/4	6	5676 1.000

82° Countersink sets SpyroTec

Article no. 5677



Cutting data page 1092



P	M	K	N	S	H
•	•	•	○	•	

consisting of art. no. 5675 • 3 different convex cutting edges • 3-flats on shank prevent slipping in the chuck • perfect for hand drills • low-vibration cutting • for round and chatter-free countersinking
 • considerably lower feed force required • for universal application

Article no. **5677**

Ø-range mm	Pieces/set	Order no.
1/4, 5/16, 3/8, 1/2, 5/8, 3/4	6	5677 1.000



Countersinks

120° Countersinks

Article no. **480**



Cutting data page 1093



3-fluted • similar to DIN 347 • radial relieved

P	M	K	N	S	H
•	○	•	•	•	•

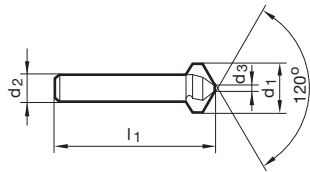

Article no.

480

d1 mm	d2 mm	d3 mm	l1 mm	Z
16.00	10.00	4.0	53.0	3

Order no.

480 16.000

120° Countersinks

Article no. **478**



Cutting data page 1093

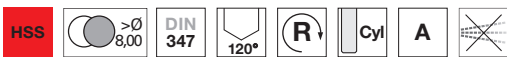

multi-fluted • straight-fluted • with relief-ground • ≤ 12.50 mm and Ø 20.00 mm according to company standard

P	M	K	N	S	H
•	○	•	•	○	•

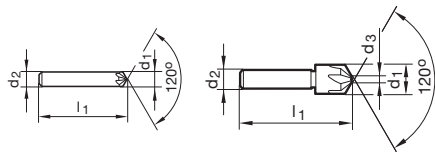

Article no.

478

d1 mm	d2 mm	d3 mm	l1 mm	Z
8.00	8.00		42.0	5
12.50	8.00	2.0	42.0	5
16.00	10.00	3.2	53.0	7
20.00	10.00	5.0	56.0	7

Order no.

478 8.000

478 12.500

478 16.000

478 20.000

Countersinking tools



120° Countersinks

Article no. 481



3-fluted • similar to DIN 347 • radial relieved

Cutting data page 1093

P	M	K	N	S	H
●	○	●	●	○	

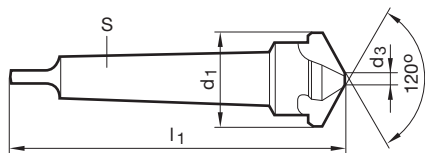

Article no.

481

d1 mm	S	d3 mm	l1 mm	Z	Article no.	Order no.
25.00	MK-2	6.3	112.0	3		481 25.000
40.00	MK-3	12.5	140.0	3		481 40.000



Counterbores with fixed pilots for fine tolerances

Article no. **482**



Cutting data page 1094



with fixed pilot • for through-holes

P	M	K	N	S	H
●	○	●	○	○	○

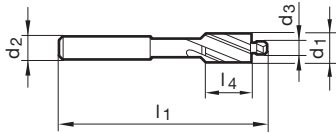

Article no. **482**

d1 mm	d3 mm	d2 mm	l1 mm	l4 mm	G	Z	Order no.
2.50	1.30	2.50	45.0	7.0	M 1.2	2	482 2.500
3.80	1.80	3.80	56.0	10.0	M 1.7	2	482 3.800
4.30	2.20	4.30	56.0	10.0	M2	2	482 4.300
5.50	2.80	5.00	71.0	14.0	M 2.6	3	482 5.500
6.00	3.20	5.00	71.0	14.0	M 3	3	482 6.000
6.50	3.70	5.00	71.0	14.0	M 3.5	3	482 6.500
8.00	4.30	5.00	71.0	14.0	M 4	3	482 8.000
10.00	5.30	8.00	80.0	18.0	M 5	3	482 10.000
11.00	6.40	8.00	80.0	18.0	M 6	3	482 11.000
15.00	8.40	12.50	100.0	22.0	M 8	3	482 15.000
18.00	10.50	12.50	100.0	22.0	M10	3	482 18.000
20.00	13.00	12.50	100.0	22.0	M12	3	482 20.000

Counterbores with fixed pilots for fine tolerances

Article no. **324**



Cutting data page 1094



with fixed pilot • for through-holes

P	M	K	N	S	H
●	○	●	○	○	○

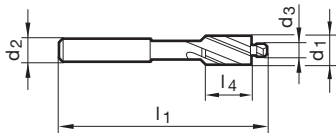

Article no. **324**

d1 mm	d3 mm	d2 mm	l1 mm	l4 mm	G	Z	Order no.
6.00	3.20	5.00	71.0	14.0	M 3	3	324 6.000
8.00	4.30	5.00	71.0	14.0	M 4	3	324 8.000
10.00	5.30	8.00	80.0	18.0	M 5	3	324 10.000
11.00	6.40	8.00	80.0	18.0	M 6	3	324 11.000
15.00	8.40	12.50	100.0	22.0	M 8	3	324 15.000
18.00	10.50	12.50	100.0	22.0	M10	3	324 18.000
20.00	13.00	12.50	100.0	22.0	M12	3	324 20.000



Counterbores with fixed pilots for fine tolerances

Article no. 485



Cutting data page 1094



P	M	K	N	S	H
•	○	•	•	○	

with fixed pilot • for through-holes, fine, in accordance with DIN ISO 273

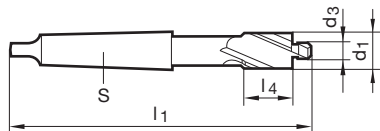

Article no.

485

d1 mm	d3 mm	S	l1 mm	l4 mm	G	Z	Order no.
20.00	13.00	MK-2	150.0	25.0	M12	3	485 20.000
24.00	15.00	MK-2	162.0	30.0	M14	3	485 24.000
26.00	17.00	MK-3	192.0	35.0	M16	3	485 26.000
30.00	19.00	MK-3	192.0	35.0	M18	3	485 30.000
33.00	21.00	MK-3	204.0	40.0	M20	3	485 33.000
40.00	25.00	MK-3	204.0	40.0	M24	3	485 40.000



Counterbores with fixed pilots for medium tolerances

Article no. **483**



Cutting data page 1094



P	M	K	N	S	H
●	○	●	○	○	○

with fixed pilot • for through-holes

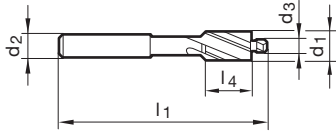

Article no. **483**

d1 mm	d3 mm	d2 mm	l1 mm	l4 mm	G	Z	Order no.
6.00	3.40	5.00	71.0	14.0	M 3	3	483 6.000
8.00	4.50	5.00	71.0	14.0	M 4	3	483 8.000
10.00	5.50	8.00	80.0	18.0	M 5	3	483 10.000
11.00	6.60	8.00	80.0	18.0	M 6	3	483 11.000
15.00	9.00	12.50	100.0	22.0	M 8	3	483 15.000
18.00	11.00	12.50	100.0	22.0	M10	3	483 18.000
20.00	13.50	12.50	100.0	22.0	M12	3	483 20.000

Counterbores with fixed pilots for medium tolerances

Article no. **325**



Cutting data page 1094



P	M	K	N	S	H
●	○	●	○	○	○

with fixed pilot • for through-holes

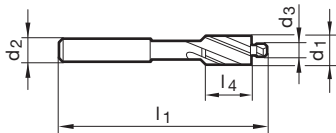

Article no. **325**

d1 mm	d3 mm	d2 mm	l1 mm	l4 mm	G	Z	Order no.
6.00	3.40	5.00	71.0	14.0	M 3	3	325 6.000
8.00	4.50	5.00	71.0	14.0	M 4	3	325 8.000
10.00	5.50	8.00	80.0	18.0	M 5	3	325 10.000
11.00	6.60	8.00	80.0	18.0	M 6	3	325 11.000
15.00	9.00	12.50	100.0	22.0	M 8	3	325 15.000
18.00	11.00	12.50	100.0	22.0	M10	3	325 18.000



Counterbores with fixed pilots for medium tolerances

Article no. 486



Cutting data page 1094



P	M	K	N	S	H
•	○	•	•	○	

with fixed pilot • for through-holes, fine, in accordance with DIN ISO 273

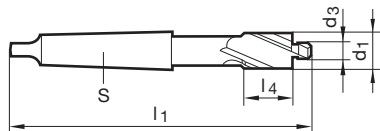

Article no.

486

d1 mm	d3 mm	S	l1 mm	l4 mm	G	Z	Order no.
18.00	11.00	MK-2	150.0	25.0	M10	3	486 18.000
20.00	13.50	MK-2	150.0	25.0	M12	3	486 20.000
24.00	15.50	MK-2	162.0	30.0	M14	3	486 24.000
26.00	17.50	MK-3	192.0	35.0	M16	3	486 26.000
33.00	22.00	MK-3	204.0	40.0	M20	3	486 33.000
40.00	26.00	MK-3	204.0	40.0	M24	3	486 40.000



Counterbores with fixed pilots for tapping size holes

Article no. **484**



Cutting data page 1094



with fixed pilot

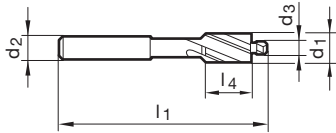

Article no.

484

d1 mm	d3 mm	d2 mm	l1 mm	l4 mm	d1	Z	Order no.
6.00	2.50	5.00	71.0	14.0	M 3	3	484 6.000
8.00	3.30	5.00	71.0	14.0	M 4	3	484 8.000
10.00	4.20	8.00	80.0	18.0	M 5	3	484 10.000
11.00	5.00	8.00	80.0	18.0	M 6	3	484 11.000
15.00	6.80	12.50	100.0	22.0	M 8	3	484 15.000
18.00	8.50	12.50	100.0	22.0	M10	3	484 18.000
20.00	10.20	12.50	100.0	22.0	M12	3	484 20.000



Counterbores with hole for detachable pilot

Article no. 463



Cutting data page 1094

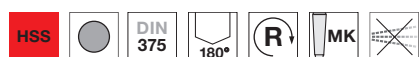

P	M	K	N	S	H
●	○	●	●	○	○

for countersinks according to DIN 974, part 1 • thanks to replaceable pilot: Fine design art. no. 464, medium design art. no. 465, core hole design art. no. 466

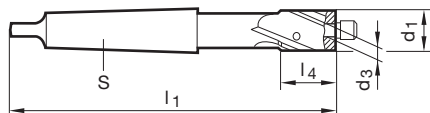

Article no. 463

d1 mm	S	d3 mm	l1 mm	l4 mm	Z	Order no.
15.00	MK-2	4.00	132.0	22.0	3	463 15.000
18.00	MK-2	5.00	140.0	25.0	3	463 18.000
20.00	MK-2	5.00	140.0	25.0	3	463 20.000
24.00	MK-2	6.00	150.0	30.0	3	463 24.000
26.00	MK-3	8.00	180.0	35.0	3	463 26.000
30.00	MK-3	8.00	180.0	35.0	3	463 30.000
33.00	MK-3	10.00	190.0	40.0	3	463 33.000
40.00	MK-3	10.00	190.0	40.0	3	463 40.000

Detach. pilot for fine tolerances

Article no. 464

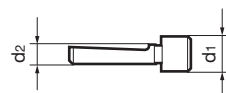

Article no. 464

d1 mm	d2 mm	G	Order no.
8.40	4.00	M 8	464 8.404
8.40	5.00	M 8	464 8.405
10.50	5.00	M10	464 10.505
10.50	6.00	M10	464 10.506
13.00	5.00	M12	464 13.005
13.00	6.00	M12	464 13.006
13.00	8.00	M12	464 13.008
15.00	6.00	M14	464 15.006
15.00	8.00	M14	464 15.008
17.00	8.00	M16	464 17.008
17.00	10.00	M16	464 17.010
19.00	8.00	M18	464 19.008
19.00	10.00	M18	464 19.010
21.00	10.00	M20	464 21.010
23.00	10.00	M22	464 23.010
25.00	10.00	M24	464 25.010

Countersinking tools



Detach. pilot for medial tolerances

Article no. 465

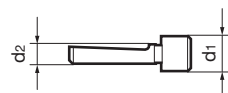

Article no. 465

d1 mm	d2 mm	G	Order no.
9.00	4.00	M 8	465 9.004
9.00	5.00	M 8	465 9.005
11.00	5.00	M10	465 11.005
11.00	6.00	M10	465 11.006
13.50	5.00	M12	465 13.505
13.50	6.00	M12	465 13.506
13.50	8.00	M12	465 13.508
15.50	6.00	M14	465 15.506
15.50	8.00	M14	465 15.508
17.50	8.00	M16	465 17.508
17.50	10.00	M16	465 17.510
20.00	8.00	M18	465 20.008
20.00	10.00	M18	465 20.010
22.00	10.00	M20	465 22.010
24.00	10.00	M22	465 24.010
26.00	10.00	M24	465 26.010

e12222. pilot for tapping size holes

Article no. 466

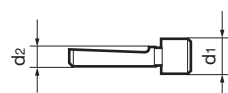

Article no. 466

d1 mm	d2 mm	G	Order no.
6.80	4.00	M 8	466 6.804
6.80	5.00	M 8	466 6.805
8.50	5.00	M10	466 8.505
8.50	6.00	M10	466 8.506
10.20	5.00	M12	466 10.205
10.20	6.00	M12	466 10.206
10.20	8.00	M12	466 10.208
12.00	6.00	M14	466 12.006
12.00	8.00	M14	466 12.008
14.00	8.00	M16	466 14.008
14.00	10.00	M16	466 14.010
15.50	8.00	M18	466 15.508
15.50	10.00	M18	466 15.510
17.50	10.00	M20	466 17.510
19.50	10.00	M22	466 19.510
21.00	10.00	M24	466 21.010



Deburring forks

Article no. 4101



with shank according to DIN 6535 • with internal cooling • for clamping in hydraulic and shrink fit chucks

P	M	K	N	S	H
●	●	●	○	○	○

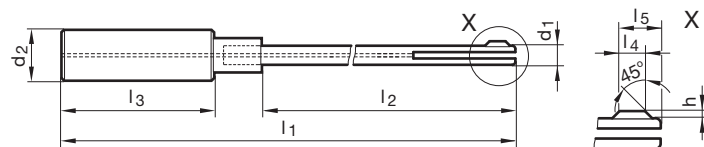

Article no. 4101

Ø-range	d1 mm	d2 h6 mm	l1 mm	l2 mm	l3 mm	l4 mm	l5 mm	h mm	Order no.
1,91 -2,15	1.90	6.00	120.0	69.0	36.0	1.0	2.05	0.35	4101 2.000
2,16 -2,40	2.10	6.00	120.0	69.0	36.0	1.5	2.60	0.40	4101 2.250
2,41 -2,70	2.40	6.00	120.0	69.0	36.0	1.5	2.90	0.40	4101 2.500
2,71 -2,90	2.60	6.00	130.0	79.0	36.0	1.5	2.95	0.45	4101 2.750
2,91 -3,25	2.90	6.00	130.0	79.0	36.0	2.0	3.65	0.45	4101 3.000
3,26 -3,60	3.20	10.00	135.0	80.0	40.0	2.0	3.80	0.60	4101 3.500
3,61 -4,25	3.60	10.00	135.0	80.0	40.0	2.0	4.10	0.70	4101 4.000
4,26 -4,75	4.20	10.00	135.0	80.0	40.0	2.5	4.60	0.70	4101 4.500
4,76 -5,30	4.70	10.00	145.0	80.0	40.0	2.5	4.85	0.75	4101 5.000
5,31 -5,80	5.20	10.00	145.0	90.0	40.0	2.5	4.85	0.75	4101 5.500
5,81 -6,20	5.60	10.00	155.0	90.0	40.0	3.0	5.80	0.80	4101 6.000
6,21 -6,70	6.00	16.00	165.0	102.0	48.0	3.0	5.90	0.90	4101 6.500
6,71 -7,10	6.50	16.00	165.0	102.0	48.0	3.0	5.85	0.85	4101 7.000
7,11 -7,60	6.90	16.00	165.0	102.0	48.0	3.5	6.95	0.95	4101 7.500
7,61 -8,05	7.30	16.00	165.0	102.0	48.0	3.5	7.00	1.00	4101 8.000

Deburring forks

Article no. 4100



with internal cooling • with continuous cylindrical shank for holding in collet chucks

P	M	K	N	S	H
●	●	●	○	○	○

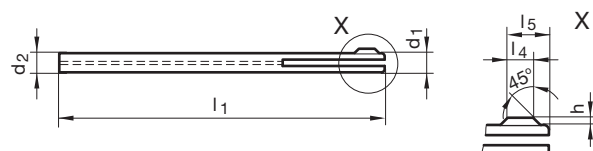

Article no. 4100

Ø-range	d1 mm	d2 mm	l1 mm	l4 mm	l5 mm	h mm	Order no.
1,91 -2,15	1.90	1.90	80.0	1.0	2.05	0.35	4100 2.000
2,16 -2,40	2.10	2.10	80.0	1.5	2.60	0.40	4100 2.250
2,41 -2,70	2.40	2.40	80.0	1.5	2.90	0.40	4100 2.500
2,71 -2,90	2.60	2.60	90.0	1.5	2.95	0.45	4100 2.750
2,91 -3,25	2.90	2.90	90.0	2.0	3.65	0.45	4100 3.000
3,26 -3,60	3.20	3.20	90.0	2.0	3.80	0.60	4100 3.500
3,61 -4,25	3.60	3.60	90.0	2.0	4.10	0.70	4100 4.000
4,26 -4,75	4.20	4.20	90.0	2.5	4.60	0.70	4100 4.500
4,76 -5,30	4.70	4.70	100.0	2.5	4.85	0.75	4100 5.000
5,31 -5,80	5.20	5.20	100.0	2.5	4.85	0.75	4100 5.500
5,81 -6,20	5.60	5.60	110.0	3.0	5.80	0.80	4100 6.000
6,21 -6,70	6.00	6.00	110.0	3.0	5.90	0.90	4100 6.500
6,71 -7,10	6.50	6.50	110.0	3.0	5.85	0.85	4100 7.000
7,11 -7,60	6.90	6.90	110.0	3.5	6.95	0.95	4100 7.500
7,61 -8,05	7.30	7.30	110.0	3.5	7.00	1.00	4100 8.000

Deburring tools



Deburring reamers

Article no. **4103**



deburring without damage to the hole surface • short process times due to low feed rate • minimum cooling pressure 15 bar

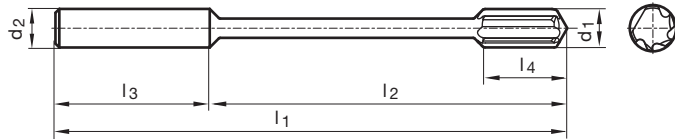

Article no.

4103

d1 mm	d2 mm	l1 mm	l2 mm	l3 mm	l4 mm	Order no.
2.97	4.00	100.0	72.0	28.0	12.0	4103 2.970
3.97	4.00	101.0	73.0	28.0	13.0	4103 3.970
4.97	6.00	121.0	85.0	36.0	13.3	4103 4.970
5.97	6.00	121.0	85.0	36.0	13.6	4103 5.970
7.97	8.00	132.0	96.0	36.0	18.1	4103 7.970
9.97	10.00	130.0	90.0	40.0	19.0	4103 9.970
11.97	12.00	130.0	85.0	45.0	19.0	4103 11.970

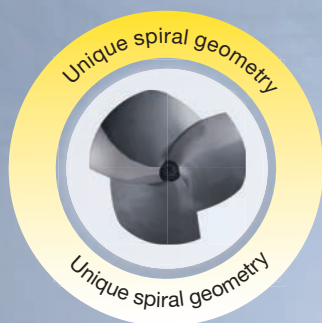
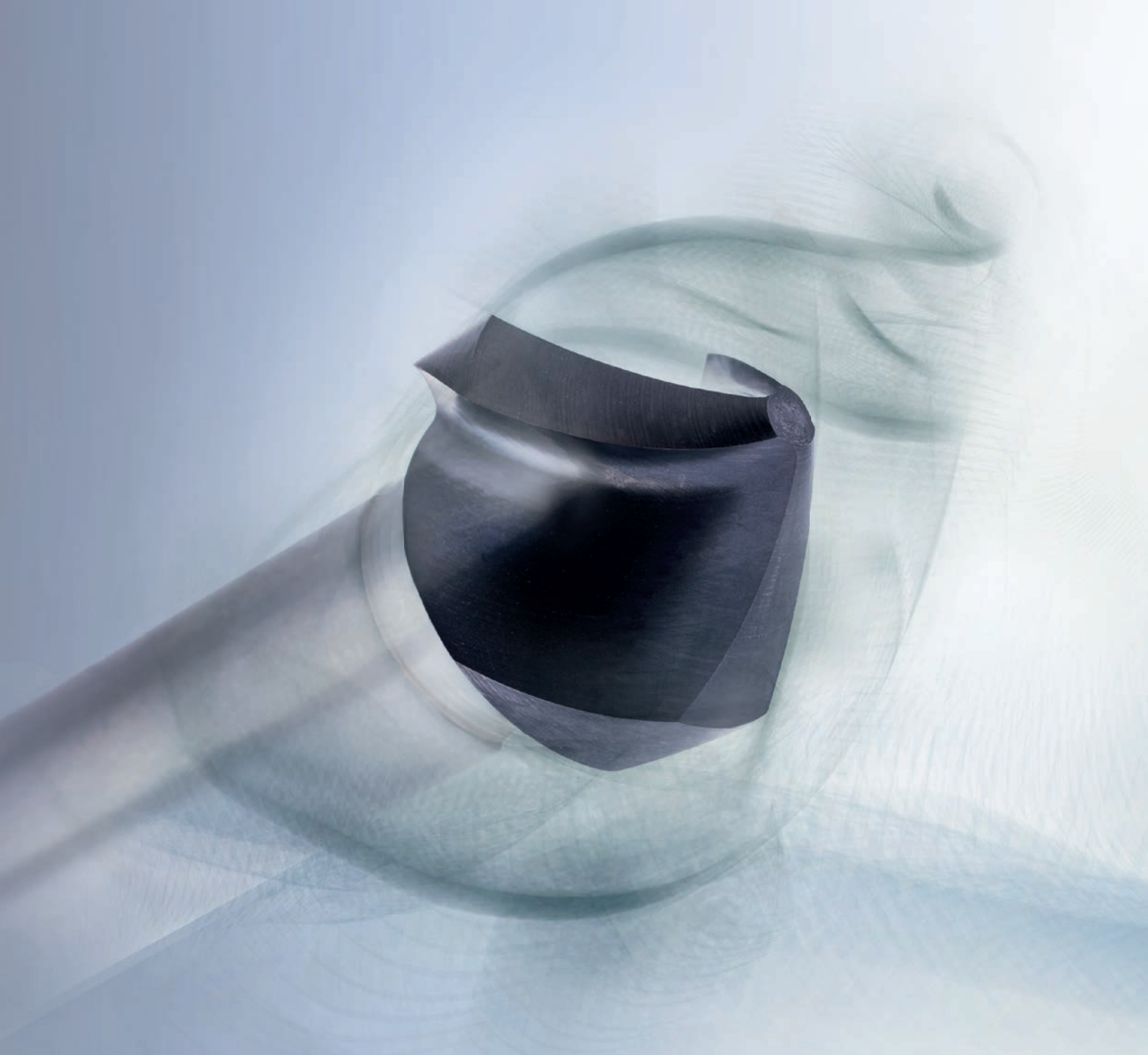

SpyroTec

SPIRAL HSS/HSCO COUNTERSINK

- Round, precise and chatter-free countersinks thanks to uneven helical pitches and radii
- Spiral cutting edges for minimum feed forces (corkscrew effect)
- 60% lower feed force
- 50% lower radial force



Countersinks SpyroTec



Cutting data

Machining group	HSS	HSCO	f (mm/rev) with nom. Ø								
	v _c (m/min)		6.3	8.3	10.4	12.4	16.5	20.5	25	31	40
P1.1.1 Unalloyed steel, annealed, 0.15 % C, Rm 420 N/mm ² , 125 HB	36	42	0.115	0.130	0.140	0.155	0.170	0.185	0.200	0.220	0.230
P1.1.2 Unalloyed steel, heat-treated, 0.15 % C, Rm 420 N/mm ² , 125 HB	31	35	0.095	0.105	0.115	0.120	0.135	0.150	0.160	0.175	0.200
P1.1.3 Unalloyed steel, annealed, 0.45 % C, Rm 640 N/mm ² , 190 HB	31	35	0.095	0.105	0.115	0.120	0.135	0.150	0.160	0.175	0.200
P1.1.4 Unalloyed steel, heat-treated, 0.45 % C, Rm 640 N/mm ² , 190 HB	31	35	0.095	0.105	0.115	0.120	0.135	0.150	0.160	0.175	0.200
P1.1.5 Unalloyed steel, heat-treated, 0.45 % C, Rm 850 N/mm ² , 250 HB	27	31	0.095	0.105	0.115	0.120	0.135	0.150	0.160	0.175	0.200
P1.1.6 Unalloyed steel, annealed, 0.75 % C, Rm 915 N/mm ² , 270 HB	25	29	0.095	0.105	0.115	0.120	0.135	0.150	0.160	0.175	0.200
P1.1.7 Unalloyed steel, heat-treated, 0.75 % C, Rm 1020 N/mm ² , 300 HB	22	25	0.095	0.105	0.115	0.120	0.135	0.150	0.160	0.175	0.200
P2.1.1 Low-alloy steel, annealed, Rm 610 N/mm ² , 180 HB	21	24	0.115	0.130	0.140	0.155	0.170	0.185	0.200	0.220	0.230
P2.1.2 Low-alloy steel, heat-treated, Rm 930 N/mm ² , 275 HB	15	17	0.095	0.105	0.115	0.120	0.135	0.150	0.160	0.175	0.200
P2.1.3 Low-alloy steel, heat-treated, Rm 1020 N/mm ² , 300 HB	13	15	0.095	0.105	0.115	0.120	0.135	0.150	0.160	0.175	0.200
P2.1.4 Low-alloy steel, heat-treated, Rm 1190 N/mm ² , 350 HB	12	13	0.075	0.080	0.090	0.095	0.110	0.120	0.125	0.140	0.170
P3.1.1 High-alloy steel and tool steel, annealed, Rm 680 N/mm ² , 200 HB	16	19	0.075	0.085	0.090	0.100	0.110	0.120	0.130	0.140	0.170
P3.1.2 High-alloy steel and tool steel, hardened and tempered, Rm 1100 N/mm ² , 325 HB	12	14	0.060	0.065	0.075	0.080	0.090	0.095	0.105	0.115	0.150
M1.1.1 Stainless steel, ferritic/martensitic, with machining additives	16	19	0.075	0.085	0.090	0.100	0.110	0.120	0.130	0.140	0.170
M1.1.2 Stainless steel, ferritic/martensitic, annealed, Rm 680 N/mm ² , 200 HB	15	17	0.075	0.085	0.090	0.100	0.110	0.120	0.130	0.140	0.170
M1.1.3 Stainless steel, ferritic/martensitic, heat-treated, Rm 810 N/mm ² , 240 HB	14	16	0.060	0.065	0.075	0.080	0.090	0.095	0.105	0.115	0.150
M2.1.1 Stainless steel, austenitic, quenched, 180 HB	15	17	0.050	0.055	0.060	0.065	0.075	0.080	0.085	0.095	0.135
M2.2.1 Duplex steel, high-strength stainless steels											
K1.1.1 Grey cast iron, pearlitic/ferritic, 180 HB	31	36	0.115	0.130	0.140	0.155	0.170	0.185	0.200	0.220	0.230
K1.1.2 Grey cast iron, pearlitic/martensitic, 260 HB	25	29	0.115	0.130	0.140	0.155	0.170	0.185	0.200	0.220	0.230
K1.2.1 Cast iron with spheroidal graphite, ferritic, 160 HB	27	31	0.115	0.130	0.140	0.155	0.170	0.185	0.200	0.220	0.230
K1.2.2 Cast iron with spheroidal graphite, pearlitic, 250 HB	23	27	0.095	0.105	0.115	0.120	0.135	0.150	0.160	0.175	0.200
K1.3.1 Malleable cast iron, ferritic, 130 HB	27	31	0.115	0.130	0.140	0.155	0.170	0.185	0.200	0.220	0.230
K1.3.2 Malleable cast iron, pearlitic, 230 HB	20	23	0.095	0.105	0.115	0.120	0.135	0.150	0.160	0.175	0.200
K2.1.1 Vermicular graphite cast iron (GJV)	25	29	0.075	0.085	0.090	0.100	0.110	0.120	0.130	0.140	0.170
K2.2.1 Austenitic-ferritic spheroidal graphite cast iron (ADI)	13	14	0.035	0.040	0.045	0.050	0.055	0.060	0.065	0.070	0.120
N1.1.1 Wrought aluminium alloys, non-hardened, 60 HB	63	72	0.140	0.160	0.175	0.185	0.210	0.225	0.245	0.265	0.270
N1.1.2 Wrought aluminium alloys, hardened, 100 HB	63	72	0.140	0.160	0.175	0.185	0.210	0.225	0.245	0.265	0.270
N2.1.1 Aluminium casting alloys, non-hardened, ≤ 12 % Si, 75 HB	50	58	0.115	0.130	0.140	0.155	0.170	0.185	0.200	0.220	0.230
N2.1.2 Aluminium casting alloys, hardened, ≤ 12 % Si, 90 HB	40	46	0.095	0.105	0.115	0.120	0.135	0.150	0.160	0.175	0.200
N2.1.3 Aluminium casting alloys, non-hardened, > 12 % Si, 130 HB	35	40	0.095	0.105	0.115	0.120	0.135	0.150	0.160	0.175	0.200
N3.1.1 Copper and copper alloys: Free-machining alloy, Pb > 1 %	69	79	0.140	0.160	0.175	0.185	0.210	0.225	0.245	0.265	0.270
N3.1.2 Copper and copper alloys: CuZn, CuSnZn	41	47	0.115	0.125	0.140	0.150	0.165	0.180	0.195	0.215	0.225
N3.1.3 Copper and copper alloys: CuSn, lead-free copper and copper electrolyte	55	63	0.115	0.125	0.140	0.150	0.165	0.180	0.195	0.215	0.225
N4.1.1 Non-metallic materials: Duroplastics, fibre-reinforced plastics	44	50	0.140	0.160	0.175	0.185	0.210	0.225	0.245	0.265	0.270
N4.1.2 Non-metallic materials: Hard rubber, wood, etc.	44	50	0.140	0.160	0.175	0.185	0.210	0.225	0.245	0.265	0.270
N4.1.3 Non-metallic materials: Graphite											
S1.1.1 Heat-resistant alloys, Fe-based, annealed, 200 HB	13	14	0.050	0.055	0.060	0.065	0.075	0.080	0.085	0.095	0.135
S1.1.2 Heat-resistant alloys, Fe-based, hardened, 280 HB	10	12	0.040	0.045	0.050	0.050	0.060	0.065	0.070	0.075	0.120
S1.1.3 Heat-resistant alloys, Ni- or Co-based, annealed, 250 HB	11	12	0.050	0.055	0.060	0.065	0.075	0.080	0.085	0.095	0.135
S1.1.4 Heat-resistant alloys, Ni- or Co-based, hardened, 350 HB	6	7	0.040	0.045	0.050	0.050	0.060	0.065	0.070	0.075	0.120
S1.1.5 Heat-resistant alloys, Ni- or Co-based, cast, 320 HB	8	9	0.040	0.045	0.050	0.050	0.060	0.065	0.070	0.075	0.120
S2.1.1 Titanium alloys, pure titanium, Rm 400 N/mm ²	13	14	0.075	0.085	0.090	0.100	0.110	0.120	0.130	0.140	0.170
S2.1.2 Titanium alloys, Alpha and Beta alloys, hardened, Rm 1050 N/mm ²	8	9	0.060	0.065	0.075	0.080	0.090	0.095	0.105	0.115	0.150
H1.1.1 Hardened steel, hardened and tempered, < 55 HRC											
H1.1.2 Hardened steel, hardened and tempered, < 60 HRC											
H1.1.3 Hardened steel, hardened and tempered, > 60 HRC											
H2.1.1 Chilled cast iron, 400 HB	10	12	0.050	0.055	0.060	0.065	0.075	0.080	0.085	0.095	0.135
H2.1.2 Chilled cast iron, hardened and tempered, < 55 HRC											



Countersinks HSS



Machining group				f (mm/rev) with nom. 0								
				v _c (m/min)			2	8.3	12.4	16.5	25	31
P1.1.1 Unalloyed steel, annealed, 0.15 % C, Rm 420 N/mm ² , 125 HB	29	33	36	0.075	0.130	0.155	0.170	0.200	0.220	0.230	0.250	0.305
P1.1.2 Unalloyed steel, heat-treated, 0.15 % C, Rm 420 N/mm ² , 125 HB	25	28	31	0.060	0.105	0.120	0.135	0.160	0.175	0.200	0.210	0.260
P1.1.3 Unalloyed steel, annealed, 0.45 % C, Rm 640 N/mm ² , 190 HB	25	28	31	0.060	0.105	0.120	0.135	0.160	0.175	0.200	0.210	0.260
P1.1.4 Unalloyed steel, heat-treated, 0.45 % C, Rm 640 N/mm ² , 190 HB	25	28	31	0.060	0.105	0.120	0.135	0.160	0.175	0.200	0.210	0.260
P1.1.5 Unalloyed steel, heat-treated, 0.45 % C, Rm 850 N/mm ² , 250 HB	22	25	27	0.060	0.105	0.120	0.135	0.160	0.175	0.200	0.210	0.260
P1.1.6 Unalloyed steel, annealed, 0.75 % C, Rm 915 N/mm ² , 270 HB	20	23	25	0.060	0.105	0.120	0.135	0.160	0.175	0.200	0.210	0.260
P1.1.7 Unalloyed steel, heat-treated, 0.75 % C, Rm 1020 N/mm ² , 300 HB	17	20	22	0.060	0.105	0.120	0.135	0.160	0.175	0.200	0.210	0.260
P2.1.1 Low-alloy steel, annealed, Rm 610 N/mm ² , 180 HB	17	20	21	0.075	0.130	0.155	0.170	0.200	0.220	0.230	0.250	0.305
P2.1.2 Low-alloy steel, heat-treated, Rm 930 N/mm ² , 275 HB	12	14	15	0.060	0.105	0.120	0.135	0.160	0.175	0.200	0.210	0.260
P2.1.3 Low-alloy steel, heat-treated, Rm 1020 N/mm ² , 300 HB	10	12	13	0.060	0.105	0.120	0.135	0.160	0.175	0.200	0.210	0.260
P2.1.4 Low-alloy steel, heat-treated, Rm 1190 N/mm ² , 350 HB	9	11	12	0.045	0.080	0.095	0.110	0.125	0.140	0.170	0.180	0.225
P3.1.1 High-alloy steel and tool steel, annealed, Rm 680 N/mm ² , 200 HB	13	15	16	0.045	0.085	0.100	0.110	0.130	0.140	0.170	0.185	0.225
P3.1.2 High-alloy steel and tool steel, hardened and tempered, Rm 1100 N/mm ² , 325 HB	10	11	12	0.040	0.065	0.080	0.090	0.105	0.115	0.150	0.160	0.200
M1.1.1 Stainless steel, ferritic/martensitic, with machining additives	13	15	16	0.045	0.085	0.100	0.110	0.130	0.140	0.170	0.185	0.225
M1.1.2 Stainless steel, ferritic/martensitic, annealed, Rm 680 N/mm ² , 200 HB	12	13	15	0.045	0.085	0.100	0.110	0.130	0.140	0.170	0.185	0.225
M1.1.3 Stainless steel, ferritic/martensitic, heat-treated, Rm 810 N/mm ² , 240 HB	11	13	14	0.040	0.065	0.080	0.090	0.105	0.115	0.150	0.160	0.200
M2.1.1 Stainless steel, austenitic, quenched, 180 HB	12	14	15	0.030	0.055	0.065	0.075	0.085	0.095	0.135	0.145	0.180
M2.2.1 Duplex steel, high-strength stainless steels												
K1.1.1 Grey cast iron, pearlitic/ferritic, 180 HB	25	29	31	0.075	0.130	0.155	0.170	0.200	0.220	0.230	0.250	0.305
K1.1.2 Grey cast iron, pearlitic/martensitic, 260 HB	20	23	25	0.075	0.130	0.155	0.170	0.200	0.220	0.230	0.250	0.305
K1.2.1 Cast iron with spheroidal graphite, ferritic, 160 HB	21	24	27	0.075	0.130	0.155	0.170	0.200	0.220	0.230	0.250	0.305
K1.2.2 Cast iron with spheroidal graphite, pearlitic, 250 HB	19	22	23	0.060	0.105	0.120	0.135	0.160	0.175	0.200	0.210	0.260
K1.3.1 Malleable cast iron, ferritic, 130 HB	21	24	27	0.075	0.130	0.155	0.170	0.200	0.220	0.230	0.250	0.305
K1.3.2 Malleable cast iron, pearlitic, 230 HB	16	19	20	0.060	0.105	0.120	0.135	0.160	0.175	0.200	0.210	0.260
K2.1.1 Vermicular graphite cast iron (GJV)	20	23	25	0.045	0.085	0.100	0.110	0.130	0.140	0.170	0.185	0.225
K2.2.1 Austenitic-ferritic spheroidal graphite cast iron (ADI)		12	13	0.025	0.040	0.050	0.055	0.065	0.070	0.120	0.125	0.155
N1.1.1 Wrought aluminium alloys, non-hardened, 60 HB	50			0.090	0.160	0.185	0.210	0.245	0.265	0.270	0.285	0.355
N1.1.2 Wrought aluminium alloys, hardened, 100 HB	50			0.090	0.160	0.185	0.210	0.245	0.265	0.270	0.285	0.355
N2.1.1 Aluminium casting alloys, non-hardened, ≤ 12 % Si, 75 HB	40	46	50	0.075	0.130	0.155	0.170	0.200	0.220	0.230	0.250	0.305
N2.1.2 Aluminium casting alloys, hardened, ≤ 12 % Si, 90 HB	32	37	40	0.060	0.105	0.120	0.135	0.160	0.175	0.200	0.210	0.260
N2.1.3 Aluminium casting alloys, non-hardened, > 12 % Si, 130 HB	28	32	35	0.060	0.105	0.120	0.135	0.160	0.175	0.200	0.210	0.260
N3.1.1 Copper and copper alloys: Free-machining alloy, Pb > 1 %	55	63	69	0.090	0.160	0.185	0.210	0.245	0.265	0.270	0.285	0.355
N3.1.2 Copper and copper alloys: CuZn, CuSnZn	33	38	41	0.070	0.125	0.150	0.165	0.195	0.215	0.225	0.245	0.300
N3.1.3 Copper and copper alloys: CuSn, lead-free copper and copper electrolyte	44	51	55	0.070	0.125	0.150	0.165	0.195	0.215	0.225	0.245	0.300
N4.1.1 Non-metallic materials: Duroplastics, fibre-reinforced plastics	35	40	44	0.090	0.160	0.185	0.210	0.245	0.265	0.270	0.285	0.355
N4.1.2 Non-metallic materials: Hard rubber, wood, etc.	35	40	44	0.090	0.160	0.185	0.210	0.245	0.265	0.270	0.285	0.355
N4.1.3 Non-metallic materials: Graphite												
S1.1.1 Heat-resistant alloys, Fe-based, annealed, 200 HB	10	12	13	0.030	0.055	0.065	0.075	0.085	0.095	0.135	0.145	0.180
S1.1.2 Heat-resistant alloys, Fe-based, hardened, 280 HB	8	9	10	0.025	0.045	0.050	0.060	0.070	0.075	0.120	0.130	0.160
S1.1.3 Heat-resistant alloys, Ni- or Co-based, annealed, 250 HB	9	10	11	0.030	0.055	0.065	0.075	0.085	0.095	0.135	0.145	0.180
S1.1.4 Heat-resistant alloys, Ni- or Co-based, hardened, 350 HB	5	6	6	0.025	0.045	0.050	0.060	0.070	0.075	0.120	0.130	0.160
S1.1.5 Heat-resistant alloys, Ni- or Co-based, cast, 320 HB	6	7	8	0.025	0.045	0.050	0.060	0.070	0.075	0.120	0.130	0.160
S2.1.1 Titanium alloys, pure titanium, Rm 400 N/mm ²	10	12	13	0.045	0.085	0.100	0.110	0.130	0.140	0.170	0.185	0.225
S2.1.2 Titanium alloys, Alpha and Beta alloys, hardened, Rm 1050 N/mm ²	7	7	8	0.040	0.065	0.080	0.090	0.105	0.115	0.150	0.160	0.200
H1.1.1 Hardened steel, hardened and tempered, < 55 HRC												
H1.1.2 Hardened steel, hardened and tempered, < 60 HRC												
H1.1.3 Hardened steel, hardened and tempered, > 60 HRC												
H2.1.1 Chilled cast iron, 400 HB	8	9	10	0.030	0.055	0.065	0.075	0.085	0.095	0.135	0.145	0.180
H2.1.2 Chilled cast iron, hardened and tempered, < 55 HRC												



Counterbores HSS



Cutting data

Machining group			f (mm/rev) with nom. Ø								
			v _c (m/min)	2.5	4.3	6	8	10	15	20	26
P1.1.1 Unalloyed steel, annealed, 0.15 % C, Rm 420 N/mm ² , 125 HB	29	33	0.080	0.100	0.115	0.130	0.140	0.165	0.185	0.205	0.230
P1.1.2 Unalloyed steel, heat-treated, 0.15 % C, Rm 420 N/mm ² , 125 HB	25	28	0.065	0.080	0.090	0.100	0.110	0.130	0.150	0.165	0.200
P1.1.3 Unalloyed steel, annealed, 0.45 % C, Rm 640 N/mm ² , 190 HB	25	28	0.065	0.080	0.090	0.100	0.110	0.130	0.150	0.165	0.200
P1.1.4 Unalloyed steel, heat-treated, 0.45 % C, Rm 640 N/mm ² , 190 HB	25	28	0.065	0.080	0.090	0.100	0.110	0.130	0.150	0.165	0.200
P1.1.5 Unalloyed steel, heat-treated, 0.45 % C, Rm 850 N/mm ² , 250 HB	22	25	0.065	0.080	0.090	0.100	0.110	0.130	0.150	0.165	0.200
P1.1.6 Unalloyed steel, annealed, 0.75 % C, Rm 915 N/mm ² , 270 HB	20	23	0.065	0.080	0.090	0.100	0.110	0.130	0.150	0.165	0.200
P1.1.7 Unalloyed steel, heat-treated, 0.75 % C, Rm 1020 N/mm ² , 300 HB	17	20	0.065	0.080	0.090	0.100	0.110	0.130	0.150	0.165	0.200
P2.1.1 Low-alloy steel, annealed, Rm 610 N/mm ² , 180 HB	17	20	0.080	0.100	0.115	0.130	0.140	0.165	0.185	0.205	0.230
P2.1.2 Low-alloy steel, heat-treated, Rm 930 N/mm ² , 275 HB	12	14	0.065	0.080	0.090	0.100	0.110	0.130	0.150	0.165	0.200
P2.1.3 Low-alloy steel, heat-treated, Rm 1020 N/mm ² , 300 HB	10	12	0.065	0.080	0.090	0.100	0.110	0.130	0.150	0.165	0.200
P2.1.4 Low-alloy steel, heat-treated, Rm 1190 N/mm ² , 350 HB	9	11	0.050	0.065	0.070	0.080	0.090	0.105	0.115	0.130	0.170
P3.1.1 High-alloy steel and tool steel, annealed, Rm 680 N/mm ² , 200 HB	13	15	0.050	0.065	0.075	0.080	0.090	0.105	0.120	0.130	0.170
P3.1.2 High-alloy steel and tool steel, hardened and tempered, Rm 1100 N/mm ² , 325 HB	10	11	0.040	0.050	0.060	0.065	0.070	0.085	0.095	0.105	0.150
M1.1.1 Stainless steel, ferritic/martensitic, with machining additives	13	15	0.050	0.065	0.075	0.080	0.090	0.105	0.120	0.130	0.170
M1.1.2 Stainless steel, ferritic/martensitic, annealed, Rm 680 N/mm ² , 200 HB	12	13	0.050	0.065	0.075	0.080	0.090	0.105	0.120	0.130	0.170
M1.1.3 Stainless steel, ferritic/martensitic, heat-treated, Rm 810 N/mm ² , 240 HB	11	13	0.040	0.050	0.060	0.065	0.070	0.085	0.095	0.105	0.150
M2.1.1 Stainless steel, austenitic, quenched, 180 HB	12	14	0.035	0.045	0.050	0.055	0.060	0.070	0.080	0.090	0.135
M2.2.1 Duplex steel, high-strength stainless steels											
K1.1.1 Grey cast iron, pearlitic/ferritic, 180 HB	25	29	0.080	0.100	0.115	0.130	0.140	0.165	0.185	0.205	0.230
K1.1.2 Grey cast iron, pearlitic/martensitic, 260 HB	20	23	0.080	0.100	0.115	0.130	0.140	0.165	0.185	0.205	0.230
K1.2.1 Cast iron with spheroidal graphite, ferritic, 160 HB	21	24	0.080	0.100	0.115	0.130	0.140	0.165	0.185	0.205	0.230
K1.2.2 Cast iron with spheroidal graphite, pearlitic, 250 HB	19	22	0.065	0.080	0.090	0.100	0.110	0.130	0.150	0.165	0.200
K1.3.1 Malleable cast iron, ferritic, 130 HB	21	24	0.080	0.100	0.115	0.130	0.140	0.165	0.185	0.205	0.230
K1.3.2 Malleable cast iron, pearlitic, 230 HB	16	19	0.065	0.080	0.090	0.100	0.110	0.130	0.150	0.165	0.200
K2.1.1 Vermicular graphite cast iron (GJV)	20	23	0.050	0.065	0.075	0.080	0.090	0.105	0.120	0.130	0.170
K2.2.1 Austenitic-ferritic spheroidal graphite cast iron (ADI)		12	0.025	0.030	0.035	0.040	0.045	0.055	0.060	0.065	0.120
N1.1.1 Wrought aluminium alloys, non-hardened, 60 HB	50		0.100	0.120	0.140	0.155	0.170	0.200	0.225	0.250	0.270
N1.1.2 Wrought aluminium alloys, hardened, 100 HB	50		0.100	0.120	0.140	0.155	0.170	0.200	0.225	0.250	0.270
N2.1.1 Aluminium casting alloys, non-hardened, ≤ 12 % Si, 75 HB	40	46	0.080	0.100	0.115	0.130	0.140	0.165	0.185	0.205	0.230
N2.1.2 Aluminium casting alloys, hardened, ≤ 12 % Si, 90 HB	32	37	0.065	0.080	0.090	0.100	0.110	0.130	0.150	0.165	0.200
N2.1.3 Aluminium casting alloys, non-hardened, > 12 % Si, 130 HB	28	32	0.065	0.080	0.090	0.100	0.110	0.130	0.150	0.165	0.200
N3.1.1 Copper and copper alloys: Free-machining alloy, Pb > 1 %	55	63	0.100	0.120	0.140	0.155	0.170	0.200	0.225	0.250	0.270
N3.1.2 Copper and copper alloys: CuZn, CuSnZn	33	38	0.080	0.095	0.110	0.125	0.135	0.160	0.180	0.200	0.225
N3.1.3 Copper and copper alloys: CuSn, lead-free copper and copper electrolyte	44	51	0.080	0.095	0.110	0.125	0.135	0.160	0.180	0.200	0.225
N4.1.1 Non-metallic materials: Duroplastics, fibre-reinforced plastics	35	40	0.100	0.120	0.140	0.155	0.170	0.200	0.225	0.250	0.270
N4.1.2 Non-metallic materials: Hard rubber, wood, etc.	35	40	0.100	0.120	0.140	0.155	0.170	0.200	0.225	0.250	0.270
N4.1.3 Non-metallic materials: Graphite											
S1.1.1 Heat-resistant alloys, Fe-based, annealed, 200 HB	10	12	0.035	0.045	0.050	0.055	0.060	0.070	0.080	0.090	0.135
S1.1.2 Heat-resistant alloys, Fe-based, hardened, 280 HB	8	9	0.030	0.035	0.040	0.045	0.050	0.055	0.065	0.070	0.120
S1.1.3 Heat-resistant alloys, Ni- or Co-based, annealed, 250 HB	9	10	0.035	0.045	0.050	0.055	0.060	0.070	0.080	0.090	0.135
S1.1.4 Heat-resistant alloys, Ni- or Co-based, hardened, 350 HB	5	6	0.030	0.035	0.040	0.045	0.050	0.055	0.065	0.070	0.120
S1.1.5 Heat-resistant alloys, Ni- or Co-based, cast, 320 HB	6	7	0.030	0.035	0.040	0.045	0.050	0.055	0.065	0.070	0.120
S2.1.1 Titanium alloys, pure titanium, Rm 400 N/mm ²	10	12	0.050	0.065	0.075	0.080	0.090	0.105	0.120	0.130	0.170
S2.1.2 Titanium alloys, Alpha and Beta alloys, hardened, Rm 1050 N/mm ²	7	7	0.040	0.050	0.060	0.065	0.070	0.085	0.095	0.105	0.150
H1.1.1 Hardened steel, hardened and tempered, < 55 HRC											
H1.1.2 Hardened steel, hardened and tempered, < 60 HRC											
H1.1.3 Hardened steel, hardened and tempered, > 60 HRC											
H2.1.1 Chilled cast iron, 400 HB	8	9	0.035	0.045	0.050	0.055	0.060	0.070	0.080	0.090	0.135
H2.1.2 Chilled cast iron, hardened and tempered, < 55 HRC											



E-Learning

GÜHRING Academy

- digital learning world with a comprehensive training programme
- for free, multimedia-based, interactive and practice-oriented



Exciting, interactive learning formats access to expertise in metal machining.



The Gühring Online Academy is available round the clock.
You decide when and where you would like to study.



Benefit from the application recommendations directly from the tool manufacturer.



The Gühring Academy can be attended for free. Sign in now!



Clamping systems GM 300

With Gühring, the tension increases

Modern tool holders
for flawless machining results

GÜHRING

Page

1104	Hydraulic chucks
1130	Shrink fit technology
1172	Tapping chucks
1186	MQL technology
1225	Tool holders for micro tools
1230	HPC clamping chucks
1237	Side lock holders
1253	Collet holders
1270	Drilling chucks
1272	Milling arbors
1280	Morse taper holders
1283	Semi-finished products
1285	 HOLDERS for fine machining
1308	HSK clamping technology
1333	Measuring instruments
1341	General accessories

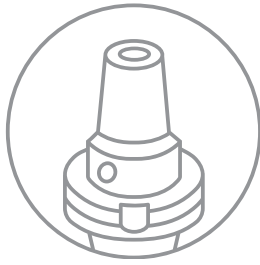

INTERFACE
machine-side



Hydraulic chucks

Hydraulic chucks
HSK-A
e.g. # 4299
p. 1104

Hydraulic chucks
HSK-C
e.g. # 4267
p. 1110



Shrink fit chucks

Shrink fit chucks
HSK-A
e.g. # 4736
p. 1131

Shrink fit chucks
HSK-C
e.g. # 4758
p. 1135

Shrink fit chucks
HSK-E
e.g. # 4737
p. 1136



Tapping chucks

Gührosync
HSK-A
e.g. # 4601
p. 1174



Tool holders for micro tools

Precision collet chuck holders
HSK-A
e.g. # 4476
p. 1225

Precision collet chuck holders
HSK-A
e.g. # 4475
p. 1226



Precision clamping chucks

Precision clamping chucks
HSK-A
e.g. # 4300
p. 1230



Side lock holders

Side lock holders
Weldon
e.g. # 4232
p. 1237

Side lock holders
Whisite Notch
e.g. # 4333
p. 1242



Collet holders

Collet holders
HSK-A
e.g. # 4304
p. 1253

Collet holders
HSK-C
e.g. # 4303
p. 1255

Collet holders
HSK-E
e.g. # 4397
p. 1257

INTERFACE
 machine-side

Hydraulic chucks
 SK
 e.g. # 4213
 p. 1112

Hydraulic chucks
 MAS/BT
 e.g. # 4221
 p. 1116

Hydraulic chucks
 MAS/BT DC
 e.g. # 4598
 p. 1119

Shrink fit chucks
 SK
 e.g. # 4738
 p. 1139

Shrink fit chucks
 MAS/BT
 e.g. # 4739
 p. 1145

Shrink fit chucks
 MAS/BT DC
 e.g. # 4790
 p. 1144

Shrink fit chucks
 CYL
 e.g. # 4719
 p. 1146

Gührosync
 SK
 e.g. # 4576
 p. 1174

Gührosync
 MAS/BT
 e.g. # 4577
 p. 1175

Gührosync
 CYL
 e.g. # 4525
 p. 1175

Precision clamping chucks
 SK
 e.g. # 4301
 p. 1230

Precision clamping chucks
 MAS/BT
 e.g. # 4244
 p. 1231

Precision clamping chucks
 CAT
 e.g. # 4243
 p. 1231

Extensions HPC
 CYL
 e.g. # 4208
 p. 1232

Side lock holders
 Weldon
 e.g. # 4824
 p. 1243

Side lock holders
 Weldon
 e.g. # 4234
 p. 1248

Collet holders
 SK
 e.g. # 4827
 p. 1258

Collet holders
 MAS/BT
 e.g. # 4245
 p. 1259



SELECTION TOOL HOLDERS

Shrink fit chucks / shrink fit extensions	Hydraulic chucks / HMC 3000 / reduction bushes	GÜHROSYNC Hydraulic synchro tapping chucks
---	--	--



Main feature	For applications requiring slim interference contours and precision with good clamping force and rigidity at a moderate price.	Easy handling when stiffness and damping are required.	Combines the advantages of hydraulic expansion and synchroclamping technology. compensates deviations of the machine optimally.
Main application	HSC – universal Drilling, countersinking, milling, reaming	Reaming and drilling Countersinking, HSC application, light milling	Synchronized thread cutting and thread forming
Characteristics	<ul style="list-style-type: none"> highest concentricity accuracy thanks to patented damping screw high stiffness and clamping force <ul style="list-style-type: none"> modularly extendable 	<ul style="list-style-type: none"> high damping with high concentricity accuracy <ul style="list-style-type: none"> simple handling flexible use thanks to reducing bushes also with GÜHROJet 	<ul style="list-style-type: none"> perfect combination of hydraulic expansion chuck and synchro <ul style="list-style-type: none"> tapping chuck simple handling flexible use thanks to reducing bushes also with GÜHROJet <ul style="list-style-type: none"> long-lasting axial and radial balancing
Interfaces			
Clamping diameter range	3 - 32 mm	3 - 32 mm	Holder Ø 12: M2 - M12 (Mt max.: 26 Nm) Holder Ø 20: M4.5 - M20 (Mt max.: 90 Nm)
Concentricity	< 3 µm	< 3 µm	< 50 µm
Balance quality	G 2.5 with 25.000 1/min or U < 1 gmm	G 2.5 with 25.000 1/min or U < 1 gmm	G 6.3 with 15.000 1/min
Concentricity with 5xD	< 5 µm	< 5 µm	-
Clamping force	very high	very high	very high
Rigidity	very high	high	medium
Dampening	low	very high	very high
Interference contour	kein/kleinst	medium	medium
Handling	good	very good / very flexible	very good / very flexible
Actuation	Shrink fit device e. g. GSS 2000 article no. 4742	Hexagon key e. g. article no. 4912	Hexagon key e. g. article no. 4912



HPC precision power chucks / clamping sleeves	Collet chucks ER	Straight shank holders "Weldon" / "Whistle-Notch"
---	------------------	---



Main feature	Provides extreme clamping force and rigidity to compensate lateral forces acting on the tool during HPC milling.	All-rounder for universal use in the low accuracy range.	Simple handling with safe clamping for applications involving large machining volumes.
Main application	HPC milling heavy HPC and fast, accurate HSC milling, drilling, universal application	Flexible – universal light machining, centering, chamfering, drilling, threading; intermediate shank dimensions	Roughing Milling, drilling
Characteristics	<ul style="list-style-type: none"> extreme clamping force and stability thanks to mechanical clamping transmission high precision and balancing quality flexible use thanks to reducing bushes also with GÜHROJet 	<ul style="list-style-type: none"> flexible chuck for various shank dimensions and tolerances for conventional machining operations 	<ul style="list-style-type: none"> robust, low cost chuck for heavy machining in the lower speed and accuracy range
Interfaces			
Clamping diameter range	3 - 32 mm 1-6 mm (HPC extensions)	ER 11: 0.5 - 7.0 mm ER 16: 0.5 - 10.0 mm ER 20: 0.5 - 13.0 mm ER 25: 0.5 - 16.0 mm ER 32: 1.0 - 20.0 mm ER 40: 3.0 - 26.0 mm	6 - 40 mm
Concentricity	< 3 µm	< 10 µm	< 10 µm
Balance quality	G 2.5 with 20,000 1/min or U < 1.2 gmm	G 2.5 with 25,000 1/min or U < 1 gmm	G 6.3 with 15,000 1/min
Concentricity with 5xD	< 8 µm	< 20 µm	< 25 µm
Clamping force	extremely high	medium	very safe thanks to threaded pin
Rigidity	extremely high	medium	very high
Dampening	high	high	low
Interference contour	medium	large	large
Handling	sehr gut / sehr flexibel	good	good
Actuation	Hexagon key / torque wrench e. g. article no. 4987 + 4916 Type D	Hook spanner max. torque: information at at clamping screw article no. 4903	Hexagon key max. torque: information at clamping screw article no. 4903



CONTENTS

Page



Hydraulic chucks

- 1104 **Chucks**
- 1120 **Reduction bushes**
- 1120 **Accessories**



Shrink fit technology

- 1130 **Chucks**
- 1146 **Extensions**
- 1149 **Accessories**
- 1156 **Shrink fit systems**



Tapping chucks

- 1172 **Tapping chucks Gührosync**
- 1181 **Synchro tapping chucks**
- 1183 **Quick change tapping chucks**



MQL technology

- 1186 **MQL**
- 1190 **MQL 1-channel**
- 1204 **MQL 2-channel**



Tool holders for micro tools

- 1225 **Tool holders**
- 1227 **Accessories**



HPC chucks

- 1230 **Chucks**
- 1233 **Clamping sleeves**



		Page
	Tool holders	1237 Side lock holders
		1253 Side lock holders
		1270 NC drilling chucks
		1272 Milling arbors
		1276 Combination cutter arbours
		1280 Morse taper holders
		1283 Semi-finished products
	Holders for fine machining	1285 Module 6x6
		1292 Module 4x4
		1302 Floating holders
	HSK clamping technology	1308 Gühroclamp 4-point clamping sets
		1311 M contour clamping sets for MQL and IC
		1314 4-point clamping sets for conventional cooling
		1322 PowerClamp clamping sets
	Measuring instruments	1333 Measuring/inspection instruments HSK
		1336 Measuring/inspection instruments spindle holders
		1339 Measuring/inspection instruments cooling lubrication
	General accessories	1341 General accessories



HSK-A hydraulic chucks with increased clamping force

Article no. **4299**



Product information:

- HSK-A according to ISO 12164-1 / DIN 69893-1
- dimensions according to DIN 69882-7
- balancing quality: G 2.5 / 25,000 rpm or rev. < 1 gmm
- for tool shanks d1 h6
- axial length adjustment
- concentricity < 3 µm
l1 from 120 mm: max. 4 µm,
l1 from 150/160 mm: max. 5 µm,
l1 from 200 mm: max. 7 µm

Scope of delivery:

- incl. adjusting screw (1) art. no. 4900
- incl. clamping screw (2) art. no. 4241

suitable accessories separately available:

- coolant supply set art. no. 4949
- replacement adjusting screw (1), art. no. 4900
- replacement clamping screw (2) art. no. 4241
- hexagonal key (2), art. no. 4912

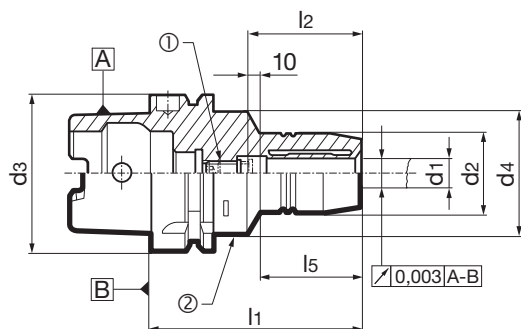

Article no.

4299

d3	d1 mm	d2 mm	d4 mm	l1 mm	l2 mm	l5 mm	①	②	②	kg	Order no.
HSK-A 32	6	26.0	40.0	80.0	37.0	29.0	4900 6.014	4241 8.000	4912 4.000	0.4	4299 6.032
HSK-A 32	8	28.0	40.0	80.0	37.0	29.0	4900 8.014	4241 8.000	4912 4.000	0.4	4299 8.032
HSK-A 32	10	30.0	40.0	85.0	41.0	35.0	4900 8.014	4241 8.000	4912 4.000	0.4	4299 10.032
HSK-A 32	12	32.0	40.0	90.0	46.0	40.0	4900 8.014	4241 8.000	4912 4.000	0.4	4299 12.032
HSK-A 40	6	26.0	33.5	70.0	37.0	36.0	4900 6.014	4241 8.001	4912 4.000	0.6	4299 6.040
HSK-A 40	8	28.0	33.5	70.0	37.0	36.0	4900 8.014	4241 8.001	4912 4.000	0.6	4299 8.040
HSK-A 40	10	30.0	33.5	75.0	41.0	42.0	4900 8.014	4241 8.001	4912 4.000	0.6	4299 10.040
HSK-A 40	12	32.0	33.5	80.0	46.0	48.0	4900 8.014	4241 8.001	4912 4.000	0.6	4299 12.040
HSK-A 50	6	26.0	40.0	70.0	37.0	28.0	4900 6.014	4241 8.000	4912 4.000	0.8	4299 6.050
HSK-A 50	8	28.0	40.0	70.0	37.0	28.0	4900 8.014	4241 8.000	4912 4.000	0.8	4299 8.050
HSK-A 50	10	30.0	40.0	75.0	41.0	34.0	4900 10.014	4241 8.000	4912 4.000	0.8	4299 10.050
HSK-A 50	12	32.0	40.0	85.0	46.0	44.0	4900 12.014	4241 8.000	4912 4.000	0.8	4299 12.050
HSK-A 50	14	34.0	40.0	85.0	46.0	44.0	4900 12.014	4241 8.000	4912 4.000	0.8	4299 14.050
HSK-A 50	16	38.0	53.0	90.0	49.0	30.0	4900 16.014	4241 10.002	4912 5.000	1.1	4299 16.050
HSK-A 50	18	40.0	57.0	90.0	49.0	30.0	4900 16.014	4241 10.002	4912 5.000	1.1	4299 18.050
HSK-A 50	20	42.0	60.0	90.0	51.0	29.0	4900 20.114	4241 10.001	4912 5.000	1.1	4299 20.050
HSK-A 63	6	26.0	50.0	70.0	37.0	24.5	4900 6.014	4241 10.002	4912 5.000	1.1	4299 6.063
HSK-A 63	6	26.0	50.0	150.0	37.0	103.0	4900 6.014	4241 10.002	4912 5.000	1.5	4299 6.163
HSK-A 63	6	26.0	50.0	200.0	37.0	153.0	4900 6.014	4241 10.002	4912 5.000	1.7	4299 6.263
HSK-A 63	8	28.0	50.0	70.0	37.0	25.5	4900 8.014	4241 10.002	4912 5.000	1.1	4299 8.063
HSK-A 63	8	28.0	50.0	150.0	37.0	104.0	4900 8.014	4241 10.002	4912 5.000	1.5	4299 8.163
HSK-A 63	8	28.0	50.0	200.0	37.0	154.0	4900 8.014	4241 10.002	4912 5.000	1.7	4299 8.263
HSK-A 63	10	30.0	50.0	80.0	41.0	35.5	4900 10.014	4241 10.002	4912 5.000	1.1	4299 10.063
HSK-A 63	10	30.0	50.0	150.0	41.0	104.0	4900 10.014	4241 10.002	4912 5.000	1.5	4299 10.163
HSK-A 63	10	30.0	50.0	200.0	41.0	154.0	4900 10.014	4241 10.002	4912 5.000	1.8	4299 10.263
HSK-A 63	12	32.0	50.0	85.0	46.0	41.5	4900 12.014	4241 10.002	4912 5.000	1.1	4299 12.063
HSK-A 63	12	32.0	50.0	150.0	46.0	105.0	4900 12.014	4241 10.002	4912 5.000	1.5	4299 12.163
HSK-A 63	12	32.0	50.0	200.0	46.0	155.0	4900 12.014	4241 10.002	4912 5.000	1.8	4299 12.263
HSK-A 63	14	34.0	50.0	85.0	46.0	41.5	4900 12.014	4241 10.002	4912 5.000	1.2	4299 14.063
HSK-A 63	14	34.0	50.0	150.0	46.0	105.0	4900 12.014	4241 10.002	4912 5.000	1.7	4299 14.163
HSK-A 63	14	34.0	50.0	200.0	46.0	155.0	4900 12.014	4241 10.002	4912 5.000	2.1	4299 14.263
HSK-A 63	16	38.0	50.0	90.0	49.0	45.5	4900 16.014	4241 10.002	4912 5.000	1.3	4299 16.063
HSK-A 63	16	38.0	50.0	150.0	49.0	106.0	4900 16.014	4241 10.002	4912 5.000	1.8	4299 16.163
HSK-A 63	16	38.0	50.0	200.0	49.0	156.0	4900 16.014	4241 10.002	4912 5.000	2.2	4299 16.263
HSK-A 63	18	40.0	50.0	90.0	49.0	48.5	4900 16.014	4241 10.002	4912 5.000	1.3	4299 18.063
HSK-A 63	18	40.0	50.0	150.0	49.0	107.0	4900 16.014	4241 10.002	4912 5.000	1.9	4299 18.163
HSK-A 63	18	40.0	50.0	200.0	49.0	157.0	4900 16.014	4241 10.002	4912 5.000	2.3	4299 18.263
HSK-A 63	20	42.0	50.0	90.0	51.0	47.5	4900 20.114	4241 10.001	4912 5.000	1.3	4299 20.063
HSK-A 63	20	42.0	50.0	150.0	51.0	108.0	4900 20.114	4241 10.002	4912 5.000	1.9	4299 20.163
HSK-A 63	20	42.0	50.0	200.0	51.0	158.0	4900 20.114	4241 10.002	4912 5.000	2.5	4299 20.263
HSK-A 63	25	57.0	63.0	120.0	57.0	55.3	4900 20.114	4241 12.000	4912 6.000	2.3	4299 25.063
HSK-A 63	32	64.0	75.0	125.0	61.0	63.0	4900 20.114	4241 12.000	4912 6.000	2.9	4299 32.063
HSK-A 80	6	26.0	50.0	70.0	37.0	24.0	4900 6.014	4241 10.002	4912 5.000	1.5	4299 6.080
HSK-A 80	8	28.0	50.0	70.0	37.0	24.0	4900 8.014	4241 10.002	4912 5.000	1.5	4299 8.080
HSK-A 80	10	30.0	50.0	80.0	41.0	35.0	4900 10.014	4241 10.002	4912 5.000	1.5	4299 10.080
HSK-A 80	12	32.0	50.0	85.0	46.0	40.0	4900 12.014	4241 10.002	4912 5.000	1.6	4299 12.080
HSK-A 80	14	34.0	50.0	85.0	46.0	40.0	4900 12.014	4241 10.002	4912 5.000	1.6	4299 14.080
HSK-A 80	16	38.0	50.0	95.0	49.0	51.0	4900 16.014	4241 10.002	4912 5.000	1.7	4299 16.080

Hydraulic chucks



Article no.

4299

d3	d1 mm	d2 mm	d4 mm	l1 mm	l2 mm	l5 mm	①	②	②	kg	Order no.
HSK-A 80	18	40.0	50.0	95.0	49.0	51.0	4900 16.014	4241 10.002	4912 5.000	1.8	4299 18.080
HSK-A 80	20	42.0	50.0	95.0	51.0	52.0	4900 20.114	4241 10.001	4912 5.000	1.8	4299 20.080
HSK-A 80	25	57.0	63.0	110.0	57.0	65.0	4900 20.114	4241 12.000	4912 6.000	2.6	4299 25.080
HSK-A 80	32	64.0	75.0	125.0	61.0	63.0	4900 20.114	4241 12.000	4912 6.000	3.2	4299 32.080
HSK-A 100	6	26.0	50.0	75.0	37.0	24.0	4900 6.014	4241 10.002	4912 5.000	2.4	4299 6.100
HSK-A 100	8	28.0	50.0	75.0	37.0	26.0	4900 8.014	4241 10.002	4912 5.000	2.4	4299 8.100
HSK-A 100	10	30.0	50.0	90.0	41.0	42.0	4900 10.014	4241 10.002	4912 5.000	2.5	4299 10.100
HSK-A 100	12	32.0	50.0	95.0	46.0	47.0	4900 12.014	4241 10.002	4912 5.000	2.5	4299 12.100
HSK-A 100	14	34.0	50.0	95.0	46.0	47.0	4900 12.014	4241 10.002	4912 5.000	2.5	4299 14.100
HSK-A 100	16	38.0	50.0	100.0	49.0	53.0	4900 16.014	4241 10.002	4912 5.000	2.7	4299 16.100
HSK-A 100	18	40.0	50.0	100.0	49.0	53.0	4900 16.014	4241 10.002	4912 5.000	2.7	4299 18.100
HSK-A 100	20	42.0	50.0	105.0	51.0	59.0	4900 20.114	4241 10.001	4912 5.000	3.2	4299 20.100
HSK-A 100	25	57.0	63.0	110.0	57.0	62.0	4900 20.114	4241 12.000	4912 6.000	3.3	4299 25.100
HSK-A 100	32	64.0	75.0	110.0	61.0	62.0	4900 20.114	4241 12.000	4912 6.000	3.8	4299 32.100
HSK-A 100	6	26.0	50.0	160.0	37.0	104.0	4900 6.014	4241 10.002	4912 5.000	2.8	4299 106.100
HSK-A 100	8	28.0	50.0	160.0	37.0	104.0	4900 8.014	4241 10.002	4912 5.000	2.8	4299 108.100
HSK-A 100	10	30.0	50.0	160.0	41.0	105.0	4900 10.014	4241 10.002	4912 5.000	2.9	4299 110.100
HSK-A 100	12	32.0	50.0	160.0	46.0	105.0	4900 12.014	4241 10.002	4912 5.000	2.9	4299 112.100
HSK-A 100	14	34.0	50.0	160.0	46.0	107.0	4900 12.014	4241 10.002	4912 5.000	2.9	4299 114.100
HSK-A 100	16	38.0	50.0	160.0	49.0	107.0	4900 16.014	4241 10.002	4912 5.000	3.2	4299 116.100
HSK-A 100	18	40.0	50.0	160.0	49.0	108.0	4900 16.014	4241 10.002	4912 5.000	3.2	4299 118.100
HSK-A 100	20	42.0	50.0	160.0	51.0	108.0	4900 20.114	4241 10.001	4912 5.000	3.6	4299 120.100
HSK-A 100	25	57.0	63.0	160.0	57.0	110.0	4900 20.114	4241 12.000	4912 6.000	3.7	4299 125.100
HSK-A 100	32	64.0	75.0	160.0	61.0	110.0	4900 20.114	4241 12.000	4912 6.000	4.2	4299 132.100
HSK-A 100	6	26.0	50.0	200.0	37.0	144.0	4900 6.014	4241 10.002	4912 5.000	3.0	4299 206.100
HSK-A 100	8	28.0	50.0	200.0	37.0	144.0	4900 8.014	4241 10.002	4912 5.000	3.0	4299 208.100
HSK-A 100	10	30.0	50.0	200.0	41.0	145.0	4900 10.014	4241 10.002	4912 5.000	3.1	4299 210.100
HSK-A 100	12	32.0	50.0	200.0	46.0	145.0	4900 12.014	4241 10.002	4912 5.000	3.1	4299 212.100
HSK-A 100	14	34.0	50.0	200.0	46.0	147.0	4900 12.014	4241 10.002	4912 5.000	3.1	4299 214.100
HSK-A 100	16	38.0	50.0	200.0	49.0	147.0	4900 16.014	4241 10.002	4912 5.000	3.4	4299 216.100
HSK-A 100	18	40.0	50.0	200.0	49.0	148.0	4900 16.014	4241 10.002	4912 5.000	3.4	4299 218.100
HSK-A 100	20	42.0	50.0	200.0	51.0	148.0	4900 20.114	4241 10.001	4912 5.000	3.8	4299 220.100
HSK-A 100	25	57.0	63.0	200.0	57.0	150.0	4900 20.114	4241 12.000	4912 6.000	3.9	4299 225.100
HSK-A 100	32	64.0	75.0	200.0	61.0	150.0	4900 20.114	4241 12.000	4912 6.000	4.4	4299 232.100



Product information:

- HSK-A according to ISO 12164-1 / DIN 69893-1
- dimensions according to DIN 69882-7
- balancing quality: G 2.5 / 25,000 rpm or rev. < 1 gmm
- for tool shanks d1 h6
- robust, radially operated length setting
- concentricity < 3 µm
l1 to 120 mm: max. 4 µm

Scope of delivery:

- incl. clamping screw (2) art. no. 4241

suitable accessories separately available:

- socket wrench for radial length adjustment art. no. 4912
- coolant supply set art. no. 4949
- replacement clamping screw (2) art. no. 4241
- hexagonal key (2), art. no. 4912
- MQL version available on request

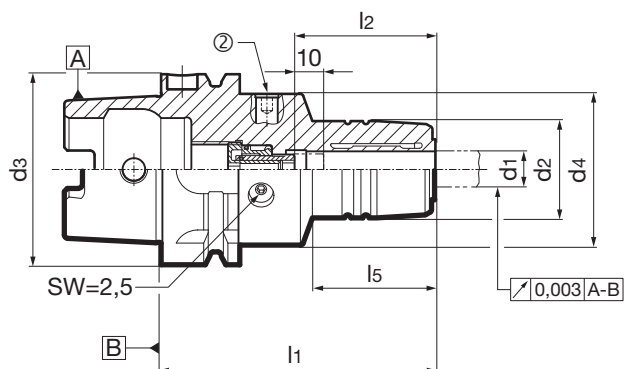

Article no. **4296**

d3	d1 mm	d2 mm	d4 mm	l1 mm	l2 mm	l5 mm	②	②	kg	Order no.
HSK-A 50	6	26.0	40.0	80	37	35.0	4241 8.000	4912 4.000	0.6	4296 6.050
HSK-A 50	8	28.0	40.0	80	37	36.0	4241 8.000	4912 4.000	0.6	4296 8.050
HSK-A 50	10	30.0	40.0	85	41	38.0	4241 8.000	4912 4.000	0.7	4296 10.050
HSK-A 50	12	32.0	40.0	90	46	43.0	4241 8.000	4912 4.000	0.7	4296 12.050
HSK-A 50	14	34.0	40.0	90	46	46.0	4241 8.000	4912 4.000	0.7	4296 14.050
HSK-A 50	16	38.0	53.0	95	49	36.5	4241 10.002	4912 5.000	0.9	4296 16.050
HSK-A 50	18	40.0	57.0	95	49	36.5	4241 10.002	4912 5.000	1.0	4296 18.050
HSK-A 50	20	42.0	60.0	100	51	39.0	4241 10.001	4912 5.000	1.1	4296 20.050
HSK-A 63	6	26.0	50.0	80	37	33.0	4241 10.001	4912 5.000	0.9	4296 6.063
HSK-A 63	8	28.0	50.0	80	37	33.0	4241 10.002	4912 5.000	1.0	4296 8.063
HSK-A 63	10	30.0	50.0	85	41	38.0	4241 10.002	4912 5.000	1.0	4296 10.063
HSK-A 63	12	32.0	50.0	90	46	40.0	4241 10.002	4912 5.000	1.1	4296 12.063
HSK-A 63	14	34.0	50.0	90	46	46.0	4241 10.001	4912 5.000	1.0	4296 14.063
HSK-A 63	16	38.0	50.0	95	49	51.0	4241 10.001	4912 5.000	1.1	4296 16.063
HSK-A 63	18	40.0	50.0	95	49	52.0	4241 10.001	4912 5.000	1.1	4296 18.063
HSK-A 63	20	42.0	50.0	100	51	58.0	4241 10.001	4912 5.000	1.2	4296 20.063
HSK-A 63	25	57.0	63.0	120	57	59.5	4241 12.000	4912 6.000	2.1	4296 25.063
HSK-A 63	32	64.0	75.0	125	61	62.5	4241 12.000	4912 6.000	2.5	4296 32.063
HSK-A 80	6	26.0	50.0	85	37	35.0	4241 10.001	4912 5.000	1.4	4296 6.080
HSK-A 80	8	28.0	50.0	85	37	36.0	4241 10.001	4912 5.000	1.5	4296 8.080
HSK-A 80	10	30.0	50.0	90	41	38.0	4241 10.002	4912 5.000	1.5	4296 10.080
HSK-A 80	12	32.0	50.0	95	46	46.0	4241 10.001	4912 5.000	1.5	4296 12.080
HSK-A 80	14	34.0	50.0	95	46	47.0	4241 10.001	4912 5.000	1.5	4296 14.080
HSK-A 80	16	38.0	50.0	100	49	53.0	4241 10.001	4912 5.000	1.6	4296 16.080
HSK-A 80	18	40.0	50.0	100	49	54.0	4241 10.001	4912 5.000	1.7	4296 18.080
HSK-A 80	20	42.0	50.0	105	51	58.0	4241 10.001	4912 5.000	1.7	4296 20.080
HSK-A 80	25	57.0	63.0	115	57	66.0	4241 12.000	4912 6.000	2.5	4296 25.080
HSK-A 80	32	64.0	75.0	125	61	63.0	4241 12.000	4912 6.000	3.0	4296 32.080
HSK-A 100	6	26.0	50.0	85	37	33.0	4241 10.001	4912 5.000	2.3	4296 6.100
HSK-A 100	8	28.0	50.0	85	37	33.0	4241 10.002	4912 5.000	2.4	4296 8.100
HSK-A 100	10	30.0	50.0	90	41	36.0	4241 10.002	4912 5.000	2.4	4296 10.100
HSK-A 100	12	32.0	50.0	95	46	40.0	4241 10.002	4912 5.000	2.5	4296 12.100
HSK-A 100	14	34.0	50.0	95	46	46.0	4241 10.001	4912 5.000	2.4	4296 14.100
HSK-A 100	16	38.0	50.0	100	49	51.0	4241 10.001	4912 5.000	2.5	4296 16.100
HSK-A 100	18	40.0	50.0	100	49	52.0	4241 10.001	4912 5.000	2.5	4296 18.100
HSK-A 100	20	42.0	50.0	105	51	58.0	4241 10.001	4912 5.000	2.6	4296 20.100
HSK-A 100	25	57.0	63.0	115	57	60.0	4241 12.000	4912 6.000	3.3	4296 25.100
HSK-A 100	32	64.0	75.0	120	61	68.0	4241 12.000	4912 6.000	3.8	4296 32.100

Hydraulic chucks



HSK-A hydraulic chucks

Article no. 4662



Product information:

- HSK-A according to ISO 12164-1 / DIN 69893-1
- balancing quality: G 2.5 / 25,000 rpm or rev. < 1 gmm
- for tool shanks d1 h6
- axial length adjustment

Scope of delivery:

- incl. adjusting screw (1) art. no. 4900
- incl. clamping screw (2) art. no. 4241

suitable accessories separately available:

- coolant supply set art. no. 4949
- replacement adjusting screw (1), art. no. 4900
- replacement clamping screw (2) art. no. 4241
- hexagonal key (2), art. no. 4912

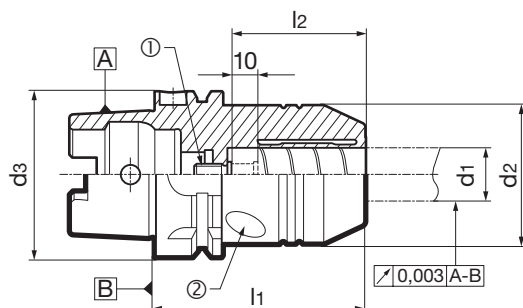

Article no.

4662

d3	d1 mm	d2 mm	l1 mm	l2 mm	①	②	②	kg
HSK-A 63	20	52.5	80.0	51.0	4900 10.014	4241 10.001	4912 5.000	1.3

Order no.

4662 20.063



HSK-A hydraulic chucks, slim design 3°

Article no. **4596**



Product information:

- HSK-A according to ISO 12164-1 / DIN 69893-1
- balancing quality: G 2.5 / 25,000 rpm or rev. < 1 gmm
- for tool shanks d1 h6
- axial length adjustment
- concentricity < 3 µm
l1 to 120 mm: max. 4 µm

Scope of delivery:

- incl. adjusting screw (1) art. no. 4941
- incl. clamping screw (2) art. no. 4241

suitable accessories separately available:

- coolant supply set art. no. 4949
- replacement adjusting screw (1), art. no. 4941
- replacement clamping screw (2) art. no. 4241
- hexagonal key (2), art. no. 4912
- MQL version available on request

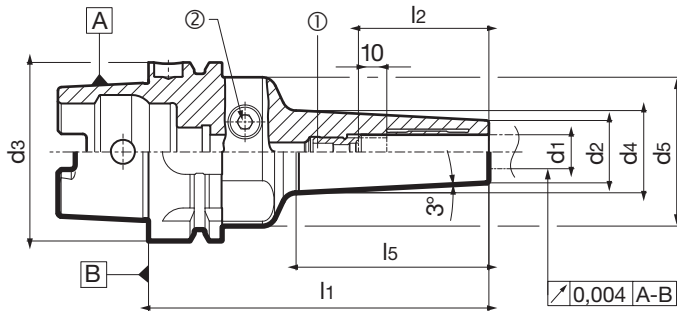

Article no.

4596

d3	d1 mm	d2 mm	d4 mm	d5 mm	l1 mm	l2 mm	l5 mm	①	②	②	kg	Order no.
HSK-A 63	6	16	23.0	52.5	120	37	67.5	4941 6.041	4241 10.002	4912 5.000	1.1	4596 6.163
HSK-A 63	8	18	25.0	52.5	120	37	67.5	4941 8.040	4241 10.002	4912 5.000	1.1	4596 8.163
HSK-A 63	10	20	27.0	52.5	120	41	67.5	4941 10.050	4241 10.002	4912 5.000	1.1	4596 10.163
HSK-A 63	12	22	29.0	52.5	120	46	68.0	4941 12.100	4241 10.002	4912 5.000	1.2	4596 12.163
HSK-A 63	14	24	31.0	52.5	120	46	68.4	4941 14.100	4241 10.002	4912 5.000	1.2	4596 14.163
HSK-A 63	16	26	33.0	52.5	120	49	68.9	4941 16.100	4241 10.002	4912 5.000	1.2	4596 16.163
HSK-A 63	18	28	35.0	52.5	120	49	69.4	4941 18.100	4241 10.002	4912 5.000	1.2	4596 18.163
HSK-A 63	20	30	37.0	52.5	120	51	69.7	4941 20.100	4241 10.002	4912 5.000	1.3	4596 20.163
HSK-A 63	6	16	27.2	52.5	160	37	108.4	4941 6.041	4241 10.002	4912 5.000	1.2	4596 6.263
HSK-A 63	8	18	29.2	52.5	160	37	108.4	4941 8.040	4241 10.002	4912 5.000	1.3	4596 8.263
HSK-A 63	10	20	31.2	52.5	160	41	108.4	4941 10.050	4241 10.002	4912 5.000	1.3	4596 10.263
HSK-A 63	12	22	33.3	52.5	160	46	109.0	4941 12.100	4241 10.002	4912 5.000	1.4	4596 12.263
HSK-A 63	14	24	35.3	52.5	160	46	109.4	4941 14.100	4241 10.002	4912 5.000	1.5	4596 14.263
HSK-A 63	16	26	37.4	52.5	160	49	110.0	4941 16.100	4241 10.002	4912 5.000	1.5	4596 16.263
HSK-A 63	18	28	39.4	52.5	160	49	110.4	4941 18.100	4241 10.002	4912 5.000	1.6	4596 18.263
HSK-A 63	20	30	41.5	52.5	160	51	112.0	4941 20.100	4241 10.002	4912 5.000	1.6	4596 20.263



HSK-A hydraulic chucks HMC 3000

Article no. 4618



GÜHROJET

Product information:

- HSK-A according to ISO 12164-1 / DIN 69893-1
- balancing quality: G 2.5 / 25,000 rpm or rev. < 1 gmm
- perfect concentricity: < 3 µm bei 10xd1
- high clamping force
- quick, easy handling and precise length adjustment only possible from the front
- IC and Gührojet peripheral cooling ensure optimal chip removal and tool lubrication
- for tool shanks d1 h6
- for small clamping diameters

Scope of delivery:

- incl. adjusting screw

suitable accessories separately available:

- coolant supply set art. no. 4949
- replacement clamping screw (2) art. no. 4241
- hexagonal key (2), art. no. 4912

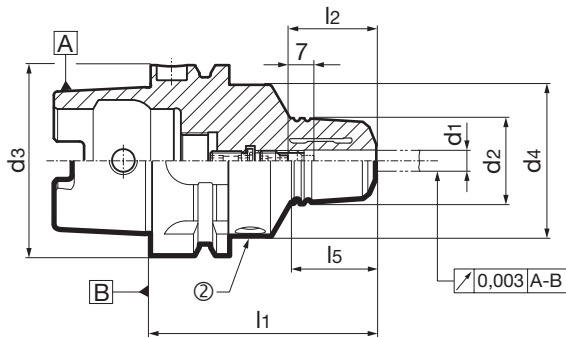

Article no.

4618

d3	d1 mm	d2 mm	d4 mm	l1 mm	l2 mm	l5 mm	②	②	kg	Order no.
HSK-A 32	3	28.0	40.0	84	34	33.0	4241 8.000	4912 4.000	0.5	4618 3.032
HSK-A 32	4	28.0	40.0	84	34	33.0	4241 8.000	4912 4.000	0.4	4618 4.032
HSK-A 32	5	28.0	40.0	84	34	33.0	4241 8.000	4912 4.000	0.4	4618 5.032
HSK-A 40	3	28.0	33.5	74	34	40.0	4241 8.001	4912 4.000	0.6	4618 3.040
HSK-A 40	4	28.0	33.5	74	34	40.0	4241 8.001	4912 4.000	0.6	4618 4.040
HSK-A 40	5	28.0	33.5	74	34	40.0	4241 8.001	4912 4.000	0.6	4618 5.040
HSK-A 50	3	28.0	40.0	74	34	32.0	4241 8.000	4912 4.000	0.8	4618 3.050
HSK-A 50	4	28.0	40.0	74	34	32.0	4241 8.000	4912 4.000	0.8	4618 4.050
HSK-A 50	5	28.0	40.0	74	34	32.0	4241 8.000	4912 4.000	0.8	4618 5.050
HSK-A 63	3	28.0	50.0	74	34	29.5	4241 10.002	4912 5.000	1.0	4618 3.063
HSK-A 63	4	28.0	50.0	74	34	29.5	4241 10.002	4912 5.000	1.0	4618 4.063
HSK-A 63	5	28.0	50.0	74	34	29.5	4241 10.002	4912 5.000	1.0	4618 5.063
HSK-A 100	3	28.0	50.0	79	34	30.0	4241 10.002	4912 5.000	2.4	4618 3.100
HSK-A 100	4	28.0	50.0	79	34	30.0	4241 10.002	4912 5.000	2.4	4618 4.100
HSK-A 100	5	28.0	50.0	79	34	30.0	4241 10.002	4912 5.000	2.4	4618 5.100



HSK-C hydraulic chucks with increased clamping force

Article no. **4267**



Product information:

- HSK-C according to ISO 12164-1/DIN 69893-1
- HSK-C 32 with clamping groove, threaded hole for coolant transfer set and hole for data medium
- balancing quality: G 2.5 / 25,000 rpm or rev. < 1 gmm
- for tool shanks d1 h6

Scope of delivery:

- incl. adjusting screw (1) art. no. 4900
- incl. clamping screw (2) art. no. 4241

suitable accessories separately available:

- replacement adjusting screw (1), art. no. 4900
- replacement clamping screw (2) art. no. 4241
- hexagonal key (2), art. no. 4912

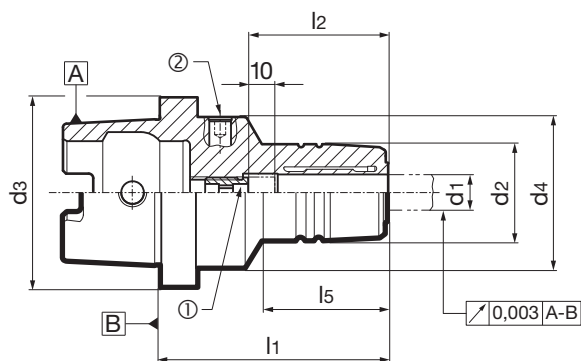

Article no.

4267

d3	d1 mm	d2 mm	d4 mm	l1 mm	l2 mm	l5 mm	①	②	②	kg	Order no.
HSK-C 32	6	26.0	32.0	65.0	37.5	33.0	4900 6.014	4241 8.001	4912 4.000	0.3	4267 6.032
HSK-C 32	8	28.0	32.0	67.0	37.5	34.0	4900 8.014	4241 8.001	4912 4.000	0.3	4267 8.032
HSK-C 32	10	30.0	32.0	72.7	42.5	39.0	4900 8.014	4241 8.001	4912 4.000	0.3	4267 10.032
HSK-C 32	12	31.5	32.0	76.0	46.0	45.0	4900 8.014	4241 8.001	4912 4.000	0.3	4267 12.032
HSK-C 40	6	26.0	40.0	60.0	37.0	35.0	4900 6.014	4241 8.000	4912 4.000	0.3	4267 6.040
HSK-C 40	8	28.0	40.0	60.0	37.0	36.0	4900 8.014	4241 8.000	4912 4.000	0.3	4267 8.040
HSK-C 40	10	30.0	40.0	65.0	41.0	41.0	4900 8.014	4241 8.000	4912 4.000	0.4	4267 10.040
HSK-C 40	12	32.0	40.0	70.0	46.0	47.0	4900 8.014	4241 8.000	4912 4.000	0.4	4267 12.040
HSK-C 50	6	26.0	50.0	60.0	37.0	30.0	4900 6.014	4241 10.002	4912 5.000	0.5	4267 6.050
HSK-C 50	8	28.0	50.0	60.0	37.0	30.0	4900 8.014	4241 10.002	4912 5.000	0.5	4267 8.050
HSK-C 50	10	30.0	50.0	65.0	41.0	35.0	4900 10.014	4241 10.002	4912 5.000	0.5	4267 10.050
HSK-C 50	12	32.0	50.0	75.0	46.0	44.0	4900 12.014	4241 10.002	4912 5.000	0.6	4267 12.050
HSK-C 50	14	34.0	50.0	75.0	46.0	46.0	4900 12.014	4241 10.002	4912 5.000	0.6	4267 14.050
HSK-C 50	16	38.0	50.0	80.0	49.0	51.0	4900 16.014	4241 10.002	4912 5.000	0.7	4267 16.050
HSK-C 50	18	40.0	50.0	80.0	49.0	51.0	4900 16.014	4241 10.002	4912 5.000	0.7	4267 18.050
HSK-C 50	20	42.0	50.0	80.0	51.0	52.0	4900 20.114	4241 10.001	4912 5.000	0.8	4267 20.050
HSK-C 63	6	26.0	50.0	60.0	37.0	25.0	4900 6.014	4241 10.002	4912 5.000	0.7	4267 6.063
HSK-C 63	8	28.0	50.0	60.0	37.0	26.0	4900 8.014	4241 10.002	4912 5.000	0.7	4267 8.063
HSK-C 63	10	30.0	50.0	65.0	41.0	31.0	4900 10.014	4241 10.002	4912 5.000	0.7	4267 10.063
HSK-C 63	12	32.0	50.0	75.0	46.0	41.0	4900 12.014	4241 10.002	4912 5.000	0.8	4267 12.063
HSK-C 63	14	34.0	50.0	75.0	46.0	42.0	4900 12.014	4241 10.002	4912 5.000	0.8	4267 14.063
HSK-C 63	16	38.0	50.0	80.0	49.0	48.0	4900 16.014	4241 10.002	4912 5.000	0.9	4267 16.063
HSK-C 63	18	40.0	50.0	80.0	49.0	48.0	4900 16.014	4241 10.002	4912 5.000	0.9	4267 18.063
HSK-C 63	20	42.0	50.0	80.0	51.0	49.0	4900 20.114	4241 10.001	4912 5.000	0.9	4267 20.063
HSK-C 63	25	57.0	63.0	95.0	57.0	63.0	4900 20.114	4241 12.000	4912 6.000	1.7	4267 25.063
HSK-C 63	32	62.5	75.0	100.0	61.0	60.3	4900 20.114	4241 12.000	4912 6.000	2.1	4267 32.063



HSK-C hydraulic chucks with radial length adjustment

Article no. 4295

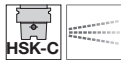

Product information:

- HSK-C according to ISO 12164-1/DIN 69893-1
- dimensions according to DIN 69882-7
- balancing quality: G 2.5 / 25,000 rpm or rev. < 1 gmm

Scope of delivery:

- incl. clamping screw (2) art. no. 4241

suitable accessories separately available:

- socket wrench for radial length adjustment art. no. 4912
- replacement clamping screw (2) art. no. 4241
- hexagonal key (2), art. no. 4912

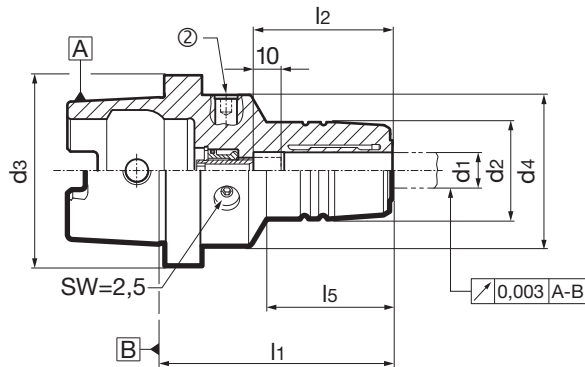

Article no.

4295

d3	d1 mm	d2 mm	d4 mm	l1 mm	l2 mm	l5 mm	②	②	kg	Order no.
HSK-C 40	6	26.0	40.0	60	37	30.0	4241 8.000	4912 4.000	0.5	4295 6.040
HSK-C 40	8	28.0	40.0	60	37	30.0	4241 8.000	4912 4.000	0.5	4295 8.040
HSK-C 40	10	30.0	40.0	65	41	35.0	4241 8.000	4912 4.000	0.5	4295 10.040
HSK-C 40	12	32.0	40.0	70	46	40.0	4241 8.000	4912 4.000	0.6	4295 12.040
HSK-C 50	6	26.0	50.0	60	37	30.0	4241 8.000	4912 4.000	0.6	4295 6.050
HSK-C 50	8	28.0	50.0	60	37	30.0	4241 10.002	4912 5.000	0.6	4295 8.050
HSK-C 50	10	30.0	50.0	65	41	35.5	4241 10.002	4912 5.000	0.6	4295 10.050
HSK-C 50	12	32.0	50.0	75	46	45.0	4241 10.002	4912 5.000	0.8	4295 12.050
HSK-C 50	14	34.0	50.0	75	46	45.0	4241 10.002	4912 5.000	0.9	4295 14.050
HSK-C 50	16	38.0	50.0	80	49	50.0	4241 10.002	4912 5.000	0.9	4295 16.050
HSK-C 50	18	40.0	50.0	80	49	50.0	4241 10.002	4912 5.000	1.0	4295 18.050
HSK-C 50	20	42.0	50.0	80	51	50.0	4241 10.001	4912 5.000	1.0	4295 20.050
HSK-C 63	6	26.0	50.0	60	37	26.0	4241 10.002	4912 5.000	1.0	4295 6.063
HSK-C 63	8	28.0	50.0	60	37	26.0	4241 10.002	4912 5.000	1.1	4295 8.063
HSK-C 63	10	30.0	50.0	65	41	32.0	4241 10.002	4912 5.000	1.1	4295 10.063
HSK-C 63	12	32.0	50.0	75	46	42.5	4241 10.002	4912 5.000	1.1	4295 12.063
HSK-C 63	14	34.0	50.0	75	46	43.0	4241 10.002	4912 5.000	1.1	4295 14.063
HSK-C 63	16	38.0	50.0	80	49	49.0	4241 10.002	4912 5.000	1.2	4295 16.063
HSK-C 63	18	40.0	50.0	80	49	50.0	4241 10.002	4912 5.000	1.2	4295 18.063
HSK-C 63	20	42.0	50.0	80	51	50.5	4241 10.001	4912 5.000	1.2	4295 20.063
HSK-C 63	25	57.0	63.0	95	57	59.5	4241 12.000	4912 6.000	1.8	4295 25.063
HSK-C 63	32	62.5	63.0	100	61	60.0	4241 12.000	4912 6.000	2.3	4295 32.063



Product information:

- ISO taper to DIN ISO 7388-1 form AD/AF
- balancing quality: G 2.5 / 25,000 rpm or rev. < 1 gmm
- for tool shanks d1 h6
- axial length adjustment
- holes for AF form closed with threaded pins on delivery

Scope of delivery:

- incl. adjusting screw (1) art. no. 4900
- incl. clamping screw (2) art. no. 4241

suitable accessories separately available:

- ISO pull studs art. no. 4925, 4926
- replacement adjusting screw (1), art. no. 4900
- replacement clamping screw (2) art. no. 4241
- hexagonal key (2), art. no. 4912

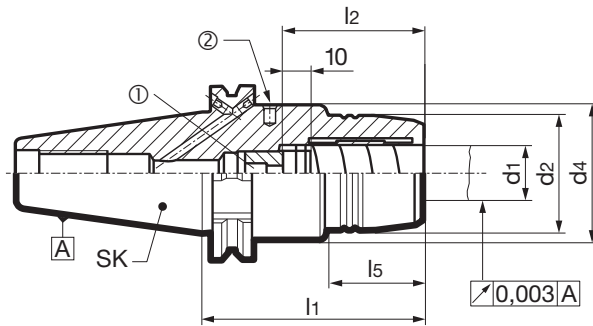

Article no.

4213

SK	d1 mm	d2 mm	d4 mm	l1 mm	l2 mm	l5 mm	①	②	②	kg	Order no.
SK 40	6	26.0	49.5	80.5	37.0	29.5	4900 6.014	4241 10.002	4912 5.000	1.2	4213 6.040
SK 40	8	28.0	49.5	80.5	37.0	30.0	4900 8.014	4241 10.002	4912 5.000	1.2	4213 8.040
SK 40	10	30.0	49.5	80.5	41.0	31.0	4900 10.014	4241 10.002	4912 5.000	1.3	4213 10.040
SK 40	12	32.0	49.5	80.5	46.0	31.5	4900 12.014	4241 10.002	4912 5.000	1.3	4213 12.040
SK 40	14	34.0	49.5	80.5	46.0	31.5	4900 12.014	4241 10.002	4912 5.000	1.3	4213 14.040
SK 40	16	38.0	49.5	80.5	49.0	33.0	4900 16.014	4241 10.002	4912 5.000	1.3	4213 16.040
SK 40	18	40.0	49.5	80.5	49.0	33.0	4900 16.014	4241 10.002	4912 5.000	1.3	4213 18.040
SK 40	20	49.5	49.5	64.5	51.0	45.4	4900 20.114	4241 10.001	4912 5.000	1.7	4213 20.040
SK 40	20	42.0	49.5	80.5	51.0	34.0	4900 20.114	4241 10.001	4912 5.000	1.3	4213 20.140
SK 40	20	42.0	49.5	110.0	51.0	34.0	4900 20.114	4241 10.001	4912 5.000	1.7	4213 20.240
SK 40	25	49.5	49.5	80.5	57.0	61.4	4900 20.114	4241 12.000	4912 6.000	1.3	4213 25.040
SK 40	32	63.0	80.0	80.5	61.0	25.5	4900 20.114	4241 12.000	4912 6.000	1.8	4213 32.040
SK 50	12	32.0	49.5	80.5	46.0	31.5	4900 12.014	4241 10.002	4912 5.000	3.1	4213 12.050
SK 50	20	42.0	49.5	80.5	51.0	34.0	4900 20.114	4241 10.001	4912 5.000	3.1	4213 20.050
SK 50	20	42.0	49.5	110.0	51.0	34.0	4900 20.114	4241 10.001	4912 5.000	3.6	4213 20.150
SK 50	32	72.0	72.0	81.0	61.0	61.9	4900 20.114	4241 12.000	4912 6.000	3.8	4213 32.050



ISO taper hydraulic chucks

Article no. 4663



Product information:

- ISO taper to DIN ISO 7388-1 form AD/AF
- balancing quality: G 2.5 / 25,000 rpm or rev. < 1 gmm
- for tool shanks d1 h6
- axial length adjustment

Scope of delivery:

- incl. adjusting screw (1) art. no. 4900
- incl. clamping screw (2) art. no. 4241

suitable accessories separately available:

- ISO pull studs art. no. 4925, 4926
- replacement adjusting screw (1), art. no. 4900
- replacement clamping screw (2) art. no. 4241
- hexagonal key (2), art. no. 4912

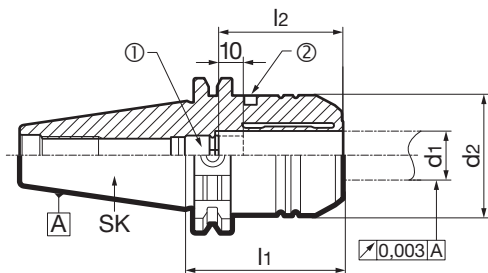

Article no.

4663

SK	d1 mm	d2 mm	l1 mm	l2 mm	①	②	②	kg
SK 40	20	49.3	64.5	51.0	4900 20.114	4241 10.001	4912 5.000	1.2

Order no.

4663 20.040



Product information:

- ISO taper to DIN ISO 7388-1 form AD/AF
- balancing quality: G 2.5 / 25,000 rpm or rev. < 1 gmm
- for tool shanks d1 h6
- axial length adjustment
- concentricity < 3 µm
l1 from 120 mm: max. 4 µm
l1 from 160 mm: = 5 µm

Scope of delivery:

- incl. adjusting screw (1) art. no. 4941
- incl. clamping screw (2) art. no. 4241

suitable accessories separately available:

- ISO pull studs art. no. 4925, 4926
- replacement adjusting screw (1), art. no. 4941
- replacement clamping screw (2) art. no. 4241
- hexagonal key (2), art. no. 4912

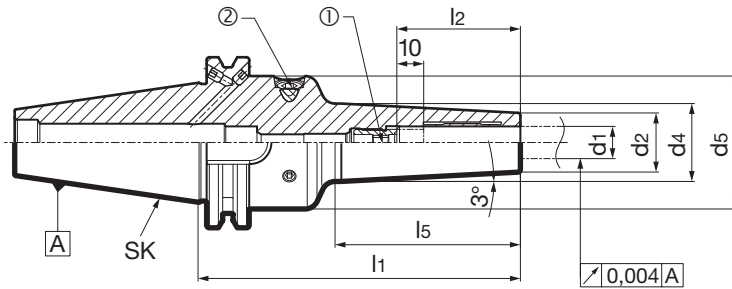

Article no.

4597

SK	d1 mm	d2 mm	d4 mm	d5 mm	l1 mm	l2 mm	l5 mm	①	②	②	kg	Order no.
SK 40	6	16	23.0	49.5	120	37	68.0	4941 6.041	4241 10.002	4912 5.000	1.3	4597 6.140
SK 40	8	18	25.0	49.5	120	37	68.0	4941 8.040	4241 10.002	4912 5.000	1.3	4597 8.140
SK 40	10	20	27.0	49.5	120	41	68.5	4941 10.050	4241 10.002	4912 5.000	1.3	4597 10.140
SK 40	12	22	29.0	49.5	120	46	69.0	4941 12.100	4241 10.002	4912 5.000	1.4	4597 12.140
SK 40	14	24	31.0	49.5	120	46	69.0	4941 14.100	4241 10.002	4912 5.000	1.4	4597 14.140
SK 40	16	26	33.0	49.5	120	49	69.5	4941 16.100	4241 10.002	4912 5.000	1.4	4597 16.140
SK 40	18	28	35.0	49.5	120	49	70.0	4941 18.100	4241 10.002	4912 5.000	1.4	4597 18.140
SK 40	20	30	37.0	49.5	120	51	70.0	4941 20.100	4241 10.002	4912 5.000	1.5	4597 20.140
SK 40	6	16	27.3	49.5	160	37	109.0	4941 6.041	4241 10.002	4912 5.000	1.4	4597 6.240
SK 40	8	18	29.3	49.5	160	37	109.0	4941 8.040	4241 10.002	4912 5.000	1.5	4597 8.240
SK 40	10	20	31.4	49.5	160	41	110.0	4941 10.050	4241 10.002	4912 5.000	1.5	4597 10.240
SK 40	12	22	33.5	49.5	160	46	111.0	4941 12.100	4241 10.002	4912 5.000	1.6	4597 12.240
SK 40	14	24	35.6	49.5	160	46	112.0	4941 14.100	4241 10.002	4912 5.000	1.7	4597 14.240
SK 40	16	26	37.6	49.5	160	49	112.0	4941 16.100	4241 10.002	4912 5.000	1.7	4597 16.240
SK 40	18	28	39.8	49.5	160	49	114.0	4941 18.100	4241 10.002	4912 5.000	1.8	4597 18.240
SK 40	20	30	41.8	49.5	160	51	114.0	4941 20.100	4241 10.002	4912 5.000	1.8	4597 20.240



ISO taper hydraulic chucks HMC 3000

Article no. 4619



Product information:

- ISO taper to DIN ISO 7388-1 form AD/AF
- balancing quality: G 2.5 / 25,000 rpm or rev. < 1 gmm
- perfect concentricity: < 3 µm bei 10xd1
- high clamping force
- quick, easy handling and precise length adjustment only possible from the front
- IC and Gührojet peripheral cooling ensure optimal chip removal and tool lubrication
- for tool shanks d1 h6
- for small clamping diameters

Scope of delivery:

- incl. adjusting screw

suitable accessories separately available:

- ISO pull studs art. no. 4925, 4926
- replacement clamping screw (2) art. no. 4241
- hexagonal key (2), art. no. 4912

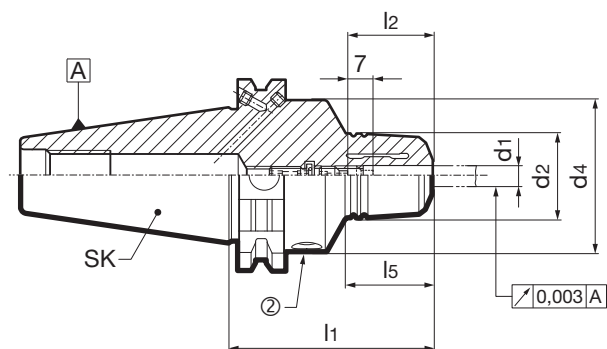

Article no.

4619

SK	d1 mm	d2 mm	d4 mm	l1 mm	l2 mm	l5 mm	②	②	kg
SK 40	3	28.0	49.5	84	34	34.0	4241 10.002	4912 5.000	0.5
SK 40	4	28.0	49.5	84	34	34.0	4241 10.002	4912 5.000	0.5
SK 40	5	28.0	49.5	84	34	34.0	4241 10.002	4912 5.000	0.5

Order no.
4619 3.040
4619 4.040
4619 5.040



Product information:

- MAS/BT to DIN ISO 7388-2 Form JD/JF
- BT30 in JD design without coolant supply via the collar
- balancing quality: G 2.5 / 25,000 rpm or rev. < 1 gmm
- for tool shanks d1 h6
- axial length adjustment

Scope of delivery:

- incl. adjusting screw (1) art. no. 4900
- incl. clamping screw (2) art. no. 4241

suitable accessories separately available:

- BT pull studs art. nr. 4927, 4928
- replacement adjusting screw (1), art. no. 4900
- replacement clamping screw (2) art. no. 4241
- hexagonal key (2), art. no. 4912

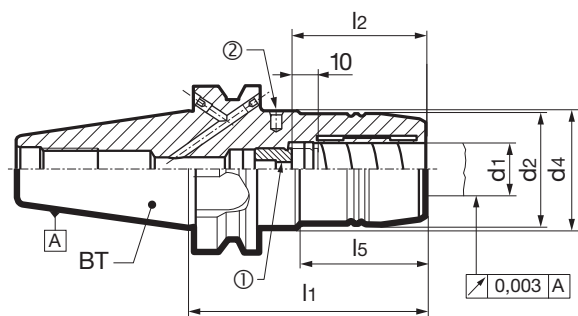

Article no.

4221

BT	d1 mm	d2 mm	d4 mm	l1 mm	l2 mm	l5 mm	①	②	②	kg	Order no.
BT 30	6	26.0	26.0	51.0	37.0		4900 6.014	4241 8.000	4912 4.000	0.4	4221 6.030
BT 30	8	28.0	28.0	51.0	37.0		4900 8.014	4241 8.000	4912 4.000	0.4	4221 8.030
BT 30	10	30.0	30.0	51.0	41.0		4900 10.014	4241 8.000	4912 4.000	0.4	4221 10.030
BT 30	12	32.0	32.0	51.0	46.0	19.5	4900 12.014	4241 8.000	4912 4.000	0.5	4221 12.030
BT 30	16	38.0	38.0	90.0	49.0	50.0	4900 16.014	4241 8.000	4912 4.000	0.8	4221 16.030
BT 30	20	42.0	42.0	90.0	51.0	50.0	4900 8.014	4241 10.001	4912 5.000	0.9	4221 20.030
BT 40	6	26.0	44.5	90.0	37.0	43.0	4900 6.014	4241 10.002	4912 5.000	1.2	4221 6.040
BT 40	8	28.0	44.5	90.0	37.0	44.5	4900 8.014	4241 10.002	4912 5.000	1.3	4221 8.040
BT 40	10	30.0	44.5	90.0	41.0	44.5	4900 10.014	4241 10.001	4912 5.000	1.3	4221 10.040
BT 40	12	32.0	44.5	90.0	46.0	44.5	4900 12.014	4241 10.001	4912 5.000	1.3	4221 12.040
BT 40	14	34.0	44.5	90.0	46.0	44.5	4900 12.014	4241 10.002	4912 5.000	1.3	4221 14.040
BT 40	16	38.0	44.5	90.0	49.0	47.5	4900 16.014	4241 10.002	4912 5.000	1.3	4221 16.040
BT 40	18	40.0	44.5	90.0	49.0	47.5	4900 16.014	4241 10.002	4912 5.000	1.4	4221 18.040
BT 40	20	49.5	49.5	72.5	51.0		4900 20.114	4241 10.001	4912 5.000	1.4	4221 20.040
BT 40	20	42.0	44.5	90.0	51.0	47.5	4900 20.114	4241 10,001	4912 5.000	1.4	4221 20.140
BT 40	25	49.5	49.5	83.0	57.0		4900 20.114	4241 12.000	4912 6.000	1.4	4221 25.040
BT 40	32	63.0	80.0	83.0	61.0	25.5	4900 20.114	4241 12.000	4912 6.000	1.9	4221 32.040
BT 50	12	32.0	44.5	90.0	46.0	34.0	4900 12.014	4241 10.002	4912 5.000	3.9	4221 12.050
BT 50	20	42.0	44.5	90.0	51.0	34.0	4900 20.114	4241 10.001	4912 5.000	3.9	4221 20.050
BT 50	32	72.0	72.0	90.0	61.0		4900 20.114	4241 12.000	4912 6.000	4.6	4221 32.050



MAS/BT hydraulic chucks

Article no. 4664



Product information:

- MAS/BT to DIN ISO 7388-2 Form JD/JF
- balancing quality: G 2.5 / 25,000 rpm or rev. < 1 gmm
- for tool shanks d1 h6
- axial length adjustment

Scope of delivery:

- incl. adjusting screw (1) art. no. 4900
- incl. clamping screw (2) art. no. 4241

suitable accessories separately available:

- BT pull studs art. nr. 4927, 4928
- replacement adjusting screw (1), art. no. 4900
- replacement clamping screw (2) art. no. 4241
- hexagonal key (2), art. no. 4912
- reduction bush art. no. 4665

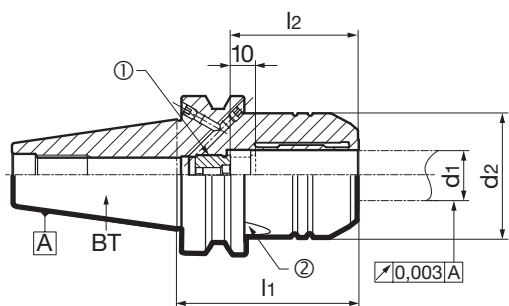

Article no.

4664

BT	d1 mm	d2 mm	l1 mm	l2 mm	①	②	②	kg	Order no.
BT 40	20	49.3	72.5	51.0	4900 20.114	4241 10.001	4912 5.000	1.2	4664 20.040



Product information:

- MAS/BT according to DIN ISO 7388-2 form JD/JF (AD/B)
- BT30 in JD design without coolant supply via the collar
- balancing quality: G 2.5 / 25,000 rpm or rev. < 1 gmm
- perfect concentricity: < 3 µm bei 10xd1
- high clamping force
- quick, easy handling and precise length adjustment only possible from the front
- IC and Gührojet peripheral cooling ensure optimal chip removal and tool lubrication
- for tool shanks d1 h6
- for small clamping diameters

Scope of delivery:

- incl. adjusting screw

suitable accessories separately available:

- BT pull studs art. nr. 4927, 4928
- replacement clamping screw (2) art. no. 4241
- hexagonal key (2), art. no. 4912

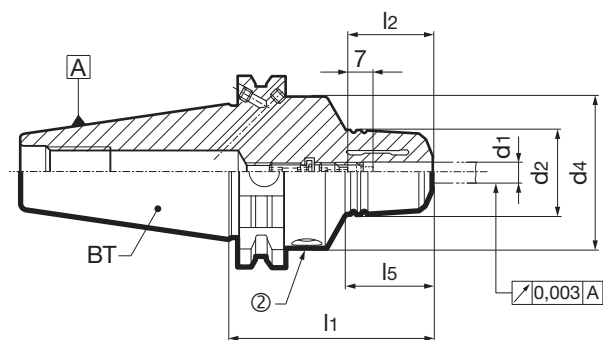

Article no. **4620**

BT	d1 mm	d2 mm	d4 mm	l1 mm	l2 mm	l5 mm	②	②	kg	Order no.
BT 30	3	28.0	28.0	55	34		4241 8.000	4912 4.000	0.6	4620 3.030
BT 30	4	28.0	28.0	55	34		4241 8.000	4912 4.000	0.6	4620 4.030
BT 30	5	28.0	28.0	55	34		4241 8.000	4912 4.000	0.4	4620 5.030
BT 40	3	28.0	44.5	94	34	48.5	4241 10.002	4912 5.000	0.6	4620 3.040
BT 40	4	28.0	44.5	94	34	48.5	4241 10.002	4912 5.000	0.6	4620 4.040
BT 40	5	28.0	44.5	94	34	48.5	4241 10.002	4912 5.000	0.6	4620 5.040



MAS/BT DC hydraulic chucks with axial plane

Article no. 4598



Product information:

- MAS/BT DC with axial plane, sim. ISO 7388-2, form JD
- balancing quality: G 2.5 / 25,000 rpm or rev. < 1 gmm
- for tool shanks d1 h6
- axial length adjustment

Scope of delivery:

- incl. adjusting screw (1) art. no. 4900
- incl. clamping screw (2) art. no. 4241

suitable accessories separately available:

- BT pull studs art. nr. 4927, 4928
- replacement adjusting screw (1), art. no. 4900
- replacement clamping screw (2) art. no. 4241
- hexagonal key (2), art. no. 4912

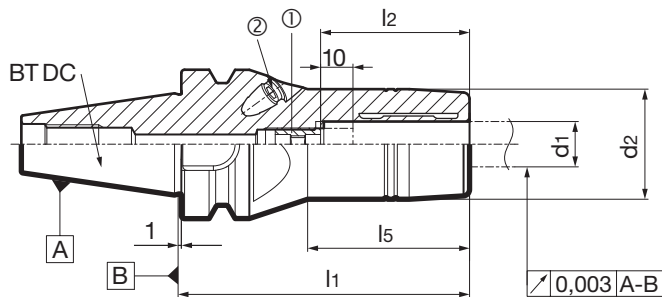

Article no. 4598

BT DC	d1 mm	d2 mm	l1 mm	l2 mm	l5 mm	①	②	②	kg	Order no.
BT 30	6	26.0	51	37	29.0	4900 6.014	4241 8.000	4912 4.000	0.4	4598 6.030
BT 30	8	28.0	51	37	29.0	4900 8.014	4241 8.000	4912 4.000	0.4	4598 8.030
BT 30	10	30.0	51	41	29.0	4900 10.014	4241 8.000	4912 4.000	0.5	4598 10.030
BT 30	12	32.0	51	46	19.5	4900 12.014	4241 8.000	4912 4.000	0.5	4598 12.030
BT 30	14	34.0	90	46	50.0	4900 12.014	4241 8.000	4912 4.000	0.8	4598 14.030
BT 30	16	38.0	90	49	50.0	4900 16.014	4241 8.000	4912 4.000	0.8	4598 16.030
BT 30	18	40.0	90	49	50.0	4900 16.014	4241 10.002	4912 5.000	0.9	4598 18.030
BT 30	20	42.0	90	51	50.0	4900 20.114	4241 10.002	4912 5.000	0.9	4598 20.030

Hydraulic chuck set

Article no. 4666

Product information:

- Case set 1, order no. 4666 20.063: Hydraulic chuck HSK-A 63, art. no. 4662
- Case set 2, order no. 4666 20.040: Hydraulic chuck SK 40, art. no. 4663
- Case set 3, order no. 4666 20.140: Hydraulic chuck MAS/BT 40, art. no. 4664
- further information can be found under the respective art. no.

Scope of delivery:

- 1 hydraulic chuck, 5 reduction bushes (Ø 6/8/10/12/16 mm), art. no. 4665, 1 clamping wrench, art. no. 4912, 1 adjusting screw, art. no. 4900

suitable accessories separately available:

- coolant supply set art. no. 4949
- ISO pull studs art. no. 4925, 4926
- BT pull studs art. nr. 4927, 4928
- replacement adjusting screw (1), art. no. 4900
- hexagonal key art. no. 4912



Article no. 4666

HSK/SK/BT	for shank Ø mm	Order no.
HSK-A 63	20.00	4666 20.063
SK 40	20.00	4666 20.040
BT 40	20.00	4666 20.140

Hydraulic chucks



Product information:

- for clamping smaller shank Ø in hydraulic chucks
- clamping-Ø for tool shank tolerance h6
- end face closed, therefore coolant-proof up to 80 bar
- concentricity $\leq 2 \mu\text{m}$
- with adjustable limit stop
- when applying reduction bushings, the permissible transferable torque can be increased by approx. 25% in contrast to direct clamping

Scope of delivery:

- incl. stop element

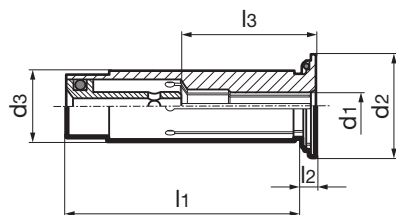

Article no.

4368

d3 mm	d1 mm	d2 mm	l1 mm	l2 mm	l3 mm	Order no.
12	3	16.5	45.0	2	25.5	4368 3.012
12	4	16.5	45.0	2	25.5	4368 4.012
12	5	16.5	45.0	2	25.5	4368 5.012
12	6	16.5	45.0	2	33.5	4368 6.012
12	8	16.5	45.0	2	33.5	4368 8.012
20	3	24.1	50.5	2	28.5	4368 3.020
20	4	24.1	50.5	2	28.5	4368 4.020
20	5	24.1	50.5	2	28.5	4368 5.020
20	6	24.1	50.5	2	37.5	4368 6.020
20	7	24.1	50.5	2	37.5	4368 7.020
20	8	24.1	50.5	2	37.5	4368 8.020
20	9	24.1	50.5	2	42.5	4368 9.020
20	10	24.1	50.5	2	42.5	4368 10.020
20	11	24.1	50.5	2	42.5	4368 11.020
20	12	24.1	50.5	2	47.5	4368 12.020
20	13	24.1	50.5	2	47.5	4368 13.020
20	14	24.1	50.5	2	47.5	4368 14.020
20	15	24.1	50.5	2	47.5	4368 15.020
20	16	24.1	50.5	2	47.5	4368 16.020
32	6	35.5	60.5	3	34.5	4368 6.032
32	8	35.5	60.5	3	34.5	4368 8.032
32	10	35.5	60.5	3	39.5	4368 10.032
32	12	35.5	60.5	3	41.5	4368 12.032
32	14	35.5	60.5	3	41.5	4368 14.032
32	16	35.5	60.5	3	49.5	4368 16.032
32	18	35.5	60.5	3	49.5	4368 18.032
32	20	35.5	60.5	3	49.5	4368 20.032
32	25	35.5	60.5	3	57.5	4368 25.032

Hydraulic chucks



Reduction bushes GÜHROJET for hydraulic chucks

Article no. 4369



Product information:

- for clamping smaller shank Ø in hydraulic chucks
- clamping-Ø for tool shank tolerance h6
- with coolant slots for peripheral cooling, therefore process and tool life improvement
- concentricity $\leq 2 \mu\text{m}$
- when applying reduction bushings, the permissible transferable torque can be increased by approx. 25% in contrast to direct clamping
- with adjustable limit stop

Scope of delivery:

- incl. stop element

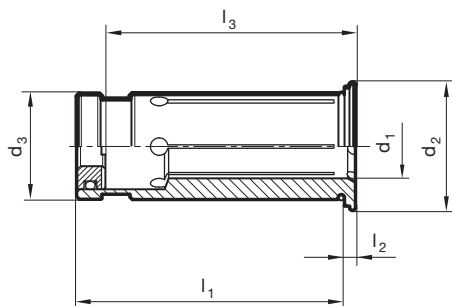

Article no.

4369

d3 mm	d1 mm	d2 mm	l1 mm	l2 mm	l3 mm	Order no.
12	3	16.5	45.0	2	25.5	4369 3.012
12	4	16.5	45.0	2	26.5	4369 4.012
12	5	16.5	45.0	2	26.5	4369 5.012
12	6	16.5	45.0	2	34.5	4369 6.012
12	8	16.5	45.0	2	34.5	4369 8.012
20	3	24.1	50.5	2	28.5	4369 3.020
20	4	24.1	50.5	2	28.5	4369 4.020
20	5	24.1	50.5	2	28.5	4369 5.020
20	6	24.1	50.5	2	37.5	4369 6.020
20	7	24.1	50.5	2	37.5	4369 7.020
20	8	24.1	50.5	2	37.5	4369 8.020
20	9	24.1	50.5	2	42.5	4369 9.020
20	10	24.1	50.5	2	42.5	4369 10.020
20	11	24.1	50.5	2	42.5	4369 11.020
20	12	24.1	50.5	2	47.5	4369 12.020
20	13	24.1	50.5	2	47.5	4369 13.020
20	14	24.1	50.5	2	47.5	4369 14.020
20	15	24.1	50.5	2	47.5	4369 15.020
20	16	24.1	50.5	2	47.5	4369 16.020
32	6	35.5	60.5	3	35.5	4369 6.032
32	8	35.5	60.5	3	35.5	4369 8.032
32	10	35.5	60.5	3	40.5	4369 10.032
32	12	35.5	60.5	3	42.5	4369 12.032
32	14	35.5	60.5	3	42.5	4369 14.032
32	16	35.5	60.5	3	49.5	4369 16.032
32	18	35.5	60.5	3	49.5	4369 18.032
32	20	35.5	60.5	3	49.5	4369 20.032
32	25	35.5	60.5	3	57.5	4369 25.032

Hydraulic chucks



Reduction bushes, sealed, for hydraulic chucks

Article no. **4665**



Product information:

- for clamping smaller shank \varnothing in hydraulic chucks
- clamping- \varnothing for tool shank tolerance h6
- concentricity $\leq 5 \mu\text{m}$
- for a coolant pressure up to 80 bar

Scope of delivery:

- incl. stop element

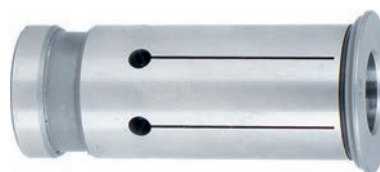
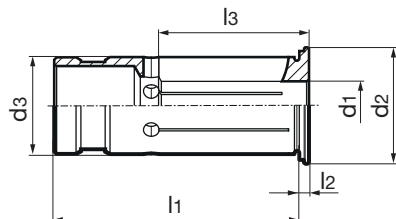

Article no.

4665

d3 mm	d1 mm	d2 mm	l1 mm	l2 mm	l3 mm	Order no.
20	6	24.0	50.5	2	27.0	4665 6.020
20	8	24.0	50.5	2	27.0	4665 8.020
20	10	24.0	50.5	2	31.0	4665 10.020
20	12	24.0	50.5	2	32.5	4665 12.020
20	16	24.0	50.5	2	35.0	4665 16.020

Extraction keys for reduction bushes

Article no. **4099**

Product information:

- for reduction bushes art. no. 4368 and 4369
- for the simple disassembly of reduction bushes

Hydraulic chucks



Article no.

4099

Size	Order no.
12-32	4099 1.000



Clamping force measuring instrument Senso 3000

Article no. **4038**

Product information:

- accurate, quick and simple measuring of the clamping force of hydraulic chucks
- mobility allows measuring within machines and fixtures
- determines clamping force via a pressure sensitive plug gauge
- indication as clamping force in percentage relative to the reference value

Scope of delivery:

- clamping force tester in sturdy case and instruction manual, incl. test mandrel, test report and battery type CR 2430

suitable accessories separately available:

- clamping force tester Senso 3000
- master recording on request



Article no. **4038**

Clamping diameter mm	Order no.
6	4038 6.000
8	4038 8.000
10	4038 10.000
12	4038 12.000
14	4038 14.000
16	4038 16.000
18	4038 18.000
20	4038 20.000
25	4038 25.000
32	4038 32.000



HSK-C universal length pre-setting adaptors

Article no. **4316**



Product information:

- HSK-C according to ISO 12164-1/DIN 69893-1
- for the application on pre-setting equipment for precise length pre-setting of axially adjustable chucks
- thanks to precise clamping also suitable for measuring and setting the diameter
- for HSK-A/C/E 50/63

suitable accessories separately available:

- plug inserts art. no. 4993

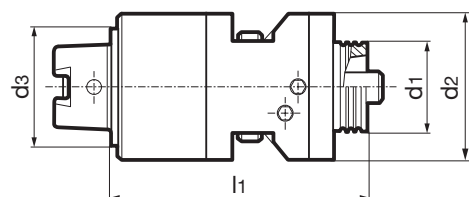

Article no.

4316

d3	d1	d2 mm	l1 mm	Order no.
HSK-C 63	HSK-A/C/E 50	63	104.5	4316 63.050
HSK-C 63	HSK-A/C/E 63	63	111.6	4316 63.063

ISO taper universal length pre-setting adaptors

Article no. **4319**



Product information:

- ISO taper to DIN ISO 7388-1
- for the application on pre-setting equipment for precise length pre-setting of axially adjustable chucks
- thanks to precise clamping also suitable for measuring and setting the diameter

suitable accessories separately available:

- plug inserts art. no. 4993

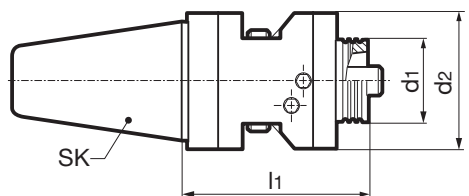

Article no.

4319

SK	d1	d2 mm	l1 mm	Order no.
SK 40	HSK-A/C/E 50	82	99.3	4319 40.050
SK 40	HSK-A/C/E 63	82	106.3	4319 40.063
SK 50	HSK-A/C/E 32	82	90.5	4319 50.032
SK 50	HSK-A/C/E 40	82	93.8	4319 50.040
SK 50	HSK-A/C/E 50	82	99.3	4319 50.050
SK 50	HSK-A/C/E 63	82	106.3	4319 50.063
SK 50	HSK-A/C/E 100	122	128.3	4319 50.100



Plug inserts

Article no. **4993**

Product information:

- for length pre-setting adaptors, art. no. 4316, 4319 and 4315

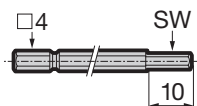

Article no.

4993

for	SW	Order no.
HSK-C	2.5/3/4/5/6	4993 100.000
HSK-A/E	2.5/3/4/5/6	4993 200.000
HSK-A(MMS)	3/4/5	4993 300.000



Clamping screws for hydraulic chucks and synchro tapping chucks

Article no. **4241**

Product information:

- replacement clamping screw for actuation of hydraulic chuck and hydro-synchronous chuck
- set screw spec. for hydraulic chucks to suit hex.key size
- tightening torque max. 10 Nm

suitable accessories separately available:

- hexagonal key art. no. 4912

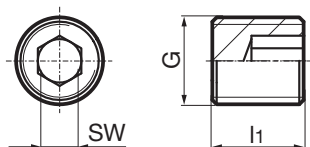

Article no. **4241**

G	l1 mm	SW mm	Order no.
M 8	10.0	4.0	4241 8.000
M 8	8.5	4.0	4241 8.001
M10	10.5	5.0	4241 10.001
M10	12.0	5.0	4241 10.002
M10	9.0	5.0	4241 10.003
M12	12.0	6.0	4241 12.000

Adjusting screws

Article no. **4900**

Product information:

- for hydraulic chucks
- for conventional internal cooling
- with plane stop for standard shank ends
- for HSK 32/40 with clamping-Ø 10.0 and 12.0 mm use code no. 8.014

suitable accessories separately available:

- hexagonal key art. no. 4912

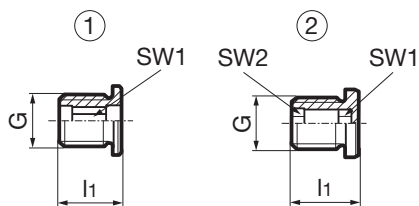

Article no. **4900**

for holder Ø	l1 mm	G	SW1 mm	SW2 mm	Order no.
6	14	M 5	2.5		4900 6.014
8	14	M 6	3.0		4900 8.014
10	14	M8 x 1	4.0		4900 10.014
12/14	14	M10X1	5.0		4900 12.014
16/18	14	M12X1	6.0		4900 16.014
20/25/32	14	M16X1	6.0		4900 20.014
20/25/32	14	M16X1	8.0	6.0	4900 20.114



MQL length pre-adjusting screws for conversion

Article no. **4919**

Product information:

- for hydraulic chucks and shrink fit chucks
- with special geometry optimised for MQL
- with tapered stop for MQL conical shank ends

suitable accessories separately available:

- hexagonal key art. no. 4912

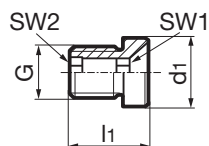

Article no. **4919**

d1 mm	l1 mm	G	SW1 mm	SW2 mm	Order no.
6	14.8	M 6	2.5	2.5	4919 6.000
8	15.6	M 6	3.0	3.0	4919 8.000
10	16.1	M 8X1	4.0	4.0	4919 10.000
10	16.6	M 6	3.0	3.0	4919 10.032
10	16.6	M 8X1	3.0	3.0	4919 10.040
12	16.6	M10X1	5.0	5.0	4919 12.000
12	17.6	M 6	3.0	3.0	4919 12.032
14	17.6	M10X1	5.0	5.0	4919 14.000
14	18.6	M 6	3.0	3.0	4919 14.040
16	18.6	M12X1	5.0	5.0	4919 16.000
16	19.6	M 6	3.0	3.0	4919 16.040
18	19.6	M12X1	5.0	5.0	4919 18.000
20	20.6	M16X1	5.0	5.0	4919 20.000
25	22.6	M16X1	8.0	6.0	4919 25.000
32	26.1	M16X1	8.0	6.0	4919 32.000



Product information:

- for hydraulic chucks according to DIN 69882-7
- for shrink fit chucks according to DIN 69882-8
- replaces conventional coolant supply sets, art. no. 4949, when applying MQL
- Please note: Not suitable for use in machines with delivery neck in accordance with DIN 69090-2, observe hole diameter d4

Scope of delivery:

- complete MQL coolant supply set consisting of: coolant pipe, cap nut, MQL tube and O-rings

suitable accessories separately available:

- socket wrench art. no. 4911

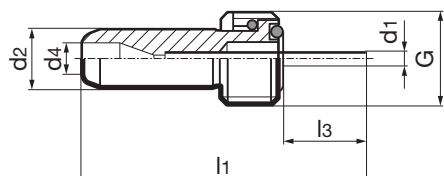

Article no. **4924**

for	d1 mm	d2 mm	d4 mm	l1 mm	l3 mm	G	Order no.
HSK-A 32	2.5	6	3.5	54.2	28.0	M10X1	4924 32.010
HSK-A 32	2.5	6	3.5	45.1	18.9	M10X1	4924 32.020
HSK-A 32	3.0	6	3.5	54.3	28.1	M10X1	4924 32.030
HSK-A 32	3.0	6	3.5	55.8	29.6	M10X1	4924 32.050
HSK-A 32	3.0	6	3.5	45.7	19.5	M10X1	4924 32.060
HSK-A 32	3.0	6	3.5	56.6	30.4	M10X1	4924 32.070
HSK-A 32	3.0	6	3.5	45.2	19.0	M10X1	4924 32.080
HSK-A 40	2.5	8	4.0	45.1	16.0	M12X1	4924 40.010
HSK-A 40	2.5	8	4.0	56.0	26.9	M12X1	4924 40.020
HSK-A 40	3.0	8	4.0	56.2	15.8	M12X1	4924 40.030
HSK-A 40	3.0	8	4.0	56.2	27.0	M12X1	4924 40.040
HSK-A 40	3.0	8	4.0	46.3	17.1	M12X1	4924 40.050
HSK-A 40	3.0	8	4.0	51.7	22.5	M12X1	4924 40.060
HSK-A 40	3.0	8	4.0	46.7	17.5	M12X1	4924 40.070
HSK-A 40	3.0	8	4.0	57.2	28.0	M12X1	4924 40.100
HSK-A 40	3.0	8	4.0	54.2	25.0	M12X1	4924 40.120
HSK-A 50	2.5	10	4.0	44.6	11.9	M16X1	4924 50.010
HSK-A 50	2.5	10	4.0	55.4	22.7	M16X1	4924 50.020
HSK-A 50	3.0	10	4.0	46.1	13.4	M16X1	4924 50.030
HSK-A 50	3.0	10	4.0	46.5	13.8	M16X1	4924 50.040
HSK-A 50	4.0	10	4.0	45.7	13.0	M16X1	4924 50.050
HSK-A 50	4.0	10	4.0	46.1	13.4	M16X1	4924 50.060
HSK-A 50	5.0	10	4.0	46.1	13.4	M16X1	4924 50.070
HSK-A 50	5.0	10	4.0	55.7	23.0	M16X1	4924 50.080
HSK-A 50	5.0	10	4.0	51.5	18.8	M16X1	4924 50.090
HSK-A 50	5.0	10	4.0	55.7	22.9	M16X1	4924 50.100
HSK-A 50	5.0	10	4.0	52.8	20.1	M16X1	4924 50.110
HSK-A 50	5.0	10	4.0	53.2	20.5	M16X1	4924 50.130
HSK-A 50	5.0	10	4.0	57.7	25.0	M16X1	4924 50.140
HSK-A 50	5.0	10	4.0	51.5	18.8	M16X1	4924 50.150
HSK-A 50	5.0	10	4.0	60.7	28.0	M16X1	4924 50.160
HSK-A 63	2.5	12	4.0	45.7	9.5	M18X1	4924 63.010
HSK-A 63	2.5	12	4.0	126.9	90.6	M18X1	4924 63.011
HSK-A 63	2.5	12	4.0	176.9	140.6	M18X1	4924 63.012
HSK-A 63	2.5	12	4.0	56.7	20.5	M18X1	4924 63.020
HSK-A 63	2.5	12	4.0	137.7	101.4	M18X1	4924 63.021
HSK-A 63	3.0	12	4.0	46.0	9.8	M18X1	4924 63.030
HSK-A 63	3.0	12	4.0	126.1	89.9	M18X1	4924 63.031
HSK-A 63	3.0	12	4.0	176.2	139.9	M18X1	4924 63.032
HSK-A 63	3.0	12	4.0	57.0	20.8	M18X1	4924 63.040
HSK-A 63	3.0	12	4.0	137.0	100.7	M18X1	4924 63.041
HSK-A 63	4.0	12	4.0	51.7	15.5	M18X1	4924 63.050
HSK-A 63	4.0	12	4.0	122.2	86.0	M18X1	4924 63.051
HSK-A 63	4.0	12	4.0	172.2	135.9	M18X1	4924 63.052
HSK-A 63	4.0	12	4.0	55.7	19.5	M18X1	4924 63.060
HSK-A 63	4.0	12	4.0	132.2	95.9	M18X1	4924 63.061
HSK-A 63	5.0	12	4.0	52.1	15.9	M18X1	4924 63.070
HSK-A 63	5.0	12	4.0	55.7	19.5	M18X1	4924 63.080
HSK-A 63	5.0	12	4.0	127.1	90.8	M18X1	4924 63.081
HSK-A 63	5.0	12	4.0	53.8	17.6	M18X1	4924 63.090
HSK-A 63	5.0	12	4.0	117.6	81.4	M18X1	4924 63.091
HSK-A 63	5.0	12	4.0	167.6	131.3	M18X1	4924 63.092
HSK-A 63	5.0	12	4.0	57.5	21.3	M18X1	4924 63.100
HSK-A 63	5.0	12	4.0	60.7	24.5	M18X1	4924 63.110

Hydraulic chucks



Article no.							4924
for	d1 mm	d2 mm	d4 mm	l1 mm	l3 mm	G	Order no.
HSK-A 63	5.0	12	4.0	114.3	78.0	M18X1	4924 63.111
HSK-A 63	6.0	12	4.0	77.0	40.8	M18X1	4924 63.120
HSK-A 63	6.0	12	4.0	69.0	32.8	M18X1	4924 63.130
HSK-A 63	5.0	12	4.0	114.6	78.3	M18X1	4924 63.131
HSK-A 63	5.0	12	4.0	164.6	128.3	M18X1	4924 63.132
HSK-A 63	6.0	12	4.0	70.7	34.5	M18X1	4924 63.140
HSK-A 63	5.0	12	4.0	124.3	88.0	M18X1	4924 63.141
HSK-A 63	5.0	12	4.0	112.9	76.6	M18X1	4924 63.151
HSK-A 63	5.0	12	4.0	162.9	126.6	M18X1	4924 63.152
HSK-A 63	5.0	12	4.0	122.1	85.8	M18X1	4924 63.161
HSK-A 63	6.0	12	4.0	116.2	79.9	M18X1	4924 63.181
HSK-A 63	6.0	12	4.0	112.2	75.9	M18X1	4924 63.201
HSK-A 80	2.5	14	4.0	44.8	5.5	M20X1.5	4924 80.010
HSK-A 80	2.5	14	4.0	61.2	21.9	M20X1.5	4924 80.020
HSK-A 80	3.0	14	4.0	44.9	5.6	M20X1.5	4924 80.030
HSK-A 80	3.0	14	4.0	61.3	22.0	M20X1.5	4924 80.040
HSK-A 80	4.0	14	4.0	50.9	11.6	M20X1.5	4924 80.050
HSK-A 80	4.0	14	4.0	61.3	22.0	M20X1.5	4924 80.060
HSK-A 80	5.0	14	4.0	51.3	12.0	M20X1.5	4924 80.070
HSK-A 80	5.0	14	4.0	51.6	12.3	M20X1.5	4924 80.090
HSK-A 80	5.0	14	4.0	61.3	22.0	M20X1.5	4924 80.100
HSK-A 80	5.0	14	4.0	57.9	18.6	M20X1.5	4924 80.110
HSK-A 80	5.0	14	4.0	58.3	19.0	M20X1.5	4924 80.130
HSK-A 80	5.0	14	4.0	63.3	24.0	M20X1.5	4924 80.140
HSK-A 80	5.0	14	4.0	56.6	17.3	M20X1.5	4924 80.150
HSK-A 80	5.0	14	4.0	66.3	78.0	M20X1.5	4924 80.160
HSK-A 80	6.0	14	4.0	53.1	13.8	M20X1.5	4924 80.170
HSK-A 80	6.0	14	4.0	70.3	78.0	M20X1.5	4924 80.180
HSK-A 80	6.0	14	4.0	77.2	37.9	M20X1.5	4924 80.190
HSK-A 80	6.0	14	4.0	71.3	78.0	M20X1.5	4924 80.200
HSK-A 100	2.5	16	4.0	53.0	9.2	M24X1.5	4924 100.010
HSK-A 100	2.5	16	4.0	63.9	78.0	M24X1.5	4924 100.020
HSK-A 100	3.0	16	4.0	53.7	9.9	M24X1.5	4924 100.030
HSK-A 100	3.0	16	4.0	64.6	78.0	M24X1.5	4924 100.040
HSK-A 100	4.0	16	4.0	63.3	19.5	M24X1.5	4924 100.050
HSK-A 100	4.0	16	4.0	63.3	78.0	M24X1.5	4924 100.060
HSK-A 100	5.0	16	4.0	63.8	20.0	M24X1.5	4924 100.070
HSK-A 100	5.0	16	4.0	64.2	20.4	M24X1.5	4924 100.090
HSK-A 100	5.0	16	4.0	63.3	78.0	M24X1.5	4924 100.100
HSK-A 100	5.0	16	4.0	65.4	21.6	M24X1.5	4924 100.110
HSK-A 100	5.0	16	4.0	65.8	22.0	M24X1.5	4924 100.130
HSK-A 100	5.0	16	4.0	65.3	78.0	M24X1.5	4924 100.140
HSK-A 100	5.0	16	4.0	69.2	25.4	M24X1.5	4924 100.150
HSK-A 100	5.0	16	4.0	68.3	78.0	M24X1.5	4924 100.160
HSK-A 100	6.0	16	4.0	68.6	24.8	M24X1.5	4924 100.170
HSK-A 100	6.0	16	4.0	72.3	78.0	M24X1.5	4924 100.180
HSK-A 100	6.0	16	4.0	64.6	20.8	M24X1.5	4924 100.190
HSK-A 100	6.0	16	4.0	73.3	78.0	M24X1.5	4924 100.200



Product information:

- HSK-A according to ISO 12164-1 / DIN 69893-1
- dimensions according to DIN 69882-8
- balancing quality: G 2.5 / 25,000 rpm or rev. < 1 gmm
- for tool shanks d1 h6
- concentricity < 3 µm
- l1 from 120 mm < 4 µm
- with axial damping screw for optimal concentricity
- design for 6xM6 balancing screws for maximum accuracy and running smoothness
- coating for protection against oxidation cleanliness and longevity
- safety colour ring for maximum operator safety

Scope of delivery:

- incl. adjusting screw with axial force damping (1), art. no. 4941 for conventional cooling

suitable accessories separately available:

- coolant supply set art. no. 4949
- replacement adjusting screw with axial force damping (1), art. no. 4941
- MQL version available on request

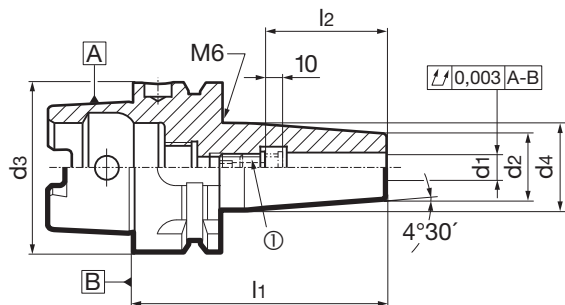

Article no. **4726**

d3	d1 mm	d2 mm	d4 mm	l1 mm	l2 mm	①	kg	Order no.
HSK-A 63	6	21	27.0	80	36	4941 6.100	1.0	4726 6.063
HSK-A 63	8	21	27.0	80	36	4941 8.100	1.0	4726 8.063
HSK-A 63	10	24	32.0	85	41	4941 10.100	1.0	4726 10.063
HSK-A 63	12	24	32.0	90	46	4941 12.100	0.9	4726 12.063
HSK-A 63	14	27	34.0	90	46	4941 14.100	1.0	4726 14.063
HSK-A 63	16	27	34.0	95	49	4941 16.100	1.0	4726 16.063
HSK-A 63	18	33	42.0	95	49	4941 18.100	1.0	4726 18.063
HSK-A 63	20	33	42.0	100	51	4941 20.100	1.0	4726 20.063
HSK-A 63	25	44	53.0	115	57	4941 25.100	2.0	4726 25.063
HSK-A 63	32	44	53.0	120	61	4941 32.100	2.0	4726 32.063
HSK-A 100	6	21	27.0	85	36	4941 6.100	2.0	4726 6.100
HSK-A 100	8	21	27.0	85	36	4941 8.100	2.0	4726 8.100
HSK-A 100	10	24	32.0	90	41	4941 10.100	2.0	4726 10.100
HSK-A 100	12	24	32.0	95	46	4941 12.100	2.0	4726 12.100
HSK-A 100	14	27	34.0	95	46	4941 14.100	2.0	4726 14.100
HSK-A 100	16	27	34.0	100	49	4941 16.100	2.0	4726 16.100
HSK-A 100	18	33	42.0	100	49	4941 18.100	2.5	4726 18.100
HSK-A 100	20	33	42.0	105	51	4941 20.100	2.5	4726 20.100
HSK-A 100	25	44	53.0	115	57	4941 25.100	3.0	4726 25.100
HSK-A 100	32	44	53.0	120	61	4941 32.100	3.0	4726 32.100



HSK-A shrink fit chucks

Article no. 4736



Product information:

- HSK-A according to ISO 12164-1 / DIN 69893-1
- dimensions according to DIN 69882-8
- balancing quality: G 2.5 / 25,000 rpm or rev. < 1 gmm
- for tool shanks d1 h6
- axial length adjustment
- balancing thread 4xM6/6xM6
- concentricity < 3 µm
l1 from 120 mm = 4 µm
l1 from 160 mm = 5 µm
l1 from 200 mm = 7 µm

Scope of delivery:

- incl. adjusting screw (1) art. no. 4977 or 4904

suitable accessories separately available:

- coolant supply set art. no. 4949
- replacement adjusting screw (1), art. no. 4977 or 4904

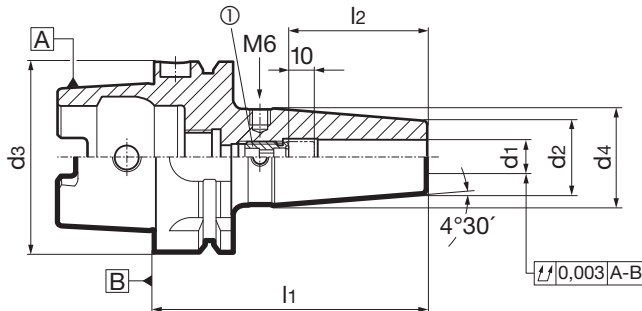

Article no.

4736

d3	d1 mm	d2 mm	d4 mm	l1 mm	l2 mm	①	kg	Order no.
HSK-A 32	6	21	26.0	70	36	4977 6.014	0.2	4736 6.032
HSK-A 32	8	21	26.0	70	36	4977 8.014	0.2	4736 8.032
HSK-A 32	10	24	30.0	75	41	4977 10.014	0.3	4736 10.032
HSK-A 32	12	24	30.0	80	46	4977 12.014	0.3	4736 12.032
HSK-A 40	6	21	27.0	80	36	4977 6.014	0.4	4736 6.040
HSK-A 40	8	21	27.0	80	36	4977 8.014	0.4	4736 8.040
HSK-A 40	10	24	32.0	80	41	4977 10.014	0.4	4736 10.040
HSK-A 40	12	24	32.0	90	46	4977 12.014	0.5	4736 12.040
HSK-A 40	14	27	34.0	90	46	4977 12.014	0.5	4736 14.040
HSK-A 40	16	27	34.0	90	49	4977 16.014	0.5	4736 16.040
HSK-A 40	18	33	42.0	95	49	4977 16.014	0.7	4736 18.040
HSK-A 40	20	33	42.0	100	51	4977 20.114	0.7	4736 20.040
HSK-A 50	6	21	27.0	80	36	4977 6.014	0.5	4736 6.050
HSK-A 50	8	21	27.0	80	36	4977 8.014	0.5	4736 8.050
HSK-A 50	10	24	32.0	85	41	4977 10.014	0.6	4736 10.050
HSK-A 50	12	24	32.0	90	46	4977 12.014	0.6	4736 12.050
HSK-A 50	14	27	34.0	90	46	4977 12.014	0.7	4736 14.050
HSK-A 50	16	27	34.0	95	49	4977 16.014	0.7	4736 16.050
HSK-A 50	18	33	42.0	95	49	4977 16.014	0.8	4736 18.050
HSK-A 50	20	33	42.0	100	51	4977 20.114	0.9	4736 20.050
HSK-A 63	3	10	18.0	80	30	4904 5.016	0.7	4736 3.063
HSK-A 63	4	10	18.0	80	35	4904 6.016	0.7	4736 4.063
HSK-A 63	5	10	18.0	80	40	4904 8.018	0.7	4736 5.063
HSK-A 63	6	21	27.0	80	36	4977 6.014	0.8	4736 6.063
HSK-A 63	8	21	27.0	80	36	4977 8.014	0.8	4736 8.063
HSK-A 63	10	24	32.0	85	41	4977 10.014	0.9	4736 10.063
HSK-A 63	12	24	32.0	90	46	4977 12.014	0.9	4736 12.063
HSK-A 63	14	27	34.0	90	46	4977 12.014	0.9	4736 14.063
HSK-A 63	16	27	34.0	95	49	4977 16.014	0.9	4736 16.063
HSK-A 63	18	33	42.0	95	49	4977 16.014	1.1	4736 18.063
HSK-A 63	20	33	42.0	100	51	4977 20.114	1.1	4736 20.063
HSK-A 63	25	44	53.0	115	57	4977 20.114	1.7	4736 25.063
HSK-A 63	32	44	53.0	120	61	4977 20.114	1.6	4736 32.063
HSK-A 63	3	10	31.1	160	30	4904 5.016	0.9	4736 103.063
HSK-A 63	4	10	31.1	160	35	4904 6.016	0.9	4736 104.063
HSK-A 63	5	10	31.1	160	40	4904 8.018	0.9	4736 105.063
HSK-A 63	6	21	27.0	160	36	4977 6.014	1.1	4736 106.063
HSK-A 63	8	21	27.0	160	36	4977 8.014	1.1	4736 108.063
HSK-A 63	10	24	32.0	160	41	4977 10.014	1.3	4736 110.063
HSK-A 63	12	24	32.0	160	46	4977 12.014	1.3	4736 112.063
HSK-A 63	14	27	34.0	160	46	4977 12.014	1.4	4736 114.063
HSK-A 63	16	27	34.0	160	49	4977 16.014	1.4	4736 116.063
HSK-A 63	18	33	42.0	160	49	4977 16.014	1.8	4736 118.063
HSK-A 63	20	33	42.0	160	51	4977 20.114	1.7	4736 120.063
HSK-A 63	25	44	53.0	160	57	4977 20.114	2.4	4736 125.063
HSK-A 63	32	44	53.0	160	61	4977 20.114	2.3	4736 132.063
HSK-A 63	3	10	25.0	120	30	4904 5.016	0.8	4736 203.063
HSK-A 63	4	10	25.0	120	35	4904 6.016	0.8	4736 204.063



Article no.

4736

d3	d1 mm	d2 mm	d4 mm	l1 mm	l2 mm	①	kg	Order no.
HSK-A 63	5	10	25.0	120	40	4904 8.018	0.8	4736 205.063
HSK-A 63	6	21	27.0	120	36	4977 6.014	0.9	4736 206.063
HSK-A 63	8	21	27.0	120	36	4977 8.014	0.9	4736 208.063
HSK-A 63	10	24	32.0	120	41	4977 10.014	1.1	4736 210.063
HSK-A 63	12	24	32.0	120	46	4977 12.014	1.0	4736 212.063
HSK-A 63	14	27	34.0	120	46	4977 12.014	1.1	4736 214.063
HSK-A 63	16	27	34.0	120	49	4977 16.014	1.1	4736 216.063
HSK-A 63	18	33	42.0	120	49	4977 16.014	1.4	4736 218.063
HSK-A 63	20	33	42.0	120	51	4977 20.114	1.3	4736 220.063
HSK-A 63	6	21	27.0	200	36	4977 6.014	1.3	4736 306.063
HSK-A 63	8	21	27.0	200	36	4977 8.014	1.3	4736 308.063
HSK-A 63	10	24	32.0	200	41	4977 10.014	1.5	4736 310.063
HSK-A 63	12	24	32.0	200	46	4977 12.014	1.5	4736 312.063
HSK-A 63	14	27	34.0	200	46	4977 12.014	1.7	4736 314.063
HSK-A 63	16	27	34.0	200	49	4977 16.014	1.6	4736 316.063
HSK-A 63	18	33	42.0	200	49	4977 16.014	2.2	4736 318.063
HSK-A 63	20	33	42.0	200	51	4977 20.114	2.2	4736 320.063
HSK-A 63	25	44	53.0	200	57	4977 20.114	3.1	4736 325.063
HSK-A 63	32	44	53.0	200	61	4977 20.114	2.9	4736 332.063
HSK-A 80	6	21	27.0	85	36	4977 6.014	1.2	4736 6.080
HSK-A 80	8	21	27.0	85	36	4977 8.014	1.2	4736 8.080
HSK-A 80	10	24	32.0	90	41	4977 10.014	1.3	4736 10.080
HSK-A 80	12	24	32.0	95	46	4977 12.014	1.3	4736 12.080
HSK-A 80	14	27	34.0	95	46	4977 12.014	1.4	4736 14.080
HSK-A 80	16	27	34.0	100	49	4977 16.014	1.4	4736 16.080
HSK-A 80	18	33	42.0	100	49	4977 16.014	1.6	4736 18.080
HSK-A 80	20	33	42.0	105	51	4977 20.114	1.6	4736 20.080
HSK-A 80	25	44	53.0	115	57	4977 20.114	2.2	4736 25.080
HSK-A 80	32	44	53.0	120	61	4977 20.114	2.1	4736 32.080
HSK-A 80	6	21	27.0	160	36	4977 6.014	1.5	4736 106.080
HSK-A 80	8	21	27.0	160	36	4977 8.014	1.5	4736 108.080
HSK-A 80	10	24	32.0	160	41	4977 10.014	1.7	4736 110.080
HSK-A 80	12	24	32.0	160	46	4977 12.014	1.7	4736 112.080
HSK-A 80	14	27	34.0	160	46	4977 12.014	1.8	4736 114.080
HSK-A 80	16	27	34.0	160	49	4977 16.014	1.8	4736 116.080
HSK-A 80	18	33	42.0	160	49	4977 16.014	2.2	4736 118.080
HSK-A 80	20	33	42.0	160	51	4977 20.114	2.2	4736 120.080
HSK-A 80	25	44	53.0	160	57	4977 20.114	2.9	4736 125.080
HSK-A 80	32	44	53.0	160	61	4977 20.114	2.7	4736 132.080
HSK-A 100	6	21	27.0	85	36	4977 6.014	2.1	4736 6.100
HSK-A 100	8	21	27.0	85	36	4977 8.014	2.1	4736 8.100
HSK-A 100	10	24	32.0	90	41	4977 10.014	2.2	4736 10.100
HSK-A 100	12	24	32.0	95	46	4977 12.014	2.2	4736 12.100
HSK-A 100	14	27	34.0	95	46	4977 12.014	2.3	4736 14.100
HSK-A 100	16	27	34.0	100	49	4977 16.014	2.3	4736 16.100
HSK-A 100	18	33	42.0	100	49	4977 16.014	2.5	4736 18.100
HSK-A 100	20	33	42.0	105	51	4977 20.114	2.5	4736 20.100
HSK-A 100	25	44	53.0	115	57	4977 20.114	3.0	4736 25.100
HSK-A 100	32	44	53.0	120	61	4977 20.114	2.9	4736 32.100
HSK-A 100	6	21	27.0	160	36	4977 6.014	2.4	4736 106.100
HSK-A 100	8	21	27.0	160	36	4977 8.014	2.4	4736 108.100
HSK-A 100	10	24	32.0	160	41	4977 10.014	2.6	4736 110.100
HSK-A 100	12	24	32.0	160	46	4977 12.014	2.6	4736 112.100
HSK-A 100	14	27	34.0	160	46	4977 12.014	2.7	4736 114.100
HSK-A 100	16	27	34.0	160	49	4977 16.014	2.7	4736 116.100
HSK-A 100	18	33	42.0	160	49	4977 16.014	3.1	4736 118.100
HSK-A 100	20	33	42.0	160	51	4977 20.114	3.1	4736 120.100
HSK-A 100	25	44	53.0	160	57	4977 20.114	3.8	4736 125.100
HSK-A 100	32	44	53.0	160	61	4977 20.114	3.6	4736 132.100
HSK-A 100	6	21	27.0	200	36	4977 6.014	2.6	4736 306.100
HSK-A 100	8	21	27.0	200	36	4977 8.014	2.6	4736 308.100
HSK-A 100	10	24	32.0	200	41	4977 10.014	2.9	4736 310.100
HSK-A 100	12	24	32.0	200	46	4977 12.014	2.9	4736 312.100
HSK-A 100	14	27	34.0	200	46	4977 12.014	3.0	4736 314.100
HSK-A 100	16	27	34.0	200	49	4977 16.014	3.0	4736 316.100
HSK-A 100	18	33	42.0	200	49	4977 16.014	3.5	4736 318.100
HSK-A 100	20	33	42.0	200	51	4977 20.114	3.5	4736 320.100
HSK-A 100	25	44	53.0	200	57	4977 20.114	4.5	4736 325.100
HSK-A 100	32	44	53.0	200	61	4977 20.114	4.3	4736 332.100

Shrink fit technology

HSK-A shrink fit chucks GÜHROJET with peripheral cooling
Article no. **4755**
GÜHROJET
Product information:

- HSK-A according to ISO 12164-1 / DIN 69893-1
- dimensions according to DIN 69882-8
- balancing quality: G 2.5 / 25,000 rpm or rev. < 1 gmm
- for tool shanks d1 h6
- axial length adjustment
- concentricity < 3 µm
l1 from 120 mm: = 4 µm
- balancing thread 4xM6/6xM6
- optimised cooling lubrication for tools without internal coolant
- good chip evacuation and increased process reliability
- coolant ducts: d1 = 6 - 10 mm with two coolant ducts, d1 = 12 - 32 mm with four coolant ducts

Scope of delivery:

- incl. adjusting screw (1) art. no. 4938

suitable accessories separately available:

- coolant supply set art. no. 4949
- replacement adjusting screw (1), art. no. 4938

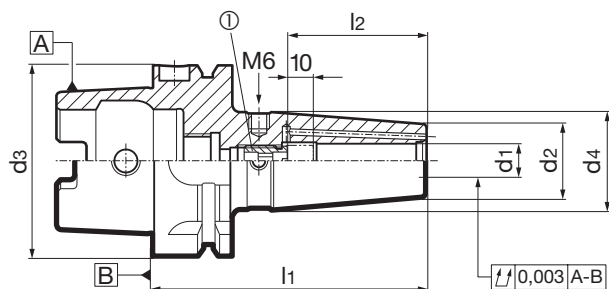

Article no.

4755

d3	d1 mm	d2 mm	d4 mm	l1 mm	l2 mm	①	kg	Order no.
HSK-A 40	6	21	27.0	80	36	4938 6.000	0.5	4755 6.040
HSK-A 40	8	21	27.0	80	36	4938 8.000	0.5	4755 8.040
HSK-A 40	10	24	32.0	80	41	4938 10.000	0.5	4755 10.040
HSK-A 40	12	24	32.0	90	46	4938 12.000	0.5	4755 12.040
HSK-A 40	14	27	33.5	90	46	4938 12.000	0.5	4755 14.040
HSK-A 40	16	27	33.5	90	49	4938 16.000	0.5	4755 16.040
HSK-A 50	6	21	27.0	80	36	4938 6.000	0.6	4755 6.050
HSK-A 50	8	21	27.0	80	36	4938 8.000	0.6	4755 8.050
HSK-A 50	10	24	32.0	85	41	4938 10.000	0.6	4755 10.050
HSK-A 50	12	24	32.0	90	46	4938 12.000	0.7	4755 12.050
HSK-A 50	14	27	34.0	90	46	4938 12.000	0.7	4755 14.050
HSK-A 50	16	27	34.0	95	49	4938 16.000	0.7	4755 16.050
HSK-A 50	18	33	41.5	95	49	4938 16.000	0.9	4755 18.050
HSK-A 50	20	33	41.5	100	51	4938 20.000	0.9	4755 20.050
HSK-A 63	6	21	27.0	80	36	4938 6.000	0.8	4755 6.063
HSK-A 63	8	21	27.0	80	36	4938 8.000	0.8	4755 8.063
HSK-A 63	10	24	32.0	85	41	4938 10.000	0.9	4755 10.063
HSK-A 63	12	24	32.0	90	46	4938 12.000	0.9	4755 12.063
HSK-A 63	14	27	34.0	90	46	4938 12.000	1.0	4755 14.063
HSK-A 63	16	27	34.0	95	49	4938 16.000	1.0	4755 16.063
HSK-A 63	18	33	42.0	95	49	4938 16.000	1.2	4755 18.063
HSK-A 63	20	33	42.0	100	51	4938 20.000	1.2	4755 20.063
HSK-A 63	6	21	27.0	120	36	4938 6.000	0.9	4755 206.063
HSK-A 63	8	21	27.0	120	36	4938 8.000	1.0	4755 208.063
HSK-A 63	10	24	32.0	120	41	4938 10.000	1.1	4755 210.063
HSK-A 63	12	24	32.0	120	46	4938 12.000	1.2	4755 212.063
HSK-A 63	14	27	34.0	120	46	4938 12.000	1.2	4755 214.063
HSK-A 63	16	27	34.0	120	49	4938 16.000	1.1	4755 216.063
HSK-A 63	18	33	42.0	120	49	4938 16.000	1.2	4755 218.063
HSK-A 63	20	33	42.0	120	51	4938 20.000	1.4	4755 220.063
HSK-A 100	6	21	27.0	85	36	4938 6.000	2.2	4755 6.100
HSK-A 100	8	21	27.0	85	36	4938 8.000	2.2	4755 8.100
HSK-A 100	10	24	32.0	90	41	4938 10.000	2.3	4755 10.100
HSK-A 100	12	24	32.0	95	46	4938 12.000	2.3	4755 12.100
HSK-A 100	14	27	34.0	95	46	4938 12.000	2.3	4755 14.100
HSK-A 100	16	27	34.0	100	49	4938 16.000	2.3	4755 16.100
HSK-A 100	18	33	42.0	100	49	4938 16.000	2.5	4755 18.100
HSK-A 100	20	33	42.0	105	51	4938 20.000	2.5	4755 20.100
HSK-A 100	25	44	53.0	115	57	4938 20.000	3.0	4755 25.100
HSK-A 100	32	44	53.0	120	61	4938 20.000	3.0	4755 32.100



Product information:

- HSK-A according to ISO 12164-1 / DIN 69893-1
- balancing quality: G 2.5 / 25,000 rpm or rev. < 1 gmm
- for carbide tool shanks in tolerance h6 (from d1 14 mm also HSS possible)
- axial length adjustment
- Concentricity < 3 µm
l1 up to 120 mm: max. 4 µm
l1 up to 160 mm: max. 5 µm

Scope of delivery:

- incl. adjusting screw (1) with axial force damping art. no. 4941 or 4904

suitable accessories separately available:

- coolant supply set art. no. 4949
- replacement adjusting screw with axial force damping (1), art. no. 4941 or 4904
- MQL version available on request

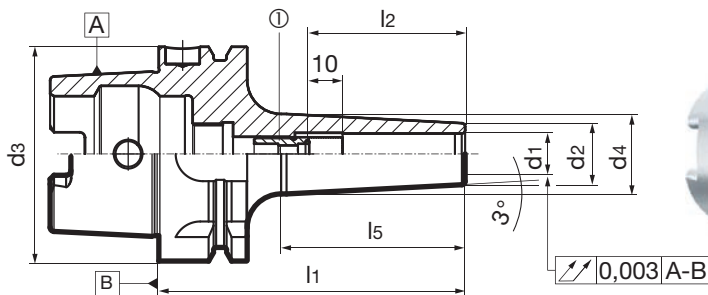

Article no.

4787

d3	d1 mm	d2 mm	d4 mm	l1 mm	l2 mm	l5 mm	①	kg	Order no.
HSK-A 63	3	9	13.0	80	30	40	4904 5.016	0.6	4787 3.063
HSK-A 63	4	10	14.0	80	35	41	4904 6.016	0.7	4787 4.063
HSK-A 63	5	11	15.0	80	40	41	4904 8.018	0.7	4787 5.063
HSK-A 63	6	12	16.0	80	36	42	4941 6.100	0.7	4787 6.063
HSK-A 63	8	14	18.0	80	36	42	4941 8.100	0.7	4787 8.063
HSK-A 63	10	16	21.0	85	41	49	4941 10.100	0.7	4787 10.063
HSK-A 63	12	18	23.5	90	46	54	4941 12.100	0.7	4787 12.063
HSK-A 63	14	20	25.5	90	46	54	4941 14.100	0.7	4787 14.063
HSK-A 63	16	22	28.0	95	49	59	4941 16.100	0.8	4787 16.063
HSK-A 63	18	24	30.0	95	49	59	4941 18.100	0.8	4787 18.063
HSK-A 63	20	26	32.5	100	51	64	4941 20.100	0.9	4787 20.063
HSK-A 63	3	9	17.0	120	30	80	4904 5.016	0.7	4787 3.163
HSK-A 63	4	10	18.0	120	35	81	4904 6.016	0.7	4787 4.163
HSK-A 63	5	11	19.0	120	40	81	4904 8.018	0.7	4787 5.163
HSK-A 63	6	12	20.5	120	36	82	4941 6.041	0.8	4787 6.163
HSK-A 63	8	14	22.5	120	36	82	4941 8.040	0.8	4787 8.163
HSK-A 63	10	16	24.5	120	41	82	4941 10.050	0.8	4787 10.163
HSK-A 63	12	18	26.5	120	46	83	4941 12.100	0.9	4787 12.163
HSK-A 63	14	20	28.5	120	46	83	4941 14.100	0.9	4787 14.163
HSK-A 63	16	22	30.5	120	49	83	4941 16.100	0.9	4787 16.163
HSK-A 63	18	24	32.7	120	49	84	4941 18.100	1.0	4787 18.163
HSK-A 63	20	26	34.7	120	51	85	4941 20.100	1.0	4787 20.163
HSK-A 63	3	9	21.5	160	30	121	4904 5.016	0.8	4787 3.263
HSK-A 63	4	10	22.5	160	35	121	4904 6.016	0.8	4787 4.263
HSK-A 63	5	11	23.5	160	40	121	4904 8.018	0.9	4787 5.263
HSK-A 63	6	12	24.5	160	36	122	4941 6.041	0.9	4787 6.263
HSK-A 63	8	14	26.5	160	36	122	4941 8.040	1.0	4787 8.263
HSK-A 63	10	16	28.5	160	41	122	4941 10.050	1.0	4787 10.263
HSK-A 63	12	18	30.5	160	46	123	4941 12.100	1.1	4787 12.263
HSK-A 63	14	20	32.8	160	46	124	4941 14.100	1.1	4787 14.263
HSK-A 63	16	22	34.8	160	49	125	4941 16.100	1.2	4787 16.263
HSK-A 63	18	24	37.0	160	49	126	4941 18.100	1.3	4787 18.263
HSK-A 63	20	26	39.0	160	51	127	4941 20.100	1.3	4787 20.263



HSK-C shrink fit chucks

Article no. 4758



Product information:

- HSK-C according to ISO 12164-1/DIN 69893-1
- dimensions according to DIN 69882-8
- balancing quality: G 2.5 / 25,000 rpm or rev. < 1 gmm
- for tool shanks d1 h6
- balancing thread 4xM6/6xM6
- concentricity < 3 µm

Scope of delivery:

- incl. adjusting screw (1) art. no. 4977

suitable accessories separately available:

- replacement adjusting screw (1), art. no. 4977

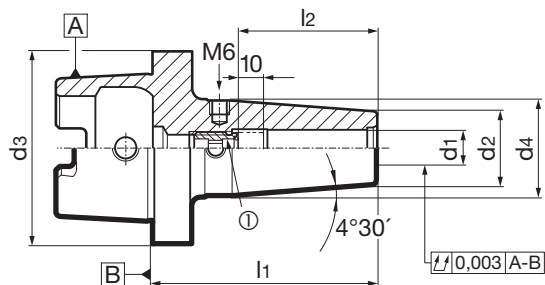

Article no.

4758

d3	d1 mm	d2 mm	d4 mm	l1 mm	l2 mm	①	kg	Order no.
HSK-C 32	6	21	26.0	65	36	4977 6.014	0.2	4758 6.032
HSK-C 32	8	21	26.0	65	36	4977 8.014	0.2	4758 8.032
HSK-C 32	10	24	30.0	65	41	4977 10.014	0.3	4758 10.032
HSK-C 32	12	24	32.0	75	46	4977 12.014	0.3	4758 12.032
HSK-C 40	6	21	30.0	70	36	4977 6.014	0.4	4758 6.040
HSK-C 40	8	21	30.0	70	36	4977 8.014	0.3	4758 8.040
HSK-C 40	10	24	32.7	70	41	4977 10.014	0.3	4758 10.040
HSK-C 40	12	24	34.1	80	46	4977 12.014	0.4	4758 12.040
HSK-C 40	14	27	37.2	80	46	4977 12.014	0.4	4758 14.040
HSK-C 40	16	27	37.2	80	49	4977 16.014	0.4	4758 16.040
HSK-C 50	6	21	30.0	70	36	4977 6.014	0.4	4758 6.050
HSK-C 50	8	21	47.0	70	36	4977 8.014	0.4	4758 8.050
HSK-C 50	10	24	33.0	75	41	4977 10.014	0.5	4758 10.050
HSK-C 50	12	24	34.0	80	46	4977 12.014	0.5	4758 12.050
HSK-C 50	14	27	37.0	80	46	4977 12.014	0.6	4758 14.050
HSK-C 50	16	27	38.5	85	49	4977 16.014	0.6	4758 16.050
HSK-C 50	18	33	44.5	85	49	4977 16.014	0.7	4758 18.050
HSK-C 50	20	33	45.0	90	51	4977 20.114	0.8	4758 20.050
HSK-C 63	6	21	29.2	70	36	4977 6.014	0.6	4758 6.063
HSK-C 63	8	21	29.2	70	36	4977 8.014	0.6	4758 8.063
HSK-C 63	10	24	33.0	75	41	4977 10.014	0.7	4758 10.063
HSK-C 63	12	24	34.0	80	46	4977 12.014	0.7	4758 12.063
HSK-C 63	14	27	36.0	80	46	4977 12.014	0.7	4758 14.063
HSK-C 63	16	27	36.0	85	49	4977 16.014	0.7	4758 16.063
HSK-C 63	18	33	43.5	85	49	4977 16.014	0.9	4758 18.063
HSK-C 63	20	33	44.3	90	51	4977 20.114	0.9	4758 20.063
HSK-C 63	25	44	53.0	100	57	4977 20.114	1.5	4758 25.063
HSK-C 63	32	44	53.0	110	61	4977 20.114	1.5	4758 32.063



HSK-E shrink fit chucks

Article no. **4737**



Product information:

- HSK-E according to DIN 69893-5 with access hole in taper for manual tool change
- balancing quality: G 2.5 / 25,000 rpm or rev. < 1 gmm
- for tool shanks d1 h6
- axial length adjustment
- concentricity < 3 µm

Scope of delivery:

- incl. adjusting screw (1) art. no. 4977 or 4904

suitable accessories separately available:

- coolant supply set art. no. 4949
- replacement adjusting screw (1), art. no. 4977 or 4904

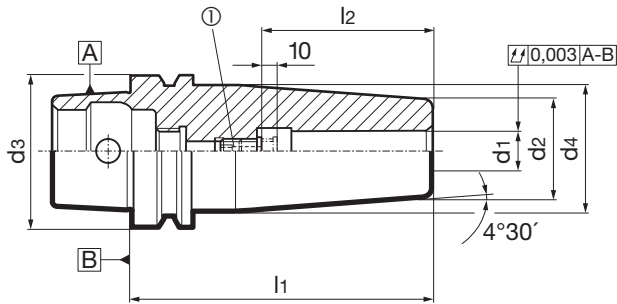

Article no.

4737

d3	d1 mm	d2 mm	d4 mm	l1 mm	l2 mm	①	kg	Order no.
HSK-E 32	3	10	15.9	60			0.1	4737 3.032
HSK-E 32	4	10	15.9	60			0.1	4737 4.032
HSK-E 32	5	10	15.9	60			0.1	4737 5.032
HSK-E 32	6	21	26.0	70	36	4977 6.014	0.1	4737 6.032
HSK-E 32	8	21	26.0	70	36	4977 8.014	0.2	4737 8.032
HSK-E 32	10	24	29.0	75	41	4977 10.014	0.2	4737 10.032
HSK-E 32	12	24	29.0	80	46	4977 12.014	0.2	4737 12.032
HSK-E 40	3	10	19.0	80			0.2	4737 3.040
HSK-E 40	4	10	19.0	80			0.2	4737 4.040
HSK-E 40	5	10	19.0	80			0.2	4737 5.040
HSK-E 40	6	21	27.0	80	36	4977 6.014	0.4	4737 6.040
HSK-E 40	8	21	27.0	80	36	4977 8.014	0.4	4737 8.040
HSK-E 40	10	24	32.0	80	41	4977 10.014	0.4	4737 10.040
HSK-E 40	12	24	32.0	90	46	4977 12.014	0.5	4737 12.040
HSK-E 40	14	27	34.0	90	46	4977 12.014	0.5	4737 14.040
HSK-E 40	16	27	34.0	90	49	4977 16.014	0.5	4737 16.040
HSK-E 50	3	10	18.0	80	30	4904 5.016	0.4	4737 3.050
HSK-E 50	4	10	18.0	80	35	4904 6.016	0.4	4737 4.050
HSK-E 50	5	10	18.0	80			0.4	4737 5.050
HSK-E 50	6	21	27.0	80	36	4977 6.014	0.5	4737 6.050
HSK-E 50	8	21	27.0	80	36	4977 8.014	0.5	4737 8.050
HSK-E 50	10	24	32.0	85	41	4977 10.014	0.5	4737 10.050
HSK-E 50	12	24	32.0	90	46	4977 12.014	0.6	4737 12.050
HSK-E 50	14	27	34.0	90	46	4977 12.014	0.7	4737 14.050
HSK-E 50	16	27	34.0	95	49	4977 16.014	0.7	4737 16.050
HSK-E 50	18	33	42.0	95	49	4977 16.014	0.9	4737 18.050
HSK-E 50	20	33	42.0	100	51	4977 20.114	0.9	4737 20.050
HSK-E 63	6	21	27.0	80	36	4977 6.014	0.8	4737 6.063
HSK-E 63	8	21	27.0	80	36	4977 8.014	0.8	4737 8.063
HSK-E 63	10	24	32.0	85	41	4977 10.014	0.9	4737 10.063
HSK-E 63	12	24	32.0	90	46	4977 12.014	0.9	4737 12.063
HSK-E 63	14	27	34.0	90	46	4977 12.014	1.0	4737 14.063
HSK-E 63	16	27	34.0	95	49	4977 16.014	1.0	4737 16.063
HSK-E 63	18	33	42.0	95	49	4977 16.014	1.1	4737 18.063
HSK-E 63	20	33	42.0	100	51	4977 20.114	1.2	4737 20.063
HSK-E 63	25	44	53.0	115	57	4977 20.114	1.8	4737 25.063
HSK-E 63	32	44	53.0	120	61	4977 20.114	1.7	4737 32.063

Shrink fit technology

HSK-E shrink fit chucks, slim design 3°
Article no. **4789**
Product information:

- HSK-E according to DIN 69893-5 with access hole in taper for manual tool change
- balancing quality: G 2.5 / 25,000 rpm or rev. < 1 gmm
- for carbide tool shanks in tolerance h6 (from d1 14 mm also HSS possible)
- axial length adjustment
- concentricity < 3 μm

Scope of delivery:

- incl. adjusting screw (1) art. no. 4904 or 4977

suitable accessories separately available:

- coolant supply set art. no. 4949
- replacement adjusting screw (1), art. no. 4904 or 4977

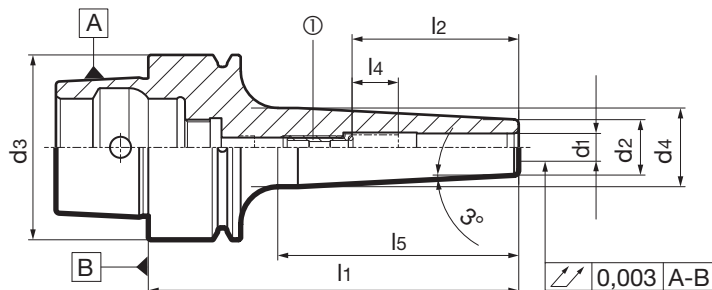

Article no.

4789

d3	d1 mm	d2 mm	d4 mm	l1 mm	l2 mm	l4 mm	l5 mm	①	kg	Order no.
HSK-E 40	3	9	12.0	60	30	10	30.0	4904 5.007	0.2	4789 3.040
HSK-E 40	4	10	13.0	60	35	10	31.0	4904 5.007	0.2	4789 4.040
HSK-E 40	5	11	14.0	60	36	10	31.0	4904 6.007	0.2	4789 5.040
HSK-E 40	6	12	15.0	60	36	5	32.0	4977 5.009	0.2	4789 6.040
HSK-E 40	8	14	17.0	60	36	5	32.0	4977 5.009	0.2	4789 8.040
HSK-E 40	10	16	19.5	60	38	5	34.0	4904 5.007	0.2	4789 10.040
HSK-E 40	12	18	21.5	60	40	3	34.5	4904 5.005	0.2	4789 12.040
HSK-E 40	3	9	14.0	80	30	10	50.0	4904 5.016	0.2	4789 3.140
HSK-E 40	4	10	15.0	80	35	10	51.0	4904 5.016	0.2	4789 4.140
HSK-E 40	5	11	16.0	80	40	10	51.0	4904 6.016	0.2	4789 5.140
HSK-E 40	6	12	17.0	80	36	10	52.0	4977 6.014	0.2	4789 6.140
HSK-E 40	8	14	19.0	80	36	10	52.5	4977 8.014	0.8	4789 8.140
HSK-E 40	10	16	21.5	80	41	10	54.0	4977 10.014	0.3	4789 10.140
HSK-E 40	12	18	23.5	80	46	10	55.0	4977 8.014	0.3	4789 12.140
HSK-E 50	3	9	13.0	80	30	10	40.0	4904 5.016	0.4	4789 3.050
HSK-E 50	4	10	14.0	80	35	10	41.0	4904 6.016	0.4	4789 4.050
HSK-E 50	5	11	15.0	80	40	10	41.0	4904 6.016	0.4	4789 5.050
HSK-E 50	6	12	16.0	80	36	10	42.0	4977 6.014	0.4	4789 6.050
HSK-E 50	8	14	18.0	80	36	10	42.0	4977 8.014	0.5	4789 8.050
HSK-E 50	10	16	20.5	80	41	10	44.0	4977 10.014	0.5	4789 10.050
HSK-E 50	12	18	22.5	80	46	10	44.5	4977 8.014	0.5	4789 12.050
HSK-E 50	14	20	24.5	80	46	10	45.5	4977 8.014	0.5	4789 14.050
HSK-E 50	16	22	26.5	80	49	10	46.5	4977 8.014	0.5	4789 16.050



Product information:

- ISO taper to DIN ISO 7388-1 form AD/AF
- balancing quality: G 2.5 / 25,000 rpm or rev. < 1 gmm
- for tool shanks d1 h6
- concentricity < 3 µm
- with axial damping screw for optimal concentricity
- design for 6xM6 balancing screws for maximum accuracy and running smoothness
- coating for protection against oxidation cleanliness and longevity
- safety colour ring for maximum operator safety

Scope of delivery:

- incl. adjusting screw with axial force damping (1), art. no. 4941 for conventional cooling

suitable accessories separately available:

- ISO pull studs art. no. 4925, 4926
- replacement adjusting screw with axial force damping (1), art. no. 4941
- MQL version available on request

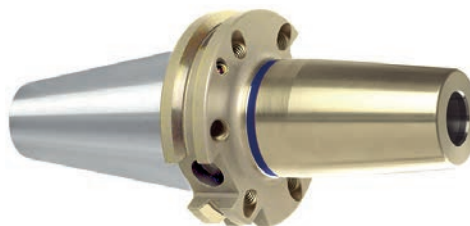
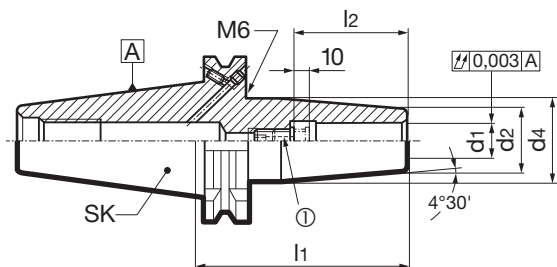

Article no.

4727

SK	d1 mm	d2 mm	d4 mm	l1 mm	l2 mm	①	kg	Order no.
SK 40	6	21	27.0	80	36	4941 6.041	1.0	4727 6.040
SK 40	8	21	27.0	80	36	4941 8.040	1.0	4727 8.040
SK 40	10	24	32.0	80	41	4941 10.050	1.0	4727 10.040
SK 40	12	24	32.0	80	46	4941 12.100	1.0	4727 12.040
SK 40	14	27	34.0	80	46	4941 14.100	1.0	4727 14.040
SK 40	16	27	34.0	80	49	4941 16.100	1.0	4727 16.040
SK 40	18	33	42.0	80	49	4941 18.100	1.0	4727 18.040
SK 40	20	33	42.0	80	51	4941 20.100	1.5	4727 20.040
SK 40	25	44	53.0	100	51	4941 25.100	1.5	4727 25.040
SK 40	32	44	53.0	100	61	4941 32.100	1.5	4727 32.040



ISO taper shrink fit chucks

Article no. 4738



Product information:

- ISO taper to DIN ISO 7388-1 form AD/AF
- balancing quality: G 2.5 / 25,000 rpm or rev. < 1 gmm
- for tool shanks d1 h6
- axial length adjustment
- balancing thread 4xM6/6xM6
- concentricity < 3 µm
- l1 from 120 mm = 4 µm
- l1 from 160 mm = 5 µm
- l1 from 200 mm = 7 µm

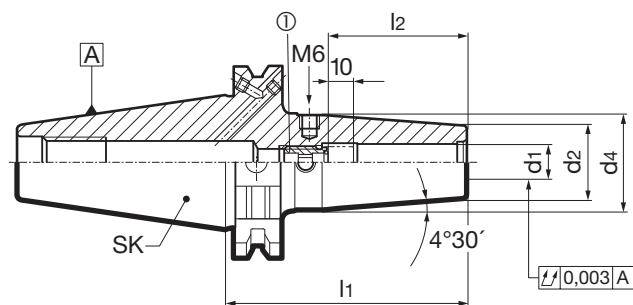

Scope of delivery:

- incl. adjusting screw (1) art. no. 4977 or 4904

suitable accessories separately available:

- ISO pull studs art. no. 4925, 4926
- replacement adjusting screw (1), art. no. 4977 or 4904

Article no.

4738

SK	d1 mm	d2 mm	d4 mm	l1 mm	l2 mm	①	kg	Order no.
SK 40	3	10	18.0	80	30	4904 5.016	0.9	4738 3.040
SK 40	4	10	18.0	80	35	4904 6.016	0.9	4738 4.040
SK 40	5	10	18.0	80	40	4904 8.018	0.9	4738 5.040
SK 40	6	21	27.0	80	36	4977 6.014	1.0	4738 6.040
SK 40	8	21	27.0	80	36	4977 8.014	1.0	4738 8.040
SK 40	10	24	32.0	80	41	4977 10.014	1.1	4738 10.040
SK 40	12	24	32.0	80	46	4977 12.014	1.0	4738 12.040
SK 40	14	27	34.0	80	46	4977 12.014	1.1	4738 14.040
SK 40	16	27	34.0	80	49	4977 16.014	1.1	4738 16.040
SK 40	18	33	42.0	80	49	4977 16.014	1.2	4738 18.040
SK 40	20	33	42.0	80	51	4977 20.114	1.5	4738 20.040
SK 40	25	44	53.0	100	57	4977 20.114	1.5	4738 25.040
SK 40	32	44	53.0	100	61	4977 20.114	1.5	4738 32.040
SK 40	3	10	31.0	160	30	4904 5.016	1.1	4738 103.040
SK 40	4	10	31.0	160	35	4904 6.016	1.1	4738 104.040
SK 40	5	10	31.0	160	40	4904 8.018	1.1	4738 105.040
SK 40	6	21	27.0	160	36	4977 6.014	1.3	4738 106.040
SK 40	8	21	27.0	160	36	4977 8.014	1.3	4738 108.040
SK 40	10	24	32.0	160	41	4977 10.014	1.5	4738 110.040
SK 40	12	24	32.0	160	46	4977 12.014	1.5	4738 112.040
SK 40	14	27	34.0	160	46	4977 12.014	1.7	4738 114.040
SK 40	16	27	34.0	160	49	4977 16.014	1.7	4738 116.040
SK 40	18	33	42.0	160	49	4977 16.014	1.9	4738 118.040
SK 40	20	33	42.0	160	51	4977 20.114	1.9	4738 120.040
SK 40	25	44	53.0	160	57	4977 20.114	2.2	4738 125.040
SK 40	3	10	24.0	120	30	4904 5.016	1.0	4738 203.040
SK 40	4	10	24.0	120	35	4904 6.016	1.0	4738 204.040
SK 40	5	10	24.0	120	40	4904 8.018	1.0	4738 205.040
SK 40	6	21	27.0	120	36	4977 6.014	1.1	4738 206.040
SK 40	8	21	27.0	120	36	4977 8.014	1.1	4738 208.040
SK 40	10	24	32.0	120	41	4977 10.014	1.2	4738 210.040
SK 40	12	24	32.0	120	46	4977 12.014	1.2	4738 212.040
SK 40	14	27	34.0	120	46	4977 12.014	1.4	4738 214.040
SK 40	16	27	34.0	120	49	4977 16.014	1.4	4738 216.040
SK 40	18	33	42.0	120	49	4977 16.014	1.5	4738 218.040
SK 40	20	33	42.0	120	51	4977 20.114	1.5	4738 220.040
SK 40	6	21	27.0	200	36	4977 6.014	1.6	4738 306.040
SK 40	8	21	27.0	200	36	4977 8.014	1.6	4738 308.040
SK 40	10	24	32.0	200	41	4977 10.014	1.8	4738 310.040
SK 40	12	24	32.0	200	46	4977 12.014	1.8	4738 312.040
SK 40	14	27	34.0	200	46	4977 12.014	2.1	4738 314.040
SK 40	16	27	34.0	200	49	4977 16.014	2.1	4738 316.040
SK 40	18	33	42.0	200	49	4977 16.014	2.3	4738 318.040
SK 40	20	33	42.0	200	51	4977 20.114	2.3	4738 320.040
SK 40	25	44	53.0	200	57	4977 20.114	2.6	4738 325.040
SK 40	32	44	53.0	200	61	4977 20.114	2.5	4738 332.040
SK 50	3	10	18.0	80	30	4904 5.016	2.6	4738 3.050
SK 50	4	10	18.0	80	35	4904 6.016	2.6	4738 4.050



Shrink fit chucks

Article no.

4738

SK	d1 mm	d2 mm	d4 mm	l1 mm	l2 mm	①	kg	Order no.
SK 50	5	10	18.0	80	40	4904 8.018	2.6	4738 5.050
SK 50	6	21	27.0	80	36	4977 6.014	2.9	4738 6.050
SK 50	8	21	27.0	80	36	4977 8.014	2.9	4738 8.050
SK 50	10	24	32.0	80	41	4977 10.014	2.9	4738 10.050
SK 50	12	24	32.0	80	46	4977 12.014	2.9	4738 12.050
SK 50	14	27	34.0	80	46	4977 12.014	3.0	4738 14.050
SK 50	16	27	34.0	80	49	4977 16.014	3.0	4738 16.050
SK 50	18	33	42.0	80	49	4977 16.014	3.0	4738 18.050
SK 50	20	33	42.0	80	51	4977 20.114	3.0	4738 20.050
SK 50	25	44	53.0	100	57	4977 20.114	3.6	4738 25.050
SK 50	32	44	53.0	100	61	4977 20.114	3.5	4738 32.050
SK 50	6	21	27.0	160	36	4977 6.014	3.1	4738 106.050
SK 50	8	21	27.0	160	36	4977 8.014	3.1	4738 108.050
SK 50	10	24	32.0	160	41	4977 10.014	3.4	4738 110.050
SK 50	12	24	32.0	160	46	4977 12.014	3.4	4738 112.050
SK 50	14	27	34.0	160	46	4977 12.014	3.7	4738 114.050
SK 50	16	27	34.0	160	49	4977 16.014	3.7	4738 116.050
SK 50	18	33	42.0	160	49	4977 16.014	4.1	4738 118.050
SK 50	20	33	42.0	160	51	4977 20.114	4.1	4738 120.050
SK 50	25	44	53.0	160	57	4977 20.114	4.7	4738 125.050
SK 50	32	44	53.0	160	61	4977 20.114	4.6	4738 132.050
SK 50	6	21	27.0	200	36	4977 6.014	3.4	4738 306.050
SK 50	8	21	27.0	200	36	4977 8.014	3.4	4738 308.050
SK 50	10	24	32.0	200	41	4977 10.014	3.7	4738 310.050
SK 50	12	24	32.0	200	46	4977 12.014	3.7	4738 312.050
SK 50	14	27	34.0	200	46	4977 12.014	4.0	4738 314.050
SK 50	16	27	34.0	200	49	4977 16.014	4.0	4738 316.050
SK 50	18	33	42.0	200	49	4977 16.014	4.4	4738 318.050
SK 50	20	33	42.0	200	51	4977 20.114	4.4	4738 320.050
SK 50	25	44	53.0	200	57	4977 20.114	5.0	4738 325.050
SK 50	32	44	53.0	200	61	4977 20.114	4.9	4738 332.050

Shrink fit technology



ISO taper shrink fit chucks GÜHROJET

Article no. 4729



GÜHROJET

Product information:

- ISO taper to DIN ISO 7388-1 form AD/AF
- balancing quality: G 2.5 / 25,000 rpm or rev. < 1 gmm
- for tool shanks d1 h6
- axial length adjustment
- concentricity < 3 µm
- incl. balancing thread 4xM6/6xM6
- optimised cooling lubrication for tools without internal coolant
- good chip evacuation and increased process reliability
- coolant ducts: d1 = 6 - 10 mm with two coolant ducts, d1 = 12 - 32 mm with four coolant ducts

Scope of delivery:

- incl. adjusting screw (1) art. no. 4977

suitable accessories separately available:

- ISO pull studs art. no. 4925, 4926
- replacement adjusting screw (1), art. no. 4977

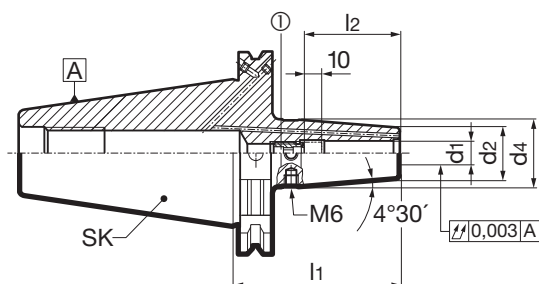

Article no.

4729

SK	d1 mm	d2 mm	d4 mm	l1 mm	l2 mm	①	kg	Order no.
SK 40	6	21	27.0	80	36	4977 6.014	1.0	4729 6.040
SK 40	8	21	27.0	80	36	4977 8.014	1.0	4729 8.040
SK 40	10	24	32.0	80	41	4977 10.014	1.1	4729 10.040
SK 40	12	24	32.0	80	46	4977 12.014	1.0	4729 12.040
SK 40	14	27	34.0	80	46	4977 12.014	1.1	4729 14.040
SK 40	16	27	34.0	80	49	4977 16.014	1.1	4729 16.040
SK 40	18	33	42.0	80	49	4977 16.014	1.2	4729 18.040
SK 40	20	33	42.0	80	51	4977 20.114	1.5	4729 20.040
SK 50	6	21	27.0	80	36	4977 6.014	2.8	4729 6.050
SK 50	8	21	27.0	80	36	4977 8.014	2.8	4729 8.050
SK 50	10	24	32.0	80	41	4977 10.014	2.8	4729 10.050
SK 50	12	24	32.0	80	46	4977 12.014	2.8	4729 12.050
SK 50	14	27	34.0	80	46	4977 12.014	2.8	4729 14.050
SK 50	16	27	34.0	80	49	4977 16.014	2.8	4729 16.050
SK 50	18	33	42.0	80	49	4977 16.014	3.0	4729 18.050
SK 50	20	33	42.0	80	51	4977 20.114	3.0	4729 20.050
SK 50	25	44	53.0	100	57	4977 20.114	3.5	4729 25.050
SK 50	32	44	53.0	100	61	4977 20.114	3.3	4729 32.050



Product information:

- ISO taper to DIN ISO 7388-1 form AD/AF
- balancing quality: G 2.5 / 25,000 rpm or rev. < 1 gmm
- for carbide tool shanks in tolerance h6 (from d1 14 mm also HSS possible)
- axial length adjustment
- Concentricity < 3 µm
l1 up to 120 mm: max. 4 µm
l1 up to 160 mm: max. 5 µm

Scope of delivery:

- incl. adjusting screw (1) art. no. 4904 or 4977

suitable accessories separately available:

- ISO pull studs art. no. 4925, 4926
- replacement adjusting screw (1), art. no. 4904 or 4977

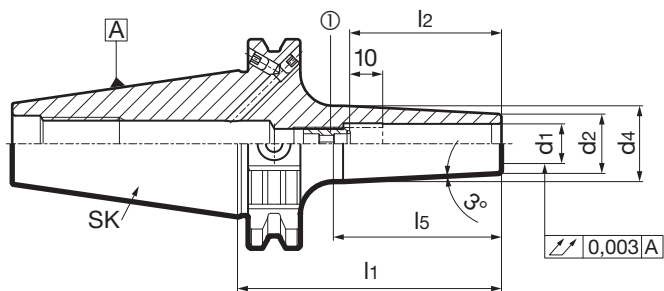

Article no. **4788**

SK	d1 mm	d2 mm	d4 mm	l1 mm	l2 mm	l5 mm	①	kg	Order no.
SK 40	3	9	13.5	80	30	46	4904 5.016	0.8	4788 3.040
SK 40	4	10	14.5	80	35	46	4904 6.016	0.8	4788 4.040
SK 40	5	11	15.5	80	40	47	4904 8.018	0.8	4788 5.040
SK 40	6	12	16.5	80	36	48	4977 6.014	0.8	4788 6.040
SK 40	8	14	19.0	80	36	49	4977 8.014	0.8	4788 8.040
SK 40	10	16	21.0	80	41	50	4977 10.014	0.9	4788 10.040
SK 40	12	18	23.0	80	46	51	4977 12.014	0.9	4788 12.040
SK 40	14	20	25.0	80	46	52	4977 12.014	0.9	4788 14.040
SK 40	16	22	27.0	80	49	53	4977 16.014	0.9	4788 16.040
SK 40	18	24	29.5	80	49	54	4977 16.014	0.9	4788 18.040
SK 40	20	26	31.5	80	51	55	4977 20.114	0.9	4788 20.040
SK 40	3	9	18.0	120	30	88	4904 5.016	0.9	4788 3.140
SK 40	4	10	19.0	120	35	88	4904 6.016	0.9	4788 4.140
SK 40	5	11	20.0	120	40	89	4904 8.018	0.9	4788 5.140
SK 40	6	12	21.0	120	36	90	4977 6.014	0.9	4788 6.140
SK 40	8	14	23.5	120	36	92	4977 8.014	1.0	4788 8.140
SK 40	10	16	25.5	120	41	92	4977 10.014	1.0	4788 10.140
SK 40	12	18	27.5	120	46	93	4977 12.014	1.0	4788 12.140
SK 40	14	20	29.5	120	46	94	4977 12.014	1.1	4788 14.140
SK 40	16	22	31.5	120	49	95	4977 16.014	1.1	4788 16.140
SK 40	18	24	33.5	120	49	96	4977 16.014	1.1	4788 18.140
SK 40	20	26	36.0	120	51	97	4977 20.114	1.2	4788 20.140
SK 40	3	9	22.5	160	30	130	4904 5.016	1.0	4788 3.240
SK 40	4	10	23.5	160	35	130	4904 6.016	1.0	4788 4.240
SK 40	5	11	24.5	160	40	131	4904 8.018	1.0	4788 5.240
SK 40	6	12	25.5	160	36	132	4977 6.014	1.1	4788 6.240
SK 40	8	14	27.5	160	36	132	4977 8.014	1.1	4788 8.240
SK 40	10	16	30.0	160	41	134	4977 10.014	1.2	4788 10.240
SK 40	12	18	32.0	160	46	135	4977 12.014	1.2	4788 12.240
SK 40	14	20	34.0	160	46	136	4977 12.014	1.3	4788 14.240
SK 40	16	22	36.0	160	49	137	4977 16.014	1.4	4788 16.240
SK 40	18	24	38.0	160	49	137	4977 16.014	1.4	4788 18.240
SK 40	20	26	40.5	160	51	139	4977 20.114	1.5	4788 20.240



MAS/BT shrink fit chucks TSG 3000

Article no. 4728



Product information:

- MAS/BT according to DIN ISO 7388-2 form JD/JF (AD/B)
- balancing quality: G 2.5 / 25,000 rpm or rev. < 1 gmm
- for tool shanks d1 h6
- concentricity < 3 µm
- with axial damping screw for optimal concentricity
- design for 6xM6 balancing screws for maximum accuracy
- coating for protection against oxidation cleanliness and longevity
- safety colour ring for maximum operator safety

Scope of delivery:

- incl. adjusting screw with axial force damping (1), art. no. 4941 for conventional cooling

suitable accessories separately available:

- BT pull studs art. nr. 4927, 4928
- replacement adjusting screw with axial force damping (1), art. no. 4941
- MQL version available on request

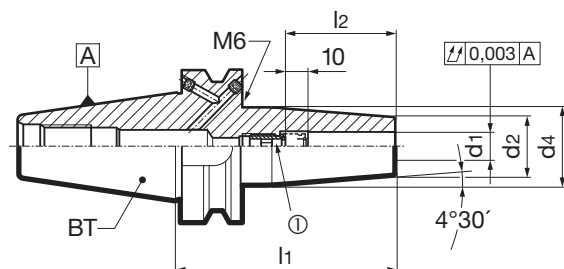

Article no.

4728

BT	d1 mm	d2 mm	d4 mm	l1 mm	l2 mm	①	kg	Order no.
BT 40	6	21	27	90	36	4941 6.041	1.0	4728 6.040
BT 40	8	21	27	90	36	4941 8.040	1.1	4728 8.040
BT 40	10	24	32	90	41	4941 10.050	1.0	4728 10.040
BT 40	12	24	32	90	46	4941 12.100	1.0	4728 12.040
BT 40	14	27	34	90	46	4941 14.100	1.5	4728 14.040
BT 40	16	27	34	90	49	4941 16.100	1.5	4728 16.040
BT 40	18	33	42	90	49	4941 18.100	2.0	4728 18.040
BT 40	20	33	42	90	51	4941 20.100	2.0	4728 20.040
BT 40	25	44	53	100	57	4941 25.100	2.0	4728 25.040
BT 40	32	44	53	100	57	4941 32.100	2.0	4728 32.040



Product information:

- MAS/BT DC with axial plane, sim. ISO 7388-2, form JD
- balancing quality: G 2.5 / 25,000 rpm or rev. < 1 gmm
- for tool shanks d1 h6
- axial length adjustment
- concentricity < 3 μm
- balancing thread 4xM6

Scope of delivery:

- incl. adjusting screw (1) art. no. 4904 or 4977

suitable accessories separately available:

- BT pull studs art. nr. 4927, 4928
- replacement adjusting screw (1), art. no. 4904 or 4977

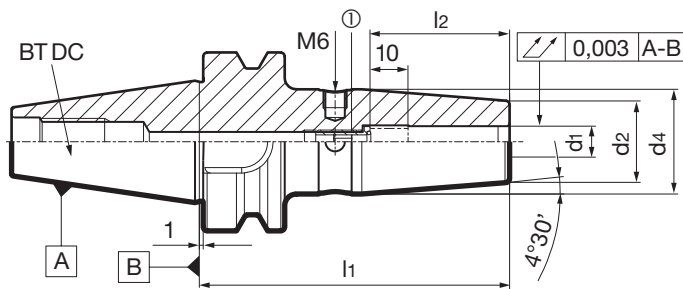

Article no.

4790

BT DC	d1 mm	d2 mm	d4 mm	l1 mm	l2 mm	①	kg	Order no.
BT 30	3	10	18	80	30	4904 5.016	0.6	4790 3.030
BT 30	4	10	18	80	35	4904 6.016	0.6	4790 4.030
BT 30	5	10	18	80	40	4904 8.018	0.6	4790 5.030
BT 30	6	21	27	80	36	4977 6.014	0.7	4790 6.030
BT 30	8	21	27	80	36	4977 8.014	0.7	4790 8.030
BT 30	10	24	32	80	41	4977 10.014	0.8	4790 10.030
BT 30	12	24	32	80	46	4977 12.014	0.8	4790 12.030
BT 30	14	27	34	80	46	4977 12.014	0.8	4790 14.030
BT 30	16	27	34	80	49	4977 16.014	0.8	4790 16.030
BT 30	18	33	42	90	49	4977 16.014	0.9	4790 18.030
BT 30	20	33	42	90	51	4977 20.114	0.9	4790 20.030



MAS/BT shrink fit chucks

Article no. 4739



Product information:

- MAS/BT to DIN ISO 7388-2 Form JD/JF
- BT30 in JD design without coolant supply via the collar
- balancing quality: G 2.5 / 25,000 rpm or rev. < 1 gmm
- for tool shanks d1 h6
- axial length adjustment
- balancing thread 4xM6/6xM6
- concentricity < 3 μm
l1 from 130 mm = 4 μm

Scope of delivery:

- incl. adjusting screw (1) art. no. 4977 or 4904

suitable accessories separately available:

- BT pull studs art. nr. 4927, 4928
- replacement adjusting screw (1), art. no. 4977 or 4904

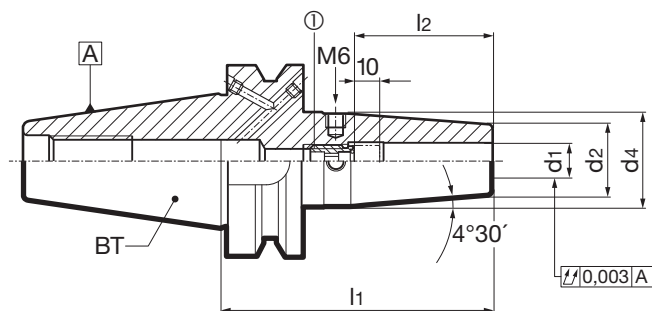

Article no.

4739

BT	d1 mm	d2 mm	d4 mm	l1 mm	l2 mm	①	kg	Order no.
BT 30	3	10	18	80	30	4904 5.016	0.6	4739 3.030
BT 30	4	10	18	80	35	4904 6.016	0.6	4739 4.030
BT 30	5	10	18	80	40	4904 8.018	0.6	4739 5.030
BT 30	6	21	27	80	36	4977 6.014	0.7	4739 6.030
BT 30	8	21	27	80	36	4977 8.014	0.7	4739 8.030
BT 30	10	24	32	80	41	4977 10.014	0.8	4739 10.030
BT 30	12	24	32	80	46	4977 12.014	0.8	4739 12.030
BT 30	14	27	34	80	46	4977 12.014	0.8	4739 14.030
BT 30	16	27	34	80	49	4977 16.014	0.8	4739 16.030
BT 30	18	33	42	90	49	4977 16.014	0.9	4739 18.030
BT 30	20	33	42	90	51	4977 20.114	0.9	4739 20.030
BT 40	3	10	18	85	30	4904 5.016	1.0	4739 3.040
BT 40	4	10	18	85	35	4904 6.016	1.0	4739 4.040
BT 40	5	10	18	85	40	4904 8.018	1.0	4739 5.040
BT 40	6	21	27	90	36	4977 6.014	1.2	4739 6.040
BT 40	8	21	27	90	36	4977 8.014	1.2	4739 8.040
BT 40	10	24	32	90	41	4977 10.014	1.2	4739 10.040
BT 40	12	24	32	90	46	4977 12.014	1.2	4739 12.040
BT 40	14	27	34	90	46	4977 12.014	1.4	4739 14.040
BT 40	16	27	34	90	49	4977 16.014	1.4	4739 16.040
BT 40	18	33	42	90	49	4977 16.014	1.7	4739 18.040
BT 40	20	33	42	90	51	4977 20.114	1.7	4739 20.040
BT 40	25	44	53	100	57	4977 20.114	1.8	4739 25.040
BT 40	32	44	53	100	61	4977 20.114	1.7	4739 32.040
BT 40	6	21	27	130	36	4977 6.014	1.3	4739 6.140
BT 40	8	21	27	130	36	4977 8.014	1.2	4739 8.140
BT 40	10	24	32	130	41	4977 10.014	1.4	4739 10.140
BT 40	12	24	32	130	46	4977 12.014	1.3	4739 12.140
BT 40	14	27	34	130	46	4977 12.014	1.4	4739 14.140
BT 40	16	27	34	130	49	4977 16.014	1.4	4739 16.140
BT 40	18	33	42	130	49	4977 16.014	1.5	4739 18.140
BT 40	20	33	42	130	51	4977 20.114	1.8	4739 20.140
BT 40	25	44	53	130	57	4977 20.114	2.0	4739 25.140
BT 40	32	44	53	130	61	4977 20.114	2.2	4739 32.140
BT 50	6	21	27	100	36	4977 6.014	2.9	4739 6.050
BT 50	8	21	27	100	36	4977 8.014	2.9	4739 8.050
BT 50	10	24	32	100	41	4977 10.014	3.8	4739 10.050
BT 50	12	24	32	100	46	4977 12.014	2.9	4739 12.050
BT 50	14	27	34	100	46	4977 12.014	3.3	4739 14.050
BT 50	16	27	34	100	49	4977 16.014	3.0	4739 16.050
BT 50	18	33	42	100	49	4977 16.014	1.9	4739 18.050
BT 50	20	33	42	100	51	4977 20.114	3.5	4739 20.050
BT 50	25	44	53	110	57	4977 20.114	4.3	4739 25.050
BT 50	32	44	53	110	61	4977 20.114	3.7	4739 32.050



Shrink fit extensions

Article no. **4719**



Product information:

- for clamping in hydraulic chucks or shrink fit chucks
- for carbide tool shanks d1 h6
(from d1 14 mm HSS also possible)
- with adjusting screw 10 mm adjustment range
- suitable for internal cooling
- we recommend the use of special cooling adaptors art. no. 4419
- concentricity < 3 µm
l1 from 115 mm = 5 µm
l1 from 150 mm = 7 µm
l1 from 200 mm = 9 µm

Scope of delivery:

- incl. adjusting screw (1) art. no. 4977 or 4904

suitable accessories separately available:

- replacement adjusting screw (1), art. no. 4904 or 4977

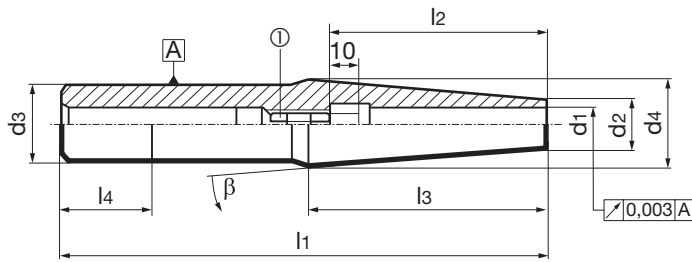

Article no.

4719

d1 mm	d2 mm	d3 mm	d4 mm	l1 mm	l2 mm	l3 mm	l4 mm	①	β °	kg	Order no.
3	7	16	16	115	30	64.4	50	4904 5.016	4	0.1	4719 3.016
4	7	16	16	115	35	64.4	50	4904 6.016	4	0.1	4719 4.016
5	8	16	16	115	40	57.2	57	4904 8.018	4	0.1	4719 5.016
6	10	16	16	115	36	42.9	72	4977 6.014	4	0.1	4719 6.016
8	12	16	16	115	36	28.6	86	4977 8.014	4	0.1	4719 8.016
10	14	16	16	115	41	14.3	100	4977 10.014	4	0.1	4719 10.016
12	16	16	23	115	46	51.5	55	4977 12.014	4	0.1	4719 12.016
3	7	20	16	115	30	65.0	48	4904 5.016	4	0.1	4719 3.020
4	8	20	17	115	35	65.0	48	4904 6.016	4	0.1	4719 4.020
5	9	20	18	115	40	65.0	49	4904 8.018	4	0.1	4719 5.020
6	10	20	19	115	36	65.0	49	4977 6.014	4	0.1	4719 6.020
8	12	20	20	115	36	57.2	57	4977 8.014	4	0.1	4719 8.020
10	14	20	20	115	41	42.9	72	4977 10.014	4	0.2	4719 10.020
12	16	20	20	115	46	28.6	86	4977 12.014	4	0.2	4719 12.020
14	20	20	28	150	46	62.9	82	4977 12.014	4	0.3	4719 14.020
14	20	25	28	150	46	62.9	85	4977 12.014	4	0.4	4719 14.025
16	24	25	33	150	49	64.4	81	4977 16.014	4	0.5	4719 16.025
3	10	20	20	160	30	71.5	88	4904 5.016	4	0.2	4719 3.120
4	10	20	20	160	35	71.5	88	4904 6.016	4	0.2	4719 4.120
5	10	20	20	160	40	71.5	88	4904 8.018	4	0.2	4719 5.120
6	14	20	20	160	36	42.9	117	4977 6.014	4	0.3	4719 6.120
8	14	20	20	160	36	42.9	117	4977 8.014	4	0.3	4719 8.120
10	20	25	25	160	41	35.8	124	4977 10.014	4	0.5	4719 10.125
12	20	25	25	160	46	35.8	124	4977 12.014	4	0.4	4719 12.125
14	20	25	29	160	46	62.9	85	4977 12.014	4	0.4	4719 14.125
16	22	25	33	160	49	78.7	77	4977 16.014	4	0.5	4719 16.125
18	27	32	32	160	49	35.8	124	4977 16.014	4	0.8	4719 18.132
20	27	32	32	160	51	35.8	124	4977 20.114	4	0.8	4719 20.132
3	10	20	20	200	30	71.5	128	4904 5.016	4	0.3	4719 3.220
4	10	20	20	200	35	71.5	128	4904 6.016	4	0.3	4719 4.220
5	10	20	20	200	40	71.5	128	4904 8.018	4	0.3	4719 5.220
6	14	20	20	200	36	42.9	157	4977 6.014	4	0.4	4719 6.220
8	14	20	20	200	36	42.9	157	4977 8.014	4	0.3	4719 8.220
10	20	25	25	200	41	35.8	164	4977 10.014	4	0.6	4719 10.225
12	20	25	25	200	46	35.8	164	4977 12.014	4	0.6	4719 12.225
14	20	32	32	200	46	85.8	114	4977 12.014	4	0.9	4719 14.232
16	24	32	32	200	49	57.2	142	4977 16.014	4	1.0	4719 16.232
18	27	32	32	200	49	35.8	164	4977 16.014	4	1.0	4719 18.232
20	27	32	32	200	51	35.8	164	4977 20.114	4	1.0	4719 20.232
6	10	12	12	125	38	19.1	105		3	0.0	4719 6.012
8	12	14	14	125	38	19.1	105		3	0.1	4719 8.014
10	14	16	16	160	42	19.1	140		3	0.2	4719 10.116
12	16	20	20	160	47	38.2	121		3	0.3	4719 12.120
16	22	25	25	160	50	28.6	131		3	0.5	4719 16.225
20	27	32	32	160	52	47.7	112		3	0.8	4719 20.332
6	10	12	12	200	38	21.0	47		3	0.1	4719 6.312
8	12	14	14	200	38	21.0	47		3	0.1	4719 8.314
10	14	16	16	250	42	21.0	50		3	0.3	4719 10.316

Shrink fit technology



Article no.

4719

d1 mm	d2 mm	d3 mm	d4 mm	l1 mm	l2 mm	l3 mm	l4 mm	①	β °	kg	Order no.
12	16	20	20	250	47	40.1	52		3	0.4	4719 12.320
16	22	25	25	250	50	30.5	58		3	0.8	4719 16.325
20	27	32	32	250	52	49.6	62		3	1.3	4719 20.432



Product information:

- for shrink fit and hydraulic chucks
- for length pre-setting of the adjusting screw with the cutting tool (less difference dimension l2, see sketch)
- flexibly mounted hexagonal key SW1/SW2 (*only available as rigid design)
- with standard screws suitable for wet application art. no. 4900, 4941, 4977

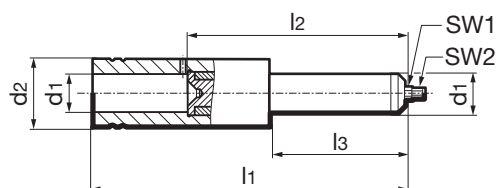

Article no.

4718

d1 mm	d2 mm	l1 mm	l2 mm	l3 mm	SW1 mm	SW2 mm	Order no.
6	25	115	80	50	3.0	2.5	4718 6.000
6	25	115	80	50	2.0	1.5	4718 6.001
6	25	115	80	50	4.0		4718 6.002
8	25	115	80	50	3.0		4718 8.000
8	25	115	80	50	2.0	1.5	4718 8.001
8	25	115	80	50	4.0		4718 8.002
10	25	115	80	50	4.0	3.0	4718 10.000
10	25	115	80	50	2.0	1.5	4718 10.001
12	25	115	80	50	5.0		4718 12.000
12	25	115	80	50	2.0	1.5	4718 12.001
12	25	115	80	50	4.0	3.0	4718 12.002
14	25	115	80	50	5.0		4718 14.000
14	25	115	80	50	2.0	1.5	4718 14.001
14	25	115	80	50	4.0	3.0	4718 14.002
16	25	120	85	55	6.0	5.0	4718 16.000
16	25	120	85	55	2.0	1.5	4718 16.001
16	25	120	85	55	4.0	3.0	4718 16.002
18	30	120	85	65	6.0	5.0	4718 18.000
18	30	120	85	65	2.0	1.5	4718 18.001
18	30	120	85	65	4.0	3.0	4718 18.002
20	30	135	90	65	8.0	5.0	4718 20.000
20	30	135	90	65	4.0	3.0	4718 20.001
20	30	135	90	65	4.0		4718 20.002
25	35	140	100	70	8.0	5.0	4718 25.000
25	35	140	100	70	3.0	2.0	4718 25.001
25	35	140	100	70	4.0		4718 25.002
32	45	150	100	70	8.0	5.0	4718 32.000
32	45	150	100	70	3.0	2.0	4718 32.001
32	45	150	100	70	4.0		4718 32.002

Shrink fit technology



Adjusting screws for GÜHROJET shrink fit chucks

Article no. **4938**

Product information:

- adjusting screws for Gührojet shrink fit chucks art. no. 4755
- with transverse groove for reliable coolant delivery

suitable accessories separately available:

- hexagonal key art. no. 4912

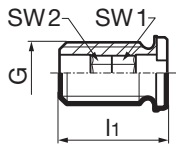

Article no. **4938**

for holder Ø	l1 mm	G	SW1 mm	SW2 mm	Order no.
6	14	M 5	2.5	2.5	4938 6.000
8	14	M 6	3.0	3.0	4938 8.000
10	14	M8 x 1	4.0	4.0	4938 10.000
12/14	14	M10X1	5.0	5.0	4938 12.000
16/18	14	M12X1	6.0	6.0	4938 16.000
20/25/32	14	M16X1	8.0	6.0	4938 20.000

Shrink fit chuck length adjusting screws with axial force damping

Article no. **4977**

Product information:

- for shrink fit chucks
- for conventional internal cooling
- with plane stop for standard shank ends
- with smooth, bearing-led length compensation, which compensates for differences between the spindle feed and thread pitch

suitable accessories separately available:

- hexagonal key art. no. 4912

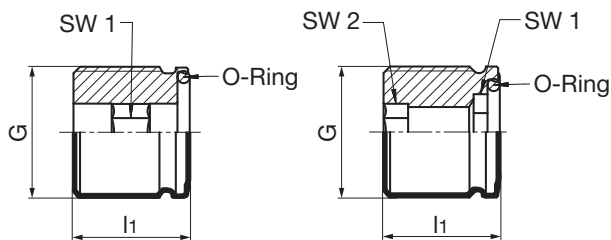

Article no. **4977**

for holder Ø	l1 mm	G	SW1 mm	SW2 mm	Order no.
6	14.0	M 5	2.5		4977 6.014
8	14.0	M 6	3.0		4977 8.014
10	14.0	M8 x 1	4.0		4977 10.014
12/14	14.0	M10X1	5.0		4977 12.014
16/18	14.0	M12X1	6.0		4977 16.014
20/25	14.0	M16X1	6.0		4977 20.014
20/25/32	14.0	M16X1	8.0	6.0	4977 20.114

Shrink fit technology



Product information:

- to adapt MQL tool holders to meet the requirements of conventional wet machining. For plain end shanks. The height of screw head compensates the height of MQL taper.
- for use with shank according to DIN 6535 with plain shank end for conventional cooling
- with patented axial force damping; the o-ring on the face prevents temperature-related warping and concentricity errors
- for MQL HSK-A shrink fit and hydraulic chucks

suitable accessories separately available:

- hexagonal key art. no. 4912

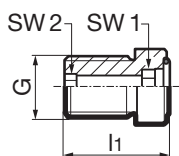

Article no.

4941

for HSK-A	for clamping Ø mm	l1 mm	G	SW1 mm	SW2 mm	Order no.
40	6	15.0	M7	2.5	2.5	4941 6.040
40	6	14.9	M 5	2.5	2.5	4941 6.041
50	6	14.0	M 8X1	2.5	2.5	4941 6.050
63-100	6	17.0	M10X1	2.5	2.5	4941 6.100
40	8	16.2	M7	3.0	3.0	4941 8.040
50	8	18.0	M 8X1	3.0	3.0	4941 8.050
63-100	8	17.0	M10X1	3.0	3.0	4941 8.100
40-50	10	16.2	M 8X1	4.0	4.0	4941 10.050
63-100	10	16.2	M10X1	4.0	4.0	4941 10.100
40-100	12	16.0	M10X1	5.0	5.0	4941 12.100
40-100	14	17.2	M10X1	5.0	5.0	4941 14.100
50-100	16	18.2	M12X1	6.0	6.0	4941 16.100
50-100	18	19.2	M12X1	6.0	6.0	4941 18.100
50-100	20	19.2	M16X1	6.0	8.0	4941 20.100
63-100	25	22.7	M16X1	6.0	8.0	4941 25.100
63-100	32	26.7	M16X1	6.0	8.0	4941 32.100



Adjusting screws

Article no. **4904**

Product information:

- for side lock holders HSK-A with mounting hole DIN 1835–2, form E, shrink fit chuck and shrink fit extension
- minimum order quantity 5 units

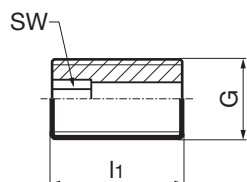
Article no. **4904**

G	l1 mm	SW mm	Order no.
M 5	5	2.5	4904 5.005
M 5	7	2.5	4904 5.007
M 5	16	2.5	4904 5.016
M 5	20	2.5	4904 5.020
M 6	7	3.0	4904 6.007
M 6	16	3.0	4904 6.016
M 6	20	3.0	4904 6.020
M 8	12	3.0	4904 8.012
M 8	18	4.0	4904 8.018
M10	17	3.0	4904 10.017
M10	20	5.0	4904 10.020
M12	14	3.0	4904 12.014
M12	20	5.0	4904 12.020
M16	25	5.0	4904 16.025
M20	25	6.0	4904 20.025



MQL length pre-adjusting screws for conversion

Article no. **4919**

Product information:

- for hydraulic chucks and shrink fit chucks
- with special geometry optimised for MQL
- with tapered stop for MQL conical shank ends

suitable accessories separately available:

- hexagonal key art. no. 4912

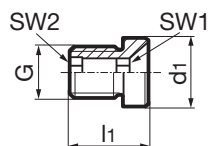

Article no.

4919

d1 mm	l1 mm	G	SW1 mm	SW2 mm	Order no.
6	14.8	M 6	2.5	2.5	4919 6.000
8	15.6	M 6	3.0	3.0	4919 8.000
10	16.1	M 8X1	4.0	4.0	4919 10.000
10	16.6	M 6	3.0	3.0	4919 10.032
10	16.6	M 8X1	3.0	3.0	4919 10.040
12	16.6	M10X1	5.0	5.0	4919 12.000
12	17.6	M 6	3.0	3.0	4919 12.032
14	17.6	M10X1	5.0	5.0	4919 14.000
14	18.6	M 6	3.0	3.0	4919 14.040
16	18.6	M12X1	5.0	5.0	4919 16.000
16	19.6	M 6	3.0	3.0	4919 16.040
18	19.6	M12X1	5.0	5.0	4919 18.000
20	20.6	M16X1	5.0	5.0	4919 20.000
25	22.6	M16X1	8.0	6.0	4919 25.000
32	26.1	M16X1	8.0	6.0	4919 32.000



MQL coolant supply set with tube, HSK-A, for conversion

Article no. 4924

Product information:

- for hydraulic chucks according to DIN 69882-7
- for shrink fit chucks according to DIN 69882-8
- replaces conventional coolant supply sets, art. no. 4949, when applying MQL
- Please note: Not suitable for use in machines with delivery neck in accordance with DIN 69090-2, observe hole diameter d4

Scope of delivery:

- complete MQL coolant supply set consisting of: coolant pipe, cap nut, MQL tube and O-rings

suitable accessories separately available:

- socket wrench art. no. 4911

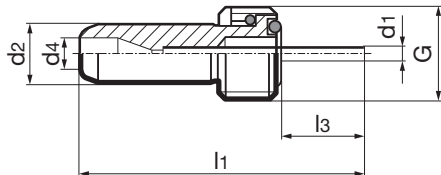

Article no.

4924

for	d1 mm	d2 mm	d4 mm	l1 mm	l3 mm	G	Order no.
HSK-A 32	2.5	6	3.5	54.2	28.0	M10X1	4924 32.010
HSK-A 32	2.5	6	3.5	45.1	18.9	M10X1	4924 32.020
HSK-A 32	3.0	6	3.5	54.3	28.1	M10X1	4924 32.030
HSK-A 32	3.0	6	3.5	55.8	29.6	M10X1	4924 32.050
HSK-A 32	3.0	6	3.5	45.7	19.5	M10X1	4924 32.060
HSK-A 32	3.0	6	3.5	56.6	30.4	M10X1	4924 32.070
HSK-A 32	3.0	6	3.5	45.2	19.0	M10X1	4924 32.080
HSK-A 40	2.5	8	4.0	45.1	16.0	M12X1	4924 40.010
HSK-A 40	2.5	8	4.0	56.0	26.9	M12X1	4924 40.020
HSK-A 40	3.0	8	4.0	56.2	15.8	M12X1	4924 40.030
HSK-A 40	3.0	8	4.0	56.2	27.0	M12X1	4924 40.040
HSK-A 40	3.0	8	4.0	46.3	17.1	M12X1	4924 40.050
HSK-A 40	3.0	8	4.0	51.7	22.5	M12X1	4924 40.060
HSK-A 40	3.0	8	4.0	46.7	17.5	M12X1	4924 40.070
HSK-A 40	3.0	8	4.0	57.2	28.0	M12X1	4924 40.100
HSK-A 40	3.0	8	4.0	54.2	25.0	M12X1	4924 40.120
HSK-A 50	2.5	10	4.0	44.6	11.9	M16X1	4924 50.010
HSK-A 50	2.5	10	4.0	55.4	22.7	M16X1	4924 50.020
HSK-A 50	3.0	10	4.0	46.1	13.4	M16X1	4924 50.030
HSK-A 50	3.0	10	4.0	46.5	13.8	M16X1	4924 50.040
HSK-A 50	4.0	10	4.0	45.7	13.0	M16X1	4924 50.050
HSK-A 50	4.0	10	4.0	46.1	13.4	M16X1	4924 50.060
HSK-A 50	5.0	10	4.0	46.1	13.4	M16X1	4924 50.070
HSK-A 50	5.0	10	4.0	55.7	23.0	M16X1	4924 50.080
HSK-A 50	5.0	10	4.0	51.5	18.8	M16X1	4924 50.090
HSK-A 50	5.0	10	4.0	55.7	22.9	M16X1	4924 50.100
HSK-A 50	5.0	10	4.0	52.8	20.1	M16X1	4924 50.110
HSK-A 50	5.0	10	4.0	53.2	20.5	M16X1	4924 50.130
HSK-A 50	5.0	10	4.0	57.7	25.0	M16X1	4924 50.140
HSK-A 50	5.0	10	4.0	51.5	18.8	M16X1	4924 50.150
HSK-A 50	5.0	10	4.0	60.7	28.0	M16X1	4924 50.160
HSK-A 63	2.5	12	4.0	45.7	9.5	M18X1	4924 63.010
HSK-A 63	2.5	12	4.0	126.9	90.6	M18X1	4924 63.011
HSK-A 63	2.5	12	4.0	176.9	140.6	M18X1	4924 63.012
HSK-A 63	2.5	12	4.0	56.7	20.5	M18X1	4924 63.020
HSK-A 63	2.5	12	4.0	137.7	101.4	M18X1	4924 63.021
HSK-A 63	3.0	12	4.0	46.0	9.8	M18X1	4924 63.030
HSK-A 63	3.0	12	4.0	126.1	89.9	M18X1	4924 63.031
HSK-A 63	3.0	12	4.0	176.2	139.9	M18X1	4924 63.032
HSK-A 63	3.0	12	4.0	57.0	20.8	M18X1	4924 63.040
HSK-A 63	3.0	12	4.0	137.0	100.7	M18X1	4924 63.041
HSK-A 63	4.0	12	4.0	51.7	15.5	M18X1	4924 63.050
HSK-A 63	4.0	12	4.0	122.2	86.0	M18X1	4924 63.051
HSK-A 63	4.0	12	4.0	172.2	135.9	M18X1	4924 63.052
HSK-A 63	4.0	12	4.0	55.7	19.5	M18X1	4924 63.060
HSK-A 63	4.0	12	4.0	132.2	95.9	M18X1	4924 63.061
HSK-A 63	5.0	12	4.0	52.1	15.9	M18X1	4924 63.070
HSK-A 63	5.0	12	4.0	55.7	19.5	M18X1	4924 63.080
HSK-A 63	5.0	12	4.0	127.1	90.8	M18X1	4924 63.081
HSK-A 63	5.0	12	4.0	53.8	17.6	M18X1	4924 63.090
HSK-A 63	5.0	12	4.0	117.6	81.4	M18X1	4924 63.091
HSK-A 63	5.0	12	4.0	167.6	131.3	M18X1	4924 63.092
HSK-A 63	5.0	12	4.0	57.5	21.3	M18X1	4924 63.100
HSK-A 63	5.0	12	4.0	60.7	24.5	M18X1	4924 63.110



Shrink fit chucks – Accessories

Article no.							4924
for	d1 mm	d2 mm	d4 mm	l1 mm	l3 mm	G	Order no.
HSK-A 63	5.0	12	4.0	114.3	78.0	M18X1	4924 63.111
HSK-A 63	6.0	12	4.0	77.0	40.8	M18X1	4924 63.120
HSK-A 63	6.0	12	4.0	69.0	32.8	M18X1	4924 63.130
HSK-A 63	5.0	12	4.0	114.6	78.3	M18X1	4924 63.131
HSK-A 63	5.0	12	4.0	164.6	128.3	M18X1	4924 63.132
HSK-A 63	6.0	12	4.0	70.7	34.5	M18X1	4924 63.140
HSK-A 63	5.0	12	4.0	124.3	88.0	M18X1	4924 63.141
HSK-A 63	5.0	12	4.0	112.9	76.6	M18X1	4924 63.151
HSK-A 63	5.0	12	4.0	162.9	126.6	M18X1	4924 63.152
HSK-A 63	5.0	12	4.0	122.1	85.8	M18X1	4924 63.161
HSK-A 63	6.0	12	4.0	116.2	79.9	M18X1	4924 63.181
HSK-A 63	6.0	12	4.0	112.2	75.9	M18X1	4924 63.201
HSK-A 80	2.5	14	4.0	44.8	5.5	M20X1.5	4924 80.010
HSK-A 80	2.5	14	4.0	61.2	21.9	M20X1.5	4924 80.020
HSK-A 80	3.0	14	4.0	44.9	5.6	M20X1.5	4924 80.030
HSK-A 80	3.0	14	4.0	61.3	22.0	M20X1.5	4924 80.040
HSK-A 80	4.0	14	4.0	50.9	11.6	M20X1.5	4924 80.050
HSK-A 80	4.0	14	4.0	61.3	22.0	M20X1.5	4924 80.060
HSK-A 80	5.0	14	4.0	51.3	12.0	M20X1.5	4924 80.070
HSK-A 80	5.0	14	4.0	51.6	12.3	M20X1.5	4924 80.090
HSK-A 80	5.0	14	4.0	61.3	22.0	M20X1.5	4924 80.100
HSK-A 80	5.0	14	4.0	57.9	18.6	M20X1.5	4924 80.110
HSK-A 80	5.0	14	4.0	58.3	19.0	M20X1.5	4924 80.130
HSK-A 80	5.0	14	4.0	63.3	24.0	M20X1.5	4924 80.140
HSK-A 80	5.0	14	4.0	56.6	17.3	M20X1.5	4924 80.150
HSK-A 80	5.0	14	4.0	66.3	78.0	M20X1.5	4924 80.160
HSK-A 80	6.0	14	4.0	53.1	13.8	M20X1.5	4924 80.170
HSK-A 80	6.0	14	4.0	70.3	78.0	M20X1.5	4924 80.180
HSK-A 80	6.0	14	4.0	77.2	37.9	M20X1.5	4924 80.190
HSK-A 80	6.0	14	4.0	71.3	78.0	M20X1.5	4924 80.200
HSK-A 100	2.5	16	4.0	53.0	9.2	M24X1.5	4924 100.010
HSK-A 100	2.5	16	4.0	63.9	78.0	M24X1.5	4924 100.020
HSK-A 100	3.0	16	4.0	53.7	9.9	M24X1.5	4924 100.030
HSK-A 100	3.0	16	4.0	64.6	78.0	M24X1.5	4924 100.040
HSK-A 100	4.0	16	4.0	63.3	19.5	M24X1.5	4924 100.050
HSK-A 100	4.0	16	4.0	63.3	78.0	M24X1.5	4924 100.060
HSK-A 100	5.0	16	4.0	63.8	20.0	M24X1.5	4924 100.070
HSK-A 100	5.0	16	4.0	64.2	20.4	M24X1.5	4924 100.090
HSK-A 100	5.0	16	4.0	63.3	78.0	M24X1.5	4924 100.100
HSK-A 100	5.0	16	4.0	65.4	21.6	M24X1.5	4924 100.110
HSK-A 100	5.0	16	4.0	65.8	22.0	M24X1.5	4924 100.130
HSK-A 100	5.0	16	4.0	65.3	78.0	M24X1.5	4924 100.140
HSK-A 100	5.0	16	4.0	69.2	25.4	M24X1.5	4924 100.150
HSK-A 100	5.0	16	4.0	68.3	78.0	M24X1.5	4924 100.160
HSK-A 100	6.0	16	4.0	68.6	24.8	M24X1.5	4924 100.170
HSK-A 100	6.0	16	4.0	72.3	78.0	M24X1.5	4924 100.180
HSK-A 100	6.0	16	4.0	64.6	20.8	M24X1.5	4924 100.190
HSK-A 100	6.0	16	4.0	73.3	78.0	M24X1.5	4924 100.200

Shrink fit technology

Power milling with

|PINLOCK|

**Volume machining without tool drawout:
perfect combination of HPC clamping chuck mit
Gührojet cooling and PinLock drawout**

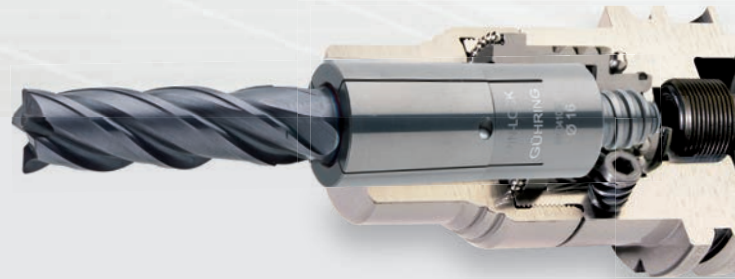

|GÜHROJET|

Thanks to the application of a PinLock clamping sleeve with securing pin any drawout of the applied standard milling tools with HB shank to DIN 6535 is safely prevented. The combination of HPC clamping technology with perfect concentricity and the efficient Gührojet peripheral cooling achieves, until now, unachieved metal removal rates, tool life and surface quality. All this with standard tools and absolute protection against unwanted drawout effects.



|PINLOCK|

- no tool drawout;
no component damage
- process reliable
- simple handling
- standard milling tools therefore
no licenses required
- for long tool life and best
surface quality





Induction shrink fit system GSS 2000

SIMPLE, QUICK AND SECURE TOOL CLAMPING



EFFICIENT OPERATION

The turntable allows simultaneous preparation, heating and cooling of the shrink fit chucks. Subsequently, there is no waiting time, tool clamping is seamless and with maximum efficiency.



QUICK COOLING

The water-cooled cooling elements cool down the shrink fit chuck quickly and safely. The shrink fit chuck remains clean and dry, so that it can be applied again without drying and without rusting. Hot spots remain safely screened during the cooling process in order to prevent burns.



SAFE SHRINK FITTING

The minimal heating of the shrink fit chuck ensures maximum operating safety on the one hand, on the other the controlled heating ensures the long life of the shrink fit chuck.



ALL UNDER CONTROL

Practical locations and compartments provide room for accessories such as stop discs or gloves in close proximity to the equipment. Thus all the necessary components are always at hand.



THE CONTROL PANEL

The clear control panel with display makes the operation of the GSS 2000 very user-friendly.



SIMPLE OPERATION

The movement of the spindle and its heating is a single handed operation. Tool clamping cannot be simpler and quicker!

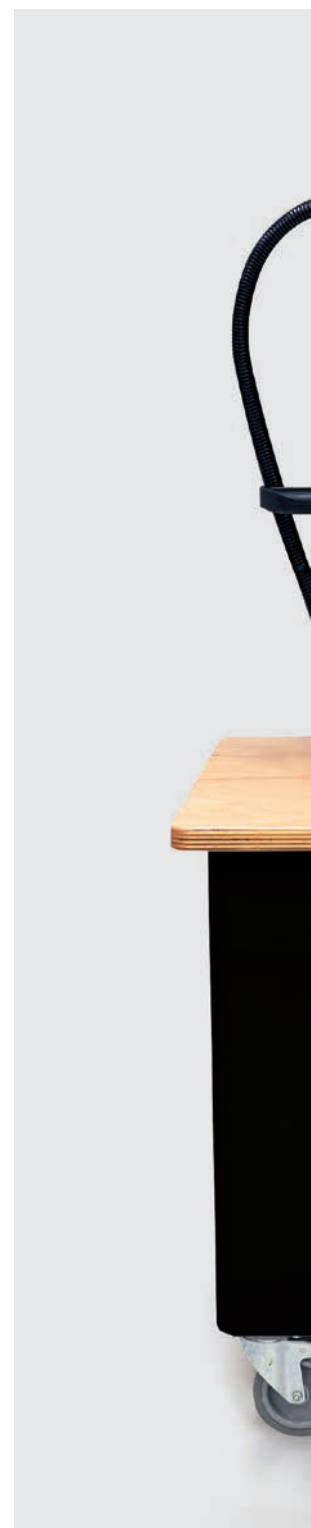



HIGH-PERFORMANCE SPINDLE
hence quick change time



OVERHEATING PROTECTION
for holder



AUTOMATIC MODE
possible (equipment automatically selects the correct heating programme)



ERROR DETECTION
choosing wrong chuck/
programme



HEATING PROGRAMMES
for standard/reinforced and
very small holder/shrink fit
extensions



GSS 2000 Basic

Article no. **4730**

Product information:

- 1-place system
- version 50/60 Hz / 400-480 V

Scope of delivery:

- incl. base system
- incl. induction coil art. no. 4743 / version 2008
- incl. 1 limit stop collar set art. no. 4769 / version 2008
- incl. 1 pair of gloves art. no. 4750

suitable accessories separately available:

- HSK holders GSS 2000 art. no. 4761
- ISO taper holders GSS 2000 art. no. 4762



Article no.	4730
Order no.	4730 10.000

Europa Version

GSS 2000 Eco-Plus

Article no. **4752**

Product information:

- 1-place system
- Europe version 50/60 Hz / 400-480 V, SpeedCooler 230V
- US version 50/60 Hz / 400-480 V, SpeedCooler 115V

Scope of delivery:

- incl. base system
- incl. induction coil art. no. 4743 / version 2008
- incl. 1 limit stop collar set art. no. 4769 / version 2008
- incl. SpeedCooler art. no. 4747
- incl. 1 pair of gloves art. no. 4750
- with integrated SpeedCooler manager

suitable accessories separately available:

- HSK holders GSS 2000 art. no. 4761
- ISO taper holders GSS 2000 art. no. 4762



Article no.	4752
Order no.	4752 10.000
	4752 20.000

Europa Version
US Version

Shrink fit technology



GSS 2000 Comfort version

Article no. **4742**

Product information:

- 3-station system with turntable
- Europe version 50/60 Hz / 400-480 V, SpeedCooler 230V
US version 50/60 Hz / 400-480 V, SpeedCooler 115V

Scope of delivery:

- incl. base system with turntable
- incl. induction coil art. no. 4743 / version 2008
- incl. 1 limit stop collar set art. no. 4769 / version 2008
- incl. SpeedCooler art. no. 4747
- incl. 1 pair of gloves art. no. 4750
- with integrated SpeedCooler manager

suitable accessories separately available:

- HSK holders GSS 2000 art. no. 4745
- ISO taper holders GSS 2000 art. no. 4744



Article no. **4742**

	Order no.
Europa Version	4742 10.000
US Version	4742 20.000

Shrink fit technology



HSK holders GSS 2000

Article no. **4761**

Product information:

- for GSS 2000 Basic and ECO Plus art. no. 4730 and 4752
- holders for HSK shrink fit chucks



Article no. **4761**

for form A/C/E		Order no.
HSK32		4761 32.000
HSK40		4761 40.000
HSK50		4761 50.000
HSK63		4761 63.000
HSK80		4761 80.000
HSK100		4761 100.000

HSK holders GSS 2000

Article no. **4745**

Product information:

- for GSS 2000 Comfort Plus art. no. 4742
- for turn-table for holding 3 SK or MAS/BT shrink fit chucks each



Article no. **4745**

for form A/C/E		Order no.
HSK32		4745 32.000
HSK40		4745 40.000
HSK50		4745 50.000
HSK63		4745 63.000
HSK80		4745 80.000
HSK100		4745 100.000

Shrink fit technology



ISO taper holders GSS 2000

Article no. **4762**

Product information:

- for GSS 2000 Basic and ECO Plus art. no. 4730 and 4752
- holders can also be used for MAS/BT and CAT shrink fit chucks



Article no. **4762**

for SK/BT/CAT		Order no.
SK-BT-CAT-30		4762 30.000
SK-BT-CAT-40		4762 40.000
SK-BT-CAT-50		4762 50.000

ISO taper holders GSS 2000

Article no. **4744**

Product information:

- for GSS 2000 Comfort Plus art. no. 4742
- holders can also be used for MAS/BT and CAT shrink fit chucks
- for turntables to hold max. 3 shrink fit chucks



Article no. **4744**

for SK/BT/CAT		Order no.
SK-BT-CAT-30		4744 30.000
SK-BT-CAT-40		4744 40.000
SK-BT-CAT-50		4744 50.000

Shrink fit technology



Limit stop collars

Article no. **4769**

Product information:

- for induction coil
- suitable for all GSS systems
- for extra short standard shrink fit chucks with Code no.,100



Article no. **4769**

for tool Ø mm	Order no.
3-5	4769 5.000
6-12	4769 12.000
6-12	4769 12.100
14-16	4769 16.000
18-20	4769 20.000
14-20	4769 20.100
25-32	4769 32.000
25-32	4769 32.100

Cooling adaptor set, complete

Article no. **4419**

Product information:

- cooling adaptor set for shrink fit system GSS 2000 Comfort Plus and ECO Plus art. no. 4742 and 4752
- for inserting in the cooling adaptor Ø14-16, in order to effectively and safely cool the small shrink fit holders with clamping diameter Ø 3-5

Shrink fit technology



Article no. **4419**

Ø range mm	Order no.
3-5	4419 5.000



Induction coil

Article no. **4743**

Product information:

- for GSS 2000
- HSS for Ø 6...32 mm, carbide for Ø 3...32 mm



Article no. **4743**

Ø range mm	Order no.
3..32	4743 32.000

Induction unit

Article no. **4757**

Product information:

- power electronics for shrink fit system
Version 50/60 Hz / 400–480 V



Article no. **4757**

Complete set	Order no.
	4757 1.000

Shrink fit technology



System cart

Article no. **4748**

Product information:

for GSS 2000 • for mobile and stationary application • continuous Ø-range



Article no. **4748**

Order no.

4748 1.000

Swivel compartments for GSS 2000

Article no. **4763**

Product information:

- for the clean storage of GSS shrink fit system accessories, i.e. limit stop washers, gloves, measuring instruments etc.
- for GSS 2000 Comfort Plus and ECO Plus art. no. 4742 and 4752

Scope of delivery:

- swivel compartment does not include accessories shown



Shrink fit technology

Article no. **4763**

Order no.

4763 1.000



Tongs

Article no. **4749**

Product information:
for the safe handling of hot tools



Article no. **4749**

Order no.
4749 1.000

Protective gloves

Article no. **4750**

Product information:
kevlar gloves providing protection against sharp cutting edges and high temperatures • as specified for all shrink fit applications



Article no. **4750**

Order no.
4750 1.000

Shrink fit technology



SpeedCooler cooling system

Article no. **4747**

Product information:

- for GSS 2000 Comfort Version and Eco-Plus
- Europe version 50/60 Hz, 230 V
- US Version 50/60 Hz, 115 V



Article no. **4747**

	Order no.
Europa Version	4747 1.000
US Version	4747 2.000

Speed Cooler manager

Article no. **4759**

Product information:

- for automatic switch on and off of the SpeedCooler
- preserves the cooling system and reduce the service intervals
- Europe version 50/60 Hz, 230 V
- US Version 50/60 Hz, 115 V



Article no. **4759**

	Order no.
Europa Version	4759 1.000
US Version	4759 2.000

Shrink fit technology



Coolant protection

Article no. **4767**

Product information:

- for GSS cooling systems
Contents: 2 litres



Article no. **4767**

Order no.
4767 1.000

Cable hoist

Article no. **4746**

Product information:

- to relieve the coil weight on the guide pillar



Article no. **4746**

Order no.
4746 1.000

Shrink fit technology



Induction shrink fit system GSS 3001

SETTING, SHRINK FITTING AND MEASURING WITH ONE SYSTEM



SHRINK FIT PROCESS

Vapours produced during the shrink fit process are removed and filtered under controlled conditions by the fume extraction system.

During the shrink fit process the tool is pre-set to the required length with the assistance of an adjustment rod.



QUICK COOLING

The water-cooled cooling elements cool down the shrink fit chuck quickly and safely. The shrink fit chuck remains clean and dry, so that it can be applied again without drying and without rusting. Hot spots remain safely screened during the cooling process in order to prevent burns.



SAFE SHRINK FITTING

The minimal heating of the shrink fit chuck ensures maximum operating safety on the one hand, on the other the controlled heating ensures the long life of the shrink fit chuck.



LABEL PRINTER

Print data such as article no., current setting dimension, date, operator etc. on an adhesive label for your pre-set tool.



USABILITY SOFTWARE

Intuitive menu navigation similar to the well-established Gühring TM-Software GTMS via touch-screen monitor.



CODIER-CHIP

The read and write function of the Codier-Chip art. no. 4955 simplifies tool identification. Tool life can be managed.





YOU BENEFIT FROM:



HIGH ECONOMIC EFFICIENCY
thanks to effective operation mode



FULL TRANSPARENCY
due to process analysis



ABSOLUTELY USER-FRIENDLY



Induction shrink fit system GSS 5000

YOU CAN'T GET MORE INTO A SYSTEM!

In addition to the functions pre-setting, shrink fitting and measuring GSS 5000 also offers the possibility of a fully automatic cutting edge form recognition and length presetting. Depending on the configuration a measuring range up to 800 mm and a measuring diameter up to 600 mm can be covered.

GSS 5000
can be
adapted to
customer
requirements.





Shrink fit technology



CONFIGURATION OF GÜHROSync SYNCHRO TAPPING CHUCKS WITH STRAIGHT SHANK FOR INTERNAL COOLING

GÜHROSync

Hydraulic synchro tapping chucks with increased clamping force

Shrink fit chucks

- 4736** HSK-A **4221** MAS-BT
- 4726** TSG 3000 HSK-A **4299** HSK-A
- 4758** HSK-C **4267** HSK-C
- 4738** ISO taper **4213** ISO taper

4949 Coolant supply set HSK-A for conventional cooling



Hydraulic synchro tapping chucks
4601 HSK-A

4925 Pull studs for ISO taper
4926



Hydraulic synchro tapping chucks
4576 ISO taper

4927 Pull studs for MAS/BT
4928



Hydraulic synchro tapping chucks
4577



4525
Hydro-Ø 12 / Ø 20
Cylindrical hydraulic synchro tapping chucks Ø 20 with internal cooling

4364
Setting screws "face" synchro tapping chucks, with conventional int. cooling

4605 Reduction bush sealed

4606 GÜHROJET reduction bush

Threading tool:
shank diameter x square



Tapping chucks



CONFIGURATION OF SYNCHRO TAPPING CHUCKS FOR CONVENTIONAL COOLING

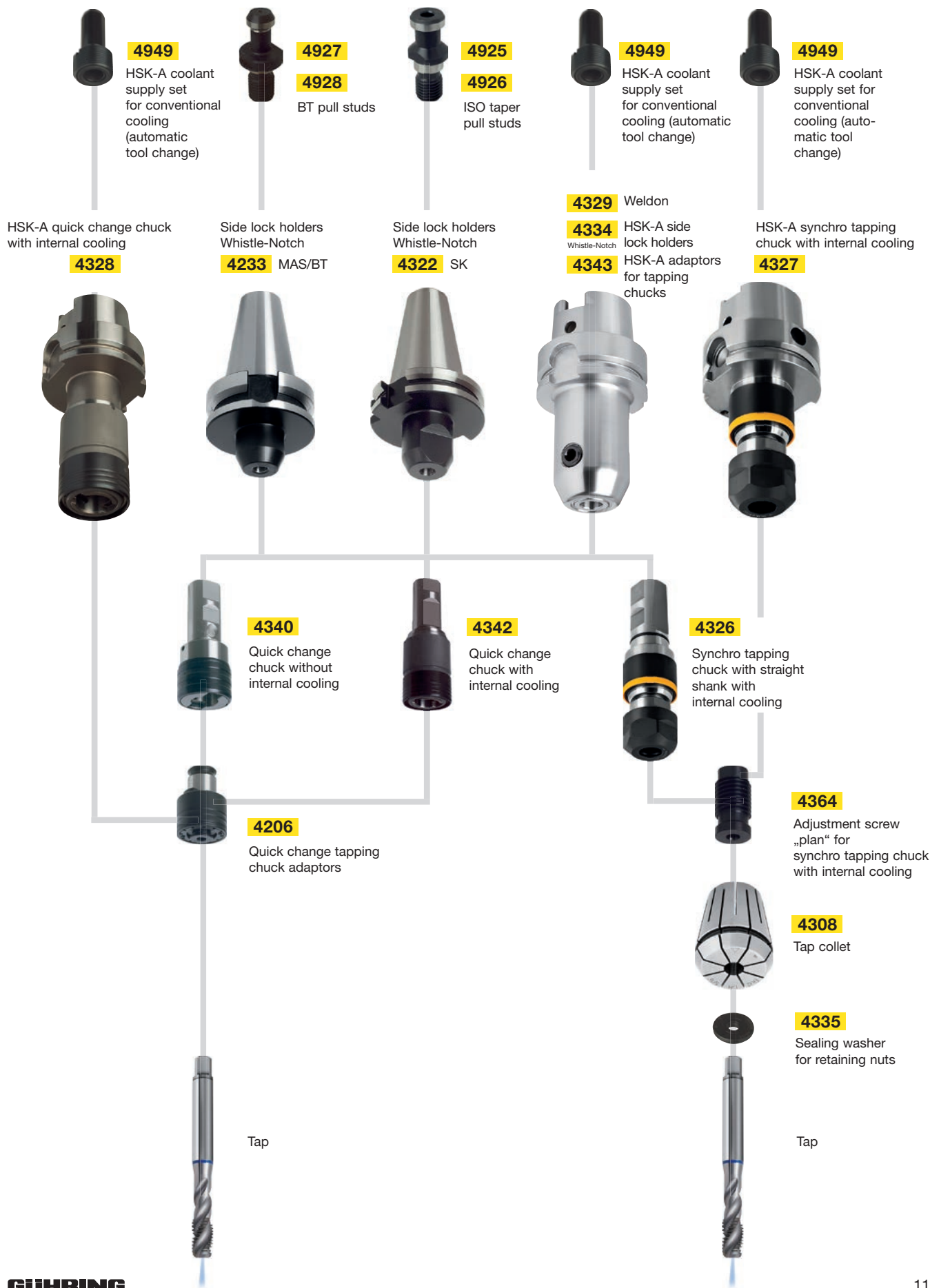

Tapping chucks



HSK-A hydraulic synchro tapping chucks with internal cooling

Article no. **4601**



Product information:

- HSK-A according to ISO 12164-1 / DIN 69893-1
- balancing quality: G 6.3 / 15,000 rpm
- coolant pressure up to max. 80 bar
- compensates synchronisation errors
- minimum length compensation ± 0.3 mm in pushing and pulling direction
- convenient hydraulic clamping using reduction bushes with active drive

suitable accessories separately available:

- adjusting screws “face” art. no. 4364
- adjustment key, art. no. 4912, type B for adjusting screws
- replacement clamping screw (2) art. no. 4241
- hexagonal key (2), art. no. 4912
- reduction bushes art. no. 4605 or 4606
- coolant supply set art. no. 4949

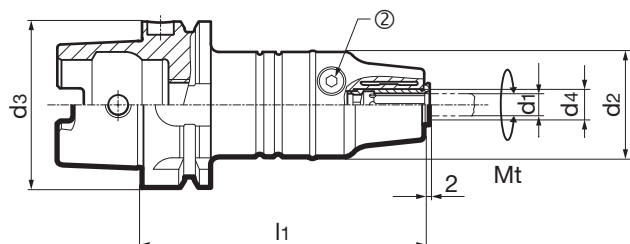

Article no. **4601**

d3	for threads	d1 mm	d2 mm	d4 mm	l1 mm	Mt max. Nm	②	②	kg	Order no.
HSK-A 63	M2-M12	2.8-10.0	40.0	12	106.5	26	4241 8.000	4912 4.600	1.2	4601 12.063
HSK-A 63	M4,5-M20	6.0-16.0	40.0	20	120.5	90	4241 10.003	4912 5.000	1.3	4601 20.063
HSK-A 100	M2-M12	2.8-10.0	40.0	12	113.0	26	4241 8.000	4912 4.600	2.6	4601 12.100
HSK-A 100	M4,5-M20	6.0-16.0	40.0	20	127.0	90	4241 10.003	4912 5.000	2.7	4601 20.100

ISO taper hydraulic synchro tapping chucks with internal cooling

Article no. **4576**



Product information:

- SK30 according to DIN ISO 7388-1
- SK40 according to DIN ISO 7388-1 form AD/AF
- balancing quality: G 6.3 / 15,000 rpm
- coolant pressure up to max. 80 bar
- compensates synchronisation errors
- minimum length compensation ± 0.3 mm in pushing and pulling direction
- convenient hydraulic clamping using reduction bushes with active drive

suitable accessories separately available:

- adjusting screws “face” art. no. 4364
- adjustment key, art. no. 4912, type B for adjusting screws
- replacement clamping screw (2) art. no. 4241
- hexagonal key (2), art. no. 4912
- reduction bushes art. no. 4605 or 4606
- pull studs art. no. 4925, 4926

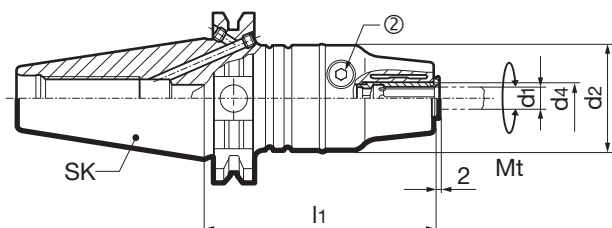

Article no. **4576**

SK	for threads	d1 mm	d2 mm	d4 mm	l1 mm	Mt max. Nm	②	②	kg	Order no.
SK 30	M2-M12	2.8-10.0	40.0	12	81.0	26	4241 8.000	4912 4.600	0.8	4576 12.030
SK 30	M4,5-M20	6.0-16.0	40.0	20	95.0	90	4241 10.003	4912 5.000	0.9	4576 20.030
SK 40	M2-M12	2.8-10.0	40.0	12	85.0	26	4241 8.000	4912 4.600	1.3	4576 12.040
SK 40	M4,5-M20	6.0-16.0	40.0	20	99.0	90	4241 10.003	4912 5.000	1.5	4576 20.040



MAS/BT hydraulic synchro tapping chucks with internal cooling

Article no. **4577**



Product information:

- MAS/BT30 according to DIN ISO 7388-2 form JD without coolant supply over collar
- MAS/BT according to DIN ISO 7388-2 form JD/JF (AD/B)
- balancing quality: G 6.3 / 15,000 rpm
- coolant pressure up to max. 80 bar
- compensates synchronisation errors
- minimum length compensation ± 0.3 mm in pushing and pulling direction
- convenient hydraulic clamping using reduction bushes with active drive

suitable accessories separately available:

- adjusting screws “face” art. no. 4364
- adjustment key, art. no. 4912, type B for adjusting screws
- replacement clamping screw (2) art. no. 4241
- hexagonal key (2), art. no. 4912
- reduction bushes art. no. 4605 or 4606
- BT pull studs art. nr. 4927, 4928

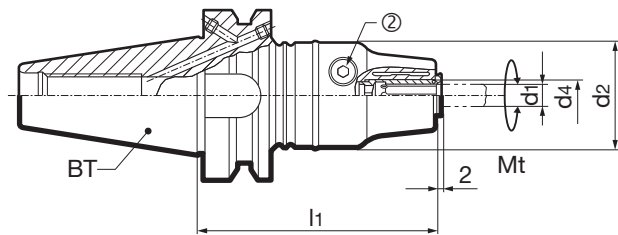

Article no. **4577**

BT	for threads	d1 mm	d2 mm	d4 mm	l1 mm	Mt max. Nm	②	②	kg	Order no.
BT 30	M2-M12	2.8-10.0	40.0	12	81.0	26	4241 8.000	4912 4.600	0.9	4577 12.030
BT 30	M4,5-M20	6.0-16.0	40.0	20	95.0	90	4241 10.003	4912 5.000	0.9	4577 20.030
BT 40	M2-M12	2.8-10.0	40.0	12	85.0	26	4241 8.000	4912 4.600	1.3	4577 12.040
BT 40	M4,5-M20	6.0-16.0	40.0	20	99.0	90	4241 10.003	4912 5.000	1.4	4577 20.040

Straight shank hydraulic synchro tapping chucks for internal cooling

Article no. **4525**



Product information:

- type 1: Straight shank similar to DIN 6535 HA
Type 2: Straight shank similar to DIN 1835 HB/HE
- balancing quality: G 6.3 / 15,000 rpm
- coolant pressure up to max. 80 bar
- compensates synchronisation errors
- minimum length compensation ± 0.3 mm in pushing and pulling direction
- convenient hydraulic clamping using reduction bushes with active drive
- adjusting screw enables 3 mm axial length readjustment

suitable accessories separately available:

- adjusting screws “face” art. no. 4364
- adjustment key, art. no. 4912, type B for adjusting screws
- replacement clamping screw (2) art. no. 4241
- hexagonal key (2), art. no. 4912
- reduction bushes art. no. 4605 or 4606

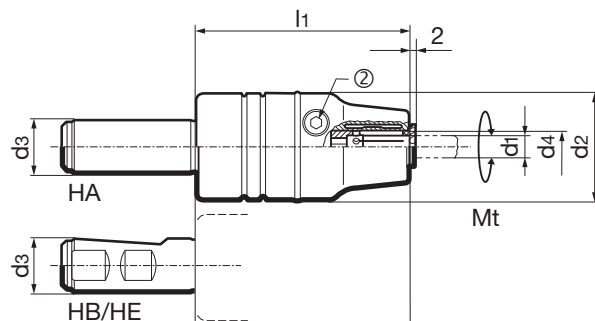

Article no. **4525**

d3 h6 mm	Shank	for threads	d1 mm	d2 mm	d4 mm	l1 mm	Mt max. Nm	②	②	kg	Order no.
20	HA	M2-M12	2.8-10.0	40	12	80	26	4241 8.000	4912 4.600	0.7	4525 12.020
20	HA	M4,5-M20	6.0-16.0	40	20	94	90	4241 10.003	4912 5.000	0.8	4525 20.020
25	HB	M2-M12	2.8-10.0	40	12	80	26	4241 8.000	4912 4.600	0.7	4525 12.025
25	HB	M4,5-M20	6.0-16.0	40	20	94	90	4241 10.003	4912 5.000	1.0	4525 20.025

Tapping chucks



Reduction bushes, sealed, for hydraulic synchro tapping chucks

Article no. **4605**



Product information:

- for clamping taps with square shank in GühringSynchro tapping chucks
- clamping Ø for tool shank tolerance h6-h9
- face side closed, therefore coolant leakproof for threading tools with IC
- positive drive of reduction bush in GühringSynchro tapping chucks
- position adjusting screw on the shank of the tap
- adjusting screw enables 3 mm axial length readjustment

suitable accessories separately available:

- IC adjusting screw "face" (1), art. no. 4364
- adjustment key, art. no. 4912, type B for adjusting screws
- MQL axial adjusting screw, art. no. 4305

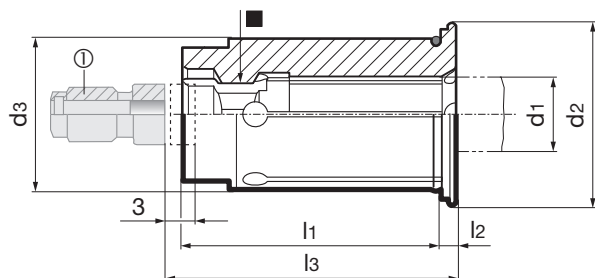

Article no.

4605

d3 mm	d1 mm	■ mm	Standard	d2 mm	l1 mm	l2 mm	l3 mm	①	for threads	Order no.
12	2.8	2.1	DIN	16.5	29.0	2.0			M2/M2.2/M2.5/M4	4605 2.812
12	3.5	2.7	DIN	16.5	29.0	2.0			M3/M4/M5	4605 3.512
12	4.0	3.2	JIS	16.5	29.0	2.0			M3/M3,5	4605 4.012
12	4.5	3.4	DIN	16.5	29.0	2.0	26.0	4364 5.020	M4/M6	4605 4.512
12	4.9	3.8	ANSI	16.5	29.0	2.0	26.0	4364 5.020	10-24 / 10-32	4605 4.912
12	5.0	4.0	JIS	16.5	29.0	2.0	26.0	4364 5.020	M4/M4,5/M5	4605 5.012
12	5.5	4.5	JIS	16.5	29.0	2.0	26.0	4364 5.020	M5	4605 5.512
12	6.0	4.9	DIN	16.5	29.0	2.0	26.0	4364 6.020	M4,5/M5/M6/M7/M8	4605 6.012
12	6.2	5.0	JIS	16.5	29.0	2.0	26.0	4364 6.020	M7/M8	4605 6.212
12	6.4	4.8	ANSI	16.5	29.0	2.0	26.0	4364 6.020	1/4-20 / 1/4-28	4605 6.412
12	7.0	5.5	DIN/JIS	16.5	29.0	2.0	26.0	4364 7.020	M7/M9/M10	4605 7.012
12	7.9	5.9	ANSI	16.5	29.0	2.0	26.0	4364 8.020	1/16-27 / 1/8-27	4605 7.912
12	8.0	6.2	DIN	16.5	29.0	2.0	31.0	4364 8.020	M8/M11	4605 8.012
12	8.2	6.1	ANSI	16.5	29.0	2.0	31.0	4364 8.020	7/16-14 / 7/16-20	4605 8.212
12	8.5	6.5	JIS	16.5	29.0	2.0	31.0	4364 8.020	M12	4605 8.512
12	9.0	7.0	DIN	16.5	29.0	2.0	32.0	4364 9.020	M9/M12	4605 9.012
12	9.3	6.9	ANSI	16.5	29.0	2.0	32.0	4364 9.020	1/2-13 / 1/2-20	4605 9.312
12	9.6	7.2	ANSI	16.5	29.0	2.0	33.0	4364 9.020	3/8-16 / 3/8-24	4605 9.612
12	10.0	8.0	DIN	16.5	29.0	2.0	36.0	4364 10.020	M10	4605 10.012
12	5.5	4.1	ANSI	16.5	29.0	2.0	26.0	4364 5.020	12-24 / 12-28	4605 15.512
12	6.0	4.5	JIS	16.5	29.0	2.0	26.0	4364 6.020	M6	4605 16.012
12	8.0	6.5	JIS	16.5	29.0	2.0	31.0	4364 8.020	M11	4605 18.012
12	8.0	6.0	ANSI	16.5	29.0	2.0	31.0	4364 8.020	5/16-18 / 5/16-24	4605 28.012
20	6.0	4.9	DIN	24.1	34.0	2.0	26.0	4364 6.032	M4,5/M5/M6/M7/M8	4605 6.020
20	6.2	5.0	JIS	24.1	34.0	2.0	26.0	4364 6.032	M7/M8	4605 6.220
20	6.4	4.8	ANSI	24.1	34.0	2.0	26.0	4364 6.032	1/4-20 / 1/4-28	4605 6.420
20	7.0	5.5	DIN/JIS	24.1	34.0	2.0	26.0	4364 7.032	M7/M9/M10	4605 7.020
20	7.9	5.9	ANSI	24.1	34.0	2.0	34.0	4364 8.032	1/16-27 / 1/8-27	4605 7.920
20	8.0	6.2	DIN	24.1	34.0	2.0	31.0	4364 8.032	M8/M11	4605 8.020
20	8.2	6.1	ANSI	24.1	34.0	2.0	31.0	4364 8.032	7/16-14 / 7/16-20	4605 8.220
20	8.5	6.5	JIS	24.1	34.0	2.0	31.0	4364 8.032	M12	4605 8.520
20	9.0	7.0	DIN	24.1	34.0	2.0	32.0	4364 9.032	M9/M12	4605 9.020
20	9.3	6.9	ANSI	24.1	34.0	2.0	32.0	4364 9.032	1/2-13 / 1/2-20	4605 9.320
20	9.6	7.2	ANSI	24.1	34.0	2.0	33.0	4364 9.032	3/8-16 / 3/8-24	4605 9.620
20	10.0	8.0	DIN	24.1	34.0	2.0	36.0	4364 10.032	M10	4605 10.020
20	10.5	8.0	JIS	24.1	34.0	2.0	36.0	4364 10.032	M14	4605 10.520
20	10.8	8.1	ANSI	24.1	34.0	2.0	35.0	4364 10.032	9/16-12 / 9/16-18	4605 10.820
20	11.0	9.0	DIN	24.1	34.0	2.0	37.0	4364 11.032	M14	4605 11.020
20	12.0	9.0	DIN	24.1	34.0	2.0	37.0	4364 11.032	M16	4605 12.020
20	12.1	9.1	ANSI	24.1	34.0	2.0	36.0	4364 11.032	5/8-11 / 5/8-18	4605 12.120
20	12.5	10.0	JIS	24.1	34.0	2.0	38.0	4364 11.032	M16	4605 12.520
20	13.0	10.0	JIS	24.1	34.0	2.0	38.0	4364 11.032	M17	4605 13.020
20	14.0	11.0	DIN/JIS	24.1	34.0	2.0	39.0	4364 14.032	M18	4605 14.020
20	14.2	10.6	ANSI	24.1	34.0	2.0	38.0	4364 14.032	1/4-18	4605 14.220
20	14.9	11.2	ANSI	24.1	34.0	2.0	39.0	4364 14.032	3/4-10 / 3/4-16	4605 14.920
20	15.0	12.0	JIS	24.1	34.0	2.0	40.0	4364 16.032	M20	4605 15.020
20	16.0	12.0	DIN	24.1	34.0	2.0	41.0	4364 16.032	M20	4605 16.020
20	8.0	6.5	JIS	24.1	34.0	2.0	31.0	4364 8.032	M11	4605 18.020

Tapping chucks



Article no.

4605

d3 mm	d1 mm	■ mm	Standard	d2 mm	l1 mm	l2 mm	l3 mm	①	for threads	Order no.
20	6.0	4.5	JIS	24.1	34.0	2.0	26.0	4364 6.032	M6	4605 26.020
20	8.0	6.0	ANSI	24.1	34.0	2.0	31.0	4364 8.032	5/16-18 / 5/16-24	4605 28.020



Product information:

- for clamping taps with square shank in Gühring synchro tapping chucks
- clamping Ø for tool shank tolerance h6-h9
- with coolant slots for peripheral cooling
- positive drive of reduction bush in Gühring synchro tapping chucks
- position adjusting screw on the shank of the tap
- adjusting screw enables 3 mm axial length readjustment

suitable accessories separately available:

- IC adjusting screw "face" (1), art. no. 4364
- adjustment key, art. no. 4912, type B for adjusting screws
- MQL axial adjusting screw, art. no. 4305

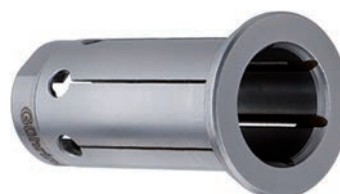
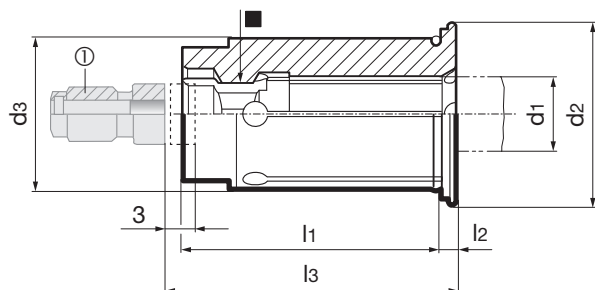

Tapping chucks

Article no.

4606

d3 mm	d1 mm	■ mm	Standard	d2 mm	l1 mm	l2 mm	l3 mm	①	for threads	Order no.
12	2.8	2.1	DIN	16.5	29.0	2.0			M2/M2.2/M2.5/M4	4606 2.812
12	3.5	2.7	DIN	16.5	29.0	2.0			M3/M4/M5	4606 3.512
12	3.5	2.7	ANSI	16.5	29.0	2.0			6-32 / 6-40	4606 3.612
12	4.0	3.2	JIS	16.5	29.0	2.0			M3/M3,5	4606 4.012
12	4.2	3.3	ANSI	16.5	29.0	2.0			8-32 / 8-36	4606 4.312
12	4.5	3.4	DIN	16.5	29.0	2.0	26.0	4364 5.020	M4/M6	4606 4.512
12	4.9	3.8	ANSI	16.5	29.0	2.0	26.0	4364 5.020	10-24 / 10-32	4606 4.912
12	5.0	4.0	JIS	16.5	29.0	2.0	26.0	4364 5.020	M4/M4,5/M5	4606 5.012
12	5.5	4.5	JIS	16.5	29.0	2.0	26.0	4364 5.020	M5	4606 5.512
12	6.0	4.9	DIN	16.5	29.0	2.0	26.0	4364 6.020	M4,5/M5/M6/M7/M8	4606 6.012
12	6.2	5.0	JIS	16.5	29.0	2.0	26.0	4364 6.020	M7/M8	4606 6.212
12	6.4	4.8	ANSI	16.5	29.0	2.0	26.0	4364 6.020	1/4-20 / 1/4-28	4606 6.412
12	7.0	5.5	DIN/JIS	16.5	29.0	2.0	26.0	4364 7.020	M7/M9/M10	4606 7.012
12	7.9	5.9	ANSI	16.5	29.0	2.0	31.0	4364 8.020	1/16-27 / 1/8-27	4606 7.912
12	8.0	6.2	DIN	16.5	29.0	2.0	31.0	4364 8.020	M8/M11	4606 8.012
12	8.2	6.1	ANSI	16.5	29.0	2.0	31.0	4364 8.020	7/16-14 / 7/16-20	4606 8.212
12	8.5	6.5	JIS	16.5	29.0	2.0	31.0	4364 8.020	M12	4606 8.512
12	9.0	7.0	DIN	16.5	29.0	2.0	32.0	4364 9.020	M9/M12	4606 9.012
12	9.3	6.9	ANSI	16.5	29.0	2.0	32.0	4364 9.020	1/2-13 / 1/2-20	4606 9.312
12	9.6	7.2	ANSI	16.5	29.0	2.0	33.0	4364 9.020	3/8-16 / 3/8-24	4606 9.612
12	10.0	8.0	DIN	16.5	29.0	2.0	36.0	4364 10.020	M10	4606 10.012
12	5.5	4.1	ANSI	16.5	29.0	2.0	26.0	4364 5.020	12-24 / 12-28	4606 15.512
12	6.0	4.5	JIS	16.5	29.0	2.0	26.0	4364 6.020	M6	4606 16.012
12	8.0	6.5	JIS	16.5	29.0	2.0	31.0	4364 8.020	M11	4606 18.012
12	8.0	6.0	ANSI	16.5	29.0	2.0	31.0	4364 8.020	5/16-18 / 5/16-24	4606 28.012
20	6.0	4.9	DIN	24.1	34.0	2.0	26.0	4364 6.032	M4,5/M5/M6/M7/M8	4606 6.020
20	6.2	5.0	JIS	24.1	34.0	2.0	26.0	4364 6.032	M7/M8	4606 6.220
20	6.4	4.8	ANSI	24.1	34.0	2.0	26.0	4364 6.032	1/4-20 / 1/4-28	4606 6.420
20	7.0	5.5	DIN/JIS	24.1	34.0	2.0	26.0	4364 7.032	M7/M9/M10	4606 7.020
20	7.9	5.9	ANSI	24.1	34.0	2.0	31.0	4364 8.032	1/16-27 / 1/8-27	4606 7.920
20	8.0	6.2	DIN	24.1	34.0	2.0	31.0	4364 8.032	M8/M11	4606 8.020
20	8.2	6.1	ANSI	24.1	34.0	2.0	31.0	4364 8.032	7/16-14 / 7/16-20	4606 8.220
20	8.5	6.5	JIS	24.1	34.0	2.0	31.0	4364 8.032	M12	4606 8.520
20	9.0	7.0	DIN	24.1	34.0	2.0	32.0	4364 9.032	M9/M12	4606 9.020
20	9.3	6.9	ANSI	24.1	34.0	2.0	32.0	4364 9.032	1/2-13 / 1/2-20	4606 9.320
20	9.6	7.2	ANSI	24.1	34.0	2.0	33.0	4364 9.032	3/8-16 / 3/8-24	4606 9.620
20	10.0	8.0	DIN	24.1	34.0	2.0	36.0	4364 10.032	M10	4606 10.020
20	10.5	8.0	JIS	24.1	34.0	2.0	36.0	4364 10.032	M14	4606 10.520
20	10.8	8.1	ANSI	24.1	34.0	2.0	35.0	4364 10.032	9/16-12 / 9/16-18	4606 10.820
20	11.0	9.0	DIN	24.1	34.0	2.0	37.0	4364 11.032	M14	4606 11.020
20	12.0	9.0	DIN	24.1	34.0	2.0	37.0	4364 11.032	M16	4606 12.020
20	12.1	9.1	ANSI	24.1	34.0	2.0	36.0	4364 11.032	5/8-11 / 5/8-18	4606 12.120
20	12.5	10.0	JIS	24.1	34.0	2.0	38.0	4364 11.032	M16	4606 12.520
20	13.0	10.0	JIS	24.1	34.0	2.0	38.0	4364 11.032	M17	4606 13.020
20	14.0	11.0	DIN/JIS	24.1	34.0	2.0	39.0	4364 14.032	M18	4606 14.020
20	14.2	10.6	ANSI	24.1	34.0	2.0	38.0	4364 14.032	1/4-18	4606 14.220
20	14.9	11.2	ANSI	24.1	34.0	2.0	39.0	4364 14.032	3/4-10 / 3/4-16	4606 14.920
20	15.0	12.0	JIS	24.1	34.0	2.0	40.0	4364 16.032	M20	4606 15.020



Article no.

4606

d3 mm	d1 mm	■ mm	Standard	d2 mm	l1 mm	l2 mm	l3 mm	①	for threads	Order no.
20	16.0	12.0	DIN	24.1	34.0	2.0	41.0	4364 16.032	M20	4606 16.020
20	8.0	6.5	JIS	24.1	34.0	2.0	31.0	4364 8.032	M11	4606 18.020
20	6.0	4.5	JIS	24.1	34.0	2.0	26.0	4364 6.032	M6	4606 26.020
20	8.0	6.0	ANSI	24.1	34.0	2.0	31.0	4364 8.032	5/16-18 / 5/16-24	4606 28.020



Product information:

- for hydraulic synchro tapping chucks art. no. 4601, 4576, 4577 and 4525
- for synchro tapping chucks art. no. 4326 and 4327
- for conventional internal cooling
- with plane stop for standard shank ends
- position adjusting screw on the shank of the tap
- adjusting screw enables 3 mm axial length readjustment

Scope of delivery:

- with O-ring for secure seal

suitable accessories separately available:

- adjustment key, art. no. 4912, type B for adjusting screws

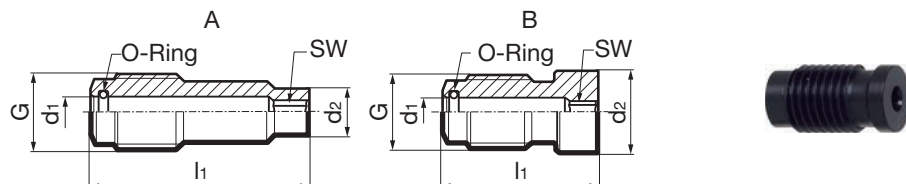

Article no. **4364**

Size	G	for shank Ø x ■ mm	d1 mm	d2 mm	l1 mm	SW mm	Type	Code no.	Order no.
ER20	M8 x 1	<6	3.6	3.3	23.7	2.0	A	5.020	4364 5.020
ER20	M8 x 1	6x4,9	3.6	4.8	23.7	2.5	A	6.020	4364 6.020
ER20	M8 x 1	7x5,5	3.6	5.4	23.7	2.5	A	7.020	4364 7.020
ER20	M8 x 1	8x6,2	3.6	5.8	18.7	2.5	A	8.020	4364 8.020
ER20	M8 x 1	9x7	3.6	6.9	17.7	2.5	A	9.020	4364 9.020
ER20	M8 x 1	10x8	3.6	7.8	13.7	2.5	B	10.020	4364 10.020
ER20	M8 x 1	11x9	3.6	8.8	14.8	2.5	B	11.020	4364 11.020
ER32	M10X1	6x4,9	4.1	3.3	33.0	2.0	A	5.032	4364 5.032
ER32	M10X1	6x4,9	4.1	4.8	34.0	3.0	A	6.032	4364 6.032
ER32	M10X1	7x5,5	4.1	5.4	33.8	3.0	A	7.032	4364 7.032
ER32	M10X1	8x6,2	4.1	6.1	28.8	3.0	A	8.032	4364 8.032
ER32	M10X1	9x7	4.1	6.9	28.2	3.0	A	9.032	4364 9.032
ER32	M10X1	10x8	4.1	7.8	23.8	3.0	A	10.032	4364 10.032
ER32	M10X1	11x9 & 12x9	4.1	8.8	22.9	3.0	A	11.032	4364 11.032
ER32	M10X1	14x11	4.1	10.8	20.6	3.0	B	14.032	4364 14.032
ER32	M10X1	16x12	4.1	11.8	19.6	3.0	B	16.032	4364 16.032
ER32	M10X1	18x14,5 & 20x16	4.1	14.3	18.0	3.0	B	18.032	4364 18.032



Synchro tapping chucks with straight shank and internal cooling

Article no. 4326



Product information:

- combination shank similar to DIN 1835
- compensates synchronisation errors
- minimum length compensation ± 0.5 mm in pushing and pulling direction
- coolant pressure up to max. 80 bar

Scope of delivery:

- incl. sealed IC/ER clamping nut art. no. 4306 (*see torque)

suitable accessories separately available:

- replacement IC/ER clamping nut, art. no. 4306
- thread tap collet chuck, art. no. 4308
- clamping key art. no. 4913
- sealing plug art. no. 4335
- adjusting screws "face" art. no. 4364
- adjustment key, art. no. 4912, type B for adjusting screws

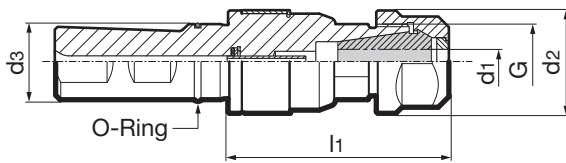

Article no. 4326

d3 mm	Size	for threads	d1 mm	d2 mm	l1 mm	Torque Nm	G	kg	Order no.
25	ER20	M4-M14	4.0-11.0	34	73.0	35	M25 X1.5	0.5	4326 20.025
25	ER32	M4-M30	4.0-20.0	50	87.5	136	M40 X1.5	1.3	4326 32.025

HSK-A synchro tapping chucks with internal coolant

Article no. 4327



Product information:

- HSK-A according to ISO 12164-1 / DIN 69893-1
- compensates synchronisation errors
- minimum length compensation ± 0.5 mm in pushing and pulling direction
- coolant pressure up to max. 80 bar

Scope of delivery:

- incl. sealed IC/ER clamping nut art. no. 4306 (*see torque)

suitable accessories separately available:

- replacement IC/ER clamping nut, art. no. 4306
- thread tap collet chuck, art. no. 4308
- clamping key art. no. 4913
- sealing plug art. no. 4335
- coolant supply set art. no. 4949
- adjusting screws "face" art. no. 4364
- adjustment key, art. no. 4912, type B for adjusting screws

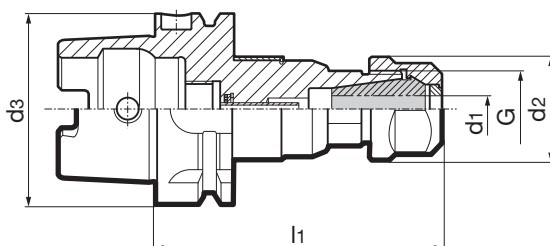

Article no. 4327

d3	Size	for threads	d1 mm	d2 mm	l1 mm	Torque Nm	G	kg	Order no.
HSK-A 63	ER20	M4-M14	4.0-11.0	34	95.5	35	M25 X1.5	0.5	4327 20.063
HSK-A 63	ER20	M4-M14	4.0-11.0	34	160.0	35	M25 X1.5	1.5	4327 20.163
HSK-A 63	ER32	M4-M30	4.0-20.0	50	109.0	136	M40 X1.5	1.5	4327 32.063
HSK-A 100	ER20	M4-M14	4.0-11.0	34	102.0	35	M25 X1.5	2.5	4327 20.100
HSK-A 100	ER32	M4-M30	4.0-20.0	50	115.5	136	M40 X1.5	2.7	4327 32.100

Tapping chucks



Tapping collets

Article no. **4308**

Product information:

- for clamping threading tools with square shank in synchro tapping chucks or collet chucks
- smaller Ø 4mm are clamped with collet, art. no. 4307 without sq. drive
- tightening torque see clamping nuts art. no. 4306
- clamping ranges:
 ER16: Ø 4.5 – Ø 8.0
 ER20: Ø 4.0 – Ø 11.0
 ER25: Ø 4.5 – Ø 12.0
 ER32: Ø 4.0 – Ø 20.0
 ER40: Ø 7.0 – Ø 22.0

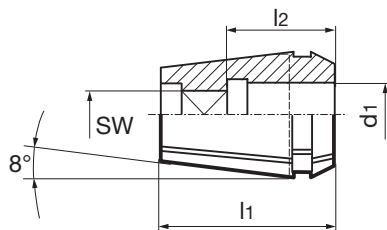

Article no.

4308

Size	for shank Ø d1 h9 mm	SW mm	l1 mm	l2 mm	Order no.
ER16	4.5	3.4	26.0	15	4308 4.516
ER16	5.5	4.3	27.5	18	4308 5.516
ER16	6.0	4.9	27.5	18	4308 6.016
ER16	7.0	5.5	27.5	18	4308 7.016
ER16	8.0	6.3	27.5	22	4308 8.016
ER20	4.0	3.2	31.5	15	4308 4.020
ER20	4.5	3.4	31.5	15	4308 4.520
ER20	5.5	4.3	31.5	18	4308 5.520
ER20	6.0	4.9	31.5	18	4308 6.020
ER20	7.0	5.5	31.5	18	4308 7.020
ER20	8.0	6.3	31.5	22	4308 8.020
ER20	9.0	7.1	31.5	22	4308 9.020
ER20	10.0	8.0	31.5	25	4308 10.020
ER20	11.0	9.0	31.5	25	4308 11.020
ER25	4.5	3.4	34.0	15	4308 4.525
ER25	5.5	4.3	34.0	18	4308 5.525
ER25	6.0	4.9	34.0	18	4308 6.025
ER25	7.0	5.5	34.0	18	4308 7.025
ER25	8.0	6.3	34.0	22	4308 8.025
ER25	9.0	7.1	34.0	22	4308 9.025
ER25	10.0	8.0	34.0	25	4308 10.025
ER25	11.0	9.0	34.0	25	4308 11.025
ER25	12.0	9.0	34.0	25	4308 12.025
ER32	4.0	3.2	40.0	15	4308 4.032
ER32	4.5	3.4	40.0	15	4308 4.532
ER32	5.5	4.3	40.0	18	4308 5.532
ER32	6.0	4.9	40.0	18	4308 6.032
ER32	7.0	5.5	40.0	18	4308 7.032
ER32	8.0	6.3	40.0	22	4308 8.032
ER32	9.0	7.1	40.0	22	4308 9.032
ER32	10.0	8.0	40.0	25	4308 10.032
ER32	11.0	9.0	40.0	25	4308 11.032
ER32	12.0	9.0	40.0	25	4308 12.032
ER32	14.0	11.2	40.0	25	4308 14.032
ER32	16.0	12.5	40.0	25	4308 16.032
ER32	18.0	14.5	40.0	25	4308 18.032
ER32	20.0	16.0	40.0	28	4308 20.032
ER40	7.0	5.5	46.0	18	4308 7.040
ER40	8.0	6.3	46.0	22	4308 8.040
ER40	9.0	7.1	46.0	22	4308 9.040
ER40	10.0	8.0	46.0	25	4308 10.040
ER40	11.0	9.0	46.0	25	4308 11.040
ER40	12.0	9.0	46.0	25	4308 12.040
ER40	14.0	11.2	46.0	25	4308 14.040
ER40	16.0	12.5	46.0	25	4308 16.040
ER40	18.0	14.5	46.0	25	4308 18.040
ER40	20.0	16.0	46.0	28	4308 20.040
ER40	22.0	18.0	46.0	28	4308 22.040

Tapping chucks



HSK-A basic adaptors for tapping chucks

Article no. **4343**



Product information:

- HSK-A according to ISO 12164-1 / DIN 69893-1
- for quick change chucks and synchro tapping chucks with straight shank (except art. no. 4342)

Scope of delivery:

- clamping screw art. No. 4903 code no. 16.001

suitable accessories separately available:

- coolant supply set art. no. 4949
- replacement clamping screw, art. no. 4903

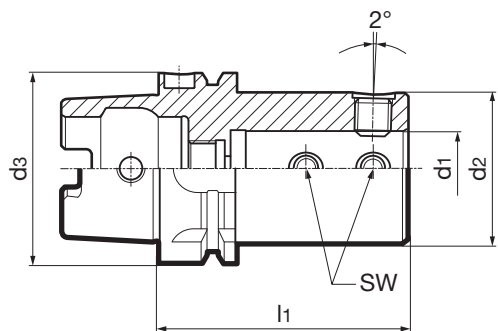

Article no. **4343**

d3	d1 mm	d2 mm	l1 mm	SW mm	kg	Order no.
HSK-A 50	25	50	80	6	0.8	4343 25.050
HSK-A 63	25	50	82	6	1.2	4343 25.063
HSK-A 80	25	50	87	6	3.1	4343 25.080
HSK-A 100	25	50	89	6	2.8	4343 25.100

Quick change tapping chucks without internal coolant

Article no. **4340**



Product information:

- combination shank similar to DIN 1835
- bearing-led length compensation

suitable accessories separately available:

- quick change tapping chucks art. no. 4206

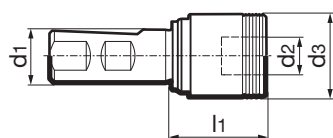

Article no. **4340**

for threads	d1 mm	d2 mm	d3 mm	l1 mm	Tension/Pressure mm	Order no.
M3-M12	25	19	38.5	41.5	9,0	4340 19.025
M8-M20	25	31	55.3	63.7	9,0	4340 31.025



Quick change tapping chucks with internal coolant

Article no. **4342**



Product information:

- combination shank similar to DIN 1835
- sealed coolant functional elements
- coolant pressure max. 50 bar

suitable accessories separately available:

- quick change tapping chucks art. no. 4206

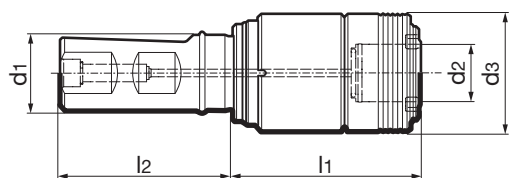

Article no. **4342**

for threads	d1 mm	d2 mm	d3 mm	l1 mm	l2 mm	Tension/Pressure	Order no.
M 3-M12	25	19	39	62	57	7,5	4342 19.025
M 8-M20	25	31	60	98	57	10,0	4342 31.025

HSK-A quick change tapping chucks with internal coolant

Article no. **4328**



Product information:

- HSK-A according to ISO 12164-1 / DIN 69893-1
- bearing-led length compensation
- coolant pressure max. 50 bar

suitable accessories separately available:

- quick change tapping chucks art. no. 4206

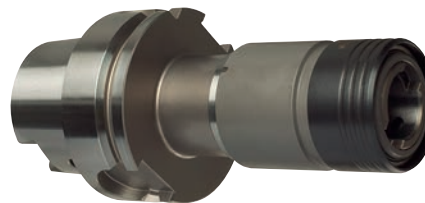
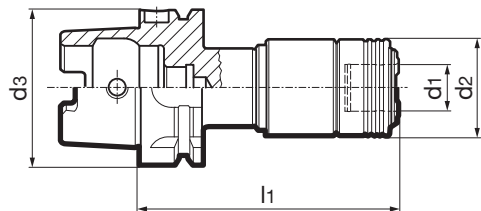

Article no. **4328**

d3	for threads	d1 mm	d2 mm	l1 mm	Tension/Pressure mm	Order no.
HSK-A 63	M3,5-M12	19	39	105	7,5	4328 19.063
HSK-A 63	M3,5-M20	31	60	140	10,0	4328 31.063



Quick change tapping chuck adaptors

Article no. 4206



Product information:

- suitable for HSS threading tools
- with safety clutch
- suitable for internal coolant supply max. 50 bar
- for solid carbide threading tools with a flute on the shank to ensure additional grip

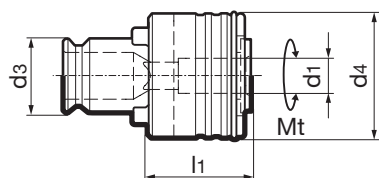

Article no. 4206

for thread	for shank Ø x ■ d1 mm	d3 mm	Mt max. Nm	d4 mm	l1 mm	Order no.
M3-M12	2,2x1,8	19	32	32	25	4206 19.022
M3-M12	2,5x2,1	19	32	32	25	4206 19.025
M3-M12	2,8x2,1	19	32	32	25	4206 19.028
M3-M12	3,5x2,7	19	32	32	25	4206 19.035
M3-M12	4x3	19	32	32	25	4206 19.040
M3-M12	4,5x3,4	19	32	32	25	4206 19.045
M3-M12	5,5x4,5	19	32	32	25	4206 19.055
M3-M12	6x4,9	19	32	32	25	4206 19.060
M3-M12	7x5,5	19	32	32	25	4206 19.070
M3-M12	8x6,2	19	32	32	25	4206 19.080
M3-M12	9x7	19	32	32	25	4206 19.090
M3-M12	10x8	19	32	32	25	4206 19.100
M8-M20	6x4,9	31	120	50	34	4206 31.060
M8-M20	7x5,5	31	120	50	34	4206 31.070
M8-M20	8x6,2	31	120	50	34	4206 31.080
M8-M20	9x7	31	120	50	34	4206 31.090
M8-M20	10x8	31	120	50	34	4206 31.100
M8-M20	11x9	31	120	50	34	4206 31.110
M8-M20	12x9	31	120	50	34	4206 31.120
M8-M20	14x11	31	120	50	34	4206 31.140
M8-M20	16x12	31	120	50	34	4206 31.160

Tapping chucks

MQL

BY GÜHRING

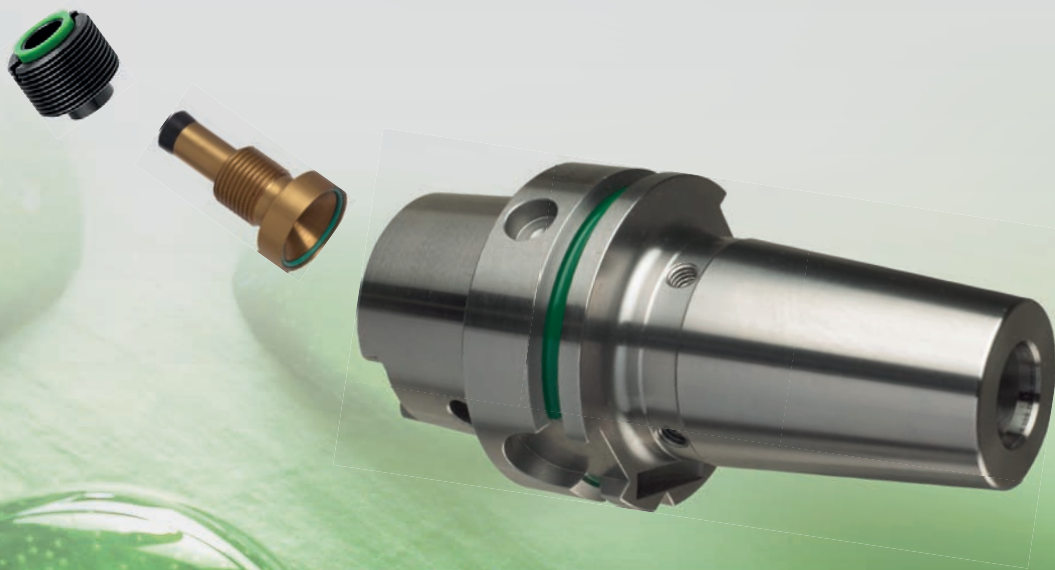

1 MQL

BY GÜHRING

Our products for the MQL 1-channel technology are identified by this symbol.

Visual feature of the 1-channel system is the gold coloured MQL length setting screw.



2 MQL

BY GÜHRING

Our products for the MQL 2-channel technology are identified by this symbol.

Visual feature of the 2-channel system is the black coloured MQL length setting screw.





MQL SYSTEM FINDER

			HSK-A for automatic tool change	HSK-A for manual tool change
1 MQL BY GÜHRING	Hydraulic chucks		Art. no. 4210	Art. no. 4209
	Shrink fit chucks		Art. no. 4741	Art. no. 4735
	Synchro chucks		Art. no. 4330	Art. no. 4298
2 MQL BY GÜHRING	Hydraulic chucks		Art. no. 4612	Art. no. 4611
	Shrink fit chucks		Art. no. 4614	Art. no. 4613
	Synchro chucks		Art. no. 4341	Art. no. 4298

4:1

When selecting the tool holders please note: the ratio of cross-section A (mm²) of the supply pipe in the MQL 2-channel supply set to the sum of the cross-sections of the tool coolant duct exits should be maximum 4:1. This achieves quick reaction times when switching on the 2-channel MQL.

automatic tool change

manual tool change

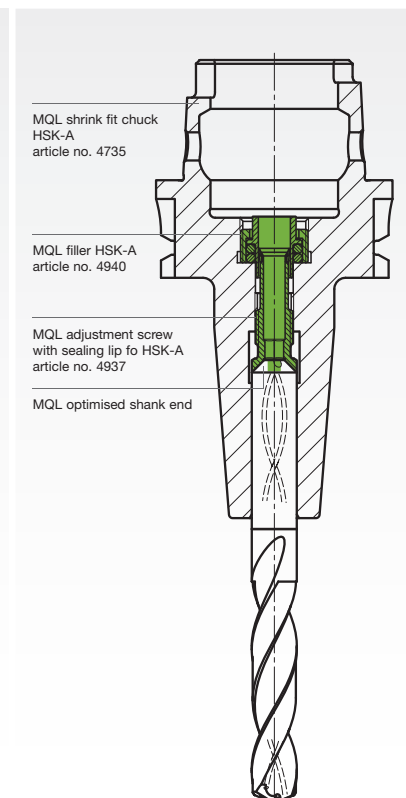
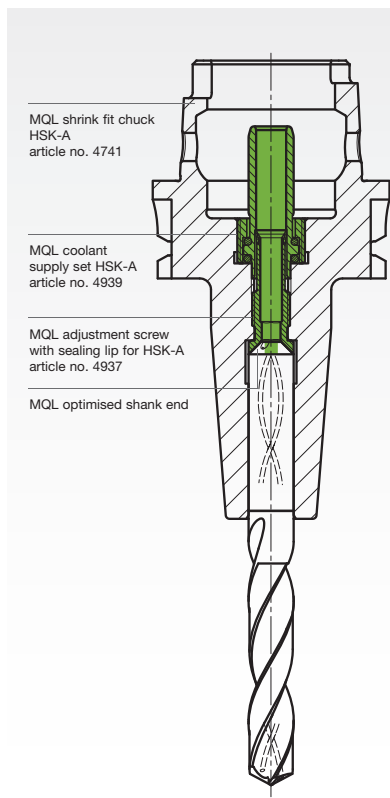

MQL technology



CONFIGURATION OF GÜHROSYNC TAPPING CHUCKS FOR MQL



MQL shrink fit chucks
HSK-A
auto. tool change



man. tool change



MQL hydraulic tapping chucks
HSK-A
auto. tool change



man. tool change



4508
MQL coolant supply set
for single channel
HSK-A



MQL HSK-A hydraulic
synchro tapping chucks
for single channel
auto. tool change



4511
MQL coolant supply set
for 2 channel systems
HSK-A



MQL HSK-A hydraulic
synchro tapping chucks
for 2 channel systems
auto. tool change



4513
MQL coolant supply set
HSK-A (filler)



MQL HSK-A hydraulic
synchro tapping chucks
man. tool change

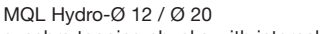

4524
MQL Hydro-Ø 12 / Ø 20
synchro tapping chucks with internal
cooling Ø 20



4305
MQL setting screws with internal cone
for MQL synchro tapping chucks



4605
Reduction bushes, sealed



4606
GÜHROJET reduction bushes





Threading tool with MQL shank:
shank diameter x square



CONFIGURATION OF MQL SYNCHRO TAPPING CHUCKS

4508 
Coolant supply set
for automatic tool change

4511 
MQL coolant supply set
for automatic tool change

4513 

MQL coolant supply set
for manual tool change



4330
HSK-A synchro
tapping chucks
for MQL single
channel systems
for automatic tool
change

4341
HSK-A synchro
tapping chucks
for MQL double
channel systems
for automatic tool
change

4298
HSK-A synchro
tapping chucks
for manual tool
change for MQL
single and double
channel systems

4305
MQL setting screw with internal taper
for MQL synchro tapping chucks

4308
tap collet

4335
sealing washer
for retaining nuts

tap





MQL 1-channel hydraulic chucks HSK-A (manual tool change)

Article no. **4209**



Product information:

- HSK-A according to ISO 12164-1 / DIN 69893-1
- for MQL 1-channel systems, Gühring MQL identifiable by green colour ring
- balancing quality: G 2.5 / 25,000 rpm or rev. < 1 gmm
- for tool shanks d1 h6
- axial length adjustment

Scope of delivery:

- MQL length adjusting screw with sealing lip (1), art. no. 4937
- MQL 1-channel filler element, art. no. 4940

suitable accessories separately available:

- hexagonal key (2), art. no. 4912
- replacement clamping screw (2) art. no. 4241
- MQL 1-channel filler element, art. no. 4940
- replacement sealing lip, art. no. 4617
- replacement MQL length adjusting screw with sealing lip (1), art. no. 4937

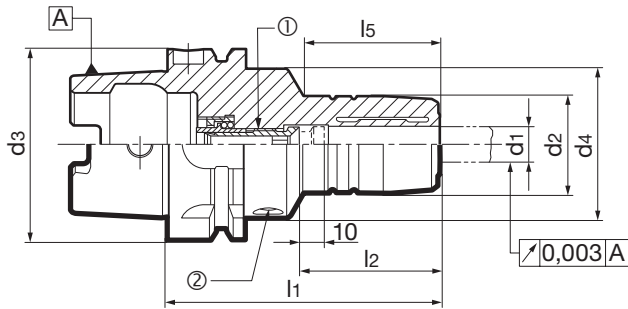

Article no.

4209

d3	d1 mm	d2 mm	d4 mm	l1 mm	l2 mm	l5 mm	①	②	②	Order no.
HSK-A 32	6	26.0	40.0	80.0	36.0	29.0	4937 6.032	4241 8.000	4912 4.000	4209 6.032
HSK-A 32	8	28.0	40.0	80.0	36.0	29.0	4937 8.032	4241 8.000	4912 4.000	4209 8.032
HSK-A 32	10	30.0	40.0	85.0	40.0	35.0	4937 10.032	4241 8.000	4912 4.000	4209 10.032
HSK-A 32	12	32.0	40.0	90.0	45.0	40.0	4937 12.032	4241 8.000	4912 4.000	4209 12.032
HSK-A 40	6	26.0	33.5	80.0	36.0	46.0	4937 6.040	4241 8.001	4912 4.000	4209 6.040
HSK-A 40	8	28.0	33.5	80.0	36.0	46.0	4937 8.040	4241 8.001	4912 4.000	4209 8.040
HSK-A 40	10	30.0	33.5	80.0	40.0	46.0	4937 10.040	4241 8.001	4912 4.000	4209 10.040
HSK-A 40	12	32.0	33.5	90.0	45.0	56.0	4937 12.040	4241 8.001	4912 4.000	4209 12.040
HSK-A 50	6	26.0	40.0	80.0	36.0	38.0	4937 6.050	4241 8.000	4912 4.000	4209 6.050
HSK-A 50	8	28.0	40.0	80.0	36.0	38.0	4937 8.050	4241 8.000	4912 4.000	4209 8.050
HSK-A 50	10	30.0	40.0	85.0	40.0	44.0	4937 10.050	4241 8.000	4912 4.000	4209 10.050
HSK-A 50	12	32.0	40.0	90.0	45.0	49.0	4937 12.050	4241 8.000	4912 4.000	4209 12.050
HSK-A 50	14	34.0	40.0	90.0	45.0	49.0	4937 14.050	4241 8.000	4912 4.000	4209 14.050
HSK-A 50	16	38.0	53.0	95.0	48.0	36.0	4937 16.050	4241 10.002	4912 5.000	4209 16.050
HSK-A 50	18	40.0	57.0	95.0	48.0	36.0	4937 18.050	4241 10.002	4912 5.000	4209 18.050
HSK-A 50	20	42.0	60.0	100.0	50.0	39.0	4937 20.050	4241 10.001	4912 5.000	4209 20.050
HSK-A 63	6	26.0	50.0	80.0	36.0	34.5	4937 6.100	4241 10.002	4912 5.000	4209 6.063
HSK-A 63	8	28.0	50.0	80.0	36.0	35.5	4937 8.100	4241 10.002	4912 5.000	4209 8.063
HSK-A 63	10	30.0	50.0	85.0	40.0	39.0	4937 10.100	4241 10.002	4912 5.000	4209 10.063
HSK-A 63	12	32.0	50.0	90.0	45.0	45.0	4937 12.100	4241 10.002	4912 5.000	4209 12.063
HSK-A 63	14	34.0	50.0	90.0	45.0	46.0	4937 14.100	4241 10.002	4912 5.000	4209 14.063
HSK-A 63	16	38.0	50.0	95.0	48.0	51.0	4937 16.100	4241 10.002	4912 5.000	4209 16.063
HSK-A 63	18	40.0	50.0	95.0	48.0	52.0	4937 18.100	4241 10.002	4912 5.000	4209 18.063
HSK-A 63	20	42.0	50.0	100.0	50.0	58.0	4937 20.100	4241 10.001	4912 5.000	4209 20.063
HSK-A 63	25	57.0	63.0	115.0	56.0	50.0	4937 25.100	4241 12.000	4912 6.000	4209 25.063
HSK-A 63	32	64.0	75.0	120.0	60.0	58.0	4937 32.100	4241 12.000	4912 6.000	4209 32.063
HSK-A 80	6	26.0	50.0	85.0	36.0	39.0	4937 6.100	4241 10.002	4912 5.000	4209 6.080
HSK-A 80	8	28.0	50.0	85.0	36.0	39.0	4937 8.100	4241 10.002	4912 5.000	4209 8.080
HSK-A 80	10	30.0	50.0	90.0	40.0	45.0	4937 10.100	4241 10.002	4912 5.000	4209 10.080
HSK-A 80	12	32.0	50.0	95.0	45.0	50.0	4937 12.100	4241 10.002	4912 5.000	4209 12.080
HSK-A 80	14	34.0	50.0	95.0	45.0	50.0	4937 14.100	4241 10.002	4912 5.000	4209 14.080
HSK-A 80	16	38.0	50.0	100.0	48.0	56.0	4937 16.100	4241 10.002	4912 5.000	4209 16.080
HSK-A 80	18	40.0	50.0	100.0	48.0	56.0	4937 18.100	4241 10.002	4912 5.000	4209 18.080
HSK-A 80	20	42.0	50.0	105.0	50.0	62.0	4937 20.100	4241 10.001	4912 5.000	4209 20.080
HSK-A 80	25	57.0	63.0	115.0	56.0	70.0	4937 25.100	4241 12.000	4912 6.000	4209 25.080
HSK-A 80	32	64.0	75.0	120.0	60.0	58.0	4937 32.100	4241 12.000	4912 6.000	4209 32.080
HSK-A 100	6	26.0	50.0	85.0	36.0	36.0	4937 6.100	4241 10.002	4912 5.000	4209 6.100
HSK-A 100	8	28.0	50.0	85.0	36.0	36.0	4937 8.100	4241 10.002	4912 5.000	4209 8.100
HSK-A 100	10	30.0	50.0	90.0	40.0	42.0	4937 10.100	4241 10.002	4912 5.000	4209 10.100
HSK-A 100	12	32.0	50.0	95.0	45.0	47.0	4937 12.100	4241 10.002	4912 5.000	4209 12.100
HSK-A 100	14	34.0	50.0	95.0	45.0	47.0	4937 14.100	4241 10.002	4912 5.000	4209 14.100
HSK-A 100	16	38.0	50.0	100.0	48.0	53.0	4937 16.100	4241 10.002	4912 5.000	4209 16.100
HSK-A 100	18	40.0	50.0	100.0	48.0	53.0	4937 18.100	4241 10.002	4912 5.000	4209 18.100
HSK-A 100	20	42.0	50.0	105.0	50.0	59.0	4937 20.100	4241 10.001	4912 5.000	4209 20.100
HSK-A 100	25	57.0	63.0	115.0	56.0	67.0	4937 25.100	4241 12.000	4912 6.000	4209 25.100
HSK-A 100	32	64.0	75.0	120.0	60.0	72.0	4937 32.100	4241 12.000	4912 6.000	4209 32.100



MQL 1-channel hydraulic chucks HSK-A (automatic tool change)

Article no. 4210



Product information:

- HSK-A according to ISO 12164-1 / DIN 69893-1
- for MQL 1-channel systems, Gühring MQL identifiable by green colour ring
- balancing quality: G 2.5 / 25,000 rpm or rev. < 1 gmm
- for tool shanks d1 h6
- axial length adjustment

Scope of delivery:

- MQL length adjusting screw with sealing lip (1), art. no. 4937

suitable accessories separately available:

- hexagonal key (2), art. no. 4912
- replacement clamping screw (2) art. no. 4241
- replacement MQL length adjusting screw with sealing lip (1), art. no. 4937
- MQL 1-channel transfer unit, art. no. 4939

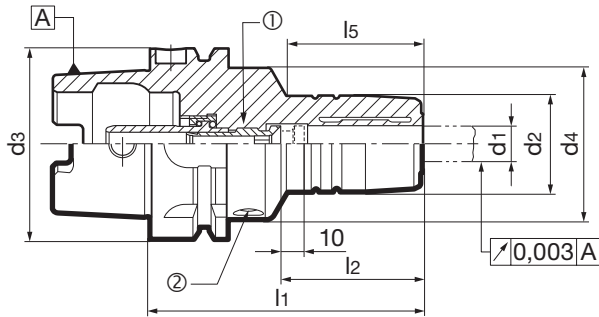

Article no.

4210

d3	d1 mm	d2 mm	d4 mm	l1 mm	l2 mm	l5 mm	①	②	②	Order no.
HSK-A 32	6	26.0	40.0	80.0	36.0	29.0	4937 6.032	4241 8.000	4912 4.000	4210 6.032
HSK-A 32	8	28.0	40.0	80.0	36.0	29.0	4937 8.032	4241 8.000	4912 4.000	4210 8.032
HSK-A 32	10	30.0	40.0	85.0	40.0	35.0	4937 10.032	4241 8.000	4912 4.000	4210 10.032
HSK-A 32	12	32.0	40.0	90.0	45.0	40.0	4937 12.032	4241 8.000	4912 4.000	4210 12.032
HSK-A 40	6	26.0	33.5	80.0	36.0	46.0	4937 6.040	4241 8.001	4912 4.000	4210 6.040
HSK-A 40	8	28.0	33.5	80.0	36.0	46.0	4937 8.040	4241 8.001	4912 4.000	4210 8.040
HSK-A 40	10	30.0	33.5	80.0	40.0	46.0	4937 10.040	4241 8.001	4912 4.000	4210 10.040
HSK-A 40	12	32.0	33.5	90.0	45.0	56.0	4937 12.040	4241 8.001	4912 4.000	4210 12.040
HSK-A 50	6	26.0	40.0	80.0	36.0	38.0	4937 6.050	4241 8.000	4912 4.000	4210 6.050
HSK-A 50	8	28.0	40.0	80.0	36.0	38.0	4937 8.050	4241 8.000	4912 4.000	4210 8.050
HSK-A 50	10	30.0	40.0	85.0	40.0	44.0	4937 10.050	4241 8.000	4912 4.000	4210 10.050
HSK-A 50	12	32.0	40.0	90.0	45.0	49.0	4937 12.050	4241 8.000	4912 4.000	4210 12.050
HSK-A 50	14	34.0	40.0	90.0	45.0	49.0	4937 14.050	4241 8.000	4912 4.000	4210 14.050
HSK-A 50	16	38.0	53.0	95.0	48.0	36.0	4937 16.050	4241 10.002	4912 5.000	4210 16.050
HSK-A 50	18	40.0	57.0	95.0	48.0	36.0	4937 18.050	4241 10.002	4912 5.000	4210 18.050
HSK-A 50	20	42.0	60.0	100.0	50.0	39.0	4937 20.050	4241 10.001	4912 5.000	4210 20.050
HSK-A 63	6	26.0	50.0	80.0	36.0	34.5	4937 6.100	4241 10.002	4912 5.000	4210 6.063
HSK-A 63	8	28.0	50.0	80.0	36.0	35.5	4937 8.100	4241 10.002	4912 5.000	4210 8.063
HSK-A 63	10	30.0	50.0	85.0	40.0	39.0	4937 10.100	4241 10.002	4912 5.000	4210 10.063
HSK-A 63	12	32.0	50.0	90.0	45.0	45.0	4937 12.100	4241 10.002	4912 5.000	4210 12.063
HSK-A 63	14	34.0	50.0	90.0	45.0	46.0	4937 14.100	4241 10.002	4912 5.000	4210 14.063
HSK-A 63	16	38.0	50.0	95.0	48.0	51.0	4937 16.100	4241 10.002	4912 5.000	4210 16.063
HSK-A 63	18	40.0	50.0	95.0	48.0	52.0	4937 18.100	4241 10.002	4912 5.000	4210 18.063
HSK-A 63	20	42.0	50.0	100.0	50.0	58.0	4937 20.100	4241 10.001	4912 5.000	4210 20.063
HSK-A 63	25	57.0	63.0	115.0	56.0	50.0	4937 25.100	4241 12.000	4912 6.000	4210 25.063
HSK-A 63	32	64.0	75.0	120.0	60.0	58.0	4937 32.100	4241 12.000	4912 6.000	4210 32.063
HSK-A 80	6	26.0	50.0	85.0	36.0	39.0	4937 6.100	4241 10.002	4912 5.000	4210 6.080
HSK-A 80	8	28.0	50.0	85.0	36.0	39.0	4937 8.100	4241 10.002	4912 5.000	4210 8.080
HSK-A 80	10	30.0	50.0	90.0	40.0	45.0	4937 10.100	4241 10.002	4912 5.000	4210 10.080
HSK-A 80	12	32.0	50.0	95.0	45.0	50.0	4937 12.100	4241 10.002	4912 5.000	4210 12.080
HSK-A 80	14	34.0	50.0	95.0	45.0	50.0	4937 14.100	4241 10.002	4912 5.000	4210 14.080
HSK-A 80	16	38.0	50.0	100.0	48.0	56.0	4937 16.100	4241 10.002	4912 5.000	4210 16.080
HSK-A 80	18	40.0	50.0	100.0	48.0	56.0	4937 18.100	4241 10.002	4912 5.000	4210 18.080
HSK-A 80	20	42.0	50.0	105.0	50.0	62.0	4937 20.100	4241 10.001	4912 5.000	4210 20.080
HSK-A 80	25	57.0	63.0	115.0	56.0	70.0	4937 25.100	4241 12.000	4912 6.000	4210 25.080
HSK-A 80	32	64.0	75.0	120.0	60.0	58.0	4937 32.100	4241 12.000	4912 6.000	4210 32.080
HSK-A 100	6	26.0	50.0	85.0	36.0	36.0	4937 6.100	4241 10.002	4912 5.000	4210 6.100
HSK-A 100	8	28.0	50.0	85.0	36.0	36.0	4937 8.100	4241 10.002	4912 5.000	4210 8.100
HSK-A 100	10	30.0	50.0	90.0	40.0	42.0	4937 10.100	4241 10.002	4912 5.000	4210 10.100
HSK-A 100	12	32.0	50.0	95.0	45.0	47.0	4937 12.100	4241 10.002	4912 5.000	4210 12.100
HSK-A 100	14	34.0	50.0	95.0	45.0	47.0	4937 14.100	4241 10.002	4912 5.000	4210 14.100
HSK-A 100	16	38.0	50.0	100.0	48.0	53.0	4937 16.100	4241 10.002	4912 5.000	4210 16.100
HSK-A 100	18	40.0	50.0	100.0	48.0	53.0	4937 18.100	4241 10.002	4912 5.000	4210 18.100
HSK-A 100	20	42.0	50.0	105.0	50.0	59.0	4937 20.100	4241 10.001	4912 5.000	4210 20.100
HSK-A 100	25	57.0	63.0	115.0	56.0	67.0	4937 25.100	4241 12.000	4912 6.000	4210 25.100
HSK-A 100	32	64.0	75.0	120.0	60.0	72.0	4937 32.100	4241 12.000	4912 6.000	4210 32.100

MQL technology



Product information:

- HSK-A according to ISO 12164-1 / DIN 69893-1
- balancing quality: G 2.5 / 25,000 rpm or rev. < 1 gmm
- for tool shanks d1 h6
- for MQL 1-channel systems, Gühring MQL identifiable by green colour ring
- incl. balancing thread 4xM6/6xM6
- even in excess lengths l1 = 120 mm (concentricity 4 µm) and 160 mm (concentricity 5 µm)

Scope of delivery:

- MQL length adjusting screw with sealing lip (1), art. no. 4937
- MQL 1-channel filler element, art. no. 4940

suitable accessories separately available:

- MQL length adjusting screw with sealing lip, art. no. 4937

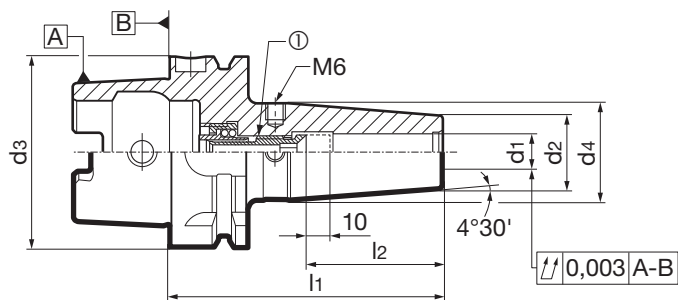

Article no.

4735

d3	d1 mm	d2 mm	d4 mm	l1 mm	l2 mm	①	Order no.
HSK-A 32	6	21	25.5	80	36	4937 6.032	4735 6.032
HSK-A 32	8	21	25.5	80	36	4937 8.032	4735 8.032
HSK-A 32	10	24	31.7	85	40	4937 10.032	4735 10.032
HSK-A 32	12	24	32.3	90	45	4937 12.032	4735 12.032
HSK-A 40	6	21	27.0	80	36	4937 6.040	4735 6.040
HSK-A 40	8	21	27.0	80	36	4937 8.040	4735 8.040
HSK-A 40	10	24	32.0	80	40	4937 10.040	4735 10.040
HSK-A 40	12	24	32.0	90	45	4937 12.040	4735 12.040
HSK-A 40	14	27	34.0	90	45	4937 14.040	4735 14.040
HSK-A 40	16	27	34.0	90	48	4937 16.040	4735 16.040
HSK-A 50	6	21	27.0	80	36	4937 6.050	4735 6.050
HSK-A 50	8	21	27.0	80	36	4937 8.050	4735 8.050
HSK-A 50	10	24	32.0	85	40	4937 10.050	4735 10.050
HSK-A 50	12	24	32.0	90	45	4937 12.050	4735 12.050
HSK-A 50	14	27	34.0	90	45	4937 14.050	4735 14.050
HSK-A 50	16	27	34.0	95	48	4937 16.050	4735 16.050
HSK-A 50	18	33	42.0	95	48	4937 18.050	4735 18.050
HSK-A 50	20	33	42.0	100	50	4937 20.050	4735 20.050
HSK-A 63	6	21	27.0	80	36	4937 6.100	4735 6.063
HSK-A 63	8	21	27.0	80	36	4937 8.100	4735 8.063
HSK-A 63	10	24	32.0	85	40	4937 10.100	4735 10.063
HSK-A 63	12	24	32.0	90	45	4937 12.100	4735 12.063
HSK-A 63	14	27	34.0	90	45	4937 14.100	4735 14.063
HSK-A 63	16	27	34.0	95	48	4937 16.100	4735 16.063
HSK-A 63	18	33	42.0	95	48	4937 18.100	4735 18.063
HSK-A 63	20	33	42.0	100	50	4937 20.100	4735 20.063
HSK-A 63	25	44	53.0	115	56	4937 25.100	4735 25.063
HSK-A 63	32	44	53.0	120	60	4937 32.100	4735 32.063
HSK-A 63	12	24	32.0	160	45	4937 12.100	4735 112.063
HSK-A 63	14	27	34.0	160	45	4937 14.100	4735 114.063
HSK-A 63	16	27	34.0	160	48	4937 16.100	4735 116.063
HSK-A 63	18	33	42.0	160	48	4937 18.100	4735 118.063
HSK-A 63	20	33	42.0	160	50	4937 20.100	4735 120.063
HSK-A 63	25	44	53.0	160	56	4937 25.100	4735 125.063
HSK-A 63	32	44	53.0	160	60	4937 32.100	4735 132.063
HSK-A 63	12	24	32.0	120	45	4937 12.100	4735 212.063
HSK-A 63	14	27	34.0	120	45	4937 14.100	4735 214.063
HSK-A 63	16	27	34.0	120	48	4937 16.100	4735 216.063
HSK-A 63	18	33	42.0	120	48	4937 18.100	4735 218.063
HSK-A 63	20	33	42.0	120	50	4937 20.100	4735 220.063
HSK-A 63	6	21	27.0	120	36	4937 6.032	4735 806.063
HSK-A 63	8	21	27.0	120	36	4937 8.040	4735 808.063
HSK-A 63	10	24	32.0	120	40	4937 10.050	4735 810.063
HSK-A 63	6	21	27.0	160	36	4937 6.032	4735 906.063
HSK-A 63	8	21	27.0	160	36	4937 8.040	4735 908.063
HSK-A 63	10	24	32.0	160	40	4937 10.050	4735 910.063
HSK-A 80	6	21	27.0	85	36	4937 6.100	4735 6.080
HSK-A 80	8	21	27.0	85	36	4937 8.100	4735 8.080



Article no.

4735

d3	d1 mm	d2 mm	d4 mm	l1 mm	l2 mm	①	Order no.
HSK-A 80	10	24	32.0	90	40	4937 10.100	4735 10.080
HSK-A 80	12	24	32.0	95	45	4937 12.100	4735 12.080
HSK-A 80	14	27	34.0	95	45	4937 14.100	4735 14.080
HSK-A 80	16	27	34.0	100	48	4937 16.100	4735 16.080
HSK-A 80	18	33	42.0	100	48	4937 18.100	4735 18.080
HSK-A 80	20	33	42.0	105	50	4937 20.100	4735 20.080
HSK-A 80	25	44	53.0	115	56	4937 25.100	4735 25.080
HSK-A 80	32	44	53.0	120	60	4937 32.100	4735 32.080
HSK-A 100	6	21	27.0	85	36	4937 6.100	4735 6.100
HSK-A 100	8	21	27.0	85	36	4937 8.100	4735 8.100
HSK-A 100	10	24	32.0	90	40	4937 10.100	4735 10.100
HSK-A 100	12	24	32.0	95	45	4937 12.100	4735 12.100
HSK-A 100	14	27	34.0	95	45	4937 14.100	4735 14.100
HSK-A 100	16	27	34.0	100	48	4937 16.100	4735 16.100
HSK-A 100	18	33	42.0	100	48	4937 18.100	4735 18.100
HSK-A 100	20	33	42.0	105	50	4937 20.100	4735 20.100
HSK-A 100	25	44	53.0	115	56	4937 25.100	4735 25.100
HSK-A 100	32	44	53.0	120	60	4937 32.100	4735 32.100
HSK-A 100	6	21	27.0	160	36	4937 6.032	4735 106.100
HSK-A 100	8	21	27.0	160	36	4937 8.040	4735 108.100
HSK-A 100	10	24	32.0	160	40	4937 10.050	4735 110.100
HSK-A 100	12	24	32.0	160	45	4937 12.100	4735 112.100
HSK-A 100	14	27	34.0	160	45	4937 14.100	4735 114.100
HSK-A 100	16	27	34.0	160	48	4937 16.100	4735 116.100
HSK-A 100	18	33	42.0	160	48	4937 18.100	4735 118.100
HSK-A 100	20	33	42.0	160	50	4937 20.100	4735 120.100
HSK-A 100	25	44	53.0	160	56	4937 25.100	4735 125.100
HSK-A 100	32	44	53.0	160	60	4937 32.100	4735 132.100



Product information:

- HSK-A according to ISO 12164-1 / DIN 69893-1
- balancing quality: G 2.5 / 25,000 rpm or rev. < 1 gmm
- for MQL 1-channel systems, Gühring MQL identifiable by green colour ring
- for tool shanks d1 h6
- axial length adjustment
- concentricity < 3 µm
- incl. balancing thread 4xM6/6xM6
- even in excess lengths l1 = 120 mm (concentricity 4 µm) and 160 mm (concentricity 5 µm)

Scope of delivery:

- MQL length adjusting screw with sealing lip (1), art. no. 4937
- MQL 1-channel transfer unit, art. no. 4939

suitable accessories separately available:

- MQL length adjusting screw with sealing lip, art. no. 4937
- sealing lip art. no. 4617
- MQL 1-channel transfer unit, art. no. 4939

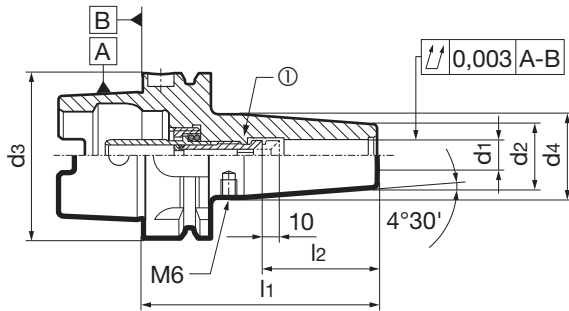

Article no.

4741

d3	d1 mm	d2 mm	d4 mm	l1 mm	l2 mm	①	Order no.
HSK-A 32	6	21	25.5	80	36	4937 6.032	4741 6.032
HSK-A 32	8	21	25.5	80	36	4937 8.032	4741 8.032
HSK-A 32	10	24	31.7	85	40	4937 10.032	4741 10.032
HSK-A 32	12	24	32.3	90	45	4937 12.032	4741 12.032
HSK-A 40	6	21	27.0	80	36	4937 6.040	4741 6.040
HSK-A 40	8	21	27.0	80	36	4937 8.040	4741 8.040
HSK-A 40	10	24	32.0	80	40	4937 10.040	4741 10.040
HSK-A 40	12	24	32.0	90	45	4937 12.040	4741 12.040
HSK-A 40	14	27	34.0	90	45	4937 14.040	4741 14.040
HSK-A 40	16	27	34.0	90	48	4937 16.040	4741 16.040
HSK-A 50	6	21	27.0	80	36	4937 6.050	4741 6.050
HSK-A 50	8	21	27.0	80	36	4937 8.050	4741 8.050
HSK-A 50	10	24	32.0	85	40	4937 10.050	4741 10.050
HSK-A 50	12	24	32.0	90	45	4937 12.050	4741 12.050
HSK-A 50	14	27	34.0	90	45	4937 14.050	4741 14.050
HSK-A 50	16	27	34.0	95	48	4937 16.050	4741 16.050
HSK-A 50	18	33	42.0	95	48	4937 18.050	4741 18.050
HSK-A 50	20	33	42.0	100	50	4937 20.050	4741 20.050
HSK-A 63	6	21	27.0	80	36	4937 6.100	4741 6.063
HSK-A 63	8	21	27.0	80	36	4937 8.100	4741 8.063
HSK-A 63	10	24	32.0	85	40	4937 10.100	4741 10.063
HSK-A 63	12	24	32.0	90	45	4937 12.100	4741 12.063
HSK-A 63	14	27	34.0	90	45	4937 14.100	4741 14.063
HSK-A 63	16	27	34.0	95	48	4937 16.100	4741 16.063
HSK-A 63	18	33	42.0	95	48	4937 18.100	4741 18.063
HSK-A 63	20	33	42.0	100	50	4937 20.100	4741 20.063
HSK-A 63	25	44	53.0	115	56	4937 25.100	4741 25.063
HSK-A 63	32	44	53.0	120	60	4937 32.100	4741 32.063
HSK-A 63	12	24	32.0	160	45	4937 12.100	4741 112.063
HSK-A 63	14	27	34.0	160	45	4937 14.100	4741 114.063
HSK-A 63	16	27	34.0	160	48	4937 16.100	4741 116.063
HSK-A 63	18	33	42.0	160	48	4937 18.100	4741 118.063
HSK-A 63	20	33	42.0	160	50	4937 20.100	4741 120.063
HSK-A 63	25	44	53.0	160	56	4937 25.100	4741 125.063
HSK-A 63	32	44	53.0	160	60	4937 32.100	4741 132.063
HSK-A 63	12	24	32.0	120	45	4937 12.100	4741 212.063
HSK-A 63	14	27	34.0	120	45	4937 14.100	4741 214.063
HSK-A 63	16	27	34.0	120	48	4937 16.100	4741 216.063
HSK-A 63	18	33	42.0	120	48	4937 18.100	4741 218.063
HSK-A 63	20	33	42.0	120	50	4937 20.100	4741 220.063
HSK-A 63	6	21	27.0	120	36	4937 6.032	4741 806.063
HSK-A 63	8	21	27.0	120	36	4937 8.040	4741 808.063
HSK-A 63	10	24	32.0	120	40	4937 10.050	4741 810.063
HSK-A 63	6	21	27.0	160	36	4937 6.032	4741 906.063
HSK-A 63	8	21	27.0	160	36	4937 8.040	4741 908.063
HSK-A 63	10	24	32.0	160	40	4937 10.050	4741 910.063
HSK-A 80	6	21	27.0	85	36	4937 6.100	4741 6.080
HSK-A 80	8	21	27.0	85	36	4937 8.100	4741 8.080



Article no.

4741

d3	d1 mm	d2 mm	d4 mm	l1 mm	l2 mm	①	Order no.
HSK-A 80	10	24	32.0	90	40	4937 10.100	4741 10.080
HSK-A 80	12	24	32.0	95	45	4937 12.100	4741 12.080
HSK-A 80	14	27	34.0	95	45	4937 14.100	4741 14.080
HSK-A 80	16	27	34.0	100	48	4937 16.100	4741 16.080
HSK-A 80	18	33	42.0	100	48	4937 18.100	4741 18.080
HSK-A 80	20	33	42.0	105	50	4937 20.100	4741 20.080
HSK-A 80	25	44	53.0	115	56	4937 25.100	4741 25.080
HSK-A 80	32	44	53.0	120	60	4937 32.100	4741 32.080
HSK-A 100	6	21	27.0	85	36	4937 6.100	4741 6.100
HSK-A 100	8	21	27.0	85	36	4937 8.100	4741 8.100
HSK-A 100	10	24	32.0	90	40	4937 10.100	4741 10.100
HSK-A 100	12	24	32.0	95	45	4937 12.100	4741 12.100
HSK-A 100	14	27	34.0	95	45	4937 14.100	4741 14.100
HSK-A 100	16	27	34.0	100	48	4937 16.100	4741 16.100
HSK-A 100	18	33	42.0	100	48	4937 18.100	4741 18.100
HSK-A 100	20	33	42.0	105	50	4937 20.100	4741 20.100
HSK-A 100	25	44	53.0	115	56	4937 25.100	4741 25.100
HSK-A 100	32	44	53.0	120	60	4937 32.100	4741 32.100
HSK-A 100	6	21	27.0	160	36	4937 6.032	4741 106.100
HSK-A 100	8	21	27.0	160	36	4937 8.040	4741 108.100
HSK-A 100	10	24	32.0	160	40	4937 10.050	4741 110.100
HSK-A 100	12	24	32.0	160	45	4937 12.100	4741 112.100
HSK-A 100	14	27	34.0	160	45	4937 14.100	4741 114.100
HSK-A 100	16	27	34.0	160	48	4937 16.100	4741 116.100
HSK-A 100	18	33	42.0	160	48	4937 18.100	4741 118.100
HSK-A 100	20	33	42.0	160	50	4937 20.100	4741 120.100
HSK-A 100	25	44	53.0	160	56	4937 25.100	4741 125.100
HSK-A 100	32	44	53.0	160	60	4937 32.100	4741 132.100



Product information:

- for MQL 1-channel systems, Gühring MQL identifiable by green colour ring
- for the use of tool shanks according to MQL company standard
- gold-coloured, anti-corrosion coating for visual identification of the 1-channel system
- with patented axial force damping from Ø 14 to 32, temperature-related warping and thus concentricity errors are avoided thanks to the o-ring on the face
- for axial length adjustment

Scope of delivery:

- incl. sealing lip

suitable accessories separately available:

- replacement sealing lip, art. no. 4617

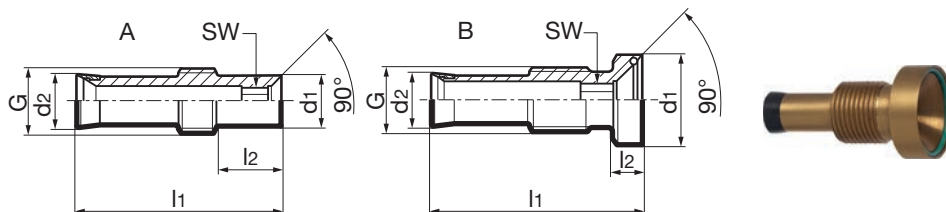

Article no.

4937

HSK-A	d1 mm	d2 mm	l1 mm	l2 mm	G	SW mm	Type	Order no.
32	6	4.0	34.5	2.5	M 5 X0.8	2	B	4937 6.032
32	8	4.0	34.5	3.0	M7 x 1	2	B	4937 8.032
32	10	4.0	35.5	3.5	M8 x 1	2	B	4937 10.032
32	12	4.0	35.5	3.5	M10 X1	2	B	4937 12.032
40	6	5.4	34.1	11.0	M7 x 1	3	A	4937 6.040
40	8	5.4	34.1	3.0	M7 x 1	3	B	4937 8.040
40	10	5.4	30.1	3.5	M8 x 1	3	B	4937 10.040
40	12	5.4	35.1	3.5	M10 X1	3	B	4937 12.040
40	14	5.4	35.1	4.5	M10 X1	3	B	4937 14.040
40	16	5.4	32.1	5.5	M12 X1	3	B	4937 16.040
50	6	6.5	31.8	10.0	M8 x 1	4	A	4937 6.050
50	8	6.5	31.8	3.0	M8 x 1	4	B	4937 8.050
50	10	6.5	32.8	3.5	M8 x 1	4	B	4937 10.050
50	12	6.5	32.8	3.5	M10 X1	4	B	4937 12.050
50	14	6.5	32.8	4.5	M10 X1	4	B	4937 14.050
50	16	6.5	34.8	5.5	M12 X1	4	B	4937 16.050
50	18	6.5	34.8	6.5	M12 X1	4	B	4937 18.050
50	20	6.5	37.8	6.5	M16 x 1	4	B	4937 20.050
63/80/100	6	8.0	31.0	10.0	M10 X1	4	A	4937 6.100
63/80/100	8	8.0	31.8	10.0	M10 X1	4	A	4937 8.100
63/80/100	10	8.0	32.8	3.5	M10 X1	4	B	4937 10.100
63/80/100	12	8.0	32.8	3.5	M10 X1	5	B	4937 12.100
63/80/100	14	8.0	32.8	4.5	M10 X1	5	B	4937 14.100
63/80/100	16	8.0	34.8	5.5	M12 X1	5	B	4937 16.100
63/80/100	18	8.0	34.8	6.5	M12 X1	5	B	4937 18.100
63/80/100	20	8.0	37.8	6.5	M16 x 1	5	B	4937 20.100
63/80/100	25	8.0	43.8	10.0	M16 x 1	5	B	4937 25.100
63/80/100	32	8.0	44.8	14.0	M16 x 1	5	B	4937 32.100

MQL technology



Sealing lips for MQL 1-channel length adjusting screws

Article no. 4617



Product information:

- for MQL 1-channel axially adjustable adjusting screw, art. no. 4937
- for adaptor sleeve, art. no. 4716

Scope of delivery:

- packing unit 5 pieces

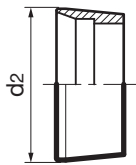

Article no.		4617
		Order no.
		4617 1.032
		4617 1.040
		4617 1.050
		4617 1.100
		4617 1.140

HSK-A	d2 mm
32	4.0
40	5.6
50	6.7
63/80/100	8.2
63/80/100	10.2

MQL 1-channel coolant supply set HSK-A (filler)

Article no. 4940



Product information:

- for MQL 1-channel tool holders (hydraulic chucks and shrink fit chucks) to company standard
- for tool holders with manual tool change
- radially alignable

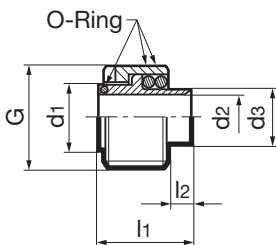

Article no.						4940
						Order no.
						4940 10.032
						4940 12.040
						4940 16.050
						4940 18.063
						4940 20.080
						4940 24.100

for	d1 mm	d2 mm	d3 mm	l1 mm	l2 mm	G
HSK32 A	4.8	4.0	4.8	18.7	12.5	M10X1
HSK40 A	6.8	5.4	6.8	13.8	5.5	M12X1
HSK50 A	7.8	6.5	7.8	15.8	5.5	M16X1
HSK63 A	9.7	8.0	9.7	16.3	4.0	M18X1
HSK80 A	9.7	8.0	9.7	18.4	4.0	M20X1.5
HSK100A	14.5	8.0	11.7	18.4	2.0	M24X1.5



MQL 1-channel coolant supply set HSK-A

Article no. **4939**

Product information:

- for MQL 1-channel tool holders (hydraulic chucks and shrink fit chucks)
- for tool holders with automatic tool change

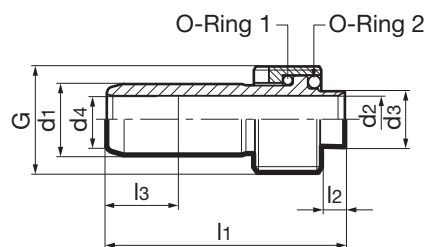

Article no. **4939**

for	d1 mm	d2 mm	d3 mm	d4 mm	l1 mm	l2 mm	l3 mm	G	Order no.
HSK32 A	6.0	4.0	4.8		38.5	12.5		M10X1	4939 10.032
HSK40 A	8.0	5.4	6.5		35.0	5.5		M12X1	4939 12.040
HSK50 A	10.0	6.5	7.5		38.5	5.5		M16X1	4939 16.050
HSK63 A	12.0	8.0	9.5		40.5	4.0		M18X1	4939 18.063
HSK80 A	14.0	8.0	9.7	10	44.0	4.0	15	M20X1.5	4939 20.080
HSK100A	16.0	8.0	11.5	12	46.0	2.0	15	M24X1.5	4939 24.100

MQL 1-channel length adjusting screws with sealing lip

Article no. **4948**



Product information:

- adaptor suitable for Gühring socket wrench (3), art. no. 4911
- for assembly of MQL 1-channel filler (2), art. no. 4940 HSK-A for manual tool change
- for assembly of MQL 1 & 2-channel filler (2), art. no. 4513 HSK-A for manual tool change
- for assembly of MQL 2-channel filler with tube (2), art. no. 4622 HSK-A for manual tool change

Scope of delivery:

- incl. Instruction manual

suitable accessories separately available:

- MQL length pre-adjusting screw with sealing lip (1) art. no. 4937
- socket wrench (3) art. no. 4911

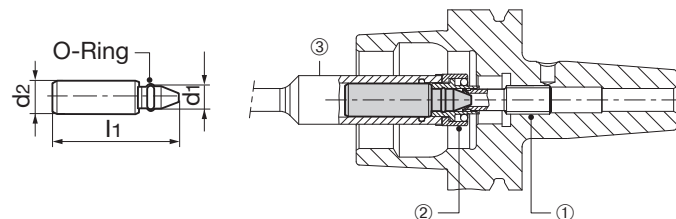

Article no. **4948**

Size	d1 mm	d2 mm	l1 mm	Order no.
HSK-A 32	4.0	5.9	30.0	4948 6.032
HSK-A 40	5.4	8.0	36.6	4948 8.040
HSK-A 50	6.5	10.0	40.1	4948 10.050
HSK-A 63	8.0	12.0	43.6	4948 12.063
HSK-A 80	8.0	14.0	46.1	4948 14.080
HSK-A 100	8.0	16.0	48.6	4948 16.100



Length adjusting screw for conventional cooling

Article no. 4941



Product information:

- to adapt MQL tool holders to meet the requirements of conventional wet machining. For plain end shanks. The height of screw head compensates the height of MQL taper.
- for use with shank according to DIN 6535 with plain shank end for conventional cooling
- with patented axial force damping; the o-ring on the face prevents temperature-related warping and concentricity errors
- for MQL HSK-A shrink fit and hydraulic chucks

suitable accessories separately available:

- hexagonal key art. no. 4912

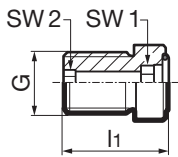

Article no.

4941

for HSK-A	for clamping Ø mm	l1 mm	G	SW2 mm	SW1 mm	Order no.
40	6	15.0	M7	2.5	2.5	4941 6.040
40	6	14.9	M 5	2.5	2.5	4941 6.041
50	6	14.0	M 8X1	2.5	2.5	4941 6.050
63-100	6	17.0	M10X1	2.5	2.5	4941 6.100
40	8	16.2	M7	3.0	3.0	4941 8.040
50	8	18.0	M 8X1	3.0	3.0	4941 8.050
63-100	8	17.0	M10X1	3.0	3.0	4941 8.100
40-50	10	16.2	M 8X1	4.0	4.0	4941 10.050
63-100	10	16.2	M10X1	4.0	4.0	4941 10.100
40-100	12	16.0	M10X1	5.0	5.0	4941 12.100
40-100	14	17.2	M10X1	5.0	5.0	4941 14.100
50-100	16	18.2	M12X1	6.0	6.0	4941 16.100
50-100	18	19.2	M12X1	6.0	6.0	4941 18.100
50-100	20	19.2	M16X1	6.0	8.0	4941 20.100
63-100	25	22.7	M16X1	6.0	8.0	4941 25.100
63-100	32	26.7	M16X1	6.0	8.0	4941 32.100



MQL hydraulic synchro tapping chucks HSK-A (manual tool change)

Article no. **4604**



Product information:

- HSK-A according to ISO 12164-1 / DIN 69893-1
- balancing quality: G 6.3 / 15,000 rpm
- convenient hydraulic clamping using reduction bushes with active drive
- for MQL 1 & 2-channel systems, Gühring MQL identifiable by green colour ring
- MQL pressure max. 16 bar
- compensates synchronisation errors
- minimum length compensation ± 0.3 mm in pushing and pulling direction
- adjusting screw enables 3 mm axial length readjustment
- guarantees the best thread quality with optimum tool life

Scope of delivery:

- MQL filler art. no. 4513
- adjustment wrench for adjusting screw

suitable accessories separately available:

- MQL axial adjusting screw, art. no. 4305
- reduction bushes art. no. 4605 or 4606
- hexagonal key (2), art. no. 4912
- replacement clamping screw (2) art. no. 4241
- adjustment key, art. no. 4912, type B for adjusting screws

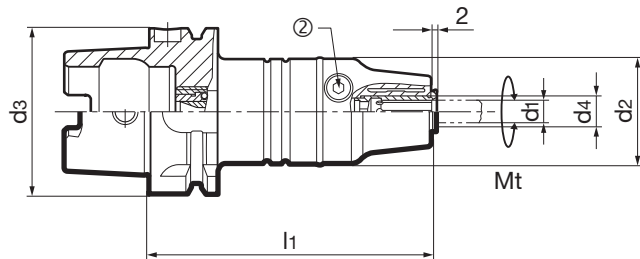

Article no.

4604

d3	d2 mm	d1	for threads	d4 mm	l1 mm	Mt max. Nm	②	②
HSK-A 63	40	2.8-10.0	M2-M12	12	106.5	26	4912 4.600	4241 8.000
HSK-A 63	40	6.0-16.0	M4,5-M20	20	120.5	90	4912 5.000	4241 10.003
HSK-A 100	40	2.8-10.0	M2-M12	12	113.0	26	4912 4.600	4241 8.000
HSK-A 100	40	6.0-16.0	M4,5-M20	20	127.0	90	4912 5.000	4241 10.003

Order no.
4604 12.063
4604 20.063
4604 12.100
4604 20.100

MQL 1-channel hydraulic synchro tapping chucks HSK-A (automatic tool change)

Article no. **4602**



Product information:

- HSK-A according to ISO 12164-1 / DIN 69893-1
- balancing quality: G 6.3 / 15,000 rpm
- for MQL 1-channel systems, Gühring MQL identifiable by green colour ring
- MQL pressure max. 16 bar
- compensates synchronisation errors
- minimum length compensation ± 0.3 mm in pushing and pulling direction
- convenient hydraulic clamping using reduction bushes with active drive
- adjusting screw enables 3 mm axial length readjustment
- guarantees the best thread quality with optimum tool life

Scope of delivery:

- MQL 1-channel transfer unit, art. no. 4508
- adjustment wrench for MQL axial adjusting screw

suitable accessories separately available:

- MQL axial adjusting screw, art. no. 4305
- reduction bushes art. no. 4605 or 4606
- hexagonal key (2), art. no. 4912
- replacement clamping screw (2) art. no. 4241

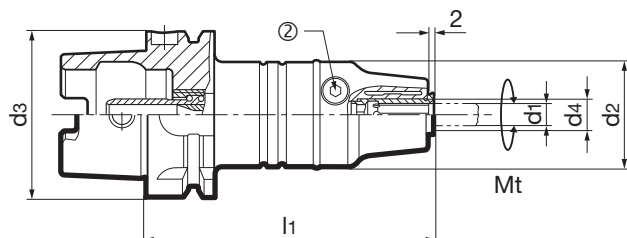

Article no.

4602

d3	d2 mm	d1	for threads	d4 mm	l1 mm	Mt max. Nm	②	②
HSK-A 63	40	2.8-10.0	M2-M12	12	106.5	26	4912 4.600	4241 8.000
HSK-A 63	40	6.0-16.0	M4,5-M20	20	120.5	90	4912 5.000	4241 10.003
HSK-A 100	40	2.8-10.0	M2-M12	12	113.0	26	4912 4.600	4241 8.000
HSK-A 100	40	6.0-16.0	M4,5-M20	20	127.0	90	4912 5.000	4241 10.003

Order no.
4602 12.063
4602 20.063
4602 12.100
4602 20.100



MQL hydraulic synchro tapping chucks with straight shank

Article no. **4524**



Product information:

- mounting shank according to DIN 1835-A for mounting in precision chucks (hydraulic expansion or power chucks, shrink fit chucks for one-time use)
- für MQL 1 & 2-channel systems, according to company standard
- MQL pressure max. 16 bar
- guarantees the best thread quality with optimum tool life
- minimum length compensation ± 0.3 mm in pushing and pulling direction
- convenient hydraulic clamping using reduction bushes with active drive
- adjusting screw enables 3 mm axial length readjustment

Scope of delivery:

- incl. adjustment key for adjusting screws

suitable accessories separately available:

- MQL axial adjusting screw, art. no. 4305
- reduction bushes art. no. 4605 or 4606
- replacement clamping screw (2) art. no. 4241

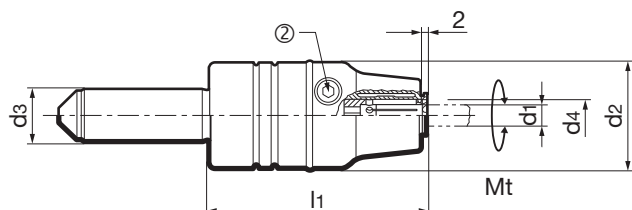

Article no. **4524**

d3 mm	d4 mm	d1	for	d2 mm	l1 mm	Mt max. Nm	SW mm	②	②
20	12.0	2.8-10.0	M2-M12	40	80.0	26	4.0	4912 4.600	4241 8.000
20	20.0	6.0-16.0	M4,5-M20	40	94.0	90	5.0	4912 5.000	4241 10.003

Order no.

4524 12.020
4524 20.020

MQL synchro tapping chucks HSK-A (manual tool change)

Article no. **4298**



Product information:

- HSK-A according to ISO 12164-1 / DIN 69893-1
- for MQL 1 & 2-channel systems
- compensates synchronisation errors
- minimum length compensation ± 0.5 mm in pushing and pulling direction
- reduces high thread flank friction forces and increases thread quality and tool life
- adjusting screw enables 2-3 mm readjustment
- MQL pressure max. 16 bar

Scope of delivery:

- MQL coolant supply set
- incl. adjusting screw
- IC/ER clamping nut with sealing washer, art. no. 4306 (*see tightening torque)
- adjustment wrench for MQL axial adjusting screw

suitable accessories separately available:

- MQL axial adjusting screw, art. no. 4305
- sealing plug art. no. 4335
- thread tap collet chuck, art. no. 4308
- clamping key art. no. 4913 for clamping nut ER
- MQL filler art. no. 4513

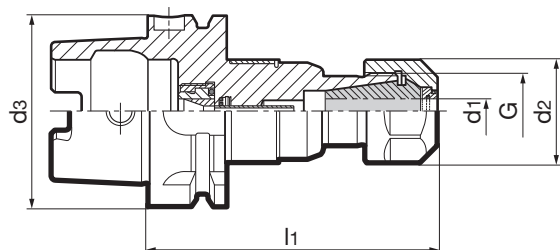

Article no. **4298**

d3	Size	G	d1 mm	d2 mm	l1 mm	Mt max. Nm
HSK-A 63	ER20	M25 X1.5	4.5-11.0	34.0	95.5	35
HSK-A 63	ER32	M40 X1.5	4.5-20.0	50.0	109.0	136

Order no.

4298 20.063
4298 32.063



Product information:

- HSK-A according to ISO 12164-1 / DIN 69893-1
- for MQL 1-channel systems
- compensates synchronisation errors
- minimum length compensation ± 0.5 mm in pushing and pulling direction
- adjusting screw enables 2-3 mm readjustment
- MQL pressure max. 16 bar
- mounted MQL coolant transfer set

Scope of delivery:

- MQL 1-channel transfer unit, art. no. 4508
- IC/ER clamping nut with sealing washer, art. no. 4306
- adjustment wrench for MQL axial adjusting screw

suitable accessories separately available:

- MQL axial adjusting screw, art. no. 4305
- sealing plug art. no. 4335
- thread tap collet chuck, art. no. 4308
- clamping key art. no. 4913

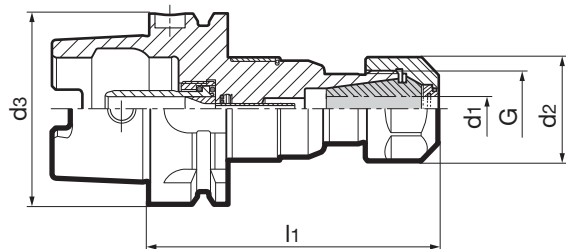

Article no.

4330

d3	Size	G	d1 mm	d2 mm	l1 mm	Mt max. Nm	Order no.
HSK-A 63	ER20	M25 X1.5	4.5-11.0	34.0	95.5	35	4330 20.063
HSK-A 63	ER32	M40 X1.5	4.5-20.0	50.0	109.0	136	4330 32.063
HSK-A 100	ER20	M25 X1.5	4.5-11.0	34.0	102.0	35	4330 20.100
HSK-A 100	ER32	M40 X1.5	4.5-20.0	50.0	115.5	136	4330 32.100



MLQ 1-channel coolant supply set HSK-A

Article no. **4508**



Product information:

- design similar to DIN 69895
- for MLQ 1-channel systems, to company standard
- for MLQ tapping chucks and monolithic holders
- for tool holders with automatic tool change
- dimensions d2 and l1 in installed condition

suitable accessories separately available:

- socket wrenches art. no. 4910
- socket wrenches for coolant supply sets art. no. 4911

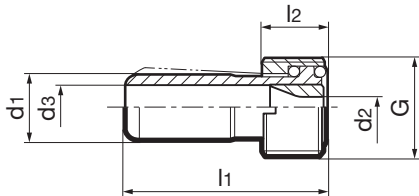

Article no. **4508**

for	d1 mm	d2 mm	d3 mm	l1 mm	l2 mm	G	Order no.
HSK-A 32	6.0	3.0	4.0	26.0	5.5	M10X1	4508 10.032
HSK-A 40	8.0	3.8	5.4	29.5	7.5	M12X1	4508 12.040
HSK-A 50	10.0	3.8	6.4	33.0	9.5	M16X1	4508 16.050
HSK-A 63	12.0	3.8	8.0	36.5	11.5	M18X1	4508 18.063
HSK-A 80	14.0	3.8	10.0	40.0	13.5	M20X1.5	4508 20.080
HSK-A 100	16.0	3.8	12.0	44.0	15.5	M24X1.5	4508 24.100

MLQ coolant supply set HSK-A (filler)

Article no. **4513**



Product information:

- for IC, for MLQ 1 & 2-channel system, according to company standard
- for MLQ tapping chucks and monolithic holders
- for tool holders with manual tool change
- radially alignable
- dimensions d2 and l1 in installed condition
- optimum seal for MLQ clamping set

suitable accessories separately available:

- socket wrenches art. no. 4910
- socket wrenches for coolant supply sets art. no. 4911

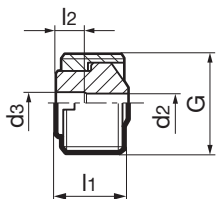

Article no. **4513**

for	d2 mm	d3 mm	l1 mm	l2 mm	G	Order no.
HSK-A 32	3.0	3.0	6.3		M10X1	4513 10.032
HSK-A 40	3.6	4.0	8.3	5.0	M12X1	4513 12.040
HSK-A 50	3.6	4.0	10.3	5.0	M16X1	4513 16.050
HSK-A 50	5.0	5.0	10.3		M16X1	4513 16.150
HSK-A 63	3.6	4.0	12.3	5.0	M18X1	4513 18.063
HSK-A 63	6.0	6.0	12.3		M18X1	4513 18.163
HSK-A 80	3.6	4.0	14.4	5.0	M20X1.5	4513 20.080
HSK-A 80	8.0	8.0	14.4		M20X1.5	4513 20.180
HSK-A 100	3.6	4.0	16.4	5.0	M24X1.5	4513 24.100
HSK-A 100	8.0	8.0	16.4		M24X1.5	4513 24.101



Product information:

- HSK-A according to ISO 12164-1 / DIN 69893-1
- balancing quality: G 2.5 / 25,000 rpm or rev. < 1 gmm
- for tool shanks d1 h6
- axial length adjustment
- for MQL 2-channel systems, to company standard
- cross-section A (mm²) ratio 4:1, see info page

Scope of delivery:

- MQL 2-channel axial adjusting screw (1) art. no. 4621
- MQL 2-channel filler with tube art. no. 4622

suitable accessories separately available:

- replacement adjusting screw (1), art. no. 4621
- replacement clamping screw (2) art. no. 4241
- hexagonal key (2), art. no. 4912

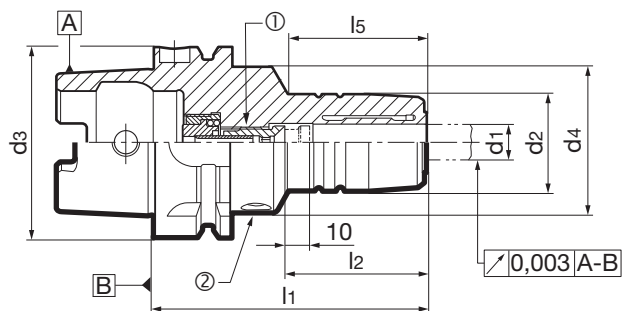

Article no.

4611

d3	d1 mm	A mm ²	d2 mm	d4 mm	l1 mm	l2 mm	l5 mm	①	②	②	Order no.
HSK-A 32	6	2.01	26.0	40.0	80.0	36.0	29.0	4621 6.032	4912 4.000	4241 8.000	4611 6.032
HSK-A 32	6	4.15	26.0	40.0	80.0	36.0	29.0	4621 6.132	4912 4.000	4241 8.000	4611 6.132
HSK-A 32	8	2.01	28.0	40.0	80.0	36.0	29.0	4621 8.032	4912 4.000	4241 8.000	4611 8.032
HSK-A 32	8	4.15	28.0	40.0	80.0	36.0	29.0	4621 8.132	4912 4.000	4241 8.000	4611 8.132
HSK-A 32	10	2.01	30.0	40.0	85.0	40.0	35.0	4621 10.032	4912 4.000	4241 8.000	4611 10.032
HSK-A 32	10	4.15	30.0	40.0	85.0	40.0	35.0	4621 10.132	4912 4.000	4241 8.000	4611 10.132
HSK-A 32	12	2.01	32.0	40.0	90.0	45.0	40.0	4621 12.032	4912 4.000	4241 8.000	4611 12.032
HSK-A 32	12	4.15	32.0	40.0	90.0	45.0	40.0	4621 12.132	4912 4.000	4241 8.000	4611 12.132
HSK-A 40	6	2.01	26.0	33.5	80.0	36.0	46.0	4621 6.040	4912 4.000	4241 8.001	4611 6.040
HSK-A 40	6	4.15	26.0	33.5	80.0	36.0	46.0	4621 6.140	4912 4.000	4241 8.001	4611 6.140
HSK-A 40	8	2.01	28.0	33.5	80.0	36.0	46.0	4621 8.040	4912 4.000	4241 8.001	4611 8.040
HSK-A 40	8	4.15	28.0	33.5	80.0	36.0	46.0	4621 8.140	4912 4.000	4241 8.001	4611 8.140
HSK-A 40	10	2.01	30.0	33.5	80.0	40.0	46.0	4621 10.040	4912 4.000	4241 8.001	4611 10.040
HSK-A 40	10	4.15	30.0	33.5	80.0	40.0	46.0	4621 10.140	4912 4.000	4241 8.001	4611 10.140
HSK-A 40	12	2.01	32.0	33.5	90.0	45.0	56.0	4621 12.040	4912 4.000	4241 8.001	4611 12.040
HSK-A 40	12	4.15	32.0	33.5	90.0	45.0	56.0	4621 12.140	4912 4.000	4241 8.001	4611 12.140
HSK-A 40	12	9.08	32.0	33.5	90.0	45.0	56.0	4621 12.240	4912 4.000	4241 8.001	4611 12.240
HSK-A 50	6	2.01	26.0	40.0	80.0	36.0	38.0	4621 6.050	4912 4.000	4241 8.000	4611 6.050
HSK-A 50	6	4.15	26.0	40.0	80.0	36.0	38.0	4621 6.150	4912 4.000	4241 8.000	4611 6.150
HSK-A 50	8	2.01	28.0	40.0	80.0	36.0	38.0	4621 8.050	4912 4.000	4241 8.000	4611 8.050
HSK-A 50	8	4.15	28.0	40.0	80.0	36.0	38.0	4621 8.150	4912 4.000	4241 8.000	4611 8.150
HSK-A 50	10	2.01	30.0	40.0	85.0	40.0	44.0	4621 10.050	4912 4.000	4241 8.000	4611 10.050
HSK-A 50	10	4.15	30.0	40.0	85.0	40.0	44.0	4621 10.150	4912 4.000	4241 8.000	4611 10.150
HSK-A 50	12	2.01	32.0	40.0	90.0	45.0	49.0	4621 12.050	4912 4.000	4241 8.000	4611 12.050
HSK-A 50	12	4.15	32.0	40.0	90.0	45.0	49.0	4621 12.150	4912 4.000	4241 8.000	4611 12.150
HSK-A 50	12	9.08	32.0	40.0	90.0	45.0	49.0	4621 12.250	4912 4.000	4241 8.000	4611 12.250
HSK-A 50	14	2.01	34.0	40.0	90.0	45.0	49.0	4621 14.050	4912 4.000	4241 8.000	4611 14.050
HSK-A 50	14	4.15	34.0	40.0	90.0	45.0	49.0	4621 14.150	4912 4.000	4241 8.000	4611 14.150
HSK-A 50	14	9.08	34.0	40.0	90.0	45.0	49.0	4621 14.250	4912 4.000	4241 8.000	4611 14.250
HSK-A 50	16	2.01	38.0	53.0	95.0	48.0	36.0	4621 16.050	4912 5.000	4241 10.002	4611 16.050
HSK-A 50	16	4.15	38.0	53.0	95.0	48.0	36.0	4621 16.150	4912 5.000	4241 10.002	4611 16.150
HSK-A 50	16	9.08	38.0	53.0	95.0	48.0	36.0	4621 16.250	4912 5.000	4241 10.002	4611 16.250
HSK-A 50	18	2.01	40.0	57.0	95.0	48.0	36.0	4621 18.050	4912 5.000	4241 10.002	4611 18.050
HSK-A 50	18	4.15	40.0	57.0	95.0	48.0	36.0	4621 18.150	4912 5.000	4241 10.002	4611 18.150
HSK-A 50	18	9.08	40.0	57.0	95.0	48.0	36.0	4621 18.250	4912 5.000	4241 10.002	4611 18.250
HSK-A 50	20	4.15	42.0	60.0	100.0	50.0	39.0	4621 20.050	4912 5.000	4241 10.001	4611 20.050
HSK-A 50	20	9.08	42.0	60.0	100.0	50.0	39.0	4621 20.150	4912 5.000	4241 10.001	4611 20.150
HSK-A 50	20	16.62	42.0	60.0	100.0	50.0	39.0	4621 20.250	4912 5.000	4241 10.001	4611 20.250
HSK-A 63	6	2.01	26.0	50.0	80.0	36.0	34.5	4621 6.100	4912 5.000	4241 10.002	4611 6.063
HSK-A 63	6	4.15	26.0	50.0	80.0	36.0	50.0	4621 6.101	4912 5.000	4241 10.002	4611 6.163
HSK-A 63	8	2.01	28.0	50.0	80.0	36.0	35.5	4621 8.100	4912 5.000	4241 10.002	4611 8.063
HSK-A 63	8	4.15	28.0	50.0	80.0	36.0	35.5	4621 8.101	4912 5.000	4241 10.002	4611 8.163
HSK-A 63	10	2.01	30.0	50.0	85.0	40.0	39.0	4621 10.100	4912 5.000	4241 10.002	4611 10.063
HSK-A 63	10	4.15	30.0	50.0	85.0	40.0	39.0	4621 10.101	4912 5.000	4241 10.002	4611 10.163
HSK-A 63	12	2.01	32.0	50.0	90.0	45.0	45.0	4621 12.100	4912 5.000	4241 10.002	4611 12.063
HSK-A 63	12	4.15	32.0	50.0	90.0	45.0	45.0	4621 12.101	4912 5.000	4241 10.002	4611 12.163
HSK-A 63	12	9.08	32.0	50.0	90.0	45.0	45.0	4621 12.102	4912 5.000	4241 10.002	4611 12.263
HSK-A 63	14	2.01	34.0	50.0	90.0	45.0	46.0	4621 14.100	4912 5.000	4241 10.002	4611 14.063



Article no.

4611

d3	d1 mm	A mm ²	d2 mm	d4 mm	l1 mm	l2 mm	l5 mm	①	②	②	Order no.
HSK-A 63	14	4.15	34.0	50.0	90.0	45.0	46.0	4621 14.101	4912 5.000	4241 10.002	4611 14.163
HSK-A 63	14	9.08	34.0	50.0	90.0	45.0	46.0	4621 14.102	4912 5.000	4241 10.002	4611 14.263
HSK-A 63	16	2.01	38.0	50.0	95.0	48.0	51.0	4621 16.100	4912 5.000	4241 10.002	4611 16.063
HSK-A 63	16	4.15	38.0	50.0	95.0	48.0	51.0	4621 16.101	4912 5.000	4241 10.002	4611 16.163
HSK-A 63	16	9.08	38.0	50.0	95.0	48.0	51.0	4621 16.102	4912 5.000	4241 10.002	4611 16.263
HSK-A 63	18	2.01	40.0	50.0	95.0	48.0	52.0	4621 18.100	4912 5.000	4241 10.002	4611 18.063
HSK-A 63	18	4.15	40.0	50.0	95.0	48.0	52.0	4621 18.101	4912 5.000	4241 10.002	4611 18.163
HSK-A 63	18	9.08	40.0	50.0	95.0	48.0	52.0	4621 18.102	4912 5.000	4241 10.002	4611 18.263
HSK-A 63	20	4.15	42.0	50.0	100.0	50.0	58.0	4621 20.100	4912 5.000	4241 10.001	4611 20.063
HSK-A 63	20	9.08	42.0	50.0	100.0	50.0	58.0	4621 20.101	4912 5.000	4241 10.001	4611 20.163
HSK-A 63	20	16.62	42.0	50.0	100.0	50.0	58.0	4621 20.102	4912 5.000	4241 10.001	4611 20.263
HSK-A 63	25	4.15	57.0	63.0	115.0	56.0	50.0	4621 25.100	4912 6.000	4241 12.000	4611 25.063
HSK-A 63	25	9.08	57.0	63.0	115.0	56.0	50.0	4621 25.101	4912 6.000	4241 12.000	4611 25.163
HSK-A 63	25	16.62	57.0	63.0	115.0	56.0	50.0	4621 25.102	4912 6.000	4241 12.000	4611 25.263
HSK-A 63	32	4.15	64.0	75.0	120.0	60.0	58.0	4621 32.100	4912 6.000	4241 12.000	4611 32.063
HSK-A 63	32	9.08	64.0	75.0	120.0	60.0	58.0	4621 32.101	4912 6.000	4241 12.000	4611 32.163
HSK-A 63	32	16.62	64.0	75.0	120.0	60.0	58.0	4621 32.102	4912 6.000	4241 12.000	4611 32.263
HSK-A 80	6	2.01	26.0	50.0	85.0	36.0	39.0	4621 6.100	4912 5.000	4241 10.002	4611 6.080
HSK-A 80	6	4.15	26.0	50.0	85.0	36.0	39.0	4621 6.101	4912 5.000	4241 10.002	4611 6.180
HSK-A 80	8	2.01	28.0	50.0	85.0	36.0	39.0	4621 8.100	4912 5.000	4241 10.002	4611 8.080
HSK-A 80	8	4.15	28.0	50.0	85.0	36.0	39.0	4621 8.101	4912 5.000	4241 10.002	4611 8.180
HSK-A 80	10	2.01	30.0	50.0	90.0	40.0	45.0	4621 10.100	4912 5.000	4241 10.002	4611 10.080
HSK-A 80	10	4.15	30.0	50.0	90.0	40.0	45.0	4621 10.101	4912 5.000	4241 10.002	4611 10.180
HSK-A 80	12	2.01	32.0	50.0	95.0	45.0	50.0	4621 12.100	4912 5.000	4241 10.002	4611 12.080
HSK-A 80	12	4.15	32.0	50.0	95.0	45.0	50.0	4621 12.101	4912 5.000	4241 10.002	4611 12.180
HSK-A 80	12	9.08	32.0	50.0	95.0	45.0	50.0	4621 12.102	4912 5.000	4241 10.002	4611 12.280
HSK-A 80	14	2.01	34.0	50.0	95.0	45.0	50.0	4621 14.100	4912 5.000	4241 10.002	4611 14.080
HSK-A 80	14	4.15	34.0	50.0	95.0	45.0	50.0	4621 14.101	4912 5.000	4241 10.002	4611 14.180
HSK-A 80	14	9.08	34.0	50.0	95.0	45.0	50.0	4621 14.102	4912 5.000	4241 10.002	4611 14.280
HSK-A 80	16	2.01	38.0	50.0	100.0	48.0	56.0	4621 16.100	4912 5.000	4241 10.002	4611 16.080
HSK-A 80	16	4.15	38.0	50.0	100.0	48.0	56.0	4621 16.101	4912 5.000	4241 10.002	4611 16.180
HSK-A 80	16	9.08	38.0	50.0	100.0	48.0	56.0	4621 16.102	4912 5.000	4241 10.002	4611 16.280
HSK-A 80	18	2.01	40.0	50.0	100.0	48.0	56.0	4621 18.100	4912 5.000	4241 10.002	4611 18.080
HSK-A 80	18	4.15	40.0	50.0	100.0	48.0	56.0	4621 18.101	4912 5.000	4241 10.002	4611 18.180
HSK-A 80	18	9.08	40.0	50.0	100.0	48.0	56.0	4621 18.102	4912 5.000	4241 10.002	4611 18.280
HSK-A 80	20	4.15	42.0	50.0	105.0	50.0	62.0	4621 20.100	4912 5.000	4241 10.001	4611 20.080
HSK-A 80	20	9.08	42.0	50.0	105.0	50.0	62.0	4621 20.101	4912 5.000	4241 10.001	4611 20.180
HSK-A 80	20	16.62	42.0	50.0	105.0	50.0	62.0	4621 20.102	4912 5.000	4241 10.001	4611 20.280
HSK-A 80	25	4.15	57.0	63.0	115.0	56.0	70.0	4621 25.100	4912 6.000	4241 12.000	4611 25.080
HSK-A 80	25	9.08	57.0	63.0	115.0	56.0	70.0	4621 25.101	4912 6.000	4241 12.000	4611 25.180
HSK-A 80	25	16.62	57.0	63.0	115.0	56.0	70.0	4621 25.102	4912 6.000	4241 12.000	4611 25.280
HSK-A 80	32	4.15	64.0	75.0	120.0	60.0	58.0	4621 32.100	4912 6.000	4241 12.000	4611 32.080
HSK-A 80	32	9.08	64.0	75.0	120.0	60.0	58.0	4621 32.101	4912 6.000	4241 12.000	4611 32.180
HSK-A 80	32	16.62	64.0	75.0	120.0	60.0	58.0	4621 32.102	4912 6.000	4241 12.000	4611 32.280
HSK-A 100	6	2.01	26.0	50.0	85.0	36.0	36.0	4621 6.100	4912 5.000	4241 10.002	4611 6.100
HSK-A 100	6	4.15	26.0	50.0	85.0	36.0	36.0	4621 6.101	4912 5.000	4241 10.002	4611 6.101
HSK-A 100	8	2.01	28.0	50.0	85.0	36.0	36.0	4621 8.100	4912 5.000	4241 10.002	4611 8.100
HSK-A 100	8	4.15	28.0	50.0	85.0	36.0	36.0	4621 8.101	4912 5.000	4241 10.002	4611 8.101
HSK-A 100	10	2.01	30.0	50.0	90.0	40.0	42.0	4621 10.100	4912 5.000	4241 10.002	4611 10.100
HSK-A 100	10	4.15	30.0	50.0	90.0	40.0	42.0	4621 10.101	4912 5.000	4241 10.002	4611 10.101
HSK-A 100	12	2.01	32.0	50.0	95.0	45.0	47.0	4621 12.100	4912 5.000	4241 10.002	4611 12.100
HSK-A 100	12	4.15	32.0	50.0	95.0	45.0	47.0	4621 12.101	4912 5.000	4241 10.002	4611 12.101
HSK-A 100	12	9.08	32.0	50.0	95.0	45.0	47.0	4621 12.102	4912 5.000	4241 10.002	4611 12.102
HSK-A 100	14	2.01	34.0	50.0	95.0	45.0	47.0	4621 14.100	4912 5.000	4241 10.002	4611 14.100
HSK-A 100	14	4.15	34.0	50.0	95.0	45.0	47.0	4621 14.101	4912 5.000	4241 10.002	4611 14.101
HSK-A 100	14	9.08	34.0	50.0	95.0	45.0	47.0	4621 14.102	4912 5.000	4241 10.002	4611 14.102
HSK-A 100	16	2.01	38.0	50.0	100.0	48.0	53.0	4621 16.100	4912 5.000	4241 10.002	4611 16.100
HSK-A 100	16	4.15	38.0	50.0	100.0	48.0	53.0	4621 16.101	4912 5.000	4241 10.002	4611 16.101
HSK-A 100	16	9.08	38.0	50.0	100.0	48.0	53.0	4621 16.102	4912 5.000	4241 10.002	4611 16.102
HSK-A 100	18	2.01	40.0	50.0	100.0	48.0	53.0	4621 18.100	4912 5.000	4241 10.002	4611 18.100
HSK-A 100	18	4.15	40.0	50.0	100.0	48.0	53.0	4621 18.101	4912 5.000	4241 10.002	4611 18.101
HSK-A 100	18	9.08	40.0	50.0	100.0	48.0	53.0	4621 18.102	4912 5.000	4241 10.002	4611 18.102
HSK-A 100	20	4.15	42.0	50.0	105.0	50.0	59.0	4621 20.100	4912 5.000	4241 10.001	4611 20.100
HSK-A 100	20	9.08	42.0	50.0	105.0	50.0	59.0	4621 20.101	4912 5.000	4241 10.001	4611 20.101
HSK-A 100	20	16.62	42.0	50.0	105.0	50.0	59.0	4621 20.102	4912 5.000	4241 10.001	4611 20.102
HSK-A 100	25	4.15	57.0	63.0	115.0	56.0	67.0	4621 25.100	4912 6.000	4241 12.000	4611 25.100
HSK-A 100	25	9.08	57.0	63.0	115.0	56.0	67.0	4621 25.101	4912 6.000	4241 12.000	4611 25.101
HSK-A 100	25	16.62	57.0	63.0	115.0	56.0	67.0	4621 25.102	4912 6.000	4241 12.000	4611 25.102
HSK-A 100	32	4.15	64.0	75.0	120.0	60.0	72.0	4621 32.100	4912 6.000	4241 12.000	4611 32.100
HSK-A 100	32	9.08	64.0	75.0	120.0	60.0	72.0	4621 32.101	4912 6.000	4241 12.000	4611 32.101
HSK-A 100	32	16.62	64.0	75.0	120.0	60.0	72.0	4621 32.102	4912 6.000	4241 12.000	4611 32.102

MQL technology



Product information:

- HSK-A according to ISO 12164-1 / DIN 69893-1
- balancing quality: G 2.5 / 25,000 rpm or rev. < 1 gmm
- for tool shanks d1 h6
- axial length adjustment
- for MQL 2-channel systems, to company standard
- cross-section A (mm²) ratio 4:1, see info page

Scope of delivery:

- MQL 2-channel axial adjusting screw (1) art. no. 4621
- MQL 2-channel transfer unit with pipe, art. no. 4623

suitable accessories separately available:

- replacement adjusting screw (1), art. no. 4621
- replacement clamping screw (2) art. no. 4241
- hexagonal key (2), art. no. 4912

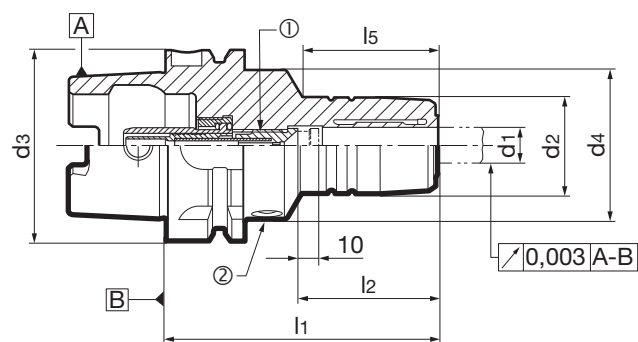

Article no.

4612

d3	d1 mm	A mm ²	d2 mm	d4 mm	l1 mm	l2 mm	l5 mm	①	②	②	Order no.
HSK-A 32	6	2.01	26.0	40.0	80.0	36.0	29.0	4621 6.032	4912 4.000	4241 8.000	4612 6.032
HSK-A 32	6	4.15	26.0	40.0	80.0	36.0	29.0	4621 6.132	4912 4.000	4241 8.000	4612 6.132
HSK-A 32	8	2.01	28.0	40.0	80.0	36.0	29.0	4621 8.032	4912 4.000	4241 8.000	4612 8.032
HSK-A 32	8	4.15	28.0	40.0	80.0	36.0	29.0	4621 8.132	4912 4.000	4241 8.000	4612 8.132
HSK-A 32	10	2.01	30.0	40.0	85.0	40.0	35.0	4621 10.032	4912 4.000	4241 8.000	4612 10.032
HSK-A 32	10	4.15	30.0	40.0	85.0	40.0	35.0	4621 10.132	4912 4.000	4241 8.000	4612 10.132
HSK-A 32	12	2.01	32.0	40.0	90.0	45.0	40.0	4621 12.032	4912 4.000	4241 8.000	4612 12.032
HSK-A 32	12	4.15	32.0	40.0	90.0	45.0	40.0	4621 12.132	4912 4.000	4241 8.000	4612 12.132
HSK-A 40	6	2.01	26.0	33.5	80.0	36.0	46.0	4621 6.040	4912 4.000	4241 8.001	4612 6.040
HSK-A 40	6	4.15	26.0	33.5	80.0	36.0	46.0	4621 6.140	4912 4.000	4241 8.001	4612 6.140
HSK-A 40	8	2.01	28.0	33.5	80.0	36.0	46.0	4621 8.040	4912 4.000	4241 8.001	4612 8.040
HSK-A 40	8	4.15	28.0	33.5	80.0	36.0	46.0	4621 8.140	4912 4.000	4241 8.001	4612 8.140
HSK-A 40	10	2.01	30.0	33.5	80.0	40.0	46.0	4621 10.040	4912 4.000	4241 8.001	4612 10.040
HSK-A 40	10	4.15	30.0	33.5	80.0	40.0	46.0	4621 10.140	4912 4.000	4241 8.001	4612 10.140
HSK-A 40	12	2.01	32.0	33.5	90.0	45.0	56.0	4621 12.040	4912 4.000	4241 8.001	4612 12.040
HSK-A 40	12	4.15	32.0	33.5	90.0	45.0	56.0	4621 12.140	4912 4.000	4241 8.001	4612 12.140
HSK-A 40	12	9.08	32.0	33.5	90.0	45.0	56.0	4621 12.240	4912 4.000	4241 8.001	4612 12.240
HSK-A 50	6	2.01	26.0	40.0	80.0	36.0	38.0	4621 6.050	4912 4.000	4241 8.000	4612 6.050
HSK-A 50	6	4.15	26.0	40.0	80.0	36.0	38.0	4621 6.150	4912 4.000	4241 8.000	4612 6.150
HSK-A 50	8	2.01	28.0	40.0	80.0	36.0	38.0	4621 8.050	4912 4.000	4241 8.000	4612 8.050
HSK-A 50	8	4.15	28.0	40.0	80.0	36.0	38.0	4621 8.150	4912 4.000	4241 8.000	4612 8.150
HSK-A 50	10	2.01	30.0	40.0	85.0	40.0	44.0	4621 10.050	4912 4.000	4241 8.000	4612 10.050
HSK-A 50	10	4.15	30.0	40.0	85.0	40.0	44.0	4621 10.150	4912 4.000	4241 8.000	4612 10.150
HSK-A 50	12	2.01	32.0	40.0	90.0	45.0	49.0	4621 12.050	4912 4.000	4241 8.000	4612 12.050
HSK-A 50	12	4.15	32.0	40.0	90.0	45.0	49.0	4621 12.150	4912 4.000	4241 8.000	4612 12.150
HSK-A 50	12	9.08	32.0	40.0	90.0	45.0	49.0	4621 12.250	4912 4.000	4241 8.000	4612 12.250
HSK-A 50	14	2.01	34.0	40.0	90.0	45.0	49.0	4621 14.050	4912 4.000	4241 8.000	4612 14.050
HSK-A 50	14	4.15	34.0	40.0	90.0	45.0	49.0	4621 14.150	4912 4.000	4241 8.000	4612 14.150
HSK-A 50	14	9.08	34.0	40.0	90.0	45.0	49.0	4621 14.250	4912 4.000	4241 8.000	4612 14.250
HSK-A 50	16	2.01	38.0	53.0	95.0	48.0	36.0	4621 16.050	4912 5.000	4241 10.002	4612 16.050
HSK-A 50	16	4.15	38.0	53.0	95.0	48.0	36.0	4621 16.150	4912 5.000	4241 10.002	4612 16.150
HSK-A 50	16	9.08	38.0	53.0	95.0	48.0	36.0	4621 16.250	4912 5.000	4241 10.002	4612 16.250
HSK-A 50	18	2.01	40.0	57.0	95.0	48.0	36.0	4621 18.050	4912 5.000	4241 10.002	4612 18.050
HSK-A 50	18	4.15	40.0	57.0	95.0	48.0	36.0	4621 18.150	4912 5.000	4241 10.002	4612 18.150
HSK-A 50	18	9.08	40.0	57.0	95.0	48.0	36.0	4621 18.250	4912 5.000	4241 10.002	4612 18.250
HSK-A 50	20	4.15	42.0	60.0	100.0	50.0	39.0	4621 20.050	4912 5.000	4241 10.001	4612 20.050
HSK-A 50	20	9.08	42.0	60.0	100.0	50.0	39.0	4621 20.150	4912 5.000	4241 10.001	4612 20.150
HSK-A 50	20	16.62	42.0	60.0	100.0	50.0	39.0	4621 20.250	4912 5.000	4241 10.001	4612 20.250
HSK-A 63	6	2.01	26.0	50.0	80.0	36.0	34.5	4621 6.100	4912 5.000	4241 10.002	4612 6.063
HSK-A 63	6	4.15	26.0	50.0	80.0	36.0	34.5	4621 6.101	4912 5.000	4241 10.002	4612 6.163
HSK-A 63	8	2.01	28.0	50.0	80.0	36.0	35.5	4621 8.100	4912 5.000	4241 10.002	4612 8.063
HSK-A 63	8	4.15	28.0	50.0	80.0	36.0	35.5	4621 8.101	4912 5.000	4241 10.002	4612 8.163
HSK-A 63	10	2.01	30.0	50.0	85.0	40.0	39.0	4621 10.100	4912 5.000	4241 10.002	4612 10.063
HSK-A 63	10	4.15	30.0	50.0	85.0	40.0	39.0	4621 10.101	4912 5.000	4241 10.002	4612 10.163
HSK-A 63	12	2.01	32.0	50.0	90.0	45.0	45.0	4621 12.100	4912 5.000	4241 10.002	4612 12.063
HSK-A 63	12	4.15	32.0	50.0	90.0	45.0	45.0	4621 12.101	4912 5.000	4241 10.002	4612 12.163
HSK-A 63	12	9.08	32.0	50.0	90.0	45.0	45.0	4621 12.102	4912 5.000	4241 10.002	4612 12.263
HSK-A 63	14	2.01	34.0	50.0	90.0	45.0	46.0	4621 14.100	4912 5.000	4241 10.002	4612 14.063



Article no.

4612

d3	d1 mm	A mm ²	d2 mm	d4 mm	l1 mm	l2 mm	l5 mm	①	②	②	Order no.
HSK-A 63	14	4.15	34.0	50.0	90.0	45.0	46.0	4621 14.101	4912 5.000	4241 10.002	4612 14.163
HSK-A 63	14	9.08	34.0	50.0	90.0	45.0	46.0	4621 14.102	4912 5.000	4241 10.002	4612 14.263
HSK-A 63	16	2.01	38.0	50.0	95.0	48.0	51.0	4621 16.100	4912 5.000	4241 10.002	4612 16.063
HSK-A 63	16	4.15	38.0	50.0	95.0	48.0	51.0	4621 16.101	4912 5.000	4241 10.002	4612 16.163
HSK-A 63	16	9.08	38.0	50.0	95.0	48.0	51.0	4621 16.102	4912 5.000	4241 10.002	4612 16.263
HSK-A 63	18	2.01	40.0	50.0	95.0	48.0	52.0	4621 18.100	4912 5.000	4241 10.002	4612 18.063
HSK-A 63	18	4.15	40.0	50.0	95.0	48.0	52.0	4621 18.101	4912 5.000	4241 10.002	4612 18.163
HSK-A 63	18	9.08	40.0	50.0	95.0	48.0	52.0	4621 18.102	4912 5.000	4241 10.002	4612 18.263
HSK-A 63	20	4.15	42.0	50.0	100.0	50.0	58.0	4621 20.100	4912 5.000	4241 10.001	4612 20.063
HSK-A 63	20	9.08	42.0	50.0	100.0	50.0	58.0	4621 20.101	4912 5.000	4241 10.001	4612 20.163
HSK-A 63	20	16.62	42.0	50.0	100.0	50.0	58.0	4621 20.102	4912 5.000	4241 10.001	4612 20.263
HSK-A 63	25	4.15	57.0	63.0	115.0	56.0	50.0	4621 25.100	4912 6.000	4241 12.000	4612 25.063
HSK-A 63	25	9.08	57.0	63.0	115.0	56.0	50.0	4621 25.101	4912 6.000	4241 12.000	4612 25.163
HSK-A 63	25	16.62	57.0	63.0	115.0	56.0	50.0	4621 25.102	4912 6.000	4241 12.000	4612 25.263
HSK-A 63	32	4.15	64.0	75.0	120.0	60.0	58.0	4621 32.100	4912 6.000	4241 12.000	4612 32.063
HSK-A 63	32	9.08	64.0	75.0	120.0	60.0	58.0	4621 32.101	4912 6.000	4241 12.000	4612 32.163
HSK-A 63	32	16.62	64.0	75.0	120.0	60.0	58.0	4621 32.102	4912 6.000	4241 12.000	4612 32.263
HSK-A 80	6	2.01	26.0	50.0	85.0	36.0	39.0	4621 6.100	4912 5.000	4241 10.002	4612 6.080
HSK-A 80	6	4.15	26.0	50.0	85.0	36.0	39.0	4621 6.101	4912 5.000	4241 10.002	4612 6.180
HSK-A 80	8	2.01	28.0	50.0	85.0	36.0	39.0	4621 8.100	4912 5.000	4241 10.002	4612 8.080
HSK-A 80	8	4.15	28.0	50.0	85.0	36.0	39.0	4621 8.101	4912 5.000	4241 10.002	4612 8.180
HSK-A 80	10	2.01	30.0	50.0	90.0	40.0	45.0	4621 10.100	4912 5.000	4241 10.002	4612 10.080
HSK-A 80	10	4.15	30.0	50.0	90.0	40.0	45.0	4621 10.101	4912 5.000	4241 10.002	4612 10.180
HSK-A 80	12	2.01	32.0	50.0	95.0	45.0	50.0	4621 12.100	4912 5.000	4241 10.002	4612 12.080
HSK-A 80	12	4.15	32.0	50.0	95.0	45.0	50.0	4621 12.101	4912 5.000	4241 10.002	4612 12.180
HSK-A 80	12	9.08	32.0	50.0	95.0	45.0	50.0	4621 12.102	4912 5.000	4241 10.002	4612 12.280
HSK-A 80	14	2.01	34.0	50.0	95.0	45.0	50.0	4621 14.100	4912 5.000	4241 10.002	4612 14.080
HSK-A 80	14	4.15	34.0	50.0	95.0	45.0	50.0	4621 14.101	4912 5.000	4241 10.002	4612 14.180
HSK-A 80	14	9.08	34.0	50.0	95.0	45.0	50.0	4621 14.102	4912 5.000	4241 10.002	4612 14.280
HSK-A 80	16	2.01	38.0	50.0	100.0	48.0	56.0	4621 16.100	4912 5.000	4241 10.002	4612 16.080
HSK-A 80	16	4.15	38.0	50.0	100.0	48.0	56.0	4621 16.101	4912 5.000	4241 10.002	4612 16.180
HSK-A 80	16	9.08	38.0	50.0	100.0	48.0	56.0	4621 16.102	4912 5.000	4241 10.002	4612 16.280
HSK-A 80	18	2.01	40.0	50.0	100.0	48.0	56.0	4621 18.100	4912 5.000	4241 10.002	4612 18.080
HSK-A 80	18	4.15	40.0	50.0	100.0	48.0	56.0	4621 18.101	4912 5.000	4241 10.002	4612 18.180
HSK-A 80	18	9.08	40.0	50.0	100.0	48.0	56.0	4621 18.102	4912 5.000	4241 10.002	4612 18.280
HSK-A 80	20	4.15	42.0	50.0	105.0	50.0	62.0	4621 20.100	4912 5.000	4241 10.001	4612 20.080
HSK-A 80	20	9.08	42.0	50.0	105.0	50.0	62.0	4621 20.101	4912 5.000	4241 10.001	4612 20.180
HSK-A 80	20	16.62	42.0	50.0	105.0	50.0	62.0	4621 20.102	4912 5.000	4241 10.001	4612 20.280
HSK-A 80	25	4.15	57.0	63.0	115.0	56.0	70.0	4621 25.100	4912 6.000	4241 12.000	4612 25.080
HSK-A 80	25	9.08	57.0	63.0	115.0	56.0	70.0	4621 25.101	4912 6.000	4241 12.000	4612 25.180
HSK-A 80	25	16.62	57.0	63.0	115.0	56.0	70.0	4621 25.102	4912 6.000	4241 12.000	4612 25.280
HSK-A 80	32	4.15	64.0	75.0	120.0	60.0	58.0	4621 32.100	4912 6.000	4241 12.000	4612 32.080
HSK-A 80	32	9.08	64.0	75.0	120.0	60.0	58.0	4621 32.101	4912 6.000	4241 12.000	4612 32.180
HSK-A 80	32	16.62	64.0	75.0	120.0	60.0	58.0	4621 32.102	4912 6.000	4241 12.000	4612 32.280
HSK-A 100	6	2.01	26.0	50.0	85.0	36.0	36.0	4621 6.100	4912 5.000	4241 10.002	4612 6.100
HSK-A 100	6	4.15	26.0	50.0	85.0	36.0	36.0	4621 6.101	4912 5.000	4241 10.002	4612 6.101
HSK-A 100	8	2.01	28.0	50.0	85.0	36.0	36.0	4621 8.100	4912 5.000	4241 10.002	4612 8.100
HSK-A 100	8	4.15	28.0	50.0	85.0	36.0	36.0	4621 8.101	4912 5.000	4241 10.002	4612 8.101
HSK-A 100	10	2.01	30.0	50.0	90.0	40.0	42.0	4621 10.100	4912 5.000	4241 10.002	4612 10.100
HSK-A 100	10	4.15	30.0	50.0	90.0	40.0	42.0	4621 10.101	4912 5.000	4241 10.002	4612 10.101
HSK-A 100	12	2.01	32.0	50.0	95.0	45.0	47.0	4621 12.100	4912 5.000	4241 10.002	4612 12.100
HSK-A 100	12	4.15	32.0	50.0	95.0	45.0	47.0	4621 12.101	4912 5.000	4241 10.002	4612 12.101
HSK-A 100	12	9.08	32.0	50.0	95.0	45.0	47.0	4621 12.102	4912 5.000	4241 10.002	4612 12.102
HSK-A 100	14	2.01	34.0	50.0	95.0	45.0	47.0	4621 14.100	4912 5.000	4241 10.002	4612 14.100
HSK-A 100	14	4.15	34.0	50.0	95.0	45.0	47.0	4621 14.101	4912 5.000	4241 10.002	4612 14.101
HSK-A 100	14	9.08	34.0	50.0	95.0	45.0	47.0	4621 14.102	4912 5.000	4241 10.002	4612 14.102
HSK-A 100	16	2.01	38.0	50.0	100.0	48.0	53.0	4621 16.100	4912 5.000	4241 10.002	4612 16.100
HSK-A 100	16	4.15	38.0	50.0	100.0	48.0	53.0	4621 16.101	4912 5.000	4241 10.002	4612 16.101
HSK-A 100	16	9.08	38.0	50.0	100.0	48.0	53.0	4621 16.102	4912 5.000	4241 10.002	4612 16.102
HSK-A 100	18	2.01	40.0	50.0	100.0	48.0	53.0	4621 18.100	4912 5.000	4241 10.002	4612 18.100
HSK-A 100	18	4.15	40.0	50.0	100.0	48.0	53.0	4621 18.101	4912 5.000	4241 10.002	4612 18.101
HSK-A 100	18	9.08	40.0	50.0	100.0	48.0	53.0	4621 18.102	4912 5.000	4241 10.002	4612 18.102
HSK-A 100	20	4.15	42.0	50.0	105.0	50.0	59.0	4621 20.100	4912 5.000	4241 10.001	4612 20.100
HSK-A 100	20	9.08	42.0	50.0	105.0	50.0	59.0	4621 20.101	4912 5.000	4241 10.001	4612 20.101
HSK-A 100	20	16.62	42.0	50.0	105.0	50.0	59.0	4621 20.102	4912 5.000	4241 10.001	4612 20.102
HSK-A 100	25	4.15	57.0	63.0	115.0	56.0	67.0	4621 25.100	4912 6.000	4241 12.000	4612 25.100
HSK-A 100	25	9.08	57.0	63.0	115.0	56.0	67.0	4621 25.101	4912 6.000	4241 12.000	4612 25.101
HSK-A 100	25	16.62	57.0	63.0	115.0	56.0	67.0	4621 25.102	4912 6.000	4241 12.000	4612 25.102
HSK-A 100	32	4.15	64.0	75.0	120.0	60.0	72.0	4621 32.100	4912 6.000	4241 12.000	4612 32.100
HSK-A 100	32	9.08	64.0	75.0	120.0	60.0	72.0	4621 32.101	4912 6.000	4241 12.000	4612 32.101
HSK-A 100	32	16.62	64.0	75.0	120.0	60.0	72.0	4621 32.102	4912 6.000	4241 12.000	4612 32.102

MQL technology



Product information:

- HSK-A according to ISO 12164-1 / DIN 69893-1
- balancing quality: G 2.5 / 25,000 rpm or rev. < 1 gmm
- for tool shanks d1 h6
- for MQL 2-channel systems, to company standard
- incl. balancing thread 4xM6/6xM6
- even in excess lengths l1 = 120 mm (concentricity 4 µm) and 160 mm (concentricity 5 µm)
- cross-section A (mm²) ratio 4:1, see info page

Scope of delivery:

- MQL 2-channel axial adjusting screw (1) art. no. 4621
- MQL 2-channel filler with tube art. no. 4622

suitable accessories separately available:

- replacement adjusting screw (1), art. no. 4621

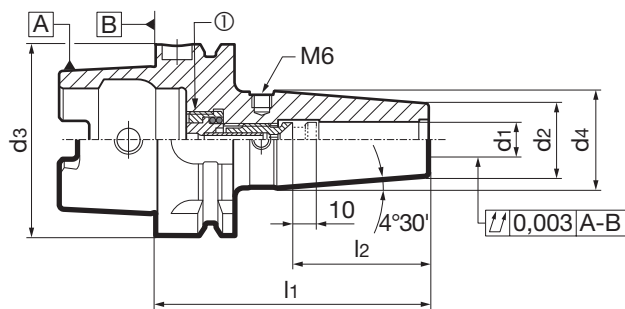

Article no.

4613

d3	d1 mm	A mm ²	d2 mm	d4 mm	l1 mm	l2 mm	①	Order no.
HSK-A 32	6	2.01	21	25.5	80	36	4621 6.032	4613 6.032
HSK-A 32	6	4.15	21	25.5	80	36	4621 6.132	4613 6.132
HSK-A 32	8	2.01	21	25.5	80	36	4621 8.032	4613 8.032
HSK-A 32	8	4.15	21	25.5	80	36	4621 8.132	4613 8.132
HSK-A 32	10	2.01	24	31.7	85	40	4621 10.032	4613 10.032
HSK-A 32	10	4.15	24	31.7	85	40	4621 10.132	4613 10.132
HSK-A 32	12	2.01	24	32.3	90	45	4621 12.032	4613 12.032
HSK-A 32	12	4.15	24	32.3	90	45	4621 12.132	4613 12.132
HSK-A 40	6	2.01	21	27.0	80	36	4621 6.040	4613 6.040
HSK-A 40	6	4.15	21	27.0	80	36	4621 6.140	4613 6.140
HSK-A 40	8	2.01	21	27.0	80	36	4621 8.040	4613 8.040
HSK-A 40	8	4.15	21	27.0	80	36	4621 8.140	4613 8.140
HSK-A 40	10	2.01	24	32.0	80	40	4621 10.040	4613 10.040
HSK-A 40	10	4.15	24	32.0	80	40	4621 10.140	4613 10.140
HSK-A 40	12	2.01	24	32.0	90	45	4621 12.040	4613 12.040
HSK-A 40	12	4.15	24	32.0	90	45	4621 12.140	4613 12.140
HSK-A 40	12	9.08	24	32.0	90	45	4621 12.240	4613 12.240
HSK-A 40	14	2.01	27	33.5	90	45	4621 14.040	4613 14.040
HSK-A 40	14	4.15	27	33.5	90	45	4621 14.140	4613 14.140
HSK-A 40	14	9.08	27	33.5	90	45	4621 14.240	4613 14.240
HSK-A 40	16	2.01	27	33.5	90	48	4621 16.040	4613 16.040
HSK-A 40	16	4.15	27	33.5	90	48	4621 16.140	4613 16.140
HSK-A 40	16	9.08	27	33.5	90	48	4621 16.240	4613 16.240
HSK-A 50	6	2.01	21	27.0	80	36	4621 6.050	4613 6.050
HSK-A 50	6	4.15	21	27.0	80	36	4621 6.150	4613 6.150
HSK-A 50	8	2.01	21	27.0	80	36	4621 8.050	4613 8.050
HSK-A 50	8	4.15	21	27.0	80	36	4621 8.150	4613 8.150
HSK-A 50	10	2.01	24	32.0	85	40	4621 10.050	4613 10.050
HSK-A 50	10	4.15	24	32.0	85	40	4621 10.150	4613 10.150
HSK-A 50	12	2.01	24	32.0	90	45	4621 12.050	4613 12.050
HSK-A 50	12	4.15	24	32.0	90	45	4621 12.150	4613 12.150
HSK-A 50	12	9.08	24	32.0	90	45	4621 12.250	4613 12.250
HSK-A 50	14	2.01	27	34.0	90	45	4621 14.050	4613 14.050
HSK-A 50	14	4.15	27	34.0	90	45	4621 14.150	4613 14.150
HSK-A 50	14	9.08	27	34.0	90	45	4621 14.250	4613 14.250
HSK-A 50	16	2.01	27	34.0	95	48	4621 16.050	4613 16.050
HSK-A 50	16	4.15	27	34.0	95	48	4621 16.150	4613 16.150
HSK-A 50	16	9.08	27	34.0	95	48	4621 16.250	4613 16.250
HSK-A 50	18	2.01	33	41.5	95	48	4621 18.050	4613 18.050
HSK-A 50	18	4.15	33	41.5	95	48	4621 18.150	4613 18.150
HSK-A 50	18	9.08	33	41.5	95	48	4621 18.250	4613 18.250
HSK-A 50	20	4.15	33	41.5	100	50	4621 20.050	4613 20.050
HSK-A 50	20	9.08	33	41.5	100	50	4621 20.150	4613 20.150
HSK-A 50	20	16.62	33	41.5	100	50	4621 20.250	4613 20.250
HSK-A 63	6	2.01	21	27.0	80	36	4621 6.100	4613 6.063
HSK-A 63	6	4.15	21	27.0	80	36	4621 6.101	4613 6.163
HSK-A 63	8	2.01	21	27.0	80	36	4621 8.100	4613 8.063
HSK-A 63	8	4.15	21	27.0	80	36	4621 8.101	4613 8.163

MQL technology



Article no.

4613

d3	d1 mm	A mm ²	d2 mm	d4 mm	l1 mm	l2 mm	①	Order no.
HSK-A 63	10	2.01	24	32.0	85	40	4621 10.100	4613 10.063
HSK-A 63	10	4.15	24	32.0	85	40	4621 10.101	4613 10.163
HSK-A 63	12	2.01	24	32.0	90	45	4621 12.100	4613 12.063
HSK-A 63	12	4.15	24	32.0	90	45	4621 12.101	4613 12.163
HSK-A 63	12	9.08	24	32.0	90	45	4621 12.102	4613 12.263
HSK-A 63	14	2.01	27	34.0	90	45	4621 14.100	4613 14.063
HSK-A 63	14	4.15	27	34.0	90	45	4621 14.101	4613 14.163
HSK-A 63	14	9.08	27	34.0	90	45	4621 14.102	4613 14.263
HSK-A 63	16	2.01	27	34.0	95	48	4621 16.100	4613 16.063
HSK-A 63	16	4.15	27	34.0	95	48	4621 16.101	4613 16.163
HSK-A 63	16	9.08	27	34.0	95	48	4621 16.102	4613 16.263
HSK-A 63	18	2.01	33	42.0	95	48	4621 18.100	4613 18.063
HSK-A 63	18	4.15	33	42.0	95	48	4621 18.101	4613 18.163
HSK-A 63	18	9.08	33	42.0	95	48	4621 18.102	4613 18.263
HSK-A 63	20	4.15	33	42.0	100	50	4621 20.100	4613 20.063
HSK-A 63	20	9.08	33	42.0	100	50	4621 20.101	4613 20.163
HSK-A 63	20	16.62	33	42.0	100	50	4621 20.102	4613 20.263
HSK-A 63	25	4.15	44	52.5	115	56	4621 25.100	4613 25.063
HSK-A 63	25	9.08	44	52.5	115	56	4621 25.101	4613 25.163
HSK-A 63	25	16.62	44	52.5	115	56	4621 25.102	4613 25.263
HSK-A 63	32	4.15	44	52.5	120	60	4621 32.100	4613 32.063
HSK-A 63	32	9.08	44	52.5	120	60	4621 32.101	4613 32.163
HSK-A 63	32	16.62	44	52.5	120	60	4621 32.102	4613 32.263
HSK-A 63	6	2.01	21	27.0	160	36	4621 6.032	4613 106.063
HSK-A 63	6	4.15	21	27.0	160	36	4621 6.132	4613 106.163
HSK-A 63	8	2.01	21	27.0	160	36	4621 8.040	4613 108.063
HSK-A 63	8	4.15	21	27.0	160	36	4621 8.140	4613 108.163
HSK-A 63	10	2.01	24	32.0	160	40	4621 10.050	4613 110.063
HSK-A 63	10	4.15	24	32.0	160	40	4621 10.150	4613 110.163
HSK-A 63	12	2.01	24	32.0	160	45	4621 12.100	4613 112.063
HSK-A 63	12	4.15	24	32.0	160	45	4621 12.101	4613 112.163
HSK-A 63	12	9.08	24	32.0	160	45	4621 12.102	4613 112.263
HSK-A 63	14	2.01	27	34.0	160	45	4621 14.100	4613 114.063
HSK-A 63	14	4.15	27	34.0	160	45	4621 14.101	4613 114.163
HSK-A 63	14	9.08	27	34.0	160	45	4621 14.102	4613 114.263
HSK-A 63	16	2.01	27	34.0	160	48	4621 16.100	4613 116.063
HSK-A 63	16	4.15	27	34.0	160	48	4621 16.101	4613 116.163
HSK-A 63	16	9.08	27	34.0	160	48	4621 16.102	4613 116.263
HSK-A 63	18	2.01	33	42.0	160	48	4621 18.100	4613 118.063
HSK-A 63	18	4.15	33	42.0	160	48	4621 18.101	4613 118.163
HSK-A 63	18	9.08	33	42.0	160	48	4621 18.102	4613 118.263
HSK-A 63	20	4.15	33	42.0	160	50	4621 20.100	4613 120.063
HSK-A 63	20	9.08	33	42.0	160	50	4621 20.101	4613 120.163
HSK-A 63	20	16.62	33	42.0	160	50	4621 20.102	4613 120.263
HSK-A 63	25	4.15	44	52.5	160	56	4621 25.100	4613 125.063
HSK-A 63	25	9.08	44	52.5	160	56	4621 25.101	4613 125.163
HSK-A 63	25	16.62	44	52.5	160	56	4621 25.102	4613 125.263
HSK-A 63	32	4.15	44	52.5	160	60	4621 32.100	4613 132.063
HSK-A 63	32	9.08	44	52.5	160	60	4621 32.101	4613 132.163
HSK-A 63	32	16.62	44	52.5	160	60	4621 32.102	4613 132.263
HSK-A 63	6	2.01	21	27.0	120	36	4621 6.032	4613 206.063
HSK-A 63	6	4.15	21	27.0	120	36	4621 6.132	4613 206.163
HSK-A 63	8	2.01	21	27.0	120	36	4621 8.040	4613 208.063
HSK-A 63	8	4.15	21	27.0	120	36	4621 8.140	4613 208.163
HSK-A 63	10	2.01	24	32.0	120	40	4621 10.050	4613 210.063
HSK-A 63	10	4.15	24	32.0	120	40	4621 10.150	4613 210.163
HSK-A 63	12	2.01	24	32.0	120	45	4621 12.100	4613 212.063
HSK-A 63	12	4.15	24	32.0	120	45	4621 12.101	4613 212.163
HSK-A 63	12	9.08	24	32.0	120	45	4621 12.102	4613 212.263
HSK-A 63	14	2.01	27	34.0	120	45	4621 14.100	4613 214.063
HSK-A 63	14	4.15	27	34.0	120	45	4621 14.101	4613 214.163
HSK-A 63	14	9.08	27	34.0	120	45	4621 14.102	4613 214.263
HSK-A 63	16	2.01	27	34.0	120	48	4621 16.100	4613 216.063
HSK-A 63	16	4.15	27	34.0	120	48	4621 16.101	4613 216.163
HSK-A 63	16	9.08	27	34.0	120	48	4621 16.102	4613 216.263
HSK-A 63	18	2.01	33	42.0	120	48	4621 18.100	4613 218.063
HSK-A 63	18	4.15	33	42.0	120	48	4621 18.101	4613 218.163
HSK-A 63	18	9.08	33	42.0	120	48	4621 18.102	4613 218.263
HSK-A 63	20	4.15	33	42.0	120	50	4621 20.100	4613 220.063
HSK-A 63	20	9.08	33	42.0	120	50	4621 20.101	4613 220.163
HSK-A 63	20	16.62	33	42.0	120	50	4621 20.102	4613 220.263
HSK-A 80	6	2.01	21	27.0	85	36	4621 6.100	4613 6.080
HSK-A 80	6	4.15	21	27.0	85	36	4621 6.101	4613 6.180
HSK-A 80	8	2.01	21	27.0	85	36	4621 8.100	4613 8.080
HSK-A 80	8	4.15	21	27.0	85	36	4621 8.101	4613 8.180
HSK-A 80	10	2.01	24	32.0	90	40	4621 10.100	4613 10.080
HSK-A 80	10	4.15	24	32.0	90	40	4621 10.101	4613 10.180
HSK-A 80	12	2.01	24	32.0	95	45	4621 12.100	4613 12.080
HSK-A 80	12	4.15	24	32.0	95	45	4621 12.101	4613 12.180
HSK-A 80	12	9.08	24	32.0	95	45	4621 12.102	4613 12.280
HSK-A 80	14	2.01	27	34.0	95	45	4621 14.100	4613 14.080
HSK-A 80	14	4.15	27	34.0	95	45	4621 14.101	4613 14.180
HSK-A 80	14	9.08	27	34.0	95	45	4621 14.102	4613 14.280
HSK-A 80	16	2.01	27	34.0	100	48	4621 16.100	4613 16.080

MQL technology



Article no.

4613

d3	d1 mm	A mm ²	d2 mm	d4 mm	l1 mm	l2 mm	①	Order no.
HSK-A 80	16	4.15	27	34.0	100	48	4621 16.101	4613 16.180
HSK-A 80	16	9.08	27	34.0	100	48	4621 16.102	4613 16.280
HSK-A 80	18	2.01	33	42.0	100	48	4621 18.100	4613 18.080
HSK-A 80	18	4.15	33	42.0	100	48	4621 18.101	4613 18.180
HSK-A 80	18	9.08	33	42.0	100	48	4621 18.102	4613 18.280
HSK-A 80	20	4.15	33	42.0	105	50	4621 20.100	4613 20.080
HSK-A 80	20	9.08	33	42.0	105	50	4621 20.101	4613 20.180
HSK-A 80	20	16.62	33	42.0	105	50	4621 20.102	4613 20.280
HSK-A 80	25	4.15	44	53.0	115	56	4621 25.100	4613 25.080
HSK-A 80	25	9.08	44	53.0	115	56	4621 25.101	4613 25.180
HSK-A 80	25	16.62	44	53.0	115	56	4621 25.102	4613 25.280
HSK-A 80	32	4.15	44	53.0	120	60	4621 32.100	4613 32.080
HSK-A 80	32	9.08	44	53.0	120	60	4621 32.101	4613 32.180
HSK-A 80	32	16.62	44	53.0	120	60	4621 32.102	4613 32.280
HSK-A 100	6	2.01	21	27.0	85	36	4621 6.100	4613 6.100
HSK-A 100	6	4.15	21	27.0	85	36	4621 6.101	4613 6.101
HSK-A 100	8	2.01	21	27.0	85	36	4621 8.100	4613 8.100
HSK-A 100	8	4.15	21	27.0	85	36	4621 8.101	4613 8.101
HSK-A 100	10	2.01	24	32.0	90	40	4621 10.100	4613 10.100
HSK-A 100	10	4.15	24	32.0	90	40	4621 10.101	4613 10.101
HSK-A 100	12	2.01	24	32.0	95	45	4621 12.100	4613 12.100
HSK-A 100	12	4.15	24	32.0	95	45	4621 12.101	4613 12.101
HSK-A 100	12	9.08	24	32.0	95	45	4621 12.102	4613 12.102
HSK-A 100	14	2.01	27	34.0	95	45	4621 14.100	4613 14.100
HSK-A 100	14	4.15	27	34.0	95	45	4621 14.101	4613 14.101
HSK-A 100	14	9.08	27	34.0	95	45	4621 14.102	4613 14.102
HSK-A 100	16	2.01	27	34.0	100	48	4621 16.100	4613 16.100
HSK-A 100	16	4.15	27	34.0	100	48	4621 16.101	4613 16.101
HSK-A 100	16	9.08	27	34.0	100	48	4621 16.102	4613 16.102
HSK-A 100	18	2.01	33	42.0	100	48	4621 18.100	4613 18.100
HSK-A 100	18	4.15	33	42.0	100	48	4621 18.101	4613 18.101
HSK-A 100	18	9.08	33	42.0	100	48	4621 18.102	4613 18.102
HSK-A 100	20	4.15	33	42.0	105	50	4621 20.100	4613 20.100
HSK-A 100	20	9.08	33	42.0	105	50	4621 20.101	4613 20.101
HSK-A 100	20	16.62	33	42.0	105	50	4621 20.102	4613 20.102
HSK-A 100	25	4.15	44	53.0	115	56	4621 25.100	4613 25.100
HSK-A 100	25	9.08	44	53.0	115	56	4621 25.101	4613 25.101
HSK-A 100	25	16.62	44	53.0	115	56	4621 25.102	4613 25.102
HSK-A 100	32	4.15	44	53.0	120	60	4621 32.100	4613 32.100
HSK-A 100	32	9.08	44	53.0	120	60	4621 32.101	4613 32.101
HSK-A 100	32	16.62	44	53.0	120	60	4621 32.102	4613 32.102
HSK-A 100	6	2.01	21	27.0	160	36	4621 6.032	4613 106.100
HSK-A 100	6	4.15	21	27.0	160	36	4621 6.132	4613 106.101
HSK-A 100	8	2.01	21	27.0	160	36	4621 8.040	4613 108.100
HSK-A 100	8	4.15	21	27.0	160	36	4621 8.140	4613 108.101
HSK-A 100	10	2.01	24	32.0	160	40	4621 10.050	4613 110.100
HSK-A 100	10	4.15	24	32.0	160	40	4621 10.150	4613 110.101
HSK-A 100	12	2.01	24	32.0	160	45	4621 12.100	4613 112.100
HSK-A 100	12	4.15	24	32.0	160	45	4621 114.101	4613 112.101
HSK-A 100	12	9.08	24	32.0	160	45	4621 114.102	4613 112.102
HSK-A 100	14	2.01	27	34.0	160	45	4621 14.100	4613 114.100
HSK-A 100	14	4.15	27	34.0	160	45	4621 14.101	4613 114.101
HSK-A 100	14	9.08	27	34.0	160	45	4621 14.102	4613 114.102
HSK-A 100	16	2.01	27	34.0	160	48	4621 16.100	4613 116.100
HSK-A 100	16	4.15	27	34.0	160	48	4621 16.101	4613 116.101
HSK-A 100	16	9.08	27	34.0	160	48	4621 16.102	4613 116.102
HSK-A 100	18	2.01	33	42.0	160	48	4621 18.100	4613 118.100
HSK-A 100	18	4.15	33	42.0	160	48	4621 18.101	4613 118.101
HSK-A 100	18	9.08	33	42.0	160	48	4621 18.102	4613 118.102
HSK-A 100	20	4.15	33	42.0	160	50	4621 20.100	4613 120.100
HSK-A 100	20	9.08	33	42.0	160	50	4621 20.101	4613 120.101
HSK-A 100	20	16.62	33	42.0	160	50	4621 20.102	4613 120.102
HSK-A 100	25	4.15	44	53.0	160	56	4621 25.100	4613 125.100
HSK-A 100	25	9.08	44	53.0	160	56	4621 25.101	4613 125.101
HSK-A 100	25	16.62	44	53.0	160	56	4621 25.102	4613 125.102
HSK-A 100	32	4.15	44	53.0	160	60	4621 32.100	4613 132.100
HSK-A 100	32	9.08	44	53.0	160	60	4621 32.101	4613 132.101
HSK-A 100	32	16.62	44	53.0	160	60	4621 32.102	4613 132.102

MLL technology



MQL 2-channel shrink fit chucks HSK-A (automatic tool change)

Article no. 4614



Product information:

- HSK-A according to ISO 12164-1 / DIN 69893-1
- balancing quality: G 2.5 / 25,000 rpm or rev. < 1 gmm
- for tool shanks d1 h6
- for MQL 2-channel systems, to company standard
- incl. balancing thread 4xM6/6xM6
- even in excess lengths l1 = 120 mm (concentricity 4 µm) and 160 mm (concentricity 5 µm)
- cross-section A (mm²) ratio 4:1, see info page

Scope of delivery:

- MQL 2-channel axial adjusting screw (1) art. no. 4621
- MQL 2-channel transfer unit with pipe, art. no. 4623

suitable accessories separately available:

- replacement adjusting screw (1), art. no. 4621

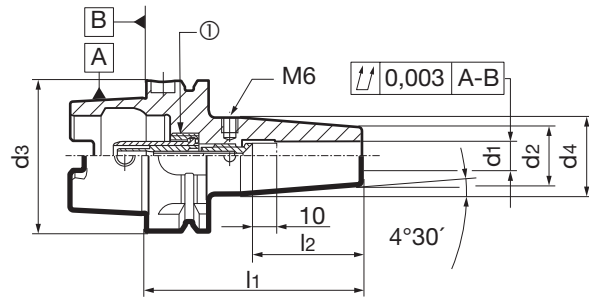

Article no.

4614

d3	d1 mm	A mm ²	d2 mm	d4 mm	l1 mm	l2 mm	①	Order no.
HSK-A 32	6	2.01	21	25.5	80	36	4621 6.032	4614 6.032
HSK-A 32	6	4.15	21	25.5	80	36	4621 6.132	4614 6.132
HSK-A 32	8	2.01	21	25.5	80	36	4621 8.032	4614 8.032
HSK-A 32	8	4.15	21	25.5	80	36	4621 8.132	4614 8.132
HSK-A 32	10	2.01	24	31.7	85	40	4621 10.032	4614 10.032
HSK-A 32	10	4.15	24	31.7	85	40	4621 10.132	4614 10.132
HSK-A 32	12	2.01	24	32.3	90	45	4621 12.032	4614 12.032
HSK-A 32	12	4.15	24	32.3	90	45	4621 12.132	4614 12.132
HSK-A 40	6	2.01	21	27.0	80	36	4621 6.040	4614 6.040
HSK-A 40	6	4.15	21	27.0	80	36	4621 6.140	4614 6.140
HSK-A 40	8	2.01	21	27.0	80	36	4621 8.040	4614 8.040
HSK-A 40	8	4.15	21	27.0	80	36	4621 8.140	4614 8.140
HSK-A 40	10	2.01	24	32.0	80	40	4621 10.040	4614 10.040
HSK-A 40	10	4.15	24	32.0	80	40	4621 10.140	4614 10.140
HSK-A 40	12	2.01	24	32.0	90	45	4621 12.040	4614 12.040
HSK-A 40	12	4.15	24	32.0	90	45	4621 12.140	4614 12.140
HSK-A 40	12	9.08	24	32.0	90	45	4621 12.240	4614 12.240
HSK-A 40	14	2.01	27	33.5	90	45	4621 14.040	4614 14.040
HSK-A 40	14	4.15	27	33.5	90	45	4621 14.140	4614 14.140
HSK-A 40	14	9.08	27	33.5	90	45	4621 14.240	4614 14.240
HSK-A 40	16	2.01	27	33.5	90	48	4621 16.040	4614 16.040
HSK-A 40	16	4.15	27	33.5	90	48	4621 16.140	4614 16.140
HSK-A 40	16	9.08	27	33.5	90	48	4621 16.240	4614 16.240
HSK-A 50	6	2.01	21	27.0	80	36	4621 6.050	4614 6.050
HSK-A 50	6	4.15	21	27.0	80	36	4621 6.150	4614 6.150
HSK-A 50	8	2.01	21	27.0	80	36	4621 8.050	4614 8.050
HSK-A 50	8	4.15	21	27.0	80	36	4621 8.150	4614 8.150
HSK-A 50	10	2.01	24	32.0	85	40	4621 10.050	4614 10.050
HSK-A 50	10	4.15	24	32.0	85	40	4621 10.150	4614 10.150
HSK-A 50	12	2.01	24	32.0	90	45	4621 12.050	4614 12.050
HSK-A 50	12	4.15	24	32.0	90	45	4621 12.150	4614 12.150
HSK-A 50	12	9.08	24	32.0	90	45	4621 12.250	4614 12.250
HSK-A 50	14	2.01	27	34.0	90	45	4621 14.050	4614 14.050
HSK-A 50	14	4.15	27	34.0	90	45	4621 14.150	4614 14.150
HSK-A 50	14	9.08	27	34.0	90	45	4621 14.250	4614 14.250
HSK-A 50	16	2.01	27	34.0	95	48	4621 16.050	4614 16.050
HSK-A 50	16	4.15	27	34.0	95	48	4621 16.150	4614 16.150
HSK-A 50	16	9.08	27	34.0	95	48	4621 16.250	4614 16.250
HSK-A 50	18	2.01	33	41.5	95	48	4621 18.050	4614 18.050
HSK-A 50	18	4.15	33	41.5	95	48	4621 18.150	4614 18.150
HSK-A 50	18	9.08	33	41.5	95	48	4621 18.250	4614 18.250
HSK-A 50	20	4.15	33	41.5	100	50	4621 20.050	4614 20.050
HSK-A 50	20	9.08	33	41.5	100	50	4621 20.150	4614 20.150
HSK-A 50	20	16.62	33	41.5	100	50	4621 20.250	4614 20.250
HSK-A 63	6	2.01	21	27.0	80	36	4621 6.100	4614 6.063
HSK-A 63	6	4.15	21	27.0	80	36	4621 6.101	4614 6.163
HSK-A 63	8	2.01	21	27.0	80	36	4621 8.100	4614 8.063
HSK-A 63	8	4.15	21	27.0	80	36	4621 8.101	4614 8.163

MQL technology



Article no.

4614

d3	d1 mm	A mm ²	d2 mm	d4 mm	l1 mm	l2 mm	①	Order no.
HSK-A 63	10	2.01	24	32.0	85	40	4621 10.100	4614 10.063
HSK-A 63	10	4.15	24	32.0	85	40	4621 10.101	4614 10.163
HSK-A 63	12	2.01	24	32.0	90	45	4621 12.100	4614 12.063
HSK-A 63	12	4.15	24	32.0	90	45	4621 12.101	4614 12.163
HSK-A 63	12	9.08	24	32.0	90	45	4621 12.102	4614 12.263
HSK-A 63	14	2.01	27	34.0	90	45	4621 14.100	4614 14.063
HSK-A 63	14	4.15	27	34.0	90	45	4621 14.101	4614 14.163
HSK-A 63	14	9.08	27	34.0	90	45	4621 14.102	4614 14.263
HSK-A 63	16	2.01	27	34.0	95	48	4621 16.100	4614 16.063
HSK-A 63	16	4.15	27	34.0	95	48	4621 16.101	4614 16.163
HSK-A 63	16	9.08	27	34.0	95	48	4621 16.102	4614 16.263
HSK-A 63	18	2.01	33	42.0	95	48	4621 18.100	4614 18.063
HSK-A 63	18	4.15	33	42.0	95	48	4621 18.101	4614 18.163
HSK-A 63	18	9.08	33	42.0	95	48	4621 18.102	4614 18.263
HSK-A 63	20	4.15	33	42.0	100	50	4621 20.100	4614 20.063
HSK-A 63	20	9.08	33	42.0	100	50	4621 20.101	4614 20.163
HSK-A 63	20	16.62	33	42.0	100	50	4621 20.102	4614 20.263
HSK-A 63	25	4.15	44	52.5	115	56	4621 25.100	4614 25.063
HSK-A 63	25	9.08	44	52.5	115	56	4621 25.101	4614 25.163
HSK-A 63	25	16.62	44	52.5	115	56	4621 25.102	4614 25.263
HSK-A 63	32	4.15	44	52.5	120	60	4621 32.100	4614 32.063
HSK-A 63	32	9.08	44	52.5	120	60	4621 32.101	4614 32.163
HSK-A 63	32	16.62	44	52.5	120	60	4621 32.102	4614 32.263
HSK-A 63	6	2.01	21	27.0	160	36	4621 6.032	4614 106.063
HSK-A 63	6	4.15	21	27.0	160	36	4621 6.132	4614 106.163
HSK-A 63	8	2.01	21	27.0	160	36	4621 8.040	4614 108.063
HSK-A 63	8	4.15	21	27.0	160	36	4621 8.140	4614 108.163
HSK-A 63	10	2.01	24	32.0	160	40	4621 10.050	4614 110.063
HSK-A 63	10	4.15	24	32.0	160	40	4621 10.150	4614 110.163
HSK-A 63	12	2.01	24	32.0	160	45	4621 12.100	4614 112.063
HSK-A 63	12	4.15	24	32.0	160	45	4621 12.101	4614 112.163
HSK-A 63	12	9.08	24	32.0	160	45	4621 12.102	4614 112.263
HSK-A 63	14	2.01	27	34.0	160	45	4621 14.100	4614 114.063
HSK-A 63	14	4.15	27	34.0	160	45	4621 14.101	4614 114.163
HSK-A 63	14	9.08	27	34.0	160	45	4621 14.102	4614 114.263
HSK-A 63	16	2.01	27	34.0	160	48	4621 16.100	4614 116.063
HSK-A 63	16	4.15	27	34.0	160	48	4621 16.101	4614 116.163
HSK-A 63	16	9.08	27	34.0	160	48	4621 16.102	4614 116.263
HSK-A 63	18	2.01	33	42.0	160	48	4621 18.100	4614 118.063
HSK-A 63	18	4.15	33	42.0	160	48	4621 18.101	4614 118.163
HSK-A 63	18	9.08	33	42.0	160	48	4621 18.102	4614 118.263
HSK-A 63	20	4.15	33	42.0	160	50	4621 20.100	4614 120.063
HSK-A 63	20	9.08	33	42.0	160	50	4621 20.101	4614 120.163
HSK-A 63	20	16.62	33	42.0	160	50	4621 20.102	4614 120.263
HSK-A 63	25	4.15	44	52.5	160	56	4621 25.100	4614 125.063
HSK-A 63	25	9.08	44	52.5	160	56	4621 25.101	4614 125.163
HSK-A 63	25	16.62	44	52.5	160	56	4621 25.102	4614 125.263
HSK-A 63	32	4.15	44	52.5	160	60	4621 32.100	4614 132.063
HSK-A 63	32	9.08	44	52.5	160	60	4621 32.101	4614 132.163
HSK-A 63	32	16.62	44	52.5	160	60	4621 32.102	4614 132.263
HSK-A 63	6	2.01	21	27.0	120	36	4621 6.032	4614 206.063
HSK-A 63	6	4.15	21	27.0	120	36	4621 6.132	4614 206.163
HSK-A 63	8	2.01	21	27.0	120	36	4621 8.040	4614 208.063
HSK-A 63	8	4.15	21	27.0	120	36	4621 8.140	4614 208.163
HSK-A 63	10	2.01	24	32.0	120	40	4621 10.050	4614 210.063
HSK-A 63	10	4.15	24	32.0	120	40	4621 10.150	4614 210.163
HSK-A 63	12	2.01	24	32.0	120	45	4621 12.100	4614 212.063
HSK-A 63	12	4.15	24	32.0	120	45	4621 12.101	4614 212.163
HSK-A 63	12	9.08	24	32.0	120	45	4621 12.102	4614 212.263
HSK-A 63	14	2.01	27	34.0	120	45	4621 14.100	4614 214.063
HSK-A 63	14	4.15	27	34.0	120	45	4621 14.101	4614 214.163
HSK-A 63	14	9.08	27	34.0	120	45	4621 14.102	4614 214.263
HSK-A 63	16	2.01	27	34.0	120	48	4621 16.100	4614 216.063
HSK-A 63	16	4.15	27	34.0	120	48	4621 16.101	4614 216.163
HSK-A 63	16	9.08	27	34.0	120	48	4621 16.102	4614 216.263
HSK-A 63	18	2.01	33	42.0	120	48	4621 18.100	4614 218.063
HSK-A 63	18	4.15	33	42.0	120	48	4621 18.101	4614 218.163
HSK-A 63	18	9.08	33	42.0	120	48	4621 18.102	4614 218.263
HSK-A 63	20	4.15	33	42.0	120	50	4621 20.100	4614 220.063
HSK-A 63	20	9.08	33	42.0	120	50	4621 20.101	4614 220.163
HSK-A 63	20	16.62	33	42.0	120	50	4621 20.102	4614 220.263
HSK-A 80	6	2.01	21	27.0	85	36	4621 6.100	4614 6.080
HSK-A 80	6	4.15	21	27.0	85	36	4621 6.101	4614 6.180
HSK-A 80	8	2.01	21	27.0	85	36	4621 8.100	4614 8.080
HSK-A 80	8	4.15	21	27.0	85	36	4621 8.101	4614 8.180
HSK-A 80	10	2.01	24	32.0	90	40	4621 10.100	4614 10.080
HSK-A 80	10	4.15	24	32.0	90	40	4621 10.101	4614 10.180
HSK-A 80	12	2.01	24	32.0	95	45	4621 12.100	4614 12.080
HSK-A 80	12	4.15	24	32.0	95	45	4621 12.101	4614 12.180
HSK-A 80	12	9.08	24	32.0	95	45	4621 12.102	4614 12.280
HSK-A 80	14	2.01	27	34.0	95	45	4621 14.100	4614 14.080
HSK-A 80	14	4.15	27	34.0	95	45	4621 14.101	4614 14.180
HSK-A 80	14	9.08	27	34.0	95	45	4621 14.102	4614 14.280
HSK-A 80	16	2.01	27	34.0	100	48	4621 16.100	4614 16.080

MQL technology



Article no.

4614

d3	d1 mm	A mm ²	d2 mm	d4 mm	l1 mm	l2 mm	①	Order no.
HSK-A 80	16	4.15	27	34.0	100	48	4621 16.101	4614 16.180
HSK-A 80	16	9.08	27	34.0	100	48	4621 16.102	4614 16.280
HSK-A 80	18	2.01	33	42.0	100	48	4621 18.100	4614 18.080
HSK-A 80	18	4.15	33	42.0	100	48	4621 18.101	4614 18.180
HSK-A 80	18	9.08	33	42.0	100	48	4621 18.102	4614 18.280
HSK-A 80	20	4.15	33	42.0	105	50	4621 20.100	4614 20.080
HSK-A 80	20	9.08	33	42.0	105	50	4621 20.101	4614 20.180
HSK-A 80	20	16.62	33	42.0	105	50	4621 20.102	4614 20.280
HSK-A 80	25	4.15	44	53.0	115	56	4621 25.100	4614 25.080
HSK-A 80	25	9.08	44	53.0	115	56	4621 25.101	4614 25.180
HSK-A 80	25	16.62	44	53.0	115	56	4621 25.102	4614 25.280
HSK-A 80	32	4.15	44	53.0	120	60	4621 32.100	4614 32.080
HSK-A 80	32	9.08	44	53.0	120	60	4621 32.101	4614 32.180
HSK-A 80	32	16.62	44	53.0	120	60	4621 32.102	4614 32.280
HSK-A 100	6	2.01	21	27.0	85	36	4621 6.100	4614 6.100
HSK-A 100	6	4.15	21	27.0	85	36	4621 6.101	4614 6.101
HSK-A 100	8	2.01	21	27.0	85	36	4621 8.100	4614 8.100
HSK-A 100	8	4.15	21	27.0	85	36	4621 8.101	4614 8.101
HSK-A 100	10	2.01	24	32.0	90	40	4621 10.100	4614 10.100
HSK-A 100	10	4.15	24	32.0	90	40	4621 10.101	4614 10.101
HSK-A 100	12	2.01	24	32.0	95	45	4621 12.100	4614 12.100
HSK-A 100	12	4.15	24	32.0	95	45	4621 12.101	4614 12.101
HSK-A 100	12	9.08	24	32.0	95	45	4621 12.102	4614 12.102
HSK-A 100	14	2.01	27	34.0	95	45	4621 14.100	4614 14.100
HSK-A 100	14	4.15	27	34.0	95	45	4621 14.101	4614 14.101
HSK-A 100	14	9.08	27	34.0	95	45	4621 14.102	4614 14.102
HSK-A 100	16	2.01	27	34.0	100	48	4621 16.100	4614 16.100
HSK-A 100	16	4.15	27	34.0	100	48	4621 16.101	4614 16.101
HSK-A 100	16	9.08	27	34.0	100	48	4621 16.102	4614 16.102
HSK-A 100	18	2.01	33	42.0	100	48	4621 18.100	4614 18.100
HSK-A 100	18	4.15	33	42.0	100	48	4621 18.101	4614 18.101
HSK-A 100	18	9.08	33	42.0	100	48	4621 18.102	4614 18.102
HSK-A 100	20	4.15	33	42.0	105	50	4621 20.100	4614 20.100
HSK-A 100	20	9.08	33	42.0	105	50	4621 20.101	4614 20.101
HSK-A 100	20	16.62	33	42.0	105	50	4621 20.102	4614 20.102
HSK-A 100	25	4.15	44	53.0	115	56	4621 25.100	4614 25.100
HSK-A 100	25	9.08	44	53.0	115	56	4621 25.101	4614 25.101
HSK-A 100	25	16.62	44	53.0	115	56	4621 25.102	4614 25.102
HSK-A 100	32	4.15	44	53.0	120	60	4621 32.100	4614 32.100
HSK-A 100	32	9.08	44	53.0	120	60	4621 32.101	4614 32.101
HSK-A 100	32	16.62	44	53.0	120	60	4621 32.102	4614 32.102
HSK-A 100	6	2.01	21	27.0	160	36	4621 6.032	4614 106.100
HSK-A 100	6	4.15	21	27.0	160	36	4621 6.132	4614 106.101
HSK-A 100	8	2.01	21	27.0	160	36	4621 8.040	4614 108.100
HSK-A 100	8	4.15	21	27.0	160	36	4621 8.140	4614 108.101
HSK-A 100	10	2.01	24	32.0	160	40	4621 10.050	4614 110.100
HSK-A 100	10	4.15	24	32.0	160	40	4621 10.150	4614 110.101
HSK-A 100	12	2.01	24	32.0	160	45	4621 12.100	4614 112.100
HSK-A 100	12	4.15	24	32.0	160	45	4621 114.101	4614 112.101
HSK-A 100	12	9.08	24	32.0	160	45	4621 114.102	4614 112.102
HSK-A 100	14	2.01	27	34.0	160	45	4621 14.100	4614 114.100
HSK-A 100	14	4.15	27	34.0	160	45	4621 14.101	4614 114.101
HSK-A 100	14	9.08	27	34.0	160	45	4621 14.102	4614 114.102
HSK-A 100	16	2.01	27	34.0	160	48	4621 16.100	4614 116.100
HSK-A 100	16	4.15	27	34.0	160	48	4621 16.101	4614 116.101
HSK-A 100	16	9.08	27	34.0	160	48	4621 16.102	4614 116.102
HSK-A 100	18	2.01	33	42.0	160	48	4621 18.100	4614 118.100
HSK-A 100	18	4.15	33	42.0	160	48	4621 18.101	4614 118.101
HSK-A 100	18	9.08	33	42.0	160	48	4621 18.102	4614 118.102
HSK-A 100	20	4.15	33	42.0	160	50	4621 20.100	4614 120.100
HSK-A 100	20	9.08	33	42.0	160	50	4621 20.101	4614 120.101
HSK-A 100	20	16.62	33	42.0	160	50	4621 20.102	4614 120.102
HSK-A 100	25	4.15	44	53.0	160	56	4621 25.100	4614 125.100
HSK-A 100	25	9.08	44	53.0	160	56	4621 25.101	4614 125.101
HSK-A 100	25	16.62	44	53.0	160	56	4621 25.102	4614 125.102
HSK-A 100	32	4.15	44	53.0	160	60	4621 32.100	4614 132.100
HSK-A 100	32	9.08	44	53.0	160	60	4621 32.101	4614 132.101
HSK-A 100	32	16.62	44	53.0	160	60	4621 32.102	4614 132.102

MQL technology



Product information:

- for the use of tool shanks according to MQL company standard
- for MQL 2-channel systems, to company standard
- black, anti-corrosion coating for visual identification of the 2-channel system
- cross-section A (mm²) ratio 4:1, see info page

suitable accessories separately available:

- clamping key art. no. 4912

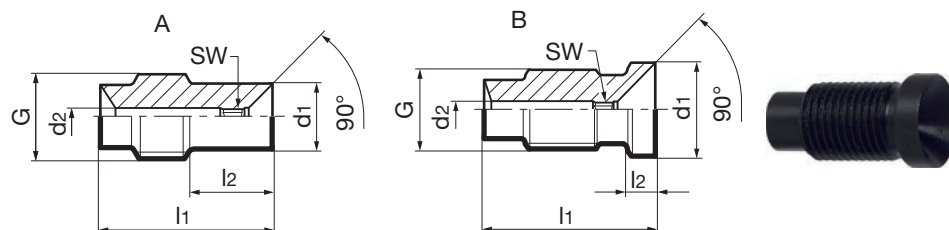

Article no.

4621

HSK-A	d1 mm	A mm ²	d2 mm	l1 mm	l2 mm	G	SW mm	Type	Order no.
32	6	2.01	2.0	25.8	2.5	M 5X0,8	1.5	A	4621 6.032
32	6	4.15	2.9	25.8	2.5	M 5X0,8	2.0	B	4621 6.132
32	8	2.01	2.0	21.0	3.0	M 7X1,0	1.5	A	4621 8.032
32	8	4.15	2.9	21.0	3.0	M 7X1,0	2.0	B	4621 8.132
32	10	2.01	2.0	22.0	3.5	M 8X1,0	1.5	A	4621 10.032
32	10	4.15	2.9	22.0	3.5	M 8X1,0	2.0	B	4621 10.132
32	12	2.01	2.0	22.0	3.5	M10X1,0	1.5	B	4621 12.032
32	12	4.15	2.9	22.0	3.5	M10X1,0	2.0	B	4621 12.132
40	6	2.01	2.0	26.6	11.0	M 7X1,0	1.5	A	4621 6.040
40	6	4.15	2.9	26.6	11.0	M 7X1,0	2.0	A	4621 6.140
40	8	2.01	2.0	26.5	3.0	M 7X1,0	1.5	B	4621 8.040
40	8	4.15	2.9	26.5	3.0	M 7X1,0	2.0	B	4621 8.140
40	10	2.01	2.0	22.2	3.5	M 8X1,0	1.5	B	4621 10.040
40	10	4.15	2.9	22.2	3.5	M 8X1,0	2.0	B	4621 10.140
40	12	2.01	2.0	26.5	3.5	M10X1,0	1.5	B	4621 12.040
40	12	4.15	2.9	26.5	3.5	M10X1,0	2.0	B	4621 12.140
40	12	9.08	4.1	26.5	3.5	M10X1,0	3.0	B	4621 12.240
40	14	2.01	2.0	26.5	4.5	M10X1,0	1.5	B	4621 14.040
40	14	4.15	2.9	26.5	4.5	M10X1,0	2.0	B	4621 14.140
40	14	9.08	4.1	26.5	4.5	M10X1,0	3.0	B	4621 14.240
40	16	2.01	2.0	23.5	5.5	M12X1,0	1.5	B	4621 16.040
40	16	4.15	2.9	23.5	5.5	M12X1,0	2.0	B	4621 16.140
40	16	9.08	4.1	23.5	5.5	M12X1,0	3.0	B	4621 16.240
50	6	2.01	2.0	22.0	10.0	M 8X1,0	1.5	A	4621 6.050
50	6	4.15	2.9	22.0	10.0	M 8X1,0	2.0	A	4621 6.150
50	8	2.01	2.0	22.0	3.0	M 8X1,0	1.5	B	4621 8.050
50	8	4.15	2.9	22.0	3.0	M 8X1,0	2.0	B	4621 8.150
50	10	2.01	2.0	23.0	3.5	M 8X1,0	1.5	B	4621 10.050
50	10	4.15	2.9	23.0	3.5	M 8X1,0	2.0	B	4621 10.150
50	12	2.01	2.0	23.7	3.5	M10X1,0	1.5	B	4621 12.050
50	12	4.15	2.9	23.7	3.5	M10X1,0	2.0	B	4621 12.150
50	12	9.08	4.1	23.7	3.5	M10X1,0	3.0	B	4621 12.250
50	14	2.01	2.0	23.7	4.5	M10X1,0	1.5	B	4621 14.050
50	14	4.15	2.9	23.7	4.5	M10X1,0	2.0	B	4621 14.150
50	14	9.08	4.1	23.7	4.5	M10X1,0	3.0	B	4621 14.250
50	16	2.01	2.0	25.7	5.5	M12X1,0	1.5	B	4621 16.050
50	16	4.15	2.9	25.7	5.5	M12X1,0	2.0	B	4621 16.150
50	16	9.08	4.1	25.7	5.5	M12X1,0	3.0	B	4621 16.250
50	18	2.01	2.0	25.7	6.5	M12X1,0	1.5	B	4621 18.050
50	18	4.15	2.9	25.7	6.5	M12X1,0	2.0	B	4621 18.150
50	18	9.08	4.1	25.7	6.5	M12X1,0	3.0	B	4621 18.250
50	20	4.15	2.9	27.5	6.5	M16X1,0	2.0	B	4621 20.050
50	20	9.08	4.1	27.5	6.5	M16X1,0	3.0	B	4621 20.150
50	20	16.62	5.4	27.5	6.5	M16X1,0	4.0	B	4621 20.250
63/80/100	6	2.01	2.0	21.3	10.0	M10X1,0	1.5	A	4621 6.100
63/80/100	6	4.15	2.9	20.5	10.0	M10X1,0	2.0	A	4621 6.101
63/80/100	8	2.01	2.0	21.3	10.0	M10X1,0	1.5	A	4621 8.100
63/80/100	8	4.15	2.9	21.3	10.0	M10X1,0	2.0	A	4621 8.101

MQL technology



Article no.

4621

HSK-A	d1 mm	A mm ²	d2 mm	l1 mm	l2 mm	G	SW mm	Type	Order no.
63/80/100	10	2.01	2.0	21.2	3.5	M10X1,0	1.5	B	4621 10.100
63/80/100	10	4.15	2.9	21.2	3.5	M10X1,0	2.0	B	4621 10.101
63/80/100	12	2.01	2.0	21.7	3.5	M10X1,0	1.5	B	4621 12.100
63/80/100	12	4.15	2.9	21.7	3.5	M10X1,0	2.0	B	4621 12.101
63/80/100	12	9.08	4.1	21.7	3.5	M10X1,0	3.0	B	4621 12.102
63/80/100	14	2.01	2.0	21.8	4.5	M10X1,0	1.5	B	4621 14.100
63/80/100	14	4.15	2.9	21.8	4.5	M10X1,0	2.0	B	4621 14.101
63/80/100	14	9.08	4.1	21.8	4.5	M10X1,0	3.0	B	4621 14.102
63/80/100	16	2.01	2.0	23.7	5.5	M12X1,0	1.5	B	4621 16.100
63/80/100	16	4.15	2.9	23.7	5.5	M12X1,0	2.0	B	4621 16.101
63/80/100	16	9.08	4.1	23.7	5.5	M12X1,0	3.0	B	4621 16.102
63/80/100	18	2.01	2.0	23.8	6.5	M12X1,0	1.5	B	4621 18.100
63/80/100	18	4.15	2.9	23.8	6.5	M12X1,0	2.0	B	4621 18.101
63/80/100	18	9.08	4.1	23.8	6.5	M12X1,0	3.0	B	4621 18.102
63/80/100	20	4.15	2.9	26.7	6.5	M16X1,0	2.0	B	4621 20.100
63/80/100	20	9.08	4.1	26.7	6.5	M16X1,0	3.0	B	4621 20.101
63/80/100	20	16.62	5.4	26.7	6.5	M16X1,0	4.0	B	4621 20.102
63/80/100	25	4.15	2.9	30.6	10.0	M16X1,0	2.0	B	4621 25.100
63/80/100	25	9.08	4.1	30.6	10.0	M16X1,0	3.0	B	4621 25.101
63/80/100	25	16.62	5.4	30.6	10.0	M16X1,0	4.0	B	4621 25.102
63/80/100	32	4.15	2.9	31.6	14.0	M16X1,0	2.0	B	4621 32.100
63/80/100	32	9.08	4.1	31.6	14.0	M16X1,0	3.0	B	4621 32.101
63/80/100	32	16.62	5.4	31.6	14.0	M16X1,0	4.0	B	4621 32.102



Product information:

- for MQL tool holders with automatic tool change (hydraulic chucks and shrink fit chucks) to company standard
- for MQL 2-channel systems, sealing by bypass system
- cross-section A (mm²) ratio 4:1, see info page

suitable accessories separately available:

- socket wrenches for coolant supply sets art. no. 4911
- mounting adaptors for MQL coolant supply set HSK-A (filler) art. no. 4948

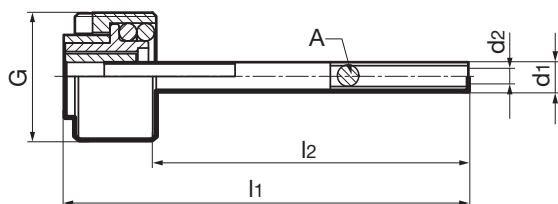

Article no.

4622

HSK-A	Ø-range	A mm ²	d1 mm	d2 mm	l1 mm	l2 mm	G	for chuck length	Order no.
32	6-12	2.01	1.9	1.6	26.5	20.0	M10 X1	80-115	4622 12.032
32	6-12	4.15	2.8	2.3	26.5	20.0	M10 X1	80-115	4622 12.132
40	6-16	2.01	1.9	1.6	22.8	14.5	M12 X1	80-115	4622 16.040
40	6-16	4.15	2.8	2.3	22.8	14.5	M12 X1	80-115	4622 16.140
40	12-16	9.07	4.0	3.4	22.6	14.3	M12 X1	80-115	4622 16.240
50	6-10	2.01	1.9	1.6	26.3	16.0	M16 x 1	80-115	4622 10.050
50	6-10	4.15	2.8	2.3	26.3	16.0	M16 x 1	80-115	4622 10.150
50	12-18	2.01	1.9	1.6	24.2	13.9	M16 x 1	80-115	4622 18.050
50	12-20	4.15	2.8	2.3	24.2	13.9	M16 x 1	80-115	4622 20.050
50	12-20	9.07	4.0	3.4	24.2	13.9	M16 x 1	80-115	4622 20.150
50	20	16.61	5.3	4.6	24.2	13.9	M16 x 1	80-115	4622 20.250
63	6-10	2.01	1.9	1.6	26.4	14.1	M18 x 1	80-115	4622 10.063
63	6-10	4.15	2.8	2.3	26.4	14.1	M18 x 1	80-115	4622 10.163
63	12-18	2.01	1.9	1.6	25.3	13.0	M18 x 1	80-115	4622 18.063
63	12-20	4.15	2.8	2.3	25.3	13.0	M18 x 1	80-115	4622 20.063
63	12-20	9.07	4.0	3.4	25.3	13.0	M18 x 1	80-115	4622 20.163
63	20	16.61	5.3	4.6	26.5	14.2	M18 x 1	80-115	4622 20.263
63	25-32	4.15	2.8	2.3	30.6	18.3	M18 x 1	80-115	4622 32.063
63	25-32	9.07	4.0	3.4	30.6	18.3	M18 x 1	80-115	4622 32.163
63	25-32	16.61	5.3	4.6	30.6	18.3	M20X1.5	80-115	4622 32.263
63	10	2.01	1.9	1.6	106.4	94.1	M18 x 1	160	4622 108.063
63	10	4.15	2.8	2.3	106.4	94.1	M18 x 1	160	4622 108.163
63	10	2.01	1.9	1.6	101.4	89.1	M18 x 1	160	4622 110.063
63	10	4.15	2.8	2.3	101.4	89.1	M18 x 1	160	4622 110.163
63	12-14	2.01	1.9	1.6	95.3	83.0	M18 x 1	160	4622 114.063
63	12-14	4.15	2.8	2.3	95.3	83.0	M18 x 1	160	4622 114.163
63	12-14	9.07	4.0	3.4	95.3	83.0	M18 x 1	160	4622 114.263
63	16-18	2.01	1.9	1.6	90.3	78.0	M18 x 1	160	4622 118.063
63	16-18	4.15	2.8	2.3	90.3	78.0	M18 x 1	160	4622 118.163
63	16-18	9.07	4.0	3.4	90.3	78.0	M18 x 1	160	4622 118.263
63	20	4.15	2.8	2.3	86.5	74.2	M18 x 1	160	4622 120.063
63	20	9.07	4.0	3.4	86.5	74.2	M18 x 1	160	4622 120.163
63	20	16.61	5.3	4.6	86.5	74.2	M18 x 1	160	4622 120.263
63	25	4.15	2.8	2.3	75.6	63.3	M18 x 1	160	4622 125.063
63	25	9.07	4.0	3.4	75.6	63.3	M18 x 1	160	4622 125.163
63	25	16.61	5.3	4.6	75.6	63.3	M18 x 1	160	4622 125.263
63	32	4.15	2.8	2.3	70.6	58.3	M18 x 1	160	4622 132.063
63	32	9.07	4.0	3.4	70.6	58.3	M18 x 1	160	4622 132.163
63	32	16.61	5.3	4.6	70.6	58.3	M18 x 1	160	4622 132.263
63	6- 8	2.01	1.9	1.6	66.4	54.1	M18 x 1	120	4622 208.063
63	6- 8	4.15	2.8	2.3	66.4	54.1	M18 x 1	120	4622 208.163
63	10	2.01	1.9	1.6	61.4	49.1	M18 x 1	120	4622 210.063
63	10	4.15	2.8	2.3	61.4	49.1	M18 x 1	120	4622 210.163
63	12-14	2.01	1.9	1.6	55.3	43.0	M18 x 1	120	4622 214.063
63	12-14	4.15	2.8	2.3	55.3	43.0	M18 x 1	120	4622 214.163
63	12-14	9.07	4.0	3.4	55.3	43.0	M18 x 1	120	4622 214.263
63	16-18	2.01	1.9	1.6	50.3	38.0	M18 x 1	120	4622 218.063
63	16-18	4.15	2.8	2.3	50.3	38.0	M18 x 1	120	4622 218.163

MQL technology



Article no.									4622
HSK-A	Ø-range	A mm ²	d1 mm	d2 mm	l1 mm	l2 mm	G	for chuck length	Order no.
63	16-18	9.07	4.0	3.4	50.3	38.0	M18 x 1	120	4622 218.263
63	20	4.15	2.8	2.3	46.5	34.2	M18 x 1	120	4622 220.063
63	20	9.07	4.0	3.4	46.5	34.2	M18 x 1	120	4622 220.163
63	20	16.61	5.3	4.6	46.5	34.2	M18 x 1	120	4622 220.263
80	6-10	2.01	1.9	1.6	29.0	14.6	M20X1.5	85-120	4622 10.080
80	6-10	4.15	2.8	2.3	29.0	14.6	M20X1.5	85-120	4622 10.180
80	12-18	2.01	1.9	1.6	27.9	13.5	M20X1.5	85-120	4622 18.080
80	12-32	4.15	2.8	2.3	27.9	13.5	M20X1.5	85-120	4622 32.080
80	12-32	9.07	4.0	3.4	27.9	13.5	M20X1.5	85-120	4622 32.180
80	20-32	16.61	5.3	4.6	28.4	14.0	M20X1.5	85-120	4622 32.280
100	6-10	2.01	1.9	1.6	29.0	12.6	M24X1.5	85-120	4622 10.100
100	6-10	4.15	2.8	2.3	29.0	12.6	M24X1.5	85-120	4622 10.101
100	12-18	2.01	1.9	1.6	27.9	11.5	M24X1.5	85-120	4622 18.100
100	12-32	4.15	2.8	2.3	27.9	11.5	M24X1.5	85-120	4622 32.100
100	12-32	9.07	4.0	3.4	27.9	11.5	M24X1.5	85-120	4622 32.101
100	20-32	16.61	5.3	4.6	28.4	12.0	M24X1.5	85-120	4622 32.102
100	10	2.01	1.9	1.6	104.0	87.6	M24X1.5	160	4622 108.100
100	10	4.15	2.8	2.3	104.0	87.6	M24X1.5	160	4622 108.101
100	10	2.01	1.9	1.6	99.0	82.6	M24X1.5	160	4622 110.100
100	10	4.15	2.8	2.3	99.0	82.6	M24X1.5	160	4622 110.101
100	12-14	2.01	1.9	1.6	92.9	76.5	M24X1.5	160	4622 114.100
100	12-14	4.15	2.8	2.3	92.9	76.5	M24X1.5	160	4622 114.101
100	12-14	9.07	4.0	3.4	92.9	76.5	M24X1.5	160	4622 114.102
100	16-18	2.01	1.9	1.6	87.9	71.5	M24X1.5	160	4622 118.100
100	16-18	4.15	2.8	2.3	87.9	71.5	M24X1.5	160	4622 118.101
100	16-18	9.07	4.0	3.4	87.9	71.5	M24X1.5	160	4622 118.102
100	20	4.15	2.8	2.3	83.4	67.0	M24X1.5	160	4622 120.100
100	20	9.07	4.0	3.4	83.4	67.0	M24X1.5	160	4622 120.101
100	20	16.61	5.3	4.6	83.4	67.0	M24X1.5	160	4622 120.102
100	25	4.15	2.8	2.3	73.4	57.0	M24X1.5	160	4622 125.100
100	25	9.07	4.0	3.4	73.4	57.0	M24X1.5	160	4622 125.101
100	25	16.61	5.3	4.6	73.4	57.0	M24X1.5	160	4622 125.102
100	32	4.15	2.8	2.3	68.4	52.0	M24X1.5	160	4622 132.100
100	32	9.07	4.0	3.4	68.4	52.0	M24X1.5	160	4622 132.101
100	32	16.61	5.3	4.6	68.4	52.0	M24X1.5	160	4622 132.102



Product information:

- for MQL tool holders with automatic tool change (hydraulic chucks and shrink fit chucks) to company standard
- for MQL 2-channel systems
- “crashsafe” design in line with DIN 69090–2, transfer element
- missing dimensions according to DIN 69895
- sealing by bypass system
- cross-section A (mm²) ratio 4:1, see info page

suitable accessories separately available:

- socket wrenches for coolant supply sets art. no. 4911

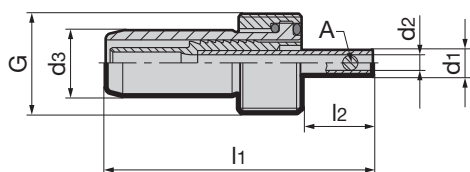

Article no.

4623

HSK-A	Ø-range	A mm ²	d1 mm	d2 mm	d3 mm	l1 mm	l2 mm	G	for chuck length	Order no.
32	6-12	2.01	1.9	1.6	6.0	47.0	20.0	M10X1,0	80-115	4623 12.032
32	6-12	4.15	2.8	2.3	6.0	47.0	20.0	M10X1,0	80-115	4623 12.132
40	12-16	2.01	1.9	1.6	8.0	43.3	14.5	M12X1,0	80-115	4623 16.040
40	12-16	4.15	2.8	2.3	8.0	43.3	14.5	M12X1,0	80-115	4623 16.140
40	12-16	9.07	4.0	3.4	8.0	43.1	14.3	M12X1,0	80-115	4623 16.240
50	6-10	2.01	1.9	1.6	10.0	48.6	16.0	M16X1,0	80-115	4623 10.050
50	6-10	4.15	2.8	2.3	10.0	48.6	16.0	M16X1,0	80-115	4623 10.150
50	12-18	2.01	1.9	1.6	10.0	46.5	13.9	M16X1,0	80-115	4623 18.050
50	20	4.15	2.8	2.3	10.0	46.5	13.9	M16X1,0	80-115	4623 20.050
50	20	9.07	4.0	3.4	10.0	46.5	13.9	M16X1,0	80-115	4623 20.150
50	20	16.61	5.3	4.6	10.0	46.5	13.9	M16X1,0	80-115	4623 20.250
63	6-10	2.01	1.9	1.6	12.0	50.0	14.1	M18X1,0	80-115	4623 10.063
63	6-10	4.15	2.8	2.3	12.0	50.0	14.1	M18X1,0	80-115	4623 10.163
63	12-18	2.01	1.9	1.6	12.0	48.8	13.0	M18 X 1	80-115	4623 18.063
63	20	4.15	2.8	2.3	12.0	48.8	13.0	M18 X 1	80-115	4623 20.063
63	20	9.07	4.0	3.4	12.0	48.8	13.0	M18X1,0	80-115	4623 20.163
63	20	16.61	5.3	4.6	12.0	50.0	14.2	M18X1,0	80-115	4623 20.263
63	20	4.15	2.8	2.3	12.0	54.1	18.3	M18X1,0	80-115	4623 32.063
63	25-32	9.07	4.0	3.4	12.0	54.1	18.3	M18X1,0	80-115	4623 32.163
63	25-32	16.61	5.3	4.6	12.0	54.1	18.3	M18X1,0	80-115	4623 32.263
63	6- 8	2.01	1.9	1.6	12.0	130.0	94.1	M18X1,0	160	4623 108.063
63	6- 8	4.15	2.8	2.3	12.0	130.0	94.1	M18X1,0	160	4623 108.163
63	10	2.01	1.9	1.6	12.0	124.9	89.1	M18X1,0	160	4623 110.063
63	10	4.15	2.8	2.3	12.0	124.9	89.1	M18X1,0	160	4623 110.163
63	12-14	2.01	1.9	1.6	12.0	118.8	83.0	M18X1,0	160	4623 114.063
63	12-14	4.15	2.8	2.3	12.0	118.8	83.0	M18X1,0	160	4623 114.163
63	12-14	9.07	4.0	3.4	12.0	118.8	83.0	M18X1,0	160	4623 114.263
63	16-18	2.01	1.9	1.6	12.0	113.8	78.0	M18X1,0	160	4623 118.063
63	16-18	4.15	2.8	2.3	12.0	113.8	78.0	M18X1,0	160	4623 118.163
63	16-18	9.07	4.0	3.4	12.0	113.8	78.0	M18X1,0	160	4623 118.263
63	20	4.15	2.8	2.3	12.0	110.0	74.2	M18X1,0	160	4623 120.063
63	20	9.07	4.0	3.4	12.0	110.0	74.2	M18X1,0	160	4623 120.163
63	20	16.61	5.3	4.6	12.0	110.0	74.2	M18X1,0	160	4623 120.263
63	25	4.15	2.8	2.3	12.0	99.1	63.3	M18X1,0	160	4623 125.063
63	25	9.07	4.0	3.4	12.0	99.1	63.3	M18X1,0	160	4623 125.163
63	25	16.61	5.3	4.6	12.0	99.1	63.3	M18X1,0	160	4623 125.263
63	32	4.15	2.8	2.3	12.0	94.1	58.3	M18X1,0	160	4623 132.063
63	32	9.07	4.0	3.4	12.0	94.1	58.3	M18X1,0	160	4623 132.163
63	32	16.61	5.3	4.6	12.0	94.1	58.3	M18X1,0	160	4623 132.263
63	6- 8	2.01	1.9	1.6	12.0	90.0	54.1	M18X1,0	120	4623 208.063
63	6- 8	4.15	2.8	2.3	12.0	90.0	54.1	M18X1,0	120	4623 208.163
63	10	2.01	1.9	1.6	12.0	85.0	49.1	M18X1,0	120	4623 210.063
63	10	4.15	2.8	2.3	12.0	85.0	49.1	M18X1,0	120	4623 210.163
63	12-14	2.01	1.9	1.6	12.0	78.8	43.0	M18X1,0	120	4623 214.063
63	12-14	4.15	2.8	2.3	12.0	78.8	43.0	M18X1,0	120	4623 214.163
63	12-14	9.07	4.0	3.4	12.0	78.8	43.0	M18X1,0	120	4623 214.263
63	16-18	2.01	1.9	1.6	12.0	73.8	38.0	M18X1,0	120	4623 218.063
63	16-18	4.15	2.8	2.3	12.0	73.8	38.0	M18X1,0	120	4623 218.163

MQL technology



Article no.										4623
HSK-A	Ø-range	A mm ²	d1 mm	d2 mm	d3 mm	l1 mm	l2 mm	G	for chuck length	Order no.
63	16-18	9.07	4.0	3.4	12.0	73.8	38.0	M18X1,0	120	4623 218.263
63	20	4.15	2.8	2.3	12.0	70.0	34.2	M18X1,0	120	4623 220.063
63	20	9.07	4.0	3.4	12.0	70.0	34.2	M18X1,0	120	4623 220.163
63	20	16.61	5.3	4.6	12.0	70.0	34.2	M18X1,0	120	4623 220.263
80	6-10	2.01	1.9	1.6	14.0	54.2	14.6	M20X1.5	85-120	4623 10.080
80	6-10	4.15	2.8	2.3	14.0	54.2	14.6	M20X1.5	85-120	4623 10.180
80	12-18	2.01	1.9	1.6	14.0	53.1	13.5	M20X1.5	85-120	4623 18.080
80	12-32	4.15	2.8	2.3	14.0	53.1	13.5	M20X1.5	85-120	4623 32.080
80	12-32	9.07	4.0	3.4	14.0	53.1	13.5	M20X1.5	85-120	4623 32.180
80	20-32	16.61	5.3	4.6	14.0	53.6	14.0	M20X1.5	85-120	4623 32.280
100	6-10	2.01	1.9	1.6	16.0	56.2	12.6	M24X1.5	85-120	4623 10.100
100	6-10	4.15	2.8	2.3	16.0	56.2	12.6	M24X1.5	85-120	4623 10.101
100	12-18	2.01	1.9	1.6	16.0	55.1	11.5	M24X1.5	85-120	4623 18.100
100	12-32	4.15	2.8	2.3	16.0	55.1	11.5	M24X1.5	85-120	4623 32.100
100	12-32	9.07	4.0	3.4	16.0	55.1	11.5	M24X1.5	85-120	4623 32.101
100	20-32	16.61	5.3	4.6	16.0	55.6	12.0	M24X1.5	85-120	4623 32.102
100	6- 8	2.01	1.9	1.6	16.0	131.2	87.6	M24X1.5	160	4623 108.100
100	6- 8	4.15	2.8	2.3	16.0	131.2	87.6	M24X1.5	160	4623 108.101
100	10	2.01	1.9	1.6	16.0	126.2	82.6	M24X1.5	160	4623 110.100
100	10	4.15	2.8	2.3	16.0	126.2	82.6	M24X1.5	160	4623 110.101
100	12-14	2.01	1.9	1.6	16.0	120.1	76.5	M24X1.5	160	4623 114.100
100	12-14	4.15	2.8	2.3	16.0	120.1	76.5	M24X1.5	160	4623 114.101
100	12-14	9.07	4.0	3.4	16.0	120.1	76.5	M24X1.5	160	4623 114.102
100	16-18	2.01	1.9	1.6	16.0	115.1	71.5	M24X1.5	160	4623 118.100
100	16-18	4.15	2.8	2.3	16.0	115.1	71.5	M24X1.5	160	4623 118.101
100	16-18	9.07	4.0	3.4	16.0	115.1	71.5	M24X1.5	160	4623 118.102
100	20	4.15	2.8	2.3	16.0	110.6	67.0	M24X1.5	160	4623 120.100
100	20	9.07	4.0	3.4	16.0	110.6	67.0	M24X1.5	160	4623 120.101
100	20	16.61	5.3	4.6	16.0	110.6	67.0	M24X1.5	160	4623 120.102
100	25	4.15	2.8	2.3	16.0	100.6	57.0	M24X1.5	160	4623 125.100
100	25	9.07	4.0	3.4	16.0	100.6	57.0	M24X1.5	160	4623 125.101
100	25	16.61	5.3	4.6	16.0	100.6	57.0	M24X1.5	160	4623 125.102
100	32	4.15	2.8	2.3	16.0	95.6	52.0	M24X1.5	160	4623 132.100
100	32	9.07	4.0	3.4	16.0	95.6	52.0	M24X1.5	160	4623 132.101
100	32	16.61	5.3	4.6	16.0	95.6	52.0	M24X1.5	160	4623 132.102



MQL hydraulic synchro tapping chucks HSK-A (manual tool change)

Article no. **4604**



Product information:

- HSK-A according to ISO 12164-1 / DIN 69893-1
- balancing quality: G 6.3 / 15,000 rpm
- convenient hydraulic clamping using reduction bushes with active drive
- for MQL 1 & 2-channel systems, Gühring MQL identifiable by green colour ring
- MQL pressure max. 16 bar
- compensates synchronisation errors
- minimum length compensation ± 0.3 mm in pushing and pulling direction
- adjusting screw enables 3 mm axial length readjustment
- guarantees the best thread quality with optimum tool life

Scope of delivery:

- MQL filler art. no. 4513
- adjustment wrench for adjusting screw

suitable accessories separately available:

- MQL axial adjusting screw, art. no. 4305
- reduction bushes art. no. 4605 or 4606
- hexagonal key (2), art. no. 4912
- replacement clamping screw (2) art. no. 4241
- adjustment key, art. no. 4912, type B for adjusting screws

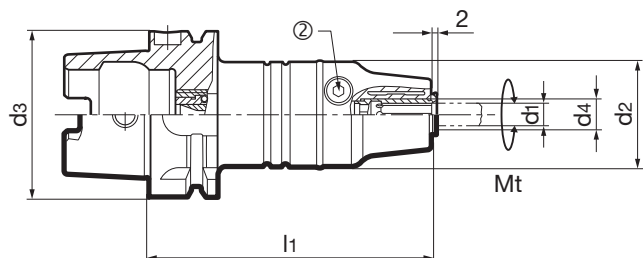

Article no. **4604**

d3	d1	d2 mm	for threads	d4 mm	l1 mm	Mt max. Nm	SW mm	②	②
HSK-A 63	2.8-10.0	40	M2-M12	12	106.5	26	4.0	4912 4.600	4241 8.000
HSK-A 63	6.0-16.0	40	M4,5-M20	20	120.5	90	5.0	4912 5.000	4241 10.003
HSK-A 100	2.8-10.0	40	M2-M12	12	113.0	26	4.0	4912 4.600	4241 8.000
HSK-A 100	6.0-16.0	40	M4,5-M20	20	127.0	90	5.0	4912 5.000	4241 10.003

Order no.
4604 12.063
4604 20.063
4604 12.100
4604 20.100

MQL 2-channel hydraulic synchro tapping chucks HSK-A (automatic tool change)

Article no. **4603**



Product information:

- HSK-A according to ISO 12164-1 / DIN 69893-1
- balancing quality: G 6.3 / 15,000 rpm
- convenient hydraulic clamping using reduction bushes with active drive
- for MQL 2-channel systems, Gühring MQL identifiable by green colour ring
- MQL pressure max. 16 bar
- compensates synchronisation errors
- minimum length compensation ± 0.3 mm in pushing and pulling direction
- reduces an increase in axial forces during the cutting cycle to a minimum
- adjusting screw enables 3 mm axial length readjustment

Scope of delivery:

- MQL 2-channel transfer unit, art. no. 4511
- adjustment wrench for adjusting screw

suitable accessories separately available:

- MQL axial adjusting screw, art. no. 4305
- reduction bushes art. no. 4605 or 4606
- hexagonal key (2), art. no. 4912
- replacement clamping screw (2) art. no. 4241

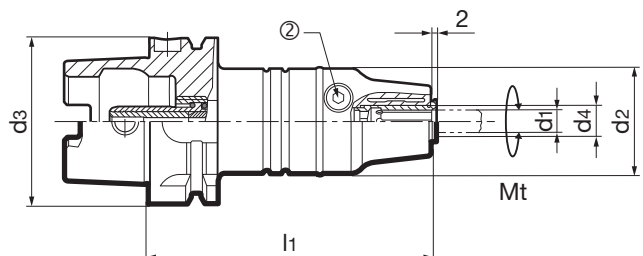

Article no. **4603**

d3	d1	d2 mm	for threads	d4 mm	l1 mm	Mt max. Nm	SW mm	②	②
HSK-A 63	2,8-10	40	M2-M12	12	106.5	26	4.0	4912 4.600	4241 8.000
HSK-A 63	6-16	40	M4,5-M20	20	120.5	90	5.0	4912 5.000	4241 10.003
HSK-A 100	2,8-10	40	M2-M12	12	113.0	26	4.0	4912 4.600	4241 8.000
HSK-A 100	6-16	40	M4,5-M20	20	127.0	90	5.0	4912 5.000	4241 10.003

Order no.
4603 12.063
4603 20.063
4603 12.100
4603 20.100



MQL hydraulic synchro tapping chucks with straight shank

Article no. **4524**



Product information:

- mounting shank according to DIN 1835-A for mounting in precision chucks (hydraulic expansion or power chucks, shrink fit chucks for one-time use)
- für MQL 1 & 2-channel systems, according to company standard
- MQL pressure max. 16 bar
- guarantees the best thread quality with optimum tool life
- minimum length compensation ± 0.3 mm in pushing and pulling direction
- convenient hydraulic clamping using reduction bushes with active drive
- adjusting screw enables 3 mm axial length readjustment

Scope of delivery:

- incl. adjustment key for adjusting screws

suitable accessories separately available:

- MQL axial adjusting screw, art. no. 4305
- reduction bushes art. no. 4605 or 4606
- replacement clamping screw (2) art. no. 4241

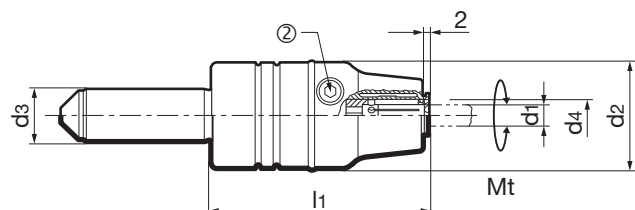

Article no. **4524**

d3 h6 mm	d1	d4 mm	for	d2 mm	l1 mm	Mt max. Nm	SW mm	②	②
20	2.8-10.0	12.0	M2-M12	40	80.0	26	4.0	4912 4.600	4241 8.000
20	6.0-16.0	20.0	M4,5-M20	40	94.0	90	5.0	4912 5.000	4241 10.003

Order no.

4524 12.020
4524 20.020

MQL synchro tapping chucks HSK-A (manual tool change)

Article no. **4298**



Product information:

- HSK-A according to ISO 12164-1 / DIN 69893-1
- for MQL 1 & 2-channel systems
- compensates synchronisation errors
- minimum length compensation ± 0.5 mm in pushing and pulling direction
- reduces high thread flank friction forces and increases thread quality and tool life
- adjusting screw enables 2-3 mm readjustment
- MQL pressure max. 16 bar

Scope of delivery:

- MQL coolant supply set
- incl. adjusting screw
- IC/ER clamping nut with sealing washer, art. no. 4306 (*see tightening torque)
- adjustment wrench for MQL axial adjusting screw

suitable accessories separately available:

- MQL axial adjusting screw, art. no. 4305
- sealing plug art. no. 4335
- thread tap collet chuck, art. no. 4308
- clamping key art. no. 4913 for clamping nut ER
- MQL filler art. no. 4513

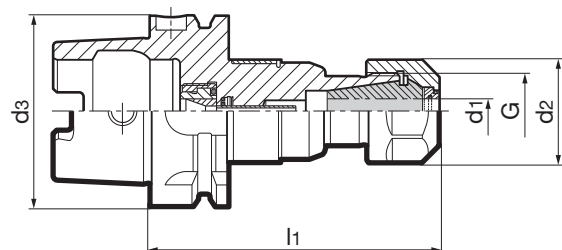

Article no. **4298**

d3	Size	G	d1 mm	d2 mm	l1 mm	Mt max. Nm
HSK-A 63	ER20	M25 X1.5	4.5-11.0	34.0	95.5	35
HSK-A 63	ER32	M40 X1.5	4.5-20.0	50.0	109.0	136

Order no.

4298 20.063
4298 32.063



Product information:

- HSK-A according to ISO 12164-1 / DIN 69893-1
- compensates synchronisation errors
- minimum length compensation ± 0.5 mm in pushing and pulling direction
- adjusting screw enables 2-3 mm readjustment
- for MQL 2-channel systems
- MQL pressure max. 16 bar
- mounted MQL coolant transfer set

Scope of delivery:

- MQL 2-channel transfer unit, art. no. 4511
- IC/ER clamping nut with sealing washer, art. no. 4306 (*see tightening torque)
- adjustment wrench for MQL axial adjusting screw

suitable accessories separately available:

- MQL axial adjusting screw, art. no. 4305
- sealing plug art. no. 4335
- thread tap collet chuck, art. no. 4308
- clamping key art. no. 4913
- MQL 2-channel coolant supply set, art. no. 4511
- replacement IC/ER clamping nut, art. no. 4306

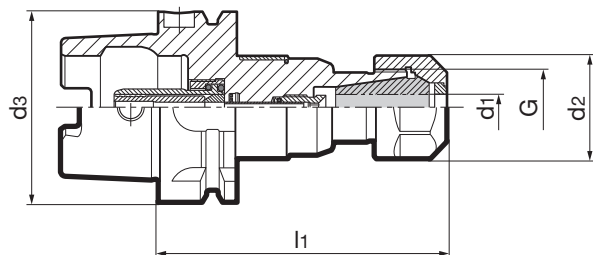

Article no.

4341

d3	Size	G	d1 mm	d2 mm	l1 mm	Mt max. Nm	Order no.
HSK-A 63	ER20	M25 X1.5	4.5-11.0	34.0	95.5	35	4341 20.063
HSK-A 63	ER32	M40 X1.5	4.5-20.0	50.0	109.0	136	4341 32.063
HSK-A 100	ER20	M25 X1.5	4.5-11.0	34.0	102.0	35	4341 20.100
HSK-A 100	ER32	M40 X1.5	4.5-20.0	50.0	115.5	136	4341 32.100



MQL adjusting screws with internal cone for MQL synchro tapping chucks

Article no. **4305**

Product information:

- MQL axial adjusting screw with inner cone
- for MQL 1 & 2-channel systems
- for MQL threading tools with external cone
- for MQL hydro synchro tapping chucks, art. no. 4602, 4603, 4604 and 4524
- for MQL synchro tapping chucks art. no. 4298, 4330 and 4341
- with adjusting screw inserted in thread tap shank, 3 mm length adjustment by hex key, art. no. 4912, type “B”

Scope of delivery:

- incl. O ring for sealing

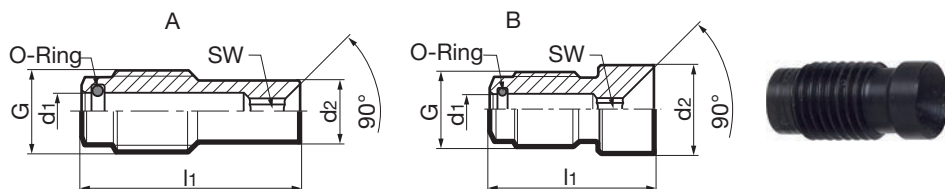

Article no. **4305**

Size	G	for shank Ø x ■ mm	d1 mm	d2 mm	l1 mm	SW mm	Type	Code no.	Order no.
ER20	M8 x 1	6x4,9	3.6	4.8	24.1	2.5	A	6.020	4305 6.020
ER20	M8 x 1	7x5,5	3.6	5.4	24.3	2.5	A	7.020	4305 7.020
ER20	M8 x 1	8x6,2	3.6	6.1	19.3	2.5	A	8.020	4305 8.020
ER20	M8 x 1	9x7	3.6	6.9	18.2	2.5	A	9.020	4305 9.020
ER20	M8 x 1	10x8	3.6	7.8	14.6	2.5	B	10.020	4305 10.020
ER20	M8 x 1	11x9	3.6	8.8	16.0	2.5	B	11.020	4305 11.020
ER32	M10X1	6x4,9	4.1	4.8	34.5	3.0	A	6.032	4305 6.032
ER32	M10X1	7x5,5	4.1	5.4	34.5	3.0	A	7.032	4305 7.032
ER32	M10X1	8x6,2	4.1	6.1	29.5	3.0	A	8.032	4305 8.032
ER32	M10X1	9x7	4.1	6.9	29.0	3.0	A	9.032	4305 9.032
ER32	M10X1	10x8	4.1	7.8	25.0	3.0	A	10.032	4305 10.032
ER32	M10X1	11x9 & 12x9	4.1	8.8	24.0	3.0	A	11.032	4305 11.032
ER32	M10X1	14x11	4.1	10.8	22.5	3.0	B	14.032	4305 14.032
ER32	M10X1	16x12	4.1	11.8	22.0	3.0	B	16.032	4305 16.032
ER32	M10X1	18x14,5 & 10x16	4.1	14.3	20.5	3.0	B	18.032	4305 18.032



MQL 2-channel coolant supply set HSK-A

Article no. **4511**

Product information:

- design similar to DIN 69895
- for MQL tapping chucks and monolithic holders
- for MQL 2-channel systems, to company standard
- for tool holders with automatic tool change
- “crashsafe” design in line with DIN 69090–2, transfer element
- dimensions d2 and l1 in installed condition

suitable accessories separately available:

- socket wrenches art. no. 4910
- socket wrenches for coolant supply sets art. no. 4911

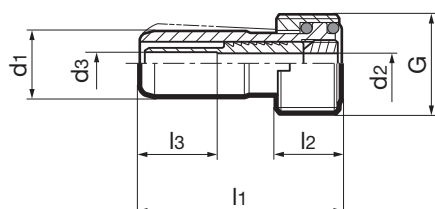

Article no. **4511**

for	d1 mm	d2 mm	d3 mm	l1 mm	l2 mm	l3 mm	G	Order no.
HSK-A 32	6.0	3.0	4.0	26.0	5.5		M10X1	4511 10.032
HSK-A 40	8.0	3.8	5.4	29.5	7.5		M12X1	4511 12.040
HSK-A 50	10.0	3.6	4.0	33.0	9.5	21.0	M16X1	4511 16.050
HSK-A 63	12.0	3.6	4.0	36.5	11.5	13.8	M18X1	4511 18.063
HSK-A 80	14.0	3.6	4.0	40.0	13.5	14.0	M20X1.5	4511 20.080
HSK-A 100	16.0	3.6	4.0	44.0	15.5	14.0	M24X1.5	4511 24.100

MQL coolant supply set HSK-A (filler)

Article no. **4513**



Product information:

- for IC, for MQL 1 & 2-channel system, according to company standard
- for MQL tapping chucks and monolithic holders
- for tool holders with manual tool change
- radially alignable
- dimensions d2 and l1 in installed condition
- optimum seal for MQL clamping set

suitable accessories separately available:

- socket wrenches art. no. 4910
- socket wrenches for coolant supply sets art. no. 4911

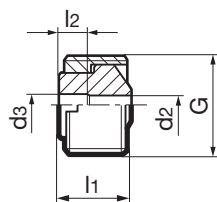

Article no. **4513**

for	d2 mm	d3 mm	l1 mm	l2 mm	G	Order no.
HSK-A 32	3.0	3.0	6.3		M10X1	4513 10.032
HSK-A 40	3.6	4.0	8.3	5.0	M12X1	4513 12.040
HSK-A 50	3.6	4.0	10.3	5.0	M16X1	4513 16.050
HSK-A 50	5.0	5.0	10.3		M16X1	4513 16.150
HSK-A 63	3.6	4.0	12.3	5.0	M18X1	4513 18.063
HSK-A 63	6.0	6.0	12.3		M18X1	4513 18.163
HSK-A 80	3.6	4.0	14.4	5.0	M20X1.5	4513 20.080
HSK-A 80	8.0	8.0	14.4		M20X1.5	4513 20.180
HSK-A 100	3.6	4.0	16.4	5.0	M24X1.5	4513 24.100
HSK-A 100	8.0	8.0	16.4		M24X1.5	4513 24.101



HSK-A precision collet holders

Article no. **4476**



Product information:

- HSK-A according to ISO 12164-1 / DIN 69893-1
- balancing quality: G 2.5 / 25,000 rpm or rev. < 1 gmm
- for ER11 high-precision collet holders (similar to ISO 15488), art. no. 4574 and 4575
- concentricity overall system < 3 µm (at 3 x clamping-Ø max. 50 mm)
- observe maximum tightening torque values of clamping nut
clamping Ø 1.0 - 2.5 = 7 Nm
clamping Ø 3.0 - 7.5 = 10 Nm
- without adjusting screw

Scope of delivery:

- incl. clamping nut art. no. 4573

suitable accessories separately available:

- collet chucks art. no. 4574 or 4575 (sealed)
- roller keys art. no. 4994
- roller spanner insert, art. no. 4995 for optimum operation
- torque wrench art. no. 4981 5,025 and coolant transfer unit, art. no. 4949

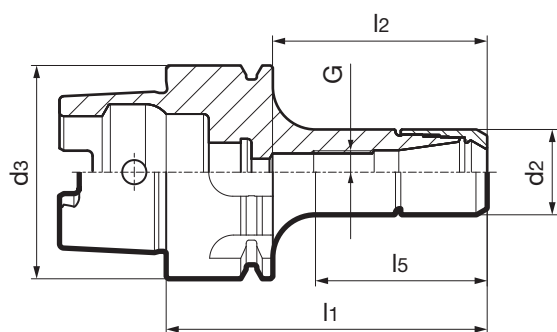

Article no.

4476

d3	Size	Ø-range	d2 mm	l1 mm	l2 mm	l5 mm	1/min	G	Order no.
HSK-A 32	ER11	1.0-7.0	16	40	24	20	50000		4476 11.032
HSK-A 40	ER11	1.0-7.0	16	60	40	40	42000	M 8 X1	4476 11.040
HSK-A 40	ER11	1.0-7.0	16	130	75	110	27000	M 8 X1	4476 11.140
HSK-A 50	ER11	1.0-7.0	16	130	60	104	27000	M 8 X1	4476 11.050
HSK-A 63	ER11	1.0-7.0	16	70	48	34	25000	M 8 X1	4476 11.063
HSK-A 63	ER11	1.0-7.0	16	100	78	64	25000	M 8 X1	4476 11.163
HSK-A 63	ER11	1.0-7.0	16	130	108	94	25000	M 8 X1	4476 11.263
HSK-A 63	ER11	1.0-7.0	16	160	138	124	25000	M 8 X1	4476 11.363



HSK-E precision collet holders

Article no. **4475**



Product information:

- HSK-E according to DIN 69893-5, without access hole in taper
- balancing quality: G 2.5 / 25,000 rpm or rev. < 1 gmm
- for ER11 high-precision collet holders (similar to ISO 15488), art. no. 4574 and 4575
- concentricity overall system < 3 µm (at 3 x clamping-Ø max. 50 mm)
- observe maximum tightening torque values of clamping nut
clamping Ø 1.0 - 2.5 = 7 Nm
clamping Ø 3.0 - 7.5 = 10 Nm
- without adjusting screw

Scope of delivery:

- incl. clamping nut art. no. 4573

suitable accessories separately available:

- collet chucks art. no. 4574 or 4575 (sealed)
- roller keys art. no. 4994
- roller spanner insert, art. no. 4995 for optimum operation
- torque wrenches art.no. 4981 5.025
- coolant supply set art. no. 4949

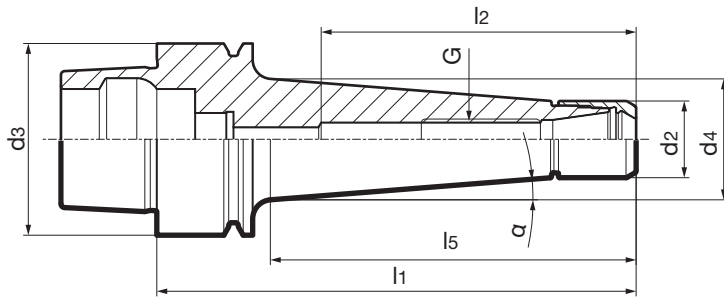

Article no.

4475

d3	Size	Ø-range	d2 mm	d4 mm	l1 mm	l2 mm	l5 mm	α °	1/min	G	Order no.
HSK-E 25	ER11	1,0-7,5	16	20.0	35	22	22.0		60000		4475 11.025
HSK-E 32	ER11	1,0-7,5	16	17.5	50	34	27.5	4.5	50000	M 8 X1	4475 11.032
HSK-E 40	ER11	1,0-7,5	16	17.0	50	31	22.5	4.5	42000	M 8 X1	4475 11.040
HSK-E 40	ER11	1,0-7,5	16	25.5	100	65	75.5	4.5	40000	M 8 X1	4475 11.140
HSK-E 40	ER11	1,0-7,5	16	30.5	130	65	108.0	4.5	35000	M 8 X1	4475 11.240
HSK-E 40	ER11	1,0-7,5	16	32.0	160	65	139.0	4.5	27000	M 8 X1	4475 11.340
HSK-E 50	ER11	1,0-7,5	16	18.0	60	37	30.0	4.5	30000	M 8 X1	4475 11.050
HSK-E 50	ER11	1,0-7,5	16	24.5	100	73	70.0	4.5	30000	M 8 X1	4475 11.150



Precision collets for precision collet holders

Article no. **4574**

Product information:

- precision collet holders, sealed ER11 sim. ISO 15488
- especially for precision collet holders art. nr. 4475 and 4476
- for tool shanks h10
- concentricity < 2 µm
- no clamping bridging
- observe maximum tightening torque values of clamping nut
clamping Ø 1.0 - 2.5 = 7 Nm
clamping Ø 3.0 - 7.5 = 10 Nm

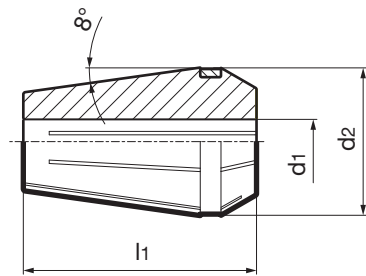

Article no. **4574**

Size	d1 mm	d2 mm	l1 mm	Order no.
ER11	1.00	11.3	18.00	4574 1.011
ER11	1.50	11.3	18.00	4574 1.511
ER11	2.00	11.3	18.00	4574 2.011
ER11	2.50	11.3	18.00	4574 2.511
ER11	3.00	11.3	18.00	4574 3.011
ER11	3.50	11.3	18.00	4574 3.511
ER11	4.00	11.3	18.00	4574 4.011
ER11	4.50	11.3	18.00	4574 4.511
ER11	5.00	11.3	18.00	4574 5.011
ER11	5.50	11.3	18.00	4574 5.511
ER11	6.00	11.3	18.00	4574 6.011
ER11	6.50	11.3	18.00	4574 6.511
ER11	7.00	11.3	18.00	4574 7.011

Precision collets for precision collet holders, sealed

Article no. **4575**

Product information:

- precision collet holders, sealed ER11 sim. ISO 15488
- especially for precision collet holders art. nr. 4475 and 4476
- for tool shanks h8
- concentricity < 2 µm
- no clamping bridging
- observe maximum tightening torque values of clamping nut
clamping Ø 1.0 - 2.5 = 7 Nm
clamping Ø 3.0 - 7.5 = 10 Nm

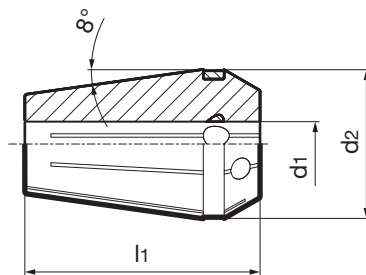

Article no. **4575**

Size	d1 mm	d2 mm	l1 mm	Order no.
ER11	3.00	11.3	18.00	4575 3.011
ER11	4.00	11.3	18.00	4575 4.011
ER11	5.00	11.3	18.00	4575 5.011
ER11	6.00	11.3	18.00	4575 6.011

Tool holders for micro tools



Clamping nuts for precision collet holders

Article no. **4573**

Product information:

- especially for precision collet holders art. nr. 4475 and 4476
- for ER11 high-precision collet holders (similar to ISO 15488), art. no. 4574 and 4575

suitable accessories separately available:

- roller keys art. no. 4994 11.000
- torque wrenches art.no. 4981 5.025

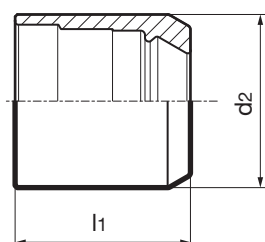

Article no. **4573**

Nominal size	Ø-range	d2 mm	l1 mm	Order no.
ER11	1.0-7.0	16.00	16.200	4573 11.000

Roller spanner for precision collet holders

Article no. **4994**

Product information:

- especially for precision collet holders art. nr. 4475 and 4476
- observe maximum tightening torque values of clamping nut
clamping Ø 1.0 - 2.5 = 7 Nm
clamping Ø 3.0 - 7.5 = 10 Nm

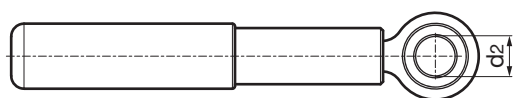

Article no. **4994**

Nominal size	d2 mm	Order no.
ER11	16	4994 11.000



Roller spanner insert for torque wrench

Article no. **4995**

Product information:

- for Torque wrenches art. no. 4981
- especially for precision collet holders art. nr. 4475 and 4476
- observe maximum tightening torque values of clamping nut
clamping Ø 1.0 - 2.5 = 7 Nm
clamping Ø 3.0 - 7.5 = 10 Nm

suitable accessories separately available:

- torque wrenches art.no. 4981 5.025

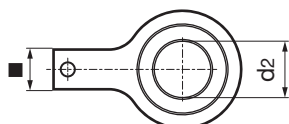

Article no. **4995**

Nominal size	d2 mm	Drive	Order no.
ER11	16	9x12	4995 11.000

Torque wrenches

Article no. **4981**

Product information:

- for roller spanner insert, art. no. 4995
- torque adjustable: 5-25 Nm
- with square socket
- triggering accuracy ± 3% of scale value

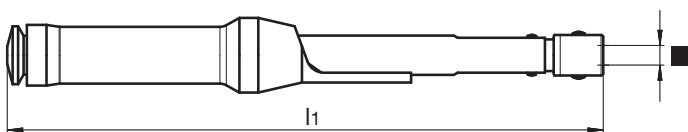

Article no. **4981**

Torque Nm	l1 mm	Drive	Order no.
5-25	273	9x12	4981 5.025

Tool holders for micro tools



HPC chucks HSK-A

Article no. **4300**



Product information:

- HSK-A according to ISO 12164-1 / DIN 69893-1
- balancing quality: G 2.5 / 20,000 rpm or U < 1.2 gmm
- incl. balancing thread 6xM6
- axial length adjustment
- for tool shanks d1 h6
- for heavy-duty machining as well as HSC and HPC
- highest clamping force and stability thanks to mech. tension gearing
- actuation torque for clamping force introduction max. 10 Nm
- suitable for internal cooling up to 80 bar

suitable accessories separately available:

- coolant supply set art. no. 4949
- clamping sleeves art. no. 4302, 4235, 4236, 4237
- Torque wrenches 10 Nm art. no. 4987 10.000
- sockets art. no. 4916 4.000 for optimal operation
- hexagonal key, art. no. 4912 4.600

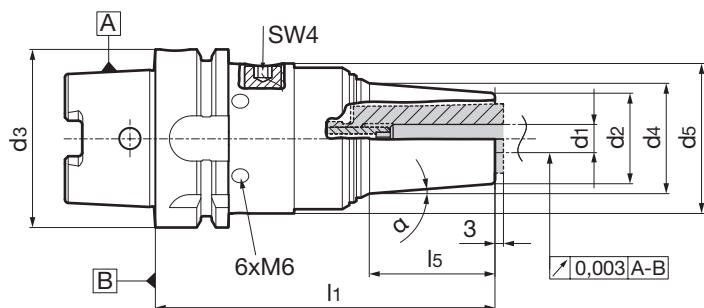

Article no. **4300**

d3	Nominal size	d1 mm	d2 mm	d4 mm	d5 mm	l1 mm	l5 mm	α °	Order no.
HSK-A 63	20	3.0-20.0	40	40	53	92	20		4300 20.063
HSK-A 63	20	3.0-20.0	32	39	53	120	44	4	4300 20.163
HSK-A 63	20	3.0-20.0	32	40	53	142	69	4	4300 20.263
HSK-A 100	20	3.0-20.0	40	40	70	100	18		4300 20.100
HSK-A 100	25	16.0-32.0	52	70	70	139	15		4300 25.100

HPC chucks SK

Article no. **4301**



Product information:

- ISO taper to DIN ISO 7388-1 form AD
- central internal cooling up to 80 bar
- balancing quality: G 2.5 / 20,000 rpm or U < 1.2 gmm
- for tool shanks d1 h6
- for heavy-duty machining as well as HSC and HPC
- highest clamping force and stability thanks to mech. tension gearing
- actuation torque for clamping force introduction max. 10 Nm
- axial length adjustment
- suitable for internal cooling up to 80 bar

suitable accessories separately available:

- clamping sleeves art. no. 4302, 4235, 4236, 4237
- ISO pull studs art. no. 4925, 4926
- Torque wrenches 10 Nm art. no. 4987 10.000
- sockets art. no. 4916 4.000 for optimal operation
- hexagonal key, art. no. 4912 4.600
- form AD/AF on request

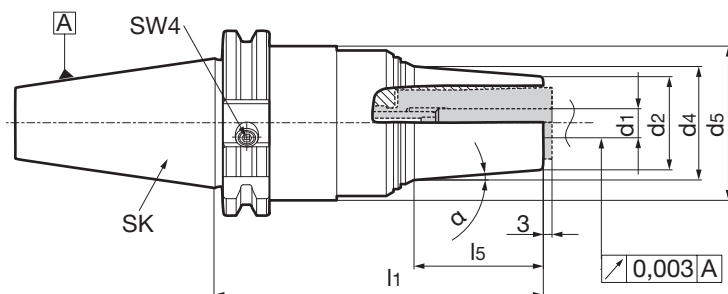

Article no. **4301**

SK	Nominal size	d1 mm	d2 mm	d4 mm	d5 mm	l1 mm	l5 mm	α °	Order no.
SK 40	20	3.0-20.0	40	40	50	62	20		4301 20.040
SK 40	20	3.0-20.0	32	39	50	91	44	4	4301 20.140
SK 40	20	3.0-20.0	32	40	50	112	69	4	4301 20.240
SK 50	20	3.0-20.0	40	40	63	62	18		4301 20.050
SK 50	25	16.0-32.0	52	70	70	101	15		4301 25.050

Precision clamping chucks



HPC chucks MAS/BT

Article no. **4244**



Product information:

- MAS/BT to DIN ISO 7388-2 form JD
- balancing quality: G 2.5 / 25,000 rpm or rev. < 1 gmm
- for tool shanks d1 h6
- axial length adjustment
- for heavy-duty machining as well as HSC and HPC
- highest clamping force and stability thanks to mech. tension gearing
- actuation torque for clamping force introduction max. 10 Nm
- suitable for internal cooling up to 80 bar

Scope of delivery:

- BT pull studs art. nr. 4927, 4928
- Torque wrenches 10 Nm art. no. 4987 10.000
- sockets art. no. 4916 4.000 for optimal operation
- hexagonal key, art. no. 4912 4.600
- clamping sleeves art. no. 4302, 4235, 4236, 4237

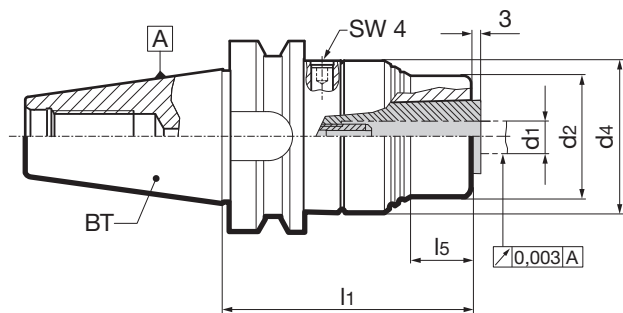

Article no. **4244**

BT	Nominal size	d1 mm	d2 mm	d4 mm	l1 mm	l5 mm	Order no.
BT 30	20	3.0-20.0	40.0	53	82.0	20	4244 20.030
BT 40	20	3.0-20.0	40.0	63	70.4	18	4244 20.040
BT 40	25	16.0-32.0	53.0	63	109.5	14	4244 25.040
BT 40	20	3.0-20.0	40.0	63	120.0	48	4244 120.040
BT 50	20	3.0-20.0	40.0	63	81.4	18	4244 20.050
BT 50	25	16.0-32.0	52.5	70	120.5	10	4244 25.050
BT 50	20	3.0-20.0	40.0	63	167.4	84	4244 120.050

HPC chucks CAT

Article no. **4243**



Product information:

- CAT to ASME B5.50
- CAT40 d4: does not correspond to ASME B5.50
- central internal coolant supply form DU
- balancing quality: G 2.5 / 20,000 rpm or U < 1.2 gmm
- for tool shanks d1 h6
- for heavy-duty machining as well as HSC and HPC
- highest clamping force and stability thanks to mech. tension gearing
- actuation torque for clamping force introduction max. 10 Nm
- suitable for internal cooling up to 80 bar

suitable accessories separately available:

- hexagonal key, art. no. 4912 4.600
- sockets art. no. 4916 4.000 for optimal operation
- clamping sleeves art. no. 4302, 4235, 4236, 4237
- socket wrenches 12 Nm art. no. 4915 12.000
- CAT pull studs on request

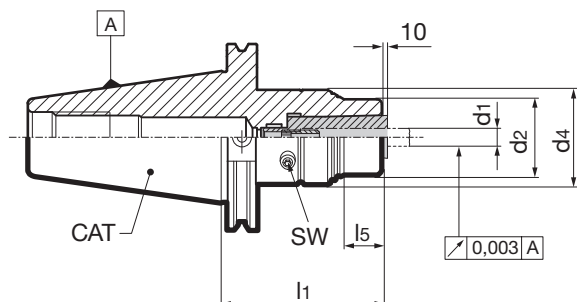

Article no. **4243**

CAT	Nominal size	d1 mm	d2 mm	d4 mm	l1 mm	l5 mm	Order no.
CAT 40	20	3.0-20.0	40	50	62.5	20	4243 20.040
CAT 50	20	3.0-20.0	40	63	62.0	18	4243 20.050
CAT 50	25	16.0-32.0	70	70	101.5		4243 25.050

Precision clamping chucks



Extensions HPC

Article no. **4208**



Product information:

- for tool shanks d1 h6
- slim extension for holding in HPC chuck or hydraulic chuck
- high clamping force
- actuation from the rear using the hexagonal key provided (SW1)
- actuation torque for clamping initiation 3 Nm

suitable accessories separately available:

- clamping sleeves art. no. 4302, 4235
- torque wrench art. no. 4915 3.000 for optimal operation
- hexagonal key, art. no. 4912 4.000

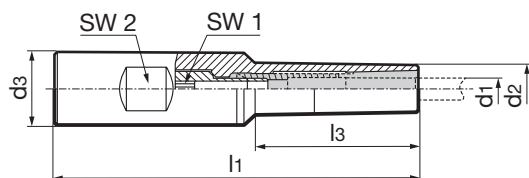

Article no.

4208

d3 mm	Nominal size	d1 mm	d2 mm	l1 mm	l3 mm	SW1 mm	SW2 mm	Order no.
14	6	1.0-6.0	13	100	29	4	13	4208 6.014
20	6	1.0-6.0	13	100	45	4	16	4208 6.020
14	6	1.0-6.0	13	150	29	4	13	4208 6.114
20	6	1.0-6.0	13	150	67	4	16	4208 6.120



Product information:

- for clamping tools with straight shank
- for tool shanks d1 h6
- for maximum holding torque
- design with peripheral cooling thanks to long slots
- type 1: for HPC power chuck
- type 2: for HPC extensions
- type P: PinLock pull-out protection with optimised cooling, 3 securing pins and assembly tool (design without adjustment way)

Scope of delivery:

- incl. adjusting screw

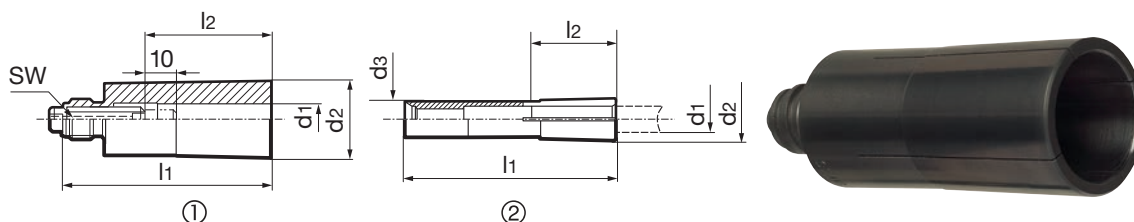

Article no.

4302

Nominal size	d1 mm	d2 mm	d3 mm	l1 mm	l2 mm	Type	SW mm	Order no.
6	1.0	10.0	8.5	50.0	28	2		4302 1.006
6	2.0	10.0	8.5	50.0	28	2		4302 2.006
6	3.0	10.0	8.5	50.0	28	2		4302 3.006
6	4.0	10.0	8.5	50.0	28	2		4302 4.006
6	5.0	10.0	8.5	50.0	28	2		4302 5.006
6	6.0	10.0	8.5	50.0	28	2		4302 6.006
20	6.0	24.6		66.0	36	1&P	4	4302 6.120
20	8.0	24.6		66.0	36	1&P	4	4302 8.120
20	10.0	24.6		66.0	40	1&P	4	4302 10.120
20	12.0	24.6		66.0	45	1&P	4	4302 12.120
20	14.0	24.6		66.0	45	1&P	4	4302 14.120
20	16.0	24.6		66.0	48	1&P	4	4302 16.120
20	18.0	24.6		66.0	48	1&P	4	4302 18.120
20	20.0	24.6		66.0	50	1&P	4	4302 20.120
25	16.0	39.0		87.5	48	1&P	5	4302 16.125
25	20.0	39.0		87.5	50	1&P	5	4302 20.125
25	22.0	39.0		87.5	50	1&P	5	4302 22.125
25	25.0	39.0		87.5	56	1&P	5	4302 25.125
20	3.0	24.6		66.0	28	1	4	4302 3.020
20	4.0	24.6		66.0	28	1	4	4302 4.020
20	5.0	24.6		66.0	28	1	4	4302 5.020
20	6.0	24.6		66.0	36	1	4	4302 6.020
20	8.0	24.6		66.0	36	1	4	4302 8.020
20	10.0	24.6		66.0	40	1	4	4302 10.020
20	12.0	24.6		66.0	45	1	4	4302 12.020
20	14.0	24.6		66.0	45	1	4	4302 14.020
20	16.0	24.6		66.0	48	1	4	4302 16.020
20	18.0	24.6		66.0	48	1	4	4302 18.020
20	20.0	24.6		66.0	50	1	4	4302 20.020
25	16.0	39.0		87.5	48	1	5	4302 16.025
25	20.0	39.0		87.5	50	1	5	4302 20.025
25	22.0	39.0		87.5	50	1	5	4302 22.025
25	25.0	39.0		87.5	56	1	5	4302 25.025
25	32.0	39.0		87.5	59	1	5	4302 32.025

Precision clamping chucks



Clamping sleeves for precision clamping chucks, sealed version

Article no. **4235**



Product information:

- for clamping tools with straight shank
- for tool shanks d1 h6
- high holding torque
- sealed design with short slots
- type 1: for HPC power chuck
- type 2: for HPC extensions

Scope of delivery:

- incl. adjusting screw

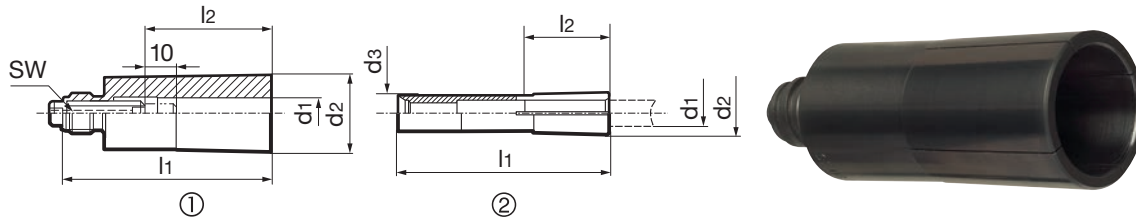

Article no.

4235

Nominal size	d1 mm	d2 mm	d3 mm	l1 mm	l2 mm	Type	SW mm	Order no.
6	1.0	10.0	8.5	50.0	28	2		4235 1.006
6	2.0	10.0	8.5	50.0	28	2		4235 2.006
6	3.0	10.0	8.5	50.0	28	2		4235 3.006
6	4.0	10.0	8.5	50.0	28	2		4235 4.006
6	5.0	10.0	8.5	50.0	28	2		4235 5.006
6	6.0	10.0	8.5	50.0	28	2		4235 6.006
20	3.0	24.6		66.0	28	1	4	4235 3.020
20	4.0	24.6		66.0	28	1	4	4235 4.020
20	5.0	24.6		66.0	28	1	4	4235 5.020
20	6.0	24.6		66.0	36	1	4	4235 6.020
20	8.0	24.6		66.0	36	1	4	4235 8.020
20	10.0	24.6		66.0	40	1	4	4235 10.020
20	12.0	24.6		66.0	45	1	4	4235 12.020
20	14.0	24.6		66.0	45	1	4	4235 14.020
20	16.0	24.6		66.0	48	1	4	4235 16.020
20	18.0	24.6		66.0	48	1	4	4235 18.020
20	20.0	24.6		66.0	50	1	4	4235 20.020
25	16.0	39.0		87.5	48	1	5	4235 16.025
25	20.0	39.0		87.5	50	1	5	4235 20.025
25	22.0	39.0		87.5	50	1	5	4235 22.025
25	25.0	39.0		87.5	56	1	5	4235 25.025
25	32.0	39.0		87.5	59	1	5	4235 32.025

Precision clamping chucks



Product information:

- for clamping imperial tool shanks
- for tool shanks d1 h6
- for maximum holding torque
- design with peripheral cooling thanks to long slots
- type P: PinLock pull-out protection with optimised cooling, 3 securing pins and assembly tool (design without adjustment way)

Scope of delivery:

- incl. adjusting screw

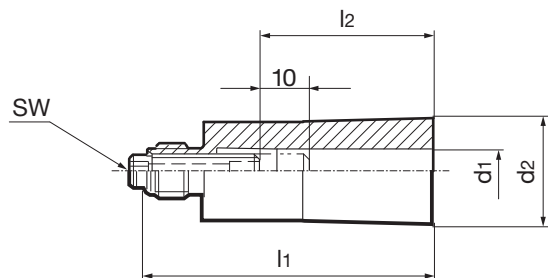

Article no.

4236

Nominal size	d1 mm	d2 mm	l1 mm	l2 mm	Type	SW mm	Order no.
20	12.700	24.6	66.0	45	P	4	4236 1.120
20	15.875	24.6	66.0	48	P	4	4236 2.120
25	19.050	39.0	87.5	51	P	5	4236 1.125
25	25.400	39.0	87.5	58	P	5	4236 2.125
20	3.175	24.6	66.0	28		4	4236 1.020
20	4.760	24.6	66.0	28		4	4236 2.020
20	6.350	24.6	66.0	36		4	4236 3.020
20	7.940	24.6	66.0	36		4	4236 4.020
20	9.525	24.6	66.0	40		4	4236 5.020
20	11.110	24.6	66.0	45		4	4236 6.020
20	12.700	24.6	66.0	45		4	4236 7.020
20	14.290	24.6	66.0	45		4	4236 8.020
20	15.880	24.6	66.0	48		4	4236 9.020
20	17.460	24.6	66.0	48		4	4236 10.020
20	19.050	24.6	66.0	50		4	4236 11.020
25	19.050	39.0	87.5	50		5	4236 1.025
25	25.400	39.0	87.5	56		5	4236 2.025

Precision clamping chucks



Clamping sleeves, imp., f. prec. clamp. chucks, sealed version

Article no. **4237**

Product information:

- for clamping imperial tool shanks
- for tool shanks d1 h6
- high holding torque
- sealed design with short slots

Scope of delivery:

- incl. adjusting screw

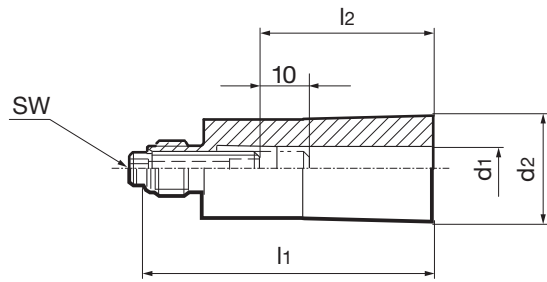

Article no. **4237**

Nominal size	d1 mm	d2 mm	l1 mm	l2 mm	SW mm	Order no.
20	9.525	24.6	66.0	40	4	4237 5.020
20	3.175	24.6	66.0	28	4	4237 1.020
25	19.050	39.0	87.5	50	5	4237 1.025
20	4.760	24.6	66.0	28	4	4237 2.020
25	25.400	39.0	87.5	56	5	4237 2.025
20	6.350	24.6	66.0	36	4	4237 3.020
20	7.940	24.6	66.0	36	4	4237 4.020
20	11.110	24.6	66.0	45	4	4237 6.020
20	12.700	24.6	66.0	45	4	4237 7.020
20	14.290	24.6	66.0	45	4	4237 8.020
20	15.880	24.6	66.0	48	4	4237 9.020
20	17.460	24.6	66.0	48	4	4237 10.020
20	19.050	24.6	66.0	50	4	4237 11.020

HSK-A Weldon side lock holders GÜHROJET
Article no. **4232**
GÜHROJET
Product information:

- HSK-A according to ISO 12164-1 / DIN 69893-1
- dimensions according to DIN 69882-4
- balancing quality: G 6.3 / 15,000 rpm
- with mounting hole DIN 1835-2, Form B "Weldon"
- from holder d1 = 25 mm with 2 clamping screws, art. no. 4903
- with coolant ducts for peripheral cooling, therefore process and tool life improvement
- coolant ducts: d1 = 6 - 14 mm with two coolant ducts, d1 = 16 - 32 mm with four coolant ducts

Scope of delivery:

- incl. clamping screw art. no. 4903

suitable accessories separately available:

- coolant supply set art. no. 4949
- replacement clamping screw, art. no. 4903

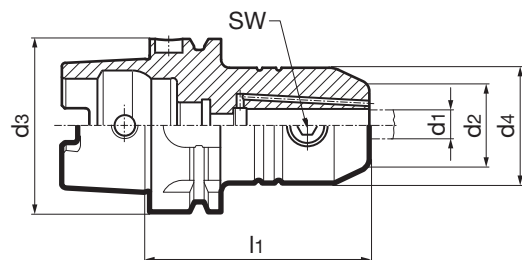

Article no.

4232

d3	d1 H5 mm	d2 mm	d4 mm	l1 mm	SW mm	Order no.
HSK-A 32	6	15	25	60	3	4232 6.032
HSK-A 32	8	20	28	60	4	4232 8.032
HSK-A 32	10	25	35	65	5	4232 10.032
HSK-A 32	12	30	42	65	6	4232 12.032
HSK-A 40	6	15	25	60	3	4232 6.040
HSK-A 40	8	20	28	60	4	4232 8.040
HSK-A 40	10	25	35	60	5	4232 10.040
HSK-A 40	12	30	42	70	6	4232 12.040
HSK-A 40	14	32	44	75	6	4232 14.040
HSK-A 40	16	36	48	75	6	4232 16.040
HSK-A 50	6	15	25	65	3	4232 6.050
HSK-A 50	8	20	28	65	4	4232 8.050
HSK-A 50	10	25	35	65	5	4232 10.050
HSK-A 50	12	30	42	80	6	4232 12.050
HSK-A 50	14	32	44	80	6	4232 14.050
HSK-A 50	16	36	48	80	6	4232 16.050
HSK-A 50	18	38	50	80	6	4232 18.050
HSK-A 50	20	40	52	80	8	4232 20.050
HSK-A 63	6	15	25	65	3	4232 6.063
HSK-A 63	8	20	28	65	4	4232 8.063
HSK-A 63	10	25	35	65	5	4232 10.063
HSK-A 63	12	30	42	80	6	4232 12.063
HSK-A 63	14	32	44	80	6	4232 14.063
HSK-A 63	16	36	48	80	6	4232 16.063
HSK-A 63	18	38	50	80	6	4232 18.063
HSK-A 63	20	40	52	80	8	4232 20.063
HSK-A 63	25	45	65	110	10	4232 25.063
HSK-A 63	32	56	72	110	10	4232 32.063
HSK-A 80	6	15	25	80	3	4232 6.080
HSK-A 80	8	20	28	80	4	4232 8.080
HSK-A 80	10	25	35	80	5	4232 10.080
HSK-A 80	12	30	42	80	6	4232 12.080
HSK-A 80	14	32	44	80	6	4232 14.080
HSK-A 80	16	36	48	100	6	4232 16.080
HSK-A 80	18	38	50	100	6	4232 18.080
HSK-A 80	20	40	52	100	8	4232 20.080
HSK-A 80	25	45	65	100	10	4232 25.080
HSK-A 80	32	56	72	110	10	4232 32.080
HSK-A 80	40	60	80	120	10	4232 40.080
HSK-A 100	6	15	25	80	3	4232 6.100
HSK-A 100	8	20	28	80	4	4232 8.100
HSK-A 100	10	25	35	80	5	4232 10.100
HSK-A 100	12	30	42	80	6	4232 12.100
HSK-A 100	14	32	44	80	6	4232 14.100
HSK-A 100	16	36	48	100	6	4232 16.100
HSK-A 100	18	38	50	100	6	4232 18.100
HSK-A 100	20	40	52	100	8	4232 20.100
HSK-A 100	25	45	65	100	10	4232 25.100



Side lock holders

Article no.

4232

d3	d1 H5 mm	d2 mm	d4 mm	l1 mm	SW mm	Order no.
HSK-A 100	32	56	72	100	10	4232 32.100
HSK-A 100	40	60	80	110	10	4232 40.100



HSK-A Weldon side lock holders

Article no. 4329



Product information:

- HSK-A according to ISO 12164-1 / DIN 69893-1
- dimensions according to DIN 69882-4
- with mounting hole DIN 1835-2, Form B "Weldon"
- balancing quality: G 6.3 / 15,000 rpm
- from holder d1 = 25 mm with 2 clamping screws, art. no. 4903

Scope of delivery:

- incl. clamping screw art. no. 4903

suitable accessories separately available:

- coolant supply set art. no. 4949
- replacement clamping screw, art. no. 4903

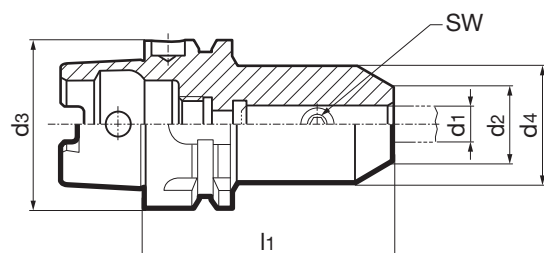

Article no.

4329

d3	d1 H5 mm	d2 mm	d4 mm	l1 mm	SW mm	Order no.
HSK-A 32	6	15	25	60	3	4329 6.032
HSK-A 32	8	20	28	60	4	4329 8.032
HSK-A 32	10	25	35	65	5	4329 10.032
HSK-A 32	12	30	42	65	6	4329 12.032
HSK-A 40	6	15	25	60	3	4329 6.040
HSK-A 40	8	20	28	60	4	4329 8.040
HSK-A 40	10	25	35	60	5	4329 10.040
HSK-A 40	12	30	42	70	6	4329 12.040
HSK-A 40	14	32	44	75	6	4329 14.040
HSK-A 40	16	36	48	75	6	4329 16.040
HSK-A 50	6	15	25	65	3	4329 6.050
HSK-A 50	8	20	28	65	4	4329 8.050
HSK-A 50	10	25	35	65	5	4329 10.050
HSK-A 50	12	30	42	80	6	4329 12.050
HSK-A 50	14	32	44	80	6	4329 14.050
HSK-A 50	16	36	48	80	6	4329 16.050
HSK-A 50	18	38	50	80	6	4329 18.050
HSK-A 50	20	40	52	80	8	4329 20.050
HSK-A 63	6	15	25	65	3	4329 6.063
HSK-A 63	8	20	28	65	4	4329 8.063
HSK-A 63	10	25	35	65	5	4329 10.063
HSK-A 63	12	30	42	80	6	4329 12.063
HSK-A 63	14	32	44	80	6	4329 14.063
HSK-A 63	16	36	48	80	6	4329 16.063
HSK-A 63	18	38	50	80	6	4329 18.063
HSK-A 63	20	40	52	80	8	4329 20.063
HSK-A 63	25	45	65	110	10	4329 25.063
HSK-A 63	32	56	72	110	10	4329 32.063
HSK-A 80	6	15	25	80	3	4329 6.080
HSK-A 80	8	20	28	80	4	4329 8.080
HSK-A 80	10	25	35	80	5	4329 10.080
HSK-A 80	12	30	42	80	6	4329 12.080
HSK-A 80	14	32	44	80	6	4329 14.080
HSK-A 80	16	36	48	100	6	4329 16.080
HSK-A 80	18	38	50	100	6	4329 18.080
HSK-A 80	20	40	52	100	8	4329 20.080
HSK-A 80	25	45	65	100	10	4329 25.080
HSK-A 80	32	56	72	110	10	4329 32.080
HSK-A 80	40	60	80	120	10	4329 40.080
HSK-A 100	6	15	25	80	3	4329 6.100
HSK-A 100	8	20	28	80	4	4329 8.100
HSK-A 100	10	25	35	80	5	4329 10.100
HSK-A 100	12	30	42	80	6	4329 12.100
HSK-A 100	14	32	44	80	6	4329 14.100
HSK-A 100	16	36	48	100	6	4329 16.100
HSK-A 100	18	38	50	100	6	4329 18.100
HSK-A 100	20	40	52	100	8	4329 20.100
HSK-A 100	25	45	65	100	10	4329 25.100



Side lock holders

Article no.

4329

d3	d1 H5 mm	d2 mm	d4 mm	l1 mm	SW mm	Order no.
HSK-A 100	32	56	72	100	10	4329 32.100
HSK-A 100	40	60	80	110	10	4329 40.100



HSK-A Whistle notch side lock holders

Article no. 4334



Product information:

- HSK-A according to ISO 12164-1 / DIN 69893-1
- dimensions according to DIN 69882-5
- with locating bore DIN 1835-2 form E "Whistle Notch" with groove on face for identification
- balancing quality: G 6.3 / 15,000 rpm
- from holder d1 = 25 mm with 2 clamping screws, art. no. 4903

Scope of delivery:

- incl. clamping screw art. no. 4903
- adjusting screw art.no. 4900

suitable accessories separately available:

- coolant supply set art. no. 4949
- replacement adjusting screw (1), art. no. 4900
- replacement clamping screw, art. no. 4903

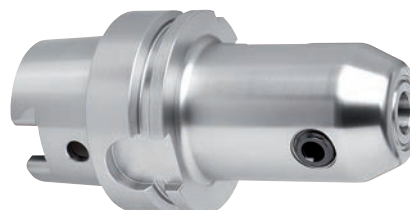
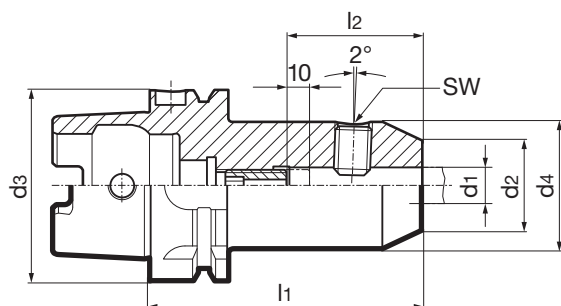

Article no.

4334

d3	d1 H5 mm	d2 mm	d4 mm	l1 mm	l2 mm	SW mm	Order no.
HSK-A 32	6	15	32	80	36	3	4334 6.032
HSK-A 32	8	20	32	80	36	4	4334 8.032
HSK-A 32	10	25	32	80	40	5	4334 10.032
HSK-A 32	12	30	32	80	45	6	4334 12.032
HSK-A 40	6	15	40	80	36	3	4334 6.040
HSK-A 40	8	20	40	80	36	4	4334 8.040
HSK-A 40	10	25	40	80	40	5	4334 10.040
HSK-A 40	12	30	40	90	45	6	4334 12.040
HSK-A 40	14	32	40	90	45	6	4334 14.040
HSK-A 40	16	36	40	90	48	6	4334 16.040
HSK-A 50	6	15	50	80	36	3	4334 6.050
HSK-A 50	8	20	50	80	36	4	4334 8.050
HSK-A 50	10	25	50	80	40	5	4334 10.050
HSK-A 50	12	30	50	90	45	6	4334 12.050
HSK-A 50	14	32	50	90	45	6	4334 14.050
HSK-A 50	16	36	50	90	48	6	4334 16.050
HSK-A 50	18	38	50	90	48	6	4334 18.050
HSK-A 50	20	40	50	100	50	8	4334 20.050
HSK-A 63	6	15	63	80	36	3	4334 6.063
HSK-A 63	8	20	63	80	36	4	4334 8.063
HSK-A 63	10	25	63	80	40	5	4334 10.063
HSK-A 63	12	30	63	90	45	6	4334 12.063
HSK-A 63	14	32	63	90	45	6	4334 14.063
HSK-A 63	16	36	63	100	48	6	4334 16.063
HSK-A 63	18	38	63	100	48	6	4334 18.063
HSK-A 63	20	40	63	100	50	8	4334 20.063
HSK-A 63	25	45	63	110	56	10	4334 25.063
HSK-A 63	32	56	63	110	60	10	4334 32.063
HSK-A 80	6	15	80	90	36	3	4334 6.080
HSK-A 80	8	20	80	90	36	4	4334 8.080
HSK-A 80	10	25	80	90	40	5	4334 10.080
HSK-A 80	12	30	80	100	45	6	4334 12.080
HSK-A 80	14	32	80	100	45	6	4334 14.080
HSK-A 80	16	36	80	100	48	6	4334 16.080
HSK-A 80	18	38	80	100	48	6	4334 18.080
HSK-A 80	20	40	80	110	50	8	4334 20.080
HSK-A 80	25	45	80	110	56	10	4334 25.080
HSK-A 80	32	56	80	120	60	10	4334 32.080
HSK-A 100	6	15	100	90	36	3	4334 6.100
HSK-A 100	8	20	100	90	36	4	4334 8.100
HSK-A 100	10	25	100	90	40	5	4334 10.100
HSK-A 100	12	30	100	100	45	6	4334 12.100
HSK-A 100	14	32	100	100	45	6	4334 14.100
HSK-A 100	16	36	100	100	48	6	4334 16.100
HSK-A 100	18	38	100	100	48	6	4334 18.100
HSK-A 100	20	40	100	110	50	8	4334 20.100
HSK-A 100	25	45	100	120	56	10	4334 25.100
HSK-A 100	32	56	100	120	60	10	4334 32.100



HSK-C Whistle notch side lock holders

Article no. **4333**

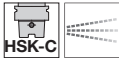

Product information:

- HSK-C according to ISO 12164-1/DIN 69893-1
- dimensions according to DIN 69882-5
- with locating bore DIN 1835-2 form E "Whistle Notch" with groove on face for identification
- balancing quality: G 6.3 / 15,000 rpm
- for tool shanks d1 h6
- from holder d1 = 25 mm with 2 clamping screws, art. no. 4903

Scope of delivery:

- incl. clamping screw art. no. 4903
- adjusting screw art.no. 4900

suitable accessories separately available:

- replacement clamping screw, art. no. 4903
- replacement adjusting screw (1), art. no. 4900

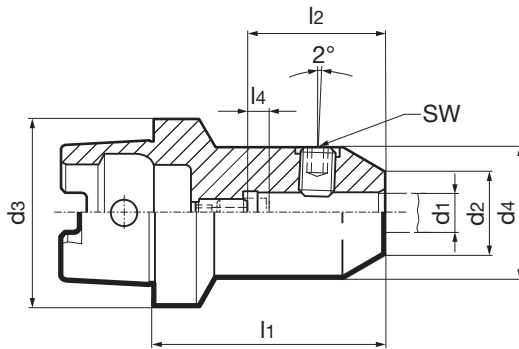

Article no.

4333

d3	d1 H5 mm	d2 mm	d4 mm	l1 mm	l2 mm	l4 mm	SW mm	Order no.
HSK-C 32	6	25	32	60	36	10	3	4333 6.032
HSK-C 32	8	28	32	60	36	10	4	4333 8.032
HSK-C 32	10	35	32	65	40	10	5	4333 10.032
HSK-C 40	6	25	40	60	36	10	3	4333 6.040
HSK-C 40	8	28	40	60	36	10	4	4333 8.040
HSK-C 40	10	35	40	65	40	10	5	4333 10.040
HSK-C 40	12	42	40	70	45	8	6	4333 12.040
HSK-C 40	14	44	40	70	45	8	6	4333 14.040
HSK-C 40	16	48	40	75	48	8	6	4333 16.040
HSK-C 40	20	52	40	80	50	8	8	4333 20.040
HSK-C 50	6	25	50	60	36	8	3	4333 6.050
HSK-C 50	8	28	50	60	36	8	4	4333 8.050
HSK-C 50	10	35	50	65	40	8	5	4333 10.050
HSK-C 50	12	42	50	75	45	10	6	4333 12.050
HSK-C 50	14	44	50	75	45	10	6	4333 14.050
HSK-C 50	16	48	50	80	48	10	6	4333 16.050
HSK-C 50	18	49	50	80	48	10	6	4333 18.050
HSK-C 50	20	52	50	80	50	8	8	4333 20.050
HSK-C 50	25	65	50	95	56	8	10	4333 25.050
HSK-C 63	6	25	63	60	36	8	3	4333 6.063
HSK-C 63	8	28	63	60	36	8	4	4333 8.063
HSK-C 63	10	35	63	65	40	8	5	4333 10.063
HSK-C 63	12	42	63	75	45	10	6	4333 12.063
HSK-C 63	14	44	63	75	45	10	6	4333 14.063
HSK-C 63	16	48	63	80	48	10	6	4333 16.063
HSK-C 63	18	50	63	80	48	10	6	4333 18.063
HSK-C 63	20	52	63	80	50	8	8	4333 20.063
HSK-C 63	25	65	63	95	56	8	10	4333 25.063
HSK-C 63	32	72	63	100	60	8	10	4333 32.063

Side lock holders



ISO taper Weldon side lock holders GÜHROJET

Article no. 4824



GÜHROJET

Product information:

- ISO taper to DIN ISO 7388-1 form AD/AF
- holes for AF form closed with threaded pins on delivery
- with mounting hole DIN 1835-2, Form B "Weldon"
- balancing quality: G 6.3 / 15,000 rpm
- with coolant ducts in the clamping bore for peripheral cooling, therefore process and tool life improvement
- from holder d1 = 25 mm with 2 clamping screws, art. no. 4903
- coolant supply form AD/AF
- coolant ducts: d1 = 6 - 18 mm with two coolant ducts d1 = 20 - 32 mm with four coolant ducts

Scope of delivery:

- incl. clamping screw art. no. 4903
- incl. O ring for sealing

suitable accessories separately available:

- ISO pull studs art. no. 4925, 4926
- replacement clamping screw, art. no. 4903

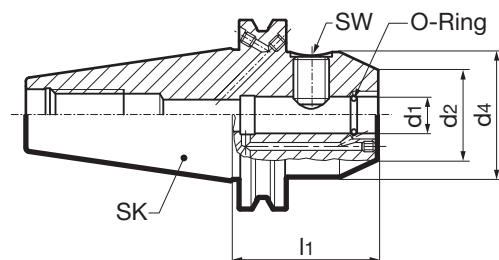

Article no.

4824

SK	d1 h5 mm	d2 mm	d4 mm	l1 mm	SW mm	Order no.
SK 40	6	15	25	50	3	4824 6.040
SK 40	8	20	28	50	4	4824 8.040
SK 40	10	25	35	50	5	4824 10.040
SK 40	12	30	42	50	6	4824 12.040
SK 40	14	32	44	50	6	4824 14.040
SK 40	16	36	48	63	6	4824 16.040
SK 40	18	38	50	63	6	4824 18.040
SK 40	20	40	52	63	8	4824 20.040
SK 40	25	45	63	100	10	4824 25.040
SK 40	32	56	72	100	10	4824 32.040
SK 40	6	15	25	100	3	4824 106.040
SK 40	8	20	28	100	4	4824 108.040
SK 40	10	25	35	100	5	4824 110.040
SK 40	12	30	42	100	6	4824 112.040
SK 40	14	32	44	100	6	4824 114.040
SK 40	16	36	48	100	6	4824 116.040
SK 40	18	38	50	100	6	4824 118.040
SK 40	20	40	52	100	8	4824 120.040
SK 40	6	15	25	130	3	4824 206.040
SK 40	8	20	28	130	4	4824 208.040
SK 40	10	25	35	130	5	4824 210.040
SK 40	12	30	42	130	6	4824 212.040
SK 40	14	32	44	130	6	4824 214.040
SK 40	16	36	48	130	6	4824 216.040
SK 40	18	38	50	130	6	4824 218.040
SK 40	20	40	52	130	8	4824 220.040
SK 40	25	45	63	130	10	4824 225.040
SK 40	32	56	72	130	10	4824 232.040
SK 40	6	15	25	160	3	4824 306.040
SK 40	8	20	28	160	4	4824 308.040
SK 40	10	25	35	160	5	4824 310.040
SK 40	12	30	42	160	6	4824 312.040
SK 40	14	32	44	160	6	4824 314.040
SK 40	16	36	48	160	6	4824 316.040
SK 40	18	38	50	160	6	4824 318.040
SK 40	20	40	52	160	8	4824 320.040
SK 40	25	45	63	160	10	4824 325.040
SK 40	32	56	72	160	10	4824 332.040
SK 40	6	15	25	200	3	4824 406.040
SK 40	8	20	28	200	4	4824 408.040
SK 40	10	25	35	200	5	4824 410.040
SK 40	12	30	42	200	6	4824 412.040
SK 40	14	32	44	200	6	4824 414.040
SK 40	16	36	48	200	6	4824 416.040
SK 40	18	38	50	200	6	4824 418.040
SK 40	20	40	52	200	8	4824 420.040
SK 40	25	45	63	200	10	4824 425.040
SK 40	32	56	72	200	10	4824 432.040



Side lock holders

Article no.

4824

SK	d1 h5 mm	d2 mm	d4 mm	l1 mm	SW mm	Order no.
SK 50	6	15	25	63	3	4824 6.050
SK 50	8	20	28	63	4	4824 8.050
SK 50	10	25	35	63	5	4824 10.050
SK 50	12	30	42	63	6	4824 12.050
SK 50	14	32	44	63	6	4824 14.050
SK 50	16	36	48	63	6	4824 16.050
SK 50	18	38	50	63	6	4824 18.050
SK 50	20	40	52	63	8	4824 20.050
SK 50	25	45	63	80	10	4824 25.050
SK 50	32	56	72	100	10	4824 32.050
SK 50	6	15	25	130	3	4824 206.050
SK 50	8	20	28	130	4	4824 208.050
SK 50	10	25	35	130	5	4824 210.050
SK 50	12	30	42	130	6	4824 212.050
SK 50	14	32	44	130	6	4824 214.050
SK 50	16	36	48	130	6	4824 216.050
SK 50	18	38	50	130	6	4824 218.050
SK 50	20	40	52	130	8	4824 220.050
SK 50	25	45	63	130	10	4824 225.050
SK 50	32	56	72	130	10	4824 232.050
SK 50	6	15	25	160	3	4824 306.050
SK 50	8	20	28	160	4	4824 308.050
SK 50	10	25	35	160	5	4824 310.050
SK 50	12	30	42	160	6	4824 312.050
SK 50	14	32	44	160	6	4824 314.050
SK 50	16	36	48	160	6	4824 316.050
SK 50	18	38	50	160	6	4824 318.050
SK 50	20	40	52	160	8	4824 320.050
SK 50	25	45	63	160	10	4824 325.050
SK 50	32	56	72	160	10	4824 332.050
SK 50	6	15	25	200	3	4824 406.050
SK 50	8	20	28	200	4	4824 408.050
SK 50	10	25	35	200	5	4824 410.050
SK 50	12	30	42	200	6	4824 412.050
SK 50	14	32	44	200	6	4824 414.050
SK 50	16	36	48	200	6	4824 416.050
SK 50	18	38	50	200	6	4824 418.050
SK 50	20	40	52	200	8	4824 420.050
SK 50	25	45	63	200	10	4824 425.050
SK 50	32	56	72	200	10	4824 432.050

Side lock holders



ISO taper Weldon side lock holders

Article no. 4497



Product information:

- ISO taper to DIN ISO 7388-1 form AD
- with mounting hole DIN 1835-2, Form B "Weldon"
- balancing quality: G 6.3 / 15,000 rpm
- from holder d1 = 25 mm with 2 clamping screws, art. no. 4903

Scope of delivery:

- incl. clamping screw art. no. 4903

suitable accessories separately available:

- ISO pull studs art. no. 4925, 4926
- replacement clamping screw, art. no. 4903

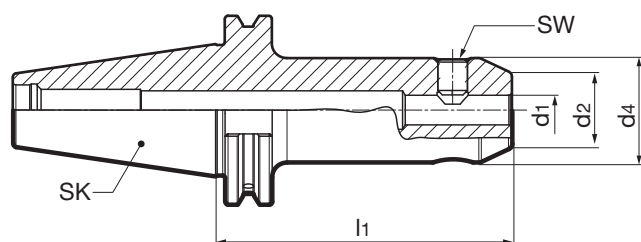

Article no.

4497

SK	d1 h5 mm	d2 mm	d4 mm	l1 mm	SW mm	Order no.
SK 40	6	15	25	50	3	4497 6.040
SK 40	8	20	28	50	4	4497 8.040
SK 40	10	25	35	50	5	4497 10.040
SK 40	12	30	42	50	6	4497 12.040
SK 40	14	32	44	50	6	4497 14.040
SK 40	16	36	48	63	6	4497 16.040
SK 40	18	38	50	63	6	4497 18.040
SK 40	20	40	52	63	8	4497 20.040
SK 40	6	15	25	100	3	4497 106.040
SK 40	8	20	28	100	4	4497 108.040
SK 40	10	25	35	100	5	4497 110.040
SK 40	12	30	42	100	6	4497 112.040
SK 40	14	32	44	100	6	4497 114.040
SK 40	16	36	48	100	6	4497 116.040
SK 40	18	38	50	100	6	4497 118.040
SK 40	20	40	52	100	8	4497 120.040
SK 40	25	45	63	100	10	4497 125.040
SK 40	32	56	72	100	10	4497 132.040
SK 40	6	15	25	130	3	4497 206.040
SK 40	8	20	28	130	4	4497 208.040
SK 40	10	25	35	130	5	4497 210.040
SK 40	12	30	42	130	6	4497 212.040
SK 40	14	32	44	130	6	4497 214.040
SK 40	16	36	48	130	6	4497 216.040
SK 40	18	38	50	130	6	4497 218.040
SK 40	20	40	52	130	8	4497 220.040
SK 40	25	45	63	130	10	4497 225.040
SK 40	32	56	72	130	10	4497 232.040
SK 40	6	15	25	160	3	4497 306.040
SK 40	8	20	28	160	4	4497 308.040
SK 40	10	25	35	160	5	4497 310.040
SK 40	12	30	42	160	6	4497 312.040
SK 40	14	32	44	160	6	4497 314.040
SK 40	16	36	48	160	6	4497 316.040
SK 40	18	38	50	160	6	4497 318.040
SK 40	20	40	52	160	8	4497 320.040
SK 40	25	45	63	160	10	4497 325.040
SK 40	32	56	72	160	10	4497 332.040
SK 40	16	36	45	35	6	4497 916.040
SK 40	20	40	45	35	8	4497 920.040
SK 40	25	45	50	35	10	4497 925.040
SK 50	6	15	25	63	3	4497 6.050
SK 50	8	20	28	63	4	4497 8.050
SK 50	10	25	35	63	5	4497 10.050
SK 50	12	30	42	63	6	4497 12.050
SK 50	14	32	44	63	6	4497 14.050
SK 50	16	36	48	63	6	4497 16.050
SK 50	18	38	50	63	6	4497 18.050



Side lock holders

Article no.

4497

SK	d1 h5 mm	d2 mm	d4 mm	l1 mm	SW mm	Order no.
SK 50	20	40	52	63	8	4497 20.050
SK 50	25	45	63	80	10	4497 25.050
SK 50	6	15	25	100	3	4497 106.050
SK 50	8	20	28	100	4	4497 108.050
SK 50	10	25	35	100	5	4497 110.050
SK 50	12	30	42	100	6	4497 112.050
SK 50	14	32	44	100	6	4497 114.050
SK 50	16	36	48	100	6	4497 116.050
SK 50	18	38	50	100	6	4497 118.050
SK 50	20	40	52	100	8	4497 120.050
SK 50	25	45	63	100	10	4497 125.050
SK 50	32	56	72	100	10	4497 132.050
SK 50	6	15	25	130	3	4497 206.050
SK 50	8	20	28	130	4	4497 208.050
SK 50	10	25	35	130	5	4497 210.050
SK 50	12	30	42	130	6	4497 212.050
SK 50	14	32	44	130	6	4497 214.050
SK 50	16	36	48	130	6	4497 216.050
SK 50	18	38	50	130	6	4497 218.050
SK 50	20	40	52	130	8	4497 220.050
SK 50	25	45	63	130	10	4497 225.050
SK 50	32	56	72	130	10	4497 232.050
SK 50	6	15	25	160	3	4497 306.050
SK 50	8	20	28	160	4	4497 308.050
SK 50	10	25	35	160	5	4497 310.050
SK 50	12	30	42	160	6	4497 312.050
SK 50	14	32	44	160	6	4497 314.050
SK 50	16	36	48	160	6	4497 316.050
SK 50	18	38	50	160	6	4497 318.050
SK 50	20	40	52	160	8	4497 320.050
SK 50	25	45	63	160	10	4497 325.050
SK 50	32	56	72	160	10	4497 332.050

Side lock holders



ISO taper Whistle Notch side lock holders

Article no. 4853



Product information:

- ISO taper to DIN ISO 7388-1 form AD/AF
- with mounting hole DIN 1835-2, Form E „Whistle Notch“
- balancing quality: G 6.3 / 15,000 rpm
- from holder d1 = 25 mm with 2 clamping screws, art. no. 4903

Scope of delivery:

- incl. clamping screw art. no. 4903
- adjusting screw art.no. 4900

suitable accessories separately available:

- replacement clamping screw, art. no. 4903
- replacement adjusting screw (1), art. no. 4900
- ISO pull studs art. no. 4925, 4926

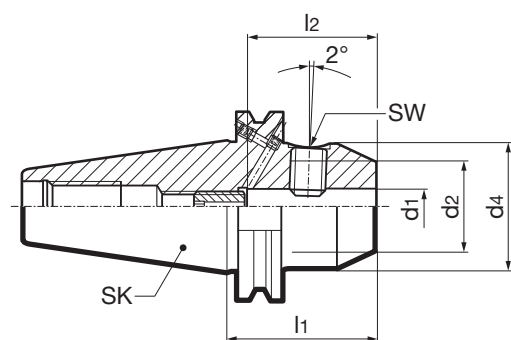

Article no.

4853

SK	d1 H5 mm	d2 mm	d4 mm	l1 mm	l2 mm	SW mm	Order no.
SK 40	6	15	25	50	36	3	4853 6.040
SK 40	8	20	28	50	36	4	4853 8.040
SK 40	10	25	35	50	40	5	4853 10.040
SK 40	12	30	42	50	45	6	4853 12.040
SK 40	14	32	44	50	45	6	4853 14.040
SK 40	16	36	48	63	48	6	4853 16.040
SK 40	18	38	50	63	48	6	4853 18.040
SK 40	20	40	52	63	50	8	4853 20.040
SK 40	25	45	63	100	56	10	4853 25.040
SK 40	32	56	72	100	60	10	4853 32.040
SK 40	6	15	25	130	36	3	4853 106.040
SK 40	8	20	28	130	36	4	4853 108.040
SK 40	10	25	35	130	40	5	4853 110.040
SK 40	12	30	42	130	45	6	4853 112.040
SK 40	14	32	44	130	45	6	4853 114.040
SK 40	16	36	36	130	54	6	4853 116.040
SK 40	18	38	38	130	48	6	4853 118.040
SK 40	20	40	40	130	50	8	4853 120.040
SK 40	25	46	46	130	56	10	4853 125.040
SK 40	32	52	52	130	68	10	4853 132.040
SK 50	6	15	25	63	36	3	4853 6.050
SK 50	8	20	28	63	36	4	4853 8.050
SK 50	10	25	35	63	40	5	4853 10.050
SK 50	12	30	42	63	45	6	4853 12.050
SK 50	14	32	44	63	45	6	4853 14.050
SK 50	16	36	48	63	48	6	4853 16.050
SK 50	18	38	50	63	48	6	4853 18.050
SK 50	20	40	52	63	50	8	4853 20.050
SK 50	25	45	63	80	56	10	4853 25.050
SK 50	32	56	72	100	60	10	4853 32.050



Product information:

- BT30 and BT40 (order no. 4234 916.040, 4234 920.040, 4234 925.040) design JD without coolant supply via collar and without GÜHROJET
- with mounting hole DIN 1835-2, Form B “Weldon”
- balancing quality: G 6.3 / 15,000 rpm
- from holder d1 = 25 mm with 2 clamping screws, art. no. 4903
- with coolant ducts in the clamping bore for peripheral cooling, therefore process and tool life improvement
- coolant ducts: d1 = 6 - 18 mm with two coolant ducts d1 = 20 - 32 mm with four coolant ducts

Scope of delivery:

- incl. clamping screw art. no. 4903
- incl. O ring for sealing

suitable accessories separately available:

- BT pull studs art. nr. 4927, 4928
- replacement clamping screw, art. no. 4903

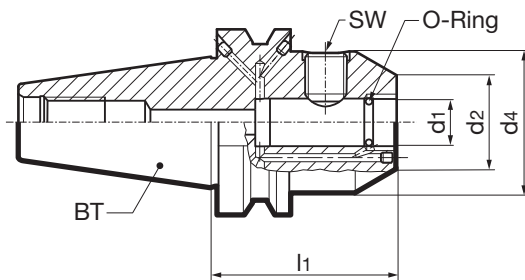

Article no.

4234

BT	d1 H5 mm	d2 mm	d4 mm	l1 mm	SW mm	Order no.
BT 30	6	15	25	50	3	4234 6.030
BT 30	8	20	28	50	4	4234 8.030
BT 30	10	25	35	50	5	4234 10.030
BT 30	12	30	42	50	6	4234 12.030
BT 30	14	32	44	50	6	4234 14.030
BT 30	16	36	48	63	6	4234 16.030
BT 30	18	38	50	63	6	4234 18.030
BT 30	20	40	52	63	8	4234 20.030
BT 40	6	15	25	50	3	4234 6.040
BT 40	8	20	28	50	4	4234 8.040
BT 40	10	25	35	63	5	4234 10.040
BT 40	12	30	42	63	6	4234 12.040
BT 40	14	32	44	63	6	4234 14.040
BT 40	16	36	48	63	6	4234 16.040
BT 40	18	38	50	63	6	4234 18.040
BT 40	20	40	52	63	8	4234 20.040
BT 40	25	45	63	90	10	4234 25.040
BT 40	32	56	72	100	10	4234 32.040
BT 40	6	15	25	100	3	4234 106.040
BT 40	8	20	28	100	4	4234 108.040
BT 40	10	25	35	100	5	4234 110.040
BT 40	12	30	42	100	6	4234 112.040
BT 40	14	32	44	100	6	4234 114.040
BT 40	16	36	48	100	6	4234 116.040
BT 40	18	38	50	100	6	4234 118.040
BT 40	20	40	52	100	8	4234 120.040
BT 40	16	36	45	35	6	4234 916.040
BT 40	20	40	45	35	8	4234 920.040
BT 40	25	45	45	35	10	4234 925.040

Side lock holders



MAS/BT Whistle Notch side lock holders

Article no. 4233



Product information:

- MAS/BT to DIN ISO 7388-2 Form JD/JF
- with mounting hole DIN 1835-2, Form E „Whistle Notch“
- balancing quality: G 6.3 / 15,000 rpm
- missing dimensions according to DIN 69895
- from holder d1 = 25 mm with 2 clamping screws, art. no. 4903

Scope of delivery:

- incl. clamping screw art. no. 4903 and adjusting screw

suitable accessories separately available:

- replacement clamping screw, art. no. 4903
- BT pull studs art. nr. 4927, 4928

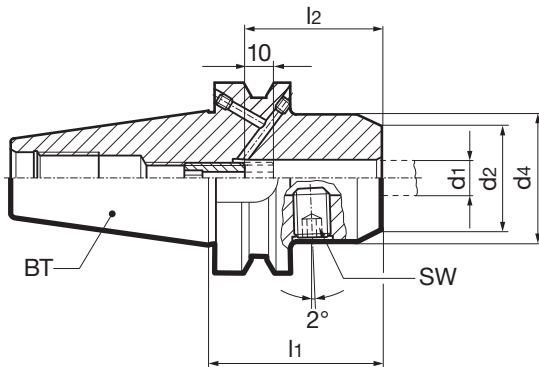

Article no.

4233

BT	d1 H5 mm	d2 mm	d4 mm	l1 mm	l2 mm	SW mm	Order no.
BT 40	6	15	25	50	36	3	4233 6.040
BT 40	8	20	28	50	36	4	4233 8.040
BT 40	10	25	35	63	40	5	4233 10.040
BT 40	12	30	42	63	45	6	4233 12.040
BT 40	14	32	44	63	45	6	4233 14.040
BT 40	16	36	48	63	48	6	4233 16.040
BT 40	18	38	50	63	48	6	4233 18.040
BT 40	20	40	52	63	50	8	4233 20.040
BT 40	25	45	63	90	56	10	4233 25.040
BT 40	32	56	72	100	60	10	4233 32.040
BT 50	6	15	25	63	36	3	4233 6.050
BT 50	8	20	28	63	36	4	4233 8.050
BT 50	10	25	35	63	40	5	4233 10.050
BT 50	12	30	42	80	45	6	4233 12.050
BT 50	14	32	44	80	45	6	4233 14.050
BT 50	16	36	48	80	48	6	4233 16.050
BT 50	18	38	50	80	48	6	4233 18.050
BT 50	20	40	52	80	50	8	4233 20.050
BT 50	25	45	65	100	56	10	4233 25.050
BT 50	32	56	72	105	60	10	4233 32.050



Clamping screws

Article no. **4903**

Product information:

- for side lock holders with hole to DIN 1835-2, B and E, and HSK-A adaptors for tapping chucks, art. nos. 4317/4322/4329/4333/4334/4343
- art. no. 4903 12.001 (M12) only for art. no. 4343
- minimum order quantity 5 units

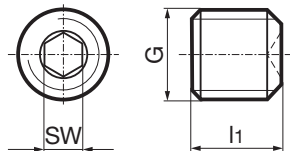

Article no.

4903

Ø-range	G	l1 mm	Torque Nm	SW mm	Order no.
6	M 6	10	5	3	4903 6.000
8	M 8	10	10	4	4903 8.000
10	M10	12	15	5	4903 10.000
12/14	M12	14	28	6	4903 12.000
25	M12	12	28	6	4903 12.001
16/18	M14	16	42	6	4903 14.000
25	M14	11	42	6	4903 14.001
20	M16	16	50	8	4903 16.000
25	M16	12	50	8	4903 16.001
25	M18X2	20	60	10	4903 18.000
32/40	M20X2	20	72	10	4903 20.000
40	M20X2	25	72	10	4903 20.001



Adjusting screws

Article no. **4904**

Product information:

- for side lock holders HSK-A with mounting hole DIN 1835–2, form E, shrink fit chuck and shrink fit extension
- minimum order quantity 5 units

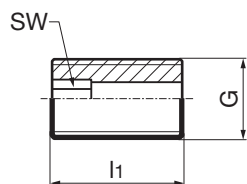
Article no. **4904**

G	l1 mm	SW mm	Order no.
M 5	5	2.5	4904 5.005
M 5	7	2.5	4904 5.007
M 5	16	2.5	4904 5.016
M 5	20	2.5	4904 5.020
M 6	7	3.0	4904 6.007
M 6	16	3.0	4904 6.016
M 6	20	3.0	4904 6.020
M 8	12	3.0	4904 8.012
M 8	18	4.0	4904 8.018
M10	17	3.0	4904 10.017
M10	20	5.0	4904 10.020
M12	14	3.0	4904 12.014
M12	20	5.0	4904 12.020
M16	25	5.0	4904 16.025
M20	25	6.0	4904 20.025



Adjusting screws

Article no. **4905**

Product information:

- for HSK-C side lock holders with hole according to DIN 1835-2, form E, art. nos. 4333 / 4322
- minimum order quantity 5 units

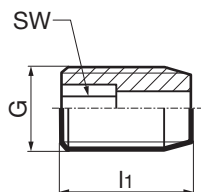

Article no.

4905

G	l1 mm	SW mm	Order no.
M 5	14	2.5	4905 5.014
M 5	16	2.5	4905 5.016
M 6	14	3.0	4905 6.014
M 6	16	3.0	4905 6.016
M 8	15	4.0	4905 8.015
M 8	17	4.0	4905 8.017
M10	17	5.0	4905 10.017
M10	20	5.0	4905 10.020
M12	19	6.0	4905 12.019
M12	22	6.0	4905 12.022
M16	20	6.0	4905 16.020
M20	26	6.0	4905 20.026



HSK-A collet holders

Article no. 4304



Product information:

- HSK-A according to ISO 12164-1 / DIN 69893-1
- for collet chuck holders with adjustment angle 8° to DIN ISO 15488
- balancing quality: G 2.5 / 25,000 rpm
or rev. < 1 gmm

Scope of delivery:

- clamping nut art. no. 4306
- adjusting screw (1) art. no. 4902

suitable accessories separately available:

- replacement IC/ER clamping nut, art. no. 4306
- replacement adjusting screw (1), art. no. 4902
- collet art. no. 4307
- clamping key art. no. 4913
- coolant supply set art. no. 4949

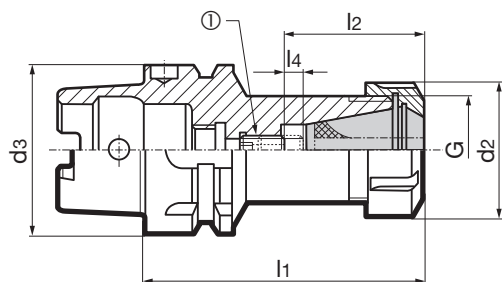

Article no.

4304

d3	Size	f. clamp. range	d2 mm	G	l1 mm	l2 mm	l4 mm	①	Order no.
HSK-A 32	ER11	1.0-7.0	19	M14 X0.75	55	25	6	4902 11.012	4304 11.032
HSK-A 32	ER16	1.0-10.0	28	M22 X1.5	80	34	6	4902 16.012	4304 16.032
HSK-A 32	ER20	3.0-13.0	34	M25 X1.5	70	40	6	4902 16.012	4304 20.032
HSK-A 40	ER16	1.0-10.0	28	M22 X1.5	80	34	6	4902 16.012	4304 16.040
HSK-A 40	ER25	2.0-16.0	42	M32 X1.5	80	44	6	4902 25.014	4304 25.040
HSK-A 40	ER32	3.0-20.0	50	M40 X1.5	100	50	10	4902 32.020	4304 32.040
HSK-A 50	ER16	1.0-10.0	28	M22 X1.5	100	34	6	4902 16.012	4304 16.050
HSK-A 50	ER25	2.0-16.0	42	M32 X1.5	80	44	6	4902 25.014	4304 25.050
HSK-A 50	ER25	2.0-16.0	42	M32 X1.5	100	44	6	4902 25.014	4304 25.150
HSK-A 50	ER32	3.0-20.0	50	M40 X1.5	100	50	10	4902 32.020	4304 32.050
HSK-A 63	ER16	1.0-10.0	28	M22 X1.5	100	34	6	4902 16.012	4304 16.063
HSK-A 63	ER16	1.0-10.0	28	M22 X1.5	160	34	6	4902 16.012	4304 16.163
HSK-A 63	ER25	2.0-16.0	42	M32 X1.5	80	42	6	4902 25.014	4304 25.063
HSK-A 63	ER25	2.0-16.0	42	M32 X1.5	100	42	6	4902 25.014	4304 25.163
HSK-A 63	ER32	3.0-20.0	50	M40 X1.5	100	50	10	4902 32.020	4304 32.063
HSK-A 63	ER40	3.0-26.0	63	M50 X1.5	120	56	10	4902 32.020	4304 40.063
HSK-A 80	ER32	3.0-20.0	50	M40 X1.5	100	50	10	4902 32.020	4304 32.080
HSK-A 80	ER32	3.0-20.0	50	M40 X1.5	160	50	10	4902 32.020	4304 32.180
HSK-A 80	ER40	3.0-26.0	63	M50 X1.5	120	56	10	4902 32.020	4304 40.080
HSK-A 100	ER32	3.0-20.0	50	M40 X1.5	100	50	10	4902 32.020	4304 32.100
HSK-A 100	ER32	3.0-20.0	50	M40 X1.5	160	50	10	4902 32.020	4304 32.101
HSK-A 100	ER40	3.0-26.0	63	M50 X1.5	120	56	10	4902 32.020	4304 40.100



HSK-A collet holders, sealed version

Article no. **4324**



Product information:

- HSK-A according to ISO 12164-1 / DIN 69893-1
- for collet chuck holders with adjustment angle 8° to DIN ISO 15488
- balancing quality: G 2.5 / 25,000 rpm or rev. < 1 gmm
- sealed, suitable for coolant pressure up to 100 bar thanks to the application of IC clamping nuts and suitable sealing disks

Scope of delivery:

- IC clamping nut, art. no. 4306
- adjusting screw (1) art. no. 4902

suitable accessories separately available:

- collet art. no. 4307
- sealing plug art. no. 4335
- clamping key art. no. 4913
- coolant supply set art. no. 4949
- replacement IC/ER clamping nut, art. no. 4306
- replacement adjusting screw (1), art. no. 4902

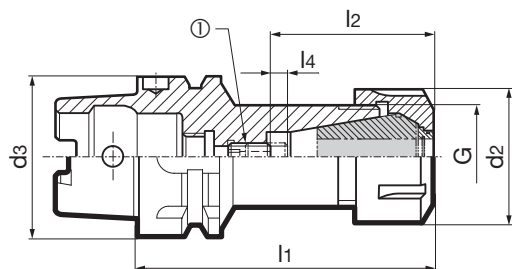

Article no.

4324

d3	Size	Ø-range	d2 mm	G	l1 mm	l2 mm	l4 mm	①	Order no.
HSK-A 32	ER16	0.5-10,0	28	M22 X1.5	85	39	6	4902 16.012	4324 16.032
HSK-A 32	ER20	0.5-13,0	34	M25 X1.5	75	45	6	4902 16.012	4324 20.032
HSK-A 40	ER16	0.5-10,0	28	M22 X1.5	85	39	6	4902 16.012	4324 16.040
HSK-A 40	ER25	0.5-16,0	42	M32 X1.5	85	49	6	4902 25.014	4324 25.040
HSK-A 40	ER32	1.0-20,0	50	M40 X1.5	105	55	10	4902 32.020	4324 32.040
HSK-A 50	ER16	0.5-10,0	28	M22 X1.5	105	39	6	4902 16.012	4324 16.050
HSK-A 50	ER25	0.5-16,0	42	M32 X1.5	85	49	6	4902 25.014	4324 25.050
HSK-A 50	ER25	0.5-16,0	42	M32 X1.5	105	49	6	4902 25.014	4324 25.150
HSK-A 50	ER32	1.0-20,0	50	M40 X1.5	105	55	10	4902 32.020	4324 32.050
HSK-A 63	ER16	0.5-10,0	28	M22 X1.5	105	39	6	4902 16.012	4324 16.063
HSK-A 63	ER16	0.5-10,0	28	M22 X1.5	165	39	6	4902 16.012	4324 16.163
HSK-A 63	ER25	0.5-16,0	42	M32 X1.5	85	47	6	4902 25.014	4324 25.063
HSK-A 63	ER25	0.5-16,0	42	M32 X1.5	105	47	6	4902 25.014	4324 25.163
HSK-A 63	ER32	1.0-20,0	50	M40 X1.5	105	55	10	4902 32.020	4324 32.063
HSK-A 63	ER40	3.0-26.0	63	M50 X1.5	125	61	10	4902 32.020	4324 40.063
HSK-A 80	ER32	1.0-20,0	50	M40 X1.5	105	55	10	4902 32.020	4324 32.080
HSK-A 80	ER32	1.0-20,0	50	M40 X1.5	165	55	10	4902 32.020	4324 32.180
HSK-A 80	ER40	3.0-26.0	63	M50 X1.5	125	61	10	4902 32.020	4324 40.080
HSK-A 100	ER32	1.0-20,0	50	M40 X1.5	105	55	10	4902 32.020	4324 32.100
HSK-A 100	ER32	1.0-20,0	50	M40 X1.5	165	55	10	4902 32.020	4324 32.101
HSK-A 100	ER40	3.0-26.0	63	M50 X1.5	125	61	10	4902 32.020	4324 40.100



HSK-C collet holders

Article no. 4303



Product information:

- HSK-C according to ISO 12164-1/DIN 69893-1
- for collet chuck holders with adjustment angle 8° to DIN ISO 15488
- balancing quality: G 2.5 / 25,000 rpm
or rev. < 1 gmm

Scope of delivery:

- clamping nut art. no. 4306
- adjusting screw (1) art. no. 4901

suitable accessories separately available:

- collet art. no. 4307
- clamping key art. no. 4913
- replacement IC/ER clamping nut, art. no. 4306
- replacement adjusting screw (1), art. no. 4901

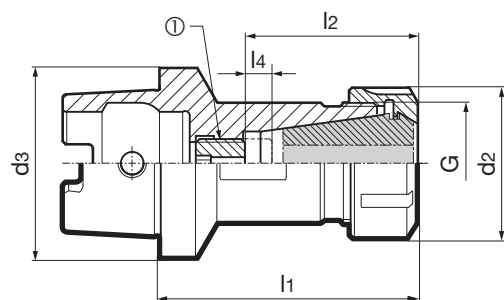

Article no.

4303

d3	Size	Ø-range	d2 mm	G	l1 mm	l2 mm	l4 mm	①	Order no.
HSK-C 25	ER16MINI	0,5-10,0	22	M19 x 1	50	30	3	4901 16.012	4303 16.025
HSK-C 32	ER16	0,5-10,0	28	M22 X1.5	55	32	4	4901 16.012	4303 16.032
HSK-C 32	ER20	0,5-13,0	34	M25 X1.5	60	38	6	4901 16.012	4303 20.032
HSK-C 32	ER25	0,5-16,0	42	M32 X1.5	70	44	6	4901 25.014	4303 25.032
HSK-C 40	ER20	0,5-13,0	34	M25 X1.5	60	38	6	4901 16.012	4303 20.040
HSK-C 40	ER25	0,5-16,0	42	M32 X1.5	70	44	8	4901 25.014	4303 25.040
HSK-C 40	ER32	1,0-20,0	50	M40 X1.5	75	49	8	4901 25.014	4303 32.040
HSK-C 50	ER16	0,5-10,0	28	M22 X1.5	60	34	6	4901 16.012	4303 16.050
HSK-C 50	ER25	0,5-16,0	42	M32 X1.5	70	44	8	4901 25.014	4303 25.050
HSK-C 50	ER32	1,0-20,0	50	M40 X1.5	75	49	8	4901 25.014	4303 32.050
HSK-C 50	ER40	3,0-26,0	63	M50 X1.5	80	54	8	4901 25.014	4303 40.050
HSK-C 63	ER40	3,0-26,0	63	M50 X1.5	80	54	8	4901 25.014	4303 40.063



HSK-C collet holders, sealed version

Article no. **4323**

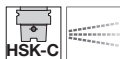

Product information:

- HSK-C according to ISO 12164-1/DIN 69893-1
- for collet chuck holders with adjustment angle 8° to DIN ISO 15488
- balancing quality: G 2.5 / 25,000 rpm or rev. < 1 gmm
- sealed, suitable for coolant pressure up to 100 bar thanks to the application of IC clamping nuts and suitable sealing disks

Scope of delivery:

- adjusting screw (1) art. no. 4901
- IC clamping nut, art. no. 4306

suitable accessories separately available:

- collet art. no. 4307
- sealing plug art. no. 4335
- clamping key art. no. 4913
- replacement adjusting screw (1), art. no. 4901
- replacement IC/ER clamping nut, art. no. 4306

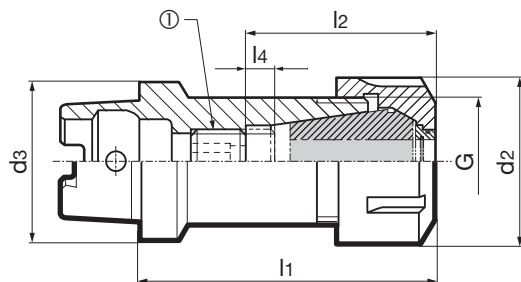

Article no.

4323

d3	Size	Ø-range	d2 mm	G	l1 mm	l2 mm	l4 mm	①	Order no.
HSK-C 25	ER16MINI	0,5-10,0	22	M19 x 1	55	35	3	4901 16.012	4323 16.025
HSK-C 32	ER16	0,5-10,0	28	M22 X1.5	60	37	4	4901 16.012	4323 16.032
HSK-C 32	ER20	0,5-13,0	34	M25 X1.5	65	43	6	4901 16.012	4323 20.032
HSK-C 32	ER25	0,5-16,0	42	M32 X1.5	75	49	6	4901 25.014	4323 25.032
HSK-C 40	ER20	0,5-13,0	34	M25 X1.5	65	43	6	4901 16.012	4323 20.040
HSK-C 40	ER25	0,5-16,0	42	M32 X1.5	75	49	8	4901 25.014	4323 25.040
HSK-C 40	ER32	1,0-20,0	50	M40 X1.5	80	54	8	4901 25.014	4323 32.040
HSK-C 50	ER16	0,5-10,0	28	M22 X1.5	65	39	6	4901 16.012	4323 16.050
HSK-C 50	ER25	0,5-16,0	42	M32 X1.5	75	49	8	4901 25.014	4323 25.050
HSK-C 50	ER32	1,0-20,0	50	M40 X1.5	80	54	8	4901 25.014	4323 32.050
HSK-C 50	ER40	3,0-26,0	63	M50 X1.5	85	59	8	4901 25.014	4323 40.050
HSK-C 63	ER40	3,0-26,0	63	M50 X1.5	85	59	8	4901 25.014	4323 40.063



HSK-E collet holders

Article no. 4397



Product information:

- HSK-E according to DIN 69893-5 with access hole in taper for manual tool change
- for collet chuck holders with adjustment angle 8° to DIN ISO 15488
- balancing quality: G 2.5 / 25,000 rpm or rev. < 1 gmm
- code no. 16.025 without length adjustment and central cooling
- incl. spanner flat for locking during clamping

Scope of delivery:

- clamping nut art. no. 4306
- adjusting screw (1) art. no. 4902

suitable accessories separately available:

- collet art. no. 4307
- clamping key art. no. 4913
- coolant supply set art. no. 4949
- replacement IC/ER clamping nut, art. no. 4306
- replacement adjusting screw (1), art. no. 4902

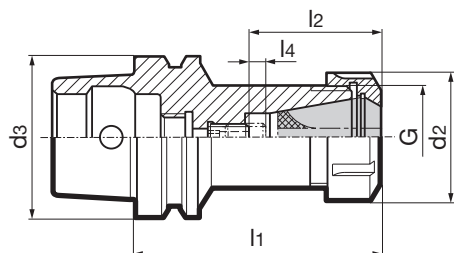

Article no.

4397

d3	Size	Ø-range	d2 mm	G	l1 mm	l2 mm	l4 mm	①	Order no.
HSK-E 25	ER16MINI	1.0-10.0	22	M19 x 1	43				4397 16.025
HSK-E 32	ER16MINI	1.0-10.0	22	M19 x 1	60	34	4	4902 16.010	4397 16.032
HSK-E 32	ER20MINI	1.0-13.0	28	M24 x 1	60	34	4	4902 16.010	4397 20.032
HSK-E 40	ER16	1.0-10.0	28	M22 X1.5	60	32	4	4902 16.010	4397 16.040
HSK-E 40	ER20MINI	1.0-13.0	28	M24 x 1	65	37	6	4902 16.010	4397 20.040
HSK-E 40	ER25MINI	2.0-16.0	35	M30 x 1	80	44	8	4902 25.014	4397 25.040
HSK-E 50	ER16	1.0-10.0	28	M22 X1.5	100	34	6	4902 16.012	4397 16.050
HSK-E 50	ER20	1.0-13.0	34	M25 X1.5	70	38	6	4902 16.010	4397 20.050
HSK-E 50	ER25	2.0-16.0	42	M32 X1.5	80	44	8	4902 25.014	4397 25.050
HSK-E 50	ER32	3.0-20.0	50	M40 X1.5	100	50	10	4902 32.020	4397 32.050
HSK-E 63	ER32	3.0-20.0	50	M40 X1.5	90	50	10	4902 25.014	4397 32.063
HSK-E 63	ER40	4.0-26.0	63	M50 X1.5	120	56	10	4902 32.020	4397 40.063



Product information:

- ISO taper to DIN ISO 7388-1 form AD/AF
- balancing quality: G 6.3 / 15,000 rpm
- for collet chuck holders with adjustment angle 8° to DIN ISO 15488

Scope of delivery:

- incl. clamping nut

suitable accessories separately available:

- collet art. no. 4307
- clamping key art. no. 4913
- ISO pull studs art. no. 4925, 4926

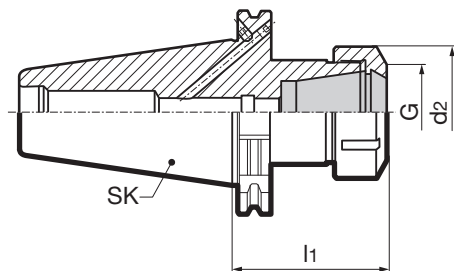

Article no. **4827**

SK	Size	Ø-range	d2 mm	G	l1 mm	Order no.
SK 40	ER16	0,5-10,0	32	M22X1,5	63	4827 16.040
SK 40	ER16	0,5-10,0	32	M22X1,5	160	4827 16.140
SK 40	ER16	0,5-10,0	32	M22X1,5	130	4827 16.240
SK 40	ER25	0,5-16,0	42	M32X1,5	60	4827 25.040
SK 40	ER25	0,5-16,0	42	M32X1,5	160	4827 25.140
SK 40	ER25	0,5-16,0	42	M32X1,5	130	4827 25.240
SK 40	ER32	1,0-20,0	50	M40X1,5	70	4827 32.040
SK 40	ER32	1,0-20,0	50	M40X1,5	160	4827 32.140
SK 40	ER32	1,0-20,0	50	M40X1,5	130	4827 32.240
SK 40	ER40	3,0-26,0	63	M50X1,5	80	4827 40.040
SK 40	ER40	3,0-26,0	63	M50X1,5	130	4827 40.240
SK 40	ER16MINI	0,5-10,0	22	M19X1	100	4827 116.040
SK 40	ER16MINI	0,5-10,0	22	M19X1	130	4827 216.040
SK 40	ER16MINI	0,5-10,0	22	M19X1	160	4827 316.040
SK 50	ER16	0,5-10,0	32	M22X1,5	70	4827 16.050
SK 50	ER16	0,5-10,0	32	M22X1,5	130	4827 16.250
SK 50	ER25	0,5-16,0	42	M32X1,5	60	4827 25.050
SK 50	ER25	0,5-16,0	42	M32X1,5	160	4827 25.150
SK 50	ER25	0,5-16,0	42	M32X1,5	130	4827 25.250
SK 50	ER32	1,0-20,0	50	M40X1,5	70	4827 32.050
SK 50	ER32	1,0-20,0	50	M40X1,5	130	4827 32.250
SK 50	ER40	3,0-26,0	63	M50X1,5	80	4827 40.050
SK 50	ER40	3,0-26,0	63	M50X1,5	160	4827 40.150
SK 50	ER40	3,0-26,0	63	M50X1,5	130	4827 40.250
SK 50	ER16MINI	0,5-10,0	22	M19x1	100	4827 116.050
SK 50	ER16MINI	0,5-10,0	22	M19x1	130	4827 216.050
SK 50	ER16MINI	0,5-10,0	22	M19x1	160	4827 316.050



MAS/BT collet holders

Article no. 4245



Product information:

- MAS/BT according to DIN ISO 7388-2 form JD/JF
- balancing quality: G 6.3 / 15,000 rpm
- coolant supply form JD/JF (* BT30 version JD without coolant supply over collar without GÜHROJET)
- for collet chuck holders with adjustment angle 8° to DIN ISO 15488

Scope of delivery:

- incl. clamping nut

suitable accessories separately available:

- collet art. no. 4307
- clamping key art. no. 4913
- BT pull studs art. nr. 4927, 4928
- BT-50 on request

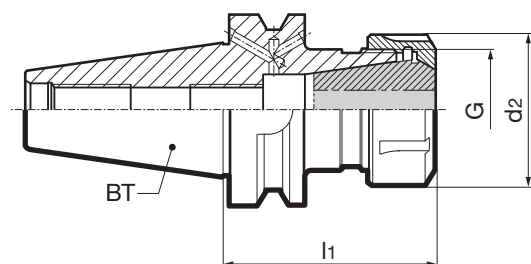

Article no.

4245

BT	Size	Ø-range	d2 mm	G	l1 mm	Order no.
BT 30	ER16	0,5-10,0	32	M22 X1.5	70	4245 16.030
BT 30	ER25	0,5-16,0	42	M32 X1.5	70	4245 25.030
BT 40	ER16	0,5-10,0	32	M22 X1.5	63	4245 16.040
BT 40	ER16	0,5-10,0	32	M22 X1.5	160	4245 16.140
BT 40	ER25	0,5-16,0	42	M32 X1.5	60	4245 25.040
BT 40	ER25	0,5-16,0	42	M32 X1.5	160	4245 25.140
BT 40	ER32	1,0-20,0	50	M40 X1.5	70	4245 32.040
BT 40	ER32	1,0-20,0	50	M40 X1.5	160	4245 32.140



Clamping keys

Article no. **4913**

Product information:

- for clamping nuts
- type A: Special hook wrench for clamping nut system DIN 6499 mini design
- type B for clamping nuts with hexagonal design
- type C for clamping nuts for external slots

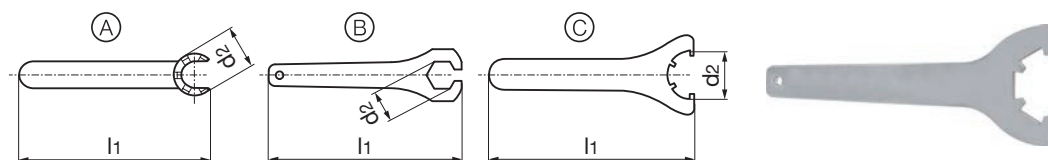

Article no.

4913

Nominal size	l1 mm	for ER d2 mm	Type	Order no.
ER20MINI	139	28	A	4913 20.200
ER16MINI	122	22	A	4913 16.200
ER25MINI	143	35	A	4913 25.200
ER20	200	34	B	4913 20.000
ER11	141	19	B	4913 11.000
ER16	178	28	B	4913 16.000
ER20	183	35	C	4913 20.100
ER16	163	32	C	4913 16.032
ER25	210	42	C	4913 25.000
ER32	250	50	C	4913 32.000
ER40	290	63	C	4913 40.000



Adjusting screws for HSK-A/HSK-E collet chucks holders

Article no. **4902**

Product information:

- for dimensions without d1 the screw is designed without spigot

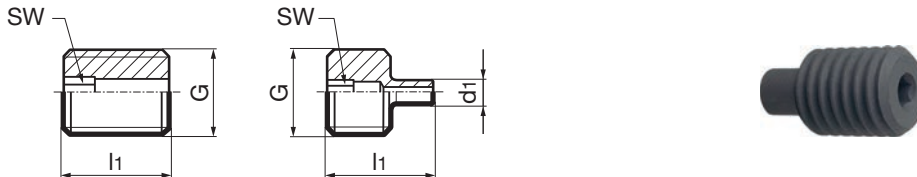

Article no.

4902

Size	Ø-range	G	d1 mm	l1 mm	SW mm	Order no.
ER11	1-7	M6		12	3.0	4902 11.012
ER16	6-10	M10		10	3.0	4902 16.010
ER16	6-10	M10		12	3.0	4902 16.012
ER16	1,2-6	M10	3.5	18	3.0	4902 16.018
ER20	6-10	M10	5.5	18	3.0	4902 20.018
ER20	2,5-6	M10	4.5	24	3.0	4902 20.024
ER25	10-16	M16		14	4.0	4902 25.014
ER25	7-10	M16	6.5	20	4.0	4902 25.020
ER25	3-7	M16	4.5	26	4.0	4902 25.026
ER32	16-20	M16		20	5.0	4902 32.020
ER32	10-16	M16	9.5	28	5.0	4902 32.028
ER32	3-10	M16	6.5	36	5.0	4902 32.036
ER40	3-8	M16	6.5	44	5.0	4902 40.044



Adjusting screws for HSK-C collet chuck holders

Article no. **4901**

Product information:

- for dimensions without d1 the screw is designed without spigot

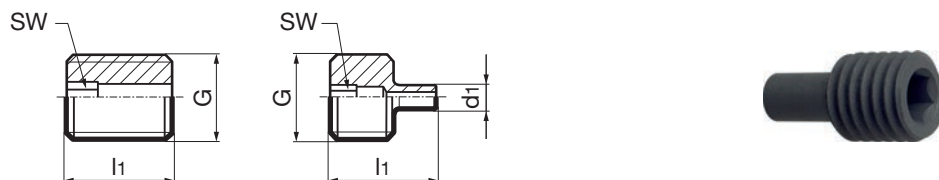

Article no.

4901

Size	f. clamp. range	G	d1 mm	l1 mm	SW mm	Order no.
ER16	0,5-10,0	M10		12	3.0	4901 16.012
ER16	0,5-10,0	M10	3.5	16	3.0	4901 16.016
ER20	0,5-13,0	M10	5.5	16	3.0	4901 20.016
ER20	0,5-13,0	M10	4.5	20	3.0	4901 20.020
ER25	0,5-16,0	M16		14	4.0	4901 25.014
ER25	0,5-16,0	M16	6.5	20	4.0	4901 25.020
ER25	0,5-16,0	M16	4.5	26	4.0	4901 25.026
ER32	0,5-20,0	M16	9.5	20	5.0	4901 32.020
ER32	0,5-20,0	M16	6.5	26	5.0	4901 32.026
ER40	0,5-20,0	M16	6.5	32	5.0	4901 32.032
ER40	0,5-26,0	M16	6.5	38	5.0	4901 40.038



Collets DIN ISO 15488

Article no. 4307

Product information:

- The clamping range of collet, art. no. 4307, is to be applied as indicated. For intermediate sizes as i.e. for \varnothing 6.3 mm (nom. size ER20) order collet d1 = 7.0 mm - 6.0 mm (code no. 07.020).
- concentricity < 10 μ m

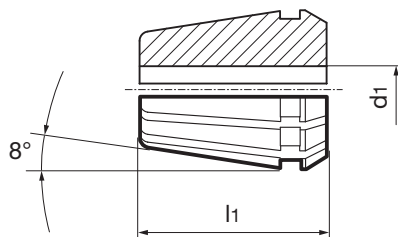

Article no.

4307

Size	d1	l1 mm	Order no.
ER11	1.0-0.5	18.0	4307 1.011
ER11	1.5-1.0	18.0	4307 1.511
ER11	2.0-1.5	18.0	4307 2.011
ER11	2.5-2.0	18.0	4307 2.511
ER11	3.0-2.5	18.0	4307 3.011
ER11	4.0-3.5	18.0	4307 4.011
ER11	5.0-4.5	18.0	4307 5.011
ER11	6.0-5.5	18.0	4307 6.011
ER11	7.0-6.5	18.0	4307 7.011
ER16	1.0-0.5	27.5	4307 1.016
ER16	1.5-1.0	27.5	4307 1.516
ER16	2.0-1.0	27.5	4307 2.016
ER16	2.5-1.5	27.5	4307 2.516
ER16	3.0-2.0	27.5	4307 3.016
ER16	4.0-3.0	27.5	4307 4.016
ER16	5.0-4.0	27.5	4307 5.016
ER16	6.0-5.0	27.5	4307 6.016
ER16	7.0-6.0	27.5	4307 7.016
ER16	8.0-7.0	27.5	4307 8.016
ER16	9.0-8.0	27.5	4307 9.016
ER16	10.0-9.0	26.0	4307 10.016
ER20	1.0-0.5	31.5	4307 1.020
ER20	1.5-1.0	31.5	4307 1.520
ER20	2.0-1.0	31.5	4307 2.020
ER20	2.5-1.5	31.5	4307 2.520
ER20	3.0-2.0	31.5	4307 3.020
ER20	4.0-3.0	31.5	4307 4.020
ER20	5.0-4.0	31.5	4307 5.020
ER20	6.0-5.0	31.5	4307 6.020
ER20	7.0-6.0	31.5	4307 7.020
ER20	8.0-7.0	31.5	4307 8.020
ER20	9.0-8.0	31.5	4307 9.020
ER20	10.0-9.0	31.5	4307 10.020
ER20	11.0-10.0	31.5	4307 11.020
ER20	12.0-11.0	31.5	4307 12.020
ER20	13.0-12.0	31.5	4307 13.020
ER25	1.0-0.5	34.0	4307 1.025
ER25	1.5-1.0	34.0	4307 1.525
ER25	2.0-1.0	34.0	4307 2.025
ER25	2.5-1.5	34.0	4307 2.525
ER25	3.0-2.0	34.0	4307 3.025
ER25	4.0-3.0	34.0	4307 4.025
ER25	5.0-4.0	34.0	4307 5.025
ER25	6.0-5.0	34.0	4307 6.025
ER25	7.0-6.0	34.0	4307 7.025
ER25	8.0-7.0	34.0	4307 8.025
ER25	9.0-8.0	34.0	4307 9.025
ER25	10.0-9.0	34.0	4307 10.025
ER25	11.0-10.0	34.0	4307 11.025
ER25	12.0-11.0	34.0	4307 12.025
ER25	13.0-12.0	34.0	4307 13.025
ER25	14.0-13.0	34.0	4307 14.025
ER25	15.0-14.0	34.0	4307 15.025
ER25	16.0-15.0	34.0	4307 16.025



Article no.

4307

Size	d1	l1 mm	Order no.
ER32	2.0-1.0	40.0	4307 2.032
ER32	2.5-1.5	40.0	4307 2.532
ER32	3.0-2.0	40.0	4307 3.032
ER32	4.0-3.0	40.0	4307 4.032
ER32	5.0-4.0	40.0	4307 5.032
ER32	6.0-5.0	40.0	4307 6.032
ER32	7.0-6.0	40.0	4307 7.032
ER32	8.0-7.0	40.0	4307 8.032
ER32	9.0-8.0	40.0	4307 9.032
ER32	10.0-9.0	40.0	4307 10.032
ER32	11.0-10.0	40.0	4307 11.032
ER32	12.0-11.0	40.0	4307 12.032
ER32	13.0-12.0	40.0	4307 13.032
ER32	14.0-13.0	40.0	4307 14.032
ER32	15.0-14.0	40.0	4307 15.032
ER32	16.0-15.0	40.0	4307 16.032
ER32	17.0-16.0	40.0	4307 17.032
ER32	18.0-17.0	40.0	4307 18.032
ER32	19.0-18.0	40.0	4307 19.032
ER32	20.0-19.0	40.0	4307 20.032
ER40	4.0-3.0	46.0	4307 4.040
ER40	5.0-4.0	46.0	4307 5.040
ER40	6.0-5.0	46.0	4307 6.040
ER40	7.0-6.0	46.0	4307 7.040
ER40	8.0-7.0	46.0	4307 8.040
ER40	9.0-8.0	46.0	4307 9.040
ER40	10.0-9.0	46.0	4307 10.040
ER40	11.0-10.0	46.0	4307 11.040
ER40	12.0-11.0	46.0	4307 12.040
ER40	13.0-12.0	46.0	4307 13.040
ER40	14.0-13.0	46.0	4307 14.040
ER40	15.0-14.0	46.0	4307 15.040
ER40	16.0-15.0	46.0	4307 16.040
ER40	17.0-16.0	46.0	4307 17.040
ER40	18.0-17.0	46.0	4307 18.040
ER40	19.0-18.0	46.0	4307 19.040
ER40	20.0-19.0	46.0	4307 20.040
ER40	21.0-20.0	46.0	4307 21.040
ER40	22.0-21.0	46.0	4307 22.040
ER40	23.0-22.0	46.0	4307 23.040
ER40	24.0-23.0	46.0	4307 24.040
ER40	25.0-24.0	46.0	4307 25.040
ER40	26.0-25.0	46.0	4307 26.040



Collet holders ER metallic sealed

Article no. 4175

Product information:

- DIN ISO 15488
- for application without sealing washer
- concentricity < 6 µm
- for high-performance tools with internal cooling e.g. HR 500 reamers
- clamping force tester for SK/BT/CAT clamping systems in machine tool spindles
- metallic sealing up to coolant pressure of 300 bar
- ER-DM collets with restricted clamping range
- The tool must be clamped at least flush or deeper in the collet. A minimum clamping length of 2/3, as for standard collets, is not possible otherwise there would be no seal.

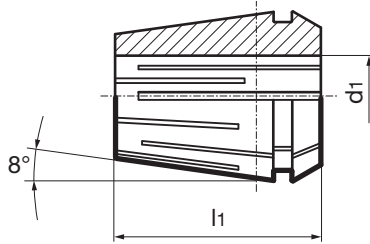

Article no.

4175

Size	d1	l1 mm	Order no.
ER20	3.00	31.5	4175 3.020
ER20	4.00	31.5	4175 4.020
ER20	5.00	31.5	4175 5.020
ER20	6.00	31.5	4175 6.020
ER20	7.00-6.50	31.5	4175 7.020
ER20	8.00-7.50	31.5	4175 8.020
ER20	9.00-8.50	31.5	4175 9.020
ER20	10.00-9.50	31.5	4175 10.020
ER20	11.00-10.50	31.5	4175 11.020
ER20	12.00-11.50	31.5	4175 12.020
ER20	13.00-12.50	31.5	4175 13.020
ER25	6.00	34.0	4175 6.025
ER25	8.00-7.50	34.0	4175 8.025
ER25	10.00-9.50	34.0	4175 10.025
ER25	12.00-11.50	34.0	4175 12.025
ER25	14.00-13.50	34.0	4175 14.025
ER25	16.00-15.50	34.0	4175 16.025
ER32	6.00	40.0	4175 6.032
ER32	8.00-7.50	40.0	4175 8.032
ER32	10.00-9.50	40.0	4175 10.032
ER32	12.00-11.50	40.0	4175 12.032
ER32	14.00-13.50	40.0	4175 14.032
ER32	16.00-15.50	40.0	4175 16.032
ER32	18.00-17.50	40.0	4175 18.032
ER32	20.00-19.50	40.0	4175 20.032



Clamping nuts, system DIN ISO 15488

Article no. **4306**

Product information:

- for collets DIN ISO 15488
- for application with internal cooling IC/ER for sealing washers
- for increased clamping version ER or IC/ER with glide ring
- suitable for up to 150 bar coolant pressure
- code xx,300 and xx,600: suitable for sealing discs, art. no. 4335, without sealing ring
- code xx,400: not suitable for sealing discs, art. no. 4335, with sealing ring
- code xx,500: suitable for sealing discs, art. no. 4335, with sealing ring
- IC/ER designs: Sealing washer, art. no. 4335

Scope of delivery:

- IC/ER versions for internal cooling

suitable accessories separately available:

- coolant-tight up to 150 bar

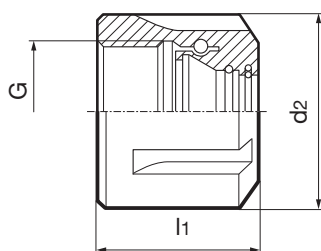

Article no. **4306**

Nominal size	d2 mm	l1 mm	G	Torque Nm	Order no.
ER 11	19	11.3	M14X0,75	24	4306 11.000
ER 16	28	17.5	M22X1,5	56	4306 16.000
ER 16	28	20.2	M22X1,5	56	4306 16.400
ER 16	28	22.7	M22X1,5	56	4306 16.500
ER 16 MINI	22	18.4	M19X1,0	24	4306 16.200
ER 20	34	19.0	M25X1,5	80	4306 20.000
ER 20	34	21.7	M25X1,5	80	4306 20.400
ER 20	34	24.2	M25X1,5	80	4306 20.500
ER 20 MINI	28	19.0	M24X1,0	28	4306 20.200
ER 25	42	22.6	M32X1,5	104	4306 25.400
ER 25	42	25.2	M32X1,5	104	4306 25.500
ER 25	42	20.0	M32X1,5	104	4306 25.000
ER 25 MINI	35	20.0	M30X1,0	32	4306 25.200
ER 32	50	22.5	M40X1,5	136	4306 32.000
ER 32	50	25.0	M40X1,5	136	4306 32.400
ER 32	50	27.4	M40X1,5	136	4306 32.500
ER 40	63	25.5	M50X1,5	176	4306 40.000
ER 40	63	28.2	M50X1,5	176	4306 40.400
ER 40	63	30.7	M50X1,5	176	4306 40.500
IC/ER 16	28	22.5	M22X1,5	56	4306 16.600
IC/ER 16 MINI	22	22.0	M19X1,0	24	4306 16.300
IC/ER 20	34	24.0	M25X1,5	80	4306 20.600
IC/ER 20 MINI	28	24.0	M24X1,0	28	4306 20.300
IC/ER 25	42	25.0	M32X1,5	104	4306 25.600
IC/ER 25 MINI	35	25.0	M30X1,0	32	4306 25.300
IC/ER 32	50	27.5	M40X1,5	136	4306 32.600
IC/ER 40	63	30.5	M50X1,5	176	4306 40.600



Sealing washers

Article no. 4335

Product information:

- The application range of the sealing ring art.-no. 78335 reaches from nom.-Ø d1 up to the next lower dimension, e.g. for Ø 6.3 mm (with nominal size ER20) a sealing ring with d1 = 6.5 mm (code-no. 06.520) must be ordered.
- for a coolant pressure up to 150 bar

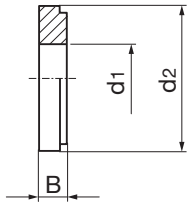

Article no.

4335

Size	d1 mm	d2 mm	B mm	Order no.
ER 16	3	13.0	4.0	4335 3.016
ER 16	3.5	13.0	4.0	4335 3.516
ER 16	4	13.0	4.0	4335 4.016
ER 16	4.5	13.0	4.0	4335 4.516
ER 16	5	13.0	4.0	4335 5.016
ER 16	5.5	13.0	4.0	4335 5.516
ER 16	6	13.0	4.0	4335 6.016
ER 16	6.5	13.0	4.0	4335 6.516
ER 16	7	13.0	4.0	4335 7.016
ER 16	7.5	13.0	4.0	4335 7.516
ER 16	8	13.0	4.0	4335 8.016
ER 16	8.5	13.0	4.0	4335 8.516
ER 16	9	13.0	4.0	4335 9.016
ER 16	9.5	13.0	4.0	4335 9.516
ER 16	10	13.0	4.0	4335 10.016
ER 20	3	16.0	4.0	4335 3.020
ER 20	3.5	16.0	4.0	4335 3.520
ER 20	4	16.0	4.0	4335 4.020
ER 20	4.5	16.0	4.0	4335 4.520
ER 20	5	16.0	4.0	4335 5.020
ER 20	5.5	16.0	4.0	4335 5.520
ER 20	6	16.0	4.0	4335 6.020
ER 20	6.5	16.0	4.0	4335 6.520
ER 20	7	16.0	4.0	4335 7.020
ER 20	7.5	16.0	4.0	4335 7.520
ER 20	8	16.0	4.0	4335 8.020
ER 20	8.5	16.0	4.0	4335 8.520
ER 20	9	16.0	4.0	4335 9.020
ER 20	9.5	16.0	4.0	4335 9.520
ER 20	10	16.0	4.0	4335 10.020
ER 20	10.5	16.0	4.0	4335 10.520
ER 20	11	16.0	4.0	4335 11.020
ER 20	11.5	16.0	4.0	4335 11.520
ER 20	12	16.0	4.0	4335 12.020
ER 20	12.5	16.0	4.0	4335 12.520
ER 20	13	16.0	4.0	4335 13.020
ER 25	3	21.0	4.0	4335 3.025
ER 25	3.5	21.0	4.0	4335 3.525
ER 25	4	21.0	4.0	4335 4.025
ER 25	4.5	21.0	4.0	4335 4.525
ER 25	5	21.0	4.0	4335 5.025
ER 25	5.5	21.0	4.0	4335 5.525
ER 25	6	21.0	4.0	4335 6.025
ER 25	6.5	21.0	4.0	4335 6.525
ER 25	7	21.0	4.0	4335 7.025
ER 25	7.5	21.0	4.0	4335 7.525
ER 25	8	21.0	4.0	4335 8.025
ER 25	8.5	21.0	4.0	4335 8.525
ER 25	9	21.0	4.0	4335 9.025
ER 25	9.5	21.0	4.0	4335 9.525
ER 25	10	21.0	4.0	4335 10.025
ER 25	10.5	21.0	4.0	4335 10.525
ER 25	11	21.0	4.0	4335 11.025
ER 25	11.5	21.0	4.0	4335 11.525

Collet holders



Article no.

4335

Size	d1 mm	d2 mm	B mm	Order no.
ER 25	12	21.0	4.0	4335 12.025
ER 25	12.5	21.0	4.0	4335 12.525
ER 25	13	21.0	4.0	4335 13.025
ER 25	13.5	21.0	4.0	4335 13.525
ER 25	14	21.0	4.0	4335 14.025
ER 25	14.5	21.0	4.0	4335 14.525
ER 25	15	21.0	4.0	4335 15.025
ER 25	15.5	21.0	4.0	4335 15.525
ER 25	16	21.0	4.0	4335 16.025
ER 32	3	27.0	4.0	4335 3.032
ER 32	3.5	27.0	4.0	4335 3.532
ER 32	4	27.0	4.0	4335 4.032
ER 32	4.5	27.0	4.0	4335 4.532
ER 32	5	27.0	4.0	4335 5.032
ER 32	5.5	27.0	4.0	4335 5.532
ER 32	6	27.0	4.0	4335 6.032
ER 32	6.5	27.0	4.0	4335 6.532
ER 32	7	27.0	4.0	4335 7.032
ER 32	7.5	27.0	4.0	4335 7.532
ER 32	8	27.0	4.0	4335 8.032
ER 32	8.5	27.0	4.0	4335 8.532
ER 32	9	27.0	4.0	4335 9.032
ER 32	9.5	27.0	4.0	4335 9.532
ER 32	10	27.0	4.0	4335 10.032
ER 32	10.5	27.0	4.0	4335 10.532
ER 32	11	27.0	4.0	4335 11.032
ER 32	11.5	27.0	4.0	4335 11.532
ER 32	12	27.0	4.0	4335 12.032
ER 32	12.5	27.0	4.0	4335 12.532
ER 32	13	27.0	4.0	4335 13.032
ER 32	13.5	27.0	4.0	4335 13.532
ER 32	14	27.0	4.0	4335 14.032
ER 32	14.5	27.0	4.0	4335 14.532
ER 32	15	27.0	4.0	4335 15.032
ER 32	15.5	27.0	4.0	4335 15.532
ER 32	16	27.0	4.0	4335 16.032
ER 32	16.5	27.0	4.0	4335 16.532
ER 32	17	27.0	4.0	4335 17.032
ER 32	17.5	27.0	4.0	4335 17.532
ER 32	18	27.0	4.0	4335 18.032
ER 32	18.5	27.0	4.0	4335 18.532
ER 32	19	27.0	4.0	4335 19.032
ER 32	19.5	27.0	4.0	4335 19.532
ER 32	20	27.0	4.0	4335 20.032
ER 40	3.5	33.5	4.0	4335 3.540
ER 40	4	33.5	4.0	4335 4.040
ER 40	4.5	33.5	4.0	4335 4.540
ER 40	5	33.5	4.0	4335 5.040
ER 40	5.5	33.5	4.0	4335 5.540
ER 40	6	33.5	4.0	4335 6.040
ER 40	6.5	33.5	4.0	4335 6.540
ER 40	7	33.5	4.0	4335 7.040
ER 40	7.5	33.5	4.0	4335 7.540
ER 40	8	33.5	4.0	4335 8.040
ER 40	8.5	33.5	4.0	4335 8.540
ER 40	9	33.5	4.0	4335 9.040
ER 40	9.5	33.5	4.0	4335 9.540
ER 40	10	33.5	4.0	4335 10.040
ER 40	10.5	33.5	4.0	4335 10.540
ER 40	11	33.5	4.0	4335 11.040
ER 40	11.5	33.5	4.0	4335 11.540
ER 40	12	33.5	4.0	4335 12.040
ER 40	12.5	33.5	4.0	4335 12.540
ER 40	13	33.5	4.0	4335 13.040
ER 40	13.5	33.5	4.0	4335 13.540
ER 40	14	33.5	4.0	4335 14.040
ER 40	14.5	33.5	4.0	4335 14.540
ER 40	15	33.5	4.0	4335 15.040
ER 40	15.5	33.5	4.0	4335 15.540
ER 40	16	33.5	4.0	4335 16.040
ER 40	16.5	33.5	4.0	4335 16.540
ER 40	17	33.5	4.0	4335 17.040
ER 40	17.5	33.5	4.0	4335 17.540
ER 40	18	33.5	4.0	4335 18.040
ER 40	18.5	33.5	4.0	4335 18.540
ER 40	19	33.5	4.0	4335 19.040
ER 40	19.5	33.5	4.0	4335 19.540
ER 40	20	33.5	4.0	4335 20.040
ER 40	20.5	33.5	4.0	4335 20.540
ER 40	21	33.5	4.0	4335 21.040
ER 40	21.5	33.5	4.0	4335 21.540
ER 40	22	33.5	4.0	4335 22.040
ER 40	22.5	33.5	4.0	4335 22.540
ER 40	23	33.5	4.0	4335 23.040

Collet holders



Article no.

4335

Size	d1 mm	d2 mm	B mm	Order no.
ER 40	23.5	33.5	4.0	4335 23.540
ER 40	24	33.5	4.0	4335 24.040
ER 40	24.5	33.5	4.0	4335 24.540
ER 40	25	33.5	4.0	4335 25.040
ER 40	25.5	33.5	4.0	4335 25.540
ER 40	26	33.5	4.0	4335 26.040



HSK-A NC drilling chucks with internal cooling

Article no. **4346**



Product information:

- HSK-A according to ISO 12164-1 / DIN 69893-1
- balancing quality: G 2.5 / 20,000 rpm
- for clamping straight shank tools
- infinitely variable Ø clamping range
- high clamping force thanks to robust worm gear
- coolant pressure max. 50 bar
- balance: G 2.5 / 20,000 rpm

suitable accessories separately available:

- coolant supply set art. no. 4949
- clamping key art. no. 4912

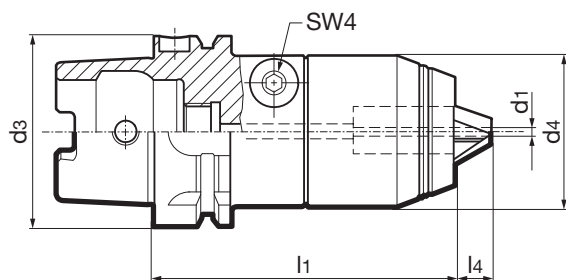

Article no. **4346**

d3	d1	d4 mm	l1 mm	l4 mm	Order no.
HSK-A 50	1,0 - 16,0	50	107	11	4346 16.050
HSK-A 63	1,0 - 16,0	50	98	12	4346 16.063
HSK-A 80	1,0 - 16,0	50	101	12	4346 16.080
HSK-A 100	1,0 - 16,0	50	104	12	4346 16.100

ISO taper NC drilling chucks with internal cooling

Article no. **4242**



Product information:

- ISO taper to DIN ISO 7388-1 form AD
- balancing quality: G 2.5 / 20,000 rpm
- for clamping straight shank tools
- infinitely variable Ø clamping range
- high clamping force thanks to robust worm gear
- coolant pressure max. 50 bar
- balance: G 2.5 / 20,000 rpm

suitable accessories separately available:

- ISO pull studs art. no. 4925, 4926
- clamping key art. no. 4912

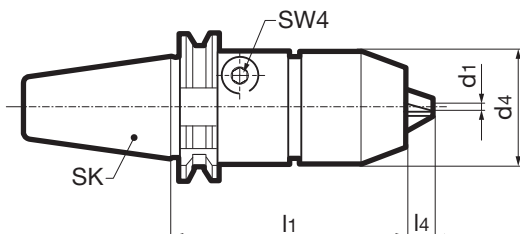

Article no. **4242**

SK	d1	d4 mm	l1 mm	l4 mm	Order no.
SK 40	1,0 - 16,0	50	80	12	4242 16.040
SK 50	1,0 - 16,0	50	80	12	4242 16.050



MAS/BT NC drilling chucks with internal cooling

Article no. 4240



GÜHROJET

Product information:

- MAS/BT to DIN ISO 7388-2 form JD
- balancing quality: G 2.5 / 20,000 rpm
- for clamping straight shank tools
- infinitely variable \varnothing clamping range
- high clamping force thanks to robust worm gear
- coolant pressure max. 50 bar
- balance: G 2.5 / 20,000 rpm

suitable accessories separately available:

- BT pull studs art. nr. 4927, 4928
- clamping key art. no. 4912

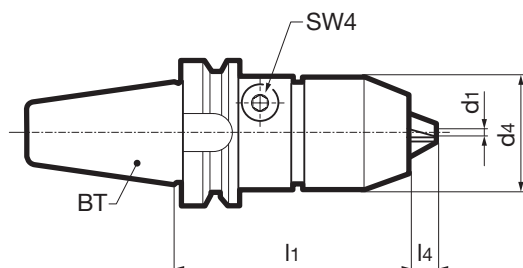

Article no.

4240

BT	d1	d4 mm	l1 mm	l4 mm	Order no.
BT 30	0,5 - 10,0	45	72	9	4240 10.030
BT 40	1,0 - 16,0	50	88	12	4240 16.040
BT 50	1,0 - 16,0	50	99	12	4240 16.050



Milling arbors HSK-A

Article no. **4362**



Product information:

- HSK-A according to ISO 12164-1 / DIN 69893-1
- according to DIN 69882-3
- balancing quality: G 6.3 / 15,000 rpm
- for holding milling cutter heads
- for centralised or decentralised internal cooling, therefore process and tool life improvement
- for holder Ø 40 and Ø 60, additionally with 4 threaded holes for holding cutter heads with tool attachment in accordance with DIN 2079 and increased contact Ø D2
- balancing thread 6xM6

Scope of delivery:

- incl. milling retainer screw art. no. 4908
- incl. retaining screws

suitable accessories separately available:

- coolant supply set art. no. 4949

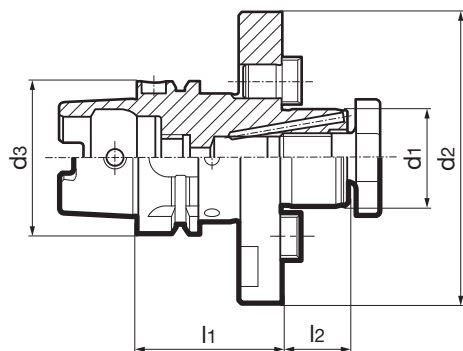

Article no.

4362

d3	d1 h6 mm	d2 mm	l1 mm	l2 mm	Order no.
HSK-A 63	22	50	50	19	4362 22.063
HSK-A 63	27	60	60	21	4362 27.063
HSK-A 63	32	78	60	24	4362 32.063
HSK-A 63	40	120	60	27	4362 40.063
HSK-A 63	40	89	60	27	4362 140.063
HSK-A 80	27	60	50	21	4362 27.080
HSK-A 80	32	78	50	24	4362 32.080
HSK-A 80	40	120	60	27	4362 40.080
HSK-A 80	60	160	70	40	4362 60.080
HSK-A 80	40	89	60	27	4362 140.080
HSK-A 100	27	60	50	21	4362 27.100
HSK-A 100	32	78	50	24	4362 32.100
HSK-A 100	40	120	60	27	4362 40.100
HSK-A 100	60	160	70	40	4362 60.100
HSK-A 100	40	89	60	27	4362 140.100



ISO taper milling arbors

Article no. 4800



GÜHROJET

Product information:

- ISO taper to DIN ISO 7388-1 form AD/AF
- coolant supply form AD/AF
- for holding milling cutter heads
- balancing quality: G 6.3 / 15,000 rpm
- for centralised or decentralised internal cooling, therefore process and tool life improvement
- clamping-Ø 40 with 4 additional tapped holes to hold milling heads with tool attachment DIN 2079 and larger contact-Ø d2

Scope of delivery:

- incl. milling retainer screw art. no. 4908
- incl. retaining screws

suitable accessories separately available:

- replacement milling cutter tightening screw, art. no. 4908
- ISO pull studs art. no. 4925, 4926

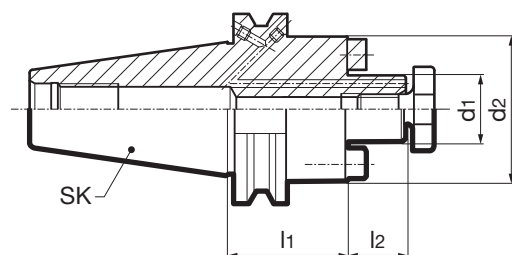

Article no.

4800

SK	d1 mm	d2 mm	l1 mm	l2 mm	Order no.
SK 40	16	38	35	17	4800 16.040
SK 40	16	38	100	17	4800 16.140
SK 40	16	38	130	17	4800 16.240
SK 40	16	38	160	17	4800 16.340
SK 40	22	48	35	19	4800 22.040
SK 40	22	48	100	19	4800 22.140
SK 40	22	48	130	19	4800 22.240
SK 40	22	48	160	19	4800 22.340
SK 40	27	60	45	21	4800 27.040
SK 40	27	60	100	21	4800 27.140
SK 40	27	60	130	21	4800 27.240
SK 40	27	60	160	21	4800 27.340
SK 40	32	78	50	24	4800 32.040
SK 40	32	78	100	24	4800 32.140
SK 40	32	78	130	24	4800 32.240
SK 40	32	78	160	24	4800 32.340
SK 40	40	88	50	27	4800 40.040
SK 50	16	32	100	17	4800 16.150
SK 50	16	32	130	17	4800 16.250
SK 50	16	32	160	17	4800 16.350
SK 50	22	48	35	19	4800 22.050
SK 50	22	48	100	19	4800 22.150
SK 50	22	48	130	19	4800 22.250
SK 50	22	48	160	19	4800 22.350
SK 50	27	60	40	21	4800 27.050
SK 50	27	60	100	21	4800 27.150
SK 50	27	60	130	21	4800 27.250
SK 50	27	60	160	21	4800 27.350
SK 50	32	78	50	24	4800 32.050
SK 50	32	78	100	24	4800 32.150
SK 50	32	78	130	24	4800 32.250
SK 50	32	78	160	24	4800 32.350
SK 50	40	88	50	27	4800 40.050
SK 50	40	88	100	27	4800 40.150
SK 50	40	88	130	27	4800 40.250
SK 50	40	88	160	27	4800 40.350



Product information:

- MAS/BT to DIN ISO 7388-2 Form JD/JF
- coolant supply form JD/JF (* BT30 version JD without coolant supply over collar without GÜHROJET)
- for holding milling cutter heads
- balancing quality: G 6.3 / 15,000 rpm
- for centralised or decentralised internal cooling, therefore process and tool life improvement
- clamping-Ø 40 with 4 additional tapped holes to hold milling heads with tool attachment DIN 2079 and larger contact-Ø d2

Scope of delivery:

- incl. milling retainer screw art. no. 4908
- incl. retaining screws

suitable accessories separately available:

- replacement milling cutter tightening screw, art. no. 4908
- BT pull studs art. no. 4927, 4928
- BT-50 on request

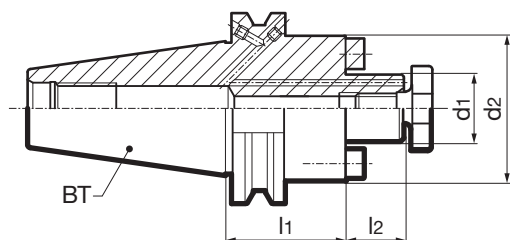

Article no.

4230

BT	d1 h6 mm	d2 mm	l1 mm	l2 mm	Order no.
BT 30	16	38	40.0	17	4230 16.030
BT 30	22	48	40.0	19	4230 22.030
BT 30	27	58	41.0	21	4230 27.030
BT 30	32	78	50.0	24	4230 32.030
BT 40	16	38	40.0	17	4230 16.040
BT 40	22	48	40.0	19	4230 22.040
BT 40	27	58	19.6	21	4230 27.040
BT 40	32	78	50.0	24	4230 32.040
BT 40	40	88	50.0	27	4230 40.040



Milling arbors CAT

Article no. 4222



GÜHROJET

Product information:

- CAT to ASME B5.50
- coolant supply form AD/AF
- balancing quality: G 6.3 / 15,000 rpm
- for holding milling cutter heads
- clamping-Ø 40 with 4 additional tapped holes to hold milling heads with tool attachment DIN 2079 and larger contact-Ø d2
- for central internal cooling

Scope of delivery:

- cylinder head screw DIN EN ISO 4762 art. no. 4907
- incl. milling retainer screw art. no. 4908
- incl. retaining screws

suitable accessories separately available:

- replacement cylinder screw DIN EN ISO 4762, art. no. 4907
- replacement milling cutter tightening screw, art. no. 4908
- CAT pull studs on request

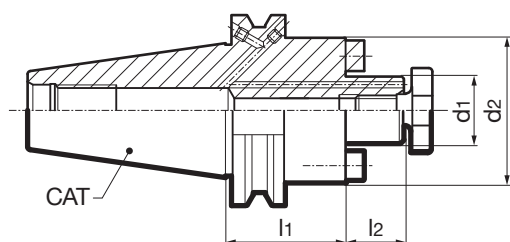

Article no.

4222

CAT	d1 h6 mm	d2 mm	l1 mm	l2 mm	Order no.
CAT 40	16	38	35	17	4222 16.040
CAT 40	22	44	35	19	4222 22.040
CAT 40	27	50	40	21	4222 27.040
CAT 40	32	78	50	24	4222 32.040
CAT 40	40	89	50	27	4222 40.040
CAT 50	16	38	35	17	4222 16.050
CAT 50	22	44	35	19	4222 22.050
CAT 50	27	50	40	21	4222 27.050
CAT 50	32	78	50	24	4222 32.050
CAT 50	40	89	50	27	4222 40.050



Product information:

- HSK-A according to ISO 12164-1 / DIN 69893-1
- for holding end face mills DIN 841, angled face mills DIN 842 with longitudinal slot, end face mills DIN 1880 with transverse slot and milling cutter heads DIN 1830
- for Ø 40 and Ø 50 holder, additionally with 4 threaded holes for holding cutter heads with tool attachment in accordance with DIN 2079
- for central coolant supply

Scope of delivery:

- incl. milling retainer screw art. no. 4908
- driver, art. no. 4922
- feather key, art. no. 4923

suitable accessories separately available:

- coolant supply set art. no. 4949

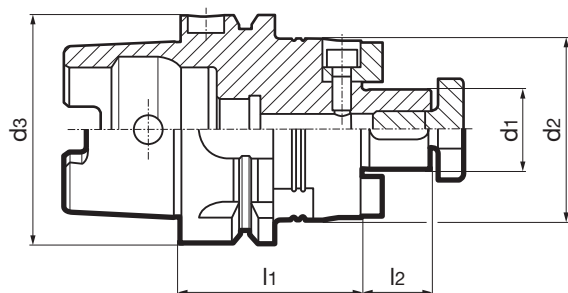

Article no. **4361**

d3	d1 h6 mm	d2 mm	l1 mm	l2 mm	Order no.
HSK-A 32	16	40	45	17	4361 16.032
HSK-A 32	22	50	50	19	4361 22.032
HSK-A 40	16	40	45	17	4361 16.040
HSK-A 40	22	50	50	19	4361 22.040
HSK-A 50	16	40	45	17	4361 16.050
HSK-A 50	22	50	50	19	4361 22.050
HSK-A 50	27	60	55	21	4361 27.050
HSK-A 63	16	40	45	17	4361 16.063
HSK-A 63	22	50	50	19	4361 22.063
HSK-A 63	27	60	55	21	4361 27.063
HSK-A 63	32	78	55	24	4361 32.063
HSK-A 63	40	89	60	27	4361 40.063
HSK-A 80	16	40	45	17	4361 16.080
HSK-A 80	22	50	50	19	4361 22.080
HSK-A 80	27	60	55	21	4361 27.080
HSK-A 80	32	78	55	24	4361 32.080
HSK-A 80	40	89	60	27	4361 40.080
HSK-A 100	22	50		19	4361 22.100
HSK-A 100	27	60	55	21	4361 27.100
HSK-A 100	32	78	55	24	4361 32.100
HSK-A 100	40	89	60	27	4361 40.100
HSK-A 100	50	120	70	30	4361 50.100



Feather key DIN 6885 A

Article no. 4923

Scope of delivery:

- minimum order quantity 10 pcs.

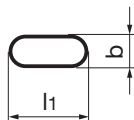

Article no. 4923

Size	l1 mm	b mm	Order no.
16	14	4	4923 4.016
22	16	6	4923 6.022
27	19	7	4923 7.027
32	22	8	4923 8.032
40	25	10	4923 10.040
50	28	12	4923 12.050

Drive dog sets for shell milling arbors

Article no. 4922

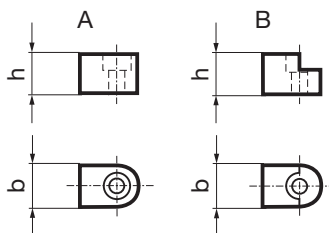

Article no. 4922

Size	Form	h mm	b mm	Order no.
16	B	9.25	8	4922 16.000
22	B	11.00	10	4922 22.000
27	A	12.75	12	4922 27.000
32	A	16.50	14	4922 32.000
40	A	20.00	16	4922 40.000
50	A	27.50	18	4922 50.000



Screws DIN EN ISO 4762 (former DIN 912)

Article no. **4907**

Product information:

strength class M3 to M8: 8.8, M12: 10.9

Scope of delivery:

- minimum order quantity 10

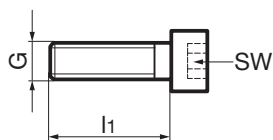

Article no. **4907**

G	l1 mm	SW mm	Order no.
M 3	8	2.5	4907 3.081
M 4	10	3.0	4907 4.100
M 4	10	3.0	4907 4.101
M 5	12	4.0	4907 5.120
M 5	16	4.0	4907 5.161
M 6	16	5.0	4907 6.140
M 6	16	5.0	4907 6.160
M 6	16	5.0	4907 6.161
M 6	20	5.0	4907 6.200
M 6	20	5.0	4907 6.201
M 8	25	6.0	4907 8.250
M12	65	10.0	4907 12.650

Milling cutter retaining screws

Article no. **4908**

Product information:

- according to DIN 6367
- on request with internal cooling

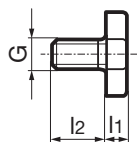

Article no. **4908**

for arbour Ø	G	l1 mm	l2 mm	Torque Nm	Order no.
16	M 8	6	16	40	4908 16.000
22	M10	7	18	60	4908 22.000
27	M12	8	22	80	4908 27.000
32	M16	9	26	95	4908 32.000
40	M20	10	30	100	4908 40.000
50	M24	12	36	135	4908 50.000
60	M30	14	45	160	4908 60.000



Socket wrenches for retaining screws

Article no. 4909

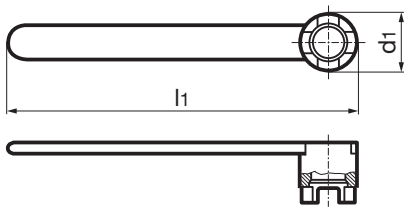

Article no.

4909

for arbour Ø	d1 mm	l1 mm	Order no.
16	22	180	4909 16.000
22	28	200	4909 22.000
27	35	225	4909 27.000
32	42	250	4909 32.000
40	52	280	4909 40.000
50	63	315	4909 50.000
60	76	355	4909 60.000



HSK-A morse taper holders

Article no. **4320**



Product information:

- HSK-A according to ISO 12164-1 / DIN 69893-1
- for holding morse tapers with tangs in accordance with DIN 228-1, form B

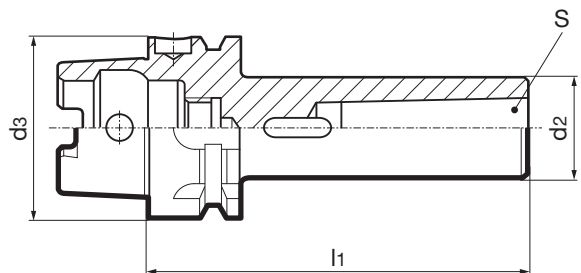

Article no. **4320**

d3	S	d2 mm	l1 mm	Order no.
HSK-A 50	MK-1	25	100	4320 1.050
HSK-A 50	MK-2	32	120	4320 2.050
HSK-A 50	MK-3	40	140	4320 3.050
HSK-A 63	MK-1	25	100	4320 1.063
HSK-A 63	MK-2	32	120	4320 2.063
HSK-A 63	MK-3	40	140	4320 3.063
HSK-A 63	MK-4	48	160	4320 4.063
HSK-A 80	MK-1	25	110	4320 1.080
HSK-A 80	MK-2	32	120	4320 2.080
HSK-A 80	MK-3	40	150	4320 3.080
HSK-A 80	MK-4	48	170	4320 4.080
HSK-A 100	MK-1	25	110	4320 1.100
HSK-A 100	MK-2	32	120	4320 2.100
HSK-A 100	MK-3	40	150	4320 3.100
HSK-A 100	MK-4	48	170	4320 4.100
HSK-A 100	MK-5	63	200	4320 5.100



ISO taper morse taper holders

Article no. 4238



Product information:

- ISO taper to DIN ISO 7388-1 form AD
- for holding morse tapers with tangs in accordance with DIN 228-1, form B

suitable accessories separately available:

- ISO pull studs art. no. 4925, 4926

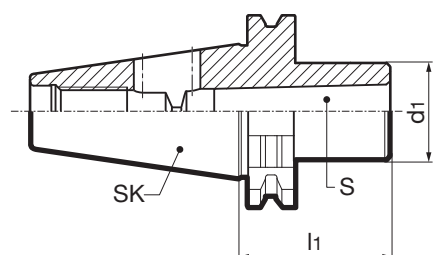

Article no.

4238

SK	S	d1 mm	l1 mm	Order no.
SK 40	MK-1	25	50	4238 1.040
SK 40	MK-2	32	50	4238 2.040
SK 40	MK-3	40	70	4238 3.040
SK 40	MK-4	48	95	4238 4.040
SK 50	MK-1	25	45	4238 1.050
SK 50	MK-2	32	60	4238 2.050
SK 50	MK-3	40	65	4238 3.050
SK 50	MK-4	48	95	4238 4.050
SK 50	MK-5	63	105	4238 5.050



BT morse taper holders

Article no. **4239**



Product information:

- MAS/BT to DIN ISO 7388-2 form JD
- for holding morse tapers with tangs in accordance with DIN 228-1, form B

suitable accessories separately available:

- BT pull studs art. nr. 4927, 4928

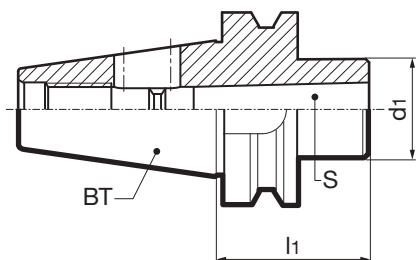

Article no. **4239**

BT	S	d1 mm	l1 mm	Order no.
BT 30	MK-1	25	45	4239 1.030
BT 30	MK-2	32	60	4239 2.030
BT 30	MK-3	40	75	4239 3.030
BT 40	MK-1	25	50	4239 1.040
BT 40	MK-2	32	50	4239 2.040
BT 40	MK-3	40	70	4239 3.040
BT 40	MK-4	48	95	4239 4.040
BT 50	MK-1	25	45	4239 1.050
BT 50	MK-2	32	60	4239 2.050
BT 50	MK-3	40	65	4239 3.050
BT 50	MK-4	48	95	4239 4.050
BT 50	MK-5	63	105	4239 5.050



HSK-A blanks

 Article no. **4983**

Product information:

- Material: nitrided steel, hardened and ground taper (yellow in scale drawing), blank unhardened for further machining
- HSK-A according to ISO 12164-1 / DIN 69893-1

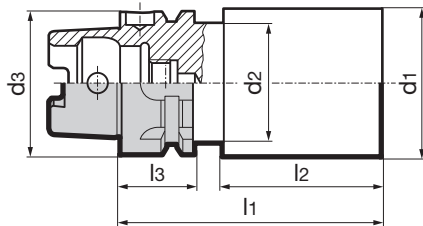

Article no.

4983

d3	d1 mm	d2 mm	l1 mm	l2 mm	l3 mm	Order no.
HSK-A 32	41	26	175	140	20	4983 175.032
HSK-A 40	51	35	205	170	20	4983 205.040
HSK-A 50	64	42	235	193	26	4983 235.050
HSK-A 63	63	53	150	108	26	4983 150.063
HSK-A 63	81	53	235	193	26	4983 235.063
HSK-A 80	101	67	235	193	26	4983 235.080
HSK-A 100	126	85	250	205	29	4983 250.100



HSK-C blanks

Article no. **4982**



Product information:

- Material: nitrided steel, hardened and ground taper (yellow in scale drawing), blank unhardened for further machining
- machining not permitted in l3 area
- HSK-C according to ISO 12164-1/DIN 69893-1

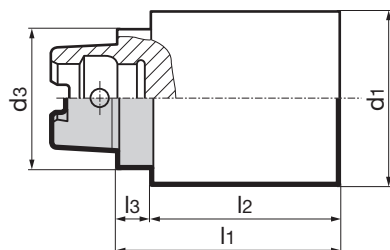

Article no. **4982**

d3	d1 mm	l1 mm	l2 mm	l3 mm	Order no.
HSK-C 25	30	100	90	10	4982 87.025
HSK-C 32	41	150	139	11	4982 50.032
HSK-C 40	51	180	169	11	4982 63.040
HSK-C 50	64	200	186	14	4982 80.050
HSK-C 50	64	90	76	14	4982 100.050
HSK-C 63	81	200	186	14	4982 112.063
HSK-C 63	81	100	86	14	4982 125.063
HSK-C 80	101	210	193	17	4982 120.080
HSK-C 100	124	225	208	17	4982 145.100



OVERVIEW OF MODULES

6x6

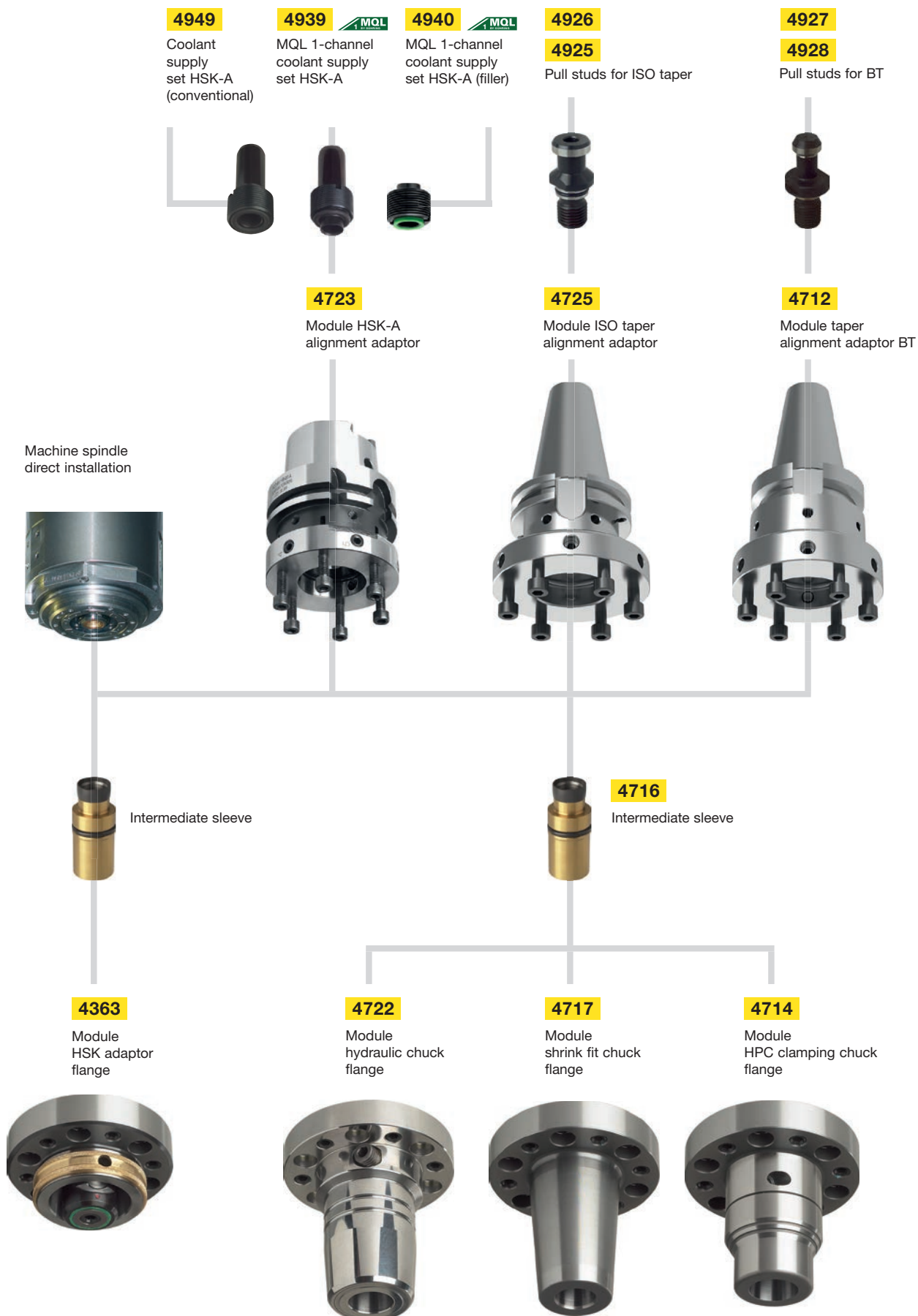



Module 6x6 HSK-A alignment adaptors

Article no. **4723**



Product information:

- HSK-A according to ISO 12164-1 / DIN 69893-1
- balancing quality: G 6.3 / 15,000 rpm
- for the highly accurate alignment of all modular flanges 6x6
- 6 balancing threads M6
- suitable for MQL and conventional cooling
- cooling lubricant without loss and flow-disruption thanks to the use of an intermediate tube

Scope of delivery:

- incl. 6 screws for radial adjustment
- incl. 6 clamping screws

suitable accessories separately available:

- adaptor sleeves art. no. 4716
- coolant supply set art. no. 4949
- MQL transfer unit, art. no. 4939 or 4940

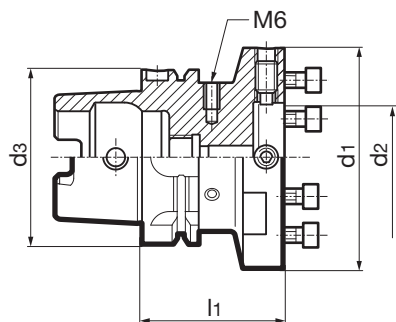

Article no. **4723**

d3	d1 mm	d2 mm	l1 mm	Order no.
HSK-A 63	60	30	60	4723 60.063
HSK-A 63	70	35	60	4723 70.063
HSK-A 63	80	40	60	4723 80.063
HSK-A 63	100	50	65	4723 100.063
HSK-A 63	117	60	65	4723 117.063
HSK-A 80	70	35	60	4723 70.080
HSK-A 80	80	40	60	4723 80.080
HSK-A 80	100	50	65	4723 100.080
HSK-A 80	117	60	65	4723 117.080
HSK-A 80	140	80	75	4723 140.080
HSK-A 100	70	35	55	4723 70.100
HSK-A 100	80	40	55	4723 80.100
HSK-A 100	100	50	65	4723 100.100
HSK-A 100	117	60	65	4723 117.100
HSK-A 100	140	80	75	4723 140.100



Product information:

- ISO taper to DIN ISO 7388-1 form AD/AF
- balancing quality: G 6.3 / 15,000 rpm
- for the highly accurate alignment of all modular flanges 6x6
- 6 balancing threads M6
- suitable for MQL and conventional cooling
- cooling lubricant without loss and flow-disruption thanks to the use of an intermediate tube

Scope of delivery:

- incl. 6 screws for radial adjustment
- incl. 6 clamping screws

suitable accessories separately available:

- adaptor sleeves art. no. 4716
- ISO pull studs art. no. 4925, 4926

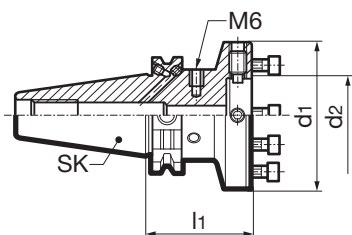

Article no. **4725**

SK	d1 mm	d2 mm	l1 mm	Order no.
SK 40	60	30	50	4725 60.040
SK 40	70	35	50	4725 70.040
SK 40	80	40	55	4725 80.040
SK 40	100	50	60	4725 100.040
SK 50	60	30	50	4725 60.050
SK 50	70	35	50	4725 70.050
SK 50	80	40	50	4725 80.050
SK 50	100	50	60	4725 100.050
SK 50	117	60	60	4725 117.050
SK 50	140	80	60	4725 140.050

Holders fine machining



Product information:

- MAS/BT to DIN ISO 7388-2 form JD
- balancing quality: G 6.3 / 15,000 rpm
- suitable for MQL and conventional cooling
- cooling lubricant without loss and flow-disruption thanks to the use of an intermediate tube
- for the highly accurate alignment of all modular flanges 6x6
- 6 balancing threads M6

Scope of delivery:

- incl. 6 screws for radial adjustment
- incl. 6 clamping screws

suitable accessories separately available:

- adaptor sleeves art. no. 4716
- BT pull studs art. nr. 4927, 4928

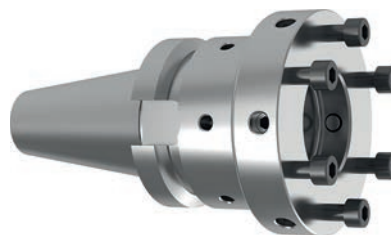
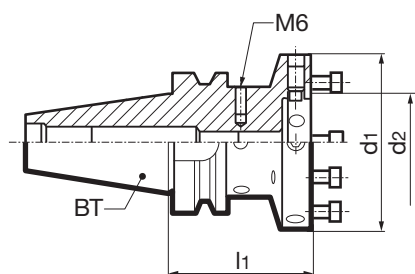

Article no.

4712

BT	d1 mm	d2 mm	l1 mm	Order no.
BT 30	60	30	50	4712 60.030
BT 30	70	35	50	4712 70.030
BT 40	60	30	55	4712 60.040
BT 40	70	35	55	4712 70.040
BT 40	80	40	65	4712 80.040
BT 40	100	50	70	4712 100.040
BT 50	60	30	70	4712 60.050
BT 50	70	35	70	4712 70.050
BT 50	80	40	70	4712 80.050
BT 50	100	50	70	4712 100.050
BT 50	117	60	80	4712 117.050
BT 50	140	80	80	4712 140.050



Product information:

- for the highly accurate radial and axial alignment on alignment adaptors or machine spindles
- balancing quality: G 6.3 / 15,000 rpm
- for tool shanks d1 h6
- cooling lubricant without loss and flow-disruption thanks to the use of an intermediate tube

Scope of delivery:

- incl. adjusting screw (2) art. no. 4941
- incl. clamping screw (3) art. no. 4241
- incl. angular alignment set art. no. 4715
- incl. 6 clamping screws

suitable accessories separately available:

- hexagonal key art. no. 4912
- adaptor sleeves (1), art. no. 4716
- replacement adjusting screw (2), art. no. 4941
- replacement clamping screw (3), art. no. 4241
- replacement sealing lip, art. no. 4617 for adaptor sleeves, art. no. 4716
- for additional clamping Ø, use reduction bushes, art. no. 4368 or 4369
- design for MQL available on request

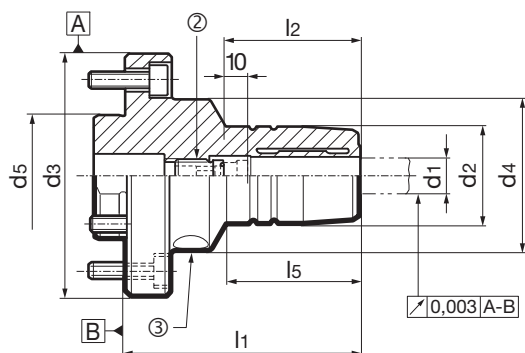

Article no.

4722

d3 mm	d1 mm	d2 mm	d4 mm	d5 mm	l1 mm	l2 mm	l5 mm	SW mm	①	②	③
70	12	32	40	35	75.0	45	45.0	4	4716 14.020	4941 12.100	4241 8.000
80	20	42	50	40	82.5	50	51.5	5	4716 14.040	4941 20.100	4241 10.001
80	12	32	50	40	77.5	45	44.3	5	4716 14.050	4941 12.100	4241 10.002
100	32	64	64	50	103.0	60	84.0	6	4716 14.020	4941 32.100	4241 12.000

Order no.
4722 12.070
4722 20.080
4722 12.080
4722 32.100



Module 6x6 shrink fit chuck flanges

Article no. **4717**

Product information:

- for the highly accurate radial and axial alignment on alignment adaptors or machine spindles
- balancing quality: G 6.3 / 15,000 rpm
- for tool shanks d1 h6
- cooling lubricant without loss and flow-disruption thanks to the use of an intermediate tube
- with axial damping screw for optimal concentricity

Scope of delivery:

- incl. adjusting screw (2) art. no. 4941
- incl. 6 angular alignment sets art. no. 4715
- incl. 6 clamping screws

suitable accessories separately available:

- adaptor sleeves (1), art. no. 4716
- replacement sealing lip, art. no. 4617 for adaptor sleeves, art. no. 4716
- further sizes on request

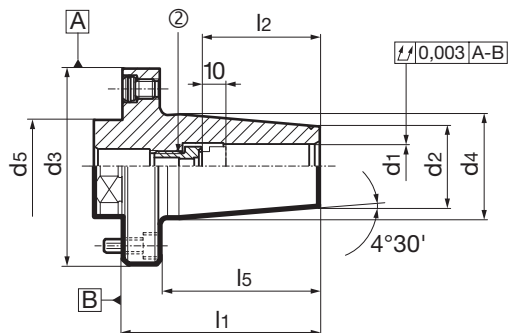

Article no.

4717

d3 mm	d1 mm	d2 mm	d4 mm	d5 mm	l1 mm	l2 mm	l5 mm	①	②	Order no.
60	6	21	27	30	70	36	56	4716 14.010	4941 6.100	4717 6.060
60	8	21	27	30	70	36	56	4716 14.010	4941 8.100	4717 8.060
60	10	24	32	30	70	40	56	4716 14.020	4941 10.100	4717 10.060
60	12	24	32	30	70	45	56	4716 14.030	4941 12.100	4717 12.060
70	12	24	32	35	75	45	60	4716 14.020	4941 12.100	4717 12.070
70	14	27	34	35	75	45	60	4716 14.020	4941 14.100	4717 14.070
70	16	27	34	35	75	48	60	4716 14.040	4941 16.100	4717 16.070
80	18	33	42	40	80	48	65	4716 14.050	4941 18.100	4717 18.080
80	20	33	42	40	80	50	65	4716 14.040	4941 20.100	4717 20.080
100	25	44	52	48	80	56	61	4716 20.010	4941 25.100	4717 25.100
100	32	44	52	50	80	60	61	4716 20.020	4941 32.100	4717 32.100



Module 6x6 HPC clamping chuck flanges

Article no. **4714**



Product information:

- highest concentricity, clamping force and rigidity thanks to mech. tension gearing
- for the highly accurate radial and axial alignment on alignment adaptors or machine spindles
- for tool shanks d1 h6
- cooling lubricant without loss and flow-disruption thanks to the use of an intermediate tube
- suitable for internal cooling up to 80 bar
- positive damping properties

Scope of delivery:

- incl. 6 angular alignment sets art. no. 4715
- incl. 6 clamping screws

suitable accessories separately available:

- clamping sleeves art. no. 4302, 4235, 4236, 4237
- 6 angle alignment units, art. no. 4715
- adaptor sleeves (1), art. no. 4716
- replacement sealing lip, art. no. 4617 for adaptor sleeves, art. no. 4716
- hexagonal key (2), art. no. 4912

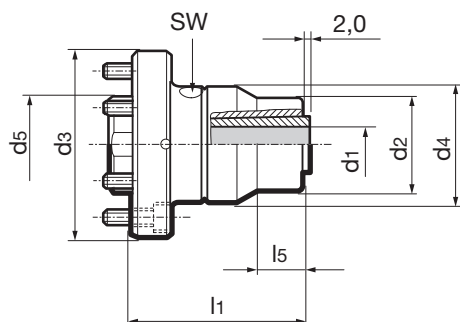

Article no. **4714**

d3 mm	Size	d1	d2 mm	d4 mm	d5 mm	l1 mm	l5 mm	SW mm	①	②
70	20	3 - 20	40.0	50.0	35.0	87.0	20.0	4	4716 20.030	4912 4.600
80	20	3 - 20	40.0	50.0	40.0	73.0	20.0	4	4716 20.030	4912 4.600
100	25	16 - 32	53.0	63.0	48.0	118.0		4	4716 20.030	4912 4.600

Order no.
4714 20.070
4714 20.080
4714 25.100

Module 6x6 HSK adaptor flanges

Article no. **4363**



Product information:

- for holding HSK-A/C shanks according to ISO 12164-1/DIN 69893
- for the highly accurate radial and axial alignment on alignment adaptors or machine spindles
- suitable for MQL and conventional cooling
- for the transferable torsional moment the interface between spindle and flange has to be taken into consideration

Scope of delivery:

- incl. MQL 4-point clamping set art. no. 4930
- incl. retension screw art. no. 4935
- incl. brass lock ring art. no. 4953
- incl. 6 angular alignment sets art. no. 4715
- incl. 6 clamping screws
- incl. adaptor sleeve (1), art. no. 4716

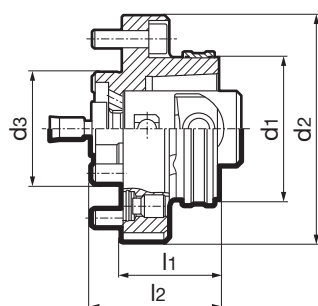

Article no. **4363**

d1	d2 mm	d3 mm	l1 mm	l2 mm	①
HSK-C 32	60	30	26	36	4716 24.060
HSK-C 40	70	35	30	40	4716 30.070
HSK-C 50	80	40	35	45	4716 23.808
HSK-C 63	100	50	43	55	4716 48.100
HSK-C 80	117	60	50	62	4716 60.117
HSK-C 100	140	80	75	87	4716 75.140

Order no.
4363 24.060
4363 30.070
4363 38.080
4363 48.100
4363 60.117
4363 75.140

HOLDERS FINE MACHINING



OVERVIEW OF MODULES

4x4

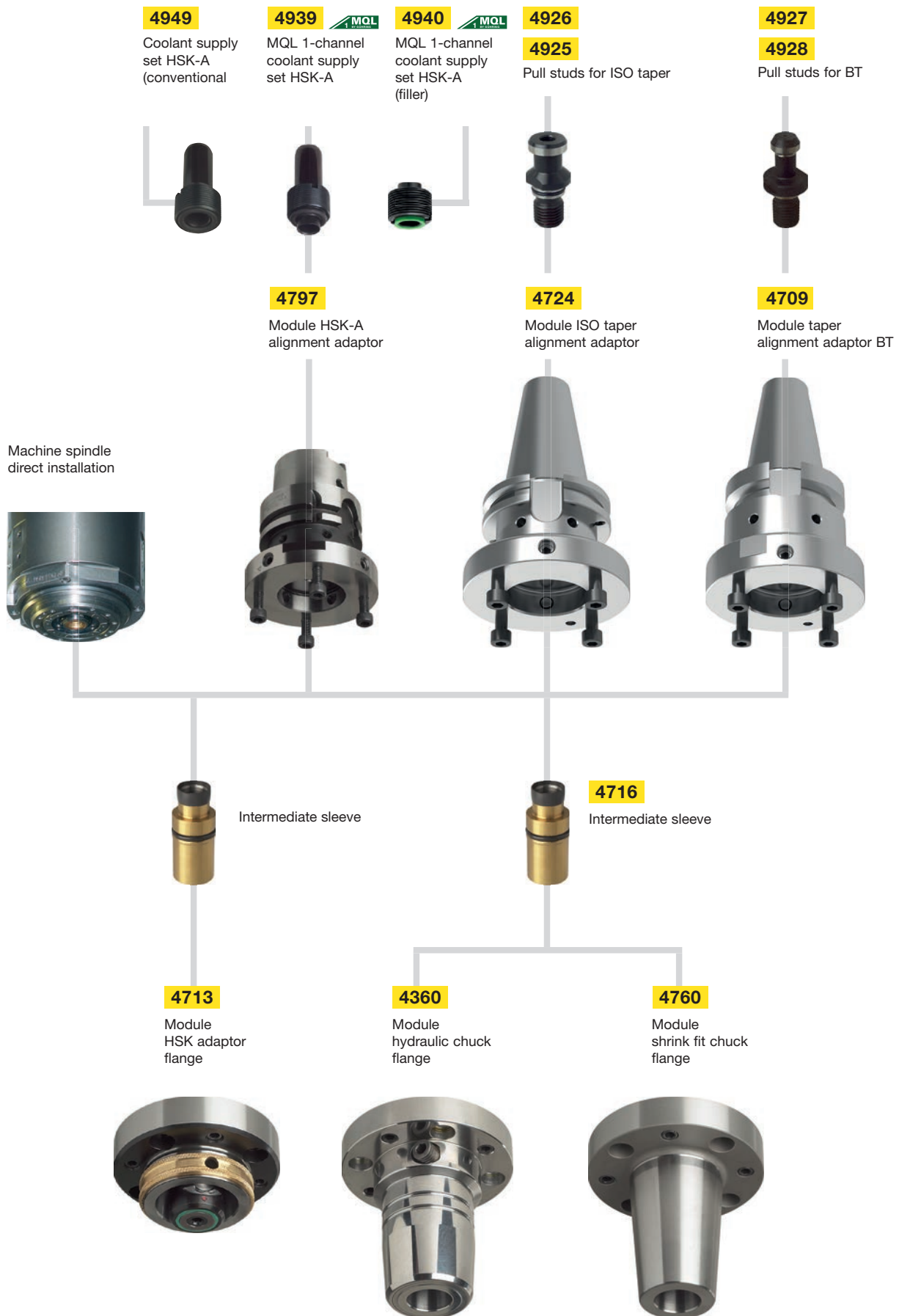

Holders fine machining



Module 4x4 HSK-A alignment adaptors

Article no. 4297



Product information:

- HSK-A according to ISO 12164-1 / DIN 69893-1
- balancing quality: G 6.3 / 15,000 rpm
- for the highly accurate alignment of all modular flanges 4x4
- cooling lubricant without loss and flow-disruption thanks to the use of an intermediate tube
- suitable for MQL and conventional cooling
- 6 balancing threads M6

Scope of delivery:

- incl. 4 screws for radial adjustment
- incl. 4 clamping screws

suitable accessories separately available:

- coolant supply set art. no. 4949
- MQL transfer unit, art. no. 4939 or 4940
- adaptor sleeves art. no. 4716
- further sizes on request

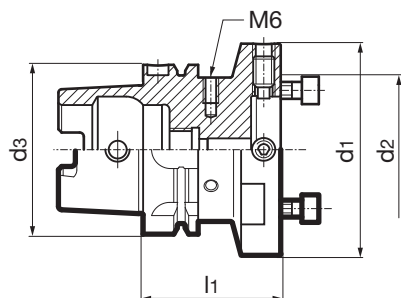

Article no.

4297

d3	d1 mm	d2 mm	l1 mm	Order no.
HSK-A 63	60	30	60	4297 60.063
HSK-A 63	70	35	60	4297 70.063
HSK-A 63	80	40	60	4297 80.063
HSK-A 63	100	50	65	4297 100.063
HSK-A 63	117	60	65	4297 117.063
HSK-A 80	70	35	60	4297 70.080
HSK-A 80	80	40	60	4297 80.080
HSK-A 80	100	50	65	4297 100.080
HSK-A 80	117	60	65	4297 117.080
HSK-A 80	140	80	75	4297 140.080
HSK-A 100	70	35	55	4297 70.100
HSK-A 100	80	40	55	4297 80.100
HSK-A 100	100	50	65	4297 100.100
HSK-A 100	117	60	65	4297 117.100
HSK-A 100	140	80	75	4297 140.100



Product information:

- ISO taper to DIN ISO 7388-1 form AD/AF
- balancing quality: G 6.3 / 15,000 rpm
- for the highly accurate alignment of all modular flanges 4x4
- 6 balancing threads M6
- suitable for MQL and conventional cooling
- cooling lubricant without loss and flow-disruption thanks to the use of an intermediate tube

Scope of delivery:

- incl. 4 screws for radial adjustment
- incl. 4 clamping screws

suitable accessories separately available:

- adaptor sleeves art. no. 4716
- ISO pull studs art. no. 4925, 4926

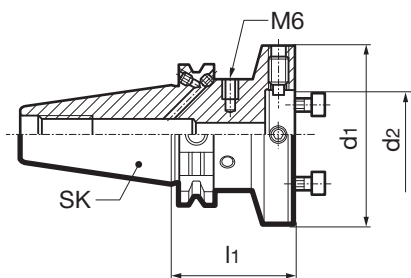

Article no. **4724**

SK	d1 mm	d2 mm	l1 mm	Order no.
SK 40	60	30	50	4724 60.040
SK 40	70	35	50	4724 70.040
SK 40	80	40	55	4724 80.040
SK 40	100	50	60	4724 100.040
SK 50	60	30	50	4724 60.050
SK 50	70	35	50	4724 70.050
SK 50	80	40	50	4724 80.050
SK 50	100	50	60	4724 100.050
SK 50	117	60	60	4724 117.050
SK 50	140	80	60	4724 140.050



Module 4x4 BT alignment adaptors

Article no. 4709



Product information:

- MAS/BT to DIN ISO 7388-2 form JD
- balancing quality: G 6.3 / 15,000 rpm
- suitable for MQL and conventional cooling
- cooling lubricant without loss and flow-disruption thanks to the use of an intermediate tube
- for the highly accurate alignment of all modular flanges 4x4
- 6 balancing threads M6

Scope of delivery:

- incl. 4 screws for radial adjustment
- incl. 4 clamping screws

suitable accessories separately available:

- BT pull studs art. nr. 4927, 4928
- adaptor sleeves art. no. 4716

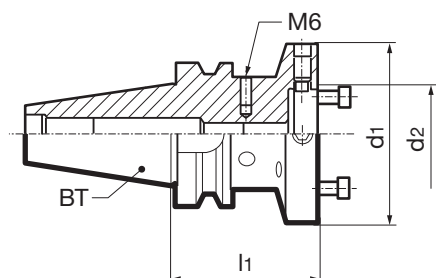

Article no.

4709

BT	d1 mm	d2 mm	l1 mm	Order no.
BT 30	60	30	50	4709 60.030
BT 30	70	35	50	4709 70.030
BT 40	60	30	55	4709 60.040
BT 40	70	35	55	4709 70.040
BT 40	80	40	65	4709 80.040
BT 40	100	50	70	4709 100.040
BT 50	60	30	70	4709 60.050
BT 50	70	35	70	4709 70.050
BT 50	80	40	70	4709 80.050
BT 50	100	50	70	4709 100.050
BT 50	117	60	80	4709 117.050
BT 50	140	80	80	4709 140.050



Product information:

- for the highly accurate radial and axial alignment on alignment adaptors or machine spindles
- balancing quality: G 6.3 / 15,000 rpm
- for tool shanks d1 h6
- cooling lubricant without loss and flow-disruption thanks to the use of an intermediate tube

Scope of delivery:

- incl. adjusting screw (2) art. no. 4941
- incl. clamping screw (3) art. no. 4241
- incl. 4 angle alignment units, art. no. 4715
- incl. 4 clamping screws

suitable accessories separately available:

- hexagonal key art. no. 4912
- adaptor sleeves (1), art. no. 4716
- replacement sealing lip, art. no. 4617 for adaptor sleeves, art. no. 4716
- for additional clamping Ø, use reduction bushes, art. no. 4368 or 4369
- design for MQL available on request

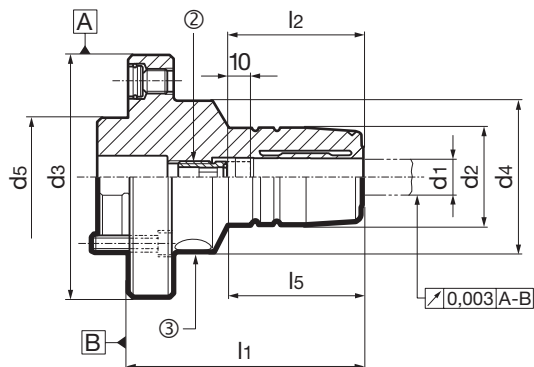

Article no.

4360

d3 mm	d1 mm	d2 mm	d4 mm	d5 mm	l1 mm	l2 mm	l5 mm	SW mm	①	②	③
70	12	32	40	35	75.0	45	45.0	4	4716 14.020	4941 12.100	4241 8.000
80	12	32	50	40	77.5	45	44.3	5	4716 14.050	4941 12.100	4241 10.002
80	20	42	50	40	82.5	50	51.5	5	4716 14.040	4941 20.100	4241 10.001
100	32	64	64	50	103.0	60	84.0	6	4716 14.020	4941 32.100	4241 12.000

Order no.
4360 12.070
4360 12.080
4360 20.080
4360 32.100



Module 4x4 shrink fit chuck flanges

Article no. 4760

Product information:

- for the highly accurate radial and axial alignment on alignment adaptors or machine spindles
- balancing quality: G 6.3 / 15,000 rpm
- for tool shanks d1 h6
- with axial damping screw for optimal concentricity
- cooling lubricant without loss and flow-disruption thanks to the use of an intermediate tube

Scope of delivery:

- incl. adjusting screw with axial force damping (1) art. no. 4941
- incl. 4 angle alignment units, art. no. 4715
- incl. 4 clamping screws

suitable accessories separately available:

- replacement adjusting screw with axial force damping (1), art. no. 4941
- angle alignment units, art. no. 4715
- incl. adaptor sleeve (1), art. no. 4716
- replacement sealing lip, art. no. 4617 for adaptor sleeves, art. no. 4716
- further sizes on request

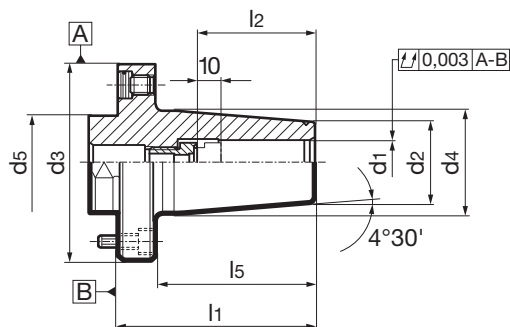

Article no.

4760

d3 mm	d1 mm	d2 mm	d4 mm	d5 mm	l1 mm	l2 mm	l5 mm	①	②	Order no.
60	6	21	27	30	70	36	56	4941 6.100	4716 14.010	4760 6.060
60	8	21	27	30	70	36	56	4941 8.100	4716 14.010	4760 8.060
60	10	24	32	30	70	40	56	4941 10.100	4716 14.020	4760 10.060
60	12	24	32	30	70	45	56	4941 12.100	4716 14.030	4760 12.060
70	12	24	32	35	75	45	60	4941 12.100	4716 14.020	4760 12.070
70	14	27	34	35	75	45	60	4941 14.100	4716 14.020	4760 14.070
70	16	27	34	35	75	48	60	4941 16.100	4716 14.040	4760 16.070
80	18	33	42	40	80	48	65	4941 18.100	4716 14.050	4760 18.080
80	20	33	42	40	80	50	65	4941 20.100	4716 14.040	4760 20.080
100	25	44	52	48	80	56	61	4941 25.100	4716 20.010	4760 25.100
100	32	44	52	50	80	60	61	4941 32.100	4716 20.020	4760 32.100



Product information:

- for holding HSK-A/C shanks according to ISO 12164-1/DIN 69893
- for the highly accurate radial and axial alignment on alignment adaptors or machine spindles
- suitable for MQL and conventional cooling
- for the transferable torsional moment the interface between spindle and flange has to be taken into consideration

Scope of delivery:

- incl. MQL 4-point clamping set art. no. 4930
- incl. retention screw art. no. 4935
- incl. brass lock ring art. no. 4953
- incl. 4 angle alignment units, art. no. 4715
- incl. 4 clamping screws
- incl. adaptor sleeve (1), art. no. 4716

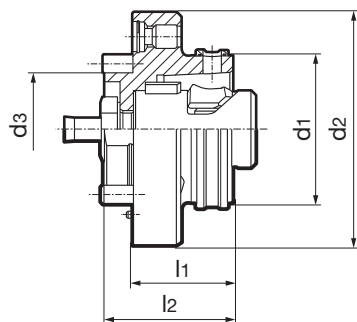

Article no.

4713

d1	d2 mm	d3 mm	l1 mm	l2 mm	①	Order no.
HSK-C 32	60	30	26	36	4716 24.060	4713 24.060
HSK-C 40	70	35	30	40	4716 30.070	4713 30.070
HSK-C 50	80	40	35	45	4716 238.080	4713 38.080
HSK-C 63	100	50	43	55	4716 48.100	4713 48.100
HSK-C 80	117	60	50	62	4716 60.117	4713 60.117
HSK-C 100	140	80	75	87	4716 75.140	4713 75.140



Length adjusting screw for conventional cooling

Article no. 4941



Product information:

- to adapt MQL tool holders to meet the requirements of conventional wet machining. For plain end shanks. The height of screw head compensates the height of MQL taper.
- for use with shank according to DIN 6535 with plain shank end for conventional cooling
- with patented axial force damping; the o-ring on the face prevents temperature-related warping and concentricity errors
- for MQL HSK-A shrink fit and hydraulic chucks

suitable accessories separately available:

- hexagonal key art. no. 4912

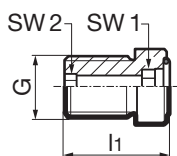

Article no.

4941

for HSK-A	for clamping Ø mm	l1 mm	G	SW2 mm	SW1 mm	Order no.
40	6	15.0	M7	2.5	2.5	4941 6.040
40	6	14.9	M 5	2.5	2.5	4941 6.041
50	6	14.0	M 8X1	2.5	2.5	4941 6.050
63-100	6	17.0	M10X1	2.5	2.5	4941 6.100
40	8	16.2	M7	3.0	3.0	4941 8.040
50	8	18.0	M 8X1	3.0	3.0	4941 8.050
63-100	8	17.0	M10X1	3.0	3.0	4941 8.100
40-50	10	16.2	M 8X1	4.0	4.0	4941 10.050
63-100	10	16.2	M10X1	4.0	4.0	4941 10.100
40-100	12	16.0	M10X1	5.0	5.0	4941 12.100
40-100	14	17.2	M10X1	5.0	5.0	4941 14.100
50-100	16	18.2	M12X1	6.0	6.0	4941 16.100
50-100	18	19.2	M12X1	6.0	6.0	4941 18.100
50-100	20	19.2	M16X1	6.0	8.0	4941 20.100
63-100	25	22.7	M16X1	6.0	8.0	4941 25.100
63-100	32	26.7	M16X1	6.0	8.0	4941 32.100



Intermediate sleeves f. mod. flanges/alignment adaptors

Article no. **4716**

Product information:

- for sealing during wet and MQL machining
- design without O ring for HSK module adaptor flange art. no. 4363 and art. no. 4713

Scope of delivery:

- sealing lip art. no. 4617 1.140
- O-ring

suitable accessories separately available:

- replacement sealing lip, art. no. 4617 1,140

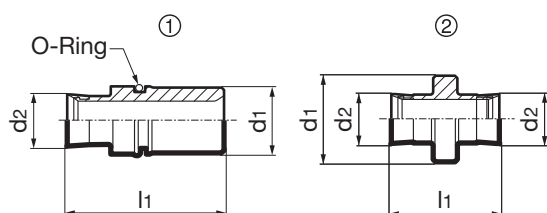

Article no.

4716

d1 mm	d2 mm	l1 mm	Type	Code no.	Order no.
14.0	10.7	47.5	1	14.010	4716 14.010
14.0	10.7	32.0	1	14.020	4716 14.020
14.0	10.7	37.5	1	14.030	4716 14.030
14.0	10.7	26.5	1	14.040	4716 14.040
14.0	10.7	31.5	1	14.050	4716 14.050
20.0	10.7	28.0	1	20.010	4716 20.010
20.0	10.7	25.5	1	20.020	4716 20.020
20.0	10.7	16.5	1	20.030	4716 20.030
4.0	10.7	26.1	1	24.060	4716 24.060
5.0	10.7	21.9	1	30.070	4716 30.070
7.0	10.7	31.7	1	48.100	4716 48.100
17.8	10.7	22.3	2	60.100	4716 60.100
10.0	10.7	28.6	2	60.117	4716 60.117
12.0	10.7	36.4	1	75.140	4716 75.140
17.8	10.7	26.3	1	117.140	4716 117.140
6.0	10.7	21.9	1	238.080	4716 238.080



Angle alignment units f. mod. flanges /alignment adaptors

Article no. **4715**

Product information:

- for precise angle alignment of mod. flanges

Scope of delivery:

- pressure disc, threaded pin and snap ring

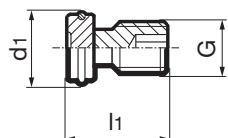

Article no.

4715

for	G	d1 mm	l1 mm	Order no.
60/70/80	M8 x 1	11.5	13	4715 8.010
100/117/14	M10X1	13.6	19	4715 10.010



Floating side lock holders

Article no. **4167**



Product information:

- straight shank d3 with clamping surface
- suitable for conventional and high-performance multi-fluted reamers, because of no angle compensation
- central coolant supply max. 80 bar
- drive surface on tool shank required
- for tool shanks d1 h6
- compensates lateral offset between tool and workpiece
- vibration-free compensation of concentricity and alignment errors
- radial compensation (4)

suitable accessories separately available:

- for other shank Ø reduction sleeves art. no. 4095 available on request
- hexagonal key (2), art. no. 4912
- other sizes and different radial compensation available on request

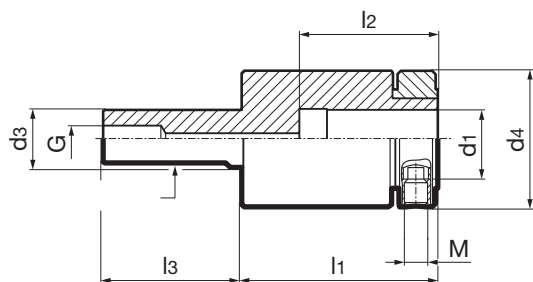

Article no. **4167**

d3 mm	d1 mm	Ø-range mm	d4 mm	l1 mm	l2 mm	l3 mm	M	G	④	Order no.
20	20	14-20	49	75	50	50	M 8	G1/8	0.12	4167 20.020
25	25	16-25	59	85	60	60	M10	G1/4	0.12	4167 25.025
32	32	20-32	80	92	63	80	M12	G3/8	0.12	4167 32.032

Floating holders, short, with side lock holder

Article no. **4169**



Product information:

- straight shank d3 with clamping surface
- suitable for conventional and high-performance multi-fluted reamers, because of no angle compensation
- central coolant supply max. 80 bar
- drive surface on tool shank required
- for tool shanks d1 h6
- compensates lateral offset between tool and workpiece
- vibration-free compensation of concentricity and alignment errors
- radial compensation (4)

suitable accessories separately available:

- for other shank Ø reduction sleeves art. no. 4095 available on request
- hexagonal key (2), art. no. 4912
- other sizes and different radial compensation available on request

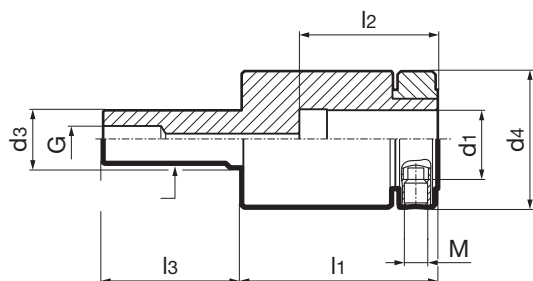

Article no. **4169**

d3 mm	d1 mm	Ø-range mm	d4 mm	l1 mm	l2 mm	l3 mm	M	G	④	Order no.
20	10	4-10	38.5	46	25	40	M 6	G1/8	0.08	4169 10.020
20	16	10-16	49.0	46	29	46	M 8	G1/8	0.10	4169 16.020
20	20	12-20	49.0	46	29	46	M 8	G1/8	0.12	4169 20.020



Floating holders, mini, with side lock holder

Article no. **4174**



Product information:

- shank holder with lateral clamping surface
- suitable for conventional and high-performance multi-fluted reamers, because of no angle compensation
- very compact design for restricted space
- central coolant supply max. 80 bar
- drive surface on tool shank required
- for tool shanks d1 h6
- compensates lateral offset between tool and workpiece
- vibration-free compensation of concentricity and alignment errors
- radial compensation (4)

suitable accessories separately available:

- for other shank Ø reduction sleeves art. no. 4097
- hexagonal key (2), art. no. 4912
- other sizes and different radial compensation available on request

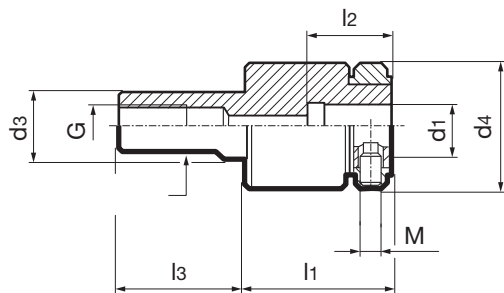

Article no. **4174**

d3 mm	d1 mm	Ø-range mm	d4 mm	l1 mm	l2 mm	l3 mm	M	G	④	Order no.
16	10	4-10	30	35	20	30	M 5	G1/8	0.12	4174 10.016

Floating holders with ER collet chuck holder

Article no. **4098**



Product information:

- straight shank d3 with clamping surface
- suitable for conventional and high-performance multi-fluted reamers, because of no angle compensation
- for the application of internally cooled reamers use metallic sealed collets type DM art. no. 4175
- central coolant supply max. 80 bar
- compensates lateral offset between tool and workpiece
- vibration-free compensation of concentricity and alignment errors
- radial compensation (4)

Scope of delivery:

- collet chucks art. No. 4175 or 4307 as well as clamping keys art. no. 4913
- other sizes and different radial compensation available on request

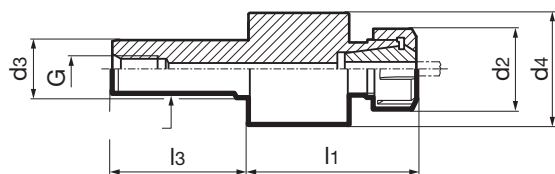

Article no. **4098**

d3 mm	Size	Ø-range mm	d2 mm	d4 mm	l1 mm	l3 mm	G	④	Order no.
16	ER20	1-13	34	49.5	74.0	40	G1/8	0.06	4098 20.016
25	ER20	1-13	34	49.5	74.0	60	G1/4	0.08	4098 20.025
20	ER25	2-16	42	59.0	84.0	50	G1/8	0.06	4098 25.020
25	ER25	2-16	42	59.0	84.0	60	G1/4	0.08	4098 25.025
32	ER32	3-20	50	64.0	91.0	80	G3/8	0.10	4098 32.032
40	ER32	3-20	50	64.0	91.0	80	G1/2	0.12	4098 32.040

Holders fine machining



Floating side lock holders

Article no. **4117**



Product information:

- VDI shank holder with teeth
- suitable for conventional and high-performance multi-fluted reamers, because of no angle compensation
- central coolant supply max. 80 bar
- tool shank with special whistle notch flat necessary
- drive surface on tool shank required
- compensates lateral offset between tool and workpiece
- for tool shanks d1 h6
- vibration-free compensation of concentricity and alignment errors
- radial compensation (4)

suitable accessories separately available:

- for other shank \varnothing reduction sleeves art. no. 4095 available on request
- hexagonal key (2), art. no. 4912
- further sizes on request

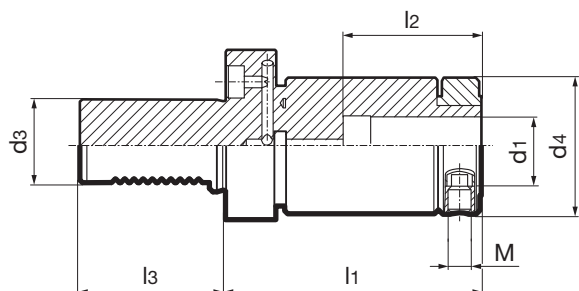

Article no.

4117

d3	d1 mm	\varnothing -range mm	d4 mm	l1 mm	l2 mm	l3 mm	M	④	Order no.
VDI 30	25	16-25	59	111	59	55	M10	0.12	4117 25.030
VDI 40	25	16-25	59	111	59	63	M10	0.12	4117 25.040
VDI 40	32	20-32	80	117	63	63	M12	0.12	4117 32.040
VDI 50	25	16-25	59	111	59	78	M10	0.12	4117 25.050
VDI 50	32	20-32	80	117	63	78	M12	0.12	4117 32.050

Floating holders VDI DIN 69880-1 with ER collet chuck holder

Article no. **4116**



Product information:

- VDI shank holder with teeth
- suitable for conventional and high-performance multi-fluted reamers, because of no angle compensation
- for the application of internally cooled reamers use metallic sealed collets type DM art. no. 4175
- with coolant supply max. 80 bar
- compensates lateral offset between tool and workpiece
- vibration-free compensation of concentricity and alignment errors
- radial compensation (4)

Scope of delivery:

- collet chucks art. No. 4175 or 4307 as well as clamping keys art. no. 4913
- other sizes and different radial compensation available on request

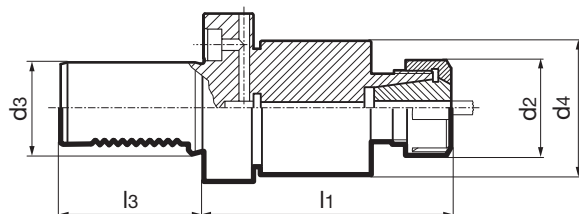

Article no.

4116

d3	Size	\varnothing -range mm	d2 mm	d4 mm	l1 mm	l3 mm	④	Order no.
VDI 30	ER25	2-16	42	59	109	55	0.08	4116 25.030
VDI 40	ER25	2-16	42	59	109	63	0.10	4116 25.040
VDI 40	ER32	3-20	50	64	116	63	0.10	4116 32.040
VDI 50	ER25	2-16	42	59	109	78	0.12	4116 25.050
VDI 50	ER32	3-20	50	64	116	78	0.12	4116 32.050



Reduction sleeves for floating holders

Article no. **4095**



Product information:

- for reducing the clamping diameter in floating holders
- central coolant supply
- drive surface on tool shank required
- applicable in floating holders art. no. 4167 and 4117
- for tool shanks d1 h6

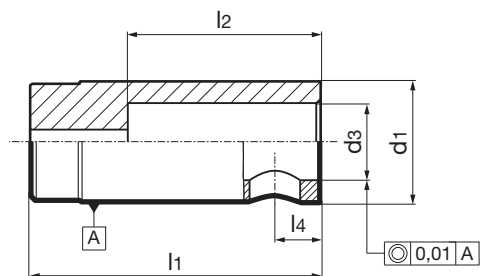

Article no. **4095**

d1 mm	d3 mm	l1 mm	l2 mm	l4 mm	Order no.
20	14	50	40	9.5	4095 14.020
20	16	50	40	9.5	4095 16.020
25	16	60	40	9.5	4095 16.025
25	18	60	40	9.5	4095 18.025
25	20	60	50	9.5	4095 20.025
32	20	63	50	12.5	4095 20.032
32	25	63	60	12.5	4095 25.032

Reduction sleeves for short floating holders

Article no. **4096**



Product information:

- for reducing the clamping diameter in floating holders
- central coolant supply
- drive surface on tool shank required
- applicable in short floating holders art. no. 4169
- for tool shanks d1 h6

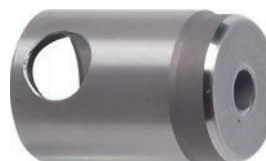
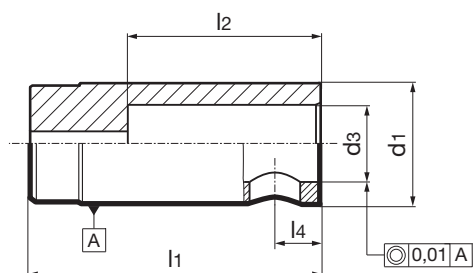

Article no. **4096**

d1 mm	d3 mm	l1 mm	l2 mm	l4 mm	Order no.
10	4	25	10	6.0	4096 4.010
10	6	25		6.0	4096 6.010
10	8	25	20	6.0	4096 8.010
16	10	29	25	7.0	4096 10.016
16	12	29	25	7.0	4096 12.016
20	12	29	25	7.0	4096 12.020
20	14	29	25	7.0	4096 14.020
20	16	29	25	7.0	4096 16.020

Holders fine machining



Reduction sleeves for mini floating holders

Article no. **4097**



Product information:

- for reducing the clamping diameter in floating holders
- central coolant supply
- drive surface on tool shank required
- applicable in mini floating holders art. no. 4174

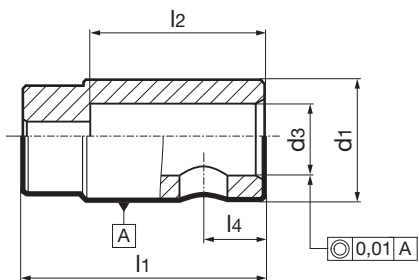

Article no.

4097

d1 mm	d3 mm	l1 mm	l2 mm	l4 mm
10	4	20	15	5.0
10	6	20	15	5.0
10	8	20	15	5.0

Order no.

4097 4.010
4097 6.010
4097 8.010



Collet holders ER metallic sealed

Article no. 4175

Product information:

- DIN ISO 15488
- for application without sealing washer
- concentricity < 6 µm
- for high-performance tools with internal cooling e.g. HR 500 reamers
- clamping force tester for SK/BT/CAT clamping systems in machine tool spindles
- metallic sealing up to coolant pressure of 300 bar
- ER-DM collets with restricted clamping range
- The tool must be clamped at least flush or deeper in the collet. A minimum clamping length of 2/3, as for standard collets, is not possible otherwise there would be no seal.

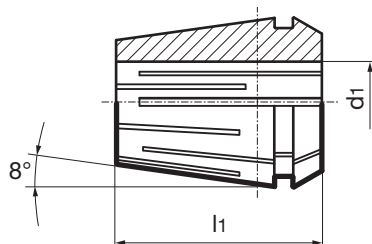

Article no. 4175

Size	d1 h9	l1 mm	Order no.
ER20	3.00	31.5	4175 3.020
ER20	4.00	31.5	4175 4.020
ER20	5.00	31.5	4175 5.020
ER20	6.00	31.5	4175 6.020
ER20	7.00-6.50	31.5	4175 7.020
ER20	8.00-7.50	31.5	4175 8.020
ER20	9.00-8.50	31.5	4175 9.020
ER20	10.00-9.50	31.5	4175 10.020
ER20	11.00-10.50	31.5	4175 11.020
ER20	12.00-11.50	31.5	4175 12.020
ER20	13.00-12.50	31.5	4175 13.020
ER25	6.00	34.0	4175 6.025
ER25	8.00-7.50	34.0	4175 8.025
ER25	10.00-9.50	34.0	4175 10.025
ER25	12.00-11.50	34.0	4175 12.025
ER25	14.00-13.50	34.0	4175 14.025
ER25	16.00-15.50	34.0	4175 16.025
ER32	6.00	40.0	4175 6.032
ER32	8.00-7.50	40.0	4175 8.032
ER32	10.00-9.50	40.0	4175 10.032
ER32	12.00-11.50	40.0	4175 12.032
ER32	14.00-13.50	40.0	4175 14.032
ER32	16.00-15.50	40.0	4175 16.032
ER32	18.00-17.50	40.0	4175 18.032
ER32	20.00-19.50	40.0	4175 20.032

Holdings fine machining



Product information:

- for radial manual HSK tool clamping
- universal application for MQL and high-pressure IC
- the central and coaxial MQL supply with constant internal diameter prevents coolant from consolidating to DIN 69090-2
- for a coolant pressure up to 160 bar
- for clamping HSK-A/C shanks to ISO 12164-1/DIN 69893

Scope of delivery:

- complete as shown in illustration
- installation and operating instructions

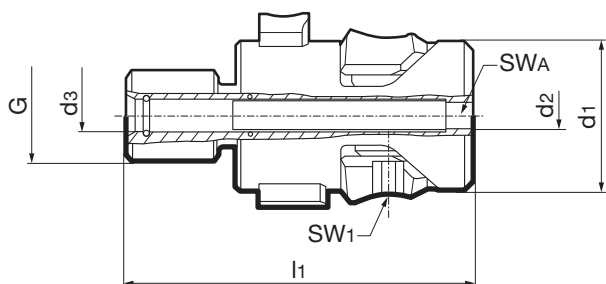

Article no.

4930

Size	d1 mm	d2 mm	d3 mm	l1 mm	G	SW1 mm	SWA mm	Order no.
HSK-32	16.7	3	4.100	41.75	M10	2.5	3.0	4930 24.100
HSK-40	20.6	4	5.100	43.90	M12	3.0	4.0	4930 30.100
HSK-50	25.5	5	7.100	54.20	M16	4.0	5.0	4930 38.100
HSK-50	25.5	5	6.100	54.20	M16	4.0	5.0	4930 38.200
HSK-63	33.0	6	7.100	72.20	M20	5.0	6.0	4930 48.100
HSK-80	41.0	8	10.100	90.20	M24	6.0	8.0	4930 60.100
HSK-100	52.0	10	12.100	107.10	M24	8.0	10.0	4930 75.100



GÜHROCLAMP fittings for MQL 4-point clamping sets, art. no. 4930

Product information:

- retention screw only for adaptor
- if spindle cannot be locked, please use torque socket art. no. 4963
- spindle with clamping segments, art. no. 4931
- ejector with pipe, art. no. 4932

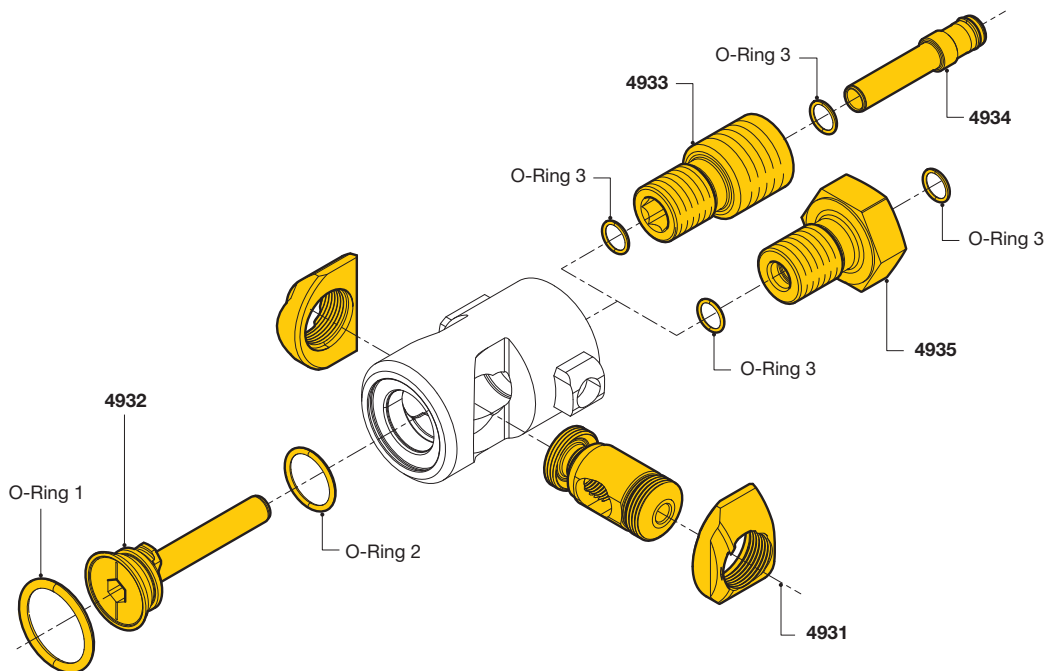

Size	Article no.	Order no.	
		4931	4932
HSK-32	4931 24.000	4932 24.100	
HSK-40	4931 30.000	4932 30.100	
HSK-50	4931 38.000	4932 38.100	
HSK-63	4931 48.000	4932 48.100	
HSK-80	4931 60.000	4932 60.100	
HSK-100	4931 75.000	4932 75.100	



Retention spindles for GÜHROCLAMP MQL 4-point clamp. sets

Article no. **4933**

Product information:

- retention spindle for direct installation in spindle

Scope of delivery:

- complete as shown in illustration

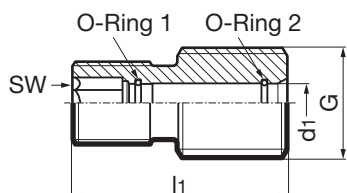

Article no. **4933**

Size	d1 mm	l1 mm	G	SW mm	Order no.
HSK-32	4.1	22.50	M10	4.0	4933 24.100
HSK-40	5.1	23.00	M12	5.0	4933 30.100
HSK-50	7.1	27.00	M16	6.0	4933 38.100
HSK-50	6.1	27.00	M16	6.0	4933 38.200
HSK-63	7.1	39.00	M20	8.0	4933 48.100
HSK-80	10.1	50.00	M24	10.0	4933 60.100
HSK-100	12.1	60.00	M24	12.0	4933 75.100

Adaptor for GÜHROCLAMP MQL 4-point clamping sets

Article no. **4934**

Product information:

- adaptor for direct installation in spindle and spindle adaptor (integrated) for coolant supply and sealing

Scope of delivery:

- complete as shown in illustration

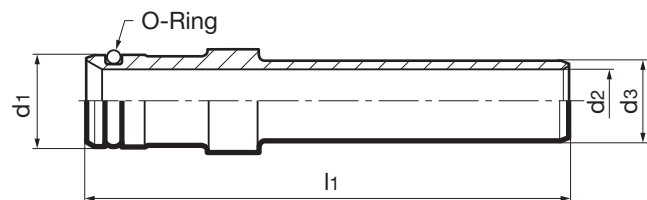

Article no. **4934**

Size	d1 mm	d2 mm	d3 mm	l1 mm	Order no.
HSK-32	4.0	2.0	4.0	14	4934 24.100
HSK-40	5.0	3.0	5.0	28	4934 30.100
HSK-50	6.0	4.0	7.0	28	4934 38.100
HSK-50	6.0	4.0	6.0	28	4934 38.200
HSK-63	8.0	5.5	7.0	42	4934 48.100
HSK-80	10.2	7.5	10.0	56	4934 60.100
HSK-100	12.0	9.5	12.0	60	4934 75.100



Retention screw for GÜHROCLAMP MQL 4-point clamping sets

Article no. **4935**

Product information:

- necessary for installation of MQL 4-point clamping set in spindle adaptors and module adaptor flange art. no. 4363, 4386, 4387 and 4713
- change against standard retention bolt
- clamping set replacement possible with internal hexagon, without flange disassembly of machine spindle

Scope of delivery:

- complete as shown in illustration

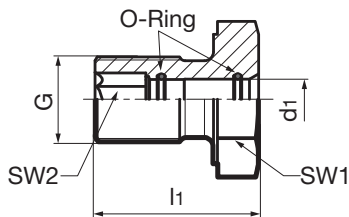

Article no. **4935**

Size	d1 mm	G	l1 mm	SW1 mm	SW2 mm	Mt max. Nm	Order no.
HSK-32	4.1	M 8 X0.75	23.5	13	4	14	4935 24.100
HSK-40	5.1	M10 X1	21.0	16	5	30	4935 30.100
HSK-50	7.1	M12 X1	25.0	18	6	60	4935 38.100
HSK-50	6.1	M12 X1	25.0	18	6	60	4935 38.200
HSK-63	7.1	M15 X1	29.0	24	8	110	4935 48.100
HSK-80	10.1	M18 X1.5	36.0	24	10	180	4935 60.100
HSK-100	12.1	M22 X1.5	46.5	32	12	200	4935 75.100

M contour clamping sets for MQL and IC

Article no. **4615**

Product information:

- for clamping HSK-A/C shanks to ISO 12164-1/DIN 69893
- the central and coaxial MQL supply with constant internal diameter prevents coolant from consolidating to DIN 69090-2
- for radial manual HSK tool clamping
- HSK clamping sets compatible with M contour spindles and adaptors
- universal application for MQL and high-pressure IC
- for a coolant pressure up to 160 bar
- spindle connection dimensions available on request

Scope of delivery:

- incl. adaptor with through hole for uninterrupted coolant supply
- including installation and operating instructions

suitable accessories separately available:

- adaptor with pin, art. no. 4616

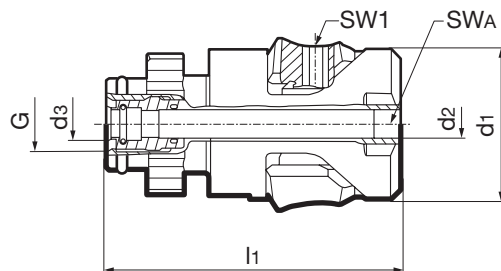

Article no. **4615**

Size	d1 mm	d2 mm	d3 mm	l1 mm	G	SW1 mm	SWA mm	Order no.
HSK-32	16.7	3.0	4.100	43.4	M8 x 1	2.5	3.0	4615 24.000
HSK-40	20.6	4.0	5.100	48.3	M10X1	3.0	4.0	4615 30.000
HSK-50	22.5	5.0	6.100	55.3	M12X1	4.0	5.0	4615 38.000
HSK-50	25.5	5.0	7.100	55.3	M12X1	4.0	5.0	4615 38.100
HSK-63	33.0	6.0	7.100	64.7	M12X1	5.0	6.0	4615 48.000
HSK-80	41.0	8.0	10.100	75.3	M16X1	6.0	8.0	4615 60.000
HSK-100	52.0	10.0	12.100	94.5	M18X1	8.0	10.0	4615 75.000



Adaptor with spigot transition for M contour clamping set

Article no. **4616**

Product information:

- application on M contour clamping sets art. no. 4615 instead of adaptor with coolant transfer hole
- adaptor for spindles without coolant tube for uninterrupted coolant supply
- universal application for MQL and high-pressure IC
- for a coolant pressure up to 160 bar
- spindle connection dimensions available on request

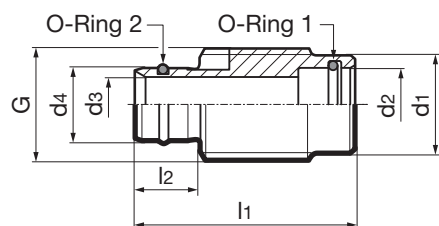

Article no. **4616**

Size	d1 mm	d2 mm	d3 mm	d4 mm	l1 mm	l2 mm	G	Order no.
HSK-C 32		3.5	3	5.0	14.4	5.4	M8 x 1	4616 24.000
HSK-C 40	7.7	4.5	4	6.0	22.0	6.5	M10 X1	4616 30.000
HSK-C 50	8.5	5.5	5	8.0	23.0	7.5	M12 X1	4616 38.000
HSK-C 63	10.6	7.0	6	8.0	24.0	7.0	M12 X1	4616 48.000
HSK-C 80		10.0	8	11.3	23.3	8.3	M16 x 1	4616 60.000
HSK-C 100		12.0	10	13.8	30.6	9.6	M18 x 1	4616 75.000

Assembly/disassembly tool for M contour clamping sets

Article no. **4624**

Product information:

- for the assembly and disassembly of M contour clamping sets art. no. 4615

HSK clamping technology

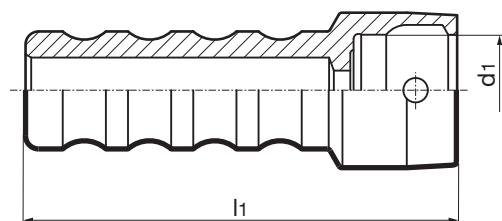

Article no. **4624**

Size	d1 mm	l1 mm	Order no.
HSK 32	17	118.7	4624 32.000
HSK 40	21	121.6	4624 40.000
HSK 50	26	127.5	4624 50.000
HSK 63	34	132.0	4624 63.000
HSK 80	42	143.0	4624 80.000
HSK 100	53	152.0	4624 100.000



Assembly/disassembly tool for MQL and M-contour clamping sets

Article no. **4986**

Product information:

- for assembling and disassembling ejectors for MQL clamping sets, art. no. 4930, and M-contour clamping sets, art. no. 4615

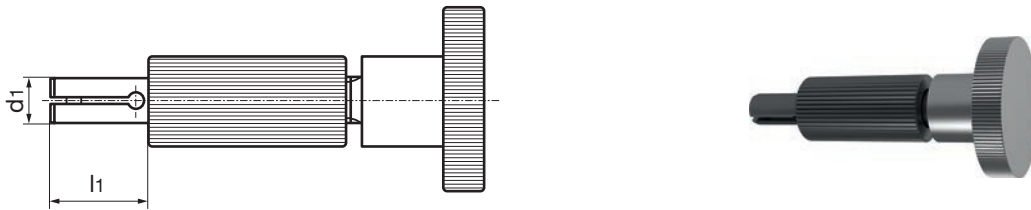

Article no. **4986**

Size	d1 mm	l1 mm	Order no.
HSK 32	3	9	4986 3.032
HSK 40	4	9	4986 4.040
HSK 50	5	11	4986 5.050
HSK 63	6	12	4986 6.063
HSK 80	8	15	4986 8.080
HSK 100	10	15	4986 10.100



Product information:

- for clamping HSK-A/C shanks to ISO 12164-1/DIN 69893
- for radial manual HSK tool clamping
- for a coolant pressure up to 80 bar

Scope of delivery:

- including installation and operating instructions

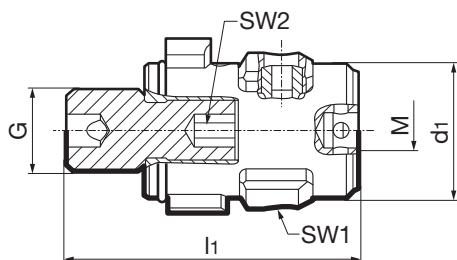

Article no. **4958**

Size	d1 mm	l1 mm	G	M	SW1 mm	SW2 mm	Order no.
HSK-C 25	13.8	30.30	M8	M4	2.5	3.0	4958 19.000
HSK-C 32	16.7	35.75	M10	M5	2.5	4.0	4958 24.000
HSK-C 40	20.6	43.70	M12	M6	3.0	5.0	4958 30.000
HSK-C 50	25.5	53.70	M16	M8	4.0	6.0	4958 38.000
HSK-C 63	33.0	71.20	M20	M10	5.0	8.0	4958 48.000
HSK-C 80	41.0	90.10	M24	M12	6.0	10.0	4958 60.000



Component parts f. 4-point clamp. set art. no. 4958, set



Product information:

- 6-piece spare parts set, consisting of:
 - Clamping segment set
 - Threaded spindle for clamping segment set
 - Mounting spindle for 4-point clamping sets, art. no. 4958
 - Ejector set consisting of ejector, snap ring and o ring
 - Fixing screw for flange, art. no. 4386 and art. no. 4387

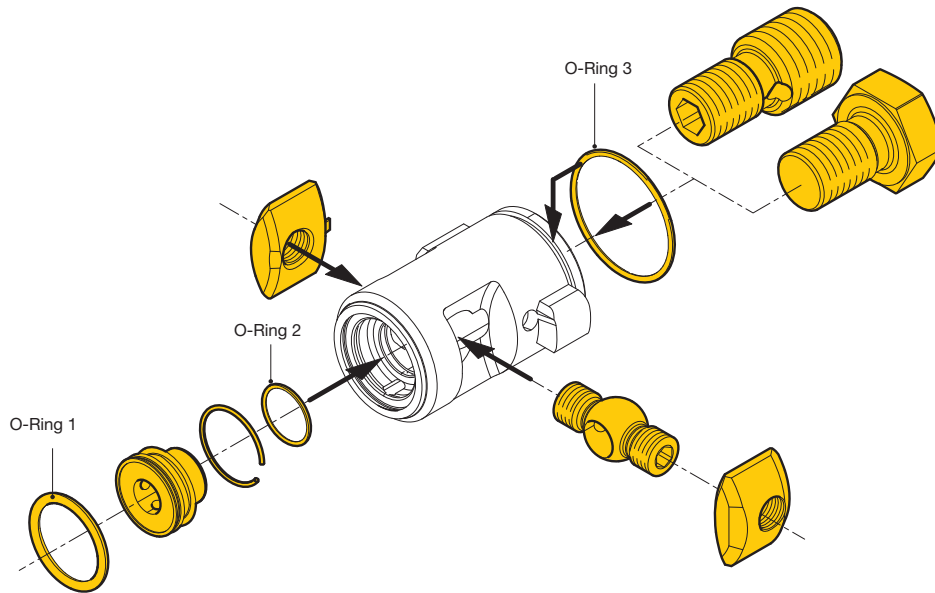

Article no.	4959
Order no.	
	4959 19.000
	4959 24.000
	4959 30.000
	4959 38.000
	4959 48.000
	4959 60.000

Size
HSK-C 25
HSK-C 32
HSK-C 40
HSK-C 50
HSK-C 63
HSK-C 80



HSK spindle adaptors (in front)

Article no. **4386**



Product information:

- for holding HSK-A/C shanks according to ISO 12164-1/DIN 69893
- radially alignable
- for the transferable torsional moment the interface between spindle and flange has to be taken into consideration

Scope of delivery:

- incl. clamping set art. no. 4958 for conventional cooling
- incl. brass lock ring art. no. 4953
- incl. indexing pin and retention screws

suitable accessories separately available:

- order for MQL application art. no. 4713

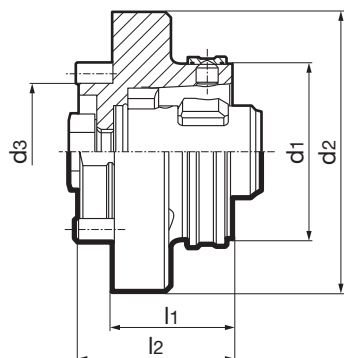

Article no. **4386**

d1	d2 mm	d3 mm	l1 mm	l2 mm	SW mm	Order no.
HSK-C 25	45	23	20	28	2.5	4386 19.000
HSK-C 32	60	30	26	36	2.5	4386 24.000
HSK-C 40	70	35	30	40	3.0	4386 30.000
HSK-C 50	80	40	35	45	4.0	4386 38.000
HSK-C 63	100	50	43	55	5.0	4386 48.000
HSK-C 80	117	60	50	62	6.0	4386 60.000

Module 4x4 HSK adaptor flanges

Article no. **4713**



Product information:

- for holding HSK-A/C shanks according to ISO 12164-1/DIN 69893
- for the highly accurate radial and axial alignment on alignment adaptors or machine spindles
- suitable for MQL and conventional cooling
- for the transferable torsional moment the interface between spindle and flange has to be taken into consideration

Scope of delivery:

- incl. MQL 4-point clamping set art. no. 4930
- incl. retention screw art. no. 4935
- incl. brass lock ring art. no. 4953
- incl. 4 angle alignment units, art. no. 4715
- incl. 4 clamping screws
- incl. adaptor sleeve (1), art. no. 4716

HSK clamping technology

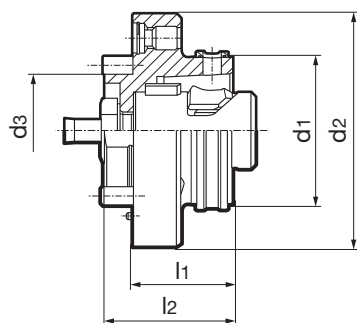

Article no. **4713**

d1	d2 mm	d3 mm	l1 mm	l2 mm	①	Order no.
HSK-C 32	60	30	26	36	4716 24.060	4713 24.060
HSK-C 40	70	35	30	40	4716 30.070	4713 30.070
HSK-C 50	80	40	35	45	4716 238.080	4713 38.080
HSK-C 63	100	50	43	55	4716 48.100	4713 48.100
HSK-C 80	117	60	50	62	4716 60.117	4713 60.117
HSK-C 100	140	80	75	87	4716 75.140	4713 75.140



Spindle mounting flange HSK

Article no. **4385**



Product information:

- for holding HSK-A/C shanks according to ISO 12164-1/DIN 69893
- radially alignable
- for the transferable torsional moment the interface between spindle and flange has to be taken into consideration

Scope of delivery:

- incl. clamping set, art. no. 4958, for conventional cooling (for nominal size 100, art. no. 4930)
- incl. brass lock ring art. no. 4953
- incl. indexing pin and retention screws

suitable accessories separately available:

- for MQL version, order no. 4385 xx.100

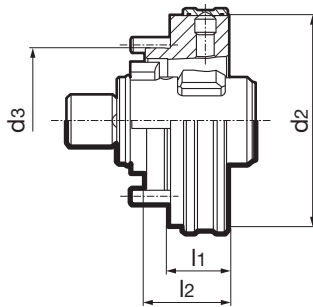

Article no.

4385

for	d2 mm	d3 mm	l1 mm	l2 mm	SW mm	Order no.
HSK-C 32	40	27	12	16	2.5	4385 24.000
HSK-C 32	40	27	12	16	2.5	4385 24.100
HSK-C 40	50	33	15	20	3.0	4385 30.000
HSK-C 40	50	33	15	20	3.0	4385 30.100
HSK-C 50	63	42	17	25	4.0	4385 38.000
HSK-C 50	63	42	17	25	4.0	4385 38.100
HSK-C 63	80	55	22	32	5.0	4385 48.000
HSK-C 63	80	55	22	32	5.0	4385 48.100
HSK-C 80	100	68	27	40	6.0	4385 60.000
HSK-C 80	100	68	27	40	6.0	4385 60.100
HSK-C 100	125	88	30	50	8.0	4385 75.000



Product information:

- for the conversion of SK to HSK-A/C interfaces to ISO 12163-1/DIN 69893-1
- radially alignable

Scope of delivery:

- incl. clamping set art. no. 4958 for conventional cooling
- incl. retention screws

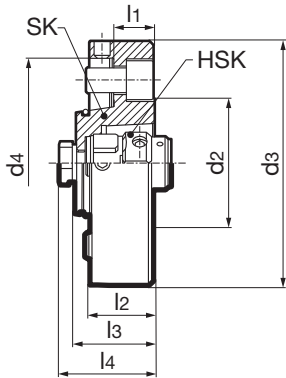

Article no.

4387

for	for	d2 mm	d3 mm	d4 mm	l1 mm	l2 mm	l3 mm	l4 mm	SW mm
SK 30	HSK-C 40	50	85	69.83	25	35	37.0	39.0	3
SK 40	HSK-C 50	63	100	88.88	20	30	39.5	41.5	4
SK 50	HSK-C 63	80	150	128.57	25	40	48.5	50.5	5
SK 50	HSK-C 80	100	150	128.57	40	55	61.1	63.1	6

Order no.

4387 30.030

4387 40.038

4387 50.048

4387 50.060



HSK-A/HSK-C reductions

Article no. **4355**



Product information:

- HSK-C according to ISO 12164-1/DIN 69893-1
- for holding HSK-A/C shanks according to ISO 12164-1/DIN 69893

Scope of delivery:

- incl. clamping set art. no. 4958 for conventional cooling
- incl. brass lock ring art. no. 4953

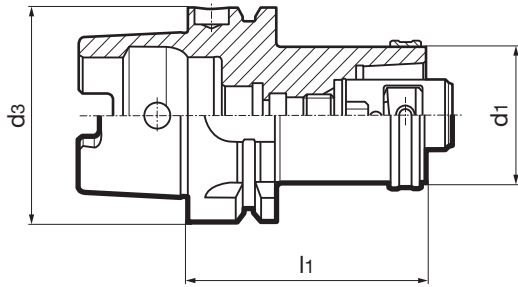

Article no. **4355**

d3	d1 mm	l1 mm	SW mm	Order no.
HSK-A 40	32	60	2.5	4355 32.040
HSK-A 50	32	60	2.5	4355 32.050
HSK-A 50	40	70	3.0	4355 40.050
HSK-A 63	50	80	4.0	4355 50.063
HSK-A 63	32	60	2.5	4355 32.063
HSK-A 63	40	70	3.0	4355 40.063
HSK-A 80	63	100	5.0	4355 63.080
HSK-A 80	50	90	4.0	4355 50.080
HSK-A 100	63	100	5.0	4355 63.100
HSK-A 100	50	90	4.0	4355 50.100
HSK-A 100	80	120	6.0	4355 80.100



Extensions HSK-A/HSK-C with MQL 4-point clamping set

Article no. **4350**



Product information:

- HSK-A according to ISO 12164-1 / DIN 69893-1
- for holding HSK-A/C shanks according to ISO 12164-1/DIN 69893
- for MQL 1 systems

Scope of delivery:

- incl. MQL 4-point clamping set art. no. 4930 and adaptor for extensions
- incl. brass lock ring art. no. 4953

suitable accessories separately available:

- coolant transfer set, art. no. 4949
- order MQL coolant transfer set separately:
 - for automatic tool change cycle, art. no . 4939 (for HSK32 art. no . 4508), for manual tool change cycle, art. no . 4940 (for HSK32 art. no. 4513)

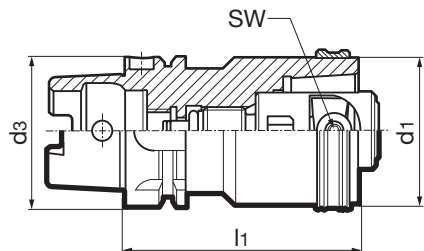

Article no. **4350**

d1 / d3	l1 mm	SW mm	Order no.
HSK-A 32	60	2.5	4350 60.032
HSK-A 40	80	3.0	4350 80.040
HSK-A 50	80	4.0	4350 80.050
HSK-A 50	100	4.0	4350 100.050
HSK-A 63	100	5.0	4350 100.063
HSK-A 63	140	5.0	4350 140.063
HSK-A 80	120	6.0	4350 120.080
HSK-A 80	160	6.0	4350 160.080
HSK-A 100	140	8.0	4350 140.100

Extensions HSK-C

Article no. **4351**

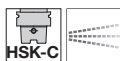

Product information:

- HSK-C according to ISO 12164-1/DIN 69893-1
- for holding HSK-A/C shanks according to ISO 12164-1/DIN 69893

Scope of delivery:

- incl. clamping set art. no. 4958 for conventional cooling
- incl. brass lock ring art. no. 4953

HSK clamping technology

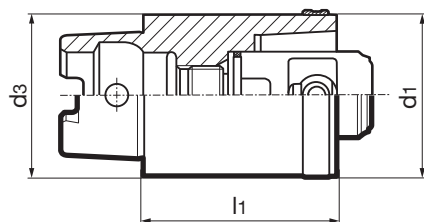

Article no. **4351**

d1 / d3	l1 mm	SW mm	Order no.
HSK-C 25	40	2.5	4351 40.025
HSK-C 32	40	2.5	4351 40.032
HSK-C 40	50	3.0	4351 50.040
HSK-C 50	60	4.0	4351 60.050
HSK-C 63	80	5.0	4351 80.063



Torque supports

Article no. **4963**

Product information:

- for the installation of 4-point clamping sets, if there are difficulties locking the spindle

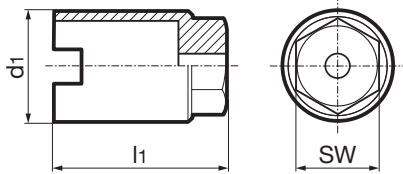

Article no. **4963**

for	d1 mm	l1 mm	SW mm	Order no.
HSK 25	17.5	25	15.0	4963 19.000
HSK 32	22.5	32	17.0	4963 24.000
HSK 40	28.0	40	19.0	4963 30.000
HSK 50	36.0	50	24.0	4963 38.000
HSK 63	45.0	60	30.0	4963 48.000
HSK 80	56.0	80	36.0	4963 60.000
HSK 100	70.0	95	36.0	4963 75.000



PowerClamp sets

Article no. **4554**



Product information:

- for clamping HSK-A/C shanks to ISO 12164-1/DIN 69893
- for a coolant pressure up to 80 bar
- The internal coolant supply is via the cage. It is floating mounted and ensures a coolant seal above 6 bar pressure.
- clamping sets are not suitable for MQL

Scope of delivery:

- including installation and operating instructions
- incl. threaded pin art. no. 4551

suitable accessories separately available:

- hexagonal key art. no. 4912
- compression spring and threaded pin for art. no. 4551
- threaded spindle, art. no. 4555
- clamping nut set, art. no. 4557
- O-ring 1 & O-ring 2 available on request

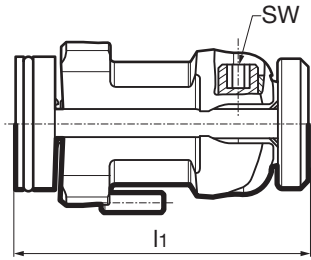

Article no. **4554**

Size	l1 mm	SW mm	Order no.
HSK-C 25	32.1	2.0	4554 19.000
HSK-C 32	41.6	2.5	4554 24.000
HSK-C 40	49.7	3.0	4554 30.000
HSK-C 50	62.2	4.0	4554 38.000
HSK-C 63	74.1	5.0	4554 48.000
HSK-C 80	96.1	6.0	4554 60.000
HSK-C 100	117.0	8.0	4554 75.000



Component parts for PowerClamp sets art. no. 4554

Product information:

- consisting of:
 - Clamping nut set, art. no. 4557
 - Threaded spindle, art. no. 4555
 - Compression spring and threaded pin, art. no. 4551

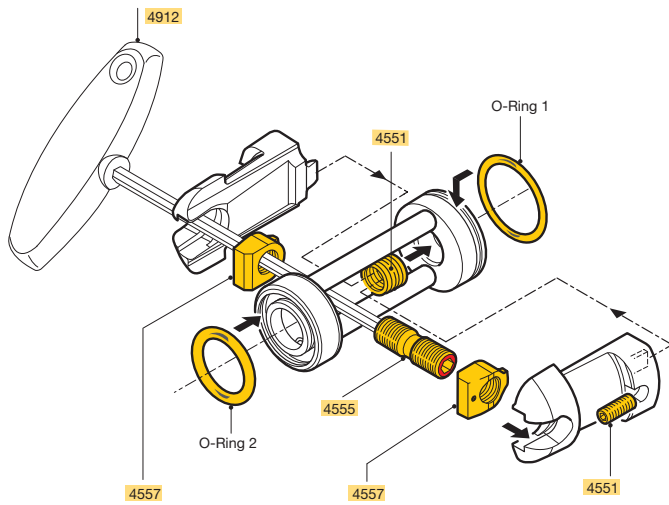

Size	Article no.	4557	4555	4551
		Order no.		
HSK-C 25		4557 1.019	4555 2.019	4551 3.019
HSK-C 32		4557 1.024	4555 2.024	4551 3.024
HSK-C 40		4557 1.030	4555 2.030	4551 3.030
HSK-C 50		4557 1.038	4555 2.038	4551 3.038
HSK-C 63		4557 1.048	4555 2.048	4551 3.048
HSK-C 80		4557 1.060	4555 2.060	4551 3.060
HSK-C 100		4557 1.075	4555 2.075	4551 3.075



HSK spindle adaptors (in front)

Article no. **4581**



Product information:

- for holding HSK-A/C shanks according to ISO 12164-1/DIN 69893
- for conventional cooling from 6 to max. 80 bar
- radially alignable
- for the transferable torsional moment the interface between spindle and flange has to be taken into consideration

Scope of delivery:

- incl. clamping set, art. no. 4554
- incl. brass lock ring art. no. 4953
- incl. indexing pin and retention screws

suitable accessories separately available:

- hexagonal key art. no. 4912

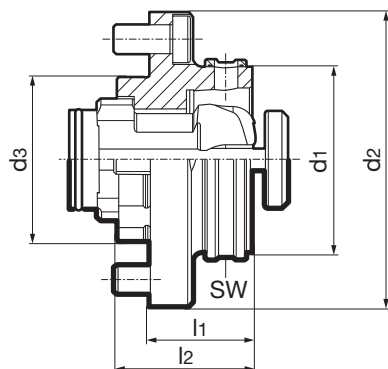

Article no.

4581

d1	d2 mm	d3 mm	l1 mm	l2 mm	SW mm	Order no.
HSK-C 25	45	23	20.0	26.5	2.0	4581 19.000
HSK-C 32	55	28	17.5	23.0	2.5	4581 24.000
HSK-C 40	63	36	22.5	29.0	3.0	4581 30.000
HSK-C 50	80	46	27.5	36.0	4.0	4581 38.000
HSK-C 63	100	56	35.0	46.0	5.0	4581 48.000
HSK-C 80	125	66	45.0	58.0	6.0	4581 60.000
HSK-C 100	160	86	57.0	72.0	8.0	4581 75.000



HSK spindle adaptors (in front)

Article no. **4586**



Product information:

- for holding HSK-A/C shanks according to ISO 12164-1/DIN 69893
- for conventional cooling from 6 to max. 80 bar
- radially alignable
- for the transferable torsional moment the interface between spindle and flange has to be taken into consideration

Scope of delivery:

- incl. clamping set, art. no. 4554
- incl. brass lock ring art. no. 4953
- incl. indexing pin and retention screws

suitable accessories separately available:

- hexagonal key art. no. 4912

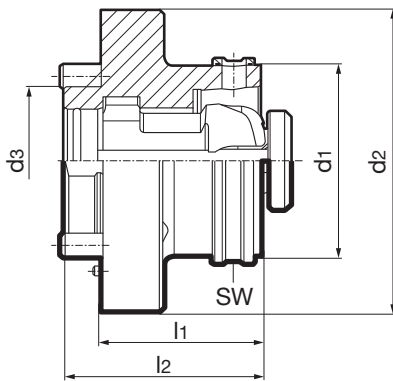

Article no.

4586

d1	d2 mm	d3 mm	l1 mm	l2 mm	SW mm	Order no.
HSK-C 40	70	35	32.5	42.5	3	4586 30.000
HSK-C 50	80	40	43.0	53.0	4	4586 38.000
HSK-C 63	100	50	53.0	65.0	5	4586 48.000
HSK-C 80	117	60	73.0	85.0	6	4586 60.000
HSK-C 100	140	80	94.0	106.0	8	4586 75.000



HSK adaptors for turning centres

Article no. 4582



Product information:

- for holding HSK-A/C shanks according to ISO 12164-1/DIN 69893
- incl. setting element to eliminate drive play with vertical tools
- for fixed tools
- for conventional cooling from 6 to max. 80 bar
- for the transferable torsional moment the interface between spindle and flange has to be taken into consideration

Scope of delivery:

- incl. clamping set, art. no. 4554
- incl. indexing pin and retention screws
- incl. brass lock ring art. no. 4953

suitable accessories separately available:

- hexagonal key art. no. 4912

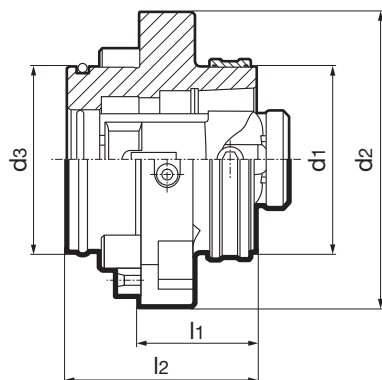

Article no.

4582

d1	d2	d3	l1	l2	SW	Order no.
HSK-C 50	84	50	35	55.0	4	4582 38.100
HSK-C 50	84	50	35	55.0	4	4582 38.200
HSK-C 63	100	63	40	64.5	5	4582 48.100
HSK-C 63	100	63	40	64.5	5	4582 48.200

Spindle mounting flange HSK

Article no. 4584



Product information:

- for holding HSK-A/C shanks according to ISO 12164-1/DIN 69893
- with larger axial plane
- for conventional cooling from 6 to max. 80 bar
- radially alignable
- for the transferable torsional moment the interface between spindle and flange has to be taken into consideration

Scope of delivery:

- incl. clamping set, art. no. 4554
- incl. brass lock ring art. no. 4953
- incl. threaded pin art. no. 4551 and tensioning screws

suitable accessories separately available:

- hexagonal key art. no. 4912

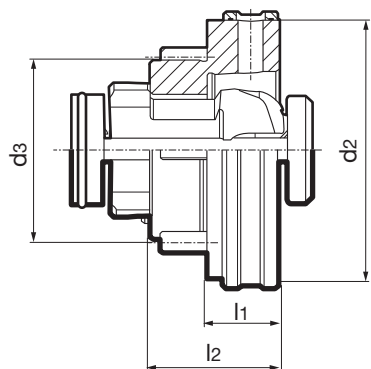

Article no.

4584

for	d2	d3	l1	l2	SW	Order no.
HSK-C 32	40	27	12.5	21.10	2.5	4584 24.000
HSK-C 40	50	33	15.0	25.70	3.0	4584 30.000
HSK-C 50	63	42	17.5	32.10	4.0	4584 38.000
HSK-C 63	80	55	22.5	40.05	5.0	4584 48.000
HSK-C 80	100	68	27.5	51.40	6.0	4584 60.000
HSK-C 100	125	88	30.0	64.00	8.0	4584 75.000



SK / HSK-C basic adaptors

Article no. 4512



Product information:

- ISO taper to DIN ISO 7388-1 form AD
- for conventional cooling from 6 to max. 80 bar
- for holding HSK-A/C shanks according to ISO 12164-1/DIN 69893
- code no. 50, 100 only for presetting device (observe load limit SK50)
- form AF on request

Scope of delivery:

- incl. clamping set, art. no. 4554
- incl. brass lock ring art. no. 4953

suitable accessories separately available:

- hexagonal key art. no. 4912
- ISO pull studs art. no. 4925, 4926

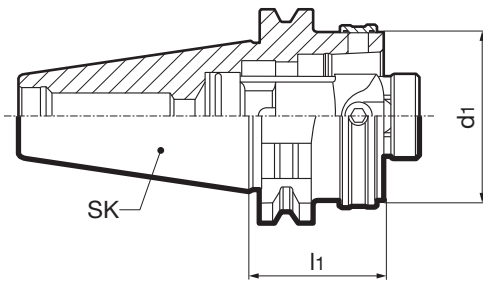

Article no. 4512

SK	d1	l1 mm	SW mm	Order no.
SK 40	HSK-C 32	40	2.5	4512 40.032
SK 40	HSK-C 40	40	3.0	4512 40.040
SK 40	HSK-C 50	40	4.0	4512 40.050
SK 40	HSK-C 63	70	5.0	4512 40.063
SK 50	HSK-C 32	40	2.5	4512 50.032
SK 50	HSK-C 40	40	3.0	4512 50.040
SK 50	HSK-C 50	40	4.0	4512 50.050
SK 50	HSK-C 63	40	5.0	4512 50.063
SK 50	HSK-C 80	70	6.0	4512 50.080
SK 50	HSK-C 100	100	8.0	4512 50.100



MAS/BT / HSK-C basic adaptors

Article no. **4514**



Product information:

- MAS/BT to DIN ISO 7388-2 form JD
- for holding HSK-A/C shanks according to ISO 12164-1/DIN 69893
- for conventional cooling from 6 to max. 80 bar

Scope of delivery:

- incl. clamping set, art. no. 4554
- incl. brass lock ring art. no. 4953

suitable accessories separately available:

- hexagonal key art. no. 4912
- BT pull studs art. nr. 4927, 4928

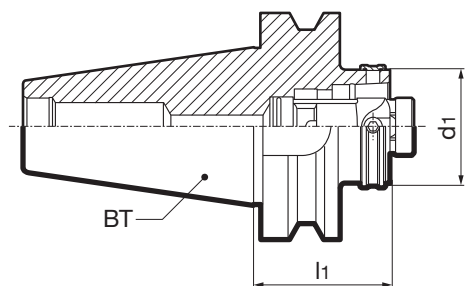

Article no. **4514**

BT	d1	l1 mm	SW mm	Order no.
BT 40	HSK-C 40	40	3.0	4514 40.040
BT 40	HSK-C 50	40	4.0	4514 40.050
BT 40	HSK-C 63	80	5.0	4514 40.063
BT 50	HSK-C 40	50	3.0	4514 50.040
BT 50	HSK-C 50	60	4.0	4514 50.050
BT 50	HSK-C 63	60	5.0	4514 50.063

CAT / HSK-C basic adaptors

Article no. **4003**



Product information:

- ANSI/CAT according to ASME B5.50
- for conventional cooling lubrication

Scope of delivery:

- clamping set
- incl. clamping set, art. no. 4554
- incl. brass lock ring art. no. 4953

suitable accessories separately available:

- hexagonal key art. no. 4912
- CAT pull studs on request

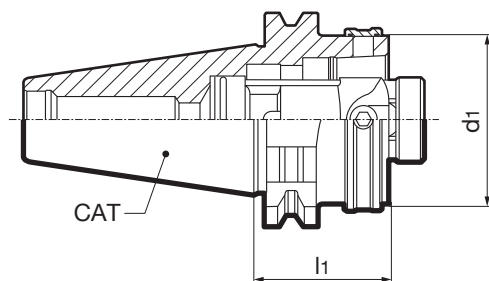

Article no. **4003**

CAT	d1	l1 mm	SW mm	Order no.
CAT 40	HSK-C 63	75	5	4003 40.063
CAT 50	HSK-C 63	75	5	4003 50.063



Extensions HSK-A/HSK-C

Article no. 4549



Product information:

- HSK-A according to ISO 12164-1 / DIN 69893-1
- for holding HSK-A/C shanks according to ISO 12164-1/DIN 69893
- for conventional cooling from 6 to max. 80 bar

Scope of delivery:

- incl. clamping set, art. no. 4554
- incl. brass lock ring art. no. 4953

suitable accessories separately available:

- coolant supply set art. no. 4949
- use art. no. 4350 for MQL machining

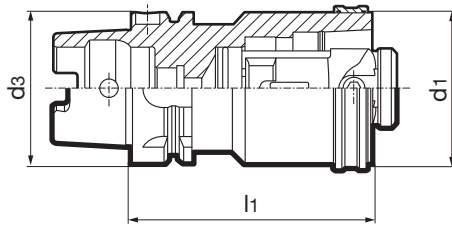

Article no. 4549

d1 / d3	l1 mm	SW mm	Order no.
HSK-A 32	60	2.5	4549 60.032
HSK-A 40	80	3.0	4549 80.040
HSK-A 50	80	4.0	4549 80.050
HSK-A 50	100	4.0	4549 100.050
HSK-A 63	100	5.0	4549 100.063
HSK-A 63	140	5.0	4549 140.063
HSK-A 80	120	6.0	4549 120.080
HSK-A 80	160	6.0	4549 160.080
HSK-A 100	140	8.0	4549 140.100
HSK-A 100	200	8.0	4549 200.100



Product information:

- for short spindles to DIN 69002-3

Scope of delivery:

- incl. clamping screws and brass locking ring

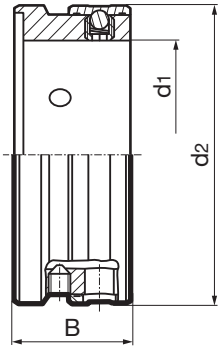

Article no.

4976

Size	d1 mm	1/min	d2 mm	B mm	Order no.
25X20	25.0	10000	35.0	15.7	4976 20.015
32X25	32.0	9000	42.5	19.7	4976 25.019
32X30	32.0	9000	43.5	19.7	4976 30.019
40X35	40.0	8000	54.0	21.7	4976 35.021
50X45	50.0	7000	68.0	24.7	4976 45.024
63X55	63.0	6000	82.0	31.7	4976 55.031



Brass locking rings

Article no. **4953**

Product information:

- the pressure ball screw must be secured with Loctite 222

Scope of delivery:

- incl. pressure ball screw (1), art. no. 4961

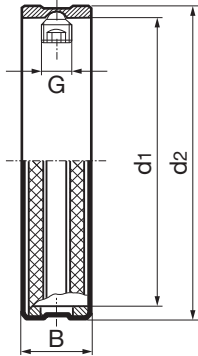

Article no.

4953

Size	d1 mm	d2 mm	B mm	G	①	Order no.
HSK-C 25	25	28.0	7	M 3.5	4961 3.500	4953 25.000
HSK-C 32	32	35.0	7	M 4	4961 4.000	4953 32.000
HSK-C 40	40	43.5	9	M 5	4961 5.000	4953 40.000
HSK-C 50	50	54.0	11	M 6	4961 6.000	4953 50.000
HSK-C 63	63	68.0	14	M 8	4961 8.000	4953 63.000
HSK-C 80	80	85.0	17	M10	4961 10.000	4953 80.000
HSK-C 100	100	105.0	23	M12	4961 12.000	4953 100.000
HSK-D 32	32	35.0	7	M 3.5	4961 3.500	4953 32.019
HSK-D 40	40	43.5	9	M 4	4961 4.000	4953 40.024
HSK-D 50	50	54.0	11	M 5	4961 5.000	4953 50.030
HSK-D 60	63	68.0	14	M 6	4961 6.000	4953 63.038
HSK-D 80	80	85.0	17	M 8	4961 8.000	4953 80.048
HSK-D 100	100	105.0	23	M10	4961 10.000	4953 100.060
HSK-D 125	125	130.0	23	M12	4961 12.000	4953 125.075



Pressure ball screws

Article no. **4961**

Product information:

- minimum order quantity 5 units

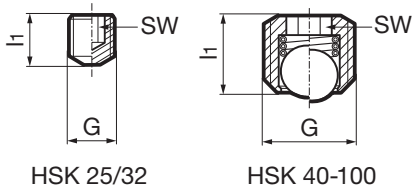

Article no.

4961

for	l1 mm	G	SW mm	Order no.
HSK 25	3.4	M 3.5	2.0	4961 3.500
HSK 32	4.3	M 4	2.0	4961 4.000
HSK 32	4.0	M 4	2.0	4961 4.001
HSK 40	4.6	M 5	2.5	4961 5.000
HSK 50	5.4	M 6	3.0	4961 6.000
HSK 63	7.0	M 8	4.0	4961 8.000
HSK 80	9.2	M10	5.0	4961 10.000
HSK 100	11.4	M12	6.0	4961 12.000



Taper measuring gauge for HSK tool shanks

Article no. **4968**

Product information:

- calibration on request

Scope of delivery:

- incl. calibrated setting gauge and measuring instructions
- supplied in wooden case with inspection protocol

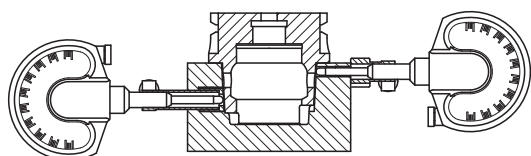

Article no. **4968**

	for	Order no.
	HSK 25	4968 19.100
	HSK 32	4968 24.100
	HSK 40	4968 30.100
	HSK 50	4968 38.100
	HSK 63	4968 48.100
	HSK 80	4968 60.100
	HSK 100	4968 75.100



Product information:

- calibration on request

Scope of delivery:

- incl. calibrated setting gauge and measuring instructions
- in plastic case with test report

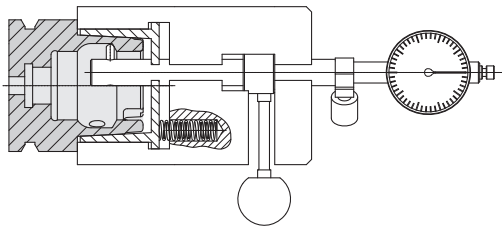

Article no. **4978**

	for	Order no.
	HSK 25	4978 19.000
	HSK 32	4978 24.000
	HSK 40	4978 30.000
	HSK 50	4978 38.000
	HSK 63	4978 48.000
	HSK 80	4978 60.000
	HSK 100	4978 75.000



Measuring gauges for HSK spindles

Article no. 4969

Product information:

- calibration on request

Scope of delivery:

- incl. calibrated setting gauge and measuring instructions
- supplied in a sturdy case with inspection protocol

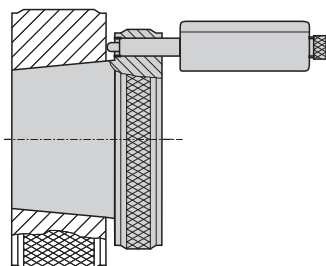

Article no. **4969**

for	Order no.
HSK 25	4969 19.000
HSK 32	4969 24.000
HSK 40	4969 30.000
HSK 50	4969 38.000
HSK 63	4969 48.000
HSK 80	4969 60.000
HSK 100	4969 75.000



ISO taper proofing bars

Article no. **4970**



Product information:

- ISO taper shank similar to DIN ISO 7388-1
- to proof concentricity at machine spindles
- further calibration on request

Scope of delivery:

- proofing arbor with test report in wooden box for vertical storage

suitable accessories separately available:

- for BT shortened special tightening bolts, art. no. 4927, 4928

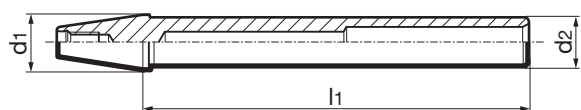

Article no. **4970**

d1	d2 mm	l1 mm	Order no.
SK 40	40	320	4970 300.040
SK 50	50	320	4970 300.050

HSK proofing bars

Article no. **4971**



Product information:

- HSK-A shank with 4 equally deep slots 90° similar to ISO 12164-1/DIN 69893
- to proof concentricity at machine spindles
- further calibration on request

Scope of delivery:

- proofing arbor with test report in wooden box for vertical storage

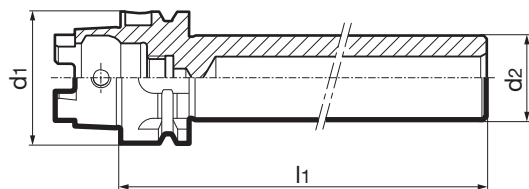

Article no. **4971**

d1	d2 mm	l1 mm	Order no.
HSK-E 32	25	140	4971 125.025
HSK-E 32	32	180	4971 150.032
HSK-A 40	40	180	4971 150.040
HSK-A 50	50	236	4971 200.050
HSK-A 63	63	346	4971 300.063
HSK-A 80	80	346	4971 300.080
HSK-A 100	100	349	4971 300.100



Balancing masters for HSK spindles

Article no. 4975



Product information:

- HSK-C according to ISO 12164-1/DIN 69893-1
- balancing quality: G 2.5 / 30,000 rpm or U < 1.2 gmm
- for balancing HSK spindles clamping systems: holds the clamping elements in the clamped position
- further calibration on request

Scope of delivery:

- supplied in wooden case with inspection protocol

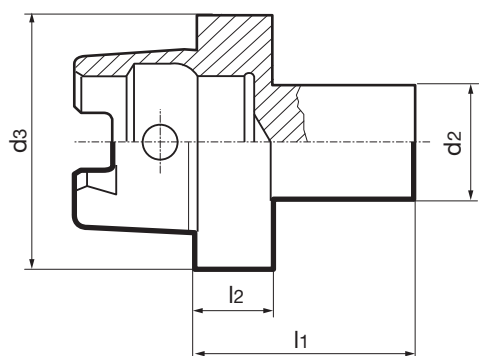

Article no. 4975

d3	d2 mm	l1 mm	l2 mm	Order no.
HSK-C 25	12	23.00	8.0	4975 25.000
HSK-C 32	12	25.00	10.0	4975 32.000
HSK-C 40	12	25.00	10.0	4975 40.000
HSK-C 50	20	37.50	12.5	4975 50.000
HSK-C 63	20	37.50	12.5	4975 63.000
HSK-C 80	20	46.00	16.0	4975 80.000
HSK-C 100	20	46.00	16.0	4975 100.000



Clamping force measuring instrument

Article no. **4973**

Product information:

- clamping force tester for SK/BT/CAT clamping systems in machine tool spindles
- further calibration on request

Scope of delivery:

- supplied in plastic case with inspection protocol and measuring instructions

suitable accessories separately available:

- for SK pull studs, art. no. 4925, 4926
- for BT shortened special tightening bolts, art. no. 4927, 4928

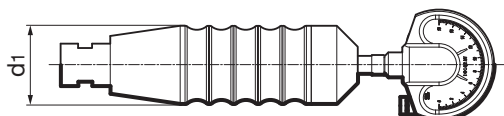

Article no. **4973**

d1	Order no.
SK/BT/CAT 30	4973 30.000
SK/BT/CAT 40	4973 40.000
SK/BT/CAT 50	4973 50.000

Clamping force measuring instrument

Article no. **4974**



Product information:

- mechanical feed-in clamping force tester for HSK clamping systems in machine tool spindles
- further calibration on request

Scope of delivery:

- supplied in plastic case with inspection protocol and measuring instructions

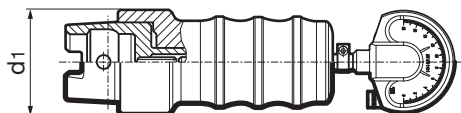

Article no. **4974**

d1	Order no.
HSK 25	4974 19.000
HSK 32	4974 24.000
HSK 40	4974 30.000
HSK 50	4974 38.000
HSK 63	4974 48.000
HSK 80	4974 60.000
HSK 100	4974 75.000



Clamping force measuring instrument Senso 3000

Article no. **4038**

Product information:

- accurate, quick and simple measuring of the clamping force of hydraulic chucks
- mobility allows measuring within machines and fixtures
- determines clamping force via a pressure sensitive plug gauge
- indication as clamping force in percentage relative to the reference value

Scope of delivery:

- clamping force tester in sturdy case and instruction manual, incl. test mandrel, test report and battery type CR 2430

Accessories

- clamping force tester Senso 3000
- master recording on request



Article no. **4038**

Clamping diameter mm	Order no.
6.0	4038 6.000
8.0	4038 8.000
10.0	4038 10.000
12.0	4038 12.000
14.0	4038 14.000
16.0	4038 16.000
18.0	4038 18.000
20.0	4038 20.000
25.0	4038 25.000
32.0	4038 32.000

Flow rate measuring device PQ 3000

Article no. **4068**

Product information:

- pPressure checking range: 1 to 120 bar
 - rate of flow checking range: 2 to 40 l/min
 - diameter holder shank: 16 mm
 - diameter range tool holder: ER 32 / 6 to 20 mm
 - display for existing pressure P in bar also rate of flow volume Q in l/min
 - Air flow/MQL cannot be checked with this system.
- Test device P 3000 for air measurement available on request.

Scope of delivery:

- clamping fixture and checking instrument
- display fixture with grip and connection socket
- checking data cable with connector plug, length 3 m
- ER 32 collet and sealing disc set for standard shanks with diameters from 6 to 20 mm
- clamping key for tensioning nut
- supplied in a sturdy case

suitable accessories separately available:

- data interface and software for data evaluation on a PC



Article no. **4068**

ER 32	Order no.
	4068 10.000

Measuring tools



Coolant supply measuring instrument CC 3000

Article no. **4076**



Product information:

- range of application 50 - 500 min⁻¹
- for a coolant pressure up to 80 bar

Scope of delivery:

- with straight shank 16h6 and HB/HE clamping surfaces
- high-grade steel filters in sizes 100, 200 and 300 µm, art. no. 4077
- refractometer including accessories
- magnifying glass, 8-fold magnification

suitable accessories separately available:

- high-grade steel filter size 60 µm, art. no. 4077



Article no. **4076**

Order no.

4076 10.063

High-grade steel filter for coolant supply measuring device

Article no. **4077**

Product information:

- range of application 50 - 500 min⁻¹
- for a coolant pressure up to 80 bar



Article no. **4077**

Order no.

Size	µm
200	
60	
100	
300	

4077 200.000
4077 60.000
4077 100.000
4077 300.000



Coolant supply sets for conventional cooling

Article no. **4949**

Product information:

- leak-proof screwed connection tested to 80 bar
- according to DIN 69895
- F = angle movability $\pm 1^\circ$
- for HSK-A and HSK-E shanks

Scope of delivery:

- incl. threaded ring and o rings

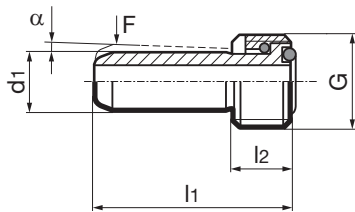

Article no. **4949**

for	d1 mm	α °	F Nm	G	l1 mm	l2 mm	Order no.
HSK 32	6.0	1.2	5	M10X1	26.0	5.5	4949 10.032
HSK 40	8.0	1.4	5	M12X1	29.5	7.5	4949 12.040
HSK 50	10.0	1.3	6	M16X1	33.0	9.5	4949 16.050
HSK 63	12.0	1.3	6	M18X1	36.5	11.5	4949 18.063
HSK 80	14.0	1.4	7	M20X1.5	40.0	13.5	4949 20.080
HSK 100	16.0	1.4	7	M24X1.5	44.0	15.5	4949 24.100

Coolant supply sets for conventional cooling with filter

Article no. **4979**

Product information:

- leak-proof screwed connection tested to 80 bar
- similar DIN 69895
- with filter for contamination-free cooling
- protects against tool breakage and eases error analysis
- F = angle movability $\pm 1^\circ$
- for HSK-A and HSK-E shanks

Scope of delivery:

- incl. threaded ring and o rings
- 100 μ stainless steel fabric filter

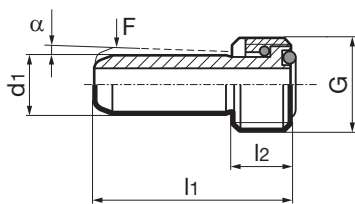

Article no. **4979**

for	d1 mm	α °	F Nm	G	l1 mm	l2 mm	Order no.
HSK 32	6.0	1.2	5	M10X1	26.0	5.5	4979 10.032
HSK 40	8.0	1.4	5	M12X1	29.5	7.5	4979 12.040
HSK 50	10.0	1.3	6	M16X1	33.0	9.5	4979 16.050
HSK 63	12.0	1.3	6	M18X1	36.5	11.5	4979 18.063
HSK 80	14.0	1.4	7	M20X1.5	40.0	13.5	4979 20.080
HSK 100	16.0	1.4	7	M24X1.5	44.0	15.0	4979 24.100



Data coding chip

Article no. **4955**

Product information:

- identification systems BIS C
- for installation space to DIN 69 873
- data carrier read/write
- 511 bytes
- operating temperature 0...+70
- protection class to IEC 60529
- product data exchange acc. to DIN 4000
- glued in hole $\varnothing 10$ H11

Scope of delivery:

- data coding chip

suitable accessories separately available:

- installation in a clamping chuck and additional balancing

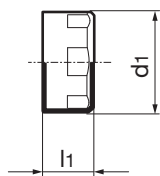

Article no.

4955

d1	l1	Order no.
mm	mm	4955 10.000
10.0	4.5	



Sockets

Article no. **4911**

Product information:

- with T-handle
- for coolant supply sets for conventional cooling and MQL coolant supply unit
- for mounting adaptor, art. no. 4948

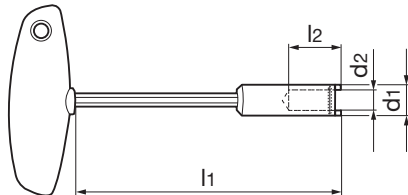

Article no. **4911**

for	d1 mm	d2 mm	l1 mm	l2 mm	Order no.
HSK 32	11.0	6.0	128	23.0	4911 24.000
HSK 40	13.0	8.0	134	26.0	4911 30.000
HSK 50	15.0	10.0	134	28.0	4911 38.000
HSK 63	17.0	12.0	135	31.5	4911 48.000
HSK 80	20.0	14.0	138	32.0	4911 60.000
HSK 100	22.5	16.0	138	35.0	4911 75.000

Sockets

Article no. **4910**

Product information:

- suitable for torque wrench art. no. 4915, drive 3/8"
- for coolant supply sets

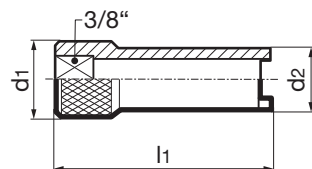

Article no. **4910**

for	Torque Nm	d1 mm	d2 mm	l1 mm	Order no.
HSK 32	7	20	14	60	4910 24.000
HSK 40	11	20	16	60	4910 30.000
HSK 50	15	20	18	60	4910 38.000
HSK 63	20	20	18	60	4910 48.000
HSK 80	25	20	20	75	4910 60.000
HSK 100	30	22	22	80	4910 75.000



Cleaning mandrels

Article no. **4914**

Product information:

- for cleaning internal tapers and the end faces on HSK
- by cleaning the contact surfaces accuracy, clamping torque and tool life of interfaces are improved
- the cleaning mandrels are available in 3 designs, suitable for HSK and ISO taper spindles and HPC high-precision chucks

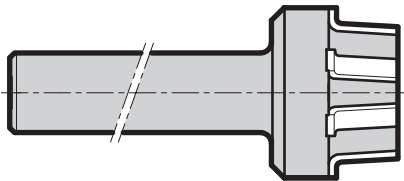

Article no. **4914**

for	Article no.	Order no.
HPC 14		4914 14.000
HPC 20		4914 20.000
HPC 25		4914 25.000
HSK 25		4914 19.000
HSK 32		4914 24.000
HSK 40		4914 30.000
HSK 50		4914 38.000
HSK 63		4914 48.000
HSK 80		4914 60.000
HSK 100		4914 75.000
SK/BT 30		4914 30.030
SK/BT 40		4914 40.000
SK/BT 50		4914 50.000



HSK cleaning cap

Article no. **4947**

Product information:

- for cleaning the external taper and face

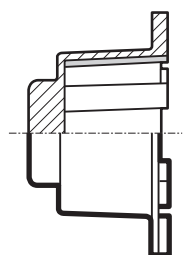

Article no. **4947**

for		Order no.
HSK 40		4947 1.040
HSK 50		4947 1.050
HSK 63		4947 1.063
HSK 80		4947 1.080
HSK 100		4947 1.100



Cylindrical cleaning mandrels

Article no. **4918**

Product information:

- for cleaning the bore of the tool holder
- i.e. hydraulic, shrink fit and HPC clamping chucks

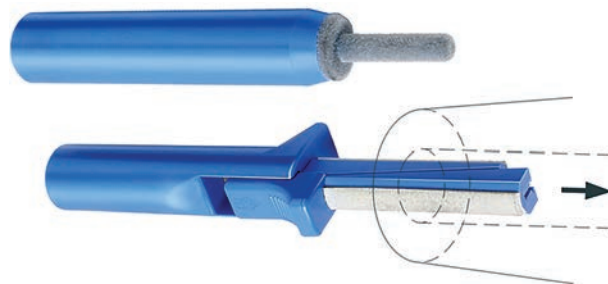
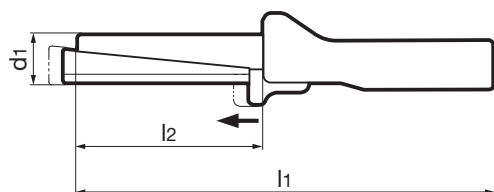

Article no. **4918**

d1 mm	l2 mm	l1 mm	Order no.
6	37	158	4918 6.000
8	37	158	4918 8.000
10	47	168	4918 10.000
12	47	168	4918 12.000
14	47	168	4918 14.000
16	70	176	4918 16.000
18	70	176	4918 18.000
20	70	176	4918 20.000
25	80	186	4918 25.000
32	100	221	4918 32.000
40	105	226	4918 40.000



HSK-C sealing plugs

Article no. **4985**



Product information:

- With high coolant pressure applications, it is imperative to seal the spindle with the sealing plug for safety reasons when the machine spindle is not fitted with a tool. The sealing plug protects the spindle from contamination.

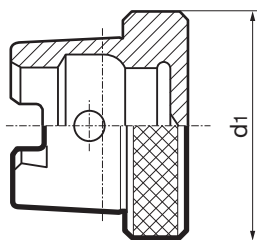

Article no. **4985**

for	d1 mm	Order no.
HSK-C 32	34	4985 32.000
HSK-C 40	42	4985 40.000
HSK-C 50	52	4985 50.000
HSK-C 63	65	4985 63.000
HSK-C 80	82	4985 80.000
HSK-C 100	102	4985 100.000



Tool setting fixtures

Article no. **4946**

Product information:

- The HSK shanks are clamped vertically and horizontally at the collar. Therefore, all tapers with the same diameter of the collar can be clamped with one fixture.
- for HSK shanks HSK 32, 40, 50 and 63, form A, C, E and F

Scope of delivery:

- incl. holder adaptors



Article no. **4946**

for	Length mm	Width mm	Height mm	kg	Order no.
HSK 32	260	130	160	9	4946 450.032
HSK 40	260	130	160	9	4946 450.040
HSK 50	260	130	160	9	4946 450.050
HSK 63	260	130	160	9	4946 450.063

Tool setting fixtures

Article no. **4990**

Product information:

- The HSK shank is held vertically by its own weight in the tool assembly block. The torque is transmitted via the drivers at the taper end.
- All taper variants of the same taper size, such as DIN 69871/DIN 2080/MAS-BT and D-BT) can be clamped without changing the inserts, simply by adjusting the clamping spindle axially.

Scope of delivery:

- incl. interchangeable discs art. no. 4991



Article no. **4990**

for	Length mm	Width mm	Height mm	kg	Order no.
SK/BT 40	260	130	160	9	4990 400.040
SK/BT 50	260	130	160	9	4990 400.050
HSK 63	260	130	160	9	4990 450.063
HSK 80	260	130	160	9	4990 450.080
HSK 100	260	130	160	9	4990 450.100



Interchangeable discs

Article no. **4991**

Product information:

- for tool setting fixture, art. no. 4990

Scope of delivery:

- 1 pair

Article no. **4991**

for	for art. no.	kg	Order no.
SK/BT 40	4990	1.5	4991 400.100
SK/BT 50	4990	1.5	4991 400.200
HSK 32	4946	0.8	4991 450.100
HSK 40	4946	0.8	4991 450.200
HSK 50	4946	0.0	4991 450.300
HSK 63	4990	0.1	4991 450.400
HSK 80	4990	0.2	4991 450.500
HSK 100	4990	0.4	4991 450.600



Torque wrenches

Article no. **4915**

Product information:

- incl. torque setting tool and bit holder
- torque wrench, art. no. 4915 3,000 (incl. bit SW4) exclusively for HPC extension, art. no. 4208



Article no. **4915**

	Drive	Torque Nm	Order no.
hexagonal	1/4"	0,4-1	4915 1.001
hexagonal	1/4"	0,5-2	4915 2.000
hexagonal	1/4"	1,5-3	4915 3.000
hexagonal	1/4"	0,8-5	4915 5.001
hexagonal	1/4"	2-8	4915 8.000

Torque wrenches

Article no. **4987**

Product information:

- firmly set to 10 Nm; suitable for our HPC chucks, art. no. 4300, 4301, 4243, 4244

suitable accessories separately available:

- hexagonal insert art. no. 4916



Article no. **4987**

	Drive	Torque Nm	Order no.
square	1/4"	10	4987 10.000



Torque wrenches

Article no. **4988**

Product information:

- incl. torque setting tool and bit holder

suitable accessories separately available:

- hexagonal insert art. no. 4916
- Torx Plus insert art. no. 4879



Article no. **4988**

	Drive	Torque Nm	Order no.
T-handle	1/4"	5-14	4988 14.000

Torque wrenches

Article no. **4989**

Product information:

- with ratchet

suitable accessories separately available:

- hexagonal insert art. no. 4916
- Torx Plus insert art. no. 4879



Article no. **4989**

	Drive	Torque Nm	Order no.
square	3/8"	10-50	4989 50.000
square	1/2"	20-200	4989 200.000

General accessories



Socket/attachments

Article no. **4916**

Product information:

- for hexagon socket screws
- type D for HPC clamping chuck

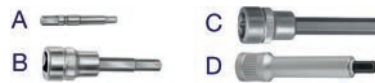
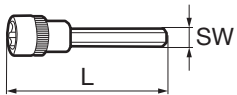

Article no. **4916**

Drive	SW mm		L mm	Type	Order no.
1/4	2.0	hexagonal	50	A	4916 2.019
1/4	2.5	hexagonal	50	A	4916 2.524
1/4	2.0	hexagonal	50	A	4916 3.030
3/8	3.0	square	52	B	4916 3.038
1/4	4.0	hexagonal	55	D	4916 4.000
3/8	4.0	square	100	B	4916 4.038
3/8	4.0	square	100	B	4916 4.138
3/8	5.0	square	100	B	4916 5.048
3/8	5.0	square	105	B	4916 5.148
1/2	6.0	square	90	C	4916 6.038
3/8	6.0	square	100	B	4916 6.060
1/2	8.0	square	90	C	4916 8.048
3/8	8.0	square	100	B	4916 8.075
1/2	10.0	square	140	C	4916 10.060
1/2	12.0	square	140	C	4916 12.000
1/2	14.0	square	60	C	4916 14.000



Hexagon clamping keys

Article no. **4912**

Product information:

- for hexagon socket screws
- order no. 4912 4.600 and 4912 4,010 special key for HPC chucks
- order no. 4912 3.456 SW 3/4/5/6 mm
- order no. 4912 4.600 SW 4/6 mm

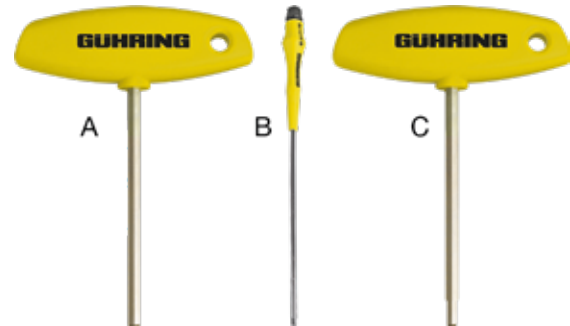
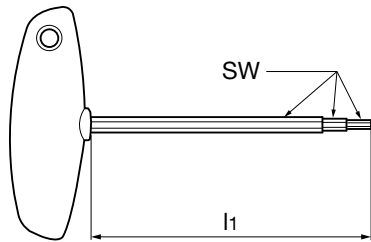

Article no. **4912**

SW mm	l1 mm	Type	Order no.
2.0	100	A	4912 2.000
2.5	100	A	4912 2.500
2.5	200	A	4912 2.501
3.0	100	A	4912 3.000
3.0	200	A	4912 3.001
4.0	100	A	4912 4.000
4.0	200	A	4912 4.001
5.0	100	A	4912 5.000
5.0	200	A	4912 5.001
6.0	100	A	4912 6.000
6.0	200	A	4912 6.001
7.0	200	A	4912 7.001
8.0	100	A	4912 8.000
8.0	200	A	4912 8.001
10.0	100	A	4912 10.000
12.0	100	A	4912 12.000
1.5	150	B	4912 1.500
2.0	150	B	4912 2.001
2.5	120	B	4912 2.502
3.0	150	B	4912 3.002
4.0	150	B	4912 4.002
2.5	60	C	4912 2.509
3456.0	100	C	4912 3.456
46.0	100	C	4912 4.600



Hexagon-socket offset screw keys

Article no. **4921**

Product information:

- for hexagon socket screws
- for threaded pin, art. no. 4551
in clamping set PowerClamp, art. no. 4554



Article no. **4921**

	SW mm	Order no.
	0.7	4921 0.700
	0.9	4921 0.900
	1.3	4921 1.300
	1.5	4921 1.501
	1.5	4921 1.500
	2.0	4921 2.000
	2.5	4921 2.500
	3.0	4921 3.000
	4.0	4921 4.000
	5.0	4921 5.000
	6.0	4921 6.000



Pull studs ISO taper DIN ISO 7388-3 form AD

Article no. **4925**

Product information:

- for ISO taper tool holders to DIN ISO 7388-3 form AD
- through hole for central coolant supply

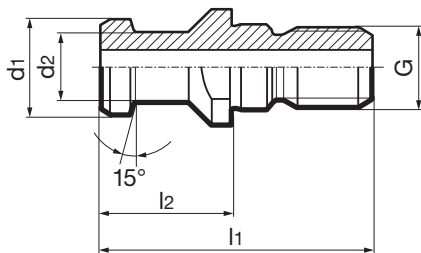

Article no. **4925**

for	d1 mm	d2 mm	l1 mm	l2 mm	Mt max. Nm	G	Order no.
30	13.0	9.0	44.0	24	20-25	M12	4925 30.000
40	19.0	14.0	54.0	26	60-80	M16	4925 40.000
50	28.0	21.0	74.0	34	200-250	M24	4925 50.000

Pull studs ISO taper DIN ISO 7388-3 form AF

Article no. **4926**

Product information:

- for ISO taper tool holders to DIN ISO 7388-3 form AD
- sealed for coolant supply above the collar

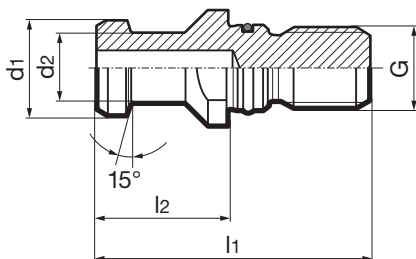

Article no. **4926**

for	d1 mm	d2 mm	l1 mm	l2 mm	Mt max. Nm	G	Order no.
30	13.0	9.0	44.0	24	20-25	M12	4926 30.000
40	19.0	14.0	54.0	26	60-80	M16	4926 40.000
50	28.0	21.0	74.0	34	200-250	M24	4926 50.000



Pull studs BT DIN ISO 7388-3

Article no. **4927**

Product information:

- for tool holders to DIN ISO 7388-2 (MAS 403 BT)
- 45° clamping shoulder angle
- design JD sealed with through hole
- design JF without through hole
- 40.100 shortened and sealed, for draw-in clamping force test equipment art. no. 4973

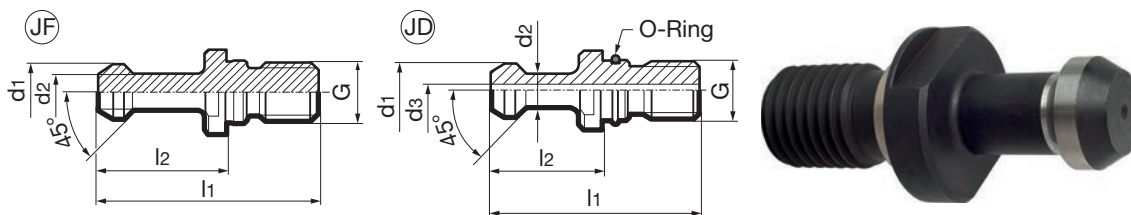

Article no. **4927**

for	Form	d1 mm	d2 mm	d3 mm	l1 mm	l2 mm	Mt max. Nm	G	Order no.
30	JF	11.0	7.0		43.0	23	20-25	M12	4927 30.000
30	JD	11.0	7.0	2.5	43.0	23	20-25	M12	4927 30.001
40	JF	15.0	10.0		60.0	35	60-80	M16	4927 40.000
40	JD	15.0	10.0	4.0	60.0	35	60-80	M16	4927 40.001
40	JF	15.0	10.0		57.0	32	60-80	M16	4927 40.100
50	JF	23.0	17.0		85.0	45	200-250	M24	4927 50.000
50	JD	23.0	17.0	8.5	85.0	45	200-250	M24	4927 50.001



Pull studs BT DIN ISO 7388-3

Article no. 4928

Product information:

- for tool holders to DIN ISO 7388-2 (MAS 403 BT)
- 60° clamping shoulder angle
- design JD sealed with through hole
- design JF without through hole
- 40.100 shortened and sealed, for draw-in clamping force test equipment art. no. 4973

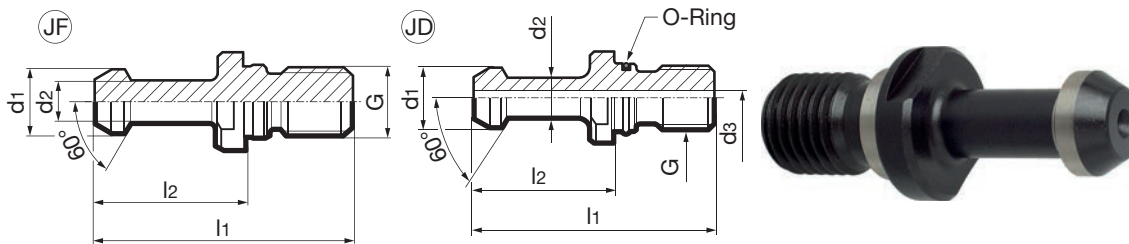

Article no.

4928

for	Form	d1 mm	d2 mm	d2 mm	l1 mm	l2 mm	Mt max. Nm	G	Order no.
30	JF	11.0	7.0		43.0	23	20-25	M12	4928 30.000
30	JD	11.0	7.0	2.5	43.0	23	20-25	M12	4928 30.001
40	JF	15.0	10.0		60.0	35	60-80	M16	4928 40.000
40	JD	15.0	10.0	4.0	60.0	35	60-80	M16	4928 40.001
40	JF	15.0	10.0		57.0	32	60-80	M16	4928 40.100
50	JF	23.0	17.0		85.0	45	200-250	M24	4928 50.000
50	JD	23.0	17.0	8.5	85.0	45	200-250	M24	4928 50.001
60	JD	32.0	24.0	12.0	115.0	65	200-250	M30	4928 60.001



Grooving tools

Perfection that catches the eye

Grooving tools that just make sense

GÜHRING

Page

1393	Micro-precision tools for radial grooving
1405	Indexable inserts for radial grooving
1408	Micro-precision tools for axial grooving
1417	Indexable inserts for axial grooving
1420	Indexable inserts for parting off
1424	Micro-precision tools for turning
1455	Micro-precision tools for internal threading
1465	Indexable inserts for threading
1469	Micro-precision tools for broaching
1475	Tool holders for micro-precision tools
1525	Tool holders for indexable inserts
1540	General accessories



ALL-ROUNDER
High degree of material flexibility

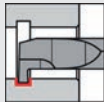

Grooving | Internal

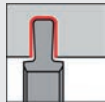

Grooving | External

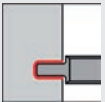

Grooving | Axial

System 104



Dmin.
1,0 mm
e.g. # 25126
p. 1393

Dmin.
4,0 mm
e.g. # 25190
p. 1408

System 106



Dmin.
5,0 mm
e.g. # 25874
p. 1394

Dmin.
6,0 mm
e.g. # 25782
p. 1408

System 108



Dmin.
7,0 mm
e.g. # 27124
p. 1396

Dmin.
8,0 mm
e.g. # 27232
p. 1409

System 305



Dmin.
40,0 mm
e.g. # 25605
p. 1406

tmax.
5,0 mm
e.g. # 25605
p. 1406

Dmin.
15,0 mm
e.g. # 25626
p. 1417

System 222



Didn't find what you were looking for?
Enter very specific requirements into our online Gühring Navigator and you will receive precise tool recommendations – cutting values included.



ALL-ROUNDER
High degree of material flexibility

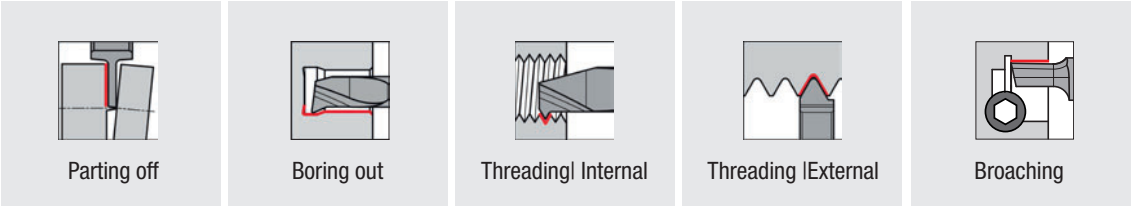

Parting off

Boring out

Threading Internal

Threading External

Broaching

Dmin.
0,7 mm
e.g. # 25052
p. 1424

Pmin.
0,2 mm
e.g. # 25158
p. 1458

from SW
1,5 mm
e.g. # 25229
p. 1469

Dmin.
5,0 mm
e.g. # 25834
p. 1425

Pmin.
1,0 mm
e.g. # 25774
p. 1460

from SW
4,0 mm
e.g. # 25897
p. 1469

Dmin.
7,0 mm
e.g. # 27100
p. 1427

Pmin.
1,5 mm
e.g. # 27132
p. 1457

from SW
8,0 mm
e.g. # 27146
p. 1470

tmax.
5,0 mm
e.g. # 25641
p. 1420

Pmin.
0,3 mm
e.g. # 25654
p. 1465

tmax.
45,0 mm
e.g. # 26601
p. 1422



SYSTEM 104 | 106 | 108

Cutting insert

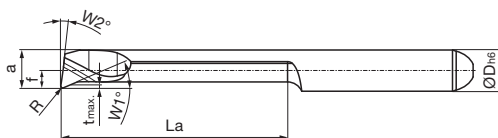

Tool description: Example: GT104.2326.010.22.30.R

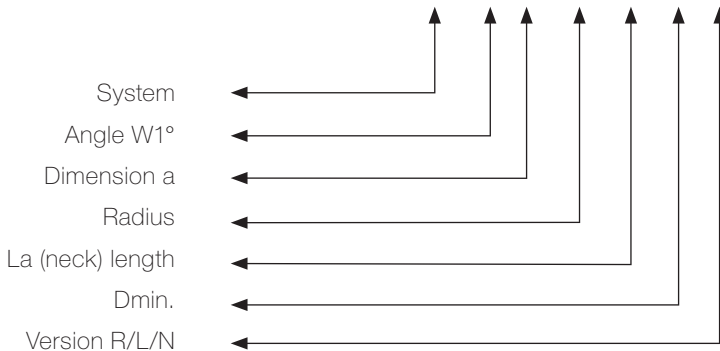

SYSTEM 104 | 106 | 108 | 110

Tool holder

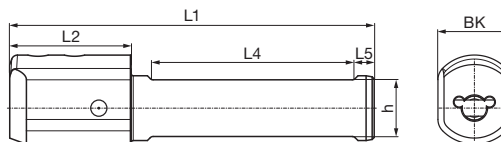

Tool description: Example: GB110.0010.090.00.22.N.IK

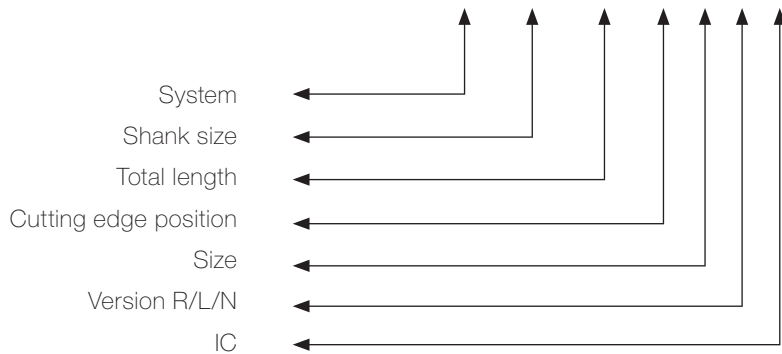

SYSTEM 305

Indexable insert

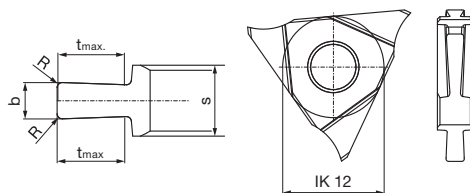

Tool description: Example: GE305.0250.020.BA.04.N

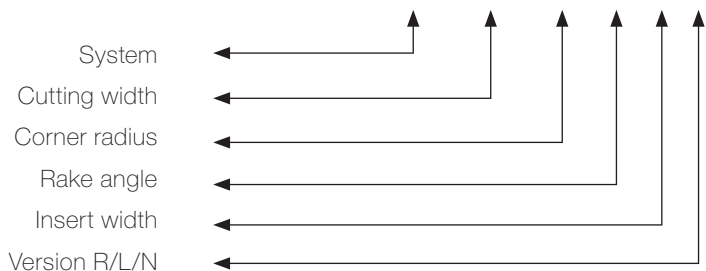



SYSTEM 222

Indexable insert

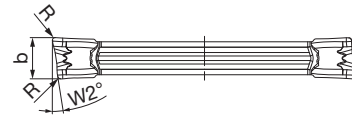

Tool description: Example: GZ222.0300.020.PM.01.N/R/L.08

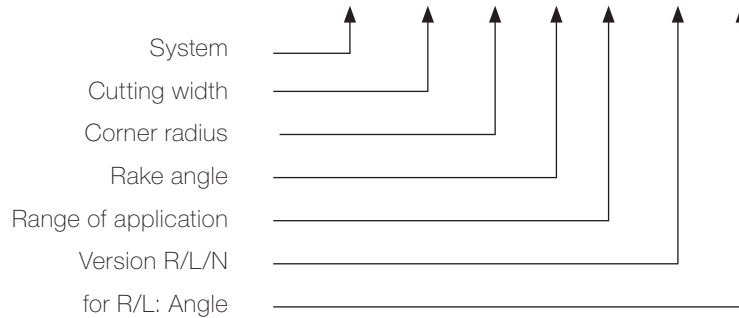

SYSTEM 305 | 222

Tool holder

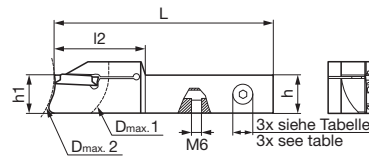

Tool description: Example: GH222.2020.109.00.03.R.IK.52

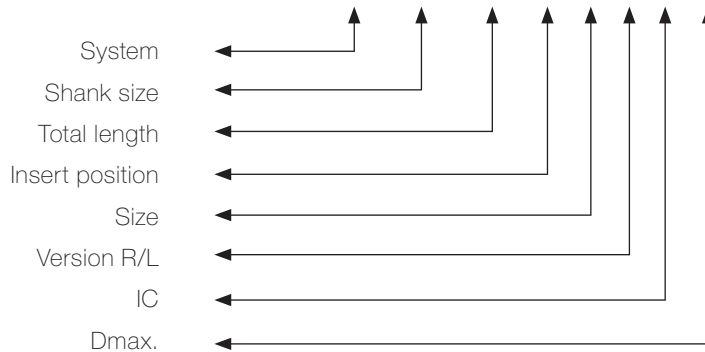

SYSTEM 222

Parting off blade

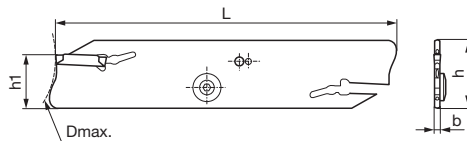

Tool description: Example: GS222.0032.147.03.02.N.IK

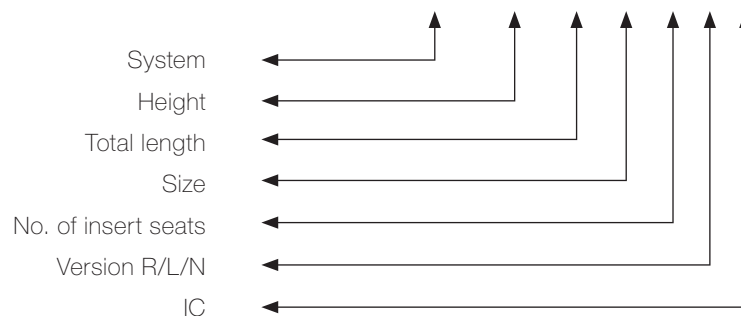



P	M	K	N	S	H	Tool illustration	Type	Cutting direction	Tool material	Surface	Article no.	Page
Cutting inserts for internal grooving, flat bottom slots												
•	•	•	•	•	•		GE104		VHM	a	25126	1393
○	○	•	•	•	•		GE104		VHM	○	25130	1393
•	•	•	•	•	•		GE104		VHM	a	25127	1393
○	○	•	•	•	•		GE104		VHM	○	25131	1393
•	•	•	•	•	•		GE106		VHM	a	25874	1394
○	○	•	•	•	•		GE106		VHM	○	25878	1394
•	•	•	•	•	•		GE106		VHM	a	25875	1394
○	○	•	•	•	•		GE106		VHM	○	25879	1394
•	•	•	•	•	•		GE106		VHM	a	25750	1395
○	○	•	•	•	•		GE106		VHM	○	25754	1395
•	•	•	•	•	•		GE106		VHM	a	25751	1395
○	○	•	•	•	•		GE106		VHM	○	25755	1395
•	•	•	•	•	•		GE108		VHM	a	27124	1396
○	○	•	•	•	•		GE108		VHM	○	27126	1396
•	•	•	•	•	•		GE108		VHM	a	27125	1396
○	○	•	•	•	•		GE108		VHM	○	27127	1396
•	•	•	•	•	•		GE108		VHM	a	27224	1397
○	○	•	•	•	•		GE108		VHM	○	27225	1397
•	•	•	•	•	•		GE108		VHM	a	27226	1397
○	○	•	•	•	•		GE108		VHM	○	27227	1397
Cutting inserts for internal grooving, full radius slots												
•	•	•	•	•	•		GE104		VHM	a	25134	1398
○	○	•	•	•	•		GE104		VHM	○	25138	1398
•	•	•	•	•	•		GE104		VHM	a	25135	1398
○	○	•	•	•	•		GE104		VHM	○	25139	1398



P	M	K	N	S	H	Tool illustration	Type	Cutting direction	Tool material	Surface	Article no.	Page
Cutting inserts for internal grooving, full radius slots												
•	•	•	○	•	•		GE106		VHM	a	25882	1399
○	○	•	•	•	•		GE106		VHM	0	25886	1399
•	•	•	○	•	•		GE106		VHM	a	25883	1399
○	○	•	•	•	•		GE106		VHM	0	25887	1399
•	•	•	○	•	•		GE106		VHM	a	25758	1400
○	○	•	•	•	•		GE106		VHM	0	25762	1400
•	•	•	○	•	•		GE106		VHM	a	25759	1400
○	○	•	•	•	•		GE106		VHM	0	25763	1400
•	•	•	○	•	•		GE108		VHM	a	27128	1401
○	○	•	•	•	•		GE108		VHM	0	27130	1401
•	•	•	○	•	•		GE108		VHM	a	27129	1401
○	○	•	•	•	•		GE108		VHM	0	27131	1401
•	•	•	○	•	•		GE108		VHM	a	27228	1402
○	○	•	•	•	•		GE108		VHM	0	27230	1402
•	•	•	○	•	•		GE108		VHM	a	27229	1402
○	○	•	•	•	•		GE108		VHM	0	27231	1402
Cutting inserts for internal pre-grooving and chamfering												
•	•	•	○	•	•		GV104		VHM	a	25142	1403
○	○	•	•	•	•		GV104		VHM	0	25146	1403
•	•	•	○	•	•		GV104		VHM	a	25143	1403
○	○	•	•	•	•		GV104		VHM	0	25147	1403
•	•	•	○	•	•		GV106		VHM	a	26902	1404
○	○	•	•	•	•		GV106		VHM	0	26904	1404
•	•	•	○	•	•		GV106		VHM	a	26903	1404
○	○	•	•	•	•		GV106		VHM	0	26905	1404

Grooving tools



P	M	K	N	S	H	Tool illustration	Type	Cutting direction	Tool material	Surface	Article no.	Page
●	○	○	○	○	○		GE305		VHM	F	25601	1405
●	●	○	○	●	○		GE305		VHM	E	25602	1405
○	○	●	○	○	○		GE305		VHM	○	25603	1405
●	○	○	○	○	○		GE305		VHM	F	25605	1406
●	●	○	○	●	○		GE305		VHM	E	25606	1406
○	●	○	●	●	○		GE305		VHM	○	25607	1406
●	○	○	○	○	○		GE305		VHM	F	25613	1407
●	●	○	○	●	○		GE305		VHM	E	25614	1407
○	●	○	●	●	○		GE305		VHM	○	25615	1407



P	M	K	N	S	H	Tool illustration	Type	Cutting direction	Tool material	Surface	Article no.	Page
●	●	○	○	●	●		GA104		VHM	a	25190	1408
○	○	●	○	○	○		GA104		VHM	○	25194	1408
●	●	○	○	●	●		GA104		VHM	a	25191	1408
○	○	●	○	○	○		GA104		VHM	○	25195	1408
●	●	○	○	●	●		GA106		VHM	a	25782	1408
○	○	●	○	○	○		GA106		VHM	○	25786	1408
●	●	○	○	●	●		GA106		VHM	a	25783	1408
○	○	●	○	○	○		GA106		VHM	○	25787	1408
●	●	○	○	●	●		GA108		VHM	a	27232	1409
○	○	●	○	○	○		GA108		VHM	○	27234	1409
●	●	○	○	●	●		GA108		VHM	a	27233	1409
○	○	●	○	○	○		GA108		VHM	○	27235	1409
Cutting inserts for axial grooving bores, full radius slots												
●	●	○	○	●	●		GA104		VHM	a	25198	1410
○	○	●	○	○	○		GA104		VHM	○	25202	1410
●	●	○	○	●	●		GA104		VHM	a	25199	1410
○	○	●	○	○	○		GA104		VHM	○	25203	1410
●	●	○	○	●	●		GA106		VHM	a	25790	1410
○	○	●	○	○	○		GA106		VHM	○	25794	1410
●	●	○	○	●	●		GA106		VHM	a	25791	1410
○	○	●	○	○	○		GA106		VHM	○	25795	1410
●	●	○	○	●	●		GA108		VHM	a	27236	1411
○	○	●	○	○	○		GA108		VHM	○	27238	1411
●	●	○	○	●	●		GA108		VHM	a	27237	1411
○	○	●	○	○	○		GA108		VHM	○	27239	1411

Grooving tools



P	M	K	N	S	H	Tool illustration	Type	Cutting direction	Tool material	Surface	Article no.	Page
Cutting inserts for axial grooving studs, flat bottom slots												
•	•	•	•	•	•		GA104		VHM	a	25206	1412
○	○	•	•	•	•		GA104		VHM	○	25210	1412
•	•	•	•	•	•		GA104		VHM	a	25207	1412
○	○	•	•	•	•		GA104		VHM	○	25211	1412
•	•	•	•	•	•		GA106		VHM	a	25798	1412
○	○	•	•	•	•		GA106		VHM	○	25802	1412
•	•	•	•	•	•		GA106		VHM	a	25799	1412
○	○	•	•	•	•		GA106		VHM	○	25803	1412
•	•	•	•	•	•		GA108		VHM	a	27240	1413
○	○	•	•	•	•		GA108		VHM	○	27242	1413
•	•	•	•	•	•		GA108		VHM	a	27241	1413
○	○	•	•	•	•		GA108		VHM	○	27243	1413
Cutting inserts for axial grooving studs, full radius slots												
•	•	•	•	•	•		GA104		VHM	a	25214	1414
○	○	•	•	•	•		GA104		VHM	○	25218	1414
•	•	•	•	•	•		GA104		VHM	a	25215	1414
○	○	•	•	•	•		GA104		VHM	○	25219	1414
•	•	•	•	•	•		GA106		VHM	a	25806	1414
○	○	•	•	•	•		GA106		VHM	○	25810	1414
•	•	•	•	•	•		GA106		VHM	a	25807	1414
○	○	•	•	•	•		GA106		VHM	○	25811	1414
•	•	•	•	•	•		GA108		VHM	a	27244	1415
○	○	•	•	•	•		GA108		VHM	○	27246	1415
•	•	•	•	•	•		GA108		VHM	a	27245	1415
○	○	•	•	•	•		GA108		VHM	○	27247	1415



P	M	K	N	S	H	Tool illustration	Type	Cutting direction	Tool material	Surface	Article no.	Page
Cutting inserts for axial chamfering bores												
●	●	○	○	●	●		GA104		VHM	Ⓐ	25222	1416
○	○	●	○	○	○		GA104		VHM	○	25226	1416
●	●	○	○	●	●		GA104		VHM	Ⓐ	25223	1416
○	○	●	○	○	○		GA104		VHM	○	25227	1416
Indexable inserts for axial grooving, flat bottom slots												
●	○	○	○	○	○		GA305		VHM	Ⓕ	25626	1417
●	●	○	○	●	○		GA305		VHM	Ⓖ	25628	1417
○	○	●	○	○	○		GA305		VHM	○	25630	1417
●	○	○	○	○	○		GA305		VHM	Ⓕ	25627	1417
●	●	○	○	●	○		GA305		VHM	Ⓖ	25629	1417
○	○	●	○	○	○		GA305		VHM	○	25631	1417
Indexable inserts for axial grooving, full radius slots												
●	○	○	○	○	○		GA305		VHM	Ⓕ	25634	1418
●	●	○	○	●	○		GA305		VHM	Ⓖ	25636	1418
○	●	○	●	●	○		GA305		VHM	○	25638	1418
●	○	○	○	○	○		GA305		VHM	Ⓕ	25635	1418
●	●	○	○	●	○		GA305		VHM	Ⓖ	25637	1418
○	●	○	●	●	○		GA305		VHM	○	25639	1418
Indexable inserts for grooving axial external recesses												
●	○	○	○	○	○		GA305		VHM	Ⓕ	25618	1419
●	●	○	○	●	○		GA305		VHM	Ⓖ	25620	1419



P	M	K	N	S	H	Tool illustration	Type	Cutting direction	Tool material	Surface	Article no.	Page
○	○	●					GA305		VHM	○	25622	1419
●	○	○	○	○	○		GA305		VHM	⊕	25619	1419
○	●	○	○	●	○		GA305		VHM	⊕	25621	1419
○	○	●					GA305		VHM	○	25623	1419



P	M	K	N	S	H	Tool illustration	Type	Cutting direction	Tool material	Surface	Article no.	Page
•	○	○	○	○	○		GZ305		VHM	F	25641	1420
•	•	○	○	•	○		GZ305		VHM	E	25642	1420
○	•	○	•	•	○		GZ305		VHM	O	25643	1420
•	○	○	○	○	○		GZ305		VHM	F	25646	1421
•	•	○	○	•	○		GZ305		VHM	E	25648	1421
○	○	•	•	•	○		GZ305		VHM	O	25650	1421
•	○	○	○	○	○		GZ305		VHM	F	25647	1421
•	•	○	○	•	○		GZ305		VHM	E	25649	1421
○	•	○	•	•	○		GZ305		VHM	O	25651	1421
•	○	○	○	○	○		GZ222		VHM	F	26601	1422
•	○	○	○	○	○		GZ222		VHM	F	26602	1422
•	○	○	○	○	○		GZ222		VHM	F	26603	1422
•	○	○	○	○	○		GZ122		VHM	F	26604	1423
○	•	○	○	○	○		GZ222		VHM	G	26605	1423



P	M	K	N	S	H	Tool illustration	Type	Cutting direction	Tool material	Surface	Article no.	Page
•	•	•	○	•	•		GT104		VHM		25052	1424
○	○	•	•	•	•		GT104		VHM	○	25056	1424
•	•	•	○	•	•		GT104		VHM		25053	1424
○	○	•	•	•	•		GT104		VHM	○	25057	1424
•	•	•	○	•	•		GT106		VHM		25834	1425
○	○	•	•	•	•		GT106		VHM	○	25838	1425
•	•	•	○	•	•		GT106		VHM		25835	1425
○	○	•	•	•	•		GT106		VHM	○	25839	1425
•	•	•	○	•	•		GT106		VHM		25702	1426
○	○	•	•	•	•		GT106		VHM	○	25706	1426
•	•	•	○	•	•		GT106		VHM		25703	1426
○	○	•	•	•	•		GT106		VHM	○	25707	1426
•	•	•	○	•	•		GT108		VHM		27100	1427
○	○	•	•	•	•		GT108		VHM	○	27102	1427
•	•	•	○	•	•		GT108		VHM		27101	1427
○	○	•	•	•	•		GT108		VHM	○	27103	1427
•	•	•	○	•	•		GT108		VHM		27200	1428
○	○	•	•	•	•		GT108		VHM	○	27202	1428
•	•	•	○	•	•		GT108		VHM		27201	1428
○	○	•	•	•	•		GT108		VHM	○	27203	1428
Cutting inserts for boring out and profiling												
•	•	•	○	•	•		GT104		VHM		25068	1429
○	○	•	•	•	•		GT104		VHM	○	25072	1429
•	•	•	○	•	•		GT104		VHM		25069	1429
○	○	•	•	•	•		GT104		VHM	○	25073	1429



P	M	K	N	S	H	Tool illustration	Type	Cutting direction	Tool material	Surface	Article no.	Page
•	•	•	○	•	•		GT106		VHM	a	25842	1430
○	○	•	•	•	•		GT106		VHM	○	25846	1430
•	•	•	○	•	•		GT106		VHM	a	25843	1430
○	○	•	•	•	•		GT106		VHM	○	25847	1430
•	•	•	○	•	•		GT106		VHM	a	25890	1431
○	○	•	•	•	•		GT106		VHM	○	25894	1431
•	•	•	○	•	•		GT106		VHM	a	25891	1431
○	○	•	•	•	•		GT106		VHM	○	25895	1431
•	•	•	○	•	•		GT106		VHM	a	25710	1432
○	○	•	•	•	•		GT106		VHM	○	25714	1432
•	•	•	○	•	•		GT106		VHM	a	25711	1432
○	○	•	•	•	•		GT106		VHM	○	25715	1432
•	•	•	○	•	•		GT106		VHM	a	25518	1433
○	○	•	•	•	•		GT106		VHM	○	25522	1433
•	•	•	○	•	•		GT106		VHM	a	25519	1433
○	○	•	•	•	•		GT106		VHM	○	25523	1433
•	•	•	○	•	•		GT108		VHM	a	27104	1434
○	○	•	•	•	•		GT108		VHM	○	27106	1434
•	•	•	○	•	•		GT108		VHM	a	27105	1434
○	○	•	•	•	•		GT108		VHM	○	27107	1434
•	•	•	○	•	•		GT108		VHM	a	27108	1435
○	○	•	•	•	•		GT108		VHM	○	27110	1435
•	•	•	○	•	•		GT108		VHM	a	27109	1435
○	○	•	•	•	•		GT108		VHM	○	27111	1435
•	•	•	○	•	•		GT108		VHM	a	27204	1436

Grooving tools



P	M	K	N	S	H	Tool illustration	Type	Cutting direction	Tool material	Surface	Article no.	Page
Cutting inserts for boring out and profiling												
○	○	●					GT108		VHM	○	27206	1436
●	●	○	●	●	●		GT108		VHM	ⓐ	27205	1436
○	○	●					GT108		VHM	○	27207	1436
●	●	○	●	●	●		GT108		VHM	ⓐ	27208	1436
○	○	●					GT108		VHM	○	27210	1436
●	●	○	●	●	●		GT108		VHM	ⓐ	27209	1436
○	○	●					GT108		VHM	○	27211	1436
Cutting inserts for boring out and profiling												
●	●	○	●	●	●		GT104		VHM	ⓐ	25084	1437
○	○	●					GT104		VHM	○	25088	1437
●	●	○	●	●	●		GT104		VHM	ⓐ	25085	1437
○	○	●					GT104		VHM	○	25089	1437
●	●	○	●	●	●		GT106		VHM	ⓐ	25502	1438
○	○	●					GT106		VHM	○	25506	1438
●	●	○	●	●	●		GT106		VHM	ⓐ	25503	1438
○	○	●					GT106		VHM	○	25507	1438
●	●	○	●	●	●		GT106		VHM	ⓐ	25510	1439
○	○	●					GT106		VHM	○	25514	1439
●	●	○	●	●	●		GT106		VHM	ⓐ	25511	1439
○	○	●					GT106		VHM	○	25515	1439
Cutting inserts for boring out and profiling												
●	●	○	●	●	●		GT104		VHM	ⓐ	25060	1440
○	○	●					GT104		VHM	○	25064	1440
●	●	○	●	●	●		GT104		VHM	ⓐ	25061	1440
○	○	●					GT104		VHM	○	25065	1440



P	M	K	N	S	H	Tool illustration	Type	Cutting direction	Tool material	Surface	Article no.	Page
•	•	•	○	•	•		GT104		VHM		25076	1441
○	○	•	•	•	•		GT104		VHM	○	25080	1441
•	•	•	○	•	•		GT104		VHM		25077	1441
○	○	•	•	•	•		GT104		VHM	○	25081	1441
Cutting inserts for boring out and profiling												
•	•	•	○	•	•		GJ104		VHM		25092	1442
○	○	•	•	•	•		GJ104		VHM	○	25096	1442
•	•	•	○	•	•		GJ104		VHM		25093	1442
○	○	•	•	•	•		GJ104		VHM	○	25097	1442
•	•	•	○	•	•		GJ106		VHM		25850	1443
○	○	•	•	•	•		GJ106		VHM	○	25854	1443
•	•	•	○	•	•		GJ106		VHM		25851	1443
○	○	•	•	•	•		GJ106		VHM	○	25855	1443
•	•	•	○	•	•		GJ106		VHM		25718	1444
○	○	•	•	•	•		GJ106		VHM	○	25722	1444
•	•	•	○	•	•		GJ106		VHM		25719	1444
○	○	•	•	•	•		GJ106		VHM	○	25723	1444
•	•	•	○	•	•		GJ108		VHM		27116	1445
○	○	•	•	•	•		GJ108		VHM	○	27118	1445
•	•	•	○	•	•		GJ108		VHM		27117	1445
○	○	•	•	•	•		GJ108		VHM	○	27119	1445
•	•	•	○	•	•		GJ108		VHM		27216	1445
○	○	•	•	•	•		GJ108		VHM	○	27218	1445
•	•	•	○	•	•		GJ108		VHM		27217	1445
○	○	•	•	•	•		GJ108		VHM	○	27219	1445

Grooving tools



P	M	K	N	S	H	Tool illustration	Type	Cutting direction	Tool material	Surface	Article no.	Page
Cutting inserts for back boring and profiling												
•	•	•	○	•	•		GT104		VHM		25108	1446
○	○	•	•	•	•		GT104		VHM	○	25112	1446
•	•	•	○	•	•		GT104		VHM		25109	1446
○	○	•	•	•	•		GT104		VHM	○	25113	1446
•	•	•	○	•	•		GT106		VHM		25858	1447
○	○	•	•	•	•		GT106		VHM	○	25862	1447
•	•	•	○	•	•		GT106		VHM		25859	1447
○	○	•	•	•	•		GT106		VHM	○	25863	1447
•	•	•	○	•	•		GT106		VHM		25734	1448
○	○	•	•	•	•		GT106		VHM	○	25738	1448
•	•	•	○	•	•		GT106		VHM		25735	1448
○	○	•	•	•	•		GT106		VHM	○	25739	1448
•	•	•	○	•	•		GT108		VHM		27120	1449
○	○	•	•	•	•		GT108		VHM	○	27122	1449
•	•	•	○	•	•		GT108		VHM		27121	1449
○	○	•	•	•	•		GT108		VHM	○	27123	1449
•	•	•	○	•	•		GT108		VHM		27220	1450
○	○	•	•	•	•		GT108		VHM	○	27222	1450
•	•	•	○	•	•		GT108		VHM		27221	1450
○	○	•	•	•	•		GT108		VHM	○	27223	1450
Cutting inserts for boring out and chamfering												
•	•	•	○	•	•		GT104		VHM		25116	1451
○	○	•	•	•	•		GT104		VHM	○	25120	1451
•	•	•	○	•	•		GT104		VHM		25117	1451
○	○	•	•	•	•		GT104		VHM	○	25121	1451



P	M	K	N	S	H	Tool illustration	Type	Cutting direction	Tool material	Surface	Article no.	Page
Cutting inserts for boring out and chamfering												
•	•	•	○	•	•		GT106		VHM		25866	1452
○	○	•	•	•	•		GT106		VHM	○	25870	1452
•	•	•	○	•	•		GT106		VHM		25867	1452
○	○	•	•	•	•		GT106		VHM	○	25871	1452
•	•	•	○	•	•		GT106		VHM		25742	1453
○	○	•	•	•	•		GT106		VHM	○	25746	1453
•	•	•	○	•	•		GT106		VHM		25743	1453
○	○	•	•	•	•		GT106		VHM	○	25747	1453
Cutting inserts for drilling into solid material and boring out Quattro Drill												
•	•	•	•	•	•		QG106		VHM		26906	1454
•	•	•	•	•	•		QG108		VHM		27290	1454



P	M	K	N	S	H	Tool illustration	Type	Cutting direction	Tool material	Surface	Article no.	Page
Cutting inserts for internal threading, part profile - metric standard threads												
•	•	•	○	•	•		GG104		VHM	a	25150	1455
○	○	•	•	•	•		GG104		VHM	○	25154	1455
•	•	•	○	•	•		GG104		VHM	a	25151	1455
○	○	•	•	•	•		GG104		VHM	○	25155	1455
•	•	•	○	•	•		GG106		VHM	a	25766	1456
○	○	•	•	•	•		GG106		VHM	○	25770	1456
•	•	•	○	•	•		GG106		VHM	a	25767	1456
○	○	•	•	•	•		GG106		VHM	○	25771	1456
•	•	•	○	•	•		GG108		VHM	a	27132	1457
○	○	•	•	•	•		GG108		VHM	○	27134	1457
•	•	•	○	•	•		GG108		VHM	a	27133	1457
○	○	•	•	•	•		GG108		VHM	○	27135	1457
Cutting inserts for internal threading, part profile - metric fine threads												
•	•	•	○	•	•		GG104		VHM	a	25158	1458
○	○	•	•	•	•		GG104		VHM	○	25162	1458
•	•	•	○	•	•		GG104		VHM	a	25159	1458
○	○	•	•	•	•		GG104		VHM	○	25163	1458
Cutting inserts for internal threading, full profile - metric standard threads												
•	•	•	○	•	•		GG104		VHM	a	25166	1459
○	○	•	•	•	•		GG104		VHM	○	25170	1459
•	•	•	○	•	•		GG104		VHM	a	25167	1459
○	○	•	•	•	•		GG104		VHM	○	25171	1459
•	•	•	○	•	•		GG106		VHM	a	25774	1460
○	○	•	•	•	•		GG106		VHM	○	25778	1460
•	•	•	○	•	•		GG106		VHM	a	25775	1460



P	M	K	N	S	H	Tool illustration	Type	Cutting direction	Tool material	Surface	Article no.	Page
Cutting inserts for internal threading, full profile - metric standard threads												
○	○	●					GG106		VHM	○	25779	1460
●	●	●	○	●	●		GG108		VHM	ⓐ	27136	1461
○	○	●					GG108		VHM	○	27138	1461
●	●	●	○	●	●		GG108		VHM	ⓐ	27137	1461
○	○	●					GG108		VHM	○	27139	1461
Cutting inserts for internal threading, part profile - UN threads												
●	●	●	○	●	●		GG104		VHM	ⓐ	25174	1462
○	○	●					GG104		VHM	○	25178	1462
●	●	●	○	●	●		GG104		VHM	ⓐ	25175	1462
○	○	●					GG104		VHM	○	25179	1462
Cutting inserts for internal threading, full profile - Whitworth pipe threads												
●	●	●	○	●	●		GG104		VHM	ⓐ	25182	1463
○	○	●					GG104		VHM	○	25186	1463
●	●	●	○	●	●		GG104		VHM	ⓐ	25183	1463
○	○	●					GG104		VHM	○	25187	1463
Cutting inserts for internal threading, part profile - trapezoidal thread												
●	●	●	○	●	●		GG106		VHM	ⓐ	25826	1464
○	○	●					GG106		VHM	○	25830	1464
●	●	●	○	●	●		GG106		VHM	ⓐ	25827	1464
○	○	●					GG106		VHM	○	25831	1464



P	M	K	N	S	H	Tool illustration	Type	Cutting direction	Tool material	Surface	Article no.	Page
Indexable inserts for threading, part profile, external												
●	○	○	○	○	○		GG305		VHM	F	25654	1465
●	●	○	○	●	○		GG305		VHM	E	25656	1465
○	○	●	○	○	○		GG305		VHM	○	25658	1465
●	○	○	○	○	○		GG305		VHM	F	25655	1465
●	●	○	○	●	○		GG305		VHM	E	25657	1465
○	○	●	○	○	○		GG305		VHM	○	25659	1465
Indexable inserts for threading, full profile, external												
●	○	○	○	○	○		GG305		VHM	F	25662	1466
●	●	○	○	●	○		GG305		VHM	E	25664	1466
○	○	●	○	○	○		GG305		VHM	○	25666	1466
●	○	○	○	○	○		GG305		VHM	F	25663	1466
●	●	○	○	●	○		GG305		VHM	E	25665	1466
○	○	●	○	○	○		GG305		VHM	○	25667	1466
Indexable inserts for threading, Withworth												
●	○	○	○	○	○		GG305		VHM	F	25668	1467
●	●	○	○	●	○		GG305		VHM	E	25670	1467
○	○	●	○	○	○		GG305		VHM	○	25672	1467
●	○	○	○	○	○		GG305		VHM	F	25669	1467



P	M	K	N	S	H	Tool illustration	Type	Cutting direction	Tool material	Surface	Article no.	Page
Indexable inserts for threading, Withworth												
●	●	○	○	●	○		GG305		VHM	Ⓔ	25671	1467
○	○	●					GG305		VHM	○	25673	1467
Indexable inserts for threading, UNC/UNF												
●	○	○	○	○	○		GG305		VHM	Ⓕ	25674	1468
●	●	○	○	●	○		GG305		VHM	Ⓔ	25676	1468
○	○	●					GG305		VHM	○	25678	1468
●	○	○	○	○	○		GG305		VHM	Ⓕ	25675	1468
●	●	○	○	●	○		GG305		VHM	Ⓔ	25677	1468
○	○	●					GG305		VHM	○	25679	1468



P	M	K	N	S	H	Tool illustration	Type	Cutting direction	Tool material	Surface	Article no.	Page
Cutting inserts for internal hexagon												
•	•	•	○	•	•		GN104		VHM	Ⓐ	25229	1469
○	○	•					GN104		VHM	○	25231	1469
•	•	•	○	•	•		GN106		VHM	Ⓐ	25897	1469
○	○	•					GN106		VHM	○	25898	1469
•	•	•	○	•	•		GN108		VHM	Ⓐ	27146	1470
○	○	•					GN108		VHM	○	27147	1470
Cutting inserts for internal square												
•	•	•	○	•	•		GN104		VHM	Ⓐ	25233	1471
○	○	•					GN104		VHM	○	25235	1471
Cutting inserts for Torx												
•	•	•	○	•	•		GN104		VHM	Ⓐ	25237	1472
○	○	•					GN104		VHM	○	25239	1472
Cutting inserts for broaching longitudinal slots												
•	•	•	○	•	•		GN106		VHM	Ⓐ	25813	1473
○	○	•					GN106		VHM	○	25815	1473
•	•	•	○	•	•		GN106		VHM	Ⓐ	25817	1473
○	○	•					GN106		VHM	○	25819	1473
•	•	•	○	•	•		GN106		VHM	Ⓐ	25821	1473
○	○	•					GN106		VHM	○	25823	1473
•	•	•	○	•	•		GN108		VHM	Ⓐ	27140	1474
○	○	•					GN108		VHM	○	27141	1474
•	•	•	○	•	•		GN108		VHM	Ⓐ	27142	1474
○	○	•					GN108		VHM	○	27143	1474
•	•	•	○	•	•		GN108		VHM	Ⓐ	27144	1474
○	○	•					GN108		VHM	○	27145	1474

Grooving tools



Tool illustration	Type	Design	Article no.	Page
Round shank holders, clamping screw above				
	GB104		25000	1475
	GB106		25300	1476
	GB108		27000	1477
	GB110		27050	1478
Round shank holders, clamping screw lateral				
	GB104		25001	1479
	GB106		25301	1480
	GB108		27001	1481
	GB110		27051	1482
Round shank holders, clamping screw above, four clamping surfaces				
	GB104		25018	1483
	GB106		25320	1484
	GB106		25325	1485
	GB108		27002	1486
	GB108		27018	1487
Round shank holders, clamping screw above, without clamping surfaces				
	GB104		25017	1488
	GB106		25319	1489
	GB108		27003	1490

Grooving tools



Tool illustration	Type	Design	Article no.	Page
Round shank holders, clamping screw above, for Citizen machine				
	GB104		25021	1491
	GB106		25316	1492
	GB108		27004	1493
Round shank holders, clamping screw above, for Star machine				
	GB104		25022	1494
	GB106		25317	1495
	GB108		27005	1496
Round shank holders, clamping screw above, for Tornos machine				
	GB104		25023	1497
	GB106		25318	1498
Round shank holders, for machine type Star, rear side machining				
	GB104		25024	1499
	GB106		25321	1500
	GB108		27016	1501



Tool illustration	Type	Design	Article no.	Page
Round shank holders for broaching				
	GB104		25006	1502
	GB106		25302	1503
	GB108		27015	1504
	GB110		27056	1505
Polygon shank holders, according to ISO 26623, straight 0°				
	GH104		25010	1506
	GH106		25307	1507
	GH108		27011	1508
Polygon shank holders, according to ISO 26623, offset 90°				
	GH104		25012	1509
	GH104		25013	1509
	GH106		25308	1510

Grooving tools



Tool illustration	Type	Design	Article no.	Page
Polygon shank holders, according to ISO 26623, offset 90°				
	GH106		25309	1510
	GH108		27012	1511
	GH108		27013	1511
HSK-T holders, according to ISO 12164-3, straight 0°				
	GH104		25016	1512
	GH106		25311	1513
	GH108		27014	1514
Square shank holders, straight 0°				
	GH104		25019	1515
	GH104		25020	1515
	GH106		25314	1516
	GH106		25315	1516
	GH108		27007	1517
	GH108		27008	1517



Tool illustration	Type	Design	Article no.	Page
Square shank holders, straight 0°				
	GH110		27052	1518
	GH110		27053	1518
Square shank holders, 90° offset				
	GH104		25002	1519
	GH104		25003	1519
	GH106		25304	1520
	GH106		25305	1520
	GH108		27009	1521
	GH108		27010	1521
	GH110		27054	1522
	GH110		27055	1522
Square shank holders 90° offset and stepped, without IC				
	GH104		25004	1523
	GH106		25303	1523

Grooving tools



Tool illustration	Type	Design	Article no.	Page
Square shank holders 90° offset and stepped, with IC				
	GH104		25005	1524
	GH106		25306	1524
Square shank holder straight, external machining, without IC				
	GH305		25350	1525
	GH305		25351	1525
	GH222		26100	1526
	GH222		26101	1526
Square shank holders straight, external machining, with IC				
	GH305		25352	1527
	GH305		25353	1527
	GH222		26102	1528
	GH222		26103	1528
Square shank holders straight, external machining, IC adjustable				
	GH305		25372	1529
	GH305		25373	1529



















Tool illustration	Type	Design	Article no.	Page
Square shank holders 90° offset, external machining, without IC				
	GH305		25356	1530
	GH305		25357	1530
Square shank holders 90° offset, external machining, with IC				
	GH305		25358	1531
	GH305		25359	1531
Square shank holders 45° offset, external machining, without IC				
	GH305		25362	1532
	GH305		25363	1532
Square shank holders 45° offset, external machining, with IC				
	GH305		25364	1533
	GH305		25365	1533
Round shank holders, internal machining, without IC				
	GB305		25368	1534
	GB305		25369	1534
Round shank holders, internal machining, with IC				
	GB305		25370	1535
	GB305		25371	1535
Parting off blade, without IC				
	GS222		26200	1536
Parting off blade, with IC				
	GS222		26201	1537

Grooving tools



Tool illustration	Type	Design	Article no.	Page
Reinforced parting off blade, without IC				
	GS222		26202	1538
	GS222		26203	1538
Reinforced parting off blade, with IC				
	GS222		26206	1539
	GS222		26207	1539



Tool illustration	Article no.	Page
Accessories		
	4915	1540
	4960	1540
	25904	1540
	25922	1540
	25921	1541
	25900	1541
	25901	1541
	25902	1541
	25906	1542
	25907	1542
	25908	1542
	25912	1542
	25905	1542
	25913	1543
	25909	1543
	25910	1543

Grooving tools



Tool illustration	Article no.	Page
Accessories 	25923	1543



Cutting inserts for internal grooving, flat bottom slots

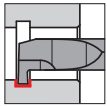

grooving depth 0.2-1.0mm
for tool holders type GB104/GH104



Cutting data page 1544

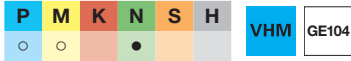

Cutting data page 1544

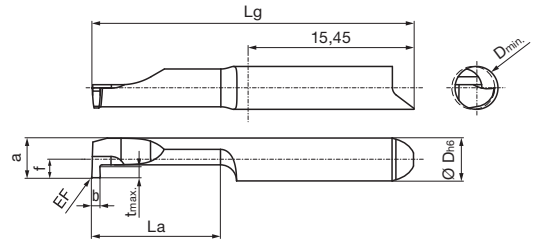

Right-hand design as shown. Left-hand design is mirror image.

Article no. **25126** a R

Article no. **25130** ○ R

Dmin. mm	b mm	f mm	a mm	EF mm	tmax. mm	La mm	Lg mm	D h6 mm	Code no.	Description
1.00	0.30	1.95	0.85	0.03	0.20	4.00	25.00	4.00	4.001	GE104.0030.000.04.10.R
1.00	0.30	1.95	0.85	0.03	0.20	7.00	25.00	4.00	4.002	GE104.0030.000.07.10.R
1.50	0.40	1.95	1.30	0.03	0.40	4.00	25.00	4.00	4.003	GE104.0040.000.04.15.R
1.50	0.40	1.95	1.30	0.03	0.40	7.00	25.00	4.00	4.004	GE104.0040.000.07.15.R
1.50	0.40	1.95	1.30	0.03	0.40	12.00	30.00	4.00	4.005	GE104.0040.000.12.15.R
2.00	0.50	1.95	1.80	0.03	0.50	4.00	25.00	4.00	4.006	GE104.0050.000.04.20.R
2.00	0.50	1.95	1.80	0.03	0.50	7.00	25.00	4.00	4.007	GE104.0050.000.07.20.R
2.00	0.50	1.95	1.80	0.03	0.50	12.00	30.00	4.00	4.008	GE104.0050.000.12.20.R
2.00	0.50	1.95	1.80	0.03	0.50	17.00	35.00	4.00	4.009	GE104.0050.000.17.20.R
3.00	0.70	1.95	2.70	0.03	0.70	7.00	25.00	4.00	4.010	GE104.0070.000.07.30.R
3.00	0.70	1.95	2.70	0.03	0.70	12.00	30.00	4.00	4.011	GE104.0070.000.12.30.R
3.00	0.70	1.95	2.70	0.03	0.70	17.00	35.00	4.00	4.012	GE104.0070.000.17.30.R
3.00	0.70	1.95	2.70	0.03	0.70	22.00	40.00	4.00	4.013	GE104.0070.000.22.30.R
4.00	0.79	1.70	3.70	0.03	1.00	12.00	30.00	4.00	4.014	GE104.0079.000.12.40.R
4.00	0.79	1.70	3.70	0.03	1.00	17.00	35.00	4.00	4.015	GE104.0079.000.17.40.R
4.00	0.79	1.70	3.70	0.03	1.00	22.00	40.00	4.00	4.016	GE104.0079.000.22.40.R
4.00	0.79	1.70	3.70	0.03	1.00	27.00	45.00	4.00	4.017	GE104.0079.000.27.40.R
4.00	0.79	1.70	3.70	0.03	1.00	32.00	50.00	4.00	4.018	GE104.0079.000.32.40.R
4.00	1.00	1.70	3.70	0.05	1.00	12.00	30.00	4.00	4.019	GE104.0100.000.12.40.R
4.00	1.00	1.70	3.70	0.05	1.00	17.00	35.00	4.00	4.020	GE104.0100.000.17.40.R
4.00	1.00	1.70	3.70	0.05	1.00	22.00	40.00	4.00	4.021	GE104.0100.000.22.40.R
4.00	1.00	1.70	3.70	0.05	1.00	27.00	45.00	4.00	4.022	GE104.0100.000.27.40.R
4.00	1.00	1.70	3.70	0.05	1.00	32.00	50.00	4.00	4.023	GE104.0100.000.32.40.R
4.00	1.50	1.70	3.70	0.05	1.00	12.00	30.00	4.00	4.024	GE104.0150.000.12.40.R
4.00	1.50	1.70	3.70	0.05	1.00	17.00	35.00	4.00	4.025	GE104.0150.000.17.40.R
4.00	1.50	1.70	3.70	0.05	1.00	22.00	40.00	4.00	4.026	GE104.0150.000.22.40.R
4.00	1.50	1.70	3.70	0.05	1.00	27.00	45.00	4.00	4.027	GE104.0150.000.27.40.R
4.00	1.50	1.70	3.70	0.05	1.00	32.00	50.00	4.00	4.028	GE104.0150.000.32.40.R

Article no. **25127** a L

On the left-hand design, the designation changes to .L

Article no. **25131** ○ L



Cutting inserts for internal grooving, flat bottom slots

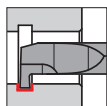

grooving depth up to 1.2 mm
for tool holders type GB106/GH106



VHM

GE106



Cutting data page 1544

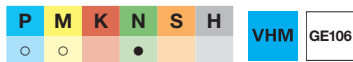

VHM

GE106



Cutting data page 1544

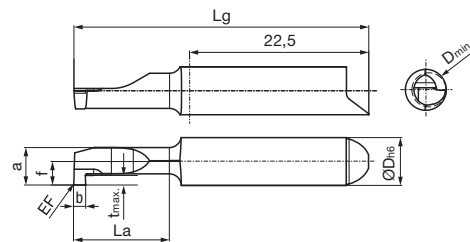

Right-hand design as shown. Left-hand design is mirror image.

Article no. **25874**



Article no. **25878**



Dmin. mm	b mm	f mm	a mm	EF mm	tmax. mm	La mm	Lg mm	D h6 mm	Code no.	Description
5.00	1.00	2.95	4.70	0.05	1.20	12.00	37.00	6.00	6.010	GE106.0100.000.12.50.R
5.00	1.00	2.95	4.70	0.05	1.20	17.00	42.00	6.00	6.020	GE106.0100.000.17.50.R
5.00	1.00	2.95	4.70	0.05	1.20	22.00	47.00	6.00	6.030	GE106.0100.000.22.50.R
5.00	1.00	2.95	4.70	0.05	1.20	27.00	52.00	6.00	6.040	GE106.0100.000.27.50.R
5.00	1.00	2.95	4.70	0.05	1.20	32.00	57.00	6.00	6.050	GE106.0100.000.32.50.R
5.00	1.00	2.95	4.70	0.05	1.20	37.00	62.00	6.00	6.060	GE106.0100.000.37.50.R
5.00	1.00	2.95	4.70	0.05	1.20	42.00	67.00	6.00	6.070	GE106.0100.000.42.50.R
5.00	1.50	2.95	4.70	0.05	1.20	12.00	37.00	6.00	6.110	GE106.0150.000.12.50.R
5.00	1.50	2.95	4.70	0.05	1.20	17.00	42.00	6.00	6.120	GE106.0150.000.17.50.R
5.00	1.50	2.95	4.70	0.05	1.20	22.00	47.00	6.00	6.130	GE106.0150.000.22.50.R
5.00	1.50	2.95	4.70	0.05	1.20	27.00	52.00	6.00	6.140	GE106.0150.000.27.50.R
5.00	1.50	2.95	4.70	0.05	1.20	32.00	57.00	6.00	6.150	GE106.0150.000.32.50.R
5.00	1.50	2.95	4.70	0.05	1.20	37.00	62.00	6.00	6.160	GE106.0150.000.37.50.R
5.00	1.50	2.95	4.70	0.05	1.20	42.00	67.00	6.00	6.170	GE106.0150.000.42.50.R
5.00	2.00	2.95	4.70	0.05	1.20	12.00	37.00	6.00	6.210	GE106.0200.000.12.50.R
5.00	2.00	2.95	4.70	0.05	1.20	17.00	42.00	6.00	6.220	GE106.0200.000.17.50.R
5.00	2.00	2.95	4.70	0.05	1.20	22.00	47.00	6.00	6.230	GE106.0200.000.22.50.R
5.00	2.00	2.95	4.70	0.05	1.20	27.00	52.00	6.00	6.240	GE106.0200.000.27.50.R
5.00	2.00	2.95	4.70	0.05	1.20	32.00	57.00	6.00	6.250	GE106.0200.000.32.50.R
5.00	2.00	2.95	4.70	0.05	1.20	37.00	62.00	6.00	6.260	GE106.0200.000.37.50.R
5.00	2.00	2.95	4.70	0.05	1.20	42.00	67.00	6.00	6.270	GE106.0200.000.42.50.R

Article no. **25875**



Article no. **25879**



On the left-hand design, the designation changes to .L



Cutting inserts for internal grooving, flat bottom slots

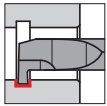

grooving depth up to 2 mm
for tool holders type GB106/GH106



P	M	K	N	S	H	VHM	GE106	a	Cutting data page 1544
•	•	•	○	•	•				



P	M	K	N	S	H	VHM	GE106	○	Cutting data page 1544
○	○	•	•	•	•				

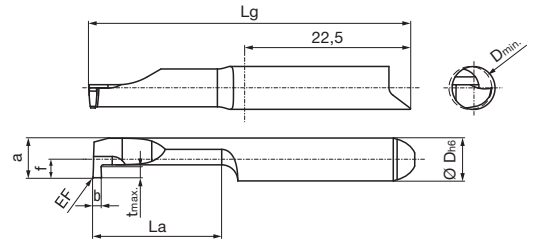

Article no. **25750** **a** **R**

Article no. **25754** ○ **R**

Right-hand design as shown. Left-hand design is mirror image.

Dmin. mm	b mm	f mm	a mm	EF mm	tmax. mm	La mm	Lg mm	D h6 mm	Code no.	Description
6.00	1.00	2.70	5.70	0.05	2.00	12.00	37.00	6.00	6.001	GE106.0100.000.12.60.R
6.00	1.00	2.70	5.70	0.05	2.00	17.00	42.00	6.00	6.002	GE106.0100.000.17.60.R
6.00	1.00	2.70	5.70	0.05	2.00	22.00	47.00	6.00	6.003	GE106.0100.000.22.60.R
6.00	1.00	2.70	5.70	0.05	2.00	27.00	52.00	6.00	6.004	GE106.0100.000.27.60.R
6.00	1.00	2.70	5.70	0.05	2.00	32.00	57.00	6.00	6.005	GE106.0100.000.32.60.R
6.00	1.00	2.70	5.70	0.05	2.00	37.00	62.00	6.00	6.006	GE106.0100.000.37.60.R
6.00	1.00	2.70	5.70	0.05	2.00	42.00	67.00	6.00	6.007	GE106.0100.000.42.60.R
6.00	1.50	2.70	5.70	0.05	2.00	12.00	37.00	6.00	6.008	GE106.0150.000.12.60.R
6.00	1.50	2.70	5.70	0.05	2.00	17.00	42.00	6.00	6.009	GE106.0150.000.17.60.R
6.00	1.50	2.70	5.70	0.05	2.00	22.00	47.00	6.00	6.010	GE106.0150.000.22.60.R
6.00	1.50	2.70	5.70	0.05	2.00	27.00	52.00	6.00	6.011	GE106.0150.000.27.60.R
6.00	1.50	2.70	5.70	0.05	2.00	32.00	57.00	6.00	6.012	GE106.0150.000.32.60.R
6.00	1.50	2.70	5.70	0.05	2.00	37.00	62.00	6.00	6.013	GE106.0150.000.37.60.R
6.00	1.50	2.70	5.70	0.05	2.00	42.00	67.00	6.00	6.014	GE106.0150.000.42.60.R
6.00	2.00	2.70	5.70	0.05	2.00	12.00	37.00	6.00	6.015	GE106.0200.000.12.60.R
6.00	2.00	2.70	5.70	0.05	2.00	17.00	42.00	6.00	6.016	GE106.0200.000.17.60.R
6.00	2.00	2.70	5.70	0.05	2.00	22.00	47.00	6.00	6.017	GE106.0200.000.22.60.R
6.00	2.00	2.70	5.70	0.05	2.00	27.00	52.00	6.00	6.018	GE106.0200.000.27.60.R
6.00	2.00	2.70	5.70	0.05	2.00	32.00	57.00	6.00	6.019	GE106.0200.000.32.60.R
6.00	2.00	2.70	5.70	0.05	2.00	37.00	62.00	6.00	6.020	GE106.0200.000.37.60.R
6.00	2.00	2.70	5.70	0.05	2.00	42.00	67.00	6.00	6.021	GE106.0200.000.42.60.R

Article no. **25751** **a** **L**

Article no. **25755** ○ **L**

On the left-hand design, the designation changes to .L



Cutting inserts for internal grooving, flat bottom slots

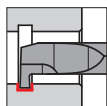

grooving depth up to 2.5 mm
for tool holders type GB108/GH108



a Cutting data page 1544

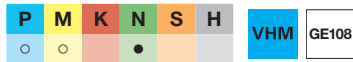

○ Cutting data page 1544

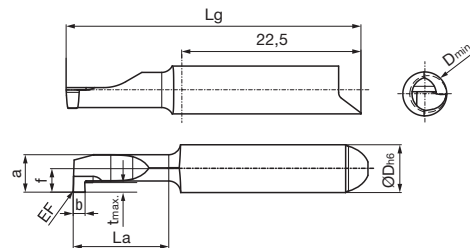

Right-hand design as shown. Left-hand design is mirror image.

Article no. **27124** **a** **R**

Article no. **27126** ○ **R**

Dmin. mm	b mm	f mm	a mm	EF mm	tmax. mm	La mm	Lg mm	D h6 mm	Code no.	Description
7.00	1.50	3.95	6.70	0.05	2.50	17.00	42.00	8.00	8.010	GE108.0150.000.17.70.R
7.00	1.50	3.95	6.70	0.05	2.50	27.00	52.00	8.00	8.020	GE108.0150.000.27.70.R
7.00	1.50	3.95	6.70	0.05	2.50	37.00	62.00	8.00	8.030	GE108.0150.000.37.70.R
7.00	1.50	3.95	6.70	0.05	2.50	42.00	67.00	8.00	8.040	GE108.0150.000.42.70.R
7.00	1.50	3.95	6.70	0.05	2.50	47.00	72.00	8.00	8.050	GE108.0150.000.47.70.R
7.00	2.00	3.95	6.70	0.05	2.50	17.00	42.00	8.00	8.110	GE108.0200.000.17.70.R
7.00	2.00	3.95	6.70	0.05	2.50	27.00	52.00	8.00	8.120	GE108.0200.000.27.70.R
7.00	2.00	3.95	6.70	0.05	2.50	37.00	62.00	8.00	8.130	GE108.0200.000.37.70.R
7.00	2.00	3.95	6.70	0.05	2.50	42.00	67.00	8.00	8.140	GE108.0200.000.42.70.R
7.00	2.00	3.95	6.70	0.05	2.50	47.00	72.00	8.00	8.150	GE108.0200.000.47.70.R
7.00	2.50	3.95	6.70	0.05	2.50	17.00	42.00	8.00	8.210	GE108.0250.000.17.70.R
7.00	2.50	3.95	6.70	0.05	2.50	27.00	52.00	8.00	8.220	GE108.0250.000.27.70.R
7.00	2.50	3.95	6.70	0.05	2.50	37.00	62.00	8.00	8.230	GE108.0250.000.37.70.R
7.00	2.50	3.95	6.70	0.05	2.50	42.00	67.00	8.00	8.240	GE108.0250.000.42.70.R
7.00	2.50	3.95	6.70	0.05	2.50	47.00	72.00	8.00	8.250	GE108.0250.000.47.70.R
7.00	3.00	3.95	6.70	0.05	2.50	17.00	42.00	8.00	8.310	GE108.0300.000.17.70.R
7.00	3.00	3.95	6.70	0.05	2.50	27.00	52.00	8.00	8.320	GE108.0300.000.27.70.R
7.00	3.00	3.95	6.70	0.05	2.50	37.00	62.00	8.00	8.330	GE108.0300.000.37.70.R
7.00	3.00	3.95	6.70	0.05	2.50	42.00	67.00	8.00	8.340	GE108.0300.000.42.70.R
7.00	3.00	3.95	6.70	0.05	2.50	47.00	72.00	8.00	8.350	GE108.0300.000.47.70.R

Article no. **27125** **a** **L**

Article no. **27127** ○ **L**

On the left-hand design, the designation changes to .L



Cutting inserts for internal grooving, flat bottom slots

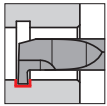

grooving depth up to 3 mm
for tool holders type GB108/GH108



P	M	K	N	S	H	VHM	GE108	a	Cutting data page 1544
•	•	•	○	•	•				



P	M	K	N	S	H	VHM	GE108	○	Cutting data page 1544
○	○	•	•	•	•				

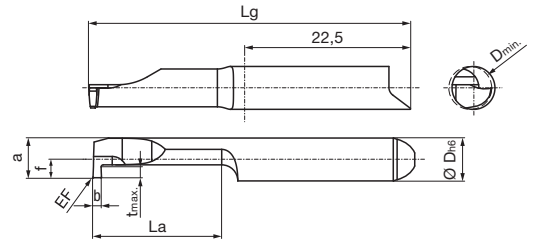

Right-hand design as shown. Left-hand design is mirror image.

Article no. **27224** **a** **(R)**
 Article no. **27225** ○ **(R)**

Dmin. mm	b mm	f mm	a mm	EF mm	tmax. mm	La mm	Lg mm	D h6 mm	Code no.	Description
8.00	1.50	3.70	7.70	0.05	3.00	17.00	42.00	8.00	8.010	GE108.0150.000.17.80.R
8.00	1.50	3.70	7.70	0.05	3.00	27.00	52.00	8.00	8.020	GE108.0150.000.27.80.R
8.00	1.50	3.70	7.70	0.05	3.00	37.00	62.00	8.00	8.030	GE108.0150.000.37.80.R
8.00	1.50	3.70	7.70	0.05	3.00	42.00	67.00	8.00	8.040	GE108.0150.000.42.80.R
8.00	1.50	3.70	7.70	0.05	3.00	47.00	72.00	8.00	8.050	GE108.0150.000.47.80.R
8.00	2.00	3.70	7.70	0.05	3.00	17.00	42.00	8.00	8.110	GE108.0200.000.17.80.R
8.00	2.00	3.70	7.70	0.05	3.00	27.00	52.00	8.00	8.120	GE108.0200.000.27.80.R
8.00	2.00	3.70	7.70	0.05	3.00	37.00	62.00	8.00	8.130	GE108.0200.000.37.80.R
8.00	2.00	3.70	7.70	0.05	3.00	42.00	67.00	8.00	8.140	GE108.0200.000.42.80.R
8.00	2.00	3.70	7.70	0.05	3.00	47.00	72.00	8.00	8.150	GE108.0200.000.47.80.R
8.00	2.50	3.70	7.70	0.05	3.00	17.00	42.00	8.00	8.210	GE108.0250.000.17.80.R
8.00	2.50	3.70	7.70	0.05	3.00	27.00	52.00	8.00	8.220	GE108.0250.000.27.80.R
8.00	2.50	3.70	7.70	0.05	3.00	37.00	62.00	8.00	8.230	GE108.0250.000.37.80.R
8.00	2.50	3.70	7.70	0.05	3.00	42.00	67.00	8.00	8.240	GE108.0250.000.42.80.R
8.00	2.50	3.70	7.70	0.05	3.00	47.00	72.00	8.00	8.250	GE108.0250.000.47.80.R
8.00	3.00	3.70	7.70	0.05	3.00	17.00	42.00	8.00	8.310	GE108.0300.000.17.80.R
8.00	3.00	3.70	7.70	0.05	3.00	27.00	52.00	8.00	8.320	GE108.0300.000.27.80.R
8.00	3.00	3.70	7.70	0.05	3.00	37.00	62.00	8.00	8.330	GE108.0300.000.37.80.R
8.00	3.00	3.70	7.70	0.05	3.00	42.00	67.00	8.00	8.340	GE108.0300.000.42.80.R
8.00	3.00	3.70	7.70	0.05	3.00	47.00	72.00	8.00	8.350	GE108.0300.000.47.80.R

Article no. **27226** **a** **(L)**
 Article no. **27227** ○ **(L)**

On the left-hand design, the designation changes to .L



Cutting inserts for internal grooving, full radius slots

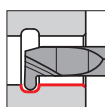

grooving depth 0.7-1.0 mm • full radius R0.4-R0.58 mm
for tool holders type GB104/GH104



a Cutting data page 1544



○ Cutting data page 1544

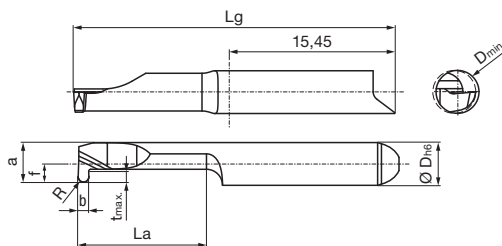

Right-hand design as shown. Left-hand design is mirror image.

Article no. **25134** **a** **R**

Article no. **25138** ○ **R**

Dmin. mm	b mm	R mm	f mm	a mm	tmax. mm	La mm	Lg mm	D h6 mm	Code no.	Description
3.00	0.80	0.40	1.95	2.70	0.70	7.00	25.00	4.00	4.001	GE104.0080.040.07.30.R
3.00	0.80	0.40	1.95	2.70	0.70	12.00	30.00	4.00	4.002	GE104.0080.040.12.30.R
3.00	0.80	0.40	1.95	2.70	0.70	17.00	35.00	4.00	4.003	GE104.0080.040.17.30.R
3.00	0.80	0.40	1.95	2.70	0.70	22.00	40.00	4.00	4.004	GE104.0080.040.22.30.R
4.00	1.00	0.50	1.70	3.70	1.00	12.00	30.00	4.00	4.005	GE104.0100.050.12.40.R
4.00	1.00	0.50	1.70	3.70	1.00	17.00	35.00	4.00	4.006	GE104.0100.050.17.40.R
4.00	1.00	0.50	1.70	3.70	1.00	22.00	40.00	4.00	4.007	GE104.0100.050.22.40.R
4.00	1.00	0.50	1.70	3.70	1.00	27.00	45.00	4.00	4.008	GE104.0100.050.27.40.R
4.00	1.00	0.50	1.70	3.70	1.00	32.00	50.00	4.00	4.009	GE104.0100.050.32.40.R
4.00	1.17	0.58	1.70	3.70	1.00	12.00	30.00	4.00	4.010	GE104.0117.058.12.40.R
4.00	1.17	0.58	1.70	3.70	1.00	17.00	35.00	4.00	4.011	GE104.0117.058.17.40.R
4.00	1.17	0.58	1.70	3.70	1.00	22.00	40.00	4.00	4.012	GE104.0117.058.22.40.R
4.00	1.17	0.58	1.70	3.70	1.00	27.00	45.00	4.00	4.013	GE104.0117.058.27.40.R
4.00	1.17	0.58	1.70	3.70	1.00	32.00	50.00	4.00	4.014	GE104.0117.058.32.40.R

Article no. **25135** **a** **L**

Article no. **25139** ○ **L**

On the left-hand design, the designation changes to .L



Cutting inserts for internal grooving, full radius slots

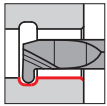

grooving depth up to 1.2 mm • full radius R0.5-R1.0 mm
for tool holders type GB106/GH106



P	M	K	N	S	H	VHM	GE106	a	Cutting data page 1544
•	•	•	○	•	•				



P	M	K	N	S	H	VHM	GE106	○	Cutting data page 1544
○	○	•	•	•	•				

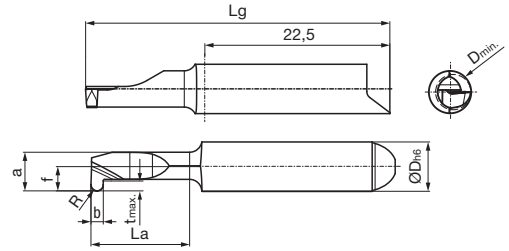

Right-hand design as shown. Left-hand design is mirror image.

Article no. **25882** **a** **R**

Article no. **25886** ○ **R**

Dmin. mm	b mm	R mm	f mm	a mm	tmax. mm	La mm	Lg mm	D h6 mm	Code no.	Description
5.00	1.00	0.50	2.95	4.70	1.20	12.00	37.00	6.00	6.010	GE106.0100.050.12.50.R
5.00	1.00	0.50	2.95	4.70	1.20	17.00	42.00	6.00	6.020	GE106.0100.050.17.50.R
5.00	1.00	0.50	2.95	4.70	1.20	22.00	47.00	6.00	6.030	GE106.0100.050.22.50.R
5.00	1.00	0.50	2.95	4.70	1.20	27.00	52.00	6.00	6.040	GE106.0100.050.27.50.R
5.00	1.00	0.50	2.95	4.70	1.20	32.00	57.00	6.00	6.050	GE106.0100.050.32.50.R
5.00	1.00	0.50	2.95	4.70	1.20	37.00	62.00	6.00	6.060	GE106.0100.050.37.50.R
5.00	1.00	0.50	2.95	4.70	1.20	42.00	67.00	6.00	6.070	GE106.0100.050.42.50.R
5.00	1.50	0.75	2.95	4.70	1.20	12.00	37.00	6.00	6.110	GE106.0150.075.12.50.R
5.00	1.50	0.75	2.95	4.70	1.20	17.00	42.00	6.00	6.120	GE106.0150.075.17.50.R
5.00	1.50	0.75	2.95	4.70	1.20	22.00	47.00	6.00	6.130	GE106.0150.075.22.50.R
5.00	1.50	0.75	2.95	4.70	1.20	27.00	52.00	6.00	6.140	GE106.0150.075.27.50.R
5.00	1.50	0.75	2.95	4.70	1.20	32.00	57.00	6.00	6.150	GE106.0150.075.32.50.R
5.00	1.50	0.75	2.95	4.70	1.20	37.00	62.00	6.00	6.160	GE106.0150.075.37.50.R
5.00	1.50	0.75	2.95	4.70	1.20	42.00	67.00	6.00	6.170	GE106.0150.075.42.50.R
5.00	2.00	1.00	2.95	4.70	1.20	12.00	37.00	6.00	6.210	GE106.0200.100.12.50.R
5.00	2.00	1.00	2.95	4.70	1.20	17.00	42.00	6.00	6.220	GE106.0200.100.17.50.R
5.00	2.00	1.00	2.95	4.70	1.20	22.00	47.00	6.00	6.230	GE106.0200.100.22.50.R
5.00	2.00	1.00	2.95	4.70	1.20	27.00	52.00	6.00	6.240	GE106.0200.100.27.50.R
5.00	2.00	1.00	2.95	4.70	1.20	32.00	57.00	6.00	6.250	GE106.0200.100.32.50.R
5.00	2.00	1.00	2.95	4.70	1.20	37.00	62.00	6.00	6.260	GE106.0200.100.37.50.R
5.00	2.00	1.00	2.95	4.70	1.20	42.00	67.00	6.00	6.270	GE106.0200.100.42.50.R

Article no. **25883** **a** **L**

Article no. **25887** ○ **L**

On the left-hand design, the designation changes to .L



Cutting inserts for internal grooving, full radius slots

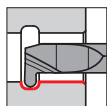

grooving depth up to 2 mm • full radius R0.5-R1.0 mm
for tool holders type GB106/GH106



Cutting data page 1544

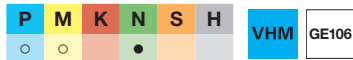

Cutting data page 1544

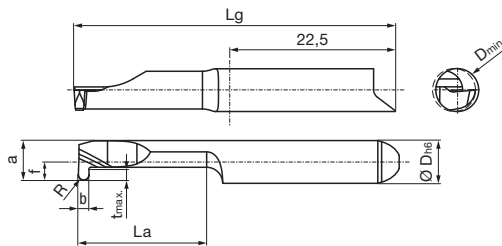

Right-hand design as shown. Left-hand design is mirror image.

Article no. **25758** **a** **R**

Article no. **25762** ○ **R**

Dmin. mm	b mm	R mm	f mm	a mm	tmax. mm	La mm	Lg mm	D h6 mm	Code no.	Description
6.00	1.00	0.50	2.70	5.70	2.00	12.00	37.00	6.00	6.001	GE106.0100.050.12.60.R
6.00	1.00	0.50	2.70	5.70	2.00	17.00	42.00	6.00	6.002	GE106.0100.050.17.60.R
6.00	1.00	0.50	2.70	5.70	2.00	22.00	47.00	6.00	6.003	GE106.0100.050.22.60.R
6.00	1.00	0.50	2.70	5.70	2.00	27.00	52.00	6.00	6.004	GE106.0100.050.27.60.R
6.00	1.00	0.50	2.70	5.70	2.00	32.00	57.00	6.00	6.005	GE106.0100.050.32.60.R
6.00	1.00	0.50	2.70	5.70	2.00	37.00	62.00	6.00	6.006	GE106.0100.050.37.60.R
6.00	1.00	0.50	2.70	5.70	2.00	42.00	67.00	6.00	6.007	GE106.0100.050.42.60.R
6.00	1.50	0.75	2.70	5.70	2.00	12.00	37.00	6.00	6.008	GE106.0150.075.12.60.R
6.00	1.50	0.75	2.70	5.70	2.00	17.00	42.00	6.00	6.009	GE106.0150.075.17.60.R
6.00	1.50	0.75	2.70	5.70	2.00	22.00	47.00	6.00	6.010	GE106.0150.075.22.60.R
6.00	1.50	0.75	2.70	5.70	2.00	27.00	52.00	6.00	6.011	GE106.0150.075.27.60.R
6.00	1.50	0.75	2.70	5.70	2.00	32.00	57.00	6.00	6.012	GE106.0150.075.32.60.R
6.00	1.50	0.75	2.70	5.70	2.00	37.00	62.00	6.00	6.013	GE106.0150.075.37.60.R
6.00	1.50	0.75	2.70	5.70	2.00	42.00	67.00	6.00	6.014	GE106.0150.075.42.60.R
6.00	2.00	1.00	2.70	5.70	2.00	12.00	37.00	6.00	6.015	GE106.0200.100.12.60.R
6.00	2.00	1.00	2.70	5.70	2.00	17.00	42.00	6.00	6.016	GE106.0200.100.17.60.R
6.00	2.00	1.00	2.70	5.70	2.00	22.00	47.00	6.00	6.017	GE106.0200.100.22.60.R
6.00	2.00	1.00	2.70	5.70	2.00	27.00	52.00	6.00	6.018	GE106.0200.100.27.60.R
6.00	2.00	1.00	2.70	5.70	2.00	32.00	57.00	6.00	6.019	GE106.0200.100.32.60.R
6.00	2.00	1.00	2.70	5.70	2.00	37.00	62.00	6.00	6.020	GE106.0200.100.37.60.R
6.00	2.00	1.00	2.70	5.70	2.00	42.00	67.00	6.00	6.021	GE106.0200.100.42.60.R

Article no. **25759** **a** **L**

Article no. **25763** ○ **L**

On the left-hand design, the designation changes to .L



Cutting inserts for internal grooving, full radius slots

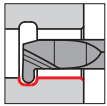

grooving depth up to 2.5 mm • full radius R0.75-R1.5 mm
for tool holders type GB108/GH108



P	M	K	N	S	H	VHM	GE108	a	Cutting data page 1544
●	●	●	○	●	●				



P	M	K	N	S	H	VHM	GE108	○	Cutting data page 1544
○	○	●	○	○	○				

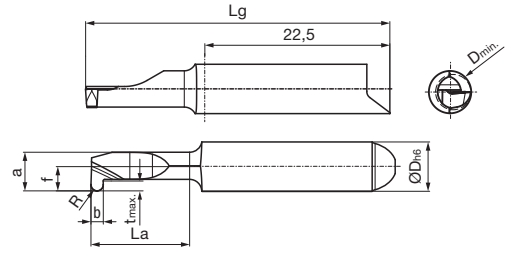

Right-hand design as shown. Left-hand design is mirror image.

Article no. **27128** **a** **(R)**
 Article no. **27130** ○ **(R)**

Dmin. mm	b mm	R mm	f mm	a mm	tmax. mm	La mm	Lg mm	D h6 mm	Code no.	Description
7.00	1.50	0.75	3.95	6.70	2.50	17.00	42.00	8.00	8.010	GE108.0150.075.17.70.R
7.00	1.50	0.75	3.95	6.70	2.50	27.00	52.00	8.00	8.020	GE108.0150.075.27.70.R
7.00	1.50	0.75	3.95	6.70	2.50	37.00	62.00	8.00	8.030	GE108.0150.075.37.70.R
7.00	1.50	0.75	3.95	6.70	2.50	42.00	67.00	8.00	8.040	GE108.0150.075.42.70.R
7.00	1.50	0.75	3.95	6.70	2.50	47.00	72.00	8.00	8.050	GE108.0150.075.47.70.R
7.00	2.00	1.00	3.95	6.70	2.50	17.00	42.00	8.00	8.110	GE108.0200.100.17.70.R
7.00	2.00	1.00	3.95	6.70	2.50	27.00	52.00	8.00	8.120	GE108.0200.100.27.70.R
7.00	2.00	1.00	3.95	6.70	2.50	37.00	62.00	8.00	8.130	GE108.0200.100.37.70.R
7.00	2.00	1.00	3.95	6.70	2.50	42.00	67.00	8.00	8.140	GE108.0200.100.42.70.R
7.00	2.00	1.00	3.95	6.70	2.50	47.00	72.00	8.00	8.150	GE108.0200.100.47.70.R
7.00	2.50	1.25	3.95	6.70	2.50	17.00	42.00	8.00	8.210	GE108.0250.125.17.70.R
7.00	2.50	1.25	3.95	6.70	2.50	27.00	52.00	8.00	8.220	GE108.0250.125.27.70.R
7.00	2.50	1.25	3.95	6.70	2.50	37.00	62.00	8.00	8.230	GE108.0250.125.37.70.R
7.00	2.50	1.25	3.95	6.70	2.50	42.00	67.00	8.00	8.240	GE108.0250.125.42.70.R
7.00	2.50	1.25	3.95	6.70	2.50	47.00	72.00	8.00	8.250	GE108.0250.125.47.70.R
7.00	3.00	1.50	3.95	6.70	2.50	17.00	42.00	8.00	8.310	GE108.0300.150.17.70.R
7.00	3.00	1.50	3.95	6.70	2.50	27.00	52.00	8.00	8.320	GE108.0300.150.27.70.R
7.00	3.00	1.50	3.95	6.70	2.50	37.00	62.00	8.00	8.330	GE108.0300.150.37.70.R
7.00	3.00	1.50	3.95	6.70	2.50	42.00	67.00	8.00	8.340	GE108.0300.150.42.70.R
7.00	3.00	1.50	3.95	6.70	2.50	47.00	72.00	8.00	8.350	GE108.0300.150.47.70.R

Article no. **27129** **a** **(L)**
 Article no. **27131** ○ **(L)**

On the left-hand design, the designation changes to .L



Cutting inserts for internal grooving, full radius slots

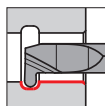

grooving depth up to 3 mm • full radius R0.75-R1.5 mm
for tool holders type GB108/GH108



a Cutting data page 1544

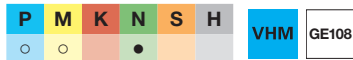

○ Cutting data page 1544

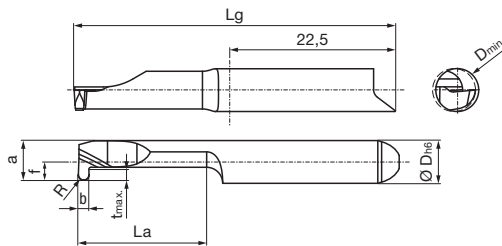

Right-hand design as shown. Left-hand design is mirror image.

Article no. **27228** **a** **R**

Article no. **27230** ○ **R**

Dmin. mm	b mm	R mm	f mm	a mm	tmax. mm	La mm	Lg mm	D h6 mm	Code no.	Description
8.00	1.50	0.75	3.70	7.70	3.00	17.00	42.00	8.00	8.010	GE108.0150.075.17.80.R
8.00	1.50	0.75	3.70	7.70	3.00	27.00	52.00	8.00	8.020	GE108.0150.075.27.80.R
8.00	1.50	0.75	3.70	7.70	3.00	37.00	62.00	8.00	8.030	GE108.0150.075.37.80.R
8.00	1.50	0.75	3.70	7.70	3.00	42.00	67.00	8.00	8.040	GE108.0150.075.42.80.R
8.00	1.50	0.75	3.70	7.70	3.00	47.00	72.00	8.00	8.050	GE108.0150.075.47.80.R
8.00	2.00	1.00	3.70	7.70	3.00	17.00	42.00	8.00	8.110	GE108.0200.100.17.80.R
8.00	2.00	1.00	3.70	7.70	3.00	27.00	52.00	8.00	8.120	GE108.0200.100.27.80.R
8.00	2.00	1.00	3.70	7.70	3.00	37.00	62.00	8.00	8.130	GE108.0200.100.37.80.R
8.00	2.00	1.00	3.70	7.70	3.00	42.00	67.00	8.00	8.140	GE108.0200.100.42.80.R
8.00	2.00	1.00	3.70	7.70	3.00	47.00	72.00	8.00	8.150	GE108.0200.100.47.80.R
8.00	2.50	1.25	3.70	7.70	3.00	17.00	42.00	8.00	8.210	GE108.0250.125.17.80.R
8.00	2.50	1.25	3.70	7.70	3.00	27.00	52.00	8.00	8.220	GE108.0250.125.27.80.R
8.00	2.50	1.25	3.70	7.70	3.00	37.00	62.00	8.00	8.230	GE108.0250.125.37.80.R
8.00	2.50	1.25	3.70	7.70	3.00	42.00	67.00	8.00	8.240	GE108.0250.125.42.80.R
8.00	2.50	1.25	3.70	7.70	3.00	47.00	72.00	8.00	8.250	GE108.0250.125.47.80.R
8.00	3.00	1.50	3.70	7.70	3.00	17.00	42.00	8.00	8.310	GE108.0300.150.17.80.R
8.00	3.00	1.50	3.70	7.70	3.00	27.00	52.00	8.00	8.320	GE108.0300.150.27.80.R
8.00	3.00	1.50	3.70	7.70	3.00	37.00	62.00	8.00	8.330	GE108.0300.150.37.80.R
8.00	3.00	1.50	3.70	7.70	3.00	42.00	67.00	8.00	8.340	GE108.0300.150.42.80.R
8.00	3.00	1.50	3.70	7.70	3.00	47.00	72.00	8.00	8.350	GE108.0300.150.47.80.R

Article no. **27229** **a** **L**

Article no. **27231** ○ **L**

On the left-hand design, the designation changes to .L



Cutting inserts for internal pre-grooving and chamfering

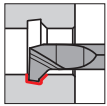

45° chamfer
for tool holders type GB104/GH104



P
M
K
N
S
H
VHM
GV104
a

Cutting data page 1544



P
M
K
N
S
H
VHM
GV104
○

Cutting data page 1544

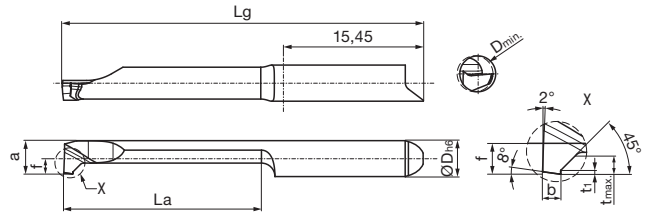

Right-hand design as shown. Left-hand design is mirror image.

Article no. **25142** a R

Article no. **25146** ○ R

Dmin. mm	b mm	f mm	t1 mm	a mm	tmax. mm	La mm	Lg mm	D h6 mm	Code no.	Description
2.00	0.70	1.95	0.20	1.80	0.50	4.00	25.00	4.00	4.001	GV104.0807.045.04.20.R
2.00	0.70	1.95	0.20	1.80	0.50	7.00	25.00	4.00	4.002	GV104.0807.045.07.20.R
2.00	0.70	1.95	0.20	1.80	0.50	12.00	30.00	4.00	4.003	GV104.0807.045.12.20.R
2.00	0.70	1.95	0.20	1.80	0.50	17.00	35.00	4.00	4.004	GV104.0807.045.17.20.R
3.00	0.70	1.95	0.20	2.70	0.70	7.00	25.00	4.00	4.005	GV104.0807.045.07.30.R
3.00	0.70	1.95	0.20	2.70	0.70	12.00	30.00	4.00	4.006	GV104.0807.045.12.30.R
3.00	0.70	1.95	0.20	2.70	0.70	17.00	35.00	4.00	4.007	GV104.0807.045.17.30.R
3.00	0.70	1.95	0.20	2.70	0.70	22.00	40.00	4.00	4.008	GV104.0807.045.22.30.R
4.00	1.00	1.70	0.20	3.70	1.00	12.00	30.00	4.00	4.009	GV104.0810.045.12.40.R
4.00	1.00	1.70	0.20	3.70	1.00	17.00	35.00	4.00	4.010	GV104.0810.045.17.40.R
4.00	1.00	1.70	0.20	3.70	1.00	22.00	40.00	4.00	4.011	GV104.0810.045.22.40.R
4.00	1.00	1.70	0.20	3.70	1.00	27.00	45.00	4.00	4.012	GV104.0810.045.27.40.R
4.00	1.00	1.70	0.20	3.70	1.00	32.00	50.00	4.00	4.013	GV104.0810.045.32.40.R

Article no. **25143** a L

Article no. **25147** ○ L

On the left-hand design, the designation changes to .L



Cutting inserts for internal pre-grooving and chamfering

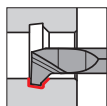

45° chamfer
for tool holders type GB106/GH106



VHM GV106

a Cutting data page 1544

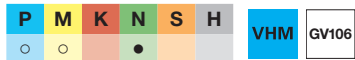

VHM GV106

○ Cutting data page 1544

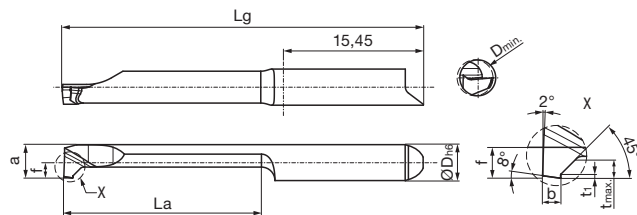

Right-hand design as shown. Left-hand design is mirror image.

Article no. **26902** **a** **R**

Article no. **26904** ○ **R**

Dmin. mm	b mm	f mm	t1 mm	a mm	tmax. mm	La mm	Lg mm	D h6 mm	Code no.	Description
5.00	1.00	2.95	0.20	4.70	1.00	12.00	37.00	6.00	6.001	GV106.0810.045.12.50.R
5.00	1.00	2.95	0.20	4.70	1.00	17.00	42.00	6.00	6.002	GV106.0810.045.17.50.R
5.00	1.00	2.95	0.20	4.70	1.00	22.00	47.00	6.00	6.003	GV106.0810.045.22.50.R
5.00	1.00	2.95	0.20	4.70	1.00	27.00	52.00	6.00	6.004	GV106.0810.045.27.50.R
5.00	1.00	2.95	0.20	4.70	1.00	32.00	57.00	6.00	6.005	GV106.0810.045.32.50.R

Article no. **26903** **a** **L**

Article no. **26905** ○ **L**

On the left-hand design, the designation changes to .L



Indexable inserts for radial grooving external and internal

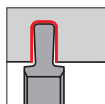

snap ring grooves to DIN471/472, NW = 0.5-5.15 mm
 indexable inserts applicable in right and left holders • geometry
 .BA ground • pay attention to assignment holder/insert seat size
 04/06 • for tool holders type GH305/GB305, size 04/06



P	M	K	N	S	H
●	○	○	○	○	○

VHM GE305

F Cutting data page 1544-1546



P	M	K	N	S	H
●	●	○	○	●	○

VHM GE305

E Cutting data page 1544-1546



P	M	K	N	S	H
○	○	○	●	○	○

VHM GE305

○ Cutting data page 1544-1546

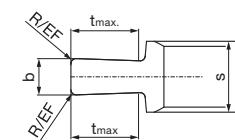
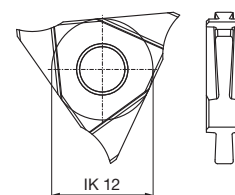

- Article no. **25601** **F** **N**
- Article no. **25602** **E** **N**
- Article no. **25603** ○ **N**

NW mm	b ±0,02 mm	R mm	EF mm	tmax. mm	s mm	Size	Code no.	Description
0.50	0.55			1.50	4.20	04	12.001	GE305.0050.000.BA.04.N
0.60	0.65			1.50	4.20	04	12.002	GE305.0060.000.BA.04.N
0.70	0.75			1.50	4.20	04	12.003	GE305.0070.000.BA.04.N
0.80	0.85			1.50	4.20	04	12.004	GE305.0080.000.BA.04.N
0.90	0.95			1.50	4.20	04	12.005	GE305.0090.000.BA.04.N
1.00	1.05		0.05	3.00	4.20	04	12.006	GE305.0100.000.BA.04.N
1.10	1.22		0.05	3.00	4.20	04	12.007	GE305.0110.000.BA.04.N
1.30	1.42		0.05	3.00	4.20	04	12.008	GE305.0130.000.BA.04.N
1.60	1.72		0.05	4.00	4.20	04	12.009	GE305.0160.000.BA.04.N
1.85	1.97	0.15		4.00	4.20	04	12.010	GE305.0185.015.BA.04.N
2.15	2.27	0.15		5.00	4.20	04	12.011	GE305.0215.015.BA.04.N
2.65	2.77	0.15		5.00	4.20	04	12.012	GE305.0265.015.BA.04.N
3.15	3.27	0.15		5.00	4.20	04	12.013	GE305.0315.015.BA.04.N
4.15	4.27	0.15		5.00	6.20	06	12.014	GE305.0415.015.BA.06.N
5.15	5.27	0.15		5.00	6.20	06	12.015	GE305.0515.015.BA.06.N



Indexable inserts for radial grooving

Indexable inserts for radial grooving and external and internal copying

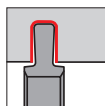

grooving depth up to 5 mm
indexable inserts applicable in right and left holders • geometry
.BA ground • for tool holders type GH305/GB305, size 04



VHM GE305

F Cutting data page 1546-1547



VHM GE305

E Cutting data page 1546-1547



VHM GE305

○ Cutting data page 1546-1547

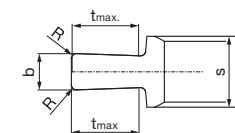
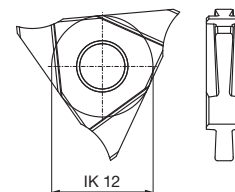

- Article no. **25605** **F**
- Article no. **25606** **E**
- Article no. **25607** ○

b ±0,02 mm	R mm	tmax. mm	s mm	Size	Code no.	Description
1.00	0.10	3.00	4.20	04	12.001	GE305.0100.010.BA.04.N
1.50	0.20	3.00	4.20	04	12.002	GE305.0150.020.BA.04.N
2.00	0.15	4.00	4.20	04	12.009	GE305.0200.015.BA.04.N
2.00	0.20	4.00	4.20	04	12.003	GE305.0200.020.BA.04.N
2.50	0.20	5.00	4.20	04	12.010	GE305.0250.020.BA.04.N
2.50	0.30	5.00	4.20	04	12.004	GE305.0250.030.BA.04.N
3.00	0.15	5.00	4.20	04	12.011	GE305.0300.015.BA.04.N
3.00	0.20	5.00	4.20	04	12.012	GE305.0300.020.BA.04.N
3.00	0.30	5.00	4.20	04	12.005	GE305.0300.030.BA.04.N
3.50	0.30	5.00	4.20	04	12.006	GE305.0350.030.BA.04.N
4.00	0.20	5.00	4.20	04	12.007	GE305.0400.020.BA.04.N
4.00	0.40	5.00	4.20	04	12.008	GE305.0400.040.BA.04.N



Indexable inserts for radial grooving and external and internal copying

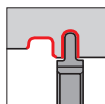

grooving depth up to 5 mm
indexable inserts applicable in right and left holders • geometry
.AA ground • for tool holders type GH305/GB305, size 04



P	M	K	N	S	H
•	○	○	○	○	○

VHM GE305

F Cutting data page 1548-1549



P	M	K	N	S	H
•	•	○	○	•	○

VHM GE305

E Cutting data page 1548-1549



P	M	K	N	S	H
○	•	○	•	•	○

VHM GE305

○ Cutting data page 1548-1549

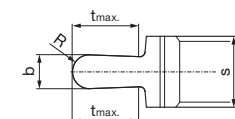
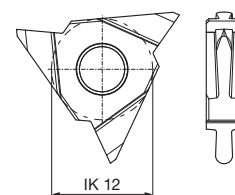

- Article no. **25613** **F** **N**
- Article no. **25614** **E** **N**
- Article no. **25615** ○ **N**

b ±0,02 mm	R mm	tmax. mm	s mm	Size	Code no.	Description
0.50	0.25	1.50	4.20	04	12.001	GE305.0050.025.AA.04.N
1.00	0.50	3.00	4.20	04	12.002	GE305.0100.050.AA.04.N
1.10	0.55	3.00	4.20	04	12.003	GE305.0110.055.AA.04.N
1.20	0.60	3.00	4.20	04	12.004	GE305.0120.060.AA.04.N
1.40	0.70	3.00	4.20	04	12.005	GE305.0140.070.AA.04.N
1.50	0.75	3.00	4.20	04	12.006	GE305.0150.075.AA.04.N
1.60	0.80	4.00	4.20	04	12.007	GE305.0160.080.AA.04.N
1.80	0.90	4.00	4.20	04	12.008	GE305.0180.090.AA.04.N
2.00	1.00	4.00	4.20	04	12.009	GE305.0200.100.AA.04.N
2.20	1.10	5.00	4.20	04	12.010	GE305.0220.110.AA.04.N
2.50	1.25	5.00	4.20	04	12.011	GE305.0250.125.AA.04.N
2.80	1.40	5.00	4.20	04	12.012	GE305.0280.140.AA.04.N
3.00	1.50	5.00	4.20	04	12.013	GE305.0300.150.AA.04.N
3.60	1.80	5.00	4.20	04	12.014	GE305.0360.180.AA.04.N
4.00	2.00	5.00	4.20	04	12.015	GE305.0400.200.AA.04.N



Cutting inserts for axial grooving, flat bottom slots

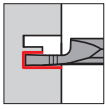

grooving depth up to 5 mm
for tool holders type GB104/GH104



a Cutting data page 1550



○ Cutting data page 1550

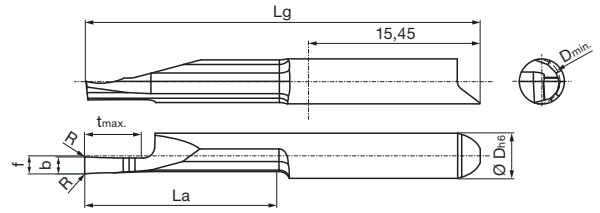

Right-hand design as shown. Left-hand design is mirror image.

Article no. **25190** **a**

Article no. **25194** ○

Dmin. mm	b mm	R mm	f mm	tmax. mm	La mm	Lg mm	D h6 mm	Code no.	Description
4.00	1.00	0.05	1.60	2.00	12.00	30.00	4.00	4.001	GA104.0100.005.12.40.R
4.00	1.00	0.05	1.60	2.00	17.00	35.00	4.00	4.002	GA104.0100.005.17.40.R
4.00	1.50	0.05	1.60	3.00	12.00	30.00	4.00	4.003	GA104.0150.005.12.40.R
4.00	1.50	0.05	1.60	3.00	17.00	35.00	4.00	4.004	GA104.0150.005.17.40.R
5.00	2.00	0.05	1.60	5.00	12.00	30.00	4.00	4.005	GA104.0200.005.12.50.R
5.00	2.00	0.05	1.60	5.00	17.00	35.00	4.00	4.006	GA104.0200.005.17.50.R

Article no. **25191** **a**

On the left-hand design, the designation changes to .L

Article no. **25195** ○

Cutting inserts for axial grooving, flat bottom slots

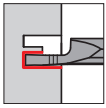

grooving depth up to 8 mm
for tool holders type GB106/GH106



a Cutting data page 1550



○ Cutting data page 1550

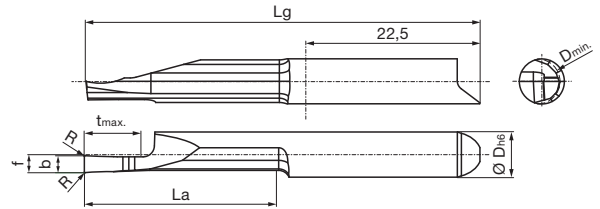

Right-hand design as shown. Left-hand design is mirror image.

Article no. **25782** **a**

Article no. **25786** ○

Axial grooving

Dmin. mm	b mm	R mm	f mm	tmax. mm	La mm	Lg mm	D h6 mm	Code no.	Description
6.00	1.50	0.10	2.60	5.00	17.00	42.00	6.00	6.001	GA106.0150.010.17.60.R
6.00	1.50	0.10	2.60	5.00	22.00	47.00	6.00	6.002	GA106.0150.010.22.60.R
6.00	2.00	0.15	2.60	8.00	17.00	42.00	6.00	6.003	GA106.0200.015.17.60.R
6.00	2.00	0.15	2.60	8.00	22.00	47.00	6.00	6.004	GA106.0200.015.22.60.R

Article no. **25783** **a**

On the left-hand design, the designation changes to .L

Article no. **25787** ○



Cutting inserts for axial grooving, flat bottom slots

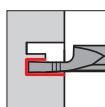

grooving depth up to 8 mm
for tool holders type GB108/GH108



P	M	K	N	S	H	VHM	GA108	a
•	•	•	○	•	•			

Cutting data page 1550



P	M	K	N	S	H	VHM	GA108	○
○	○	•	•	•	•			

Cutting data page 1550

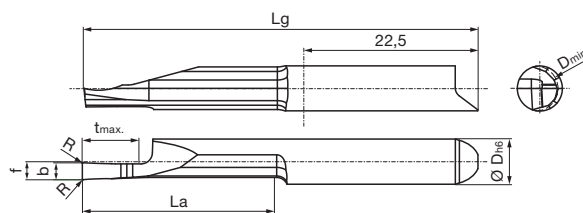

Right-hand design as shown. Left-hand design is mirror image.

Article no. **27232** **a** **R**

Article no. **27234** ○ **R**

Dmin. mm	b mm	R mm	f mm	tmax. mm	La mm	Lg mm	D h6 mm	Code no.	Description
8.00	2.50	0.15	3.60	5.00	17.00	42.00	8.00	8.001	GA108.0250.015.17.80.R
8.00	2.50	0.15	3.60	5.00	22.00	47.00	8.00	8.002	GA108.0250.015.22.80.R
8.00	3.00	0.15	3.60	8.00	17.00	42.00	8.00	8.003	GA108.0300.015.17.80.R
8.00	3.00	0.15	3.60	8.00	22.00	47.00	8.00	8.004	GA108.0300.015.22.80.R

Article no. **27233** **a** **L**

Article no. **27235** ○ **L**

On the left-hand design, the designation changes to .L



Cutting inserts for axial grooving bores, full radius slots

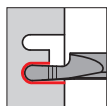

grooving depth up to 5 mm
for tool holders type GB104/GH104



● Cutting data page 1550

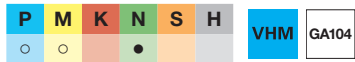

○ Cutting data page 1550

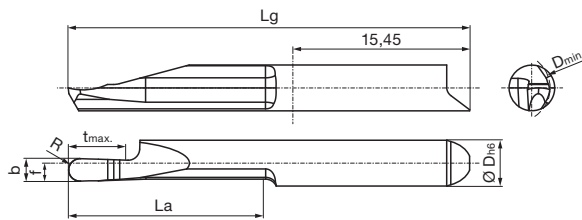

Article no. **25198**

Article no. **25202**

Right-hand design as shown. Left-hand design is mirror image.

Dmin. mm	b mm	R mm	f mm	tmax. mm	La mm	Lg mm	D h6 mm	Code no.	Description
6.00	1.00	0.50	1.60	2.00	12.00	30.00	4.00	4.001	GA104.0100.050.12.60.R
6.00	1.00	0.50	1.60	2.00	17.00	35.00	4.00	4.002	GA104.0100.050.17.60.R
6.00	1.50	0.75	1.60	3.00	12.00	30.00	4.00	4.003	GA104.0150.075.12.60.R
6.00	1.50	0.75	1.60	3.00	17.00	35.00	4.00	4.004	GA104.0150.075.17.60.R
6.00	2.00	1.00	1.60	5.00	12.00	30.00	4.00	4.005	GA104.0200.100.12.60.R
6.00	2.00	1.00	1.60	5.00	17.00	35.00	4.00	4.006	GA104.0200.100.17.60.R

Article no. **25199**

Article no. **25203**

On the left-hand design, the designation changes to .L

Cutting inserts for axial grooving bores, full radius slots

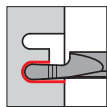

grooving depth up to 8 mm
for tool holders type GB106/GH106



● Cutting data page 1550

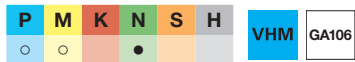

○ Cutting data page 1550

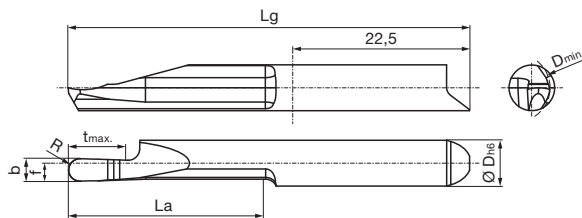

Article no. **25790**

Article no. **25794**

Right-hand design as shown. Left-hand design is mirror image.

Dmin. mm	b mm	R mm	f mm	tmax. mm	La mm	Lg mm	D h6 mm	Code no.	Description
6.00	1.50	0.75	2.60	5.00	17.00	42.00	6.00	6.001	GA106.0150.075.17.60.R
6.00	1.50	0.75	2.60	5.00	22.00	47.00	6.00	6.002	GA106.0150.075.22.60.R
6.00	2.00	1.00	2.60	8.00	17.00	42.00	6.00	6.003	GA106.0200.100.17.60.R
6.00	2.00	1.00	2.60	8.00	22.00	47.00	6.00	6.004	GA106.0200.100.22.60.R

Article no. **25791**

Article no. **25795**

On the left-hand design, the designation changes to .L

Axial grooving



Cutting inserts for axial grooving bores, full radius slots

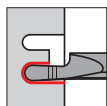

grooving depth up to 8 mm • full radius R1.25-R1.5 mm
for tool holders type GB108/GH108



P	M	K	N	S	H	VHM	GA108	a
•	•	•	○	•	•			

○ Cutting data page 1550



P	M	K	N	S	H	VHM	GA108	○
○	○	•	•	•	•			

○ Cutting data page 1550

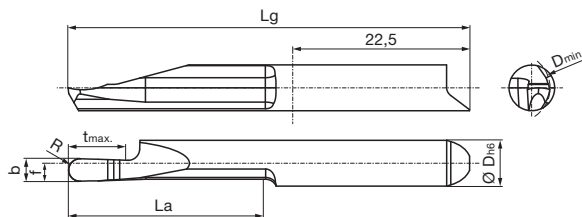

Right-hand design as shown. Left-hand design is mirror image.

Article no. **27236** **a** **R**

Article no. **27238** ○ **R**

Dmin. mm	b mm	R mm	f mm	tmax. mm	La mm	Lg mm	D h6 mm	Code no.	Description
8.00	2.50	1.25	3.60	5.00	17.00	42.00	8.00	8.001	GA108.0250.125.17.80.R
8.00	2.50	1.25	3.60	5.00	22.00	47.00	8.00	8.002	GA108.0250.125.22.80.R
8.00	3.00	1.50	3.60	8.00	17.00	42.00	8.00	8.003	GA108.0300.150.17.80.R
8.00	3.00	1.50	3.60	8.00	22.00	47.00	8.00	8.004	GA108.0300.150.22.80.R

Article no. **27237** **a** **L**

Article no. **27239** ○ **L**

On the left-hand design, the designation changes to .L



Cutting inserts for axial grooving studs, flat bottom slots

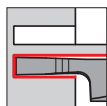

grooving depth up to 5 mm
for tool holders type GB104/GH104



Cutting data page 1550

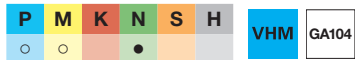

Cutting data page 1550

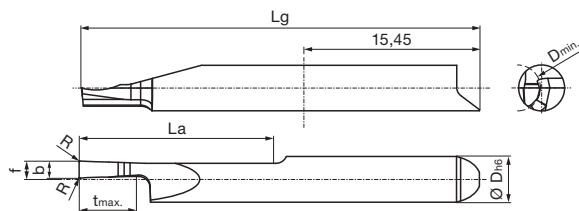

Right-hand design as shown. Left-hand design is mirror image.

Article no. **25206**

Article no. **25210**

Dmin. mm	b mm	R mm	f mm	tmax. mm	La mm	Lg mm	D h6 mm	Code no.	Description
4.00	1.00	0.05	1.60	2.00	12.00	30.00	4.00	4.001	GA104.Z100.005.12.40.R
4.00	1.00	0.05	1.60	2.00	17.00	35.00	4.00	4.002	GA104.Z100.005.17.40.R
4.00	1.50	0.05	1.60	3.00	12.00	30.00	4.00	4.003	GA104.Z150.005.12.40.R
4.00	1.50	0.05	1.60	3.00	17.00	35.00	4.00	4.004	GA104.Z150.005.17.40.R
5.00	2.00	0.05	1.60	5.00	12.00	30.00	4.00	4.005	GA104.Z200.005.12.50.R
5.00	2.00	0.05	1.60	5.00	17.00	35.00	4.00	4.006	GA104.Z200.005.17.50.R

Article no. **25207**

On the left-hand design, the designation changes to .L

Article no. **25211**

Cutting inserts for axial grooving studs, flat bottom slots

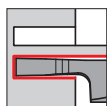

grooving depth up to 8 mm
for tool holders type GB106/GH106



Cutting data page 1550

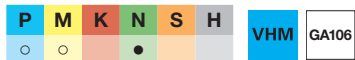

Cutting data page 1550

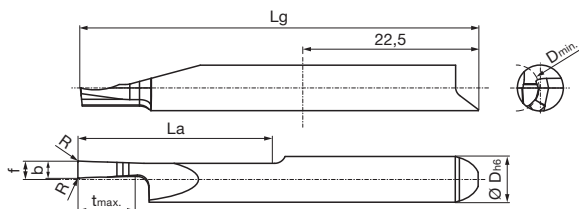

Right-hand design as shown. Left-hand design is mirror image.

Article no. **25798**

Article no. **25802**

Dmin. mm	b mm	R mm	f mm	tmax. mm	La mm	Lg mm	D h6 mm	Code no.	Description
6.00	1.50	0.10	2.60	5.00	17.00	42.00	6.00	6.001	GA106.Z150.010.17.60.R
6.00	1.50	0.10	2.60	5.00	22.00	47.00	6.00	6.002	GA106.Z150.010.22.60.R
6.00	2.00	0.15	2.60	8.00	17.00	42.00	6.00	6.003	GA106.Z200.015.17.60.R
6.00	2.00	0.15	2.60	8.00	22.00	47.00	6.00	6.004	GA106.Z200.015.22.60.R

Article no. **25799**

On the left-hand design, the designation changes to .L

Article no. **25803**



Cutting inserts for axial grooving studs, flat bottom slots

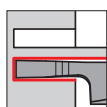

grooving depth up to 8 mm
for tool holders type GB108/GH108



P	M	K	N	S	H	VHM	GA108	a
•	•	•	○	•	•			

Cutting data page 1550



P	M	K	N	S	H	VHM	GA108	○
○	○	•	•	•	•			

○ Cutting data page 1550

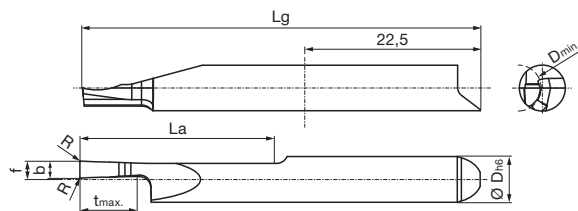

Right-hand design as shown. Left-hand design is mirror image.

Article no. **27240** **a** **R**

Article no. **27242** ○ **R**

Dmin. mm	b mm	R mm	f mm	tmax. mm	La mm	Lg mm	D h6 mm	Code no.	Description
8.00	2.50	0.15	3.60	5.00	17.00	42.00	8.00	8.001	GA108.Z250.015.17.80.R
8.00	2.50	0.15	3.60	5.00	22.00	47.00	8.00	8.002	GA108.Z250.015.22.80.R
8.00	3.00	0.15	3.60	8.00	17.00	42.00	8.00	8.003	GA108.Z300.015.17.80.R
8.00	3.00	0.15	3.60	8.00	22.00	47.00	8.00	8.004	GA108.Z300.015.22.80.R

Article no. **27241** **a** **L**

Article no. **27243** ○ **L**

On the left-hand design, the designation changes to .L



Cutting inserts for axial grooving studs, full radius slots

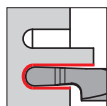

grooving depth up to 5 mm • full radius R0.5-R1.0 mm
for tool holders type GB104/GH104



Cutting data page 1550



Cutting data page 1550

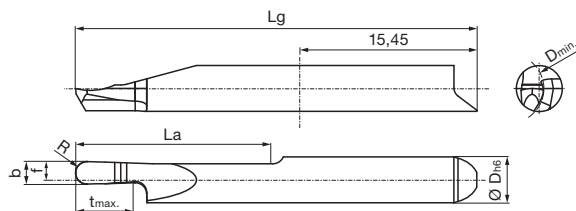

Article no. **25214**

Article no. **25218**

Right-hand design as shown. Left-hand design is mirror image.

Dmin. mm	b mm	R mm	f mm	tmax. mm	La mm	Lg mm	D h6 mm	Code no.	Description
6.00	1.00	0.50	1.60	2.00	12.00	30.00	4.00	4.001	GA104.Z100.050.12.60.R
6.00	1.00	0.50	1.60	2.00	17.00	35.00	4.00	4.002	GA104.Z100.050.17.60.R
6.00	1.50	0.75	1.60	3.00	12.00	30.00	4.00	4.003	GA104.Z150.075.12.60.R
6.00	1.50	0.75	1.60	3.00	17.00	35.00	4.00	4.004	GA104.Z150.075.17.60.R
6.00	2.00	1.00	1.60	5.00	12.00	30.00	4.00	4.005	GA104.Z200.100.12.60.R
6.00	2.00	1.00	1.60	5.00	17.00	35.00	4.00	4.006	GA104.Z200.100.17.60.R

Article no. **25215**

Article no. **25219**

On the left-hand design, the designation changes to .L

Cutting inserts for axial grooving studs, full radius slots

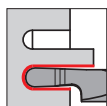

grooving depth up to 8 mm • full radius R0.75-R1.0 mm
for tool holders type GB106/GH106



Cutting data page 1550

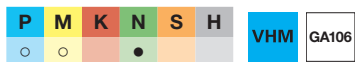

Cutting data page 1550

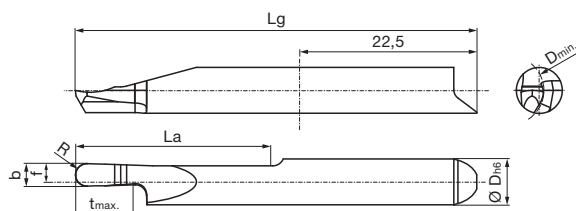

Article no. **25806**

Article no. **25810**

Right-hand design as shown. Left-hand design is mirror image.

Dmin. mm	b mm	R mm	f mm	tmax. mm	La mm	Lg mm	D h6 mm	Code no.	Description
6.00	1.50	0.75	2.60	5.00	17.00	42.00	6.00	6.001	GA106.Z150.075.17.60.R
6.00	1.50	0.75	2.60	5.00	22.00	47.00	6.00	6.002	GA106.Z150.075.22.60.R
6.00	2.00	1.00	2.60	8.00	17.00	42.00	6.00	6.003	GA106.Z200.100.17.60.R
6.00	2.00	1.00	2.60	8.00	22.00	47.00	6.00	6.004	GA106.Z200.100.22.60.R

Article no. **25807**

Article no. **25811**

On the left-hand design, the designation changes to .L

Axial grooving



Cutting inserts for axial grooving studs, full radius slots

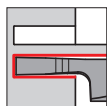

grooving depth up to 8 mm • full radius R1.25-R1.5 mm
for tool holders type GB108/GH108



P	M	K	N	S	H	VHM	GA108
•	•	•	○	•	•		

a Cutting data page 1550



P	M	K	N	S	H	VHM	GA108
○	○	•	•	•	•		

○ Cutting data page 1550

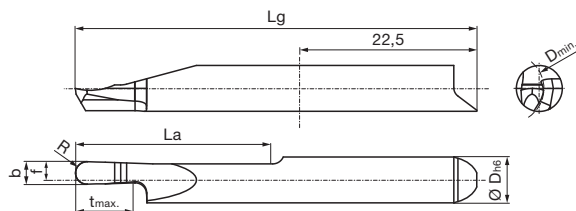

Right-hand design as shown. Left-hand design is mirror image.

Article no. **27244** **a** **R**

Article no. **27246** ○ **R**

Dmin. mm	b mm	R mm	f mm	tmax. mm	La mm	Lg mm	D h6 mm	Code no.	Description
8.00	2.50	1.25	3.60	5.00	17.00	42.00	8.00	8.001	GA108.Z250.125.17.80.R
8.00	2.50	1.25	3.60	5.00	22.00	47.00	8.00	8.002	GA108.Z250.125.22.80.R
8.00	3.00	1.50	3.60	8.00	17.00	42.00	8.00	8.003	GA108.Z300.150.17.80.R
8.00	3.00	1.50	3.60	8.00	22.00	47.00	8.00	8.004	GA108.Z300.150.22.80.R

Article no. **27245** **a** **L**

Article no. **27247** ○ **L**

On the left-hand design, the designation changes to .L



Cutting inserts for axial chamfering bores

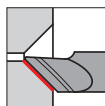

45°/60°/75° chamfer angle
for tool holders type GB104/GH104



Cutting data page 1550

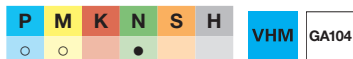

Cutting data page 1550

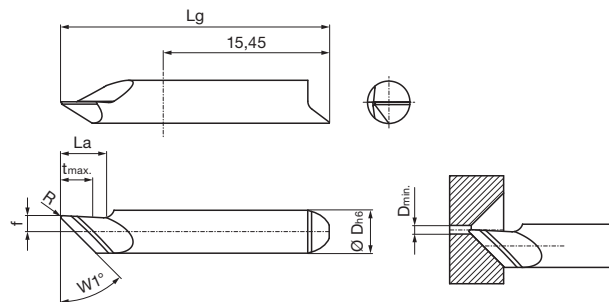

Article no. **25222** **a** **(R)**

Article no. **25226** ○ **(R)**

Right-hand design as shown. Left-hand design is mirror image.

Dmin. mm	R mm	W1 °	f mm	tmax. mm	La mm	Lg mm	D h6 mm	Code no.	Description
0.80	0.15	45.00	1.50	3.00	4.00	25.00	4.00	4.001	GA104.F045.015.04.08.R
0.80	0.15	60.00	0.50	3.50	4.00	25.00	4.00	4.002	GA104.F060.015.04.08.R
0.80	0.15	75.00	0.50	2.00	4.00	25.00	4.00	4.003	GA104.F075.015.04.08.R

Article no. **25223** **a** **(L)**

Article no. **25227** ○ **(L)**

On the left-hand design, the designation changes to .L



Indexable inserts for axial grooving, flat bottom slots

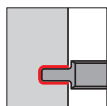

grooving depth up to 3 mm
 right index. inserts in right, left index. inserts in left tool holders
 • geometry .BA ground • for tool holders type GH305, size 04



P	M	K	N	S	H
○	○	○	○	○	○

VHM GA305

F Cutting data page 1550



P	M	K	N	S	H
○	●	○	○	●	○

VHM GA305

E Cutting data page 1550



P	M	K	N	S	H
○	○	○	●	○	○

VHM GA305

○ Cutting data page 1550

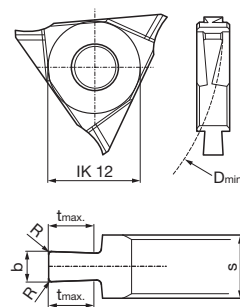

- Article no. **25626** **F** **R**
- Article no. **25628** **E** **R**
- Article no. **25630** ○ **R**

Right-hand design as shown. Left-hand design is mirror image.

Dmin. mm	b ±0,02 mm	R mm	tmax. mm	s mm	Size	Code no.	Description
15.00	1.50	0.20	2.00	4.20	04	12.001	GA305.0150.020.BA.04.R
30.00	2.00	0.20	3.00	4.20	04	12.002	GA305.0200.020.BA.04.R
30.00	2.50	0.20	3.00	4.20	04	12.003	GA305.0250.020.BA.04.R
30.00	3.00	0.20	3.00	4.20	04	12.004	GA305.0300.020.BA.04.R

- Article no. **25627** **F** **L**
- Article no. **25629** **E** **L**
- Article no. **25631** ○ **L**

On the left-hand design, the designation changes to .L



Indexable inserts for axial grooving, full radius slots

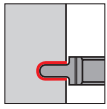

grooving depth up to 3 mm

right index. inserts in right, left index. inserts in left tool holders

• geometry .AA ground • for tool holders type GH305, size 04



VHM

GA305



Cutting data page 1550



VHM

GA305



Cutting data page 1550



VHM

GA305



Cutting data page 1550

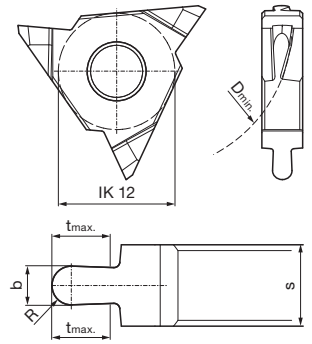

- Article no. **25634**
- Article no. **25636**
- Article no. **25638**

Right-hand design as shown. Left-hand design is mirror image.

Dmin. mm	b ±0,02 mm	R mm	tmax. mm	s mm	Size	Code no.	Description
15.00	1.50	0.75	2.00	4.20	04	12.001	GA305.0150.075.AA.04.R
30.00	2.00	1.00	3.00	4.20	04	12.002	GA305.0200.100.AA.04.R
30.00	3.00	1.50	3.00	4.20	04	12.003	GA305.0300.150.AA.04.R
30.00	4.00	2.00	3.00	4.20	04	12.004	GA305.0400.200.AA.04.R

- Article no. **25635**
- Article no. **25637**
- Article no. **25639**

On the left-hand design, the designation changes to .L



Indexable inserts for grooving axial external recesses

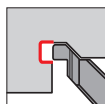

grooving depth up to 2 mm
 right index. inserts in right, left index. inserts in left tool holders
 • geometry .AA ground • for axial external recesses according to ISO 9974-2 • for tool holders type GH305, 45° offset



P	M	K	N	S	H
•	○	○	○	○	○

VHM GA305

F Cutting data page 1550



P	M	K	N	S	H
•	•	○	○	•	○

VHM GA305

E Cutting data page 1550



P	M	K	N	S	H
○	○	•	•	○	○

VHM GA305

○ Cutting data page 1550

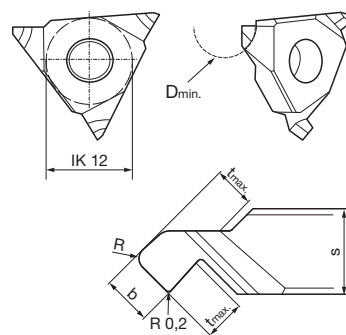

Right-hand design as shown. Left-hand design is mirror image.

Dmin. mm	b ±0,02 mm	R mm	tmax. mm	s mm	Size	Code no.	Description
8.00	1.50	0.40	1.60	4.20	04	12.001	GA305.0150.040.AA.04.R
12.00	2.00	0.50	1.90	4.20	04	12.002	GA305.0200.050.AA.04.R
20.00	2.40	0.60	2.00	4.20	04	12.003	GA305.0240.060.AA.04.R

- Article no. **25618** **F** **R**
- Article no. **25620** **E** **R**
- Article no. **25622** ○ **R**

- Article no. **25619** **F** **L**
- Article no. **25621** **E** **L**
- Article no. **25623** ○ **L**

On the left-hand design, the designation changes to .L



Indexable inserts for parting off

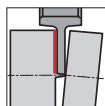

grooving depth up to 5 mm
 indexable inserts applicable in right and left holders • geometry
 .AA ground • for tool holders type GH305, size 04

**VHM**

GZ305

F Cutting data page 1552**VHM**

GZ305

E Cutting data page 1552**VHM**

GZ305

○ Cutting data page 1552

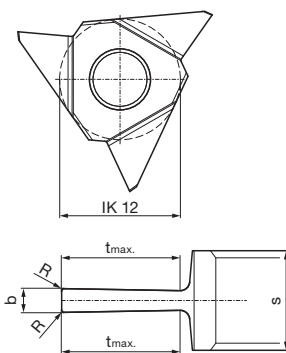

- Article no. **25641** **F**
- Article no. **25642** **E**
- Article no. **25643** ○

b ±0,02 mm	R mm	tmax. mm	s mm	Size	Code no.	Description
1.00	0.10	5.00	4.20	04	12.001	GZ305.0100.000.AA.04.N
1.50	0.10	5.00	4.20	04	12.002	GZ305.0150.000.AA.04.N



Indexable inserts for parting off

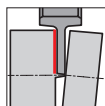

grooving depth up to 5 mm
 indexable inserts applicable in right and left holders • geometry
 .AA ground • for tool holders type GH305, size 04



VHM

GZ305



Cutting data page 1552



VHM

GZ305



Cutting data page 1552



VHM

GZ305



Cutting data page 1552

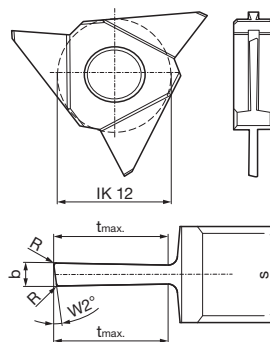

Right-hand design as shown. Left-hand design is mirror image.

b ±0,02 mm	R mm	W2 °	tmax. mm	s mm	Size	Code no.	Description
1.00	0.10	8.00	5.00	4.20	04	12.001	GZ305.0100.080.AA.04.R
1.50	0.10	8.00	5.00	4.20	04	12.002	GZ305.0150.080.AA.04.R

Article no. **25646**

Article no. **25648**

Article no. **25650**

Article no. **25647**

Article no. **25649**

Article no. **25651**

On the left-hand design, the designation changes to .L



Indexable inserts for parting off

Indexable inserts for parting off

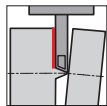

with chip former • geometry .PP sintered • for tool holders type GH222/GS222

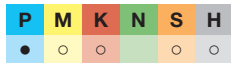

VHM GZ222

F Cutting data page 1552

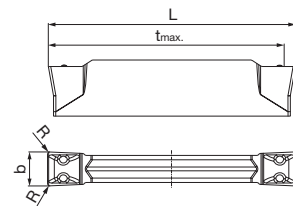

Article no. **26601**



b mm	L mm	R mm	tmax. mm	Code no.	Description
2.00	22.00	0.20	21.00	22.020	GZ222.0200.020.PP.02.N
3.00	22.00	0.20	21.00	22.030	GZ222.0300.020.PP.02.N

Indexable inserts for parting off

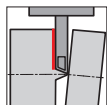

with chip former • geometry .PM sintered • for tool holders type GH222/GS222



VHM GZ222

F Cutting data page 1552

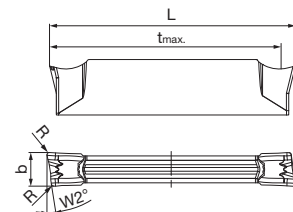

Right-hand design as shown. Left-hand design is mirror image.

Article no. **26602**



b mm	L mm	R mm	W2 °	tmax. mm	Code no.	Description
3.00	22.350	0.20	8	21.00	22.030	GZ222.0300.020.PM.01.R.08

On the left-hand design, the designation changes to .L

Article no. **26603**





Indexable inserts for parting off

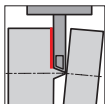

with chip former • geometry .PP sintered • for tool holders type GH222/GS222



VHM GZ122

F Cutting data page 1552

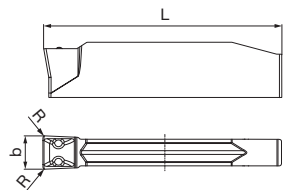

Article no. **26604**



b mm	L mm	R mm	Code no.	Description
3.00	21.540	0.20	22.030	GZ122.0300.020.PP.02.N

Indexable inserts for parting off

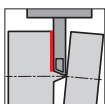

with chip former • geometry .MP sintered • for tool holders type GH222/GS222

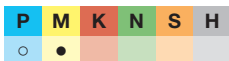

VHM GZ222

a Cutting data page 1552

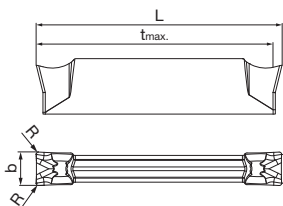

Article no. **26605**



b mm	L mm	R mm	tmax. mm	Code no.	Description
3.00	22.00	0.20	21.00	22.030	GZ222.0300.020.MP.02.N



Cutting inserts for boring out and profiling

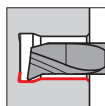

radial free 23°

for tool holders type GB104/GH104

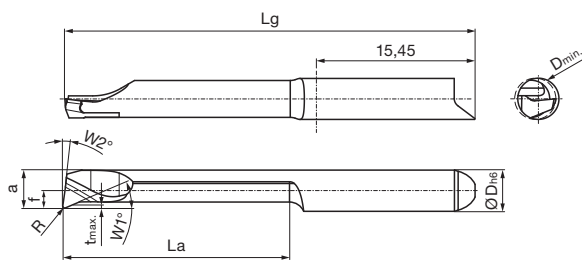
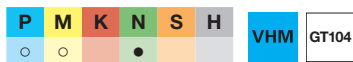

Article no. **25052** **a** **(R)**

Article no. **25056** **○** **(R)**

Right-hand design as shown. Left-hand design is mirror image.

Dmin. mm	R mm	W1 °	W2 °	f mm	a mm	tmax. mm	La mm	Lg mm	D h6 mm	Code no.	Description
0.70	0.05	23	8	1.95	0.60	0.05	3.00	25.00	4.00	4.001	GT104.2306.005.03.07.R
1.00	0.05	23	8	1.95	0.90	0.10	4.00	25.00	4.00	4.002	GT104.2309.005.04.10.R
1.00	0.05	23	8	1.95	0.90	0.10	7.00	25.00	4.00	4.003	GT104.2309.005.07.10.R
1.50	0.05	23	8	1.95	1.40	0.15	4.00	25.00	4.00	4.004	GT104.2314.005.04.15.R
1.50	0.05	23	8	1.95	1.40	0.15	7.00	25.00	4.00	4.005	GT104.2314.005.07.15.R
1.50	0.05	23	8	1.95	1.40	0.15	12.00	30.00	4.00	4.006	GT104.2314.005.12.15.R
1.50	0.10	23	8	1.95	1.40	0.15	4.00	25.00	4.00	4.007	GT104.2314.010.04.15.R
1.50	0.10	23	8	1.95	1.40	0.15	7.00	25.00	4.00	4.008	GT104.2314.010.07.15.R
1.50	0.10	23	8	1.95	1.40	0.15	12.00	30.00	4.00	4.009	GT104.2314.010.12.15.R
2.00	0.05	23	8	1.95	1.90	0.15	4.00	25.00	4.00	4.010	GT104.2319.005.04.20.R
2.00	0.05	23	8	1.95	1.90	0.15	7.00	25.00	4.00	4.011	GT104.2319.005.07.20.R
2.00	0.05	23	8	1.95	1.90	0.15	12.00	30.00	4.00	4.012	GT104.2319.005.12.20.R
2.00	0.05	23	8	1.95	1.90	0.15	17.00	35.00	4.00	4.013	GT104.2319.005.17.20.R
2.00	0.10	23	8	1.95	1.90	0.15	4.00	25.00	4.00	4.014	GT104.2319.010.04.20.R
2.00	0.10	23	8	1.95	1.90	0.15	7.00	25.00	4.00	4.015	GT104.2319.010.07.20.R
2.00	0.10	23	8	1.95	1.90	0.15	12.00	30.00	4.00	4.016	GT104.2319.010.12.20.R
2.00	0.10	23	8	1.95	1.90	0.15	17.00	35.00	4.00	4.017	GT104.2319.010.17.20.R
2.00	0.15	23	8	1.95	1.90	0.15	4.00	25.00	4.00	4.018	GT104.2319.015.04.20.R
2.00	0.15	23	8	1.95	1.90	0.15	7.00	25.00	4.00	4.019	GT104.2319.015.07.20.R
2.00	0.15	23	8	1.95	1.90	0.15	12.00	30.00	4.00	4.020	GT104.2319.015.12.20.R
2.00	0.15	23	8	1.95	1.90	0.15	17.00	35.00	4.00	4.021	GT104.2319.015.17.20.R
3.00	0.05	23	8	1.95	2.60	0.20	7.00	25.00	4.00	4.022	GT104.2326.005.07.30.R
3.00	0.05	23	8	1.95	2.60	0.20	12.00	30.00	4.00	4.023	GT104.2326.005.12.30.R
3.00	0.05	23	8	1.95	2.60	0.20	17.00	35.00	4.00	4.024	GT104.2326.005.17.30.R
3.00	0.05	23	8	1.95	2.60	0.20	22.00	40.00	4.00	4.025	GT104.2326.005.22.30.R
3.00	0.10	23	8	1.95	2.60	0.20	7.00	25.00	4.00	4.026	GT104.2326.010.07.30.R
3.00	0.10	23	8	1.95	2.60	0.20	12.00	30.00	4.00	4.027	GT104.2326.010.12.30.R
3.00	0.10	23	8	1.95	2.60	0.20	17.00	35.00	4.00	4.028	GT104.2326.010.17.30.R
3.00	0.10	23	8	1.95	2.60	0.20	22.00	40.00	4.00	4.029	GT104.2326.010.22.30.R
3.00	0.20	23	8	1.95	2.60	0.20	7.00	25.00	4.00	4.030	GT104.2326.020.07.30.R
3.00	0.20	23	8	1.95	2.60	0.20	12.00	30.00	4.00	4.031	GT104.2326.020.12.30.R
3.00	0.20	23	8	1.95	2.60	0.20	17.00	35.00	4.00	4.032	GT104.2326.020.17.30.R
3.00	0.20	23	8	1.95	2.60	0.20	22.00	40.00	4.00	4.033	GT104.2326.020.22.30.R
4.00	0.05	23	8	1.70	3.70	0.30	12.00	30.00	4.00	4.034	GT104.2337.005.12.40.R
4.00	0.05	23	8	1.70	3.70	0.30	17.00	35.00	4.00	4.035	GT104.2337.005.17.40.R
4.00	0.05	23	8	1.70	3.70	0.30	22.00	40.00	4.00	4.036	GT104.2337.005.22.40.R
4.00	0.05	23	8	1.70	3.70	0.30	27.00	45.00	4.00	4.037	GT104.2337.005.27.40.R
4.00	0.05	23	8	1.70	3.70	0.30	32.00	50.00	4.00	4.038	GT104.2337.005.32.40.R
4.00	0.15	23	8	1.70	3.70	0.30	12.00	30.00	4.00	4.039	GT104.2337.015.12.40.R
4.00	0.15	23	8	1.70	3.70	0.30	17.00	35.00	4.00	4.040	GT104.2337.015.17.40.R
4.00	0.15	23	8	1.70	3.70	0.30	22.00	40.00	4.00	4.041	GT104.2337.015.22.40.R
4.00	0.15	23	8	1.70	3.70	0.30	27.00	45.00	4.00	4.042	GT104.2337.015.27.40.R
4.00	0.15	23	8	1.70	3.70	0.30	32.00	50.00	4.00	4.043	GT104.2337.015.32.40.R
4.00	0.25	23	8	1.70	3.70	0.30	12.00	30.00	4.00	4.044	GT104.2337.025.12.40.R
4.00	0.25	23	8	1.70	3.70	0.30	17.00	35.00	4.00	4.045	GT104.2337.025.17.40.R
4.00	0.25	23	8	1.70	3.70	0.30	22.00	40.00	4.00	4.046	GT104.2337.025.22.40.R
4.00	0.25	23	8	1.70	3.70	0.30	27.00	45.00	4.00	4.047	GT104.2337.025.27.40.R
4.00	0.25	23	8	1.70	3.70	0.30	32.00	50.00	4.00	4.048	GT104.2337.025.32.40.R
4.00	0.10	23	8	1.70	3.70	0.30	12.00	30.00	4.00	4.049	GT104.2337.010.12.40.R
4.00	0.10	23	8	1.70	3.70	0.30	17.00	35.00	4.00	4.050	GT104.2337.010.17.40.R
4.00	0.10	23	8	1.70	3.70	0.30	22.00	40.00	4.00	4.051	GT104.2337.010.22.40.R
4.00	0.20	23	8	1.70	3.70	0.30	12.00	30.00	4.00	4.052	GT104.2337.020.12.40.R
4.00	0.20	23	8	1.70	3.70	0.30	17.00	35.00	4.00	4.053	GT104.2337.020.17.40.R
4.00	0.20	23	8	1.70	3.70	0.30	22.00	40.00	4.00	4.054	GT104.2337.020.22.40.R

Article no. **25053** **a** **(L)**

Article no. **25057** **○** **(L)**

On the left-hand design, the designation changes to .L



Cutting inserts for boring out and profiling

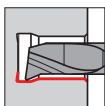

radial free 23°
for tool holders type GB106/GH106



P
M
K
N
S
H
VHM
GT106
a

Cutting data page 1554



P
M
K
N
S
H
VHM
GT106
a

Cutting data page 1554

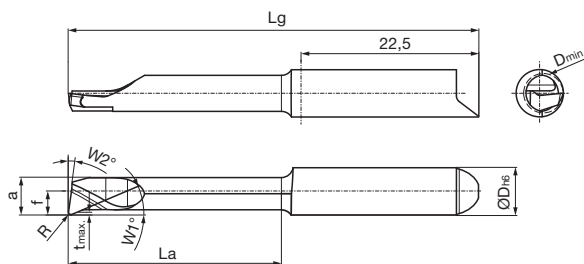

Right-hand design as shown. Left-hand design is mirror image.

Article no. **25834**



Article no. **25838**



Dmin. mm	R mm	W1 °	W2 °	f mm	a mm	tmax. mm	La mm	Lg mm	D h6 mm	Code no.	Description
5.00	0.05	23	8	2.95	4.70	0.30	12.00	37.00	6.00	6.010	GT106.2347.005.12.50.R
5.00	0.05	23	8	2.95	4.70	0.30	17.00	42.00	6.00	6.020	GT106.2347.005.17.50.R
5.00	0.05	23	8	2.95	4.70	0.30	22.00	47.00	6.00	6.030	GT106.2347.005.22.50.R
5.00	0.05	23	8	2.95	4.70	0.30	27.00	52.00	6.00	6.040	GT106.2347.005.27.50.R
5.00	0.05	23	8	2.95	4.70	0.30	32.00	57.00	6.00	6.050	GT106.2347.005.32.50.R
5.00	0.05	23	8	2.95	4.70	0.30	37.00	62.00	6.00	6.060	GT106.2347.005.37.50.R
5.00	0.05	23	8	2.95	4.70	0.30	42.00	67.00	6.00	6.070	GT106.2347.005.42.50.R
5.00	0.10	23	8	2.95	4.70	0.30	12.00	37.00	6.00	6.110	GT106.2347.010.12.50.R
5.00	0.10	23	8	2.95	4.70	0.30	17.00	42.00	6.00	6.120	GT106.2347.010.17.50.R
5.00	0.10	23	8	2.95	4.70	0.30	22.00	47.00	6.00	6.130	GT106.2347.010.22.50.R
5.00	0.10	23	8	2.95	4.70	0.30	27.00	52.00	6.00	6.140	GT106.2347.010.27.50.R
5.00	0.10	23	8	2.95	4.70	0.30	32.00	57.00	6.00	6.150	GT106.2347.010.32.50.R
5.00	0.10	23	8	2.95	4.70	0.30	37.00	62.00	6.00	6.160	GT106.2347.010.37.50.R
5.00	0.10	23	8	2.95	4.70	0.30	42.00	67.00	6.00	6.170	GT106.2347.010.42.50.R
5.00	0.15	23	8	2.95	4.70	0.30	12.00	37.00	6.00	6.210	GT106.2347.015.12.50.R
5.00	0.15	23	8	2.95	4.70	0.30	17.00	42.00	6.00	6.220	GT106.2347.015.17.50.R
5.00	0.15	23	8	2.95	4.70	0.30	22.00	47.00	6.00	6.230	GT106.2347.015.22.50.R
5.00	0.15	23	8	2.95	4.70	0.30	27.00	52.00	6.00	6.240	GT106.2347.015.27.50.R
5.00	0.15	23	8	2.95	4.70	0.30	32.00	57.00	6.00	6.250	GT106.2347.015.32.50.R
5.00	0.15	23	8	2.95	4.70	0.30	37.00	62.00	6.00	6.260	GT106.2347.015.37.50.R
5.00	0.15	23	8	2.95	4.70	0.30	42.00	67.00	6.00	6.270	GT106.2347.015.42.50.R
5.00	0.20	23	8	2.95	4.70	0.30	12.00	37.00	6.00	6.310	GT106.2347.020.12.50.R
5.00	0.20	23	8	2.95	4.70	0.30	17.00	42.00	6.00	6.320	GT106.2347.020.17.50.R
5.00	0.20	23	8	2.95	4.70	0.30	22.00	47.00	6.00	6.330	GT106.2347.020.22.50.R
5.00	0.20	23	8	2.95	4.70	0.30	27.00	52.00	6.00	6.340	GT106.2347.020.27.50.R
5.00	0.20	23	8	2.95	4.70	0.30	32.00	57.00	6.00	6.350	GT106.2347.020.32.50.R
5.00	0.20	23	8	2.95	4.70	0.30	37.00	62.00	6.00	6.360	GT106.2347.020.37.50.R
5.00	0.20	23	8	2.95	4.70	0.30	42.00	67.00	6.00	6.370	GT106.2347.020.42.50.R
5.00	0.30	23	8	2.95	4.70	0.30	12.00	37.00	6.00	6.410	GT106.2347.030.12.50.R
5.00	0.30	23	8	2.95	4.70	0.30	17.00	42.00	6.00	6.420	GT106.2347.030.17.50.R
5.00	0.30	23	8	2.95	4.70	0.30	22.00	47.00	6.00	6.430	GT106.2347.030.22.50.R
5.00	0.30	23	8	2.95	4.70	0.30	27.00	52.00	6.00	6.440	GT106.2347.030.27.50.R
5.00	0.30	23	8	2.95	4.70	0.30	32.00	57.00	6.00	6.450	GT106.2347.030.32.50.R
5.00	0.30	23	8	2.95	4.70	0.30	37.00	62.00	6.00	6.460	GT106.2347.030.37.50.R
5.00	0.30	23	8	2.95	4.70	0.30	42.00	67.00	6.00	6.470	GT106.2347.030.42.50.R

Article no. **25835**



Article no. **25839**



On the left-hand design, the designation changes to .L

Boring out



Cutting inserts for boring out and profiling

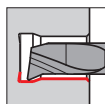

radial free 23°
for tool holders type GB106/GH106



a Cutting data page 1554

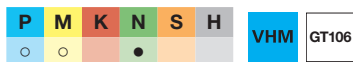

○ Cutting data page 1554

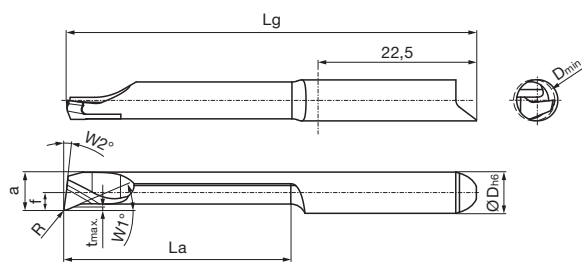

Right-hand design as shown. Left-hand design is mirror image.

Article no. **25702** **a**

Article no. **25706** ○

Dmin. mm	R mm	W1 °	W2 °	f mm	a mm	tmax. mm	La mm	Lg mm	D h6 mm	Code no.	Description
6.00	0.05	23	8	2.70	5.70	0.30	12.00	37.00	6.00	6.019	GT106.2357.005.12.60.R
6.00	0.05	23	8	2.70	5.70	0.30	17.00	42.00	6.00	6.020	GT106.2357.005.17.60.R
6.00	0.05	23	8	2.70	5.70	0.30	22.00	47.00	6.00	6.021	GT106.2357.005.22.60.R
6.00	0.05	23	8	2.70	5.70	0.30	27.00	52.00	6.00	6.022	GT106.2357.005.27.60.R
6.00	0.05	23	8	2.70	5.70	0.30	32.00	57.00	6.00	6.023	GT106.2357.005.32.60.R
6.00	0.05	23	8	2.70	5.70	0.30	37.00	62.00	6.00	6.024	GT106.2357.005.37.60.R
6.00	0.05	23	8	2.70	5.70	0.30	42.00	67.00	6.00	6.025	GT106.2357.005.42.60.R
6.00	0.05	23	8	2.70	5.70	0.30	47.00	72.00	6.00	6.026	GT106.2357.005.47.60.R
6.00	0.05	23	8	2.70	5.70	0.30	52.00	77.00	6.00	6.027	GT106.2357.005.52.60.R
6.00	0.10	23	8	2.70	5.70	0.30	12.00	37.00	6.00	6.028	GT106.2357.010.12.60.R
6.00	0.10	23	8	2.70	5.70	0.30	17.00	42.00	6.00	6.029	GT106.2357.010.17.60.R
6.00	0.10	23	8	2.70	5.70	0.30	22.00	47.00	6.00	6.030	GT106.2357.010.22.60.R
6.00	0.10	23	8	2.70	5.70	0.30	27.00	52.00	6.00	6.031	GT106.2357.010.27.60.R
6.00	0.10	23	8	2.70	5.70	0.30	32.00	57.00	6.00	6.032	GT106.2357.010.32.60.R
6.00	0.10	23	8	2.70	5.70	0.30	37.00	62.00	6.00	6.033	GT106.2357.010.37.60.R
6.00	0.10	23	8	2.70	5.70	0.30	42.00	67.00	6.00	6.034	GT106.2357.010.42.60.R
6.00	0.10	23	8	2.70	5.70	0.30	47.00	72.00	6.00	6.035	GT106.2357.010.47.60.R
6.00	0.10	23	8	2.70	5.70	0.30	52.00	77.00	6.00	6.036	GT106.2357.010.52.60.R
6.00	0.15	23	8	2.70	5.70	0.30	12.00	37.00	6.00	6.013	GT106.2357.015.12.60.R
6.00	0.15	23	8	2.70	5.70	0.30	17.00	42.00	6.00	6.014	GT106.2357.015.17.60.R
6.00	0.15	23	8	2.70	5.70	0.30	22.00	47.00	6.00	6.015	GT106.2357.015.22.60.R
6.00	0.15	23	8	2.70	5.70	0.30	27.00	52.00	6.00	6.001	GT106.2357.015.27.60.R
6.00	0.15	23	8	2.70	5.70	0.30	32.00	57.00	6.00	6.002	GT106.2357.015.32.60.R
6.00	0.15	23	8	2.70	5.70	0.30	37.00	62.00	6.00	6.003	GT106.2357.015.37.60.R
6.00	0.15	23	8	2.70	5.70	0.30	42.00	67.00	6.00	6.004	GT106.2357.015.42.60.R
6.00	0.15	23	8	2.70	5.70	0.30	47.00	72.00	6.00	6.005	GT106.2357.015.47.60.R
6.00	0.15	23	8	2.70	5.70	0.30	52.00	77.00	6.00	6.006	GT106.2357.015.52.60.R
6.00	0.20	23	8	2.70	5.70	0.30	12.00	37.00	6.00	6.037	GT106.2357.020.12.60.R
6.00	0.20	23	8	2.70	5.70	0.30	17.00	42.00	6.00	6.038	GT106.2357.020.17.60.R
6.00	0.20	23	8	2.70	5.70	0.30	22.00	47.00	6.00	6.039	GT106.2357.020.22.60.R
6.00	0.20	23	8	2.70	5.70	0.30	27.00	52.00	6.00	6.040	GT106.2357.020.27.60.R
6.00	0.20	23	8	2.70	5.70	0.30	32.00	57.00	6.00	6.041	GT106.2357.020.32.60.R
6.00	0.20	23	8	2.70	5.70	0.30	37.00	62.00	6.00	6.042	GT106.2357.020.37.60.R
6.00	0.20	23	8	2.70	5.70	0.30	42.00	67.00	6.00	6.043	GT106.2357.020.42.60.R
6.00	0.20	23	8	2.70	5.70	0.30	47.00	72.00	6.00	6.044	GT106.2357.020.47.60.R
6.00	0.20	23	8	2.70	5.70	0.30	52.00	77.00	6.00	6.045	GT106.2357.020.52.60.R
6.00	0.25	23	8	2.70	5.70	0.30	12.00	37.00	6.00	6.046	GT106.2357.025.12.60.R
6.00	0.25	23	8	2.70	5.70	0.30	17.00	42.00	6.00	6.047	GT106.2357.025.17.60.R
6.00	0.25	23	8	2.70	5.70	0.30	22.00	47.00	6.00	6.048	GT106.2357.025.22.60.R
6.00	0.25	23	8	2.70	5.70	0.30	27.00	52.00	6.00	6.049	GT106.2357.025.27.60.R
6.00	0.25	23	8	2.70	5.70	0.30	32.00	57.00	6.00	6.050	GT106.2357.025.32.60.R
6.00	0.25	23	8	2.70	5.70	0.30	37.00	62.00	6.00	6.051	GT106.2357.025.37.60.R
6.00	0.25	23	8	2.70	5.70	0.30	42.00	67.00	6.00	6.052	GT106.2357.025.42.60.R
6.00	0.25	23	8	2.70	5.70	0.30	47.00	72.00	6.00	6.053	GT106.2357.025.47.60.R
6.00	0.25	23	8	2.70	5.70	0.30	52.00	77.00	6.00	6.054	GT106.2357.025.52.60.R
6.00	0.30	23	8	2.70	5.70	0.30	12.00	37.00	6.00	6.016	GT106.2357.030.12.60.R
6.00	0.30	23	8	2.70	5.70	0.30	17.00	42.00	6.00	6.017	GT106.2357.030.17.60.R
6.00	0.30	23	8	2.70	5.70	0.30	22.00	47.00	6.00	6.018	GT106.2357.030.22.60.R
6.00	0.30	23	8	2.70	5.70	0.30	27.00	52.00	6.00	6.007	GT106.2357.030.27.60.R
6.00	0.30	23	8	2.70	5.70	0.30	32.00	57.00	6.00	6.008	GT106.2357.030.32.60.R
6.00	0.30	23	8	2.70	5.70	0.30	37.00	62.00	6.00	6.009	GT106.2357.030.37.60.R
6.00	0.30	23	8	2.70	5.70	0.30	42.00	67.00	6.00	6.010	GT106.2357.030.42.60.R
6.00	0.30	23	8	2.70	5.70	0.30	47.00	72.00	6.00	6.011	GT106.2357.030.47.60.R
6.00	0.30	23	8	2.70	5.70	0.30	52.00	77.00	6.00	6.012	GT106.2357.030.52.60.R

Boring out

Article no. **25703** **a**

Article no. **25707** ○

On the left-hand design, the designation changes to .L



Cutting inserts for boring out and profiling

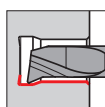

radial free 23°
for tool holders type GB108/GH108



P
M
K
N
S
H
VHM
GT108
a

Cutting data page 1556



P
M
K
N
S
H
VHM
GT108
a

Cutting data page 1556

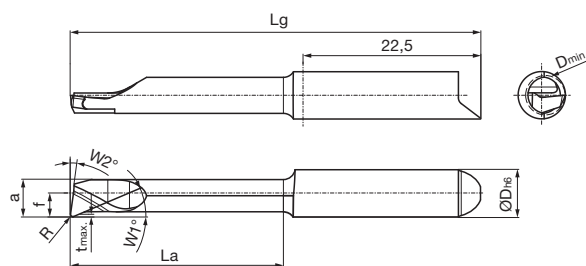

Right-hand design as shown. Left-hand design is mirror image.

Article no. **27100** a R

Article no. **27102** L R

Dmin. mm	R mm	W1 °	W2 °	f mm	a mm	tmax. mm	La mm	Lg mm	D h6 mm	Code no.	Description
7.00	0.10	23	8	3.95	6.70	0.50	17.00	42.00	8.00	8.120	GT108.2367.010.17.70.R
7.00	0.10	23	8	3.95	6.70	0.50	27.00	52.00	8.00	8.140	GT108.2367.010.27.70.R
7.00	0.10	23	8	3.95	6.70	0.50	37.00	62.00	8.00	8.160	GT108.2367.010.37.70.R
7.00	0.10	23	8	3.95	6.70	0.50	42.00	67.00	8.00	8.170	GT108.2367.010.42.70.R
7.00	0.10	23	8	3.95	6.70	0.50	47.00	72.00	8.00	8.180	GT108.2367.010.47.70.R
7.00	0.10	23	8	3.95	6.70	0.50	52.00	77.00	8.00	8.190	GT108.2367.010.52.70.R
7.00	0.20	23	8	3.95	6.70	0.50	17.00	42.00	8.00	8.320	GT108.2367.020.17.70.R
7.00	0.20	23	8	3.95	6.70	0.50	27.00	52.00	8.00	8.340	GT108.2367.020.27.70.R
7.00	0.20	23	8	3.95	6.70	0.50	37.00	62.00	8.00	8.360	GT108.2367.020.37.70.R
7.00	0.20	23	8	3.95	6.70	0.50	42.00	67.00	8.00	8.370	GT108.2367.020.42.70.R
7.00	0.20	23	8	3.95	6.70	0.50	47.00	72.00	8.00	8.380	GT108.2367.020.47.70.R
7.00	0.20	23	8	3.95	6.70	0.50	52.00	77.00	8.00	8.390	GT108.2367.020.52.70.R

Article no. **27101** a L

Article no. **27103** L L

On the left-hand design, the designation changes to .L



Cutting inserts for boring out and profiling

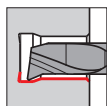

radial free 23°

for tool holders type GB108/GH108



Cutting data page 1556

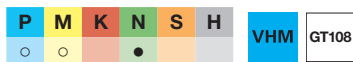

Cutting data page 1556

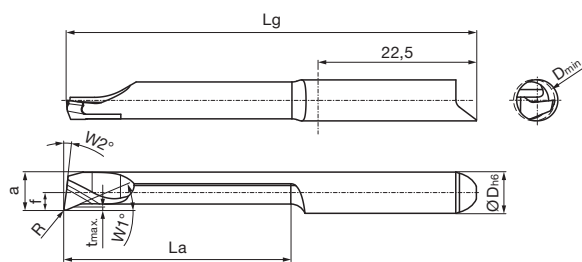

Right-hand design as shown. Left-hand design is mirror image.

Article no. **27200** **a** **R**

Article no. **27202** ○ **R**

Dmin. mm	R mm	W1 °	W2 °	f mm	a mm	tmax. mm	La mm	Lg mm	D h6 mm	Code no.	Description
8.00	0.10	23	8	3.70	7.70	0.60	17.00	42.00	8.00	8.120	GT108.2377.010.17.80.R
8.00	0.10	23	8	3.70	7.70	0.60	27.00	52.00	8.00	8.140	GT108.2377.010.27.80.R
8.00	0.10	23	8	3.70	7.70	0.60	37.00	62.00	8.00	8.160	GT108.2377.010.37.80.R
8.00	0.10	23	8	3.70	7.70	0.60	42.00	67.00	8.00	8.170	GT108.2377.010.42.80.R
8.00	0.10	23	8	3.70	7.70	0.60	47.00	72.00	8.00	8.180	GT108.2377.010.47.80.R
8.00	0.10	23	8	3.70	7.70	0.60	52.00	77.00	8.00	8.190	GT108.2377.010.52.80.R
8.00	0.20	23	8	3.70	7.70	0.60	17.00	42.00	8.00	8.320	GT108.2377.020.17.80.R
8.00	0.20	23	8	3.70	7.70	0.60	27.00	52.00	8.00	8.340	GT108.2377.020.27.80.R
8.00	0.20	23	8	3.70	7.70	0.60	37.00	62.00	8.00	8.360	GT108.2377.020.37.80.R
8.00	0.20	23	8	3.70	7.70	0.60	42.00	67.00	8.00	8.370	GT108.2377.020.42.80.R
8.00	0.20	23	8	3.70	7.70	0.60	47.00	72.00	8.00	8.380	GT108.2377.020.47.80.R
8.00	0.20	23	8	3.70	7.70	0.60	52.00	77.00	8.00	8.390	GT108.2377.020.52.80.R

Article no. **27201** **a** **L**

Article no. **27203** ○ **L**

On the left-hand design, the designation changes to .L



Cutting inserts for boring out and profiling

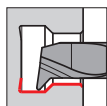

radial free 47°
for tool holders type GB104/GH104

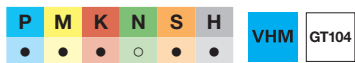

a Cutting data page 1553

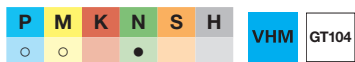

○ Cutting data page 1553

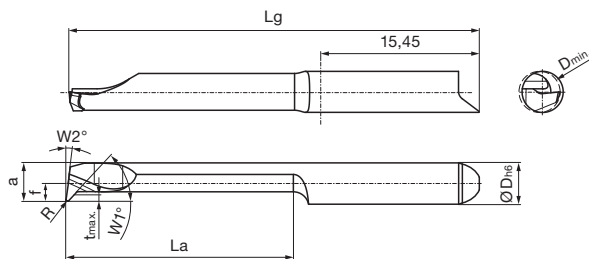

Right-hand design as shown. Left-hand design is mirror image.

Article no. **25068** **a**

Article no. **25072** ○

Dmin. mm	R mm	W1 °	W2 °	f mm	a mm	tmax. mm	La mm	Lg mm	D h6 mm	Code no.	Description
2.00	0.05	47	8	1.95	1.70	0.35	4.00	25.00	4.00	4.001	GT104.4717.005.04.20.R
2.00	0.05	47	8	1.95	1.70	0.35	7.00	25.00	4.00	4.002	GT104.4717.005.07.20.R
2.00	0.05	47	8	1.95	1.70	0.35	12.00	30.00	4.00	4.003	GT104.4717.005.12.20.R
2.00	0.05	47	8	1.95	1.70	0.35	17.00	35.00	4.00	4.004	GT104.4717.005.17.20.R
2.00	0.10	47	8	1.95	1.70	0.35	4.00	25.00	4.00	4.005	GT104.4717.010.04.20.R
2.00	0.10	47	8	1.95	1.70	0.35	7.00	25.00	4.00	4.006	GT104.4717.010.07.20.R
2.00	0.10	47	8	1.95	1.70	0.35	12.00	30.00	4.00	4.007	GT104.4717.010.12.20.R
2.00	0.10	47	8	1.95	1.70	0.35	17.00	35.00	4.00	4.008	GT104.4717.010.17.20.R
2.00	0.15	47	8	1.95	1.70	0.35	4.00	25.00	4.00	4.009	GT104.4717.015.04.20.R
2.00	0.15	47	8	1.95	1.70	0.35	7.00	25.00	4.00	4.010	GT104.4717.015.07.20.R
2.00	0.15	47	8	1.95	1.70	0.35	12.00	30.00	4.00	4.011	GT104.4717.015.12.20.R
2.00	0.15	47	8	1.95	1.70	0.35	17.00	35.00	4.00	4.012	GT104.4717.015.17.20.R
3.00	0.05	47	8	1.95	2.70	0.55	7.00	25.00	4.00	4.013	GT104.4727.005.07.30.R
3.00	0.05	47	8	1.95	2.70	0.55	12.00	30.00	4.00	4.014	GT104.4727.005.12.30.R
3.00	0.05	47	8	1.95	2.70	0.55	17.00	35.00	4.00	4.015	GT104.4727.005.17.30.R
3.00	0.05	47	8	1.95	2.70	0.55	22.00	40.00	4.00	4.016	GT104.4727.005.22.30.R
3.00	0.10	47	8	1.95	2.70	0.55	7.00	25.00	4.00	4.017	GT104.4727.010.07.30.R
3.00	0.10	47	8	1.95	2.70	0.55	12.00	30.00	4.00	4.018	GT104.4727.010.12.30.R
3.00	0.10	47	8	1.95	2.70	0.55	17.00	35.00	4.00	4.019	GT104.4727.010.17.30.R
3.00	0.10	47	8	1.95	2.70	0.55	22.00	40.00	4.00	4.020	GT104.4727.010.22.30.R
3.00	0.25	47	8	1.95	2.70	0.55	7.00	25.00	4.00	4.021	GT104.4727.025.07.30.R
3.00	0.25	47	8	1.95	2.70	0.55	12.00	30.00	4.00	4.022	GT104.4727.025.12.30.R
3.00	0.25	47	8	1.95	2.70	0.55	17.00	35.00	4.00	4.023	GT104.4727.025.17.30.R
3.00	0.25	47	8	1.95	2.70	0.55	22.00	40.00	4.00	4.024	GT104.4727.025.22.30.R
4.00	0.05	47	8	1.70	3.70	0.60	12.00	30.00	4.00	4.025	GT104.4737.005.12.40.R
4.00	0.05	47	8	1.70	3.70	0.60	17.00	35.00	4.00	4.026	GT104.4737.005.17.40.R
4.00	0.05	47	8	1.70	3.70	0.60	22.00	40.00	4.00	4.027	GT104.4737.005.22.40.R
4.00	0.05	47	8	1.70	3.70	0.60	27.00	45.00	4.00	4.028	GT104.4737.005.27.40.R
4.00	0.05	47	8	1.70	3.70	0.60	32.00	50.00	4.00	4.029	GT104.4737.005.32.40.R
4.00	0.15	47	8	1.70	3.70	0.60	12.00	30.00	4.00	4.030	GT104.4737.015.12.40.R
4.00	0.15	47	8	1.70	3.70	0.60	17.00	35.00	4.00	4.031	GT104.4737.015.17.40.R
4.00	0.15	47	8	1.70	3.70	0.60	22.00	40.00	4.00	4.032	GT104.4737.015.22.40.R
4.00	0.15	47	8	1.70	3.70	0.60	27.00	45.00	4.00	4.033	GT104.4737.015.27.40.R
4.00	0.15	47	8	1.70	3.70	0.60	32.00	50.00	4.00	4.034	GT104.4737.015.32.40.R
4.00	0.25	47	8	1.70	3.70	0.60	12.00	30.00	4.00	4.035	GT104.4737.025.12.40.R
4.00	0.25	47	8	1.70	3.70	0.60	17.00	35.00	4.00	4.036	GT104.4737.025.17.40.R
4.00	0.25	47	8	1.70	3.70	0.60	22.00	40.00	4.00	4.037	GT104.4737.025.22.40.R
4.00	0.25	47	8	1.70	3.70	0.60	27.00	45.00	4.00	4.038	GT104.4737.025.27.40.R
4.00	0.25	47	8	1.70	3.70	0.60	32.00	50.00	4.00	4.039	GT104.4737.025.32.40.R
4.00	0.10	47	8	1.70	3.70	0.60	12.00	30.00	4.00	4.040	GT104.4737.010.12.40.R
4.00	0.10	47	8	1.70	3.70	0.60	17.00	35.00	4.00	4.041	GT104.4737.010.17.40.R
4.00	0.10	47	8	1.70	3.70	0.60	22.00	40.00	4.00	4.042	GT104.4737.010.22.40.R
4.00	0.20	47	8	1.70	3.70	0.60	12.00	30.00	4.00	4.043	GT104.4737.020.12.40.R
4.00	0.20	47	8	1.70	3.70	0.60	17.00	35.00	4.00	4.044	GT104.4737.020.17.40.R
4.00	0.20	47	8	1.70	3.70	0.60	22.00	40.00	4.00	4.045	GT104.4737.020.22.40.R

Article no. **25069** **a**

Article no. **25073** ○

On the left-hand design, the designation changes to .L

Boring out



Micro-precision tools for turning

Cutting inserts for boring out and profiling

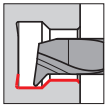

radial free 47° • tmax. 0.6 mm
for tool holders type GB106/GH106



VHM

GT106



Cutting data page 1554



VHM

GT106



Cutting data page 1554

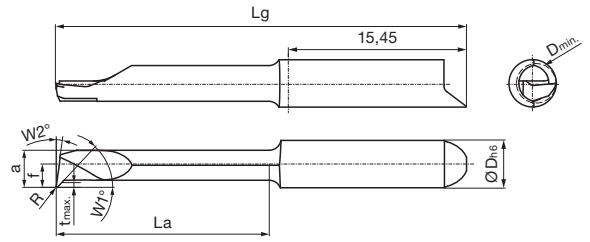

Right-hand design as shown. Left-hand design is mirror image.

Article no. **25842**



Article no. **25846**



Dmin. mm	R mm	W1 °	W2 °	f mm	a mm	tmax. mm	La mm	Lg mm	D h6 mm	Code no.	Description
5.00	0.05	47	8	2.95	4.70	0.60	12.00	37.00	6.00	6.010	GT106.4747.005.12.50.R
5.00	0.05	47	8	2.95	4.70	0.60	17.00	42.00	6.00	6.020	GT106.4747.005.17.50.R
5.00	0.05	47	8	2.95	4.70	0.60	22.00	47.00	6.00	6.030	GT106.4747.005.22.50.R
5.00	0.05	47	8	2.95	4.70	0.60	27.00	52.00	6.00	6.040	GT106.4747.005.27.50.R
5.00	0.05	47	8	2.95	4.70	0.60	32.00	57.00	6.00	6.050	GT106.4747.005.32.50.R
5.00	0.05	47	8	2.95	4.70	0.60	37.00	62.00	6.00	6.060	GT106.4747.005.37.50.R
5.00	0.05	47	8	2.95	4.70	0.60	42.00	67.00	6.00	6.070	GT106.4747.005.42.50.R
5.00	0.10	47	8	2.95	4.70	0.60	12.00	37.00	6.00	6.110	GT106.4747.010.12.50.R
5.00	0.10	47	8	2.95	4.70	0.60	17.00	42.00	6.00	6.120	GT106.4747.010.17.50.R
5.00	0.10	47	8	2.95	4.70	0.60	22.00	47.00	6.00	6.130	GT106.4747.010.22.50.R
5.00	0.10	47	8	2.95	4.70	0.60	27.00	52.00	6.00	6.140	GT106.4747.010.27.50.R
5.00	0.10	47	8	2.95	4.70	0.60	32.00	57.00	6.00	6.150	GT106.4747.010.32.50.R
5.00	0.10	47	8	2.95	4.70	0.60	37.00	62.00	6.00	6.160	GT106.4747.010.37.50.R
5.00	0.10	47	8	2.95	4.70	0.60	42.00	67.00	6.00	6.170	GT106.4747.010.42.50.R
5.00	0.15	47	8	2.95	4.70	0.60	12.00	37.00	6.00	6.210	GT106.4747.015.12.50.R
5.00	0.15	47	8	2.95	4.70	0.60	17.00	42.00	6.00	6.220	GT106.4747.015.17.50.R
5.00	0.15	47	8	2.95	4.70	0.60	22.00	47.00	6.00	6.230	GT106.4747.015.22.50.R
5.00	0.15	47	8	2.95	4.70	0.60	27.00	52.00	6.00	6.240	GT106.4747.015.27.50.R
5.00	0.15	47	8	2.95	4.70	0.60	32.00	57.00	6.00	6.250	GT106.4747.015.32.50.R
5.00	0.15	47	8	2.95	4.70	0.60	37.00	62.00	6.00	6.260	GT106.4747.015.37.50.R
5.00	0.15	47	8	2.95	4.70	0.60	42.00	67.00	6.00	6.270	GT106.4747.015.42.50.R
5.00	0.20	47	8	2.95	4.70	0.60	12.00	37.00	6.00	6.310	GT106.4747.020.12.50.R
5.00	0.20	47	8	2.95	4.70	0.60	17.00	42.00	6.00	6.320	GT106.4747.020.17.50.R
5.00	0.20	47	8	2.95	4.70	0.60	22.00	47.00	6.00	6.330	GT106.4747.020.22.50.R
5.00	0.20	47	8	2.95	4.70	0.60	27.00	52.00	6.00	6.340	GT106.4747.020.27.50.R
5.00	0.20	47	8	2.95	4.70	0.60	32.00	57.00	6.00	6.350	GT106.4747.020.32.50.R
5.00	0.20	47	8	2.95	4.70	0.60	37.00	62.00	6.00	6.360	GT106.4747.020.37.50.R
5.00	0.20	47	8	2.95	4.70	0.60	42.00	67.00	6.00	6.370	GT106.4747.020.42.50.R
5.00	0.30	47	8	2.95	4.70	0.60	12.00	37.00	6.00	6.410	GT106.4747.030.12.50.R
5.00	0.30	47	8	2.95	4.70	0.60	17.00	42.00	6.00	6.420	GT106.4747.030.17.50.R
5.00	0.30	47	8	2.95	4.70	0.60	22.00	47.00	6.00	6.430	GT106.4747.030.22.50.R
5.00	0.30	47	8	2.95	4.70	0.60	27.00	52.00	6.00	6.440	GT106.4747.030.27.50.R
5.00	0.30	47	8	2.95	4.70	0.60	32.00	57.00	6.00	6.450	GT106.4747.030.32.50.R
5.00	0.30	47	8	2.95	4.70	0.60	37.00	62.00	6.00	6.460	GT106.4747.030.37.50.R
5.00	0.30	47	8	2.95	4.70	0.60	42.00	67.00	6.00	6.470	GT106.4747.030.42.50.R

Article no. **25843**



Article no. **25847**



On the left-hand design, the designation changes to .L.



Cutting inserts for boring out and profiling

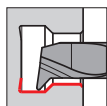

radial free 47° • tmax. 1 mm
for tool holders type GB106/GH106



P
M
K
N
S
H
VHM
GT106
a

Cutting data page 1554



P
M
K
N
S
H
VHM
GT106
○

Cutting data page 1554

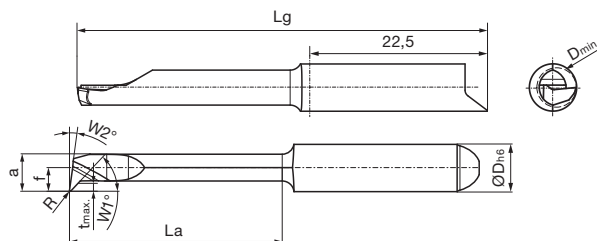

Right-hand design as shown. Left-hand design is mirror image.

Article no. **25890** a R

Article no. **25894** ○ R

Dmin. mm	R mm	W1 °	W2 °	f mm	a mm	tmax. mm	La mm	Lg mm	D h6 mm	Code no.	Description
5.00	0.05	47	8	2.95	4.70	1.00	12.00	37.00	6.00	6.010	GT106.4747.005.12.50.R.T1
5.00	0.05	47	8	2.95	4.70	1.00	17.00	42.00	6.00	6.020	GT106.4747.005.17.50.R.T1
5.00	0.05	47	8	2.95	4.70	1.00	22.00	47.00	6.00	6.030	GT106.4747.005.22.50.R.T1
5.00	0.05	47	8	2.95	4.70	1.00	27.00	52.00	6.00	6.040	GT106.4747.005.27.50.R.T1
5.00	0.05	47	8	2.95	4.70	1.00	32.00	57.00	6.00	6.050	GT106.4747.005.32.50.R.T1
5.00	0.05	47	8	2.95	4.70	1.00	37.00	62.00	6.00	6.060	GT106.4747.005.37.50.R.T1
5.00	0.05	47	8	2.95	4.70	1.00	42.00	67.00	6.00	6.070	GT106.4747.005.42.50.R.T1
5.00	0.10	47	8	2.95	4.70	1.00	12.00	37.00	6.00	6.110	GT106.4747.010.12.50.R.T1
5.00	0.10	47	8	2.95	4.70	1.00	17.00	42.00	6.00	6.120	GT106.4747.010.17.50.R.T1
5.00	0.10	47	8	2.95	4.70	1.00	22.00	47.00	6.00	6.130	GT106.4747.010.22.50.R.T1
5.00	0.10	47	8	2.95	4.70	1.00	27.00	52.00	6.00	6.140	GT106.4747.010.27.50.R.T1
5.00	0.10	47	8	2.95	4.70	1.00	32.00	57.00	6.00	6.150	GT106.4747.010.32.50.R.T1
5.00	0.10	47	8	2.95	4.70	1.00	37.00	62.00	6.00	6.160	GT106.4747.010.37.50.R.T1
5.00	0.10	47	8	2.95	4.70	1.00	42.00	67.00	6.00	6.170	GT106.4747.010.42.50.R.T1
5.00	0.15	47	8	2.95	4.70	1.00	12.00	37.00	6.00	6.210	GT106.4747.015.12.50.R.T1
5.00	0.15	47	8	2.95	4.70	1.00	17.00	42.00	6.00	6.220	GT106.4747.015.17.50.R.T1
5.00	0.15	47	8	2.95	4.70	1.00	22.00	47.00	6.00	6.230	GT106.4747.015.22.50.R.T1
5.00	0.15	47	8	2.95	4.70	1.00	27.00	52.00	6.00	6.240	GT106.4747.015.27.50.R.T1
5.00	0.15	47	8	2.95	4.70	1.00	32.00	57.00	6.00	6.250	GT106.4747.015.32.50.R.T1
5.00	0.15	47	8	2.95	4.70	1.00	37.00	62.00	6.00	6.260	GT106.4747.015.37.50.R.T1
5.00	0.15	47	8	2.95	4.70	1.00	42.00	67.00	6.00	6.270	GT106.4747.015.42.50.R.T1
5.00	0.20	47	8	2.95	4.70	1.00	12.00	37.00	6.00	6.310	GT106.4747.020.12.50.R.T1
5.00	0.20	47	8	2.95	4.70	1.00	17.00	42.00	6.00	6.320	GT106.4747.020.17.50.R.T1
5.00	0.20	47	8	2.95	4.70	1.00	22.00	47.00	6.00	6.330	GT106.4747.020.22.50.R.T1
5.00	0.20	47	8	2.95	4.70	1.00	27.00	52.00	6.00	6.340	GT106.4747.020.27.50.R.T1
5.00	0.20	47	8	2.95	4.70	1.00	32.00	57.00	6.00	6.350	GT106.4747.020.32.50.R.T1
5.00	0.20	47	8	2.95	4.70	1.00	37.00	62.00	6.00	6.360	GT106.4747.020.37.50.R.T1
5.00	0.20	47	8	2.95	4.70	1.00	42.00	67.00	6.00	6.370	GT106.4747.020.42.50.R.T1
5.00	0.30	47	8	2.95	4.70	1.00	12.00	37.00	6.00	6.410	GT106.4747.030.12.50.R.T1
5.00	0.30	47	8	2.95	4.70	1.00	17.00	42.00	6.00	6.420	GT106.4747.030.17.50.R.T1
5.00	0.30	47	8	2.95	4.70	1.00	22.00	47.00	6.00	6.430	GT106.4747.030.22.50.R.T1
5.00	0.30	47	8	2.95	4.70	1.00	27.00	52.00	6.00	6.440	GT106.4747.030.27.50.R.T1
5.00	0.30	47	8	2.95	4.70	1.00	32.00	57.00	6.00	6.450	GT106.4747.030.32.50.R.T1
5.00	0.30	47	8	2.95	4.70	1.00	37.00	62.00	6.00	6.460	GT106.4747.030.37.50.R.T1
5.00	0.30	47	8	2.95	4.70	1.00	42.00	67.00	6.00	6.470	GT106.4747.030.42.50.R.T1

Article no. **25891** a L

Article no. **25895** ○ L

On the left-hand design, the designation changes to .L



Cutting inserts for boring out and profiling

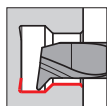

radial free 47° • tmax. 0.6 mm
for tool holders type GB106/GH106

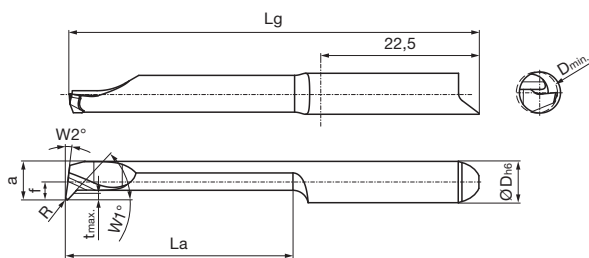
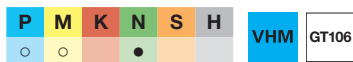

Right-hand design as shown. Left-hand design is mirror image.

Article no. **25710** **a** **(R)**

Article no. **25714** **○** **(R)**

Dmin. mm	R mm	W1 °	W2 °	f mm	a mm	tmax. mm	La mm	Lg mm	D h6 mm	Code no.	Description
6.00	0.05	47	8	2.70	5.70	0.60	12.00	37.00	6.00	6.019	GT106.4757.005.12.60.R
6.00	0.05	47	8	2.70	5.70	0.60	17.00	42.00	6.00	6.020	GT106.4757.005.17.60.R
6.00	0.05	47	8	2.70	5.70	0.60	22.00	47.00	6.00	6.021	GT106.4757.005.22.60.R
6.00	0.05	47	8	2.70	5.70	0.60	27.00	52.00	6.00	6.022	GT106.4757.005.27.60.R
6.00	0.05	47	8	2.70	5.70	0.60	32.00	57.00	6.00	6.023	GT106.4757.005.32.60.R
6.00	0.05	47	8	2.70	5.70	0.60	37.00	62.00	6.00	6.024	GT106.4757.005.37.60.R
6.00	0.05	47	8	2.70	5.70	0.60	42.00	67.00	6.00	6.025	GT106.4757.005.42.60.R
6.00	0.05	47	8	2.70	5.70	0.60	47.00	72.00	6.00	6.026	GT106.4757.005.47.60.R
6.00	0.05	47	8	2.70	5.70	0.60	52.00	77.00	6.00	6.027	GT106.4757.005.52.60.R
6.00	0.10	47	8	2.70	5.70	0.60	12.00	37.00	6.00	6.028	GT106.4757.010.12.60.R
6.00	0.10	47	8	2.70	5.70	0.60	17.00	42.00	6.00	6.029	GT106.4757.010.17.60.R
6.00	0.10	47	8	2.70	5.70	0.60	22.00	47.00	6.00	6.030	GT106.4757.010.22.60.R
6.00	0.10	47	8	2.70	5.70	0.60	27.00	52.00	6.00	6.031	GT106.4757.010.27.60.R
6.00	0.10	47	8	2.70	5.70	0.60	32.00	57.00	6.00	6.032	GT106.4757.010.32.60.R
6.00	0.10	47	8	2.70	5.70	0.60	37.00	62.00	6.00	6.033	GT106.4757.010.37.60.R
6.00	0.10	47	8	2.70	5.70	0.60	42.00	67.00	6.00	6.034	GT106.4757.010.42.60.R
6.00	0.10	47	8	2.70	5.70	0.60	47.00	72.00	6.00	6.035	GT106.4757.010.47.60.R
6.00	0.10	47	8	2.70	5.70	0.60	52.00	77.00	6.00	6.036	GT106.4757.010.52.60.R
6.00	0.15	47	8	2.70	5.70	0.60	12.00	37.00	6.00	6.013	GT106.4757.015.12.60.R
6.00	0.15	47	8	2.70	5.70	0.60	17.00	42.00	6.00	6.014	GT106.4757.015.17.60.R
6.00	0.15	47	8	2.70	5.70	0.60	22.00	47.00	6.00	6.015	GT106.4757.015.22.60.R
6.00	0.15	47	8	2.70	5.70	0.60	27.00	52.00	6.00	6.001	GT106.4757.015.27.60.R
6.00	0.15	47	8	2.70	5.70	0.60	32.00	57.00	6.00	6.002	GT106.4757.015.32.60.R
6.00	0.15	47	8	2.70	5.70	0.60	37.00	62.00	6.00	6.003	GT106.4757.015.37.60.R
6.00	0.15	47	8	2.70	5.70	0.60	42.00	67.00	6.00	6.004	GT106.4757.015.42.60.R
6.00	0.15	47	8	2.70	5.70	0.60	47.00	72.00	6.00	6.005	GT106.4757.015.47.60.R
6.00	0.15	47	8	2.70	5.70	0.60	52.00	77.00	6.00	6.006	GT106.4757.015.52.60.R
6.00	0.20	47	8	2.70	5.70	0.60	12.00	37.00	6.00	6.037	GT106.4757.020.12.60.R
6.00	0.20	47	8	2.70	5.70	0.60	17.00	42.00	6.00	6.038	GT106.4757.020.17.60.R
6.00	0.20	47	8	2.70	5.70	0.60	22.00	47.00	6.00	6.039	GT106.4757.020.22.60.R
6.00	0.20	47	8	2.70	5.70	0.60	27.00	52.00	6.00	6.040	GT106.4757.020.27.60.R
6.00	0.20	47	8	2.70	5.70	0.60	32.00	57.00	6.00	6.041	GT106.4757.020.32.60.R
6.00	0.20	47	8	2.70	5.70	0.60	37.00	62.00	6.00	6.042	GT106.4757.020.37.60.R
6.00	0.20	47	8	2.70	5.70	0.60	42.00	67.00	6.00	6.043	GT106.4757.020.42.60.R
6.00	0.20	47	8	2.70	5.70	0.60	47.00	72.00	6.00	6.044	GT106.4757.020.47.60.R
6.00	0.20	47	8	2.70	5.70	0.60	52.00	77.00	6.00	6.045	GT106.4757.020.52.60.R
6.00	0.30	47	8	2.70	5.70	0.60	12.00	37.00	6.00	6.016	GT106.4757.030.12.60.R
6.00	0.30	47	8	2.70	5.70	0.60	17.00	42.00	6.00	6.017	GT106.4757.030.17.60.R
6.00	0.30	47	8	2.70	5.70	0.60	22.00	47.00	6.00	6.018	GT106.4757.030.22.60.R
6.00	0.30	47	8	2.70	5.70	0.60	27.00	52.00	6.00	6.007	GT106.4757.030.27.60.R
6.00	0.30	47	8	2.70	5.70	0.60	32.00	57.00	6.00	6.008	GT106.4757.030.32.60.R
6.00	0.30	47	8	2.70	5.70	0.60	37.00	62.00	6.00	6.009	GT106.4757.030.37.60.R
6.00	0.30	47	8	2.70	5.70	0.60	42.00	67.00	6.00	6.010	GT106.4757.030.42.60.R
6.00	0.30	47	8	2.70	5.70	0.60	47.00	72.00	6.00	6.011	GT106.4757.030.47.60.R
6.00	0.30	47	8	2.70	5.70	0.60	52.00	77.00	6.00	6.012	GT106.4757.030.52.60.R

Boring out

On the left-hand design, the designation changes to .L

Article no. **25711** **a** **(L)**

Article no. **25715** **○** **(L)**



Cutting inserts for boring out and profiling

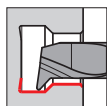

radial free 47° • tmax. 2 mm
for tool holders type GB106/GH106



Cutting data page 1554

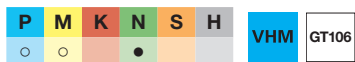

Cutting data page 1554

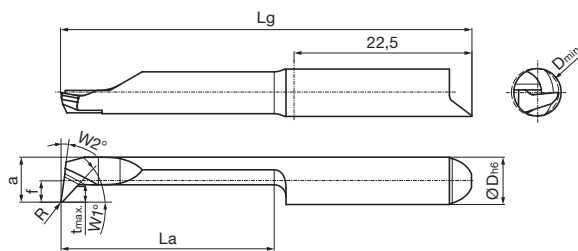

Right-hand design as shown. Left-hand design is mirror image.

Article no. **25518** a R
Article no. **25522** ○ R

Dmin. mm	R mm	W1 °	W2 °	f mm	a mm	tmax. mm	La mm	Lg mm	D h6 mm	Code no.	Description
6.00	0.05	47	8	2.70	5.70	2.00	12.00	37.00	6.00	6.010	GT106.4757.005.12.60.R.T2
6.00	0.05	47	8	2.70	5.70	2.00	17.00	42.00	6.00	6.020	GT106.4757.005.17.60.R.T2
6.00	0.05	47	8	2.70	5.70	2.00	22.00	47.00	6.00	6.030	GT106.4757.005.22.60.R.T2
6.00	0.05	47	8	2.70	5.70	2.00	27.00	52.00	6.00	6.040	GT106.4757.005.27.60.R.T2
6.00	0.05	47	8	2.70	5.70	2.00	32.00	57.00	6.00	6.050	GT106.4757.005.32.60.R.T2
6.00	0.05	47	8	2.70	5.70	2.00	37.00	62.00	6.00	6.060	GT106.4757.005.37.60.R.T2
6.00	0.05	47	8	2.70	5.70	2.00	42.00	67.00	6.00	6.070	GT106.4757.005.42.60.R.T2
6.00	0.05	47	8	2.70	5.70	2.00	47.00	72.00	6.00	6.080	GT106.4757.005.47.60.R.T2
6.00	0.05	47	8	2.70	5.70	2.00	52.00	77.00	6.00	6.090	GT106.4757.005.52.60.R.T2
6.00	0.10	47	8	2.70	5.70	2.00	12.00	37.00	6.00	6.110	GT106.4757.010.12.60.R.T2
6.00	0.10	47	8	2.70	5.70	2.00	17.00	42.00	6.00	6.120	GT106.4757.010.17.60.R.T2
6.00	0.10	47	8	2.70	5.70	2.00	22.00	47.00	6.00	6.130	GT106.4757.010.22.60.R.T2
6.00	0.10	47	8	2.70	5.70	2.00	27.00	52.00	6.00	6.140	GT106.4757.010.27.60.R.T2
6.00	0.10	47	8	2.70	5.70	2.00	32.00	57.00	6.00	6.150	GT106.4757.010.32.60.R.T2
6.00	0.10	47	8	2.70	5.70	2.00	37.00	62.00	6.00	6.160	GT106.4757.010.37.60.R.T2
6.00	0.10	47	8	2.70	5.70	2.00	42.00	67.00	6.00	6.170	GT106.4757.010.42.60.R.T2
6.00	0.10	47	8	2.70	5.70	2.00	47.00	72.00	6.00	6.180	GT106.4757.010.47.60.R.T2
6.00	0.10	47	8	2.70	5.70	2.00	52.00	77.00	6.00	6.190	GT106.4757.010.52.60.R.T2
6.00	0.15	47	8	2.70	5.70	2.00	12.00	37.00	6.00	6.210	GT106.4757.015.12.60.R.T2
6.00	0.15	47	8	2.70	5.70	2.00	17.00	42.00	6.00	6.220	GT106.4757.015.17.60.R.T2
6.00	0.15	47	8	2.70	5.70	2.00	22.00	47.00	6.00	6.230	GT106.4757.015.22.60.R.T2
6.00	0.15	47	8	2.70	5.70	2.00	27.00	52.00	6.00	6.240	GT106.4757.015.27.60.R.T2
6.00	0.15	47	8	2.70	5.70	2.00	32.00	57.00	6.00	6.250	GT106.4757.015.32.60.R.T2
6.00	0.15	47	8	2.70	5.70	2.00	37.00	62.00	6.00	6.260	GT106.4757.015.37.60.R.T2
6.00	0.15	47	8	2.70	5.70	2.00	42.00	67.00	6.00	6.270	GT106.4757.015.42.60.R.T2
6.00	0.15	47	8	2.70	5.70	2.00	47.00	72.00	6.00	6.280	GT106.4757.015.47.60.R.T2
6.00	0.15	47	8	2.70	5.70	2.00	52.00	77.00	6.00	6.290	GT106.4757.015.52.60.R.T2
6.00	0.20	47	8	2.70	5.70	2.00	12.00	37.00	6.00	6.310	GT106.4757.020.12.60.R.T2
6.00	0.20	47	8	2.70	5.70	2.00	17.00	42.00	6.00	6.320	GT106.4757.020.17.60.R.T2
6.00	0.20	47	8	2.70	5.70	2.00	22.00	47.00	6.00	6.330	GT106.4757.020.22.60.R.T2
6.00	0.20	47	8	2.70	5.70	2.00	27.00	52.00	6.00	6.340	GT106.4757.020.27.60.R.T2
6.00	0.20	47	8	2.70	5.70	2.00	32.00	57.00	6.00	6.350	GT106.4757.020.32.60.R.T2
6.00	0.20	47	8	2.70	5.70	2.00	37.00	62.00	6.00	6.360	GT106.4757.020.37.60.R.T2
6.00	0.20	47	8	2.70	5.70	2.00	42.00	67.00	6.00	6.370	GT106.4757.020.42.60.R.T2
6.00	0.20	47	8	2.70	5.70	2.00	47.00	72.00	6.00	6.380	GT106.4757.020.47.60.R.T2
6.00	0.20	47	8	2.70	5.70	2.00	52.00	77.00	6.00	6.390	GT106.4757.020.52.60.R.T2
6.00	0.30	47	8	2.70	5.70	2.00	12.00	37.00	6.00	6.410	GT106.4757.030.12.60.R.T2
6.00	0.30	47	8	2.70	5.70	2.00	17.00	42.00	6.00	6.420	GT106.4757.030.17.60.R.T2
6.00	0.30	47	8	2.70	5.70	2.00	22.00	47.00	6.00	6.430	GT106.4757.030.22.60.R.T2
6.00	0.30	47	8	2.70	5.70	2.00	27.00	52.00	6.00	6.440	GT106.4757.030.27.60.R.T2
6.00	0.30	47	8	2.70	5.70	2.00	32.00	57.00	6.00	6.450	GT106.4757.030.32.60.R.T2
6.00	0.30	47	8	2.70	5.70	2.00	37.00	62.00	6.00	6.460	GT106.4757.030.37.60.R.T2
6.00	0.30	47	8	2.70	5.70	2.00	42.00	67.00	6.00	6.470	GT106.4757.030.42.60.R.T2
6.00	0.30	47	8	2.70	5.70	2.00	47.00	72.00	6.00	6.480	GT106.4757.030.47.60.R.T2
6.00	0.30	47	8	2.70	5.70	2.00	52.00	77.00	6.00	6.490	GT106.4757.030.52.60.R.T2

Boring out

On the left-hand design, the designation changes to .L

Article no. **25519** a L
Article no. **25523** ○ L



Cutting inserts for boring out and profiling

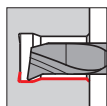

radial free 47° • tmax. 0.8 mm
for tool holders type GB108/GH108



a Cutting data page 1556



○ Cutting data page 1556

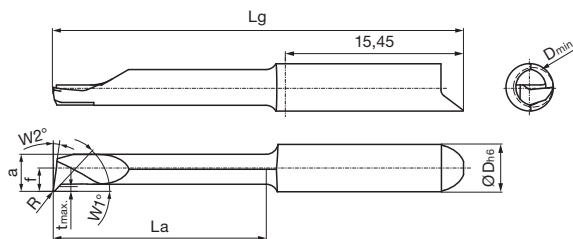

Right-hand design as shown. Left-hand design is mirror image.

Article no. **27104** **a** **R**

Article no. **27106** ○ **R**

Dmin. mm	R mm	W1 °	W2 °	f mm	a mm	tmax. mm	La mm	Lg mm	D h6 mm	Code no.	Description
7.00	0.10	47	8	3.95	6.70	0.80	17.00	42.00	8.00	8.120	GT108.4767.010.17.70.R
7.00	0.10	47	8	3.95	6.70	0.80	27.00	52.00	8.00	8.140	GT108.4767.010.27.70.R
7.00	0.10	47	8	3.95	6.70	0.80	37.00	62.00	8.00	8.160	GT108.4767.010.37.70.R
7.00	0.10	47	8	3.95	6.70	0.80	42.00	67.00	8.00	8.170	GT108.4767.010.42.70.R
7.00	0.10	47	8	3.95	6.70	0.80	47.00	72.00	8.00	8.180	GT108.4767.010.47.70.R
7.00	0.20	47	8	3.95	6.70	0.80	17.00	42.00	8.00	8.320	GT108.4767.020.17.70.R
7.00	0.20	47	8	3.95	6.70	0.80	27.00	52.00	8.00	8.340	GT108.4767.020.27.70.R
7.00	0.20	47	8	3.95	6.70	0.80	37.00	62.00	8.00	8.360	GT108.4767.020.37.70.R
7.00	0.20	47	8	3.95	6.70	0.80	42.00	67.00	8.00	8.370	GT108.4767.020.42.70.R
7.00	0.20	47	8	3.95	6.70	0.80	47.00	72.00	8.00	8.380	GT108.4767.020.47.70.R

Article no. **27105** **a** **L**

Article no. **27107** ○ **L**

On the left-hand design, the designation changes to .L



Cutting inserts for boring out and profiling

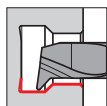

radial free 47° • tmax. 2 mm
for tool holders type GB108/GH108



P	M	K	N	S	H	VHM	GT108
•	•	•	○	•	•		

a Cutting data page 1556



P	M	K	N	S	H	VHM	GT108
○	○	•	•	•	•		

○ Cutting data page 1556

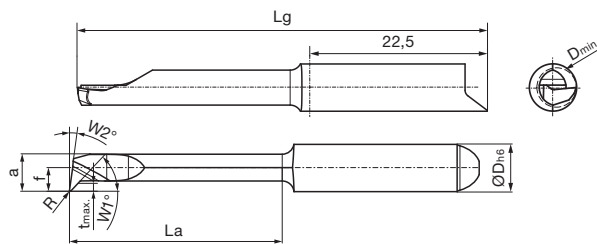

Right-hand design as shown. Left-hand design is mirror image.

Article no. **27108** **a** **R**

Article no. **27110** ○ **R**

Dmin. mm	R mm	W1 °	W2 °	f mm	a mm	tmax. mm	La mm	Lg mm	D h6 mm	Code no.	Description
7.00	0.10	47	8	3.95	6.70	2.00	17.00	42.00	8.00	8.120	GT108.4767.010.17.70.R.T2
7.00	0.10	47	8	3.95	6.70	2.00	27.00	52.00	8.00	8.140	GT108.4767.010.27.70.R.T2
7.00	0.10	47	8	3.95	6.70	2.00	37.00	62.00	8.00	8.160	GT108.4767.010.37.70.R.T2
7.00	0.10	47	8	3.95	6.70	2.00	42.00	67.00	8.00	8.170	GT108.4767.010.42.70.R.T2
7.00	0.20	47	8	3.95	6.70	2.00	17.00	42.00	8.00	8.320	GT108.4767.020.17.70.R.T2
7.00	0.20	47	8	3.95	6.70	2.00	27.00	52.00	8.00	8.340	GT108.4767.020.27.70.R.T2
7.00	0.20	47	8	3.95	6.70	2.00	37.00	62.00	8.00	8.360	GT108.4767.020.37.70.R.T2
7.00	0.20	47	8	3.95	6.70	2.00	42.00	67.00	8.00	8.370	GT108.4767.020.42.70.R.T2

Article no. **27109** **a** **L**

Article no. **27111** ○ **L**

On the left-hand design, the designation changes to .L



Cutting inserts for boring out and profiling

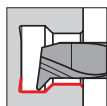

radial free 47° • tmax. 1 mm
for tool holders type GB108/GH108



a Cutting data page 1556



○ Cutting data page 1556

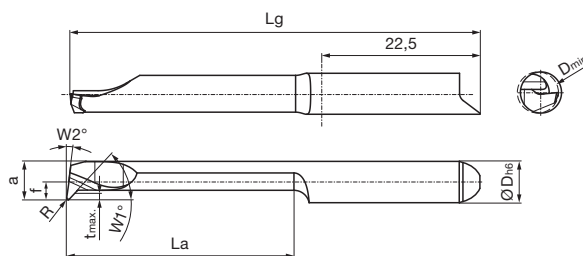

Article no. **27204** **a**

Article no. **27206** ○

Right-hand design as shown. Left-hand design is mirror image.

Dmin. mm	R mm	W1 °	W2 °	f mm	a mm	tmax. mm	La mm	Lg mm	D h6 mm	Code no.	Description
8.00	0.10	47	8	3.70	7.70	1.00	17.00	42.00	8.00	8.029	GT108.4777.010.17.80.R
8.00	0.10	47	8	3.70	7.70	1.00	27.00	52.00	8.00	8.031	GT108.4777.010.27.80.R
8.00	0.10	47	8	3.70	7.70	1.00	37.00	62.00	8.00	8.033	GT108.4777.010.37.80.R
8.00	0.10	47	8	3.70	7.70	1.00	42.00	67.00	8.00	8.034	GT108.4777.010.42.80.R
8.00	0.10	47	8	3.70	7.70	1.00	47.00	72.00	8.00	8.035	GT108.4777.010.47.80.R
8.00	0.20	47	8	3.70	7.70	1.00	17.00	42.00	8.00	8.038	GT108.4777.020.17.80.R
8.00	0.20	47	8	3.70	7.70	1.00	27.00	52.00	8.00	8.040	GT108.4777.020.27.80.R
8.00	0.20	47	8	3.70	7.70	1.00	37.00	62.00	8.00	8.042	GT108.4777.020.37.80.R
8.00	0.20	47	8	3.70	7.70	1.00	42.00	67.00	8.00	8.043	GT108.4777.020.42.80.R
8.00	0.20	47	8	3.70	7.70	1.00	47.00	72.00	8.00	8.044	GT108.4777.020.47.80.R

Article no. **27205** **a**

Article no. **27207** ○

On the left-hand design, the designation changes to .L

Cutting inserts for boring out and profiling

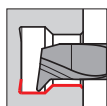

radial free 47° • tmax. 2.5 mm
for tool holders type GB108/GH108



a Cutting data page 1556

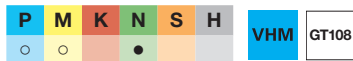

○ Cutting data page 1556

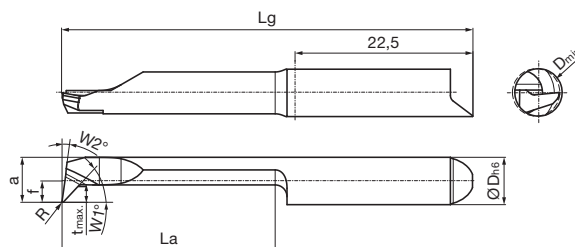

Article no. **27208** **a**

Article no. **27210** ○

Right-hand design as shown. Left-hand design is mirror image.

Dmin. mm	R mm	W1 °	W2 °	f mm	a mm	tmax. mm	La mm	Lg mm	D h6 mm	Code no.	Description
8.00	0.10	47	8	3.70	7.70	2.50	17.00	42.00	8.00	8.120	GT108.4777.010.17.80.R.T2.5
8.00	0.10	47	8	3.70	7.70	2.50	27.00	52.00	8.00	8.140	GT108.4777.010.27.80.R.T2.5
8.00	0.10	47	8	3.70	7.70	2.50	37.00	62.00	8.00	8.160	GT108.4777.010.37.80.R.T2.5
8.00	0.10	47	8	3.70	7.70	2.50	42.00	67.00	8.00	8.170	GT108.4777.010.42.80.R.T2.5
8.00	0.20	47	8	3.70	7.70	2.50	17.00	42.00	8.00	8.320	GT108.4777.020.17.80.R.T2.5
8.00	0.20	47	8	3.70	7.70	2.50	27.00	52.00	8.00	8.340	GT108.4777.020.27.80.R.T2.5
8.00	0.20	47	8	3.70	7.70	2.50	37.00	62.00	8.00	8.360	GT108.4777.020.37.80.R.T2.5
8.00	0.20	47	8	3.70	7.70	2.50	42.00	67.00	8.00	8.370	GT108.4777.020.42.80.R.T2.5

Article no. **27209** **a**

Article no. **27211** ○

On the left-hand design, the designation changes to .L

Boring out



Cutting inserts for boring out and profiling

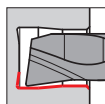

radial free 8°
for tool holders type GB104/GH104

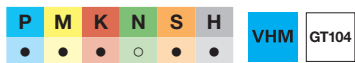

a Cutting data page 1553

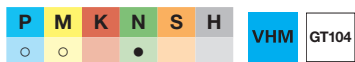

○ Cutting data page 1553

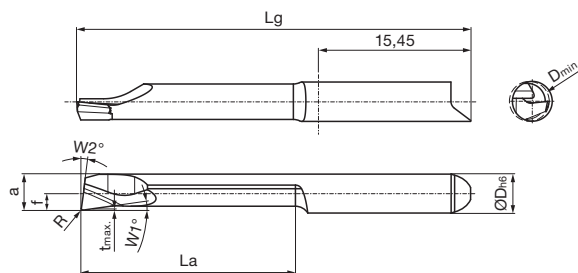

Right-hand design as shown. Left-hand design is mirror image.

Article no. **25084** **a**

Article no. **25088** ○

Dmin. mm	R mm	W1 °	W2 °	f mm	a mm	tmax. mm	La mm	Lg mm	D h6 mm	Code no.	Description
3.00	0.05	8	8	1.95	2.70	0.15	7.00	25.00	4.00	4.001	GT104.0827.005.07.30.R
3.00	0.05	8	8	1.95	2.70	0.15	12.00	30.00	4.00	4.002	GT104.0827.005.12.30.R
3.00	0.05	8	8	1.95	2.70	0.15	17.00	35.00	4.00	4.003	GT104.0827.005.17.30.R
3.00	0.05	8	8	1.95	2.70	0.15	22.00	40.00	4.00	4.004	GT104.0827.005.22.30.R
3.00	0.10	8	8	1.95	2.70	0.15	7.00	25.00	4.00	4.005	GT104.0827.010.07.30.R
3.00	0.10	8	8	1.95	2.70	0.15	12.00	30.00	4.00	4.006	GT104.0827.010.12.30.R
3.00	0.10	8	8	1.95	2.70	0.15	17.00	35.00	4.00	4.007	GT104.0827.010.17.30.R
3.00	0.10	8	8	1.95	2.70	0.15	22.00	40.00	4.00	4.008	GT104.0827.010.22.30.R
3.00	0.20	8	8	1.95	2.70	0.15	7.00	25.00	4.00	4.009	GT104.0827.020.07.30.R
3.00	0.20	8	8	1.95	2.70	0.15	12.00	30.00	4.00	4.010	GT104.0827.020.12.30.R
3.00	0.20	8	8	1.95	2.70	0.15	17.00	35.00	4.00	4.011	GT104.0827.020.17.30.R
3.00	0.20	8	8	1.95	2.70	0.15	22.00	40.00	4.00	4.012	GT104.0827.020.22.30.R
4.00	0.05	8	8	1.70	3.70	0.15	12.00	30.00	4.00	4.013	GT104.0837.005.12.40.R
4.00	0.05	8	8	1.70	3.70	0.15	17.00	35.00	4.00	4.014	GT104.0837.005.17.40.R
4.00	0.05	8	8	1.70	3.70	0.15	22.00	40.00	4.00	4.015	GT104.0837.005.22.40.R
4.00	0.05	8	8	1.70	3.70	0.15	27.00	45.00	4.00	4.016	GT104.0837.005.27.40.R
4.00	0.05	8	8	1.70	3.70	0.15	32.00	50.00	4.00	4.017	GT104.0837.005.32.40.R
4.00	0.15	8	8	1.70	3.70	0.15	12.00	30.00	4.00	4.018	GT104.0837.015.12.40.R
4.00	0.15	8	8	1.70	3.70	0.15	17.00	35.00	4.00	4.019	GT104.0837.015.17.40.R
4.00	0.15	8	8	1.70	3.70	0.15	22.00	40.00	4.00	4.020	GT104.0837.015.22.40.R
4.00	0.15	8	8	1.70	3.70	0.15	27.00	45.00	4.00	4.021	GT104.0837.015.27.40.R
4.00	0.15	8	8	1.70	3.70	0.15	32.00	50.00	4.00	4.022	GT104.0837.015.32.40.R
4.00	0.25	8	8	1.70	3.70	0.15	12.00	30.00	4.00	4.023	GT104.0837.025.12.40.R
4.00	0.25	8	8	1.70	3.70	0.15	17.00	35.00	4.00	4.024	GT104.0837.025.17.40.R
4.00	0.25	8	8	1.70	3.70	0.15	22.00	40.00	4.00	4.025	GT104.0837.025.22.40.R
4.00	0.25	8	8	1.70	3.70	0.15	27.00	45.00	4.00	4.026	GT104.0837.025.27.40.R
4.00	0.25	8	8	1.70	3.70	0.15	32.00	50.00	4.00	4.027	GT104.0837.025.32.40.R
4.00	0.10	8	8	1.70	3.70	0.15	12.00	30.00	4.00	4.028	GT104.0837.010.12.40.R
4.00	0.10	8	8	1.70	3.70	0.15	17.00	35.00	4.00	4.029	GT104.0837.010.17.40.R
4.00	0.10	8	8	1.70	3.70	0.15	22.00	40.00	4.00	4.030	GT104.0837.010.22.40.R

Article no. **25085** **a**

Article no. **25089** ○

On the left-hand design, the designation changes to .L



Cutting inserts for boring out and profiling

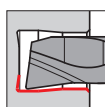

radial free 8°
for tool holders type GB106/GH106

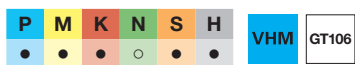

a Cutting data page 1554

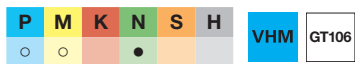

○ Cutting data page 1554

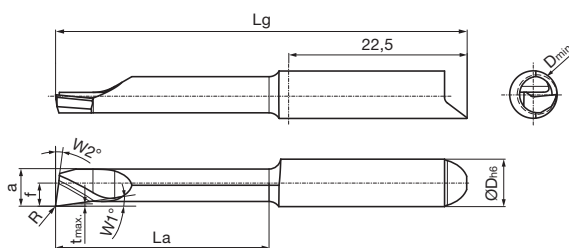

Right-hand design as shown. Left-hand design is mirror image.

Article no. **25502** **a**

Article no. **25506** ○

Dmin. mm	R mm	W1 °	W2 °	f mm	a mm	tmax. mm	La mm	Lg mm	D h6 mm	Code no.	Description
5.00	0.05	8	8	2.95	4.70	0.30	12.00	37.00	6.00	6.010	GT106.0847.005.12.50.R
5.00	0.05	8	8	2.95	4.70	0.30	17.00	42.00	6.00	6.020	GT106.0847.005.17.50.R
5.00	0.05	8	8	2.95	4.70	0.30	22.00	47.00	6.00	6.030	GT106.0847.005.22.50.R
5.00	0.05	8	8	2.95	4.70	0.30	27.00	52.00	6.00	6.040	GT106.0847.005.27.50.R
5.00	0.05	8	8	2.95	4.70	0.30	32.00	57.00	6.00	6.050	GT106.0847.005.32.50.R
5.00	0.05	8	8	2.95	4.70	0.30	37.00	62.00	6.00	6.060	GT106.0847.005.37.50.R
5.00	0.05	8	8	2.95	4.70	0.30	42.00	67.00	6.00	6.070	GT106.0847.005.42.50.R
5.00	0.10	8	8	2.95	4.70	0.30	12.00	37.00	6.00	6.110	GT106.0847.010.12.50.R
5.00	0.10	8	8	2.95	4.70	0.30	17.00	42.00	6.00	6.120	GT106.0847.010.17.50.R
5.00	0.10	8	8	2.95	4.70	0.30	22.00	47.00	6.00	6.130	GT106.0847.010.22.50.R
5.00	0.10	8	8	2.95	4.70	0.30	27.00	52.00	6.00	6.140	GT106.0847.010.27.50.R
5.00	0.10	8	8	2.95	4.70	0.30	32.00	57.00	6.00	6.150	GT106.0847.010.32.50.R
5.00	0.10	8	8	2.95	4.70	0.30	37.00	62.00	6.00	6.160	GT106.0847.010.37.50.R
5.00	0.10	8	8	2.95	4.70	0.30	42.00	67.00	6.00	6.170	GT106.0847.010.42.50.R
5.00	0.15	8	8	2.95	4.70	0.30	12.00	37.00	6.00	6.210	GT106.0847.015.12.50.R
5.00	0.15	8	8	2.95	4.70	0.30	17.00	42.00	6.00	6.220	GT106.0847.015.17.50.R
5.00	0.15	8	8	2.95	4.70	0.30	22.00	47.00	6.00	6.230	GT106.0847.015.22.50.R
5.00	0.15	8	8	2.95	4.70	0.30	27.00	52.00	6.00	6.240	GT106.0847.015.27.50.R
5.00	0.15	8	8	2.95	4.70	0.30	32.00	57.00	6.00	6.250	GT106.0847.015.32.50.R
5.00	0.15	8	8	2.95	4.70	0.30	37.00	62.00	6.00	6.260	GT106.0847.015.37.50.R
5.00	0.15	8	8	2.95	4.70	0.30	42.00	67.00	6.00	6.270	GT106.0847.015.42.50.R
5.00	0.20	8	8	2.95	4.70	0.30	12.00	37.00	6.00	6.310	GT106.0847.020.12.50.R
5.00	0.20	8	8	2.95	4.70	0.30	17.00	42.00	6.00	6.320	GT106.0847.020.17.50.R
5.00	0.20	8	8	2.95	4.70	0.30	22.00	47.00	6.00	6.330	GT106.0847.020.22.50.R
5.00	0.20	8	8	2.95	4.70	0.30	27.00	52.00	6.00	6.340	GT106.0847.020.27.50.R
5.00	0.20	8	8	2.95	4.70	0.30	32.00	57.00	6.00	6.350	GT106.0847.020.32.50.R
5.00	0.20	8	8	2.95	4.70	0.30	37.00	62.00	6.00	6.360	GT106.0847.020.37.50.R
5.00	0.20	8	8	2.95	4.70	0.30	42.00	67.00	6.00	6.370	GT106.0847.020.42.50.R
5.00	0.30	8	8	2.95	4.70	0.30	12.00	37.00	6.00	6.410	GT106.0847.030.12.50.R
5.00	0.30	8	8	2.95	4.70	0.30	17.00	42.00	6.00	6.420	GT106.0847.030.17.50.R
5.00	0.30	8	8	2.95	4.70	0.30	22.00	47.00	6.00	6.430	GT106.0847.030.22.50.R
5.00	0.30	8	8	2.95	4.70	0.30	27.00	52.00	6.00	6.440	GT106.0847.030.27.50.R
5.00	0.30	8	8	2.95	4.70	0.30	32.00	57.00	6.00	6.450	GT106.0847.030.32.50.R
5.00	0.30	8	8	2.95	4.70	0.30	37.00	62.00	6.00	6.460	GT106.0847.030.37.50.R
5.00	0.30	8	8	2.95	4.70	0.30	42.00	67.00	6.00	6.470	GT106.0847.030.42.50.R

Article no. **25503** **a**

Article no. **25507** ○

On the left-hand design, the designation changes to .L.



Cutting inserts for boring out and profiling

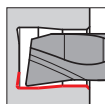

radial free 8°
for tool holders type GB106/GH106



Cutting data page 1554

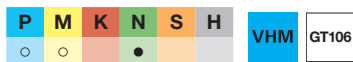

Cutting data page 1554

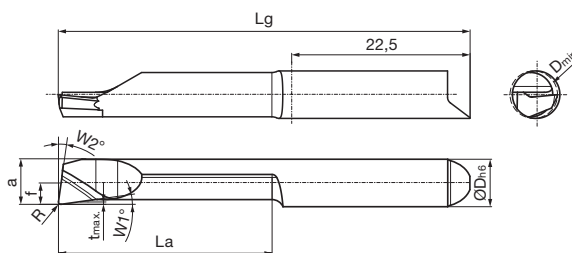

Right-hand design as shown. Left-hand design is mirror image.

Article no. **25510** a R

Article no. **25514** ○ R

Dmin. mm	R mm	W1 °	W2 °	f mm	a mm	tmax. mm	La mm	Lg mm	D h6 mm	Code no.	Description
6.00	0.05	8	8	2.70	5.70	0.30	12.00	37.00	6.00	6.010	GT106.0857.005.12.60.R
6.00	0.05	8	8	2.70	5.70	0.30	17.00	42.00	6.00	6.020	GT106.0857.005.17.60.R
6.00	0.05	8	8	2.70	5.70	0.30	22.00	47.00	6.00	6.030	GT106.0857.005.22.60.R
6.00	0.05	8	8	2.70	5.70	0.30	27.00	52.00	6.00	6.040	GT106.0857.005.27.60.R
6.00	0.05	8	8	2.70	5.70	0.30	32.00	57.00	6.00	6.050	GT106.0857.005.32.60.R
6.00	0.05	8	8	2.70	5.70	0.30	37.00	62.00	6.00	6.060	GT106.0857.005.37.60.R
6.00	0.05	8	8	2.70	5.70	0.30	42.00	67.00	6.00	6.070	GT106.0857.005.42.60.R
6.00	0.10	8	8	2.70	5.70	0.30	12.00	37.00	6.00	6.110	GT106.0857.010.12.60.R
6.00	0.10	8	8	2.70	5.70	0.30	17.00	42.00	6.00	6.120	GT106.0857.010.17.60.R
6.00	0.10	8	8	2.70	5.70	0.30	22.00	47.00	6.00	6.130	GT106.0857.010.22.60.R
6.00	0.10	8	8	2.70	5.70	0.30	27.00	52.00	6.00	6.140	GT106.0857.010.27.60.R
6.00	0.10	8	8	2.70	5.70	0.30	32.00	57.00	6.00	6.150	GT106.0857.010.32.60.R
6.00	0.10	8	8	2.70	5.70	0.30	37.00	62.00	6.00	6.160	GT106.0857.010.37.60.R
6.00	0.10	8	8	2.70	5.70	0.30	42.00	67.00	6.00	6.170	GT106.0857.010.42.60.R
6.00	0.15	8	8	2.70	5.70	0.30	12.00	37.00	6.00	6.210	GT106.0857.015.12.60.R
6.00	0.15	8	8	2.70	5.70	0.30	17.00	42.00	6.00	6.220	GT106.0857.015.17.60.R
6.00	0.15	8	8	2.70	5.70	0.30	22.00	47.00	6.00	6.230	GT106.0857.015.22.60.R
6.00	0.15	8	8	2.70	5.70	0.30	27.00	52.00	6.00	6.240	GT106.0857.015.27.60.R
6.00	0.15	8	8	2.70	5.70	0.30	32.00	57.00	6.00	6.250	GT106.0857.015.32.60.R
6.00	0.15	8	8	2.70	5.70	0.30	37.00	62.00	6.00	6.260	GT106.0857.015.37.60.R
6.00	0.15	8	8	2.70	5.70	0.30	42.00	67.00	6.00	6.270	GT106.0857.015.42.60.R
6.00	0.20	8	8	2.70	5.70	0.30	12.00	37.00	6.00	6.310	GT106.0857.020.12.60.R
6.00	0.20	8	8	2.70	5.70	0.30	17.00	42.00	6.00	6.320	GT106.0857.020.17.60.R
6.00	0.20	8	8	2.70	5.70	0.30	22.00	47.00	6.00	6.330	GT106.0857.020.22.60.R
6.00	0.20	8	8	2.70	5.70	0.30	27.00	52.00	6.00	6.340	GT106.0857.020.27.60.R
6.00	0.20	8	8	2.70	5.70	0.30	32.00	57.00	6.00	6.350	GT106.0857.020.32.60.R
6.00	0.20	8	8	2.70	5.70	0.30	37.00	62.00	6.00	6.360	GT106.0857.020.37.60.R
6.00	0.20	8	8	2.70	5.70	0.30	42.00	67.00	6.00	6.370	GT106.0857.020.42.60.R
6.00	0.30	8	8	2.70	5.70	0.30	12.00	37.00	6.00	6.410	GT106.0857.030.12.60.R
6.00	0.30	8	8	2.70	5.70	0.30	17.00	42.00	6.00	6.420	GT106.0857.030.17.60.R
6.00	0.30	8	8	2.70	5.70	0.30	22.00	47.00	6.00	6.430	GT106.0857.030.22.60.R
6.00	0.30	8	8	2.70	5.70	0.30	27.00	52.00	6.00	6.440	GT106.0857.030.27.60.R
6.00	0.30	8	8	2.70	5.70	0.30	32.00	57.00	6.00	6.450	GT106.0857.030.32.60.R
6.00	0.30	8	8	2.70	5.70	0.30	37.00	62.00	6.00	6.460	GT106.0857.030.37.60.R
6.00	0.30	8	8	2.70	5.70	0.30	42.00	67.00	6.00	6.470	GT106.0857.030.42.60.R

Article no. **25511** a L

Article no. **25515** ○ L

On the left-hand design, the designation changes to .L

Boring out



Cutting inserts for boring out and profiling

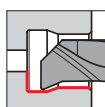

face flat 90°

for tool holders type GB104/GH104

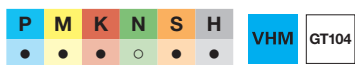

a Cutting data page 1553



○ Cutting data page 1553

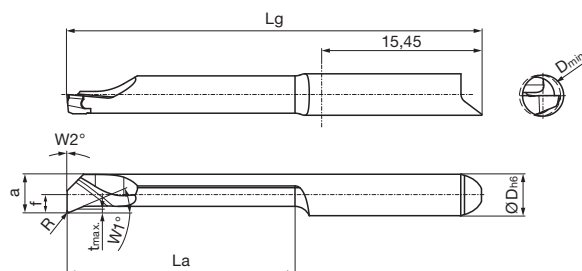

Right-hand design as shown. Left-hand design is mirror image.

Article no. **25060**



Article no. **25064**



Dmin. mm	R mm	W1 °	W2 °	f mm	a mm	tmax. mm	La mm	Lg mm	D h6 mm	Code no.	Description
0.70	0.05	23	0	1.95	0.60	0.05	3.00	25.00	4.00	4.001	GT104.9006.005.03.07.R
1.00	0.05	23	0	1.95	0.90	0.10	4.00	25.00	4.00	4.002	GT104.9009.005.04.10.R
1.00	0.05	23	0	1.95	0.90	0.10	7.00	25.00	4.00	4.003	GT104.9009.005.07.10.R
1.50	0.05	23	0	1.95	1.40	0.15	4.00	25.00	4.00	4.004	GT104.9014.005.04.15.R
1.50	0.05	23	0	1.95	1.40	0.15	7.00	25.00	4.00	4.005	GT104.9014.005.07.15.R
1.50	0.05	23	0	1.95	1.40	0.15	12.00	30.00	4.00	4.006	GT104.9014.005.12.15.R
1.50	0.10	23	0	1.95	1.40	0.15	4.00	25.00	4.00	4.007	GT104.9014.010.04.15.R
1.50	0.10	23	0	1.95	1.40	0.15	7.00	25.00	4.00	4.008	GT104.9014.010.07.15.R
1.50	0.10	23	0	1.95	1.40	0.15	12.00	30.00	4.00	4.009	GT104.9014.010.12.15.R
2.00	0.05	23	0	1.95	1.90	0.15	4.00	25.00	4.00	4.010	GT104.9019.005.04.20.R
2.00	0.05	23	0	1.95	1.90	0.15	7.00	25.00	4.00	4.011	GT104.9019.005.07.20.R
2.00	0.05	23	0	1.95	1.90	0.15	12.00	30.00	4.00	4.012	GT104.9019.005.12.20.R
2.00	0.05	23	0	1.95	1.90	0.15	17.00	35.00	4.00	4.013	GT104.9019.005.17.20.R
2.00	0.10	23	0	1.95	1.90	0.15	4.00	25.00	4.00	4.014	GT104.9019.010.04.20.R
2.00	0.10	23	0	1.95	1.90	0.15	7.00	25.00	4.00	4.015	GT104.9019.010.07.20.R
2.00	0.10	23	0	1.95	1.90	0.15	12.00	30.00	4.00	4.016	GT104.9019.010.12.20.R
2.00	0.10	23	0	1.95	1.90	0.15	17.00	35.00	4.00	4.017	GT104.9019.010.17.20.R
2.00	0.15	23	0	1.95	1.90	0.15	4.00	25.00	4.00	4.018	GT104.9019.015.04.20.R
2.00	0.15	23	0	1.95	1.90	0.15	7.00	25.00	4.00	4.019	GT104.9019.015.07.20.R
2.00	0.15	23	0	1.95	1.90	0.15	12.00	30.00	4.00	4.020	GT104.9019.015.12.20.R
2.00	0.15	23	0	1.95	1.90	0.15	17.00	35.00	4.00	4.021	GT104.9019.015.17.20.R
3.00	0.05	23	0	1.95	2.60	0.20	7.00	25.00	4.00	4.022	GT104.9026.005.07.30.R
3.00	0.05	23	0	1.95	2.60	0.20	12.00	30.00	4.00	4.023	GT104.9026.005.12.30.R
3.00	0.05	23	0	1.95	2.60	0.20	17.00	35.00	4.00	4.024	GT104.9026.005.17.30.R
3.00	0.05	23	0	1.95	2.60	0.20	22.00	40.00	4.00	4.025	GT104.9026.005.22.30.R
3.00	0.10	23	0	1.95	2.60	0.20	7.00	25.00	4.00	4.026	GT104.9026.010.07.30.R
3.00	0.10	23	0	1.95	2.60	0.20	12.00	30.00	4.00	4.027	GT104.9026.010.12.30.R
3.00	0.10	23	0	1.95	2.60	0.20	17.00	35.00	4.00	4.028	GT104.9026.010.17.30.R
3.00	0.10	23	0	1.95	2.60	0.20	22.00	40.00	4.00	4.029	GT104.9026.010.22.30.R
3.00	0.20	23	0	1.95	2.60	0.20	7.00	25.00	4.00	4.030	GT104.9026.020.07.30.R
3.00	0.20	23	0	1.95	2.60	0.20	12.00	30.00	4.00	4.031	GT104.9026.020.12.30.R
3.00	0.20	23	0	1.95	2.60	0.20	17.00	35.00	4.00	4.032	GT104.9026.020.17.30.R
3.00	0.20	23	0	1.95	2.60	0.20	22.00	40.00	4.00	4.033	GT104.9026.020.22.30.R
4.00	0.05	23	0	1.70	3.70	0.30	12.00	30.00	4.00	4.034	GT104.9037.005.12.40.R
4.00	0.05	23	0	1.70	3.70	0.30	17.00	35.00	4.00	4.035	GT104.9037.005.17.40.R
4.00	0.05	23	0	1.70	3.70	0.30	22.00	40.00	4.00	4.036	GT104.9037.005.22.40.R
4.00	0.05	23	0	1.70	3.70	0.30	27.00	45.00	4.00	4.037	GT104.9037.005.27.40.R
4.00	0.05	23	0	1.70	3.70	0.30	32.00	50.00	4.00	4.038	GT104.9037.005.32.40.R
4.00	0.15	23	0	1.70	3.70	0.30	12.00	30.00	4.00	4.039	GT104.9037.015.12.40.R
4.00	0.15	23	0	1.70	3.70	0.30	17.00	35.00	4.00	4.040	GT104.9037.015.17.40.R
4.00	0.15	23	0	1.70	3.70	0.30	22.00	40.00	4.00	4.041	GT104.9037.015.22.40.R
4.00	0.15	23	0	1.70	3.70	0.30	27.00	45.00	4.00	4.042	GT104.9037.015.27.40.R
4.00	0.15	23	0	1.70	3.70	0.30	32.00	50.00	4.00	4.043	GT104.9037.015.32.40.R
4.00	0.25	23	0	1.70	3.70	0.30	12.00	30.00	4.00	4.044	GT104.9037.025.12.40.R
4.00	0.25	23	0	1.70	3.70	0.30	17.00	35.00	4.00	4.045	GT104.9037.025.17.40.R
4.00	0.25	23	0	1.70	3.70	0.30	22.00	40.00	4.00	4.046	GT104.9037.025.22.40.R
4.00	0.25	23	0	1.70	3.70	0.30	27.00	45.00	4.00	4.047	GT104.9037.025.27.40.R
4.00	0.25	23	0	1.70	3.70	0.30	32.00	50.00	4.00	4.048	GT104.9037.025.32.40.R
4.00	0.10	23	0	1.70	3.70	0.30	12.00	30.00	4.00	4.049	GT104.9037.010.12.40.R
4.00	0.10	23	0	1.70	3.70	0.30	17.00	35.00	4.00	4.050	GT104.9037.010.17.40.R
4.00	0.10	23	0	1.70	3.70	0.30	22.00	40.00	4.00	4.051	GT104.9037.010.22.40.R

Boring out

Article no. **25061**



Article no. **25065**



On the left-hand design, the designation changes to .L



Cutting inserts for boring out and profiling



face free 20°
for tool holders type GB104/GH104



P
M
K
N
S
H
VHM
GT104
a

Cutting data page 1553



P
M
K
N
S
H
VHM
GT104
a

Cutting data page 1553

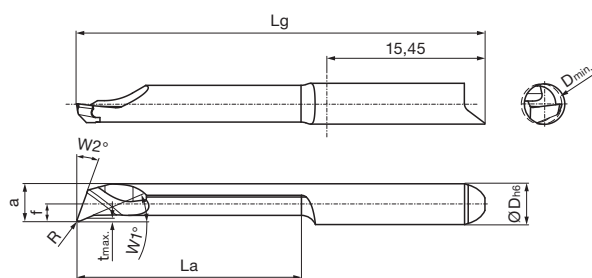

Article no. 25076 a R

Article no. 25080 ○ R

Right-hand design as shown. Left-hand design is mirror image.

Dmin. mm	R mm	W1 °	W2 °	f mm	a mm	tmax. mm	La mm	Lg mm	D h6 mm	Code no.	Description
3.00	0.05	23	20	1.95	2.60	0.20	7.00	25.00	4.00	4.001	GT104.2026.005.07.30.R
3.00	0.05	23	20	1.95	2.60	0.20	12.00	30.00	4.00	4.002	GT104.2026.005.12.30.R
3.00	0.05	23	20	1.95	2.60	0.20	17.00	35.00	4.00	4.003	GT104.2026.005.17.30.R
3.00	0.05	23	20	1.95	2.60	0.20	22.00	40.00	4.00	4.004	GT104.2026.005.22.30.R
3.00	0.10	23	20	1.95	2.60	0.20	7.00	25.00	4.00	4.005	GT104.2026.010.07.30.R
3.00	0.10	23	20	1.95	2.60	0.20	12.00	30.00	4.00	4.006	GT104.2026.010.12.30.R
3.00	0.10	23	20	1.95	2.60	0.20	17.00	35.00	4.00	4.007	GT104.2026.010.17.30.R
3.00	0.10	23	20	1.95	2.60	0.20	22.00	40.00	4.00	4.008	GT104.2026.010.22.30.R
3.00	0.20	23	20	1.95	2.60	0.20	7.00	25.00	4.00	4.009	GT104.2026.020.07.30.R
3.00	0.20	23	20	1.95	2.60	0.20	12.00	30.00	4.00	4.010	GT104.2026.020.12.30.R
3.00	0.20	23	20	1.95	2.60	0.20	17.00	35.00	4.00	4.011	GT104.2026.020.17.30.R
3.00	0.20	23	20	1.95	2.60	0.20	22.00	40.00	4.00	4.012	GT104.2026.020.22.30.R
4.00	0.05	23	20	1.70	3.70	0.30	12.00	30.00	4.00	4.013	GT104.2037.005.12.40.R
4.00	0.05	23	20	1.70	3.70	0.30	17.00	35.00	4.00	4.014	GT104.2037.005.17.40.R
4.00	0.05	23	20	1.70	3.70	0.30	22.00	40.00	4.00	4.015	GT104.2037.005.22.40.R
4.00	0.05	23	20	1.70	3.70	0.30	27.00	45.00	4.00	4.016	GT104.2037.005.27.40.R
4.00	0.05	23	20	1.70	3.70	0.30	32.00	50.00	4.00	4.017	GT104.2037.005.32.40.R
4.00	0.15	23	20	1.70	3.70	0.30	12.00	30.00	4.00	4.018	GT104.2037.015.12.40.R
4.00	0.15	23	20	1.70	3.70	0.30	17.00	35.00	4.00	4.019	GT104.2037.015.17.40.R
4.00	0.15	23	20	1.70	3.70	0.30	22.00	40.00	4.00	4.020	GT104.2037.015.22.40.R
4.00	0.15	23	20	1.70	3.70	0.30	27.00	45.00	4.00	4.021	GT104.2037.015.27.40.R
4.00	0.15	23	20	1.70	3.70	0.30	32.00	50.00	4.00	4.022	GT104.2037.015.32.40.R
4.00	0.25	23	20	1.70	3.70	0.30	12.00	30.00	4.00	4.023	GT104.2037.025.12.40.R
4.00	0.25	23	20	1.70	3.70	0.30	17.00	35.00	4.00	4.024	GT104.2037.025.17.40.R
4.00	0.25	23	20	1.70	3.70	0.30	22.00	40.00	4.00	4.025	GT104.2037.025.22.40.R
4.00	0.25	23	20	1.70	3.70	0.30	27.00	45.00	4.00	4.026	GT104.2037.025.27.40.R
4.00	0.25	23	20	1.70	3.70	0.30	32.00	50.00	4.00	4.027	GT104.2037.025.32.40.R

Article no. 25077 a L

Article no. 25081 ○ L

On the left-hand design, the designation changes to .L



Cutting inserts for boring out and profiling

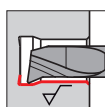

WIPER-geometry
for tool holders type GB104/GH104



a Cutting data page 1553

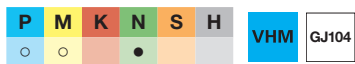

○ Cutting data page 1553

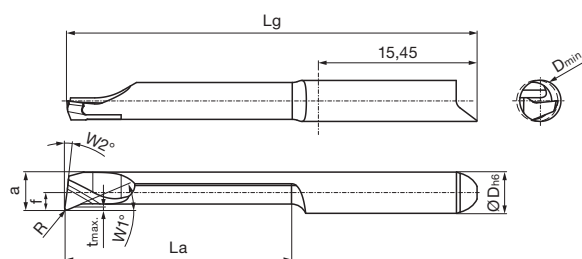

Right-hand design as shown. Left-hand design is mirror image.

Article no. **25092** **a**

Article no. **25096** ○

Dmin. mm	R mm	W1 °	W2 °	f mm	a mm	tmax. mm	La mm	Lg mm	D h6 mm	Code no.	Description
2.00	0.10	23	8	1.95	1.90	0.15	4.00	25.00	4.00	4.001	GJ104.2319.010.04.20.R
2.00	0.10	23	8	1.95	1.90	0.15	7.00	25.00	4.00	4.002	GJ104.2319.010.07.20.R
2.00	0.10	23	8	1.95	1.90	0.15	12.00	30.00	4.00	4.003	GJ104.2319.010.12.20.R
2.00	0.10	23	8	1.95	1.90	0.15	17.00	35.00	4.00	4.004	GJ104.2319.010.17.20.R
3.00	0.15	23	8	1.95	2.60	0.20	7.00	25.00	4.00	4.005	GJ104.2326.015.07.30.R
3.00	0.15	23	8	1.95	2.60	0.20	12.00	30.00	4.00	4.006	GJ104.2326.015.12.30.R
3.00	0.15	23	8	1.95	2.60	0.20	17.00	35.00	4.00	4.007	GJ104.2326.015.17.30.R
3.00	0.15	23	8	1.95	2.60	0.20	22.00	40.00	4.00	4.008	GJ104.2326.015.22.30.R
4.00	0.20	23	8	1.70	3.70	0.30	12.00	30.00	4.00	4.009	GJ104.2337.020.12.40.R
4.00	0.20	23	8	1.70	3.70	0.30	17.00	35.00	4.00	4.010	GJ104.2337.020.17.40.R
4.00	0.20	23	8	1.70	3.70	0.30	22.00	40.00	4.00	4.011	GJ104.2337.020.22.40.R
4.00	0.20	23	8	1.70	3.70	0.30	27.00	45.00	4.00	4.012	GJ104.2337.020.27.40.R
4.00	0.20	23	8	1.70	3.70	0.30	32.00	50.00	4.00	4.013	GJ104.2337.020.32.40.R

Article no. **25093** **a**

Article no. **25097** ○

On the left-hand design, the designation changes to .L



Cutting inserts for boring out and profiling

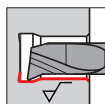

WIPER-geometry
for tool holders type GB106/GH106



P
M
K
N
S
H
VHM
GJ106
a

Cutting data page 1554



P
M
K
N
S
H
VHM
GJ106
○

Cutting data page 1554

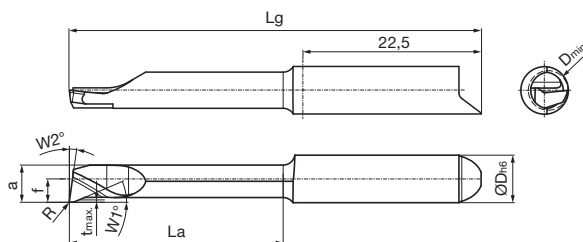

Right-hand design as shown. Left-hand design is mirror image.

Article no. **25850** a R

Article no. **25854** ○ R

Dmin. mm	R mm	W1 °	W2 °	f mm	a mm	tmax. mm	La mm	Lg mm	D h6 mm	Code no.	Description
5.00	0.05	23	8	2.95	4.70	0.30	12.00	37.00	6.00	6.010	GJ106.2347.005.12.50.R
5.00	0.05	23	8	2.95	4.70	0.30	17.00	42.00	6.00	6.020	GJ106.2347.005.17.50.R
5.00	0.05	23	8	2.95	4.70	0.30	22.00	47.00	6.00	6.030	GJ106.2347.005.22.50.R
5.00	0.05	23	8	2.95	4.70	0.30	27.00	52.00	6.00	6.040	GJ106.2347.005.27.50.R
5.00	0.05	23	8	2.95	4.70	0.30	32.00	57.00	6.00	6.050	GJ106.2347.005.32.50.R
5.00	0.05	23	8	2.95	4.70	0.30	37.00	62.00	6.00	6.060	GJ106.2347.005.37.50.R
5.00	0.05	23	8	2.95	4.70	0.30	42.00	67.00	6.00	6.070	GJ106.2347.005.42.50.R
5.00	0.10	23	8	2.95	4.70	0.30	12.00	37.00	6.00	6.110	GJ106.2347.010.12.50.R
5.00	0.10	23	8	2.95	4.70	0.30	17.00	42.00	6.00	6.120	GJ106.2347.010.17.50.R
5.00	0.10	23	8	2.95	4.70	0.30	22.00	47.00	6.00	6.130	GJ106.2347.010.22.50.R
5.00	0.10	23	8	2.95	4.70	0.30	27.00	52.00	6.00	6.140	GJ106.2347.010.27.50.R
5.00	0.10	23	8	2.95	4.70	0.30	32.00	57.00	6.00	6.150	GJ106.2347.010.32.50.R
5.00	0.10	23	8	2.95	4.70	0.30	37.00	62.00	6.00	6.160	GJ106.2347.010.37.50.R
5.00	0.10	23	8	2.95	4.70	0.30	42.00	67.00	6.00	6.170	GJ106.2347.010.42.50.R
5.00	0.15	23	8	2.95	4.70	0.30	12.00	37.00	6.00	6.210	GJ106.2347.015.12.50.R
5.00	0.15	23	8	2.95	4.70	0.30	17.00	42.00	6.00	6.220	GJ106.2347.015.17.50.R
5.00	0.15	23	8	2.95	4.70	0.30	22.00	47.00	6.00	6.230	GJ106.2347.015.22.50.R
5.00	0.15	23	8	2.95	4.70	0.30	27.00	52.00	6.00	6.240	GJ106.2347.015.27.50.R
5.00	0.15	23	8	2.95	4.70	0.30	32.00	57.00	6.00	6.250	GJ106.2347.015.32.50.R
5.00	0.15	23	8	2.95	4.70	0.30	37.00	62.00	6.00	6.260	GJ106.2347.015.37.50.R
5.00	0.15	23	8	2.95	4.70	0.30	42.00	67.00	6.00	6.270	GJ106.2347.015.42.50.R
5.00	0.20	23	8	2.95	4.70	0.30	12.00	37.00	6.00	6.310	GJ106.2347.020.12.50.R
5.00	0.20	23	8	2.95	4.70	0.30	17.00	42.00	6.00	6.320	GJ106.2347.020.17.50.R
5.00	0.20	23	8	2.95	4.70	0.30	22.00	47.00	6.00	6.330	GJ106.2347.020.22.50.R
5.00	0.20	23	8	2.95	4.70	0.30	27.00	52.00	6.00	6.340	GJ106.2347.020.27.50.R
5.00	0.20	23	8	2.95	4.70	0.30	32.00	57.00	6.00	6.350	GJ106.2347.020.32.50.R
5.00	0.20	23	8	2.95	4.70	0.30	37.00	62.00	6.00	6.360	GJ106.2347.020.37.50.R
5.00	0.20	23	8	2.95	4.70	0.30	42.00	67.00	6.00	6.370	GJ106.2347.020.42.50.R
5.00	0.30	23	8	2.95	4.70	0.30	12.00	37.00	6.00	6.410	GJ106.2347.030.12.50.R
5.00	0.30	23	8	2.95	4.70	0.30	17.00	42.00	6.00	6.420	GJ106.2347.030.17.50.R
5.00	0.30	23	8	2.95	4.70	0.30	22.00	47.00	6.00	6.430	GJ106.2347.030.22.50.R
5.00	0.30	23	8	2.95	4.70	0.30	27.00	52.00	6.00	6.440	GJ106.2347.030.27.50.R
5.00	0.30	23	8	2.95	4.70	0.30	32.00	57.00	6.00	6.450	GJ106.2347.030.32.50.R
5.00	0.30	23	8	2.95	4.70	0.30	37.00	62.00	6.00	6.460	GJ106.2347.030.37.50.R
5.00	0.30	23	8	2.95	4.70	0.30	42.00	67.00	6.00	6.470	GJ106.2347.030.42.50.R

Article no. **25851** a L

Article no. **25855** ○ L

On the left-hand design, the designation changes to .L

Boring out



Cutting inserts for boring out and profiling

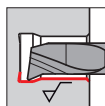

WIPER-geometry
for tool holders type GB106/GH106

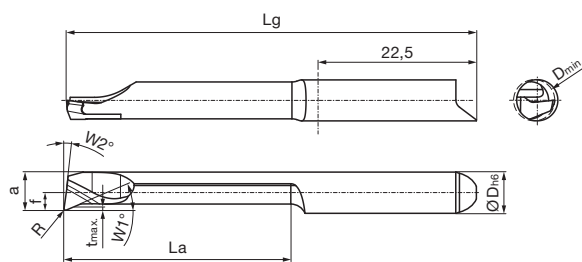
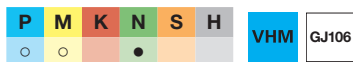

Right-hand design as shown. Left-hand design is mirror image.

Article no. **25718** **a** **(R)**

Article no. **25722** **○** **(R)**

Dmin. mm	R mm	W1 °	W2 °	f mm	a mm	tmax. mm	La mm	Lg mm	D h6 mm	Code no.	Description
6.00	0.05	23	8	2.70	5.70	0.30	12.00	37.00	6.00	6.019	GJ106.2357.005.12.60.R
6.00	0.05	23	8	2.70	5.70	0.30	17.00	42.00	6.00	6.020	GJ106.2357.005.17.60.R
6.00	0.05	23	8	2.70	5.70	0.30	22.00	47.00	6.00	6.021	GJ106.2357.005.22.60.R
6.00	0.05	23	8	2.70	5.70	0.30	27.00	52.00	6.00	6.022	GJ106.2357.005.27.60.R
6.00	0.05	23	8	2.70	5.70	0.30	32.00	57.00	6.00	6.023	GJ106.2357.005.32.60.R
6.00	0.05	23	8	2.70	5.70	0.30	37.00	62.00	6.00	6.024	GJ106.2357.005.37.60.R
6.00	0.05	23	8	2.70	5.70	0.30	42.00	67.00	6.00	6.025	GJ106.2357.005.42.60.R
6.00	0.05	23	8	2.70	5.70	0.30	47.00	72.00	6.00	6.026	GJ106.2357.005.47.60.R
6.00	0.05	23	8	2.70	5.70	0.30	52.00	77.00	6.00	6.027	GJ106.2357.005.52.60.R
6.00	0.15	23	8	2.70	5.70	0.30	12.00	37.00	6.00	6.013	GJ106.2357.015.12.60.R
6.00	0.15	23	8	2.70	5.70	0.30	17.00	42.00	6.00	6.014	GJ106.2357.015.17.60.R
6.00	0.15	23	8	2.70	5.70	0.30	22.00	47.00	6.00	6.015	GJ106.2357.015.22.60.R
6.00	0.15	23	8	2.70	5.70	0.30	27.00	52.00	6.00	6.001	GJ106.2357.015.27.60.R
6.00	0.15	23	8	2.70	5.70	0.30	32.00	57.00	6.00	6.002	GJ106.2357.015.32.60.R
6.00	0.15	23	8	2.70	5.70	0.30	37.00	62.00	6.00	6.003	GJ106.2357.015.37.60.R
6.00	0.15	23	8	2.70	5.70	0.30	42.00	67.00	6.00	6.004	GJ106.2357.015.42.60.R
6.00	0.15	23	8	2.70	5.70	0.30	47.00	72.00	6.00	6.005	GJ106.2357.015.47.60.R
6.00	0.15	23	8	2.70	5.70	0.30	52.00	77.00	6.00	6.006	GJ106.2357.015.52.60.R
6.00	0.20	23	8	2.70	5.70	0.30	12.00	37.00	6.00	6.028	GJ106.2357.020.12.60.R
6.00	0.20	23	8	2.70	5.70	0.30	17.00	42.00	6.00	6.029	GJ106.2357.020.17.60.R
6.00	0.20	23	8	2.70	5.70	0.30	22.00	47.00	6.00	6.030	GJ106.2357.020.22.60.R
6.00	0.20	23	8	2.70	5.70	0.30	27.00	52.00	6.00	6.031	GJ106.2357.020.27.60.R
6.00	0.20	23	8	2.70	5.70	0.30	32.00	57.00	6.00	6.032	GJ106.2357.020.32.60.R
6.00	0.20	23	8	2.70	5.70	0.30	37.00	62.00	6.00	6.033	GJ106.2357.020.37.60.R
6.00	0.20	23	8	2.70	5.70	0.30	42.00	67.00	6.00	6.034	GJ106.2357.020.42.60.R
6.00	0.20	23	8	2.70	5.70	0.30	47.00	72.00	6.00	6.035	GJ106.2357.020.47.60.R
6.00	0.20	23	8	2.70	5.70	0.30	52.00	77.00	6.00	6.036	GJ106.2357.020.52.60.R
6.00	0.30	23	8	2.70	5.70	0.30	12.00	37.00	6.00	6.016	GJ106.2357.030.12.60.R
6.00	0.30	23	8	2.70	5.70	0.30	17.00	42.00	6.00	6.017	GJ106.2357.030.17.60.R
6.00	0.30	23	8	2.70	5.70	0.30	22.00	47.00	6.00	6.018	GJ106.2357.030.22.60.R
6.00	0.30	23	8	2.70	5.70	0.30	27.00	52.00	6.00	6.007	GJ106.2357.030.27.60.R
6.00	0.30	23	8	2.70	5.70	0.30	32.00	57.00	6.00	6.008	GJ106.2357.030.32.60.R
6.00	0.30	23	8	2.70	5.70	0.30	37.00	62.00	6.00	6.009	GJ106.2357.030.37.60.R
6.00	0.30	23	8	2.70	5.70	0.30	42.00	67.00	6.00	6.010	GJ106.2357.030.42.60.R
6.00	0.30	23	8	2.70	5.70	0.30	47.00	72.00	6.00	6.011	GJ106.2357.030.47.60.R
6.00	0.30	23	8	2.70	5.70	0.30	52.00	77.00	6.00	6.012	GJ106.2357.030.52.60.R

Article no. **25719** **a** **(L)**

Article no. **25723** **○** **(L)**

On the left-hand design, the designation changes to .L



Cutting inserts for boring out and profiling

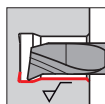

WIPER-geometry
for tool holders type GB108/GH108



P
M
K
N
S
H
VHM
GJ108
a

Cutting data page 1556



P
M
K
N
S
H
VHM
GJ108
a

Cutting data page 1556

Right-hand design as shown. Left-hand design is mirror image.

Dmin. mm	R mm	W1 °	W2 °	f mm	a mm	tmax. mm	La mm	Lg mm	D h6 mm	Code no.	Description
7.00	0.10	23	8	3.95	6.70	0.50	17.00	42.00	8.00	8.120	GJ108.2367.010.17.70.R
7.00	0.10	23	8	3.95	6.70	0.50	27.00	52.00	8.00	8.140	GJ108.2367.010.27.70.R
7.00	0.10	23	8	3.95	6.70	0.50	37.00	62.00	8.00	8.160	GJ108.2367.010.37.70.R
7.00	0.10	23	8	3.95	6.70	0.50	42.00	67.00	8.00	8.170	GJ108.2367.010.42.70.R
7.00	0.10	23	8	3.95	6.70	0.50	47.00	72.00	8.00	8.180	GJ108.2367.010.47.70.R
7.00	0.10	23	8	3.95	6.70	0.50	52.00	77.00	8.00	8.190	GJ108.2367.010.52.70.R
7.00	0.20	23	8	3.95	6.70	0.50	17.00	42.00	8.00	8.320	GJ108.2367.020.17.70.R
7.00	0.20	23	8	3.95	6.70	0.50	27.00	52.00	8.00	8.340	GJ108.2367.020.27.70.R
7.00	0.20	23	8	3.95	6.70	0.50	37.00	62.00	8.00	8.360	GJ108.2367.020.37.70.R
7.00	0.20	23	8	3.95	6.70	0.50	42.00	67.00	8.00	8.370	GJ108.2367.020.42.70.R
7.00	0.20	23	8	3.95	6.70	0.50	47.00	72.00	8.00	8.380	GJ108.2367.020.47.70.R
7.00	0.20	23	8	3.95	6.70	0.50	52.00	77.00	8.00	8.390	GJ108.2367.020.52.70.R

Article no. **27116** a R

Article no. **27118** L R

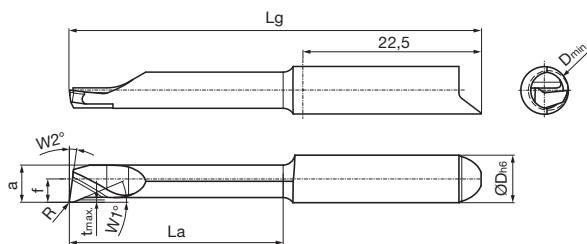

Article no. **27117** a L

Article no. **27119** L L

On the left-hand design, the designation changes to .L

Cutting inserts for boring out and profiling

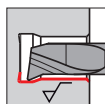

WIPER-geometry
for tool holders type GB108/GH108



P
M
K
N
S
H
VHM
GJ108
a

Cutting data page 1556



P
M
K
N
S
H
VHM
GJ108
a

Cutting data page 1556

Right-hand design as shown. Left-hand design is mirror image.

Dmin. mm	R mm	W1 °	W2 °	f mm	a mm	tmax. mm	La mm	Lg mm	D h6 mm	Code no.	Description
8.00	0.10	23	8	3.70	7.70	0.60	17.00	42.00	8.00	8.120	GJ108.2377.010.17.80.R
8.00	0.10	23	8	3.70	7.70	0.60	27.00	52.00	8.00	8.140	GJ108.2377.010.27.80.R
8.00	0.10	23	8	3.70	7.70	0.60	37.00	62.00	8.00	8.160	GJ108.2377.010.37.80.R
8.00	0.10	23	8	3.70	7.70	0.60	42.00	67.00	8.00	8.170	GJ108.2377.010.42.80.R
8.00	0.10	23	8	3.70	7.70	0.60	47.00	72.00	8.00	8.180	GJ108.2377.010.47.80.R
8.00	0.10	23	8	3.70	7.70	0.60	52.00	77.00	8.00	8.190	GJ108.2377.010.52.80.R
8.00	0.20	23	8	3.70	7.70	0.60	17.00	42.00	8.00	8.320	GJ108.2377.020.17.80.R
8.00	0.20	23	8	3.70	7.70	0.60	27.00	52.00	8.00	8.340	GJ108.2377.020.27.80.R
8.00	0.20	23	8	3.70	7.70	0.60	37.00	62.00	8.00	8.360	GJ108.2377.020.37.80.R
8.00	0.20	23	8	3.70	7.70	0.60	42.00	67.00	8.00	8.370	GJ108.2377.020.42.80.R
8.00	0.20	23	8	3.70	7.70	0.60	47.00	72.00	8.00	8.380	GJ108.2377.020.47.80.R
8.00	0.20	23	8	3.70	7.70	0.60	52.00	77.00	8.00	8.390	GJ108.2377.020.52.80.R

Article no. **27216** a R

Article no. **27218** L R

Article no. **27217** a L

Article no. **27219** L L

On the left-hand design, the designation changes to .L



Cutting inserts for back boring and profiling

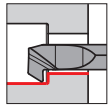

radial free 32°

for tool holders type GB104/GH104

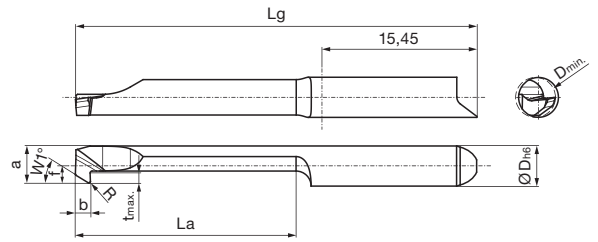
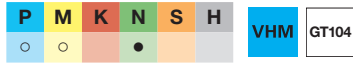

Right-hand design as shown. Left-hand design is mirror image.

Article no. **25108** **a** **(R)**

Article no. **25112** **○** **(R)**

Dmin. mm	b mm	R mm	W1 °	f mm	a mm	tmax. mm	La mm	Lg mm	D h6 mm	Code no.	Description
2.00	1.00	0.10	32	1.95	1.70	0.30	4.00	25.00	4.00	4.001	GT104.3217.010.04.20.R
2.00	1.00	0.10	32	1.95	1.70	0.30	7.00	25.00	4.00	4.002	GT104.3217.010.07.20.R
2.00	1.00	0.10	32	1.95	1.70	0.30	12.00	30.00	4.00	4.003	GT104.3217.010.12.20.R
2.00	1.00	0.10	32	1.95	1.70	0.30	17.00	35.00	4.00	4.004	GT104.3217.010.17.20.R
3.00	1.50	0.05	32	1.95	2.60	0.70	7.00	25.00	4.00	4.005	GT104.3226.005.07.30.R
3.00	1.50	0.05	32	1.95	2.60	0.70	12.00	30.00	4.00	4.006	GT104.3226.005.12.30.R
3.00	1.50	0.05	32	1.95	2.60	0.70	17.00	35.00	4.00	4.007	GT104.3226.005.17.30.R
3.00	1.50	0.05	32	1.95	2.60	0.70	22.00	40.00	4.00	4.008	GT104.3226.005.22.30.R
3.00	1.50	0.10	32	1.95	2.60	0.70	7.00	25.00	4.00	4.009	GT104.3226.010.07.30.R
3.00	1.50	0.10	32	1.95	2.60	0.70	12.00	30.00	4.00	4.010	GT104.3226.010.12.30.R
3.00	1.50	0.10	32	1.95	2.60	0.70	17.00	35.00	4.00	4.011	GT104.3226.010.17.30.R
3.00	1.50	0.10	32	1.95	2.60	0.70	22.00	40.00	4.00	4.012	GT104.3226.010.22.30.R
4.00	1.50	0.10	32	1.70	3.70	1.00	12.00	30.00	4.00	4.013	GT104.3237.010.12.40.R
4.00	1.50	0.10	32	1.70	3.70	1.00	17.00	35.00	4.00	4.014	GT104.3237.010.17.40.R
4.00	1.50	0.10	32	1.70	3.70	1.00	22.00	40.00	4.00	4.015	GT104.3237.010.22.40.R
4.00	1.50	0.10	32	1.70	3.70	1.00	27.00	45.00	4.00	4.016	GT104.3237.010.27.40.R
4.00	1.50	0.10	32	1.70	3.70	1.00	32.00	50.00	4.00	4.017	GT104.3237.010.32.40.R
4.00	1.50	0.15	32	1.70	3.70	1.00	12.00	30.00	4.00	4.018	GT104.3237.015.12.40.R
4.00	1.50	0.15	32	1.70	3.70	1.00	17.00	35.00	4.00	4.019	GT104.3237.015.17.40.R
4.00	1.50	0.15	32	1.70	3.70	1.00	22.00	40.00	4.00	4.020	GT104.3237.015.22.40.R
4.00	1.50	0.15	32	1.70	3.70	1.00	27.00	45.00	4.00	4.021	GT104.3237.015.27.40.R
4.00	1.50	0.15	32	1.70	3.70	1.00	32.00	50.00	4.00	4.022	GT104.3237.015.32.40.R

Article no. **25109** **a** **(L)**

On the left-hand design, the designation changes to .L

Article no. **25113** **○** **(L)**



Cutting inserts for back boring and profiling

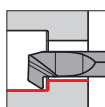

radial free 32°
for tool holders type GB106/GH106

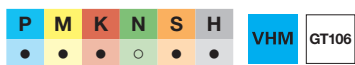

a Cutting data page 1559



○ Cutting data page 1559

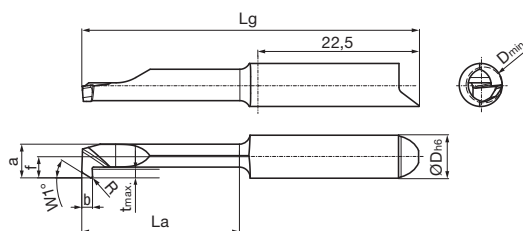

Right-hand design as shown. Left-hand design is mirror image.

Article no. **25858** **a**

Article no. **25862** ○

Dmin. mm	b mm	R mm	W1 °	f mm	a mm	tmax. mm	La mm	Lg mm	D h6 mm	Code no.	Description
5.00	1.50	0.20	32	2.95	4.70	1.20	12.00	37.00	6.00	6.010	GT106.3247.020.12.50.R
5.00	1.50	0.20	32	2.95	4.70	1.20	17.00	42.00	6.00	6.020	GT106.3247.020.17.50.R
5.00	1.50	0.20	32	2.95	4.70	1.20	22.00	47.00	6.00	6.030	GT106.3247.020.22.50.R
5.00	1.50	0.20	32	2.95	4.70	1.20	27.00	52.00	6.00	6.040	GT106.3247.020.27.50.R
5.00	1.50	0.20	32	2.95	4.70	1.20	32.00	57.00	6.00	6.050	GT106.3247.020.32.50.R
5.00	1.50	0.20	32	2.95	4.70	1.20	37.00	62.00	6.00	6.060	GT106.3247.020.37.50.R
5.00	1.50	0.20	32	2.95	4.70	1.20	42.00	67.00	6.00	6.070	GT106.3247.020.42.50.R

Article no. **25859** **a**

Article no. **25863** ○

On the left-hand design, the designation changes to .L



Cutting inserts for back boring and profiling

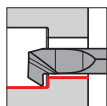

radial free 32°

for tool holders type GB106/GH106

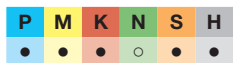

VHM

GT106



Cutting data page 1559



VHM

GT106



Cutting data page 1559

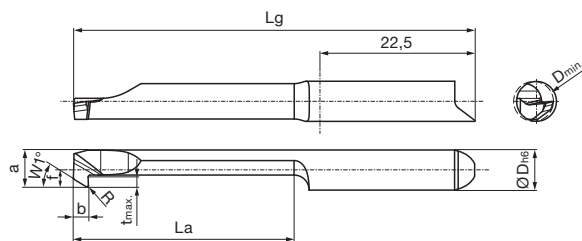

Right-hand design as shown. Left-hand design is mirror image.

Article no. **25734**



Article no. **25738**



Dmin. mm	b mm	R mm	W1 °	f mm	a mm	tmax. mm	La mm	Lg mm	D h6 mm	Code no.	Description
6.00	1.50	0.20	32	2.70	5.70	2.00	12.00	37.00	6.00	6.013	GT106.3257.020.12.60.R
6.00	1.50	0.20	32	2.70	5.70	2.00	17.00	42.00	6.00	6.014	GT106.3257.020.17.60.R
6.00	1.50	0.20	32	2.70	5.70	2.00	22.00	47.00	6.00	6.001	GT106.3257.020.22.60.R
6.00	1.50	0.20	32	2.70	5.70	2.00	32.00	57.00	6.00	6.002	GT106.3257.020.32.60.R
6.00	1.50	0.20	32	2.70	5.70	2.00	42.00	67.00	6.00	6.003	GT106.3257.020.42.60.R
6.00	1.50	0.20	32	2.70	5.70	2.00	52.00	77.00	6.00	6.004	GT106.3257.020.52.60.R

Article no. **25735**



On the left-hand design, the designation changes to .L

Article no. **25739**





Cutting inserts for back boring and profiling

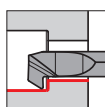

radial free 32°
for tool holders type GB108/GH108



P	M	K	N	S	H	VHM	GT108
•	•	•	○	•	•		

a Cutting data page 1560



P	M	K	N	S	H	VHM	GT108
○	○	•	•	•	•		

○ Cutting data page 1560

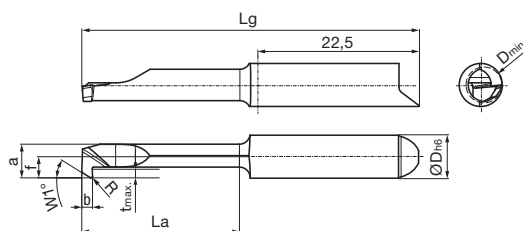

Right-hand design as shown. Left-hand design is mirror image.

Article no. **27120** **a** **R**

Article no. **27122** ○ **R**

Dmin. mm	b mm	R mm	W1 °	f mm	a mm	tmax. mm	La mm	Lg mm	D h6 mm	Code no.	Description
7.00	1.50	0.20	32	3.95	6.70	1.80	17.00	42.00	8.00	8.010	GT108.3267.020.17.70.R
7.00	1.50	0.20	32	3.95	6.70	1.80	27.00	52.00	8.00	8.020	GT108.3267.020.27.70.R
7.00	1.50	0.20	32	3.95	6.70	1.80	37.00	62.00	8.00	8.030	GT108.3267.020.37.70.R
7.00	1.50	0.20	32	3.95	6.70	1.80	42.00	67.00	8.00	8.040	GT108.3267.020.42.70.R
7.00	1.50	0.20	32	3.95	6.70	1.80	47.00	72.00	8.00	8.050	GT108.3267.020.47.70.R
7.00	1.50	0.20	32	3.95	6.70	1.80	52.00	77.00	8.00	8.060	GT108.3267.020.52.70.R

Article no. **27121** **a** **L**

Article no. **27123** ○ **L**

On the left-hand design, the designation changes to .L



Cutting inserts for back boring and profiling

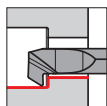

radial free 32°

for tool holders type GB108/GH108



VHM

GT108

a Cutting data page 1560



VHM

GT108

○ Cutting data page 1560

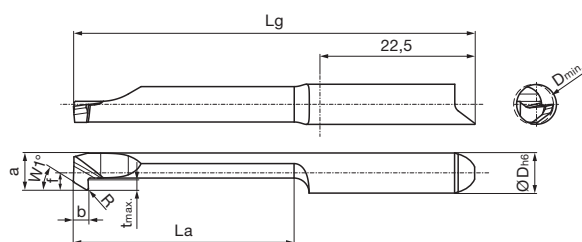

Right-hand design as shown. Left-hand design is mirror image.

Article no. **27220**



Article no. **27222**



Dmin. mm	b mm	R mm	W1 °	f mm	a mm	tmax. mm	La mm	Lg mm	D h6 mm	Code no.	Description
8.00	1.50	0.20	32	3.70	7.70	2.20	17.00	42.00	8.00	8.010	GT108.3277.020.17.80.R
8.00	1.50	0.20	32	3.70	7.70	2.20	27.00	52.00	8.00	8.020	GT108.3277.020.27.80.R
8.00	1.50	0.20	32	3.70	7.70	2.20	37.00	62.00	8.00	8.030	GT108.3277.020.37.80.R
8.00	1.50	0.20	32	3.70	7.70	2.20	42.00	67.00	8.00	8.040	GT108.3277.020.42.80.R
8.00	1.50	0.20	32	3.70	7.70	2.20	47.00	72.00	8.00	8.050	GT108.3277.020.47.80.R
8.00	1.50	0.20	32	3.70	7.70	2.20	52.00	77.00	8.00	8.060	GT108.3277.020.52.80.R

Article no. **27221**



On the left-hand design, the designation changes to .L

Article no. **27223**





Cutting inserts for boring out and chamfering

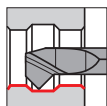

45° both sides
for tool holders type GB104/GH104



VHM

GT104



Cutting data page 1561

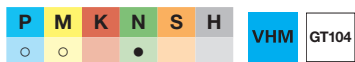

VHM

GT104



Cutting data page 1561

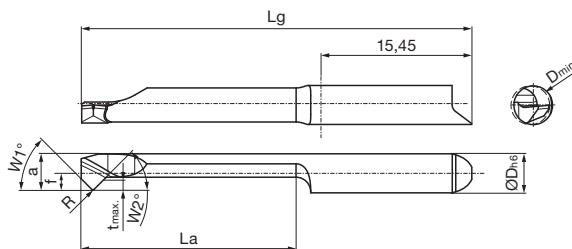

Right-hand design as shown. Left-hand design is mirror image.

Article no. **25116**



Article no. **25120**



Dmin. mm	R mm	W1 °	W2 °	f mm	a mm	tmax. mm	La mm	Lg mm	D h6 mm	Code no.	Description
2.00	0.10	45	45	1.95	1.80	0.50	4.00	25.00	4.00	4.001	GT104.4518.010.04.20.R
2.00	0.10	45	45	1.95	1.80	0.50	7.00	25.00	4.00	4.002	GT104.4518.010.07.20.R
2.00	0.10	45	45	1.95	1.80	0.50	12.00	30.00	4.00	4.003	GT104.4518.010.12.20.R
2.00	0.10	45	45	1.95	1.80	0.50	17.00	35.00	4.00	4.004	GT104.4518.010.17.20.R
3.00	0.10	45	45	1.95	2.70	0.70	7.00	25.00	4.00	4.005	GT104.4527.010.07.30.R
3.00	0.10	45	45	1.95	2.70	0.70	12.00	30.00	4.00	4.006	GT104.4527.010.12.30.R
3.00	0.10	45	45	1.95	2.70	0.70	17.00	35.00	4.00	4.007	GT104.4527.010.17.30.R
3.00	0.10	45	45	1.95	2.70	0.70	22.00	40.00	4.00	4.008	GT104.4527.010.22.30.R
4.00	0.15	45	45	1.70	3.70	1.00	12.00	30.00	4.00	4.009	GT104.4537.015.12.40.R
4.00	0.15	45	45	1.70	3.70	1.00	17.00	35.00	4.00	4.010	GT104.4537.015.17.40.R
4.00	0.15	45	45	1.70	3.70	1.00	22.00	40.00	4.00	4.011	GT104.4537.015.22.40.R
4.00	0.15	45	45	1.70	3.70	1.00	27.00	45.00	4.00	4.012	GT104.4537.015.27.40.R
4.00	0.15	45	45	1.70	3.70	1.00	32.00	50.00	4.00	4.013	GT104.4537.015.32.40.R

Article no. **25117**



Article no. **25121**



On the left-hand design, the designation changes to .L

Boring out



Cutting inserts for boring out and chamfering

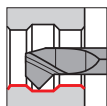

45° both sides

for tool holders type GB106/GH106

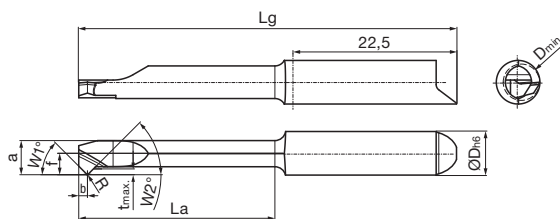

Right-hand design as shown. Left-hand design is mirror image.

Article no. **25866** **a** **R**

Article no. **25870** **○** **R**

Dmin. mm	R mm	W1 °	W2 °	f mm	a mm	tmax. mm	La mm	Lg mm	D h6 mm	Code no.	Description
5.00	0.10	45	45	2.95	4.70	0.80	12.00	37.00	6.00	6.010	GT106.4547.010.12.50.R
5.00	0.10	45	45	2.95	4.70	0.80	17.00	42.00	6.00	6.020	GT106.4547.010.17.50.R
5.00	0.10	45	45	2.95	4.70	0.80	22.00	47.00	6.00	6.030	GT106.4547.010.22.50.R
5.00	0.10	45	45	2.95	4.70	0.80	27.00	52.00	6.00	6.040	GT106.4547.010.27.50.R
5.00	0.10	45	45	2.95	4.70	0.80	32.00	57.00	6.00	6.050	GT106.4547.010.32.50.R
5.00	0.10	45	45	2.95	4.70	0.80	37.00	62.00	6.00	6.060	GT106.4547.010.37.50.R
5.00	0.10	45	45	2.95	4.70	0.80	42.00	67.00	6.00	6.070	GT106.4547.010.42.50.R
5.00	0.15	45	45	2.95	4.70	0.80	12.00	37.00	6.00	6.110	GT106.4547.015.12.50.R
5.00	0.15	45	45	2.95	4.70	0.80	17.00	42.00	6.00	6.120	GT106.4547.015.17.50.R
5.00	0.15	45	45	2.95	4.70	0.80	22.00	47.00	6.00	6.130	GT106.4547.015.22.50.R
5.00	0.15	45	45	2.95	4.70	0.80	27.00	52.00	6.00	6.140	GT106.4547.015.27.50.R
5.00	0.15	45	45	2.95	4.70	0.80	32.00	57.00	6.00	6.150	GT106.4547.015.32.50.R
5.00	0.15	45	45	2.95	4.70	0.80	37.00	62.00	6.00	6.160	GT106.4547.015.37.50.R
5.00	0.15	45	45	2.95	4.70	0.80	42.00	67.00	6.00	6.170	GT106.4547.015.42.50.R
5.00	0.20	45	45	2.95	4.70	0.80	12.00	37.00	6.00	6.210	GT106.4547.020.12.50.R
5.00	0.20	45	45	2.95	4.70	0.80	17.00	42.00	6.00	6.220	GT106.4547.020.17.50.R
5.00	0.20	45	45	2.95	4.70	0.80	22.00	47.00	6.00	6.230	GT106.4547.020.22.50.R
5.00	0.20	45	45	2.95	4.70	0.80	27.00	52.00	6.00	6.240	GT106.4547.020.27.50.R
5.00	0.20	45	45	2.95	4.70	0.80	32.00	57.00	6.00	6.250	GT106.4547.020.32.50.R
5.00	0.20	45	45	2.95	4.70	0.80	37.00	62.00	6.00	6.260	GT106.4547.020.37.50.R
5.00	0.20	45	45	2.95	4.70	0.80	42.00	67.00	6.00	6.270	GT106.4547.020.42.50.R
5.00	0.30	45	45	2.95	4.70	0.80	12.00	37.00	6.00	6.310	GT106.4547.030.12.50.R
5.00	0.30	45	45	2.95	4.70	0.80	17.00	42.00	6.00	6.320	GT106.4547.030.17.50.R
5.00	0.30	45	45	2.95	4.70	0.80	22.00	47.00	6.00	6.330	GT106.4547.030.22.50.R
5.00	0.30	45	45	2.95	4.70	0.80	27.00	52.00	6.00	6.340	GT106.4547.030.27.50.R
5.00	0.30	45	45	2.95	4.70	0.80	32.00	57.00	6.00	6.350	GT106.4547.030.32.50.R
5.00	0.30	45	45	2.95	4.70	0.80	37.00	62.00	6.00	6.360	GT106.4547.030.37.50.R
5.00	0.30	45	45	2.95	4.70	0.80	42.00	67.00	6.00	6.370	GT106.4547.030.42.50.R

Article no. **25867** **a** **L**

Article no. **25871** **○** **L**

On the left-hand design, the designation changes to .L



Cutting inserts for boring out and chamfering

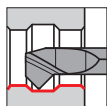

45° both sides
for tool holders type GB106/GH106



P
M
K
N
S
H
VHM
GT106
a

Cutting data page 1562



P
M
K
N
S
H
VHM
GT106
○

Cutting data page 1562

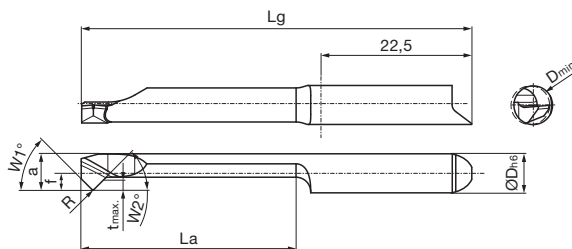

Right-hand design as shown. Left-hand design is mirror image.

Article no. **25742** a R

Article no. **25746** ○ R

Dmin. mm	R mm	W1 °	W2 °	f mm	a mm	tmax. mm	La mm	Lg mm	D h6 mm	Code no.	Description
6.00	0.10	45	45	2.70	5.70	1.00	12.00	37.00	6.00	6.019	GT106.4557.010.12.60.R
6.00	0.10	45	45	2.70	5.70	1.00	17.00	42.00	6.00	6.020	GT106.4557.010.17.60.R
6.00	0.10	45	45	2.70	5.70	1.00	22.00	47.00	6.00	6.021	GT106.4557.010.22.60.R
6.00	0.10	45	45	2.70	5.70	1.00	27.00	52.00	6.00	6.022	GT106.4557.010.27.60.R
6.00	0.10	45	45	2.70	5.70	1.00	32.00	57.00	6.00	6.023	GT106.4557.010.32.60.R
6.00	0.10	45	45	2.70	5.70	1.00	37.00	62.00	6.00	6.024	GT106.4557.010.37.60.R
6.00	0.10	45	45	2.70	5.70	1.00	42.00	67.00	6.00	6.025	GT106.4557.010.42.60.R
6.00	0.10	45	45	2.70	5.70	1.00	47.00	72.00	6.00	6.026	GT106.4557.010.47.60.R
6.00	0.10	45	45	2.70	5.70	1.00	52.00	77.00	6.00	6.027	GT106.4557.010.52.60.R
6.00	0.15	45	45	2.70	5.70	1.00	12.00	37.00	6.00	6.013	GT106.4557.015.12.60.R
6.00	0.15	45	45	2.70	5.70	1.00	17.00	42.00	6.00	6.014	GT106.4557.015.17.60.R
6.00	0.15	45	45	2.70	5.70	1.00	22.00	47.00	6.00	6.015	GT106.4557.015.22.60.R
6.00	0.15	45	45	2.70	5.70	1.00	27.00	52.00	6.00	6.001	GT106.4557.015.27.60.R
6.00	0.15	45	45	2.70	5.70	1.00	32.00	57.00	6.00	6.002	GT106.4557.015.32.60.R
6.00	0.15	45	45	2.70	5.70	1.00	37.00	62.00	6.00	6.003	GT106.4557.015.37.60.R
6.00	0.15	45	45	2.70	5.70	1.00	42.00	67.00	6.00	6.004	GT106.4557.015.42.60.R
6.00	0.15	45	45	2.70	5.70	1.00	47.00	72.00	6.00	6.005	GT106.4557.015.47.60.R
6.00	0.15	45	45	2.70	5.70	1.00	52.00	77.00	6.00	6.006	GT106.4557.015.52.60.R
6.00	0.20	45	45	2.70	5.70	1.00	12.00	37.00	6.00	6.028	GT106.4557.020.12.60.R
6.00	0.20	45	45	2.70	5.70	1.00	17.00	42.00	6.00	6.029	GT106.4557.020.17.60.R
6.00	0.20	45	45	2.70	5.70	1.00	22.00	47.00	6.00	6.030	GT106.4557.020.22.60.R
6.00	0.20	45	45	2.70	5.70	1.00	27.00	52.00	6.00	6.031	GT106.4557.020.27.60.R
6.00	0.20	45	45	2.70	5.70	1.00	32.00	57.00	6.00	6.032	GT106.4557.020.32.60.R
6.00	0.20	45	45	2.70	5.70	1.00	37.00	62.00	6.00	6.033	GT106.4557.020.37.60.R
6.00	0.20	45	45	2.70	5.70	1.00	42.00	67.00	6.00	6.034	GT106.4557.020.42.60.R
6.00	0.20	45	45	2.70	5.70	1.00	47.00	72.00	6.00	6.035	GT106.4557.020.47.60.R
6.00	0.20	45	45	2.70	5.70	1.00	52.00	77.00	6.00	6.036	GT106.4557.020.52.60.R
6.00	0.30	45	45	2.70	5.70	1.00	12.00	37.00	6.00	6.016	GT106.4557.030.12.60.R
6.00	0.30	45	45	2.70	5.70	1.00	17.00	42.00	6.00	6.017	GT106.4557.030.17.60.R
6.00	0.30	45	45	2.70	5.70	1.00	22.00	47.00	6.00	6.018	GT106.4557.030.22.60.R
6.00	0.30	45	45	2.70	5.70	1.00	27.00	52.00	6.00	6.007	GT106.4557.030.27.60.R
6.00	0.30	45	45	2.70	5.70	1.00	32.00	57.00	6.00	6.008	GT106.4557.030.32.60.R
6.00	0.30	45	45	2.70	5.70	1.00	37.00	62.00	6.00	6.009	GT106.4557.030.37.60.R
6.00	0.30	45	45	2.70	5.70	1.00	42.00	67.00	6.00	6.010	GT106.4557.030.42.60.R
6.00	0.30	45	45	2.70	5.70	1.00	47.00	72.00	6.00	6.011	GT106.4557.030.47.60.R
6.00	0.30	45	45	2.70	5.70	1.00	52.00	77.00	6.00	6.012	GT106.4557.030.52.60.R

Article no. **25743** a L

Article no. **25747** ○ L

On the left-hand design, the designation changes to .L



Cutting inserts for drilling into solid material and boring out Quattro Drill

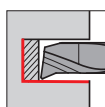

face flat 90°

drilling depth 2.5xD and 4.0xD • for tool holders type GB106, art. nr. 25325 • 4 applications: drilling into solid material, boring out, chamfering, turning



VHM QG106

Y Cutting data page 1563

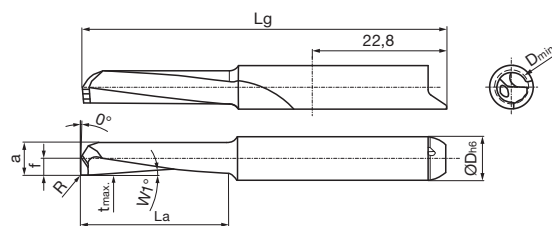

Article no. **26906**



Dmin. mm	R mm	W1 °	f mm	a mm	tmax. mm	La mm	Lg mm	D h6 mm	Code no.	Description
4.00	0.20	5	2.00	3.80	0.20	11.00	47.00	6.00	6.001	QG106.0538.020.11.40.R
4.00	0.20	5	2.00	3.80	0.20	17.00	52.00	6.00	6.002	QG106.0538.020.17.40.R
5.00	0.20	5	2.50	4.80	0.20	13.50	47.00	6.00	6.003	QG106.0548.020.13.50.R
5.00	0.20	5	2.50	4.80	0.20	21.00	52.00	6.00	6.004	QG106.0548.020.21.50.R

Cutting inserts for drilling into solid material and boring out Quattro Drill

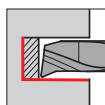

face flat 90°

drilling depth 2.5xD and 4.0xD • for tool holders type GB108, art. Nr. 27018 • 4 applications: drilling into solid material, boring out, chamfering, turning



VHM QG108

Y Cutting data page 1563

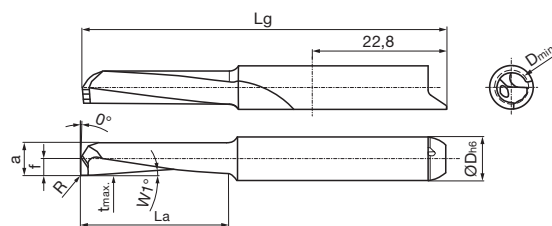

Article no. **27290**



Dmin. mm	R mm	W1 °	f mm	a mm	tmax. mm	La mm	Lg mm	D h6 mm	Code no.	Description
6.00	0.20	5	3.00	5.80	0.20	16.00	52.00	8.00	8.001	QG108.0558.020.16.60.R
6.00	0.20	5	3.00	5.80	0.20	25.00	62.00	8.00	8.002	QG108.0558.020.25.60.R
7.00	0.20	5	3.50	6.80	0.20	18.50	57.00	8.00	8.003	QG108.0568.020.18.70.R
7.00	0.20	5	3.50	6.80	0.20	29.00	67.00	8.00	8.004	QG108.0568.020.29.70.R



Cutting inserts for internal threading, part profile - metric standard threads

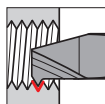

pitch P = 0.4-1.0
for tool holders type GB104/GH104



P
M
K
N
S
H
VHM
GG104
a Cutting data page 1564



P
M
K
N
S
H
VHM
GG104
○ Cutting data page 1564

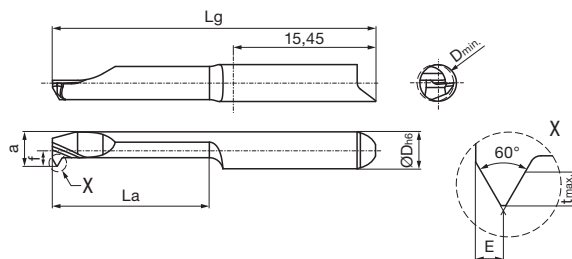

Right-hand design as shown. Left-hand design is mirror image.

Article no. **25150** a R

Article no. **25154** ○ R

G	P mm	Dmin. mm	f mm	tmax. mm	a mm	E mm	La mm	Lg mm	D h6 mm	Code no.	Description
M2/M2,5	0,40-0,45	1.50	1.95	0.25	1.40	0.25	4.00	25.00	4.00	4.001	GG104.TM02.040.04.15.R
M2/M2,5	0,40-0,45	1.50	1.95	0.25	1.40	0.25	7.00	25.00	4.00	4.002	GG104.TM02.040.07.15.R
M2/M2,5	0,40-0,45	1.50	1.95	0.25	1.40	0.25	12.00	30.00	4.00	4.003	GG104.TM02.040.12.15.R
M3	0,500	2.50	1.95	0.30	2.20	0.30	4.00	25.00	4.00	4.004	GG104.TM03.050.04.25.R
M3	0,500	2.50	1.95	0.30	2.20	0.30	7.00	25.00	4.00	4.005	GG104.TM03.050.07.25.R
M3	0,500	2.50	1.95	0.30	2.20	0.30	12.00	30.00	4.00	4.006	GG104.TM03.050.12.25.R
M4	0,700	3.30	1.95	0.40	3.00	0.40	7.00	25.00	4.00	4.007	GG104.TM04.070.07.33.R
M4	0,700	3.30	1.95	0.40	3.00	0.40	12.00	30.00	4.00	4.008	GG104.TM04.070.12.33.R
M4	0,700	3.30	1.95	0.40	3.00	0.40	17.00	35.00	4.00	4.009	GG104.TM04.070.17.33.R
M5/M6	0,80-1,00	4.00	1.70	0.60	3.70	0.50	12.00	30.00	4.00	4.010	GG104.TM05.080.12.40.R
M5/M6	0,80-1,00	4.00	1.70	0.60	3.70	0.50	17.00	35.00	4.00	4.011	GG104.TM05.080.17.40.R
M5/M6	0,80-1,00	4.00	1.70	0.60	3.70	0.50	22.00	40.00	4.00	4.012	GG104.TM05.080.22.40.R

Article no. **25151** a L

Article no. **25155** ○ L

On the left-hand design, the designation changes to .L



Cutting inserts for internal threading, part profile - metric standard threads

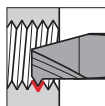

pitch P = 1.25-1.75

for tool holders type GB106/GH106

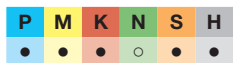

VHM

GG106



Cutting data page 1564



VHM

GG106



Cutting data page 1564

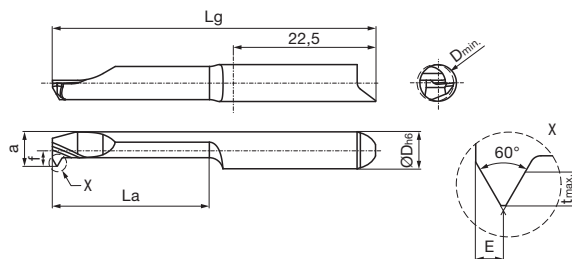

Article no. **25766**



Article no. **25770**



Right-hand design as shown. Left-hand design is mirror image.

G	P mm	Dmin. mm	f mm	tmax. mm	a mm	E mm	La mm	Lg mm	D h6 mm	Code no.	Description
M8	1.25	6.80	2.95	0.70	5.95	0.70	17.00	42.00	6.00	6.001	GG106.TM08.125.17.68.R
M8	1.25	6.80	2.95	0.70	5.95	0.70	22.00	47.00	6.00	6.002	GG106.TM08.125.22.68.R
M8	1.25	6.80	2.95	0.70	5.95	0.70	27.00	52.00	6.00	6.003	GG106.TM08.125.27.68.R
M8	1.25	6.80	2.95	0.70	5.95	0.70	12.00	37.00	6.00	6.010	GG106.TM08.125.12.68.R
M8	1.25	6.80	2.95	0.70	5.95	0.70	32.00	57.00	6.00	6.011	GG106.TM08.125.32.68.R
M8	1.25	6.80	2.95	0.70	5.95	0.70	37.00	62.00	6.00	6.012	GG106.TM08.125.37.68.R
M8	1.25	6.80	2.95	0.70	5.95	0.70	42.00	67.00	6.00	6.013	GG106.TM08.125.42.68.R
M10	1.50	8.50	2.95	0.85	5.95	0.85	17.00	42.00	6.00	6.004	GG106.TM10.150.17.85.R
M10	1.50	8.50	2.95	0.85	5.95	0.85	22.00	47.00	6.00	6.005	GG106.TM10.150.22.85.R
M10	1.50	8.50	2.95	0.85	5.95	0.85	27.00	52.00	6.00	6.006	GG106.TM10.150.27.85.R
M10	1.50	8.50	2.95	0.85	5.95	0.85	12.00	37.00	6.00	6.014	GG106.TM10.150.12.85.R
M10	1.50	8.50	2.95	0.85	5.95	0.85	32.00	57.00	6.00	6.015	GG106.TM10.150.32.85.R
M10	1.50	8.50	2.95	0.85	5.95	0.85	37.00	62.00	6.00	6.016	GG106.TM10.150.37.85.R
M10	1.50	8.50	2.95	0.85	5.95	0.85	42.00	67.00	6.00	6.017	GG106.TM10.150.42.85.R
M12	1.75	10.20	2.95	1.00	5.95	1.00	17.00	42.00	6.00	6.007	GG106.TM12.175.17.99.R
M12	1.75	10.20	2.95	1.00	5.95	1.00	22.00	47.00	6.00	6.008	GG106.TM12.175.22.99.R
M12	1.75	10.20	2.95	1.00	5.95	1.00	27.00	52.00	6.00	6.009	GG106.TM12.175.27.99.R
M12	1.75	10.20	2.95	1.00	5.95	1.00	12.00	37.00	6.00	6.018	GG106.TM12.175.12.99.R
M12	1.75	10.20	2.95	1.00	5.95	1.00	32.00	57.00	6.00	6.019	GG106.TM12.175.32.99.R
M12	1.75	10.20	2.95	1.00	5.95	1.00	37.00	62.00	6.00	6.020	GG106.TM12.175.37.99.R
M12	1.75	10.20	2.95	1.00	5.95	1.00	42.00	67.00	6.00	6.021	GG106.TM12.175.42.99.R

Article no. **25767**



Article no. **25771**



On the left-hand design, the designation changes to .L



Cutting inserts for internal threading, part profile - metric standard threads

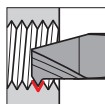

pitch P = 1.5-1.75
for tool holders type GB108/GH108



VHM GG108

a Cutting data page 1564



VHM GG108

○ Cutting data page 1564

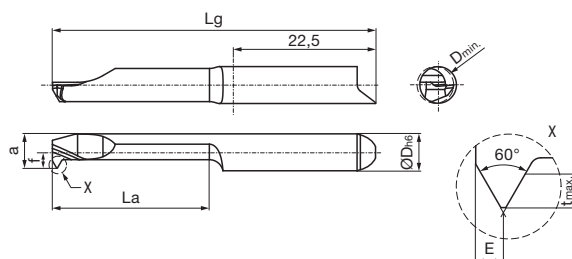

Right-hand design as shown. Left-hand design is mirror image.

Article no. **27132** **a** **R**

Article no. **27134** ○ **R**

G	P mm	Dmin. mm	f mm	tmax. mm	a mm	E mm	La mm	Lg mm	D h6 mm	Code no.	Description
M10	1.50	8.50	3.95	0.90	7.95	0.90	17.00	42.00	8.00	8.001	GG108.TM10.150.17.85.R
M10	1.50	8.50	3.95	0.90	7.95	0.90	27.00	52.00	8.00	8.002	GG108.TM10.150.27.85.R
M10	1.50	8.50	3.95	0.90	7.95	0.90	37.00	62.00	8.00	8.003	GG108.TM10.150.17.85.R
M10	1.50	8.50	3.95	0.90	7.95	0.90	37.00	62.00	8.00	8.003	GG108.TM10.150.37.85.R
M12	1.75	10.20	3.95	1.05	7.95	1.00	17.00	42.00	8.00	8.004	GG108.TM12.175.17.00.R
M12	1.75	10.20	3.95	1.05	7.95	1.00	27.00	52.00	8.00	8.005	GG108.TM12.175.27.00.R
M12	1.75	10.20	3.95	1.05	7.95	1.00	37.00	62.00	8.00	8.006	GG108.TM12.175.37.00.R

Article no. **27133** **a** **L**

Article no. **27135** ○ **L**

On the left-hand design, the designation changes to .L



Cutting inserts for internal threading, part profile - metric fine threads

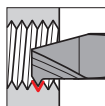

pitch $P = 0.2-0.5$
for tool holders type GB104/GH104



P	M	K	N	S	H	VHM	GG104
●	●	●	○	●	●		

a Cutting data page 1564



P	M	K	N	S	H	VHM	GG104
○	○	●	●	○	○		

○ Cutting data page 1564

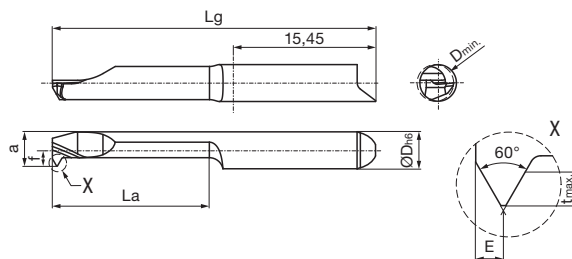

Article no. **25158**



Article no. **25162**



Right-hand design as shown. Left-hand design is mirror image.

G	P mm	Dmin. mm	f mm	tmax. mm	a mm	E mm	La mm	Lg mm	D h6 mm	Code no.	Description
M2/M3	0,20-0,30	1.70	1.95	0.20	1.55	0.20	4.00	25.00	4.00	4.001	GG104.TM02.020.04.17.R
M2/M3	0,20-0,30	1.70	1.95	0.20	1.55	0.20	7.00	25.00	4.00	4.002	GG104.TM02.020.07.17.R
M2/M3	0,20-0,30	1.70	1.95	0.20	1.55	0.20	12.00	30.00	4.00	4.003	GG104.TM02.020.12.17.R
M4/M5	0,35-0,50	3.50	1.95	0.30	3.20	0.35	7.00	25.00	4.00	4.004	GG104.TM04.035.07.35.R
M4/M5	0,35-0,50	3.50	1.95	0.30	3.20	0.35	12.00	30.00	4.00	4.005	GG104.TM04.035.12.35.R
M4/M5	0,35-0,50	3.50	1.95	0.30	3.20	0.35	17.00	35.00	4.00	4.006	GG104.TM04.035.17.35.R

Article no. **25159**



Article no. **25163**



On the left-hand design, the designation changes to .L



Cutting inserts for internal threading, full profile - metric standard threads

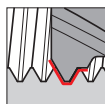

pitch P = 0.4-0.8
for tool holders type GB104/GH104



VHM GG104

a Cutting data page 1564



VHM GG104

○ Cutting data page 1564

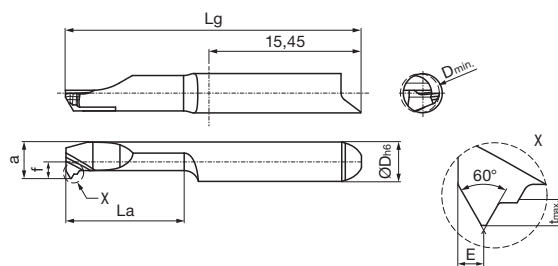

Right-hand design as shown. Left-hand design is mirror image.

Article no. **25166** **a**

Article no. **25170** ○

G	P mm	Dmin. mm	f mm	tmax. mm	a mm	E mm	La mm	Lg mm	D h6 mm	Code no.	Description
M2	0.40	1.50	1.95	0.25	1.35	0.20	4.00	25.00	4.00	4.001	GG104.VM02.040.04.15.R
M2	0.40	1.50	1.95	0.25	1.35	0.20	7.00	25.00	4.00	4.002	GG104.VM02.040.07.15.R
M2	0.40	1.50	1.95	0.25	1.35	0.20	12.00	30.00	4.00	4.003	GG104.VM02.040.12.15.R
M3	0.50	2.40	1.95	0.35	1.95	0.30	4.00	25.00	4.00	4.004	GG104.VM03.050.04.24.R
M3	0.50	2.40	1.95	0.35	1.95	0.30	7.00	25.00	4.00	4.005	GG104.VM03.050.07.24.R
M3	0.50	2.40	1.95	0.35	1.95	0.30	12.00	30.00	4.00	4.006	GG104.VM03.050.12.24.R
M4	0.70	3.10	1.95	0.45	2.80	0.40	7.00	25.00	4.00	4.007	GG104.VM04.070.07.31.R
M4	0.70	3.10	1.95	0.45	2.80	0.40	12.00	30.00	4.00	4.008	GG104.VM04.070.12.31.R
M4	0.70	3.10	1.95	0.45	2.80	0.40	17.00	35.00	4.00	4.009	GG104.VM04.070.17.31.R
M4	0.70	3.10	1.95	0.45	2.80	0.40	22.00	40.00	4.00	4.010	GG104.VM04.070.22.31.R
M5	0.80	4.00	1.70	0.50	3.70	0.50	12.00	30.00	4.00	4.011	GG104.VM05.080.12.40.R
M5	0.80	4.00	1.70	0.50	3.70	0.50	17.00	35.00	4.00	4.012	GG104.VM05.080.17.40.R
M5	0.80	4.00	1.70	0.50	3.70	0.50	22.00	40.00	4.00	4.013	GG104.VM05.080.22.40.R
M5	0.80	4.00	1.70	0.50	3.70	0.50	27.00	45.00	4.00	4.014	GG104.VM05.080.27.40.R

Article no. **25167** **a**

Article no. **25171** ○

On the left-hand design, the designation changes to .L



Cutting inserts for internal threading, full profile - metric standard threads

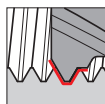

pitch $P = 1.0-1.75$
for tool holders type GB106/GH106



VHM GG106

a Cutting data page 1564



VHM GG106

○ Cutting data page 1564

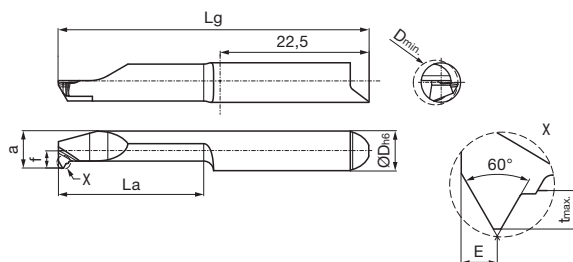

Right-hand design as shown. Left-hand design is mirror image.

Article no. **25774**



Article no. **25778**



G	P mm	Dmin. mm	f mm	tmax. mm	a mm	E mm	La mm	Lg mm	D h6 mm	Code no.	Description
M6	1.00	5.00	2.95	0.60	4.50	0.50	12.00	37.00	6.00	6.010	GG106.VM06.100.12.50.R
M6	1.00	5.00	2.95	0.60	4.50	0.50	17.00	42.00	6.00	6.020	GG106.VM06.100.17.50.R
M6	1.00	5.00	2.95	0.60	4.50	0.50	22.00	47.00	6.00	6.030	GG106.VM06.100.22.50.R
M6	1.00	5.00	2.95	0.60	4.50	0.50	27.00	52.00	6.00	6.040	GG106.VM06.100.27.50.R
M6	1.00	5.00	2.95	0.60	4.50	0.50	32.00	57.00	6.00	6.050	GG106.VM06.100.32.50.R
M6	1.00	5.00	2.95	0.60	4.50	0.50	37.00	62.00	6.00	6.060	GG106.VM06.100.37.50.R
M6	1.00	5.00	2.95	0.60	4.50	0.50	42.00	67.00	6.00	6.070	GG106.VM06.100.42.50.R
M8	1.25	6.80	2.95	0.75	5.95	0.70	12.00	37.00	6.00	6.110	GG106.VM08.125.12.68.R
M8	1.25	6.80	2.95	0.75	5.95	0.70	17.00	42.00	6.00	6.120	GG106.VM08.125.17.68.R
M8	1.25	6.80	2.95	0.75	5.95	0.70	22.00	47.00	6.00	6.130	GG106.VM08.125.22.68.R
M8	1.25	6.80	2.95	0.75	5.95	0.70	27.00	52.00	6.00	6.140	GG106.VM08.125.27.68.R
M8	1.25	6.80	2.95	0.75	5.95	0.70	32.00	57.00	6.00	6.150	GG106.VM08.125.32.68.R
M8	1.25	6.80	2.95	0.75	5.95	0.70	37.00	62.00	6.00	6.160	GG106.VM08.125.37.68.R
M8	1.25	6.80	2.95	0.75	5.95	0.70	42.00	67.00	6.00	6.170	GG106.VM08.125.42.68.R
M10	1.50	8.50	2.95	0.90	5.95	0.90	12.00	37.00	6.00	6.210	GG106.VM10.150.12.85.R
M10	1.50	8.50	2.95	0.90	5.95	0.90	17.00	42.00	6.00	6.220	GG106.VM10.150.17.85.R
M10	1.50	8.50	2.95	0.90	5.95	0.90	22.00	47.00	6.00	6.230	GG106.VM10.150.22.85.R
M10	1.50	8.50	2.95	0.90	5.95	0.90	27.00	52.00	6.00	6.240	GG106.VM10.150.27.85.R
M10	1.50	8.50	2.95	0.90	5.95	0.90	32.00	57.00	6.00	6.250	GG106.VM10.150.32.85.R
M10	1.50	8.50	2.95	0.90	5.95	0.90	37.00	62.00	6.00	6.260	GG106.VM10.150.37.85.R
M10	1.50	8.50	2.95	0.90	5.95	0.90	42.00	67.00	6.00	6.270	GG106.VM10.150.42.85.R
M12	1.75	10.20	2.95	1.05	5.95	0.90	12.00	37.00	6.00	6.310	GG106.VM12.175.12.00.R
M12	1.75	10.20	2.95	1.05	5.95	0.90	17.00	42.00	6.00	6.320	GG106.VM12.175.17.00.R
M12	1.75	10.20	2.95	1.05	5.95	0.90	22.00	47.00	6.00	6.330	GG106.VM12.175.22.00.R
M12	1.75	10.20	2.95	1.05	5.95	0.90	27.00	52.00	6.00	6.340	GG106.VM12.175.27.00.R
M12	1.75	10.20	2.95	1.05	5.95	0.90	32.00	57.00	6.00	6.350	GG106.VM12.175.32.00.R
M12	1.75	10.20	2.95	1.05	5.95	0.90	37.00	62.00	6.00	6.360	GG106.VM12.175.37.00.R
M12	1.75	10.20	2.95	1.05	5.95	0.90	42.00	67.00	6.00	6.370	GG106.VM12.175.42.00.R

Article no. **25775**



On the left-hand design, the designation changes to .L

Article no. **25779**





Cutting inserts for internal threading, full profile - metric standard threads

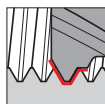

pitch P = 1.5-1.75
for tool holders type GB108/GH108



VHM

GG108

a Cutting data page 1564



VHM

GG108

○ Cutting data page 1564

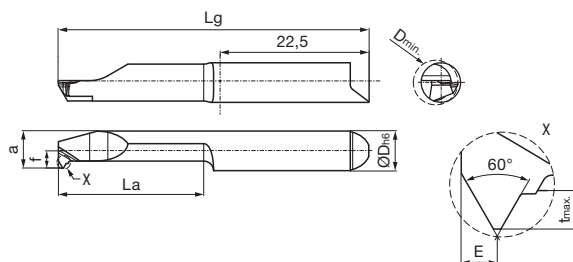

Right-hand design as shown. Left-hand design is mirror image.

Article no. **27136**



Article no. **27138**



G	P mm	Dmin. mm	f mm	tmax. mm	a mm	E mm	La mm	Lg mm	D h6 mm	Code no.	Description
M10	1.50	8.50	3.95	0.90	7.95	0.90	17.00	42.00	8.00	8.001	GG108.VM10.150.17.85.R
M10	1.50	8.50	3.95	0.90	7.95	0.90	27.00	52.00	8.00	8.002	GG108.VM10.150.27.85.R
M10	1.50	8.50	3.95	0.90	7.95	0.90	37.00	62.00	8.00	8.003	GG108.VM10.150.17.85.R
M12	1.75	10.20	3.95	1.05	7.95	1.00	17.00	42.00	8.00	8.004	GG108.VM12.175.17.00.R
M12	1.75	10.20	3.95	1.05	7.95	1.00	27.00	52.00	8.00	8.005	GG108.VM12.175.27.00.R
M12	1.75	10.20	3.95	1.05	7.95	1.00	37.00	62.00	8.00	8.006	GG108.VM12.175.37.00.R

Article no. **27137**



On the left-hand design, the designation changes to .L

Article no. **27139**





Cutting inserts for internal threading, part profile - UN threads

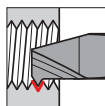

pitch 32-40 thread/inch
for tool holders type GB104/GH104



Cutting data page 1564

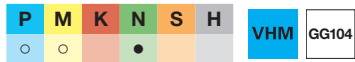

Cutting data page 1564

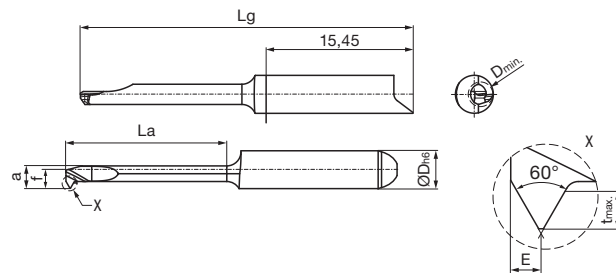

Right-hand design as shown. Left-hand design is mirror image.

Article no. **25174**

Article no. **25178**

P	Dmin.	f	tmax.	a	E	La	Lg	D h6	Code no.	Description
G/inch	mm	mm	mm	mm	mm	mm	mm	mm		
32-40	2.60	1.95	0.55	2.35	0.45	17.00	35.00	4.00	4.001	GG104.TU32.040.17.26.R

Article no. **25175**

On the left-hand design, the designation changes to .L

Article no. **25179**



Cutting inserts for internal threading, full profile - Whitworth pipe threads

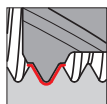

pitch 24-28 thread/inch
for tool holders type GB104/GH104



P	M	K	N	S	H	VHM	GG104	a
•	•	•	○	•	•			

Cutting data page 1564



P	M	K	N	S	H	VHM	GG104	○
○	○	•	•	•	•			

Cutting data page 1564

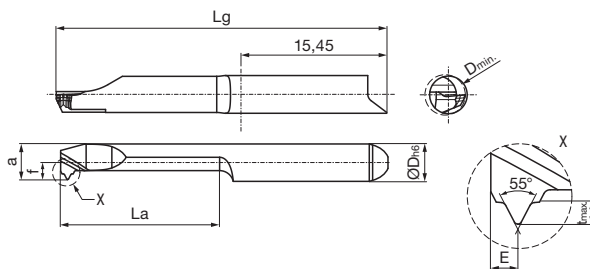

Right-hand design as shown. Left-hand design is mirror image.

Article no. **25182** **a** **R**

Article no. **25186** ○ **R**

P G/inch	Dmin. mm	f mm	tmax. mm	a mm	E mm	La mm	Lg mm	D h6 mm	Code no.	Description
28	4.30	1.80	0.65	3.80	0.75	17.00	35.00	4.00	4.001	GG104.VW28.091.17.43.R
26	4.90	1.95	0.70	3.95	0.80	17.00	35.00	4.00	4.002	GG104.VW26.098.17.49.R
24	3.30	1.95	0.75	3.00	0.80	17.00	35.00	4.00	4.003	GG104.VW24.106.17.33.R

Article no. **25183** **a** **L**

Article no. **25187** ○ **L**

On the left-hand design, the designation changes to .L



Cutting inserts for internal threading, part profile - trapezoidal thread

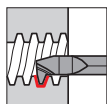

pitch P = 1.5-3.0

for tool holders type GB106/GH106



P	M	K	N	S	H	VHM	GG106	a	Cutting data page 1564
●	●	●	○	●	●				



P	M	K	N	S	H	VHM	GG106	○	Cutting data page 1564
○	○	●	●	○	●				

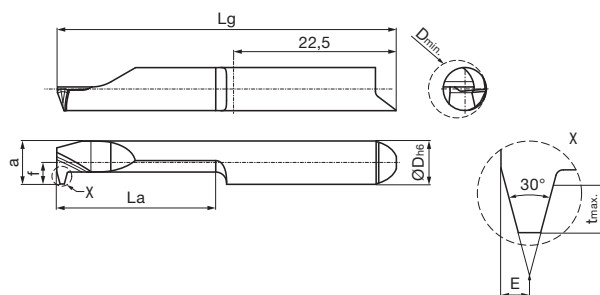

Article no. **25826**



Article no. **25830**



Right-hand design as shown. Left-hand design is mirror image.

G	P mm	Dmin. mm	f mm	E mm	a mm	tmax. mm	La mm	Lg mm	D h6 mm	Code no.	Description
Tr8	1.50	6.50	2.95	0.60	5.95	0.90	22.00	47.00	6.00	6.001	GG106.TT08.150.22.65.R
Tr8	2.00	6.00	2.70	0.75	5.70	1.25	22.00	47.00	6.00	6.002	GG106.TT08.200.22.60.R
Tr10	2.00	8.00	2.95	0.75	5.95	1.25	22.00	47.00	6.00	6.003	GG106.TT10.200.22.80.R
Tr10	2.00	8.00	2.95	0.75	5.95	1.25	32.00	57.00	6.00	6.004	GG106.TT10.200.32.80.R
Tr10	3.00	7.00	2.95	1.10	5.95	1.75	22.00	47.00	6.00	6.005	GG106.TT10.300.22.70.R
Tr10	3.00	7.00	2.95	1.10	5.95	1.75	32.00	57.00	6.00	6.006	GG106.TT10.300.32.70.R

Article no. **25827**



Article no. **25831**



On the left-hand design, the designation changes to .L



Indexable inserts for threading, part profile, external

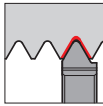

pitch P = 1.0-6.0

ground chip breaker • geometry .AA ground • pay attention to assignment holder/insert seat size 04/06 • for tool holders type GH305, size 04/06

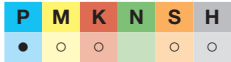
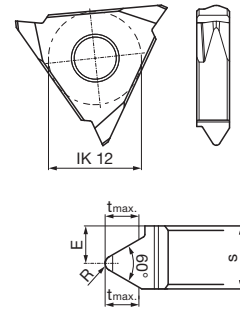

VHM GG305

F Cutting data page 1565



VHM GG305

E Cutting data page 1565

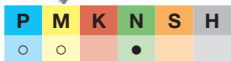

VHM GG305

○ Cutting data page 1565

- Article no. **25654** **F** **R**
- Article no. **25656** **E** **R**
- Article no. **25658** ○ **R**

Right-hand design as shown. Left-hand design is mirror image.

P mm	E mm	R mm	tmax. mm	s mm	Size	Code no.	Description
0,3-0,5	3.90	0.04	0.40	4.20	04	12.100	GG305.TM00.050.AA.04.R
0,5-0,8	3.80	0.07	0.60	4.20	04	12.110	GG305.TM00.080.AA.04.R
0,8-1,0	3.70	0.11	0.70	4.20	04	12.120	GG305.TM00.099.AA.04.R
1,00	3.60	0.14	0.70	4.20	04	12.010	GG305.TM00.100.AA.04.R
1,25	3.50	0.17	0.85	4.20	04	12.020	GG305.TM00.125.AA.04.R
1,50	3.40	0.21	1.00	4.20	04	12.030	GG305.TM00.150.AA.04.R
1,75	3.20	0.25	1.20	4.20	04	12.040	GG305.TM00.175.AA.04.R
2,00	3.10	0.28	1.35	4.20	04	12.050	GG305.TM00.200.AA.04.R
2,50	2.90	0.36	1.65	4.20	04	12.060	GG305.TM00.250.AA.04.R
3,00	2.60	0.43	2.00	4.20	04	12.070	GG305.TM00.300.AA.04.R
3,50	2.50	0.50	2.25	4.20	04	12.090	GG305.TM00.350.AA.04.R
3.0-6.0	3.50	0.43	4.00	6.20	06	12.080	GG305.TM00.600.AA.06.R

- Article no. **25655** **F** **L**
- Article no. **25657** **E** **L**
- Article no. **25659** ○ **L**

On the left-hand design, the designation changes to .L



Indexable inserts for threading, full profile, external

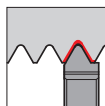

pitch P = 1.0-6.0

ground chip breaker • geometry .AA ground • pay attention to assignment holder/insert seat size 04/06/08 • for tool holders type GH305, size 04/06/08



VHM

GG305



Cutting data page 1565



VHM

GG305



Cutting data page 1565



VHM

GG305



Cutting data page 1565

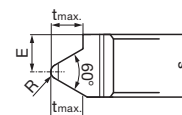
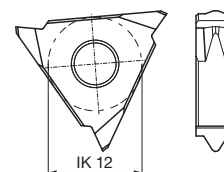

Article no. **25662**



Article no. **25664**



Article no. **25666**



Right-hand design as shown. Left-hand design is mirror image.

P mm	E mm	R mm	tmax. mm	s mm	Size	Code no.	Description
1.00	3.60	0.14	0.70	4.20	04	12.010	GG305.VM00.100.AA.04.R
1.25	3.40	0.17	1.00	4.20	04	12.020	GG305.VM00.125.AA.04.R
1.50	3.30	0.21	1.15	4.20	04	12.030	GG305.VM00.150.AA.04.R
1.75	3.20	0.25	1.30	4.20	04	12.040	GG305.VM00.175.AA.04.R
2.00	3.10	0.28	1.45	4.20	04	12.050	GG305.VM00.200.AA.04.R
2.50	2.90	0.36	1.75	4.20	04	12.060	GG305.VM00.250.AA.04.R
3.00	2.70	0.43	2.10	4.20	04	12.070	GG305.VM00.300.AA.04.R
3.50	2.40	0.50	2.40	4.20	04	12.080	GG305.VM00.350.AA.04.R
4.00	4.20	0.57	2.70	6.20	06	12.090	GG305.VM00.400.AA.06.R
5.00	3.80	0.72	3.30	6.20	06	12.100	GG305.VM00.500.AA.06.R
6.00	5.20	0.86	3.90	8.20	08	12.110	GG305.VM00.600.AA.08.R

Article no. **25663**



Article no. **25665**



Article no. **25667**



On the left-hand design, the designation changes to .L



Indexable inserts for threading, Withworth

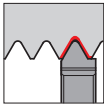

pitch 28-11 TPI
ground chip breaker • geometry .AA ground • for tool holders
type GH305, size 04

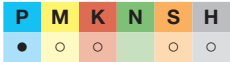

VHM GG305

F Cutting data page 1565

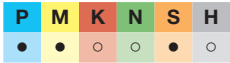

VHM GG305

E Cutting data page 1565



VHM GG305

○ Cutting data page 1565

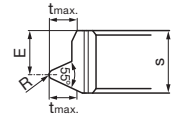
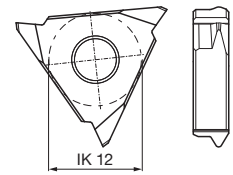

- Article no. **25668** **F** **(R)**
- Article no. **25670** **E** **(R)**
- Article no. **25672** **○** **(R)**

Right-hand design as shown. Left-hand design is mirror image.

P G/inch	E mm	R mm	tmax. mm	s mm	Size	Code no.	Description
28	3.60	0.11	0.58	4.20	04	12.010	GG305.VW00.028.AA.04.R
19	3.40	0.17	0.86	4.20	04	12.020	GG305.VW00.019.AA.04.R
14	3.20	0.23	1.16	4.20	04	12.030	GG305.VW00.014.AA.04.R
11	3.00	0.30	1.48	4.20	04	12.040	GG305.VW00.011.AA.04.R

- Article no. **25669** **F** **(L)**
- Article no. **25671** **E** **(L)**
- Article no. **25673** **○** **(L)**

On the left-hand design, the designation changes to .L



Indexable inserts for threading, UNC/UNF

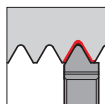

pitch 24-12 TPI
ground chip breaker • geometry .AA ground • for tool holders
type GH305, size 04



VHM

GG305



Cutting data page 1565



VHM

GG305



Cutting data page 1565



VHM

GG305



Cutting data page 1565

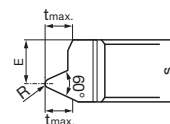
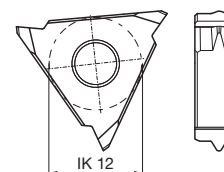

Article no. **25674**



Article no. **25676**



Article no. **25678**



Right-hand design as shown. Left-hand design is mirror image.

P G/inch	E mm	R mm	tmax. mm	s mm	Size	Code no.	Description
24	3.60	0.15	0.80	4.20	04	12.010	GG305.VU00.024.AA.04.R
20	3.50	0.18	0.90	4.20	04	12.020	GG305.VU00.020.AA.04.R
18	3.40	0.20	1.00	4.20	04	12.030	GG305.VU00.018.AA.04.R
16	3.30	0.23	1.10	4.20	04	12.040	GG305.VU00.016.AA.04.R
14	3.30	0.26	1.20	4.20	04	12.050	GG305.VU00.014.AA.04.R
12	3.20	0.31	1.40	4.20	04	12.060	GG305.VU00.012.AA.04.R

Article no. **25675**



Article no. **25677**



Article no. **25679**



On the left-hand design, the designation changes to .L



Cutting inserts for internal hexagon

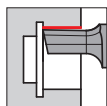

SW 1.5-4.0
for tool holders type GB104, art. no. 25006



P
M
K
N
S
H
VHM
GN104
a

Cutting data page 1566



P
M
K
N
S
H
VHM
GN104
○

Cutting data page 1566

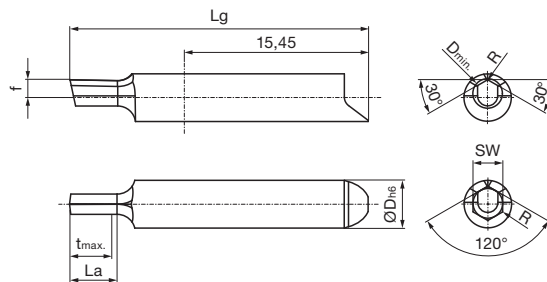

Article no. **25229**



Article no. **25231**



SW	Dmin. mm	R mm	f mm	tmax. mm	La mm	Lg mm	D h6 mm	Code no.	Description
1,50-2,00	1.50	0.05	1.50	3.50	7.50	25.00	4.00	4.001	GN104.SW15.005.04.15.N
2,00-2,50	2.00	0.05	1.50	3.50	7.50	25.00	4.00	4.002	GN104.SW20.005.04.20.N
2,50-2,90	2.50	0.05	1.50	3.50	7.50	25.00	4.00	4.003	GN104.SW25.005.04.25.N
2,90-3,50	2.90	0.05	1.50	4.50	7.50	25.00	4.00	4.004	GN104.SW29.005.05.29.N
3,50-4,00	3.50	0.05	1.50	5.50	7.50	25.00	4.00	4.005	GN104.SW35.005.06.35.N

Cutting inserts for internal hexagon

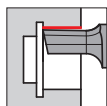

SW 4.0-10.0
for tool holders type GB106, art. no. 25302



P
M
K
N
S
H
VHM
GN106
a

Cutting data page 1566



P
M
K
N
S
H
VHM
GN106
○

Cutting data page 1566

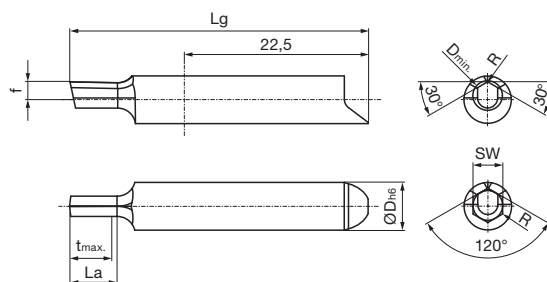

Article no. **25897**



Article no. **25898**



SW	Dmin. mm	R mm	f mm	tmax. mm	La mm	Lg mm	D h6 mm	Code no.	Description
4,00-4,50	4.00	0.10	1.50	6.00	9.00	37.00	6.00	6.001	GN106.SW40.010.06.40.N
4,50-5,00	4.50	0.10	1.50	7.00	10.00	37.00	6.00	6.002	GN106.SW45.010.07.45.N
5,00-8,00	5.00	0.10	1.50	9.00	12.00	37.00	6.00	6.003	GN106.SW50.010.09.50.N
8,00-10,00	8.00	0.10	1.50	12.00	12.50	37.00	6.00	6.004	GN106.SW80.010.12.80.N



Cutting inserts for internal hexagon

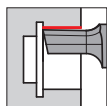

A/F 8.0-14.0

for tool holders type GB106, art. no. 27015

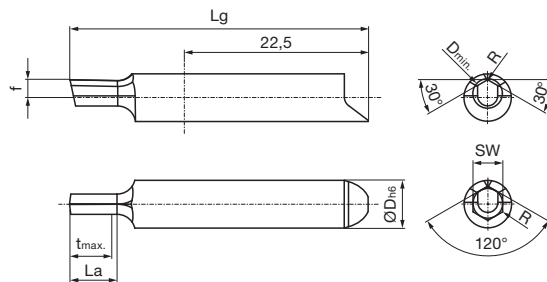

Article no. **27146**



Article no. **27147**



SW	Dmin. mm	R mm	f mm	tmax. mm	La mm	Lg mm	D h6 mm	Code no.	Description
8,00-10,00	8.00	0.10	2.50	12.00	12.50	42.00	8.00	8.001	GN108.SW80.010.12.80.N
8,00-10,00	8.00	0.10	2.50	24.00	24.50	52.00	8.00	8.002	GN108.SW80.010.24.80.N
10,00-14,0	10.00	0.10	2.50	12.00	12.50	42.00	8.00	8.003	GN108.SW10.010.12.00.N
10,00-14,0	10.00	0.10	2.50	24.00	24.50	52.00	8.00	8.004	GN108.SW10.010.24.00.N



Cutting inserts for internal square

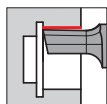

SW 1.5-4.0
for tool holders type GB104, art. no. 25006

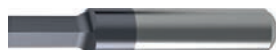

P	M	K	N	S	H	VHM	GN104	a	Cutting data page 1566
•	•	•	○	•	•				



P	M	K	N	S	H	VHM	GN104	○	Cutting data page 1566
○	○	•	•	•	•				

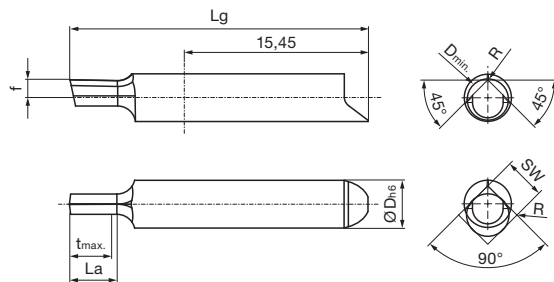

Article no. **25233** **a**

Article no. **25235** ○

SW	Dmin. mm	R mm	f mm	tmax. mm	La mm	Lg mm	D h6 mm	Code no.	Description
1,50-1,80	1.40	0.05	1.50	3.50	7.50	25.00	4.00	4.001	GN104.4545.005.04.15.N
2,00-2,50	1.90	0.05	1.50	3.50	7.50	25.00	4.00	4.002	GN104.4545.005.04.20.N
2,50-2,90	2.40	0.05	1.50	3.50	7.50	25.00	4.00	4.003	GN104.4545.005.04.25.N
2,90-3,50	2.80	0.05	1.50	4.50	7.50	25.00	4.00	4.004	GN104.4545.005.05.29.N
3,50-4,00	3.40	0.05	1.50	5.50	7.50	25.00	4.00	4.005	GN104.4545.005.06.35.N



Cutting inserts for Torx

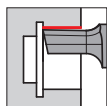

Torx 8-30
for tool holders type GB104, art. no. 25006



Cutting data page 1566



Cutting data page 1566

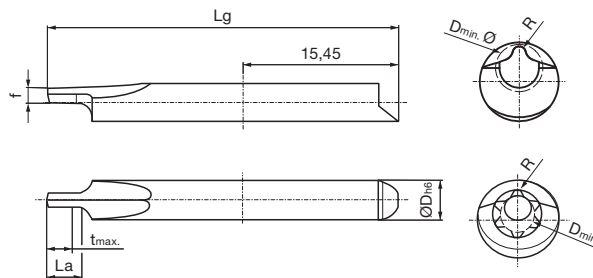

Article no. **25237**



Article no. **25239**



Torx	Dmin. mm	R mm	f mm	tmax. mm	La mm	Lg mm	D h6 mm	Code no.	Description
T8	1.70	0.24	1.80	2.50	3.00	35.00	4.00	4.001	GN104.TX08.024.03.17.N
T10	2.00	0.28	1.80	2.50	3.00	35.00	4.00	4.002	GN104.TX10.028.03.20.N
T15	2.40	0.33	1.80	3.50	4.00	40.00	4.00	4.003	GN104.TX15.033.04.24.N
T20	2.80	0.39	1.80	3.50	4.00	40.00	4.00	4.004	GN104.TX20.039.04.28.N
T25	3.20	0.45	1.80	4.50	5.00	40.00	4.00	4.005	GN104.TX25.045.05.32.N
T30	4.00	0.56	1.80	4.50	5.00	40.00	4.00	4.006	GN104.TX30.056.05.40.N



Cutting inserts for broaching longitudinal slots

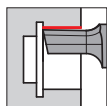

tolerance class C11, P9, JS9
for tool holders type GB106, art. no. 25302



P
M
K
N
S
H
VHM
GN106
a

Cutting data page 1566



P
M
K
N
S
H
VHM
GN106
a

Cutting data page 1566

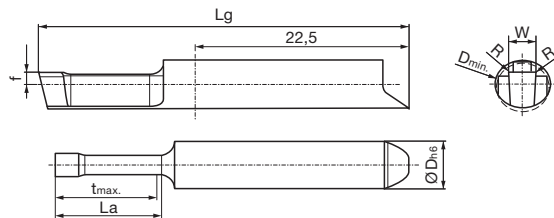

Article no. **25813** a N

Article no. **25815** N

for slot width	Dmin. mm	W mm	R mm	f mm	tmax. mm	La mm	Lg mm	D h6 mm	Code no.	Description
2 P9	6.00	1.98	0.10	1.50	11.50	12.00	37.00	6.00	6.001	GN106.0198.010.12.06.N
3 P9	6.00	2.98	0.10	1.50	11.50	12.00	37.00	6.00	6.002	GN106.0298.010.12.06.N
4 P9	6.00	3.98	0.10	1.50	11.50	12.00	37.00	6.00	6.003	GN106.0398.010.12.06.N
5 P9	7.00	4.98	0.20	1.50	11.50	12.00	37.00	6.00	6.004	GN106.0498.020.12.07.N

Article no. **25817** a N

Article no. **25819** N

for slot width	Dmin. mm	W mm	R mm	f mm	tmax. mm	La mm	Lg mm	D h6 mm	Code no.	Description
2 JS9	6.00	2.00	0.10	1.50	11.50	12.00	37.00	6.00	6.001	GN106.0200.010.12.06.N
3 JS9	6.00	3.00	0.10	1.50	11.50	12.00	37.00	6.00	6.002	GN106.0300.010.12.06.N
4 JS9	6.00	4.00	0.10	1.50	11.50	12.00	37.00	6.00	6.003	GN106.0400.010.12.06.N
5 JS9	7.00	5.00	0.20	1.50	11.50	12.00	37.00	6.00	6.004	GN106.0500.020.12.07.N

Article no. **25821** a N

Article no. **25823** N

for slot width	Dmin. mm	W mm	R mm	f mm	tmax. mm	La mm	Lg mm	D h6 mm	Code no.	Description
2 C11	6.00	2.11	0.35	1.50	11.50	12.00	37.00	6.00	6.001	GN106.0211.035.12.06.N
3 C11	6.00	3.11	0.35	1.50	11.50	12.00	37.00	6.00	6.002	GN106.0311.035.12.06.N
4 C11	6.00	4.13	0.50	1.50	11.50	12.00	37.00	6.00	6.003	GN106.0413.050.12.06.N
5 C11	7.00	5.13	0.50	1.50	11.50	12.00	37.00	6.00	6.004	GN106.0513.050.12.07.N



Cutting inserts for broaching longitudinal slots

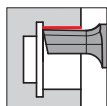

tolerance class C11, P9, JS9
for tool holders type GB106, art. no. 27015



P	M	K	N	S	H	VHM	GN108
●	●	●	○	●	●		

a Cutting data page 1566



P	M	K	N	S	H	VHM	GN108
○	○	●	○	○	○		

○ Cutting data page 1566

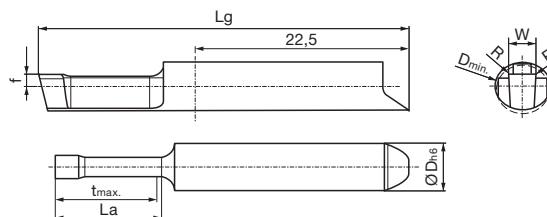

Article no. **27140** **a** **(N)**

Article no. **27141** ○ **(N)**

for slot width	Dmin. mm	W mm	R mm	f mm	tmax. mm	La mm	Lg mm	D h6 mm	Code no.	Description
5 P9	9.00	4.98	0.20	2.50	11.50	12.00	42.00	8.00	8.001	GN108.0498.020.12.90.N
5 P9	9.00	4.98	0.20	2.50	23.50	24.00	52.00	8.00	8.002	GN108.0498.020.24.90.N
6 P9	10.00	5.98	0.20	2.50	11.50	12.00	42.00	8.00	8.003	GN108.0598.020.12.00.N
6 P9	10.00	5.98	0.20	2.50	23.50	24.00	52.00	8.00	8.004	GN108.0598.020.24.00.N

Article no. **27142** **a** **(N)**

Article no. **27143** ○ **(N)**

for slot width	Dmin. mm	W mm	R mm	f mm	tmax. mm	La mm	Lg mm	D h6 mm	Code no.	Description
5 JS9	9.00	5.00	0.20	2.50	11.50	12.00	42.00	8.00	8.001	GN108.0500.020.12.90.N
5 JS9	9.00	5.00	0.20	2.50	23.50	24.00	52.00	8.00	8.002	GN108.0500.020.24.90.N
6 JS9	10.00	6.00	0.20	2.50	11.50	12.00	42.00	8.00	8.003	GN108.0600.020.12.00.N
6 JS9	10.00	6.00	0.20	2.50	23.50	24.00	52.00	8.00	8.004	GN108.0600.020.24.00.N

Article no. **27144** **a** **(N)**

Article no. **27145** ○ **(N)**

for slot width	Dmin. mm	W mm	R mm	f mm	tmax. mm	La mm	Lg mm	D h6 mm	Code no.	Description
5 C11	9.00	5.13	0.50	2.50	11.50	12.00	42.00	8.00	8.001	GN108.0513.050.12.90.N
5 C11	9.00	5.13	0.50	2.50	23.50	24.00	52.00	8.00	8.002	GN108.0513.050.24.90.N
6 C11	10.00	6.13	0.50	2.50	11.50	12.00	42.00	8.00	8.003	GN108.0613.050.12.10.N
6 C11	10.00	6.13	0.50	2.50	23.50	24.00	52.00	8.00	8.004	GN108.0613.050.24.10.N



Round shank holders, clamping screw above

for cutting inserts type 104
with internal coolant supply



GB104

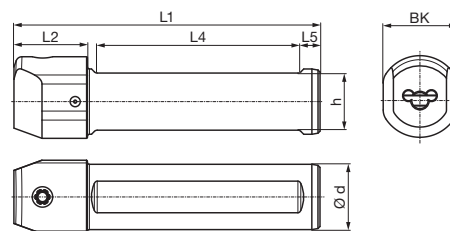

Article no. **25000** B N

d mm	h mm	L1 mm	L2 mm	L4 mm	L5 mm	BK mm	Code no.	Description
10.00	9.00	75.00	18.00	50.00	4.00	12.0	4.001	GB104.0010.075.00.15.N.IK
12.00	11.00	75.00	18.00	50.00	4.00	14.0	4.002	GB104.0012.075.00.15.N.IK
12.70	11.00	89.92	17.78	54.86	4.00	13.9	4.015	GB104.0500.354.00.15.N.IK
15.87	14.00	89.92	17.78	54.86	4.00	17.7	4.016	GB104.0625.354.00.15.N.IK
16.00	14.00	75.00	18.00	50.00	4.00	18.0	4.003	GB104.0016.075.00.15.N.IK
19.05	17.04	96.52	17.78	69.85	4.00		4.017	GB104.0750.380.00.15.N.IK
20.00	18.00	90.00		55.00	4.00		4.004	GB104.0020.090.00.15.N.IK
22.00	20.00	90.00		55.00	4.00		4.005	GB104.0022.090.00.15.N.IK
25.00	23.00	100.00		55.00	4.00		4.006	GB104.0025.100.00.15.N.IK
25.40	23.39	96.52		69.85	4.00		4.018	GB104.1000.380.00.15.N.IK

Spare parts

Article no.	Clamping screw	Tightening torque Nm
25900		
Code 6.000	M6x7.5x15IP	4-4.5

Article no.	Torx-Plus wrench
25904	
Code 15.000	T15IP T-handle



Round shank holders, clamping screw above

for cutting inserts type 106
with internal coolant supply



GB106

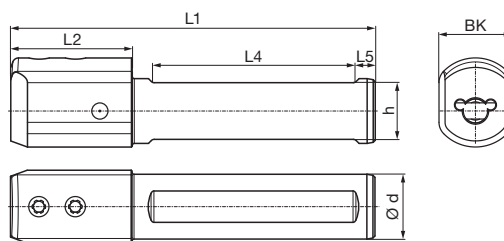

Article no. **25300**



d mm	h mm	L1 mm	L2 mm	L4 mm	L5 mm	BK mm	Code no.	Description
10.00	9.00	90.00	30.00	50.00	4.00	13.0	6.001	GB106.0010.090.00.22.N.IK
12.00	11.00	90.00	30.00	50.00	4.00	14.0	6.002	GB106.0012.090.00.22.N.IK
12.70	11.00	89.92	26.67	54.86	4.00	13.9	6.015	GB106.0500.354.00.22.N.IK
15.87	14.00	89.92	26.67	54.86	4.00	17.7	6.016	GB106.0625.354.00.22.N.IK
16.00	14.00	90.00	30.00	50.00	4.00	18.0	6.003	GB106.0016.090.00.22.N.IK
19.05	17.04	105.41	26.67	69.85	4.00		6.017	GB106.0750.415.00.22.N.IK
20.00	18.00	95.00	30.00	55.00	4.00		6.004	GB106.0020.095.00.22.N.IK
22.00	20.00	95.00		55.00	4.00		6.005	GB106.0022.095.00.22.N.IK
25.00	23.00	100.00		55.00	4.00		6.006	GB106.0025.100.00.22.N.IK
25.40	23.39	105.41		69.85	4.00		6.018	GB106.1000.415.00.22.N.IK

Spare parts

Article no.	Clamping screw	Tightening torque Nm
25900		
Code 6.000	M6x7.5x15IP	4-4.5
Article no.	Torx-Plus wrench	
25904		
Code 15.000	T15IP T-handle	



Round shank holders, clamping screw above

for cutting inserts type 108
with internal coolant supply



GB108

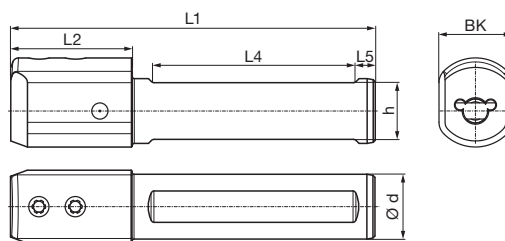

Article no. **27000**



d mm	h mm	L1 mm	L2 mm	L4 mm	L5 mm	BK mm	Code no.	Description
10.00	9.00	90.00	30.00	50.00	4.00	16.5	8.001	GB108.0010.090.00.22.N.IK
12.00	11.00	90.00	30.00	50.00	4.00	16.5	8.002	GB108.0012.090.00.22.N.IK
12.70	11.00	89.92	26.67	54.86	4.00	16.5	8.015	GB108.0500.354.00.22.N.IK
15.87	14.00	89.92	26.67	54.86	4.00	16.5	8.016	GB108.0625.354.00.22.N.IK
16.00	14.00	90.00	30.00	50.00	4.00	16.5	8.003	GB108.0016.090.00.22.N.IK
19.05	17.00	105.41	26.67	69.85	4.00	20.5	8.017	GB108.0750.415.00.22.N.IK
20.00	18.00	95.00	30.00	55.00	4.00	20.5	8.004	GB108.0020.095.00.22.N.IK
22.00	20.00	95.00	30.00	55.00	4.00		8.005	GB108.0022.095.00.22.N.IK
25.00	23.00	100.00		55.00	4.00		8.006	GB108.0025.100.00.22.N.IK
25.40	23.40	105.41		69.85	4.00		8.018	GB108.1000.415.00.22.N.IK

Spare parts

Article no.	Clamping screw	Tightening torque Nm
25900		
Code 6.000	M6x7.5x15IP	4-4.5
Article no.	Torx-Plus wrench	
25904		
Code 15.000	T15IP T-handle	



Round shank holders, clamping screw above

for cutting inserts type 110
with internal coolant supply



GB110

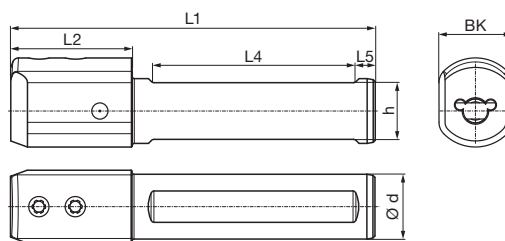

Article no. **27050**



d mm	h mm	L1 mm	L2 mm	L4 mm	L5 mm	BK mm	Code no.	Description
10.00	9.00	90.00	30.00	50.00	4.00	20.0	10.001	GB110.0010.090.00.22.N.IK
12.00	11.00	90.00	30.00	50.00	4.00	20.0	10.002	GB110.0012.090.00.22.N.IK
12.70	11.00	89.92	26.67	54.86	4.00	20.0	10.015	GB110.0500.354.00.22.N.IK
15.87	14.00	89.92	26.67	54.86	4.00	20.0	10.016	GB110.0625.354.00.22.N.IK
16.00	14.00	90.00	30.00	50.00	4.00	20.0	10.003	GB110.0016.090.00.22.N.IK
19.05	17.00	105.41	26.67	69.85	4.00	20.5	10.017	GB110.0750.415.00.22.N.IK
20.00	18.00	95.00	30.00	55.00	4.00	20.5	10.004	GB110.0020.095.00.22.N.IK
22.00	20.00	95.00	30.00	55.00	4.00		10.005	GB110.0022.095.00.22.N.IK
25.00	23.00	100.00		55.00	4.00		10.006	GB110.0025.100.00.22.N.IK
25.40	23.40	105.41		69.85	4.00		10.018	GB110.1000.415.00.22.N.IK

Spare parts

Article no.	Clamping screw	Tightening torque Nm
25900		
Code 6.000	M6x7.5x15IP	4-4.5
Article no.	Torx-Plus wrench	
25904		
Code 15.000	T15IP T-handle	



Round shank holders, clamping screw lateral

for cutting inserts type 104
with internal coolant supply

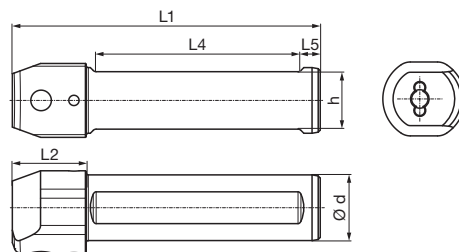

GB104

Article no. **25001**



d mm	h mm	L1 mm	L2 mm	L4 mm	L5 mm	Code no.	Description
10.00	9.00	75.00	18.00	50.00	4.00	4.001	GB104.0010.075.00.15.N.IK.90
12.00	11.00	75.00	18.00	50.00	4.00	4.002	GB104.0012.075.00.15.N.IK.90
12.70	11.00	89.92	17.78	54.86	4.00	4.015	GB104.0500.354.00.15.N.IK.90
15.87	14.00	89.92	17.78	54.86	4.00	4.016	GB104.0625.354.00.15.N.IK.90
16.00	14.00	75.00	18.00	50.00	4.00	4.003	GB104.0016.075.00.15.N.IK.90
19.05	17.04	96.52	17.78	69.85	4.00	4.017	GB104.0750.380.00.15.N.IK.90
20.00	18.00	90.00		55.00	4.00	4.004	GB104.0020.090.00.15.N.IK.90
22.00	20.00	90.00		55.00	4.00	4.005	GB104.0022.090.00.15.N.IK.90
25.00	23.00	100.00		55.00	4.00	4.006	GB104.0025.100.00.15.N.IK.90
25.40	23.39	96.52		69.85	4.00	4.018	GB104.1000.380.00.15.N.IK.90

Spare parts

Article no.	Clamping screw	Tightening torque Nm
25900		
Code 6.000	M6x7.5x15IP	4-4.5
Article no.	Torx-Plus wrench	
25904		
Code 15.000	T15IP T-handle	



Round shank holders, clamping screw lateral

for cutting inserts type 106
with internal coolant supply



GB106

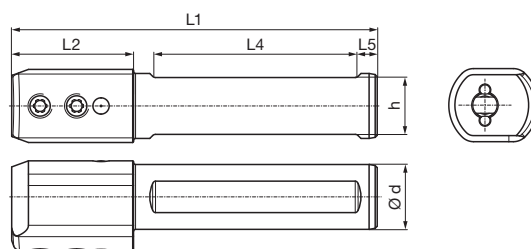

Article no. **25301**



d mm	h mm	L1 mm	L2 mm	L4 mm	L5 mm	Code no.	Description
10.00	9.00	90.00	30.00	50.00	4.00	6.001	GB106.0010.090.00.22.N.IK.90
12.00	11.00	90.00	30.00	50.00	4.00	6.002	GB106.0012.090.00.22.N.IK.90
12.70	11.00	89.92	26.67	54.86	4.00	6.015	GB106.0500.354.00.22.N.IK.90
15.87	14.00	89.92	26.67	54.86	4.00	6.016	GB106.0625.354.00.22.N.IK.90
16.00	14.00	90.00	30.00	50.00	4.00	6.003	GB106.0016.090.00.22.N.IK.90
19.05	17.04	105.41	26.67	69.85	4.00	6.017	GB106.0750.415.00.22.N.IK.90
20.00	18.00	95.00	30.00	55.00	4.00	6.004	GB106.0020.095.00.22.N.IK.90
22.00	20.00	95.00		55.00	4.00	6.005	GB106.0022.095.00.22.N.IK.90
25.00	23.00	100.00		55.00	4.00	6.006	GB106.0025.100.00.22.N.IK.90
25.40	23.39	105.41		69.85	4.00	6.018	GB106.1000.415.00.22.N.IK.90

Spare parts

Article no.	Clamping screw	Tightening torque Nm
25900		
Code 6.000	M6x7.5x15IP	4-4.5
Article no.	Torx-Plus wrench	
25904		
Code 15.000	T15IP T-handle	



Round shank holders, clamping screw lateral

for cutting inserts type 108
with internal coolant supply



GB108

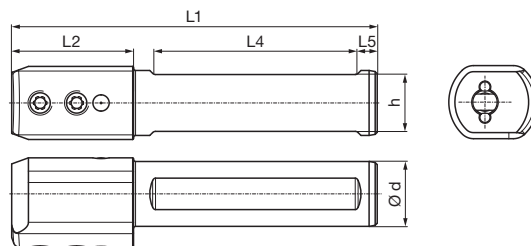

Article no. **27001**



d mm	h mm	L1 mm	L2 mm	L4 mm	L5 mm	Code no.	Description
10.00	9.00	90.00	30.00	50.00	4.00	8.001	GB108.0010.090.00.22.N.IK.90
12.00	11.00	90.00	30.00	50.00	4.00	8.002	GB108.0012.090.00.22.N.IK.90
12.70	11.00	89.92	26.67	54.86	4.00	8.015	GB108.0500.354.00.22.N.IK.90
15.87	14.00	89.92	26.67	54.86	4.00	8.016	GB108.0625.354.00.22.N.IK.90
16.00	14.00	90.00	30.00	50.00	4.00	8.003	GB108.0016.090.00.22.N.IK.90
19.05	17.00	105.41	26.67	69.85	4.00	8.017	GB108.0750.415.00.22.N.IK.90
20.00	18.00	95.00	30.00	55.00	4.00	8.004	GB108.0020.095.00.22.N.IK.90
22.00	20.00	95.00	30.00	55.00	4.00	8.005	GB108.0022.095.00.22.N.IK.90
25.00	23.00	100.00		55.00	4.00	8.006	GB108.0025.100.00.22.N.IK.90
25.40	23.40	105.41		69.85	4.00	8.018	GB108.1000.415.00.22.N.IK.90

Spare parts

Article no.	Clamping screw	Tightening torque Nm
25900		
Code 6.000	M6x7.5x15IP	4-4.5
Article no.	Torx-Plus wrench	
25904		
Code 15.000	T15IP T-handle	



Round shank holders, clamping screw lateral

for cutting inserts type 110
with internal coolant supply



GB110

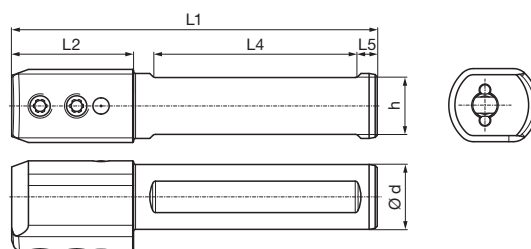

Article no. **27051**



d mm	h mm	L1 mm	L2 mm	L4 mm	L5 mm	Code no.	Description
10.00	9.00	90.00	30.00	50.00	4.00	10.001	GB110.0010.090.00.22.N.IK90
12.00	11.00	90.00	30.00	50.00	4.00	10.002	GB110.0012.090.00.22.N.IK90
12.70	11.00	89.92	26.67	54.86	4.00	10.015	GB110.0500.354.00.22.N.IK90
15.87	14.00	89.92	26.67	54.86	4.00	10.016	GB110.0625.354.00.22.N.IK90
16.00	14.00	90.00	30.00	50.00	4.00	10.003	GB110.0016.090.00.22.N.IK90
19.05	17.00	105.41	26.67	69.85	4.00	10.017	GB110.0750.415.00.22.N.IK90
20.00	18.00	95.00	30.00	55.00	4.00	10.004	GB110.0020.095.00.22.N.IK90
22.00	20.00	95.00	30.00	55.00	4.00	10.005	GB110.0022.095.00.22.N.IK90
25.00	23.00	100.00		55.00	4.00	10.006	GB110.0025.100.00.22.N.IK90
25.40	23.40	105.41		69.85	4.00	10.018	GB110.1000.415.00.22.N.IK90

Spare parts

Article no.	Clamping screw	Tightening torque Nm
25900		
Code 6.000	M6x7.5x15IP	4-4.5
Article no.	Torx-Plus wrench	
25904		
Code 15.000	T15IP T-handle	



Round shank holders, clamping screw above, four clamping surfaces

for cutting inserts type 104
with internal coolant supply

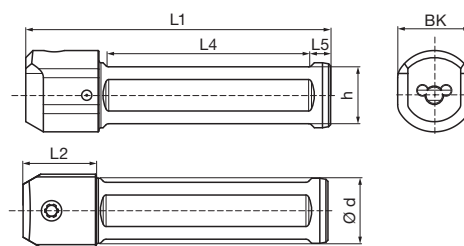

GB104

Article no. **25018**



d mm	h mm	L1 mm	L2 mm	L4 mm	L5 mm	BK mm	Code no.	Description
12.70	11.00	89.92	17.78	55.00	4.00	13.9	4.050	GB104.0500.354.00.15.N.IK.VSP
15.87	14.00	89.92	17.78	55.00	4.00	17.7	4.060	GB104.0625.354.00.15.N.IK.VSP
16.00	14.00	75.00	18.00	50.00	4.00	18.0	4.010	GB104.0016.075.00.15.N.IK.VSP
19.05	17.04	96.52	17.78	69.85	4.00		4.070	GB104.0750.380.00.15.N.IK.VSP
20.00	18.00	90.00		55.00	4.00		4.020	GB104.0020.090.00.15.N.IK.VSP
22.00	20.00	90.00		55.00	4.00		4.030	GB104.0022.090.00.15.N.IK.VSP
25.00	23.00	100.00		55.00	4.00		4.040	GB104.0025.100.00.15.N.IK.VSP
25.40	23.39	96.52		69.85	4.00		4.080	GB104.1000.380.00.15.N.IK.VSP

Spare parts

Article no.	Clamping screw	Tightening torque Nm
25900		
Code 6.000	M6x7.5x15IP	4-4.5

Article no.	Torx-Plus wrench
25904	
Code 15.000	T15IP T-handle



Round shank holders, clamping screw above, four clamping surfaces

for cutting inserts type 106
with internal coolant supply

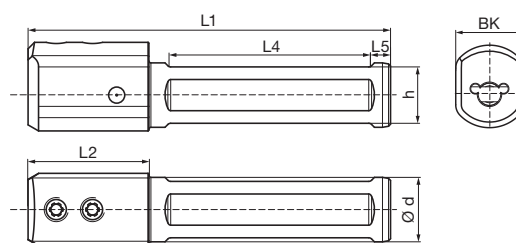

GB106

Article no. **25320**



d mm	h mm	L1 mm	L2 mm	L4 mm	L5 mm	BK mm	Code no.	Description
12.70	11.00	89.92	26.67	54.86	4.00	13.9	6.050	GB106.0500.354.00.22.N.IK.VSP
15.87	14.00	89.92	26.67	54.86	4.00	17.7	6.060	GB106.0625.354.00.22.N.IK.VSP
16.00	14.00	90.00	30.00	50.00	4.00	18.0	6.010	GB106.0016.090.00.22.N.IK.VSP
19.05	17.04	105.41	26.67	69.85	4.00		6.070	GB106.0750.415.00.22.N.IK.VSP
20.00	18.00	95.00	30.00	55.00	4.00		6.020	GB106.0020.095.00.22.N.IK.VSP
22.00	20.00	95.00		55.00	4.00		6.030	GB106.0022.095.00.22.N.IK.VSP
25.00	23.00	100.00		55.00	4.00		6.040	GB106.0025.100.00.22.N.IK.VSP
25.40	23.39	105.41		69.85	4.00		6.080	GB106.1000.415.00.22.N.IK.VSP

Spare parts

Article no.	Clamping screw	Tightening torque Nm
25900		
Code 6.000	M6x7.5x15IP	4-4.5

Article no.	Torx-Plus wrench
25904	
Code 15.000	T15IP T-handle



Round shank holders, clamping screw above, four clamping surfaces

for inserts type 106 with IC •
with central internal coolant supply

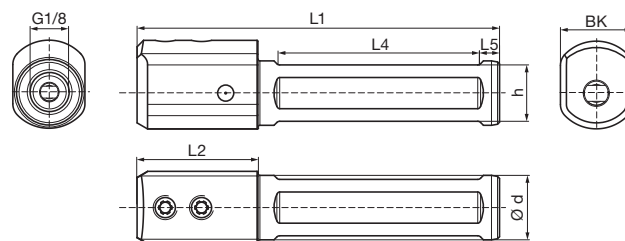

GB106

Article no. **25325**



d mm	h mm	L1 mm	L2 mm	L4 mm	L5 mm	BK mm	Code no.	Description
16.00	14.00	90.00	30.00	50.00	4.00	18.0	6.001	GB106.0016.090.00.22.N.IK.Z
20.00	18.00	95.00	30.00	55.00	4.00		6.002	GB106.0020.095.00.22.N.IK.Z
22.00	20.00	95.00		55.00	4.00		6.003	GB106.0022.095.00.22.N.IK.Z

Spare parts

Article no.	Clamping screw	Tightening torque Nm
25900		
Code 6.000	M6x7.5x15IP	4-4.5

Article no.	Torx-Plus wrench
25904	
Code 15.000	T15IP T-handle



Round shank holders, clamping screw above, four clamping surfaces

for cutting inserts type 108 • especially suitable for Quattro Drill,
art. No. 27290

with internal coolant supply

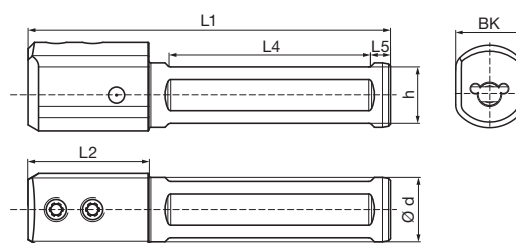

GB108

Article no. **27002**



d mm	h mm	L1 mm	L2 mm	L4 mm	L5 mm	BK mm	Code no.	Description
16.00	14.00	90.00	30.00	50.00	4.00	16.5	8.010	GB108.0016.090.00.22.N.IK.VSP
20.00	18.00	95.00	30.00	55.00	4.00	20.5	8.020	GB108.0020.095.00.22.N.IK.VSP
22.00	20.00	95.00	30.00	55.00	4.00		8.030	GB108.0022.095.00.22.N.IK.VSP
25.00	23.00	100.00		55.00	4.00		8.040	GB108.0025.100.00.22.N.IK.VSP

Spare parts

Article no.	Clamping screw	Tightening torque Nm
25900		
Code 6.000	M6x7.5x15IP	4-4.5

Article no.	Torx-Plus wrench
25904	
Code 15.000	T15IP T-handle



Round shank holders, clamping screw above, four clamping surfaces

for inserts type 108 with IC •
with central internal coolant supply

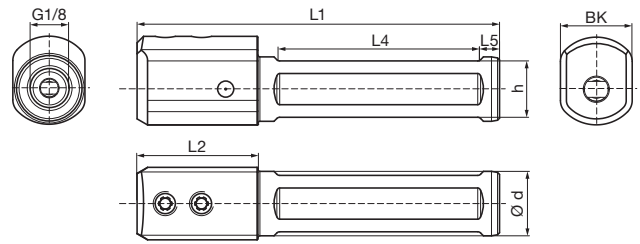

GB108

Article no. **27018**



d mm	h mm	L1 mm	L2 mm	L4 mm	L5 mm	BK mm	Code no.	Description
16.00	14.00	90.00	30.00	50.00	4.00	16.5	8.001	GB108.0016.090.00.22.N.IK.Z
20.00	18.00	95.00	30.00	55.00	4.00	20.5	8.002	GB108.0020.095.00.22.N.IK.Z
22.00	20.00	95.00	30.00	55.00	4.00		8.003	GB108.0022.095.00.22.N.IK.Z

Spare parts

Article no.	Clamping screw	Tightening torque Nm
25900 Code 6.000	M6x7.5x15IP	4-4.5
Article no.	Torx-Plus wrench	
25904 Code 15.000	T15IP T-handle	



Round shank holders, clamping screw above, without clamping surfaces

for cutting inserts type 104
with internal coolant supply

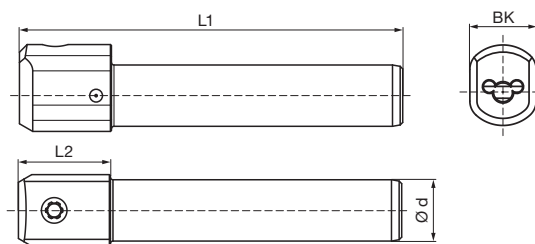

GB104

Article no. **25017**



d mm	L1 mm	L2 mm	BK mm	Code no.	Description
10.00	75.00	18.00	12.0	4.010	GB104.0010.075.00.15.N.IK.RND
12.00	75.00	18.00	14.0	4.020	GB104.0012.075.00.15.N.IK.RND
16.00	75.00	18.00	18.0	4.030	GB104.0016.075.00.15.N.IK.RND

Spare parts

Article no.	Clamping screw	Tightening torque Nm
25900		
Code 6.000	M6x7.5x15IP	4-4.5

Article no.	Torx-Plus wrench
25904	
Code 15.000	T15IP T-handle



Round shank holders, clamping screw above, without clamping surfaces

for cutting inserts type 106
with internal coolant supply

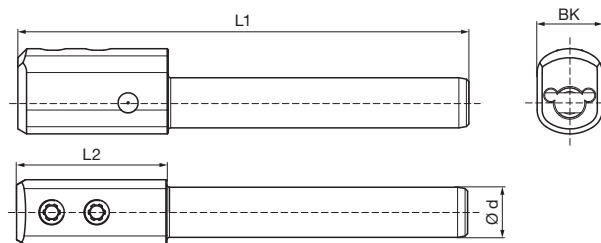

GB106

Article no. **25319**



d mm	L1 mm	L2 mm	BK mm	Code no.	Description
10.00	90.00	30.00	13.0	6.010	GB106.0010.090.00.22.N.IK.RND
12.00	90.00	30.00	14.0	6.020	GB106.0012.090.00.22.N.IK.RND
16.00	90.00	30.00	18.0	6.030	GB106.0016.090.00.22.N.IK.RND

Spare parts

Article no.	Clamping screw	Tightening torque Nm
25900		
Code 6.000	M6x7.5x15IP	4-4.5

Article no.	Torx-Plus wrench
25904	
Code 15.000	T15IP T-handle



Round shank holders, clamping screw above, without clamping surfaces

for cutting inserts type 108
with internal coolant supply

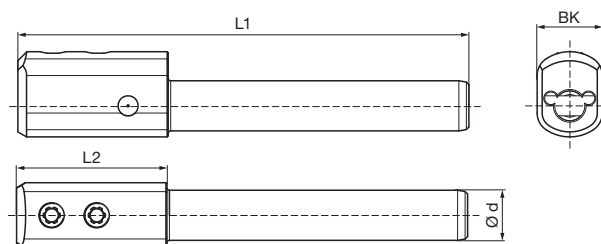

GB108

Article no. **27003**



d mm	L1 mm	L2 mm	BK mm	Code no.	Description
10.00	90.00	30.00	16.5	8.010	GB108.0010.090.00.22.N.IK.RND
12.00	90.00	30.00	16.5	8.020	GB108.0012.090.00.22.N.IK.RND
16.00	90.00	30.00	16.5	8.030	GB108.0016.090.00.22.N.IK.RND

Spare parts

Article no.	Clamping screw	Tightening torque Nm
25900		
Code 6.000	M6x7.5x15IP	4-4.5

Article no.	Torx-Plus wrench
25904	
Code 15.000	T15IP T-handle



Round shank holders, clamping screw above, for Citizen machine

for cutting inserts type 104
with internal coolant supply

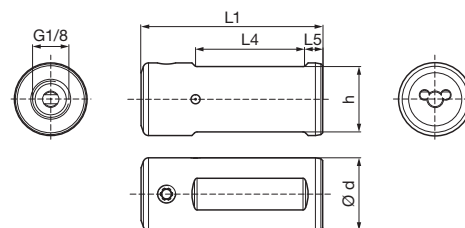

GB104

Article no. **25021**



d mm	h mm	L1 mm	L4 mm	L5 mm	Code no.	Description
19.05	17.04	40.00	20.32	4.00	4.110	GB104.0750.040.00.15.N.IK.CIT
19.05	17.04	50.00	31.75	4.00	4.120	GB104.0750.050.00.15.N.IK.CIT
19.05	17.04	70.00	44.45	4.00	4.130	GB104.0750.070.00.15.N.IK.CIT
19.05	17.04	100.00	76.20	4.00	4.140	GB104.0750.100.00.15.N.IK.CIT
20.00	18.00	50.00	30.00	4.00	4.010	GB104.0020.050.00.15.N.IK.CIT
20.00	18.00	30.00	13.00	4.00	4.020	GB104.0020.030.00.15.N.IK.CIT
25.40	23.40	60.00	38.10	4.00	4.150	GB104.1000.060.00.15.N.IK.CIT
25.40	23.40	100.00	76.20	4.00	4.160	GB104.1000.100.00.15.N.IK.CIT

Spare parts

Article no.	Clamping screw	Tightening torque Nm
25900		
Code 6.000	M6x7.5x15IP	4-4.5
Article no.	Torx-Plus wrench	
25904		
Code 15.000	T15IP T-handle	



Round shank holders, clamping screw above, for Citizen machine

for cutting inserts type 106
with internal coolant supply

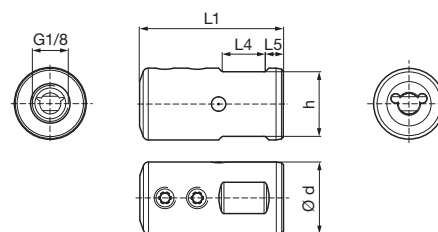

GB106

Article no. **25316**



d mm	h mm	L1 mm	L4 mm	L5 mm	Code no.	Description
19.05	17.05	40.00	12.70	4.00	6.110	GB106.0750.040.00.22.N.IK.CIT
19.05	17.05	50.00	22.86	4.00	6.120	GB106.0750.050.00.22.N.IK.CIT
19.05	17.05	70.00	44.45	4.00	6.130	GB106.0750.070.00.22.N.IK.CIT
19.05	17.05	100.00	73.66	4.00	6.140	GB106.0750.100.00.22.N.IK.CIT
20.00	18.00	40.00	12.00	4.00	6.010	GB106.0020.040.00.22.N.IK.CIT
20.00	18.00	50.00	22.00	4.00	6.020	GB106.0020.050.00.22.N.IK.CIT
25.40	23.40	60.00	31.75	4.00	6.150	GB106.1000.060.00.22.N.IK.CIT
25.40	23.40	100.00	73.66	4.00	6.160	GB106.1000.100.00.22.N.IK.CIT

Spare parts

Article no.	Clamping screw	Tightening torque Nm
25900		
Code 6.000	M6x7.5x15IP	4-4.5

Article no.	Torx-Plus wrench
25904	
Code 15.000	T15IP T-handle



Round shank holders, clamping screw above, for Citizen machine

for cutting inserts type 108
with internal coolant supply

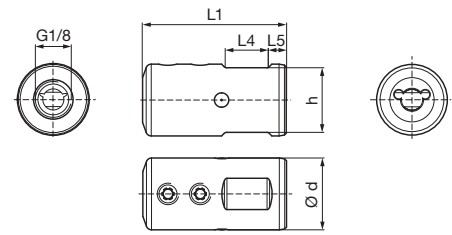

GB108

Article no. **27004**



d mm	h mm	L1 mm	L4 mm	L5 mm	Code no.	Description
19.05	17.05	40.00	12.70	4.00	8.110	GB108.0750.040.00.22.N.IK.CIT
19.05	17.05	50.00	22.86	4.00	8.120	GB108.0750.050.00.22.N.IK.CIT
19.05	17.05	70.00	44.45	4.00	8.130	GB108.0750.070.00.22.N.IK.CIT
19.05	17.05	100.00	73.66	4.00	8.140	GB108.0750.100.00.22.N.IK.CIT
20.00	18.00	40.00	12.00	4.00	8.010	GB108.0020.040.00.22.N.IK.CIT
20.00	18.00	50.00	22.00	4.00	8.020	GB108.0020.050.00.22.N.IK.CIT
25.40	23.40	60.00	31.75	4.00	8.150	GB108.1000.060.00.22.N.IK.CIT
25.40	23.40	100.00	73.66	4.00	8.160	GB108.1000.100.00.22.N.IK.CIT

Spare parts

Article no.	Clamping screw	Tightening torque Nm
25900		
Code 6.000	M6x7.5x15IP	4-4.5

Article no.	Torx-Plus wrench
25904	
Code 15.000	T15IP T-handle



Round shank holders, clamping screw above, for Star machine

for cutting inserts type 104
with internal coolant supply

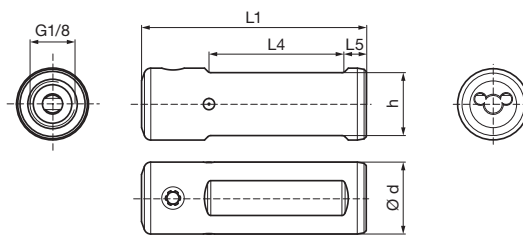

GB104

Article no. **25022**



d mm	h mm	L1 mm	L4 mm	L5 mm	Code no.	Description
16.00	14.00	30.00	13.00	4.00	4.010	GB104.0016.030.00.15.N.IK.STA
16.00	14.00	50.00	30.00	4.00	4.020	GB104.0016.050.00.15.N.IK.STA
16.00	14.00	70.00	50.00	4.00	4.030	GB104.0016.070.00.15.N.IK.STA
22.00	20.00	38.00	18.00	4.00	4.040	GB104.0022.038.00.15.N.IK.STA
22.00	20.00	50.00	30.00	4.00	4.050	GB104.0022.050.00.15.N.IK.STA
22.00	20.00	70.00	50.00	4.00	4.060	GB104.0022.070.00.15.N.IK.STA
22.00	20.00	100.00	80.00	4.00	4.070	GB104.0022.100.00.15.N.IK.STA
22.00	20.00	120.00	100.00	4.00	4.080	GB104.0022.120.00.15.N.IK.STA

Spare parts

Article no.	Clamping screw	Tightening torque Nm
25900		
Code 6.000	M6x7.5x15IP	4-4.5

Article no.	Torx-Plus wrench
25904	
Code 15.000	T15IP T-handle



Round shank holders, clamping screw above, for Star machine

for cutting inserts type 106
with internal coolant supply

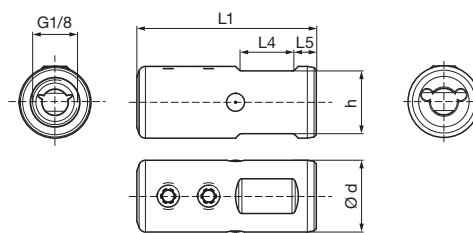

GB106

Article no. **25317**



d mm	h mm	L1 mm	L4 mm	L5 mm	Code no.	Description
16.00	14.00	40.00	12.00	4.00	6.010	GB106.0016.040.00.22.N.IK.STA
16.00	14.00	50.00	22.00	4.00	6.020	GB106.0016.050.00.22.N.IK.STA
16.00	14.00	70.00	42.00	4.00	6.030	GB106.0016.070.00.22.N.IK.STA
22.00	20.00	38.00	10.00	4.00	6.040	GB106.0022.038.00.22.N.IK.STA
22.00	20.00	50.00	20.00	4.00	6.050	GB106.0022.050.00.22.N.IK.STA
22.00	20.00	70.00	40.00	4.00	6.060	GB106.0022.070.00.22.N.IK.STA
22.00	20.00	100.00	70.00	4.00	6.070	GB106.0022.100.00.22.N.IK.STA
22.00	20.00	120.00	90.00	4.00	6.080	GB106.0022.120.00.22.N.IK.STA

Spare parts

Article no.	Clamping screw	Tightening torque Nm
25900		
Code 6.000	M6x7.5x15IP	4-4.5

Article no.	Torx-Plus wrench
25904	
Code 15.000	T15IP T-handle



Round shank holders, clamping screw above, for Star machine

for cutting inserts type 108
with internal coolant supply

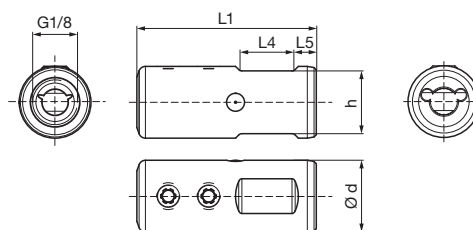

GB108

Article no. **27005**



d mm	h mm	L1 mm	L4 mm	L5 mm	Code no.	Description
16.00	14.00	40.00	12.00	4.00	8.010	GB108.0016.040.00.22.N.IK.STA
16.00	14.00	50.00	22.00	4.00	8.020	GB108.0016.050.00.22.N.IK.STA
16.00	14.00	70.00	42.00	4.00	8.030	GB108.0016.070.00.22.N.IK.STA
22.00	20.00	38.00	10.00	4.00	8.040	GB108.0022.038.00.22.N.IK.STA
22.00	20.00	50.00	20.00	4.00	8.050	GB108.0022.050.00.22.N.IK.STA
22.00	20.00	70.00	40.00	4.00	8.060	GB108.0022.070.00.22.N.IK.STA
22.00	20.00	100.00	70.00	4.00	8.070	GB108.0022.100.00.22.N.IK.STA
22.00	20.00	120.00	90.00	4.00	8.080	GB108.0022.120.00.22.N.IK.STA

Spare parts

Article no.	Clamping screw	Tightening torque Nm	Description
25900			
Code 6.000	M6x7,5x15IP	4-4.5	GB108.0022...
Article no.	Clamping screw	Tightening torque Nm	Description
25908			
Code 6.001	M6x3,5x15IP	4-4.5	GB108.0016...
Article no.	Torx-Plus wrench		
25904			
Code 15.000	T15IP T-handle		



Round shank holders, clamping screw above, for Tornos machine

for cutting inserts type 104
with internal coolant supply

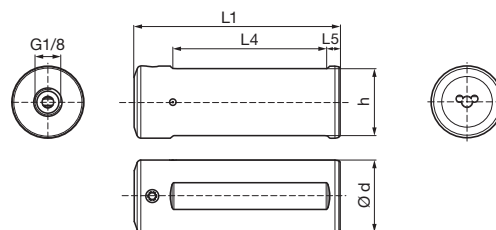

GB104

Article no. **25023**



d mm	h mm	L1 mm	L4 mm	L5 mm	Code no.	Description
18.00	16.00	310.00	290.00	4.00	4.010	GB104.0018.310.00.15.N.IK.TOR
20.00	18.00	170.00	150.00	4.00	4.020	GB104.0020.170.00.15.N.IK.TOR
20.00	18.00	185.00	165.00	4.00	4.030	GB104.0020.185.00.15.N.IK.TOR
25.00	23.00	100.00	80.00	4.00	4.040	GB104.0025.100.00.15.N.IK.TOR
25.00	23.00	150.00	130.00	4.00	4.050	GB104.0025.150.00.15.N.IK.TOR
28.00	26.00	80.00	60.00	4.00	4.060	GB104.0028.080.00.15.N.IK.TOR

Spare parts

Article no.	Clamping screw	Tightening torque Nm
25900 Code 6.000	M6x7.5x15IP	4-4.5
Article no.	Torx-Plus wrench	
25904 Code 15.000	T15IP T-handle	



Round shank holders, clamping screw above, for Tornos machine

for cutting inserts type 106
with internal coolant supply

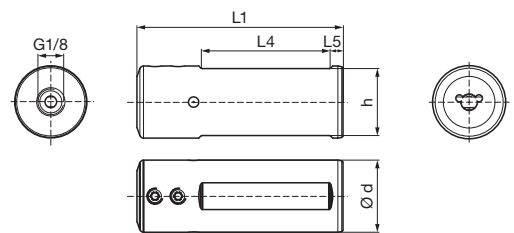

GB106

Article no. **25318**



d mm	h mm	L1 mm	L4 mm	L5 mm	Code no.	Description
18.00	16.00	310.00	280.00	4.00	6.010	GB106.0018.310.00.22.N.IK.TOR
20.00	18.00	170.00	140.00	4.00	6.020	GB106.0020.170.00.22.N.IK.TOR
20.00	18.00	185.00	155.00	4.00	6.030	GB106.0020.185.00.22.N.IK.TOR
25.00	23.00	100.00	70.00	4.00	6.040	GB106.0025.100.00.22.N.IK.TOR
25.00	23.00	150.00	120.00	4.00	6.050	GB106.0025.150.00.22.N.IK.TOR
28.00	26.00	80.00	50.00	4.00	6.060	GB106.0028.080.00.22.N.IK.TOR

Spare parts

Article no.	Clamping screw	Tightening torque Nm
25900 Code 6.000	M6x7.5x15IP	4-4.5
Article no.	Torx-Plus wrench	
25904 Code 15.000	T15IP T-handle	



Round shank holders, for machine type Star, rear side machining

for cutting inserts type 104
with internal coolant supply

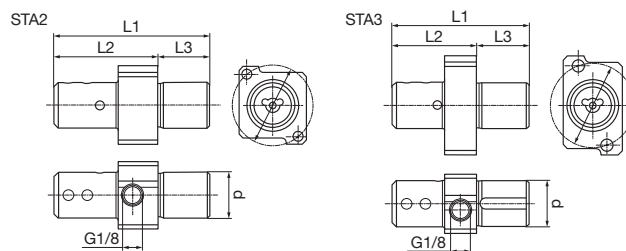

GB104

Article no. **25024**



d mm	L1 mm	L3 mm	L2 mm	Code no.	Description
22.00	75.00	25.00	50.00	4.010	GB104.0022.075.00.15.N.IK.STA2
22.00	65.00	25.00	40.00	4.020	GB104.0022.065.00.15.N.IK.STA3

Spare parts

Article no.	Clamping screw	Tightening torque Nm
25900	M6x7.5x15IP	4-4.5
Code 6.000		

Article no.	Connection screws	Description
25912		
Code 4.000	M4x30 (STA2)	GB104.022.....IK.STA2
Code 5.000	M5x30 (STA3)	GB104.022.....IK.STA3

Article no.	Torx-Plus wrench
25904	
Code 15.000	T15IP T-handle



Round shank holders, for machine type Star, rear side machining

for cutting inserts type 106
with internal coolant supply

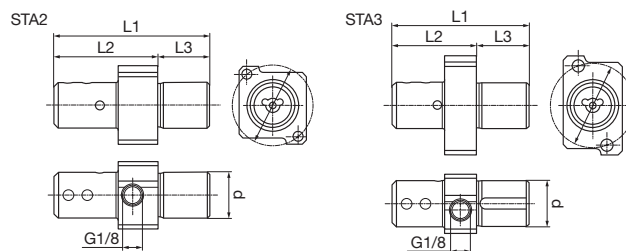

GB106

Article no. **25321**



d mm	L1 mm	L3 mm	L2 mm	Code no.	Description
22.00	75.00	25.00	50.00	6.010	GB106.0022.075.00.22.N.IK.STA2
22.00	65.00	25.00	40.00	6.020	GB106.0022.065.00.22.N.IK.STA3

Spare parts

Article no.	Clamping screw	Tightening torque Nm
25900	M6x7.5x15IP	4-4.5
Code 6.000		
Article no.	Connection screws	Description
25912		
Code 4.000	M4x30 (STA2)	GB106.022.....IK.STA2
Code 5.000	M5x30 (STA3)	GB106.022.....IK.STA3
Article no.	Torx-Plus wrench	
25904		
Code 15.000	T15IP T-handle	



Round shank holders, for machine type Star, rear side machining

for cutting inserts type 108
with internal coolant supply

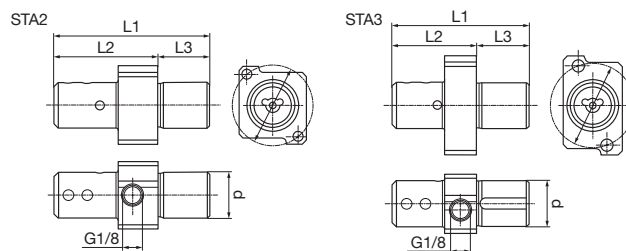

GB108

Article no. **27016**



d mm	L1 mm	L3 mm	L2 mm	Code no.	Description
22.00	75.00	25.00	50.00	8.010	GB108.0022.075.00.22.N.IK.STA2
22.00	65.00	25.00	40.00	8.020	GB108.0022.065.00.22.N.IK.STA3

Spare parts

Article no.	Clamping screw	Tightening torque Nm
25900	M6x7.5x15IP	4-4.5
Code 6.000		
Article no.	Connection screws	Description
25912		
Code 4.000	M4x30 (STA2)	GB108.022.....IK.STA2
Code 5.000	M5x30 (STA3)	GB108.022.....IK.STA3
Article no.	Torx-Plus wrench	
25904		
Code 15.000	T15IP T-handle	



Round shank holders for broaching

for cutting inserts type 104
with internal coolant supply

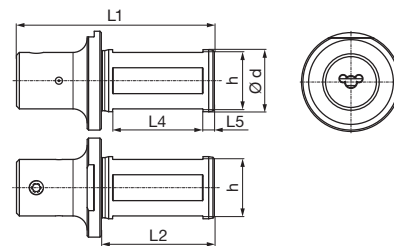

GB104

Article no. **25006**



d mm	h mm	L1 mm	L2 mm	L4 mm	L5 mm	Code no.	Description
19.05	17.05	69.85	40.00	32.00	4.00	4.010	GB104.0750.275.00.15.S.IK
20.00	18.00	70.00	40.00	32.00	4.00	4.001	GB104.0020.070.00.15.S.IK
22.00	20.00	70.00	40.00	32.00	4.00	4.002	GB104.0022.070.00.15.S.IK
25.00	23.00	70.00	40.00	32.00	4.00	4.003	GB104.0025.070.00.15.S.IK
25.40	23.40	69.85	40.00	32.00	4.00	4.011	GB104.1000.275.00.15.S.IK

Spare parts

Article no.	Clamping screw	Tightening torque Nm
25900		
Code 6.000	M6x7.5x15IP	4-4.5

Article no.	Torx-Plus wrench
25904	
Code 15.000	T15IP T-handle



Round shank holders for broaching

for cutting inserts type 106
with internal coolant supply

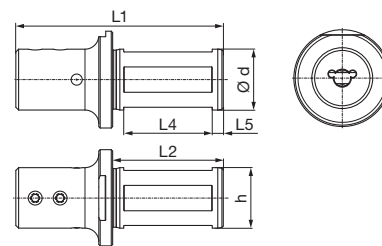

GB106

Article no. **25302**



d mm	h mm	L1 mm	L2 mm	L4 mm	L5 mm	Code no.	Description
19.05	17.05	76.20	40.00	32.00	4.00	6.010	GB106.0750.300.00.22.S.IK
20.00	18.00	75.00	40.00	32.00	4.00	6.001	GB106.0020.075.00.22.S.IK
22.00	20.00	75.00	40.00	32.00	4.00	6.002	GB106.0022.075.00.22.S.IK
25.00	23.00	75.00	40.00	32.00	4.00	6.003	GB106.0025.075.00.22.S.IK
25.40	23.40	76.20	40.00	32.00	4.00	6.011	GB106.1000.300.00.22.S.IK

Spare parts

Article no.	Clamping screw	Tightening torque Nm
25900		
Code 6.000	M6x7.5x15IP	4-4.5

Article no.	Torx-Plus wrench
25904	
Code 15.000	T15IP T-handle



Round shank holders for broaching

for cutting inserts type 108
with internal coolant supply

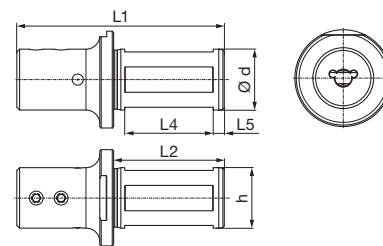

GB108

Article no. **27015**



d mm	h mm	L1 mm	L2 mm	L4 mm	L5 mm	Code no.	Description
19.05	17.05	76.20	40.00	32.00	4.00	8.010	GB108.0750.300.00.22.S.IK
20.00	18.00	75.00	40.00	32.00	4.00	8.001	GB108.0020.075.00.22.S.IK
22.00	20.00	75.00	40.00	32.00	4.00	8.002	GB108.0022.075.00.22.S.IK
25.00	23.00	75.00	40.00	32.00	4.00	8.003	GB108.0025.075.00.22.S.IK
25.40	23.40	76.20	40.00	32.00	4.00	8.011	GB108.1000.300.00.22.S.IK

Spare parts

Article no.	Clamping screw	Tightening torque Nm
25900		
Code 6.000	M6x7.5x15IP	4-4.5

Article no.	Torx-Plus wrench
25904	
Code 15.000	T15IP T-handle



Round shank holders for broaching

for cutting inserts type 110
with internal coolant supply

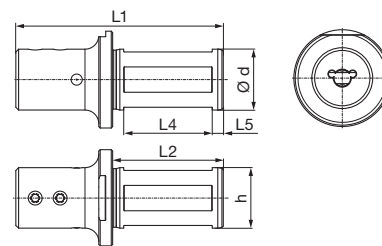

GB110

Article no. **27056**



d mm	h mm	L1 mm	L2 mm	L4 mm	L5 mm	Code no.	Description
19.05	17.05	76.20	40.00	32.00	4.00	10.010	GB110.0750.300.00.22.S.IK
20.00	18.00	75.00	40.00	32.00	4.00	10.001	GB110.0020.075.00.22.S.IK
22.00	20.00	75.00	40.00	32.00	4.00	10.002	GB110.0022.075.00.22.S.IK
25.00	23.00	75.00	40.00	32.00	4.00	10.003	GB110.0025.075.00.22.S.IK
25.40	23.40	76.20	40.00	32.00	4.00	10.011	GB110.1000.300.00.22.S.IK

Spare parts

Article no.	Clamping screw	Tightening torque Nm
25900		
Code 6.000	M6x7.5x15IP	4-4.5

Article no.	Torx-Plus wrench
25904	
Code 15.000	T15IP T-handle



Polygon shank holders, according to ISO 26623, straight 0°

for cutting inserts type 104
with internal coolant supply

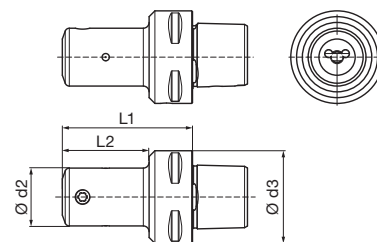

GH104

Article no. **25010**



d2 mm	d3	L1 mm	L2 mm	Code no.	Description
20.00	PSC 32	45.00	30.00	4.001	GH104.PO32.045.00.15.N.IK
20.00	PSC 40	50.00	30.00	4.002	GH104.PO40.050.00.15.N.IK
20.00	PSC 50	50.00	30.00	4.003	GH104.PO50.050.00.15.N.IK
20.00	PSC 63	52.00	30.00	4.004	GH104.PO63.052.00.15.N.IK

Spare parts

Article no.	Clamping screw	Tightening torque Nm
25900	M6x7.5x15IP	4-4.5
Article no.	Torx-Plus wrench	
25904	T15IP T-handle	



Polygon shank holders, according to ISO 26623, straight 0°

for cutting inserts type 106
with internal coolant supply

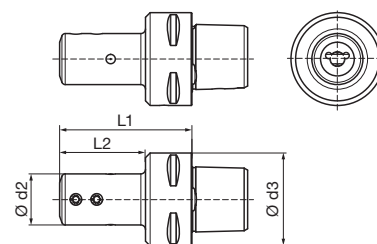

GH106

Article no. **25307**



d2 mm	d3	L1 mm	L2 mm	Code no.	Description
22.00	PSC 32	52.00	37.00	6.001	GH106.PO32.052.00.22.N.IK
22.00	PSC 40	57.00	37.00	6.002	GH106.PO40.057.00.22.N.IK
22.00	PSC 50	57.00	37.00	6.003	GH106.PO50.057.00.22.N.IK
22.00	PSC 63	60.00	38.00	6.004	GH106.PO63.060.00.22.N.IK

Spare parts

Article no.	Clamping screw	Tightening torque Nm
25900	M6x7.5x15IP	4-4.5
Article no.	Torx-Plus wrench	
25904	T15IP T-handle	
Code 15.000		



Polygon shank holders, according to ISO 26623, straight 0°

for cutting inserts type 108
with internal coolant supply

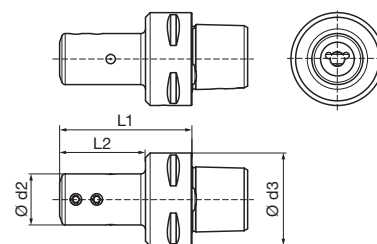

GH108

Article no. **27011**



d2 mm	d3	L1 mm	L2 mm	Code no.	Description
24.00	PSC 32	52.00	37.00	8.001	GH108.PO32.052.00.22.N.IK
24.00	PSC 40	57.00	37.00	8.002	GH108.PO40.057.00.22.N.IK
24.00	PSC 50	57.00	37.00	8.003	GH108.PO50.057.00.22.N.IK
24.00	PSC 63	60.00	38.00	8.004	GH108.PO63.060.00.22.N.IK

Spare parts

Article no.	Clamping screw	Tightening torque Nm
25900		
Code 6.000	M6x7.5x15IP	4-4.5

Article no.	Torx-Plus wrench
25904	
Code 15.000	T15IP T-handle



Polygon shank holders, according to ISO 26623, offset 90°

for cutting inserts type 104
with internal coolant supply

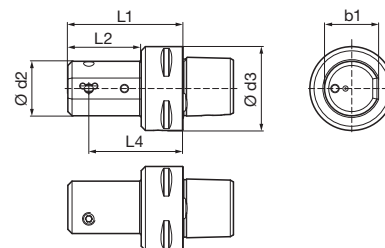

GH104

Right-hand design as shown. Left-hand design is mirror image.

Article no. **25012**



d2 mm	d3	L1 mm	L2 mm	L4 mm	b1 mm	Code no.	Description
26.00	PSC 32	55.00	40.00	45.00	25.00	4.001	GH104.PO32.055.90.15.R.IK
26.00	PSC 40	55.00	35.00	45.00	25.00	4.002	GH104.PO40.055.90.15.R.IK
26.00	PSC 50	55.00	35.00	45.00	25.00	4.003	GH104.PO50.055.90.15.R.IK
26.00	PSC 63	55.00	33.00	45.00	25.00	4.004	GH104.PO63.055.90.15.R.IK

On the left-hand design, the designation changes to .L

Article no. **25013**



Spare parts

Article no.	Clamping screw	Tightening torque Nm
25900 Code 6.000	M6x7.5x15IP	4-4.5
Article no.	Torx-Plus wrench	
25904 Code 15.000	T15IP T-handle	



Polygon shank holders, according to ISO 26623, offset 90°

for cutting inserts type 106
with internal coolant supply

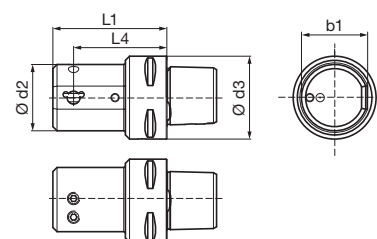

GH106

Right-hand design as shown. Left-hand design is mirror image.

Article no. **25308**



d2 mm	d3	L1 mm	L4 mm	b1 mm	Code no.	Description
32.00	PSC 32	55.00	45.00	31.00	6.001	GH106.PO32.055.90.22.R.IK
32.00	PSC 40	55.00	45.00	31.00	6.002	GH106.PO40.055.90.22.R.IK
32.00	PSC 50	60.00	50.00	31.00	6.003	GH106.PO50.060.90.22.R.IK
32.00	PSC 63	60.00	50.00	31.00	6.004	GH106.PO63.060.90.22.R.IK

On the left-hand design, the designation changes to .L

Article no. **25309**



Spare parts

Article no.	Clamping screw	Tightening torque Nm
25900 Code 6.000	M6x7.5x15IP	4-4.5
Article no.	Torx-Plus wrench	
25904 Code 15.000	T15IP T-handle	



Polygon shank holders, according to ISO 26623, offset 90°

for cutting inserts type 108
with internal coolant supply

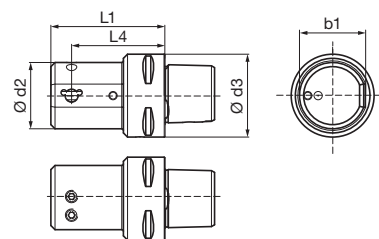

GH108

Right-hand design as shown. Left-hand design is mirror image.

Article no. **27012**



d2 mm	d3	L1 mm	L4 mm	b1 mm	Code no.	Description
32.00	PSC 32	55.00	45.00	31.00	8.001	GH108.PO32.055.90.22.R.IK
32.00	PSC 40	55.00	45.00	31.00	8.002	GH108.PO40.055.90.22.R.IK
32.00	PSC 50	60.00	50.00	31.00	8.003	GH108.PO50.060.90.22.R.IK
32.00	PSC 63	60.00	50.00	31.00	8.004	GH108.PO63.060.90.22.R.IK

On the left-hand design, the designation changes to .L

Article no. **27013**



Spare parts

Article no.	Clamping screw	Tightening torque Nm
25900 Code 6.000	M6x7.5x15IP	4-4.5
Article no.	Torx-Plus wrench	
25904 Code 15.000	T15IP T-handle	



HSK-T holders, according to ISO 12164-3, straight 0°

for cutting inserts type 104
with internal coolant supply

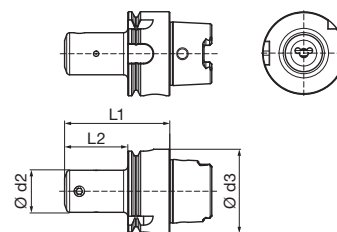

GH104

Article no. **25016**



d2 mm	d3	L1 mm	L2 mm	Code no.	Description
20.00	HSK-T 40	50.00	30.00	4.001	GH104.HS40.050.00.15.N.IK
20.00	HSK-T 63	56.00	30.00	4.002	GH104.HS63.056.00.15.N.IK

Spare parts

Article no.	Clamping screw	Tightening torque Nm
25900		
Code 6.000	M6x7.5x15IP	4-4.5

Article no.	Torx-Plus wrench
25904	
Code 15.000	T15IP T-handle



HSK-T holders, according to ISO 12164-3, straight 0°

for cutting inserts type 106
with internal coolant supply

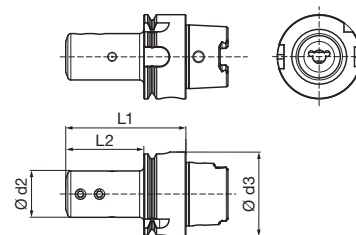

GH106

Article no. **25311**



d2 mm	d3	L1 mm	L2 mm	Code no.	Description
22.00	HSK-T 40	57.00	37.00	6.001	GH106.HS40.057.00.22.N.IK
22.00	HSK-T 63	63.00	37.00	6.002	GH106.HS63.063.00.22.N.IK

Spare parts

Article no.	Clamping screw	Tightening torque Nm
25900		
Code 6.000	M6x7.5x15IP	4-4.5

Article no.	Torx-Plus wrench
25904	
Code 15.000	T15IP T-handle



HSK-T holders, according to ISO 12164-3, straight 0°

for cutting inserts type 108
with internal coolant supply

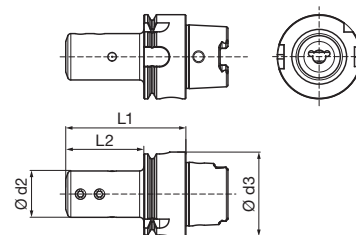

GH108

Article no. **27014**



d2 mm	d3	L1 mm	L2 mm	Code no.	Description
24.00	HSK-T 40	57.00	37.00	8.001	GH108.HS40.057.00.22.N.IK
24.00	HSK-T 63	63.00	37.00	8.002	GH108.HS63.063.00.22.N.IK

Spare parts

Article no.	Clamping screw	Tightening torque Nm
25900		
Code 6.000	M6x7.5x15IP	4-4.5

Article no.	Torx-Plus wrench
25904	
Code 15.000	T15IP T-handle



Square shank holders, straight 0°

for cutting inserts type 104
without internal coolant supply

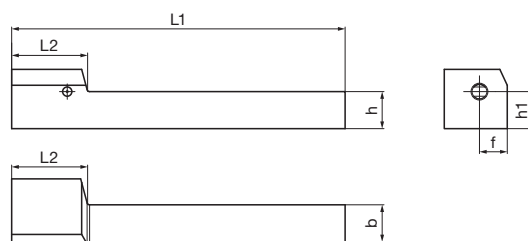

GH104

Right-hand design as shown. Left-hand design is mirror image.

Article no. **25019**



b mm	h mm	h1 mm	f mm	L1 mm	L2 mm	Code no.	Description
8.00	8.00	8.00	7.50	90.00	20.50	4.010	GH104.0808.090.00.15.R
9.52	9.52	9.52	7.62	88.90	20.00	4.100	GH104.0375.350.00.15.R
10.00	10.00	10.00	7.50	90.00	20.50	4.020	GH104.1010.090.00.15.R
12.00	12.00	12.00	7.50	90.00	20.50	4.030	GH104.1212.090.00.15.R
12.70	12.70	12.70	7.62	88.90	20.00	4.110	GH104.0500.350.00.15.R
15.87	15.87	15.87	7.62	101.60	20.00	4.120	GH104.0625.400.00.15.R
16.00	16.00	16.00	7.50	100.00	20.50	4.040	GH104.1616.100.00.15.R

On the left-hand design, the designation changes to .L

Article no. **25020**



Spare parts

Article no.	Clamping screw	Tightening torque Nm
25900 Code 6.000	M6x7.5x15IP	4-4.5

Article no.	Torx-Plus wrench
25904 Code 15.000	T15IP T-handle



Square shank holders, straight 0°

for cutting inserts type 106
without internal coolant supply

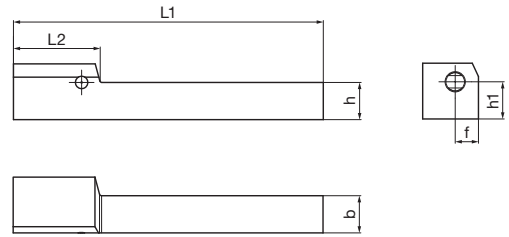

GH106

Right-hand design as shown. Left-hand design is mirror image.

Article no. **25314**



b mm	h mm	h1 mm	f mm	L1 mm	L2 mm	Code no.	Description
9.52	9.52	9.52	7.62	88.90	27.94	6.110	GH106.0375.350.00.22.R
10.00	10.00	10.00	7.50	100.00	28.00	6.010	GH106.1010.100.00.22.R
12.00	12.00	12.00	7.50	100.00	28.00	6.020	GH106.1212.100.00.22.R
12.70	12.70	12.70	7.62	88.90	27.94	6.120	GH106.0500.350.00.22.R
15.87	15.87	15.87	7.62	101.60	27.94	6.130	GH106.0625.400.00.22.R
16.00	16.00	16.00	7.50	120.00	28.00	6.030	GH106.1616.120.00.22.R

On the left-hand design, the designation changes to .L

Article no. **25315**



Spare parts

Article no.	Clamping screw	Tightening torque Nm
25900		
Code 6.000	M6x7.5x15IP	4-4.5

Article no.	Torx-Plus wrench
25904	
Code 15.000	T15IP T-handle



Square shank holders, straight 0°

for cutting inserts type 108
without internal coolant supply

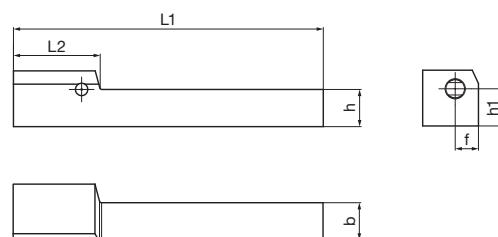

GH108

Right-hand design as shown. Left-hand design is mirror image.

Article no. **27007**



b mm	h mm	h1 mm	f mm	L1 mm	L2 mm	Code no.	Description
9.52	9.52	9.52	7.62	88.90	27.94	8.110	GH108.0375.350.00.22.R
10.00	10.00	10.00	7.50	100.00	28.00	8.010	GH108.1010.100.00.22.R
12.00	12.00	12.00	7.50	100.00	28.00	8.020	GH108.1212.100.00.22.R
12.70	12.70	12.70	7.62	88.90	27.94	8.120	GH108.0500.350.00.22.R
15.87	15.87	15.87	7.62	101.60	27.94	8.130	GH108.0625.400.00.22.R
16.00	16.00	16.00	7.50	120.00	28.00	8.030	GH108.1616.120.00.22.R

On the left-hand design, the designation changes to .L

Article no. **27008**



Spare parts

Article no.	Clamping screw	Tightening torque
25900		Nm
Code 6.000	M6x7.5x15IP	4-4.5

Article no.	Torx-Plus wrench
25904	
Code 15.000	T15IP T-handle



Square shank holders, straight 0°

for cutting inserts type 110
without internal coolant supply

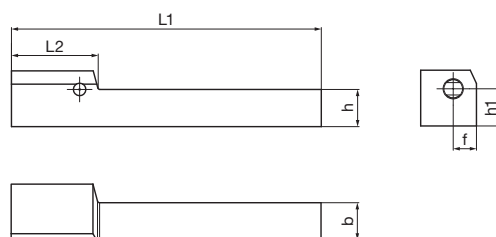

GH110

Right-hand design as shown. Left-hand design is mirror image.

Article no. **27052**



b mm	h mm	h1 mm	f mm	L1 mm	L2 mm	Code no.	Description
9.52	9.52	9.52	7.62	88.90	27.94	10.110	GH110.0375.350.00.22.R
10.00	10.00	10.00	7.50	100.00	28.00	10.010	GH110.1010.100.00.22.R
12.00	12.00	12.00	7.50	100.00	28.00	10.020	GH110.1212.100.00.22.R
12.70	12.70	12.70	7.62	88.90	27.94	10.120	GH110.0500.350.00.22.R
15.87	15.87	15.87	7.62	101.60	27.94	10.130	GH110.0625.400.00.22.R
16.00	16.00	16.00	7.50	120.00	28.00	10.030	GH110.1616.120.00.22.R

On the left-hand design, the designation changes to .L

Article no. **27053**



Spare parts

Article no.	Clamping screw	Tightening torque Nm
25900		
Code 6.000	M6x7.5x15IP	4-4.5

Article no.	Torx-Plus wrench
25904	
Code 15.000	T15IP T-handle



Square shank holders, 90° offset

for cutting inserts type 104
without internal coolant supply

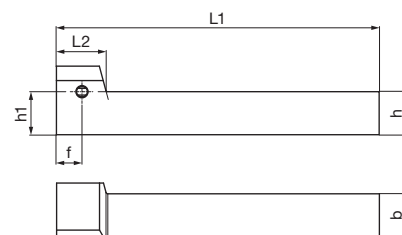

GH104

Right-hand design as shown. Left-hand design is mirror image.

Article no. **25002**



b mm	h mm	h1 mm	f mm	L1 mm	L2 mm	Code no.	Description
8.00	8.00	8.00	9.50	90.00	18.50	4.001	GH104.0808.090.90.15.R
9.52	9.52	9.52	7.62	88.90	16.51	4.010	GH104.0375.350.90.15.R
10.00	10.00	10.00	9.50	90.00	18.50	4.002	GH104.1010.090.90.15.R
12.00	12.00	12.00	9.50	90.00	18.50	4.003	GH104.1212.090.90.15.R
12.70	12.70	12.70	7.62	88.90	16.51	4.011	GH104.0500.350.90.15.R
15.87	15.87	15.87	7.62	101.60	16.51	4.012	GH104.0625.400.90.15.R
16.00	16.00	16.00	9.50	120.00	18.50	4.004	GH104.1616.120.90.15.R

On the left-hand design, the designation changes to .L

Article no. **25003**



Spare parts

Article no.	Clamping screw	Tightening torque Nm
25900 Code 6.000	M6x7.5x15IP	4-4.5

Article no.	Torx-Plus wrench
25904 Code 15.000	T15IP T-handle



Square shank holders, 90° offset

for cutting inserts type 106
without internal coolant supply

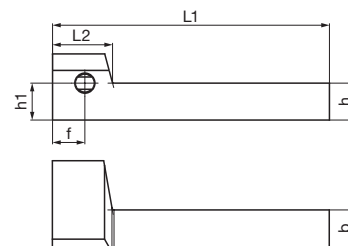

GH106

Right-hand design as shown. Left-hand design is mirror image.

Article no. **25304**



b mm	h mm	h1 mm	f mm	L1 mm	L2 mm	Code no.	Description
9.52	9.52	9.52	10.67	88.90	19.50	6.010	GH106.0375.350.90.22.R
10.00	10.00	10.00	10.50	90.00	19.50	6.001	GH106.1010.090.90.22.R
12.00	12.00	12.00	10.50	90.00	19.50	6.002	GH106.1212.090.90.22.R
12.70	12.70	12.70	10.67	88.90	19.50	6.011	GH106.0500.350.90.22.R
15.87	15.87	15.87	10.67	101.60	19.50	6.012	GH106.0625.400.90.22.R
16.00	16.00	16.00	10.50	120.00	19.50	6.003	GH106.1616.120.90.22.R

On the left-hand design, the designation changes to .L

Article no. **25305**



Spare parts

Article no.	Clamping screw	Tightening torque
25900		Nm
Code 6.000	M6x7.5x15IP	4-4.5

Article no.	Torx-Plus wrench
25904	
Code 15.000	T15IP T-handle



Square shank holders, 90° offset

for cutting inserts type 108
without internal coolant supply

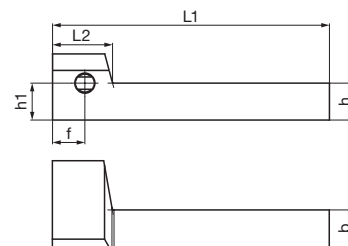

GH108

Right-hand design as shown. Left-hand design is mirror image.

Article no. **27009**



b mm	h mm	h1 mm	f mm	L1 mm	L2 mm	Code no.	Description
9.52	9.52	9.52	11.43	88.90	20.32	8.010	GH108.0375.350.90.22.R
10.00	10.00	10.00	11.50	90.00	20.50	8.001	GH108.1010.090.90.22.R
12.00	12.00	12.00	11.50	90.00	20.50	8.002	GH108.1212.090.90.22.R
12.70	12.70	12.70	11.43	88.90	20.32	8.011	GH108.0500.350.90.22.R
15.87	15.87	15.87	11.43	101.60	20.32	8.012	GH108.0625.400.90.22.R
16.00	16.00	16.00	11.50	120.00	20.50	8.003	GH108.1616.120.90.22.R

On the left-hand design, the designation changes to .L

Article no. **27010**



Spare parts

Article no.	Clamping screw	Tightening torque Nm
25900		
Code 6.000	M6x7.5x15IP	4-4.5

Article no.	Torx-Plus wrench
25904	
Code 15.000	T15IP T-handle



Square shank holders, 90° offset

for cutting inserts type 110
without internal coolant supply

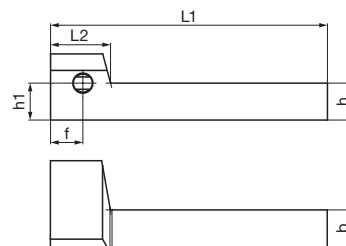

GH110

Right-hand design as shown. Left-hand design is mirror image.

Article no. **27054**



b mm	h mm	h1 mm	f mm	L1 mm	L2 mm	Code no.	Description
9.52	9.52	9.52	11.43	88.90	20.32	10.010	GH110.0375.350.90.22.R
10.00	10.00	10.00	11.50	90.00	20.50	10.001	GH110.1010.090.90.22.R
12.00	12.00	12.00	11.50	90.00	20.50	10.002	GH110.1212.090.90.22.R
12.70	12.70	12.70	11.43	88.90	20.32	10.011	GH110.0500.350.90.22.R
15.87	15.87	15.87	11.43	101.60	20.32	10.012	GH110.0625.400.90.22.R
16.00	16.00	16.00	11.50	120.00	20.50	10.003	GH110.1616.120.90.22.R

On the left-hand design, the designation changes to .L

Article no. **27055**



Spare parts

Article no.	Clamping screw	Tightening torque
25900		Nm
Code 6.000	M6x7.5x15IP	4-4.5

Article no.	Torx-Plus wrench
25904	
Code 15.000	T15IP T-handle



Square shank holders 90° offset and stepped, without IC

for cutting inserts type 104
without internal coolant supply



GH104

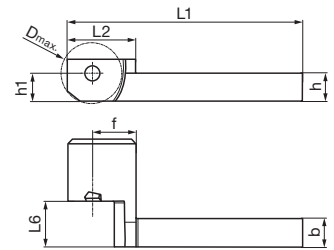

Article no. **25004**



b mm	h mm	h1 mm	f mm	L1 mm	L2 mm	L6 mm	Dmax. mm	Code no.	Description
10.00	10.00	10.00	9.60	100.00	29.00	19.60	25.00	4.001	GH104.1010.100.90.15.N
12.00	12.00	12.00	7.60	100.00	29.00	19.60	25.00	4.002	GH104.1212.100.90.15.N

Square shank holders 90° offset and stepped, without IC

for cutting inserts type 106
without internal coolant supply



GH106

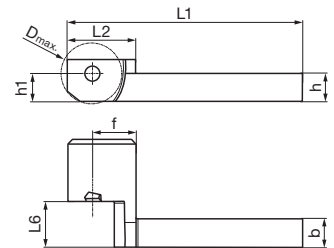

Article no. **25303**



b mm	h mm	h1 mm	f mm	L1 mm	L2 mm	L6 mm	Dmax. mm	Code no.	Description
10.00	10.00	10.00	9.60	100.00	29.00	19.60	25.00	6.001	GH106.1010.100.90.15.N
12.00	12.00	12.00	7.60	100.00	29.00	19.60	25.00	6.002	GH106.1212.100.90.15.N



Square shank holders 90° offset and stepped, with IC

for cutting inserts type 104
with internal coolant supply



GH104

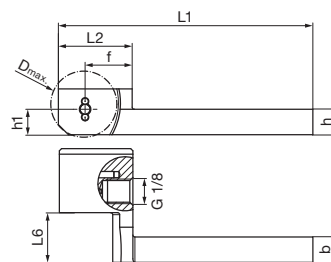

Article no. **25005**



b mm	h mm	h1 mm	f mm	L1 mm	L2 mm	L6 mm	Dmax. mm	Code no.	Description
10.00	10.00	10.00	9.60	100.00	29.00	19.60	25.00	4.001	GH104.1010.100.90.15.N.IK
12.00	12.00	12.00	7.60	100.00	29.00	19.60	25.00	4.002	GH104.1212.100.90.15.N.IK

Square shank holders 90° offset and stepped, with IC

for cutting inserts type 106
with internal coolant supply



GH106

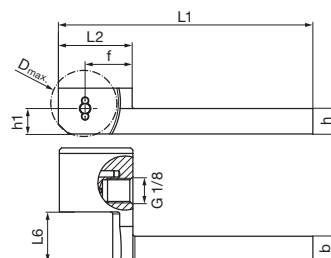

Article no. **25306**



b mm	h mm	h1 mm	f mm	L1 mm	L2 mm	L6 mm	Dmax. mm	Code no.	Description
10.00	10.00	10.00	9.60	100.00	29.00	19.60	25.00	6.001	GH106.1010.100.90.15.N.IK
12.00	12.00	12.00	7.60	100.00	29.00	19.60	25.00	6.002	GH106.1212.100.90.15.N.IK



Square shank holder straight, external machining, without IC

for indexable inserts type 305 • grooving depth up to 5 mm
without internal coolant supply

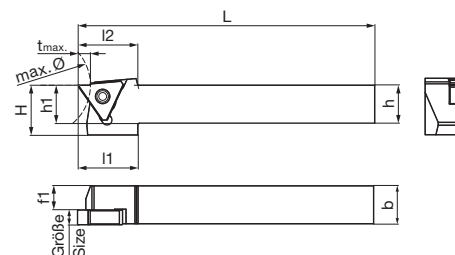

max. Ø	t _{max.}
80	5
160	4,5
240	4
320	3,5
axial	3

GH305

Right-hand design as shown. Left-hand design is mirror image.

Article no. **25350**



h mm	b mm	L mm	h1 mm	Dmax. mm	l1 mm	l2 mm	f1 mm	Size	Code no.	Description
10.00	10.00	125.00	10.00	20.00	24.00	25.00	8.20	04	12.013	GH305.1010.125.00.04.R
12.00	12.00	125.00	12.00	20.00	24.00	25.00	8.20	04	12.014	GH305.1212.125.00.04.R
12.70	12.70	127.00	12.70	21.70	25.40	25.40	8.90	04	12.033	GH305.0500.500.00.04.R
15.87	15.87	127.00	15.87	20.87	25.40	25.40	12.07	04	12.021	GH305.0625.500.00.04.R
16.00	16.00	125.00	16.00	21.00	25.00	25.00	12.20	04	12.001	GH305.1616.125.00.04.R
19.05	19.05	127.00	19.05	24.05	25.40	25.40	15.25	04	12.022	GH305.0750.500.00.04.R
20.00	20.00	125.00	20.00	25.00	25.00	25.00	16.20	04	12.002	GH305.2020.125.00.04.R
25.00	25.00	150.00	25.00	30.00	25.00	25.00	21.20	04	12.003	GH305.2525.150.00.04.R
25.40	25.40	152.40	25.40	30.40	25.40	25.40	21.60	04	12.023	GH305.1000.600.00.04.R
10.00	10.00	125.00	10.00	20.00	24.00	25.00	8.20	06	12.015	GH305.1010.125.00.06.R
12.00	12.00	125.00	12.00	20.00	24.00	25.00	8.20	06	12.016	GH305.1212.125.00.06.R
12.70	12.70	127.00	12.70	21.70	25.40	25.40	6.90	06	12.034	GH305.0500.500.00.06.R
15.87	15.87	127.00	15.87	20.87	25.40	25.40	10.07	06	12.024	GH305.0625.500.00.06.R
16.00	16.00	125.00	16.00	21.00	25.00	25.00	10.20	06	12.004	GH305.1616.125.00.06.R
19.05	19.05	127.00	19.05	24.05	25.40	25.40	13.25	06	12.025	GH305.0750.500.00.06.R
20.00	20.00	125.00	20.00	25.00	25.00	25.00	14.20	06	12.005	GH305.2020.125.00.06.R
25.00	25.00	150.00	25.00	30.00	25.00	25.00	19.20	06	12.006	GH305.2525.150.00.06.R
25.40	25.40	152.40	25.40	30.40	25.40	25.40	19.60	06	12.026	GH305.1000.600.00.06.R
10.00	10.00	125.00	10.00	20.00	24.00	25.00	8.20	08	12.017	GH305.1010.125.00.08.R
12.00	12.00	125.00	12.00	20.00	24.00	25.00	8.20	08	12.018	GH305.1212.125.00.08.R
12.70	12.70	127.00	12.70	21.70	25.40	25.40	4.90	08	12.035	GH305.0500.500.00.08.R
15.87	15.87	127.00	15.87	20.87	25.40	25.40	8.07	08	12.027	GH305.0625.500.00.08.R
16.00	16.00	125.00	16.00	21.00	25.00	25.00	8.20	08	12.007	GH305.1616.125.00.08.R
19.05	19.05	127.00	19.05	24.05	25.40	25.40	11.25	08	12.028	GH305.0750.500.00.08.R
20.00	20.00	125.00	20.00	25.00	25.00	25.00	12.20	08	12.008	GH305.2020.125.00.08.R
25.00	25.00	150.00	25.00	30.00	25.00	25.00	17.20	08	12.009	GH305.2525.150.00.08.R
25.40	25.40	152.40	25.40	30.40	25.40	25.40	17.60	08	12.029	GH305.1000.600.00.08.R
10.00	10.00	125.00	10.00	20.00	24.00	25.00	8.20	12	12.019	GH305.1010.125.00.12.R
12.00	12.00	125.00	12.00	20.00	24.00	25.00	8.20	12	12.020	GH305.1212.125.00.12.R
12.70	12.70	127.00	12.70	21.70	25.40	25.40	8.90	12	12.036	GH305.0500.500.00.12.R
15.87	15.87	127.00	15.87	20.87	24.40	25.40	8.27	12	12.030	GH305.0625.500.00.12.R
16.00	16.00	125.00	16.00	21.00	24.00	25.00	8.60	12	12.010	GH305.1616.125.00.12.R
19.05	19.05	127.00	19.05	24.05	25.40	25.40	7.25	12	12.031	GH305.0750.500.00.12.R
20.00	20.00	125.00	20.00	25.00	25.00	25.00	8.20	12	12.011	GH305.2020.125.00.12.R
25.00	25.00	150.00	25.00	30.00	25.00	25.00	13.20	12	12.012	GH305.2525.150.00.12.R
25.40	25.40	152.40	25.40	30.40	25.40	25.40	13.60	12	12.032	GH305.1000.600.00.12.R

On the left-hand design, the designation changes to .L

Article no. **25351**



Spare parts

Article no.	Clamping screw	Tightening torque Nm	Size	Description
25901				
Code 4.002	M4x11x15IP	3-3.5	04-06	GH305.1010.125....; GH305.1212.125...
Code 4.000	M4x15x15IP	3-3.5	04-06	GH305.0625.500....; GH305.0750.500...
Code 4.000	M4x15x15IP	3-3.5	04-06	GH305.1616.125....; GH305.1000.600...
Code 4.000	M4x15x15IP	3-3.5	04-06	GH305.2020.125....; GH305.2525.150...
Code 4.000	M4x15x15IP	3-3.5	08	GH305....
Code 4.003	M4x17x15IP	3-3.5	12	GH305....
Article no.	Torx-Plus wrench			
25904				
Code 15.000	T15IP T-handle			



Square shank holder straight, external machining, without IC

for indexable inserts type 222 • tmax. 21 mm: maximum grooving depth before 2nd cutting edge engages
without internal coolant supply

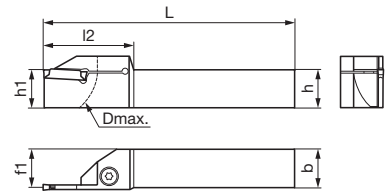

Dmax. = 52	
max. Ø	tmax.
52	26
65	24
82	22
100	21
160	20

GH222

Right-hand design as shown. Left-hand design is mirror image.

Article no. **26100**



h mm	b mm	L mm	l2 mm	h1 mm	f1 mm	Dmax. mm	Size	Code no.	Description
10.00	10.00	125.00	30.00	10.00	9.00	26.00	02	22.110	GH222.1010.125.00.02.R.00.26
12.00	12.00	125.00	30.00	12.00	11.00	26.00	02	22.120	GH222.1212.125.00.02.R.00.26
12.00	12.00	125.00	34.00	12.00	11.00	34.00	02	22.121	GH222.1212.125.00.02.R.00.34
12.70	12.70	127.00	30.00	12.70	11.70	26.00	02	22.130	GH222.0500.500.00.02.R.00.26
12.70	12.70	127.00	34.00	12.70	11.70	34.00	02	22.131	GH222.0500.500.00.02.R.00.34
15.87	15.87	127.00	39.50	15.87	14.87	45.00	02	22.140	GH222.0625.500.00.02.R.00.45
16.00	16.00	125.00	39.50	16.00	15.00	45.00	02	22.150	GH222.1616.125.00.02.R.00.45
19.05	19.05	127.00	39.00	19.05	19.05	45.00	02	22.160	GH222.0750.500.00.02.R.00.45
20.00	20.00	125.00	39.00	20.00	20.00	45.00	02	22.170	GH222.2020.125.00.02.R.00.45
12.00	12.00	125.00	34.00	12.00	10.50	34.00	03	22.020	GH222.1212.125.00.03.R.00.34
12.70	12.70	126.15	34.00	12.70	11.20	34.00	03	22.030	GH222.0500.500.00.03.R.00.34
15.87	15.87	127.00	39.50	15.87	14.37	45.00	03	22.040	GH222.0625.500.00.03.R.00.45
16.00	16.00	125.00	39.50	16.00	14.50	45.00	03	22.050	GH222.1616.125.00.03.R.00.45
19.05	19.05	127.00	45.00	19.05	19.05	52.00	03	22.060	GH222.0750.500.00.03.R.00.52
20.00	20.00	125.00	45.00	20.00	20.00	52.00	03	22.070	GH222.2020.125.00.03.R.00.52
25.00	25.00	150.00	45.00	25.00	25.00	52.00	03	22.080	GH222.2525.150.00.03.R.00.52
25.40	25.40	152.40	45.00	25.40	25.40	52.00	03	22.090	GH222.1000.600.00.03.R.00.52

On the left-hand design, the designation changes to .L

Article no. **26101**



Spare parts

Article no.	Clamping screw	Tightening torque Nm	Description
25906	M4x15.5x15IP	3.5	GH222.1212....; GH222.0500....; GH222.0625....; GH222.1616....
Code 4.000			

Article no.	Clamping screw	Tightening torque Nm	Description
25907	M5x18x25IP	6	GH222.0750....; GH222.2020....; GH222.2525....; GH222.1000....
Code 5.000			

Article no.	Torx-Plus wrench
25904	T15IP
Code 15.001	

Article no.	Torx-Plus wrench
25922	T25IP
Code 15.000	



Square shank holders straight, external machining, with IC

for indexable inserts type 305 • grooving depth up to 5 mm
with internal coolant supply from above and below

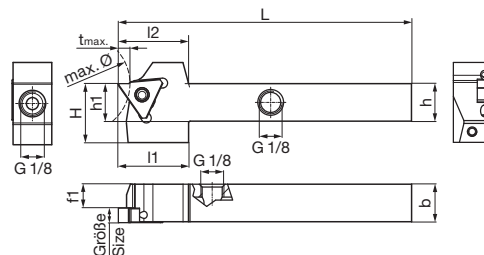

max. Ø	tmax.
80	5
160	4,5
240	4
320	3,5
axial	3

GH305

Right-hand design as shown. Left-hand design is mirror image.

Article no. **25352**



h mm	b mm	L mm	h1 mm	H mm	l1 mm	l2 mm	f1 mm	Size	Code no.	Description
12.00	12.00	125.00	12.00	21.00	30.00	30.00	10.20	04	12.014	GH305.1212.125.00.04.R.IK
12.70	12.70	127.00	12.70	21.70	30.48	30.48	8.90	04	12.033	GH305.0500.500.00.04.R.IK
15.87	15.87	127.00	15.87	24.87	30.48	30.48	12.07	04	12.021	GH305.0625.500.00.04.R.IK
16.00	16.00	125.00	16.00	25.00	30.00	30.00	12.20	04	12.001	GH305.1616.125.00.04.R.IK
19.05	19.05	127.00	19.05	24.05	30.48	30.48	15.25	04	12.022	GH305.0750.500.00.04.R.IK
20.00	20.00	125.00	20.00	25.00	30.00	30.00	16.20	04	12.002	GH305.2020.125.00.04.R.IK
25.00	25.00	150.00	25.00	30.00	30.00	30.00	21.20	04	12.003	GH305.2525.150.00.04.R.IK
25.40	25.40	152.40	25.40	30.40	30.48	30.48	21.60	04	12.023	GH305.1000.600.00.04.R.IK
12.00	12.00	125.00	12.00	21.00	30.00	30.00	10.20	06	12.016	GH305.1212.125.00.06.R.IK
12.70	12.70	127.00	12.70	21.70	30.48	30.48	6.90	06	12.034	GH305.0500.500.00.06.R.IK
15.87	15.87	127.00	15.87	24.87	30.48	30.48	10.07	06	12.024	GH305.0625.500.00.06.R.IK
16.00	16.00	125.00	16.00	25.00	30.00	30.00	10.20	06	12.004	GH305.1616.125.00.06.R.IK
19.05	19.05	127.00	19.05	24.05	30.48	30.48	13.25	06	12.025	GH305.0750.500.00.06.R.IK
20.00	20.00	125.00	20.00	25.00	30.00	30.00	14.20	06	12.005	GH305.2020.125.00.06.R.IK
25.00	25.00	150.00	25.00	30.00	30.00	30.00	19.20	06	12.006	GH305.2525.150.00.06.R.IK
25.40	25.40	152.40	25.40	30.40	30.48	30.48	19.60	06	12.026	GH305.1000.600.00.06.R.IK
12.00	12.00	125.00	12.00	21.00	30.00	30.00	10.20	08	12.018	GH305.1212.125.00.08.R.IK
12.70	12.70	127.00	12.70	21.70	30.48	30.48	4.90	08	12.035	GH305.0500.500.00.08.R.IK
15.87	15.87	127.00	15.87	24.87	30.48	30.48	8.07	08	12.027	GH305.0625.500.00.08.R.IK
16.00	16.00	125.00	16.00	25.00	30.00	30.00	8.20	08	12.007	GH305.1616.125.00.08.R.IK
19.05	19.05	127.00	19.05	24.05	30.48	30.48	11.25	08	12.028	GH305.0750.500.00.08.R.IK
20.00	20.00	125.00	20.00	25.00	30.00	30.00	12.20	08	12.008	GH305.2020.125.00.08.R.IK
25.00	25.00	150.00	25.00	30.00	30.00	30.00	17.20	08	12.009	GH305.2525.150.00.08.R.IK
25.40	25.40	152.40	25.40	30.40	30.48	30.48	17.60	08	12.029	GH305.1000.600.00.08.R.IK
12.00	12.00	125.00	12.00	25.00	30.00	30.00	10.20	12	12.020	GH305.1212.125.00.12.R.IK
12.70	12.70	127.00	12.70	25.70	30.48	30.48	10.90	12	12.036	GH305.0500.500.00.12.R.IK
15.87	15.87	127.00	15.87	24.87	30.48	30.48	8.07	12	12.030	GH305.0625.500.00.12.R.IK
16.00	16.00	125.00	16.00	25.00	30.00	30.00	8.20	12	12.010	GH305.1616.125.00.12.R.IK
19.05	19.05	127.00	19.05	24.05	30.48	30.48	7.25	12	12.031	GH305.0750.500.00.12.R.IK
20.00	20.00	125.00	20.00	25.00	30.00	30.00	8.20	12	12.011	GH305.2020.125.00.12.R.IK
25.00	25.00	150.00	25.00	30.00	30.00	30.00	13.20	12	12.012	GH305.2525.150.00.12.R.IK
25.40	25.40	152.40	25.40	30.40	30.48	30.48	13.60	12	12.032	GH305.1000.600.00.12.R.IK

On the left-hand design, the designation changes to .L

Article no. **25353**



Spare parts

Article no.	Clamping screw	Tightening torque Nm	Size	Description
25901				
Code 4.002	M4x11x15IP	3-3.5	04-06	GH305.1010.125....; GH305.1212.125...
Code 4.000	M4x15x15IP	3-3.5	04-06	GH305.0625.500....; GH305.0750.500...
Code 4.000	M4x15x15IP	3-3.5	04-06	GH305.1616.125....; GH305.1000.600...
Code 4.000	M4x15x15IP	3-3.5	04-06	GH305.2020.125....; GH305.2525.150...
Code 4.000	M4x15x15IP	3-3.5	08	GH305....
Code 4.003	M4x17x15IP	3-3.5	12	GH305....

Article no.	Torx-Plus wrench
25904	
Code 15.000	T15IP T-handle

Tool holders



Square shank holders straight, external machining, with IC

for indexable inserts type 222 • t_{max}. 21 mm: maximum grooving depth before 2nd cutting edge engages

with internal coolant supply from above and below • TL (tubeless): tubeless coolant supply from shank size 19.05x19.05 from shank bottom

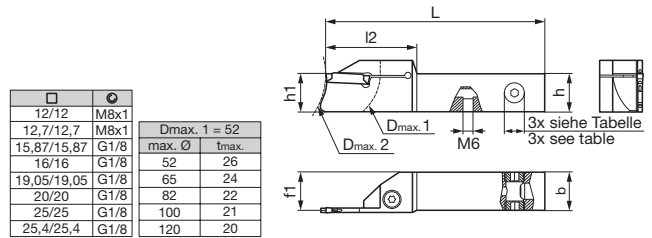

GH222

Right-hand design as shown. Left-hand design is mirror image.

Article no. **26102**



h mm	b mm	L mm	l2 mm	h1 mm	f1 mm	Dmax. 1 mm	Dmax. 2 mm	Size	Code no.	Description
10.00	10.00	125.00	30.00	10.00	9.00	26.00	65.00	02	22.110	GH222.1010.125.00.02.R.IK.26
12.00	12.00	125.00	30.00	12.00	11.00	26.00	65.00	02	22.120	GH222.1212.125.00.02.R.IK.26
12.00	12.00	125.00	34.00	12.00	11.00	34.00	65.00	02	22.121	GH222.1212.125.00.02.R.IK.34
12.70	12.70	127.00	30.00	12.70	11.70	26.00	65.00	02	22.130	GH222.0500.500.00.02.R.IK.26
12.70	12.70	127.00	34.00	12.70	11.70	34.00	65.00	02	22.131	GH222.0500.500.00.02.R.IK.34
15.87	15.87	127.00	39.50	15.87	14.87	45.00	82.00	02	22.140	GH222.0625.500.00.02.R.IK.45
16.00	16.00	125.00	39.50	16.00	15.00	45.00	82.00	02	22.150	GH222.1616.125.00.02.R.IK.45
19.05	19.05	127.00	39.00	19.05	19.05	45.00	82.00	02	22.160	GH222.0750.404.00.02.R.IK.45
20.00	20.00	102.50	39.00	20.00	20.00	45.00	82.00	02	22.170	GH222.2020.103.00.02.R.IK.45
12.00	12.00	125.00	34.00	12.00	10.50	34.00	65.00	03	22.020	GH222.1212.125.00.03.R.IK.34
12.70	12.70	127.00	34.00	12.70	11.20	34.00	65.00	03	22.030	GH222.0500.500.00.03.R.IK.34
15.87	15.87	127.00	39.50	15.87	14.37	45.00	82.00	03	22.040	GH222.0625.500.00.03.R.IK.45
16.00	16.00	125.00	39.50	16.00	14.50	45.00	82.00	03	22.050	GH222.1616.125.00.03.R.IK.45
19.05	19.05	108.50	45.00	19.05	19.05	52.00	82.00	03	22.060	GH222.0750.427.00.03.R.IK.52
20.00	20.00	108.50	45.00	20.00	20.00	52.00	82.00	03	22.070	GH222.2020.109.00.03.R.IK.52
25.00	25.00	120.50	45.00	25.00	25.00	52.00	120.00	03	22.080	GH222.2525.120.00.03.R.IK.52
25.40	25.40	120.50	45.00	25.40	25.40	52.00	120.00	03	22.090	GH222.1000.474.00.03.R.IK.52

On the left-hand design, the designation changes to .L

Article no. **26103**



Spare parts

Article no.	Clamping screw	Tightening torque Nm	Description
25906			
Code 4.000	M4x15.5x15IP	3.5	GH222.1212....; GH222.0500....; GH222.0625....; GH222.1616....

Article no.	Clamping screw	Tightening torque Nm	Description
25907			
Code 5.000	M5x18x25IP	6	GH222.0750....; GH222.2020....; GH222.2525....; GH222.1000....

Article no.	Torx-Plus wrench
25904	
Code 15.001	T15IP

Article no.	Torx-Plus wrench
25922	
Code 15.000	T25IP



Square shank holders straight, external machining, IC adjustable

for indexable inserts type 305 • grooving depth up to 5 mm
with internal coolant supply

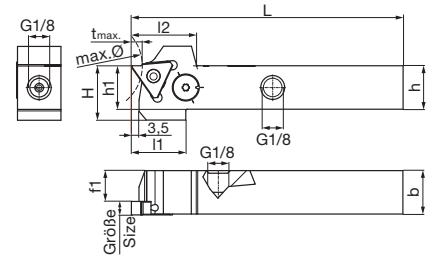

max. Ø	tmax.
80	5
160	4,5
240	4
320	3,5
axial	3

GH305

Right-hand design as shown. Left-hand design is mirror image.

Article no. **25372**



h mm	b mm	L mm	h1 mm	H mm	l1 mm	l2 mm	f1 mm	Size	Code no.	Description
15.87	15.87	127.00	15.87	24.87	30.48	30.48	12.07	04	12.021	GH305.0625.500.00.04.R.IK.EST
16.00	16.00	125.00	16.00	25.00	30.00	30.00	12.20	04	12.001	GH305.1616.125.00.04.R.IK.EST
19.05	19.05	127.00	19.05	24.05	30.48	30.48	15.25	04	12.022	GH305.0750.500.00.04.R.IK.EST
20.00	20.00	125.00	20.00	25.00	30.00	30.00	16.20	04	12.002	GH305.2020.125.00.04.R.IK.EST
25.00	25.00	150.00	25.00	30.00	30.00	30.00	21.20	04	12.003	GH305.2525.150.00.04.R.IK.EST
25.40	25.40	152.40	25.40	30.40	30.48	30.48	21.60	04	12.023	GH305.1000.600.00.04.R.IK.EST
15.87	15.87	127.00	15.87	24.87	30.48	30.48	10.07	06	12.024	GH305.0625.500.00.06.R.IK.EST
16.00	16.00	125.00	16.00	25.00	30.00	30.00	10.20	06	12.004	GH305.1616.125.00.06.R.IK.EST
19.05	19.05	127.00	19.05	24.05	30.48	30.48	13.25	06	12.025	GH305.0750.500.00.06.R.IK.EST
20.00	20.00	125.00	20.00	25.00	30.00	30.00	14.20	06	12.005	GH305.2020.125.00.06.R.IK.EST
25.00	25.00	150.00	25.00	30.00	30.00	30.00	19.20	06	12.006	GH305.2525.150.00.06.R.IK.EST
25.40	25.40	152.40	25.40	30.40	30.48	30.48	19.60	06	12.026	GH305.1000.600.00.06.R.IK.EST

Spare parts

Article no.	Clamping screw	Tightening torque Nm	Size	Description
25901				
Code 4.002	M4x11x15IP	3-3.5	04-06	GH305.1010.125....; GH305.1212.125...
Code 4.000	M4x15x15IP	3-3.5	04-06	GH305.0625.500....; GH305.0750.500...
Code 4.000	M4x15x15IP	3-3.5	04-06	GH305.1616.125....; GH305.1000.600...
Code 4.000	M4x15x15IP	3-3.5	04-06	GH305.2020.125....; GH305.2525.150...
Code 4.000	M4x15x15IP	3-3.5	08	GH305....
Code 4.003	M4x17x15IP	3-3.5	12	GH305....

Article no.	Torx-Plus wrench
25904	
Code 15.000	T15IP T-handle



Tool holders for indexable inserts

Square shank holders 90° offset, external machining, without IC

for indexable inserts type 305 • grooving depth up to 3.5 mm
without internal coolant supply

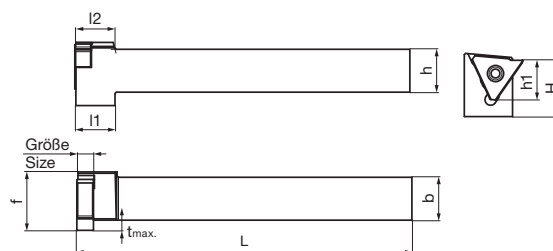
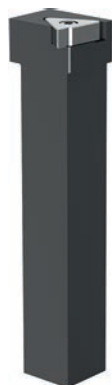

GH305

Right-hand design as shown. Left-hand design is mirror image.

Article no. **25356**



h mm	b mm	L mm	h1 mm	H mm	l1 mm	l2 mm	f mm	Size	Code no.	Description
10.00	10.00	125.00	10.00	19.00	14.60	14.60	13.80	04	12.013	GH305.1010.125.90.04.R
12.00	12.00	125.00	12.00	21.00	14.60	14.60	15.80	04	12.014	GH305.1212.125.90.04.R
12.70	12.70	127.00	12.70	21.70	14.84	14.84	16.50	04	12.033	GH305.0500.500.90.04.R
15.87	15.87	127.00	15.87	20.87	14.84	14.84	19.67	04	12.021	GH305.0625.500.90.04.R
16.00	16.00	125.00	16.00	21.00	14.60	14.60	19.80	04	12.001	GH305.1616.125.90.04.R
19.05	19.05	127.00	19.05	24.05	14.84	14.84	22.85	04	12.022	GH305.0750.500.90.04.R
20.00	20.00	125.00	20.00	25.00	14.60	14.60	23.80	04	12.002	GH305.2020.125.90.04.R
25.00	25.00	150.00	25.00	30.00	14.60	14.60	28.80	04	12.003	GH305.2525.150.90.04.R
25.40	25.40	152.40	25.40	30.40	14.84	14.84	29.20	04	12.023	GH305.1000.600.90.04.R
10.00	10.00	125.00	10.00	19.00	14.60	14.60	13.80	06	12.015	GH305.1010.125.90.06.R
12.00	12.00	125.00	12.00	21.00	14.60	14.60	15.80	06	12.016	GH305.1212.125.90.06.R
12.70	12.70	127.00	12.70	21.70	14.84	14.84	16.50	06	12.034	GH305.0500.500.90.06.R
15.87	15.87	127.00	15.87	20.87	14.84	14.84	19.67	06	12.024	GH305.0625.500.90.06.R
16.00	16.00	125.00	16.00	21.00	14.60	14.60	19.80	06	12.004	GH305.1616.125.90.06.R
19.05	19.05	127.00	19.05	24.05	14.84	14.84	22.85	06	12.025	GH305.0750.500.90.06.R
20.00	20.00	125.00	20.00	25.00	14.60	14.60	23.80	06	12.005	GH305.2020.125.90.06.R
25.00	25.00	150.00	25.00	30.00	14.60	14.60	28.80	06	12.006	GH305.2525.150.90.06.R
25.40	25.40	152.40	25.40	30.40	14.84	14.84	29.20	06	12.026	GH305.1000.600.90.06.R
10.00	10.00	125.00	10.00	19.00	16.60	16.60	13.80	08	12.017	GH305.1010.125.90.08.R
12.00	12.00	125.00	12.00	21.00	16.60	16.60	15.80	08	12.018	GH305.1212.125.90.08.R
12.70	12.70	127.00	12.70	21.70	16.84	16.84	16.50	08	12.035	GH305.0500.500.90.08.R
15.87	15.87	127.00	15.87	20.87	16.84	16.84	19.67	08	12.027	GH305.0625.500.90.08.R
16.00	16.00	125.00	16.00	21.00	16.60	16.60	19.80	08	12.007	GH305.1616.125.90.08.R
19.05	19.05	127.00	19.05	24.05	16.84	16.84	22.85	08	12.028	GH305.0750.500.90.08.R
20.00	20.00	125.00	20.00	25.00	16.60	16.60	23.80	08	12.008	GH305.2020.125.90.08.R
25.00	25.00	150.00	25.00	30.00	16.60	16.60	28.80	08	12.009	GH305.2525.150.90.08.R
25.40	25.40	152.40	25.40	30.40	16.84	16.84	29.20	08	12.029	GH305.1000.600.90.08.R
10.00	10.00	125.00	10.00	19.00	16.60	20.60	13.80	12	12.019	GH305.1010.125.90.12.R
12.00	12.00	125.00	12.00	21.00	20.60	20.60	15.80	12	12.020	GH305.1212.125.90.12.R
12.70	12.70	127.00	12.70	21.70	20.84	20.84	16.50	12	12.036	GH305.0500.500.90.12.R
15.87	15.87	127.00	15.87	20.87	20.84	20.84	19.67	12	12.030	GH305.0625.500.90.12.R
16.00	16.00	125.00	16.00	21.00	20.60	20.60	19.80	12	12.010	GH305.1616.125.90.12.R
19.05	19.05	127.00	19.05	24.05	20.84	20.84	22.85	12	12.031	GH305.0750.500.90.12.R
20.00	20.00	125.00	20.00	25.00	20.60	20.60	23.80	12	12.011	GH305.2020.125.90.12.R
25.00	25.00	150.00	25.00	30.00	20.60	20.60	28.80	12	12.012	GH305.2525.150.90.12.R
25.40	25.40	152.40	25.40	30.40	20.84	20.84	29.20	12	12.032	GH305.1000.600.90.12.R

On the left-hand design, the designation changes to .L

Article no. **25357**



Spare parts

Article no.	Clamping screw	Tightening torque Nm	Size
25901			
Code 4.000	M4x15x15IP	3-3.5	04-08
Code 4.003	M4x17x15IP	3-3.5	12

Article no.	Torx-Plus wrench
25904	
Code 15.000	T15IP T-handle



Square shank holders 90° offset, external machining, with IC

for indexable inserts type 305 • grooving depth up to 3.5 mm
with internal coolant supply from above and below

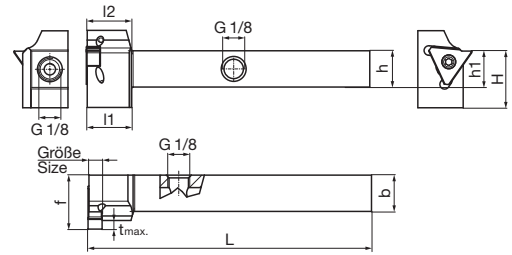

GH305

Right-hand design as shown. Left-hand design is mirror image.

Article no. **25358**



h mm	b mm	L mm	h1 mm	H mm	l1 mm	l2 mm	f mm	Size	Code no.	Description
12.00	12.00	125.00	12.00	21.00	21.60	21.60	23.80	04	12.014	GH305.1212.125.90.04.R.IK
12.70	12.70	127.00	12.70	21.70	19.92	19.92	22.70	04	12.033	GH305.0500.500.90.04.R.IK
15.87	15.87	127.00	15.87	24.87	19.92	19.92	24.12	04	12.021	GH305.0625.500.90.04.R.IK
16.00	16.00	125.00	16.00	25.00	19.60	19.60	23.80	04	12.001	GH305.1616.125.90.04.R.IK
19.05	19.05	127.00	19.05	24.05	19.92	19.92	22.85	04	12.022	GH305.0750.500.90.04.R.IK
20.00	20.00	125.00	20.00	25.00	19.60	19.60	23.80	04	12.002	GH305.2020.125.90.04.R.IK
25.00	25.00	150.00	25.00	30.00	19.60	19.60	28.80	04	12.003	GH305.2525.150.90.04.R.IK
25.40	25.40	152.40	25.40	30.40	19.92	19.92	29.20	04	12.023	GH305.1000.600.90.04.R.IK
12.00	12.00	125.00	12.00	21.00	21.60	21.60	23.80	06	12.016	GH305.1212.125.90.06.R.IK
12.70	12.70	127.00	12.70	21.70	19.92	19.92	22.70	06	12.034	GH305.0500.500.90.06.R.IK
15.87	15.87	127.00	15.87	24.87	19.92	19.92	24.12	06	12.024	GH305.0625.500.90.06.R.IK
16.00	16.00	125.00	16.00	25.00	19.60	19.60	23.80	06	12.004	GH305.1616.125.90.06.R.IK
19.05	19.05	127.00	19.05	24.05	19.92	19.92	22.85	06	12.025	GH305.0750.500.90.06.R.IK
20.00	20.00	125.00	20.00	25.00	19.60	19.60	23.80	06	12.005	GH305.2020.125.90.06.R.IK
25.00	25.00	150.00	25.00	30.00	19.60	19.60	28.80	06	12.006	GH305.2525.150.90.06.R.IK
25.40	25.40	152.40	25.40	30.40	19.92	19.92	29.20	06	12.026	GH305.1000.600.90.06.R.IK
12.00	12.00	125.00	12.00	21.00	23.60	23.60	23.80	08	12.018	GH305.1212.125.90.08.R.IK
12.70	12.70	127.00	12.70	21.70	21.92	21.92	22.70	08	12.035	GH305.0500.500.90.08.R.IK
15.87	15.87	127.00	15.87	24.87	21.92	21.92	24.12	08	12.027	GH305.0625.500.90.08.R.IK
16.00	16.00	125.00	16.00	25.00	19.60	19.60	23.80	08	12.007	GH305.1616.125.90.08.R.IK
19.05	19.05	127.00	19.05	24.05	19.92	19.92	22.85	08	12.028	GH305.0750.500.90.08.R.IK
20.00	20.00	125.00	20.00	25.00	19.60	19.60	23.80	08	12.008	GH305.2020.125.90.08.R.IK
25.00	25.00	150.00	25.00	30.00	19.60	19.60	28.80	08	12.009	GH305.2525.150.90.08.R.IK
25.40	25.40	152.40	25.40	30.40	19.92	19.92	29.20	08	12.029	GH305.1000.600.90.08.R.IK
12.00	12.00	125.00	12.00	21.00	27.60	27.60	23.80	12	12.020	GH305.1212.125.90.12.R.IK
12.70	12.70	127.00	12.70	21.70	25.92	25.92	22.70	12	12.036	GH305.0500.500.90.12.R.IK
15.87	15.87	127.00	15.87	24.87	25.92	25.92	24.12	12	12.030	GH305.0625.500.90.12.R.IK
16.00	16.00	125.00	16.00	25.00	27.60	27.60	23.80	12	12.010	GH305.1616.125.90.12.R.IK
19.05	19.05	127.00	19.05	24.05	25.92	25.92	24.12	12	12.031	GH305.0750.500.90.12.R.IK
20.00	20.00	125.00	20.00	25.00	27.60	27.60	23.80	12	12.011	GH305.2020.125.90.12.R.IK
25.00	25.00	150.00	25.00	30.00	27.60	27.60	28.80	12	12.012	GH305.2525.150.90.12.R.IK
25.40	25.40	152.40	25.40	30.40	25.92	25.92	29.20	12	12.032	GH305.1000.600.90.12.R.IK

On the left-hand design, the designation changes to .L

Article no. **25359**



Spare parts

Article no.	Clamping screw	Tightening torque Nm	Size
25901			
Code 4.000	M4x15x15IP	3-3.5	04-08
Code 4.003	M4x17x15IP	3-3.5	12

Article no.	Torx-Plus wrench
25904	
Code 15.000	T15IP T-handle



Square shank holders 45° offset, external machining, without IC

for indexable inserts type 305 • grooving depth up to 2 mm
without internal coolant supply

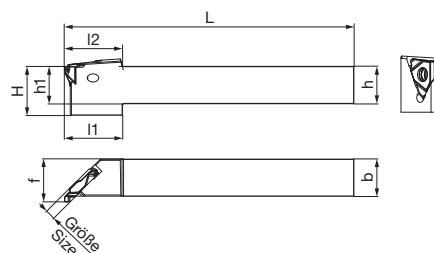

GH305

Right-hand design as shown. Left-hand design is mirror image.

Article no. **25362**



h mm	b mm	L mm	h1 mm	H mm	l1 mm	l2 mm	f mm	Size	Code no.	Description
10.00	10.00	125.00	10.00	21.00	25.66	25.66	12.56	04	12.004	GH305.1010.125.45.04.R
12.00	12.00	125.00	12.00	21.00	25.66	25.66	14.56	04	12.005	GH305.1212.125.45.04.R
12.70	12.70	127.00	12.70	21.70	25.66	25.66	15.10	04	12.020	GH305.0500.500.45.04.R
15.87	15.87	127.00	15.87	20.87	26.06	26.06	18.44	04	12.021	GH305.0625.500.45.04.R
16.00	16.00	125.00	16.00	21.00	25.66	25.66	18.56	04	12.001	GH305.1616.125.45.04.R
19.05	19.05	127.00	19.05	24.05	26.06	26.06	21.61	04	12.022	GH305.0750.500.45.04.R
20.00	20.00	125.00	20.00	25.00	25.66	25.66	22.56	04	12.002	GH305.2020.125.45.04.R
25.00	25.00	150.00	25.00	30.00	30.66	30.66	27.56	04	12.003	GH305.2525.150.45.04.R
25.40	25.40	152.40	25.40	30.40	31.14	31.14	27.96	04	12.023	GH305.1000.600.45.04.R

On the left-hand design, the designation changes to .L

Article no. **25363**



Spare parts

Article no.	Clamping screw	Tightening torque Nm
25902		
Code 4.001	M4x0.5x7x15IP	3-3.5
Article no.	Torx-Plus wrench	
25904		
Code 15.000	T15IP T-handle	



Square shank holders 45° offset, external machining, with IC

for indexable inserts type 305 • grooving depth up to 2 mm
with internal coolant supply from above

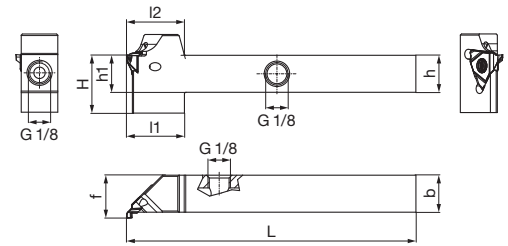

GH305

Right-hand design as shown. Left-hand design is mirror image.

Article no. **25364**



h mm	b mm	L mm	h1 mm	H mm	l1 mm	l2 mm	f mm	Size	Code no.	Description
12.00	12.00	125.00	12.00	25.00	25.66	25.66	14.56	04	12.005	GH305.1212.125.45.04.R.IK
12.70	12.70	127.00	12.70	25.70	25.66	25.66	15.10	04	12.020	GH305.0500.500.45.04.R.IK
15.87	15.87	127.00	15.87	24.87	26.06	26.06	18.44	04	12.021	GH305.0625.500.45.04.R.IK
16.00	16.00	125.00	16.00	25.00	25.66	25.66	18.56	04	12.001	GH305.1616.125.45.04.R.IK
19.05	19.05	127.00	19.05	24.05	26.06	26.06	21.61	04	12.022	GH305.0750.500.45.04.R.IK
20.00	20.00	125.00	20.00	25.00	25.66	25.66	22.56	04	12.002	GH305.2020.125.45.04.R.IK
25.00	25.00	150.00	25.00	30.00	30.66	30.66	27.56	04	12.003	GH305.2525.150.45.04.R.IK
25.40	25.40	152.40	25.40	30.40	31.14	31.14	27.96	04	12.023	GH305.1000.600.45.04.R.IK

On the left-hand design, the designation changes to .L

Article no. **25365**



Spare parts

Article no.	Clamping screw	Tightening torque Nm
25902		
Code 4.001	M4x0.5x7x15IP	3-3.5
Article no.	Torx-Plus wrench	
25904		
Code 15.000	T15IP T-handle	



Round shank holders, internal machining, without IC

for indexable inserts type 305 • grooving depth up to 4 mm
without internal coolant supply

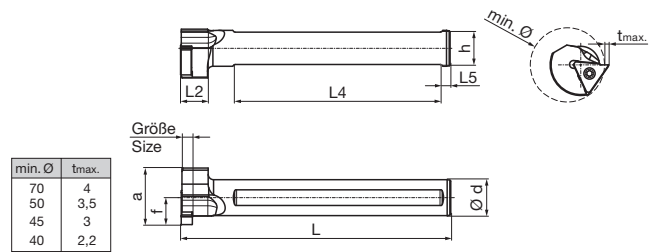

GB305

Right-hand design as shown. Left-hand design is mirror image.

Article no. **25368**



d	L	L2	L4	L5	h	f	a	Size	Code no.	Description
mm	mm	mm	mm	mm	mm	mm	mm			
19.05	152.40	14.60	116.84	4.00	17.04	14.48	30.48	04	12.021	GB305.0750.600.90.04.R
20.00	150.00	14.60	115.00	4.00	18.00	15.00	31.50	04	12.001	GB305.0020.150.90.04.R
25.00	170.00	14.60	130.00	4.00	23.00	17.50	34.50	04	12.002	GB305.0025.170.90.04.R
25.40	170.18	14.60	129.54	4.00	23.39	17.78	34.54	04	12.022	GB305.1000.670.90.04.R
31.75	205.20	14.60	162.56	4.00	29.74	21.08	39.37	04	12.023	GB305.1250.800.90.04.R
32.00	200.00	14.60	160.00	4.00	30.00	21.00	39.25	04	12.003	GB305.0032.200.90.04.R
19.05	152.40	14.60	116.84	4.00	17.04	14.48	30.48	06	12.024	GB305.0750.600.90.06.R
20.00	150.00	14.60	115.00	4.00	18.00	15.00	31.50	06	12.004	GB305.0020.150.90.06.R
25.00	170.00	14.60	130.00	4.00	23.00	17.50	34.50	06	12.005	GB305.0025.170.90.06.R
25.40	170.18	14.60	129.54	4.00	23.39	17.78	34.54	06	12.025	GB305.1000.670.90.06.R
31.75	203.20	14.60	162.56	4.00	29.74	21.08	39.37	06	12.026	GB305.1250.800.90.06.R
32.00	200.00	14.60	160.00	4.00	30.00	21.00	39.25	06	12.006	GB305.0032.200.90.06.R
19.05	152.40	14.60	116.84	4.00	17.04	14.48	30.48	08	12.027	GB305.0750.600.90.08.R
20.00	150.00	14.60	115.00	4.00	18.00	15.00	31.50	08	12.007	GB305.0020.150.90.08.R
25.00	170.00	14.60	130.00	4.00	23.00	17.50	34.50	08	12.008	GB305.0025.170.90.08.R
25.40	170.18	14.60	129.54	4.00	23.39	17.78	34.54	08	12.028	GB305.1000.670.90.08.R
31.75	203.20	14.60	162.56	4.00	29.74	21.08	39.37	08	12.029	GB305.1250.800.90.08.R
32.00	200.00	14.60	160.00	4.00	30.00	21.00	39.25	08	12.009	GB305.0032.200.90.08.R
19.05	152.40	19.60	116.84	4.00	17.04	14.48	30.48	12	12.030	GB305.0750.600.90.12.R
20.00	150.00	19.60	115.00	4.00	18.00	15.00	31.50	12	12.010	GB305.0020.150.90.12.R
25.00	170.00	19.60	130.00	4.00	23.00	17.50	34.50	12	12.011	GB305.0025.170.90.12.R
25.40	170.18	19.60	129.54	4.00	23.39	17.78	34.54	12	12.031	GB305.1000.670.90.12.R
31.75	203.20	19.60	162.56	4.00	29.74	21.08	39.37	12	12.032	GB305.1250.800.90.12.R
32.00	200.00	19.60	160.00	4.00	30.00	21.00	39.25	12	12.012	GB305.0032.200.90.12.R

On the left-hand design, the designation changes to .L

Article no. **25369**



Spare parts

Article no.	Clamping screw	Tightening torque	Size
25901		Nm	
Code 4.000	M4x15x15IP	3-3.5	04-08
Code 4.003	M4x17x15IP	3-3.5	12
Article no.	Torx-Plus wrench		
25904			
Code 15.000	T15IP T-handle		

Tool holders



Round shank holders, internal machining, with IC

for indexable inserts type 305 • grooving depth up to 4 mm
with internal coolant supply from above

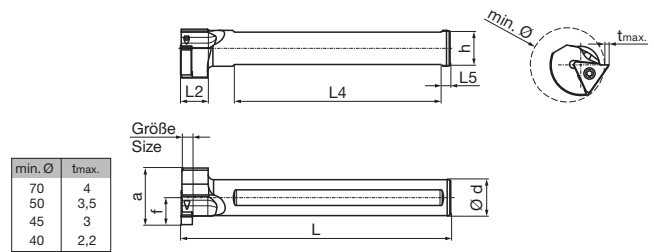

GB305

Right-hand design as shown. Left-hand design is mirror image.

Article no. **25370**



d	L	L2	L4	L5	h	f	a	Size	Code no.	Description
mm	mm	mm	mm	mm	mm	mm	mm			
19.05	152.40	14.60	116.84	4.00	17.04	14.48	30.48	04	12.021	GB305.0750.600.90.04.R.IK
20.00	150.00	14.60	115.00	4.00	18.00	15.00	31.50	04	12.001	GB305.0020.150.90.04.R.IK
25.00	170.00	14.60	130.00	4.00	23.00	17.50	34.50	04	12.002	GB305.0025.170.90.04.R.IK
25.40	170.18	14.60	129.54	4.00	23.39	17.78	34.54	04	12.022	GB305.1000.670.90.04.R.IK
31.75	205.20	14.60	162.56	4.00	29.74	21.08	39.37	04	12.023	GB305.1250.800.90.04.R.IK
32.00	200.00	14.60	160.00	4.00	30.00	21.00	39.25	04	12.003	GB305.0032.200.90.04.R.IK
19.05	152.40	14.60	116.84	4.00	17.04	14.48	30.48	06	12.024	GB305.0750.600.90.06.R.IK
20.00	150.00	14.60	115.00	4.00	18.00	15.00	31.50	06	12.004	GB305.0020.150.90.06.R.IK
25.00	170.00	14.60	130.00	4.00	23.00	17.50	34.50	06	12.005	GB305.0025.170.90.06.R.IK
25.40	170.18	14.60	129.54	4.00	23.39	17.78	34.54	06	12.025	GB305.1000.670.90.06.R.IK
31.75	203.20	14.60	162.56	4.00	29.74	21.08	39.37	06	12.026	GB305.1250.800.90.06.R.IK
32.00	200.00	14.60	160.00	4.00	30.00	21.00	39.25	06	12.006	GB305.0032.200.90.06.R.IK
19.05	152.40	14.60	116.84	4.00	17.04	14.48	30.48	08	12.027	GB305.0750.600.90.12.R.IK
20.00	150.00	14.60	115.00	4.00	18.00	15.00	31.50	08	12.007	GB305.0020.150.90.08.R.IK
25.00	170.00	14.60	130.00	4.00	23.00	17.50	34.50	08	12.008	GB305.0025.170.90.08.R.IK
25.40	170.18	14.60	129.54	4.00	23.39	17.78	34.54	08	12.028	GB305.1000.670.90.08.R.IK
31.75	203.20	14.60	162.56	4.00	29.74	21.08	39.37	08	12.029	GB305.1250.800.90.08.R.IK
32.00	200.00	14.60	160.00	4.00	30.00	21.00	39.25	08	12.009	GB305.0032.200.90.08.R.IK
19.05	152.40	19.60	116.84	4.00	17.04	14.48	30.48	12	12.030	GB305.0750.600.90.06.R.IK
20.00	150.00	19.60	115.00	4.00	18.00	15.00	31.50	12	12.010	GB305.0020.150.90.12.R.IK
25.00	170.00	19.60	130.00	4.00	23.00	17.50	34.50	12	12.011	GB305.0025.170.90.12.R.IK
25.40	170.18	19.60	129.54	4.00	23.39	17.78	34.54	12	12.031	GB305.1000.670.90.12.R.IK
31.75	203.20	19.60	162.56	4.00	29.74	21.08	39.37	12	12.032	GB305.1250.800.90.12.R.IK
32.00	200.00	19.60	160.00	4.00	30.00	21.00	39.25	12	12.012	GB305.0032.200.90.12.R.IK

On the left-hand design, the designation changes to .L

Article no. **25371**



Spare parts

Article no.	Clamping screw	Tightening torque	Size
25901		Nm	
Code 4.000	M4x15x15IP	3-3.5	04-08
Code 4.003	M4x17x15IP	3-3.5	12
Article no.	Torx-Plus wrench		
25904			
Code 15.000	T15IP T-handle		



Parting off blade, without IC

for indexable inserts type 222
without internal coolant supply

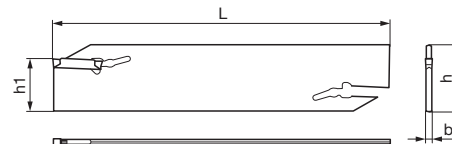

GS222

Article no. **26200**



tmax. mm	b mm	h mm	h1 mm	L mm	Size	Code no.	Description
35.00	1.55	26.00	21.40	120.00	02	22.102	GS222.0026.120.02.02.N
45.00	1.55	32.00	25.00	150.00	02	22.103	GS222.0032.150.02.02.N
35.00	2.25	26.00	21.40	120.00	03	22.002	GS222.0026.120.03.02.N
45.00	2.25	32.00	25.00	150.00	03	22.003	GS222.0032.150.03.02.N

Spare parts

Article no.	Mounting key
25921	
Code 15.000	



Parting off blade, with IC

for indexable inserts type 222

with internal coolant supply from above and below

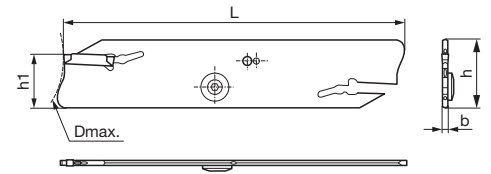

GS222

Article no. **26201**



tmax. mm	b mm	h mm	h1 mm	L mm	Dmax. mm	Size	Code no.	Description
35.00	1.55	26.00	21.40	118.00	70.00	02	22.102	GS222.0026.118.02.02.N.IK
45.00	1.55	32.00	25.00	147.50	90.00	02	22.103	GS222.0032.147.02.02.N.IK
35.00	2.25	26.00	21.40	118.00	70.00	03	22.002	GS222.0026.118.03.02.N.IK
45.00	2.25	32.00	25.00	147.50	90.00	03	22.003	GS222.0032.147.03.02.N.IK

Spare parts

Article no. 25921 Code 15.000	Mounting key
Article no. 25909 Code 4.000	IC locking screw



Reinforced parting off blade, without IC

for indexable inserts type 222/122

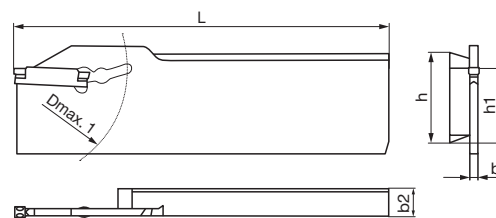

GS222

Right-hand design as shown. Left-hand design is mirror image.

Article no. **26202**



b mm	b2 mm	h mm	h1 mm	L mm	Dmax. 1 mm	Size	Code no.	Description
2.25	8.00	26.00	21.40	110.00	66.00	03	22.002	GS222.0826.110.03.01.R.00.R
2.25	8.00	32.00	25.00	120.00	66.00	03	22.003	GS222.0832.120.03.01.R.00.R

On the left-hand design, the designation changes to .L.00.L

Article no. **26203**



Spare parts

Article no. 25921	Mounting key
Code 15.000	

Article no. 25909	IC locking screw
Code 4.000	



Reinforced parting off blade, with IC

for indexable inserts type 222/122

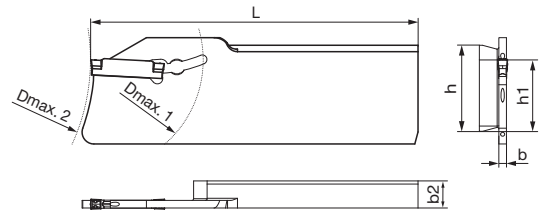

GS222

Right-hand design as shown. Left-hand design is mirror image.

Article no. **26206**



b mm	b2 mm	h mm	h1 mm	L mm	Dmax. 1 mm	Dmax. 2 mm	Size	Code no.	Description
2.25	8.00	26.00	21.40	99.54	66.00	120.00	03	22.002	GS222.0826.097.03.01.R.IK.R
2.25	8.00	32.00	25.00	123.02	66.00	120.00	03	22.003	GS222.0832.120.03.01.R.IK.R

On the left-hand design, the designation changes to .L.IK.L

Article no. **26207**



Spare parts

Article no. 25921 Code 15.000	Mounting key
Article no. 25909 Code 4.000	IC locking screw



Torque wrenches



Article no. **4915**

Size	Torque Nm	l1 mm	Code no.
1/4	2-8	200.000	8.000

Torx-Plus interchangeable blade

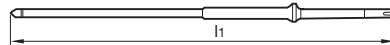

Article no. **4960**

Size	Torque Nm	l1 mm	Code no.
T15IP	6,6	175.000	15.000

Torx Plus wrench



key with T-handle code no. 15.000 • allen key code no. 15.001

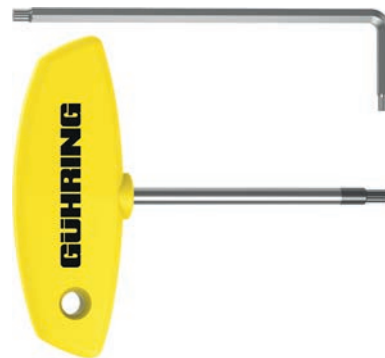

Article no. **25904**

Size	l1 mm	Code no.
9x12	65.000	15.000
9x12	97.000	15.001

Torx Plus wrench



for tool holders GH222



Article no. **25922**

Size	l1 mm	Code no.
25IP	58.000	15.000



Mounting keys



for parting off blade
GS222



Article no.

25921

l1
mm
120.000

Code no.
15.000

Clamping screws



for system
104/106/108/110

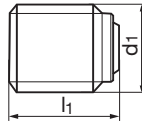

Article no.

25900

Size

d1

l1
mm
7.500

Code no.

15IP

M6

6.000

Clamping screws



for system 305

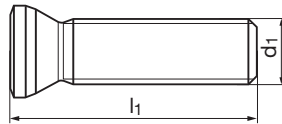

Article no.

25901

Size

d1

l1
mm
15.000
22.000
11.000
17.000
22.000

Code no.

15IP
15IP
15IP
15IP
25IP

M4
M4
M4
M4
M5

4.000
4.001
4.002
4.003
5.000

Clamping screws



for system 305

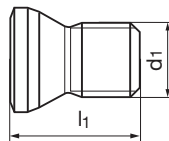

Article no.

25902

Size

d1

l1
mm
15.000
7.000

Code no.

15IP
15IP

M4 x 0,5
M4 x 0,5

4.000
4.001



Clamping screws



for shank holder system
222 GH222.1212 to
GH222.1616

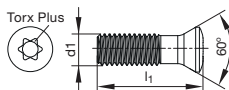

Article no.

25906

Size	d1	l1 mm	Code no.
15IP	M4	15.500	4.000

Clamping screws



for shank holder system
222 GH222.0750 to
GH222.1000

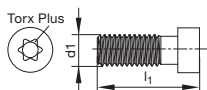

Article no.

25907

Size	d1	l1 mm	Code no.
25IP	M5	18.000	5.000

Clamping screws



for system
104/106/108/110

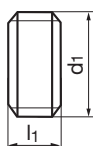

Article no.

25908

Size	d1	l1 mm	Code no.
15IP	M6	4.500	6.000
15IP	M6	3.500	6.001

Fastening screws



for Star holder

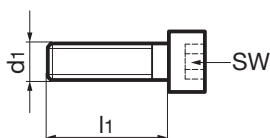

Article no.

25912

Size	d1	l1 mm	Code no.
SW3	M4	30.000	4.000
SW4	M5	30.000	5.000

Set screws



for IC lock, systems 305
and 222

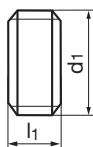

Article no.

25905

Size	d1	l1 mm	Code no.
SW 4	G1/8	5.000	5.000



Set screws



for IC lock, systems 305 and 222

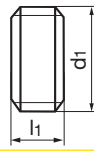

Article no. **25913**

Size	d1	l1 mm	Code no.
SW4	M8x1	5.000	8.000

IC screw plugs



for parting off blade GS222

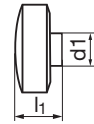

Article no. **25909**

Size	d1	l1 mm	Code no.
SW3	M4	4.700	4.000

IC screw plugs for tubeless coolant supply (TL)



for tool holders GH222 and GH305

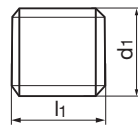

Article no. **25910**

Size	d1	l1 mm	Code no.
SW3	M6	6.000	6.000

Lubricating paste for clamping screws



Article no. **25923**

Code no.

1.000



Internal grooving



Machining group	Length	System 104		
		v _c (m/min)	f (mm/rev) by D _{min} .	
			≤ 1.5	> 1.5
P1.1.1 Unalloyed steel, annealed, 0.15 % C, Rm 420 N/mm ² , 125 HB P1.1.2 Unalloyed steel, heat-treated, 0.15 % C, Rm 420 N/mm ² , 125 HB P1.1.3 Unalloyed steel, annealed, 0.45 % C, Rm 640 N/mm ² , 190 HB P1.1.4 Unalloyed steel, heat-treated, 0.45 % C, Rm 640 N/mm ² , 190 HB P1.1.5 Unalloyed steel, heat-treated, 0.45 % C, Rm 850 N/mm ² , 250 HB P1.1.6 Unalloyed steel, annealed, 0.75 % C, Rm 915 N/mm ² , 270 HB P1.1.7 Unalloyed steel, heat-treated, 0.75 % C, Rm 1020 N/mm ² , 300 HB	K	40	0.010	0.030
	M	30	0.010	0.025
	L	20	0.010	0.015
P2.1.1 Low-alloy steel, annealed, Rm 610 N/mm ² , 180 HB P2.1.2 Low-alloy steel, heat-treated, Rm 930 N/mm ² , 275 HB P2.1.3 Low-alloy steel, heat-treated, Rm 1020 N/mm ² , 300 HB P2.1.4 Low-alloy steel, heat-treated, Rm 1190 N/mm ² , 350 HB	K	40	0.010	0.030
	M	30	0.010	0.025
	L	20	0.010	0.015
P3.1.1 High-alloy steel and tool steel, annealed, Rm 680 N/mm ² , 200 HB P3.1.2 High-alloy steel and tool steel, hardened and tempered, Rm 1100 N/mm ² , 325 HB	K	40	0.010	0.030
	M	30	0.010	0.025
	L	20	0.010	0.015
M1.1.1 Stainless steel, ferritic/martensitic, with machining additives M1.1.2 Stainless steel, ferritic/martensitic, annealed, Rm 680 N/mm ² , 200 HB M1.1.3 Stainless steel, ferritic/martensitic, heat-treated, Rm 810 N/mm ² , 240 HB	K	35	0.005	0.025
	M	30	0.005	0.020
	L	20	0.010	0.010
M2.1.1 Stainless steel, austenitic, quenched, 180 HB M2.2.1 Duplex steel, high-strength stainless steels	K	35	0.005	0.025
	M	30	0.005	0.020
	L	20	0.010	0.010
K1.1.1 Grey cast iron, pearlitic/ferritic, 180 HB K1.1.2 Grey cast iron, pearlitic/martensitic, 260 HB K1.2.1 Cast iron with spheroidal graphite, ferritic, 160 HB K1.2.2 Cast iron with spheroidal graphite, pearlitic, 250 HB K1.3.1 Malleable cast iron, ferritic, 130 HB K1.3.2 Malleable cast iron, pearlitic, 230 HB	K	40	0.010	0.040
	M	30	0.010	0.030
	L	20	0.015	0.020
K2.1.1 Vermicular graphite cast iron (GJV) K2.2.1 Austenitic-ferritic spheroidal graphite cast iron (ADI)				
N1.1.1 Wrought aluminium alloys, non-hardened, 60 HB N1.1.2 Wrought aluminium alloys, hardened, 100 HB	K	80	0.015	0.045
	M	65	0.015	0.035
	L	40	0.015	0.025
N2.1.1 Aluminium casting alloys, non-hardened, ≤ 12 % Si, 75 HB N2.1.2 Aluminium casting alloys, hardened, ≤ 12 % Si, 90 HB N2.1.3 Aluminium casting alloys, non-hardened, > 12 % Si, 130 HB	K	80	0.015	0.045
	M	65	0.015	0.035
	L	40	0.015	0.025
N3.1.1 Copper and copper alloys: Free-machining alloy, Pb > 1 % N3.1.2 Copper and copper alloys: CuZn, CuSnZn N3.1.3 Copper and copper alloys: CuSn, lead-free copper and copper electrolyte	K	80	0.015	0.045
	M	65	0.015	0.035
	L	40	0.015	0.025
N4.1.1 Non-metallic materials: Duroplastics, fibre-reinforced plastics N4.1.2 Non-metallic materials: Hard rubber, wood, etc. N4.1.3 Non-metallic materials: Graphite	K	80	0.015	0.045
	M	65	0.015	0.035
	L	40	0.015	0.025
S1.1.1 Heat-resistant alloys, Fe-based, annealed, 200 HB S1.1.2 Heat-resistant alloys, Fe-based, hardened, 280 HB S1.1.3 Heat-resistant alloys, Ni- or Co-based, annealed, 250 HB S1.1.4 Heat-resistant alloys, Ni- or Co-based, hardened, 350 HB S1.1.5 Heat-resistant alloys, Ni- or Co-based, cast, 320 HB	K	25	0.005	0.010
	M	20	0.005	0.010
	L	15	0.005	0.005
S2.1.1 Titanium alloys, pure titanium, Rm 400 N/mm ² S2.1.2 Titanium alloys, Alpha and Beta alloys, hardened, Rm 1050 N/mm ²	K	25	0.005	0.010
	M	20	0.005	0.010
	L	15	0.005	0.005
H1.1.1 Hardened steel, hardened and tempered, < 55 HRC H1.1.2 Hardened steel, hardened and tempered, < 60 HRC H1.1.3 Hardened steel, hardened and tempered, > 60 HRC	K	25	0.005	0.010
	M	20	0.005	0.010
	L	15	0.005	0.005
H2.1.1 Chilled cast iron, 400 HB H2.1.2 Chilled cast iron, hardened and tempered, < 55 HRC	K	25	0.005	0.010
	M	20	0.005	0.010
	L	15	0.005	0.005

K = short tools with La/D_{min} < 3.5 | M = medium length tools with La/D_{min}. from 3.5 - 6.5 | L = long tools with La/D_{min}. > 6.5



System 106		System 108		System 305					
v _c (m/min)	f (mm/rev)	v _c (m/min)	f (mm/rev)	v _c (m/min)	f (mm/rev) by width				
					< 1	< 2	< 3	< 4	≥ 4
80	0.030	100	0.030	150	0.01	0.02	0.03	0.04	0.05
65	0.025	80	0.025						
40	0.015	50	0.015						
80	0.030	100	0.030						
65	0.025	80	0.025						
40	0.015	50	0.015						
80	0.030	100	0.030	150	0.01	0.02	0.03	0.04	0.05
65	0.025	80	0.025						
40	0.015	50	0.015						
80	0.030	100	0.030						
65	0.025	80	0.025						
40	0.015	50	0.015						
70	0.025	90	0.025	150	0.01	0.02	0.03	0.04	0.05
60	0.020	75	0.020						
35	0.010	45	0.010						
70	0.025	90	0.025						
60	0.020	75	0.020						
35	0.010	45	0.010						
80	0.040	100	0.040	150	0.01	0.02	0.03	0.04	0.05
65	0.030	80	0.030						
40	0.020	50	0.020						
160	0.045	200	0.045	300	0.01	0.02	0.03	0.04	0.05
130	0.035	160	0.035						
80	0.025	100	0.025						
160	0.045	200	0.045						
130	0.035	160	0.035						
80	0.025	100	0.025						
160	0.045	200	0.045						
130	0.035	160	0.035						
80	0.025	100	0.025						
160	0.045	200	0.045						
130	0.035	160	0.035						
80	0.025	100	0.025						
50	0.010	65	0.010	100	0.01	0.02	0.03	0.04	0.05
40	0.010	55	0.010						
25	0.005	35	0.005						
50	0.010	65	0.010						
40	0.010	55	0.010						
25	0.005	35	0.005						
50	0.010	65	0.010	100	0.01	0.02	0.03	0.04	0.05
40	0.010	55	0.010						
25	0.005	35	0.005						
50	0.010	65	0.010						
40	0.010	55	0.010						
25	0.005	35	0.005						

Cutting data



External grooving System 305



Machining group	V _c (m/min)	System 305			
		f (mm/rev) by width			
		< 1	< 2	< 3	≥ 3
P1.1.1 Unalloyed steel, annealed, 0.15 % C, Rm 420 N/mm ² , 125 HB	150	0.050	0.070	0.100	0.120
P1.1.2 Unalloyed steel, heat-treated, 0.15 % C, Rm 420 N/mm ² , 125 HB	150	0.050	0.070	0.100	0.120
P1.1.3 Unalloyed steel, annealed, 0.45 % C, Rm 640 N/mm ² , 190 HB	150	0.050	0.070	0.100	0.120
P1.1.4 Unalloyed steel, heat-treated, 0.45 % C, Rm 640 N/mm ² , 190 HB	150	0.050	0.070	0.100	0.120
P1.1.5 Unalloyed steel, heat-treated, 0.45 % C, Rm 850 N/mm ² , 250 HB	150	0.050	0.070	0.100	0.120
P1.1.6 Unalloyed steel, annealed, 0.75 % C, Rm 915 N/mm ² , 270 HB	150	0.050	0.070	0.100	0.120
P1.1.7 Unalloyed steel, heat-treated, 0.75 % C, Rm 1020 N/mm ² , 300 HB	150	0.050	0.070	0.100	0.120
P2.1.1 Low-alloy steel, annealed, Rm 610 N/mm ² , 180 HB	150	0.050	0.070	0.100	0.120
P2.1.2 Low-alloy steel, heat-treated, Rm 930 N/mm ² , 275 HB	150	0.050	0.070	0.100	0.120
P2.1.3 Low-alloy steel, heat-treated, Rm 1020 N/mm ² , 300 HB	150	0.050	0.070	0.100	0.120
P2.1.4 Low-alloy steel, heat-treated, Rm 1190 N/mm ² , 350 HB	150	0.050	0.070	0.100	0.120
P3.1.1 High-alloy steel and tool steel, annealed, Rm 680 N/mm ² , 200 HB	150	0.050	0.070	0.100	0.120
P3.1.2 High-alloy steel and tool steel, hardened and tempered, Rm 1100 N/mm ² , 325 HB	150	0.050	0.070	0.100	0.120
M1.1.1 Stainless steel, ferritic/martensitic, with machining additives	135	0.040	0.050	0.075	0.090
M1.1.2 Stainless steel, ferritic/martensitic, annealed, Rm 680 N/mm ² , 200 HB	135	0.040	0.050	0.075	0.090
M1.1.3 Stainless steel, ferritic/martensitic, heat-treated, Rm 810 N/mm ² , 240 HB	135	0.040	0.050	0.075	0.090
M2.1.1 Stainless steel, austenitic, quenched, 180 HB	135	0.040	0.050	0.075	0.090
M2.2.1 Duplex steel, high-strength stainless steels	135	0.040	0.050	0.075	0.090
K1.1.1 Grey cast iron, pearlitic/ferritic, 180 HB	150	0.065	0.085	0.125	0.150
K1.1.2 Grey cast iron, pearlitic/martensitic, 260 HB	150	0.065	0.085	0.125	0.150
K1.2.1 Cast iron with spheroidal graphite, ferritic, 160 HB	150	0.065	0.085	0.125	0.150
K1.2.2 Cast iron with spheroidal graphite, pearlitic, 250 HB	150	0.065	0.085	0.125	0.150
K1.3.1 Malleable cast iron, ferritic, 130 HB	150	0.065	0.085	0.125	0.150
K1.3.2 Malleable cast iron, pearlitic, 230 HB	150	0.065	0.085	0.125	0.150
K2.1.1 Vermicular graphite cast iron (GJV)					
K2.2.1 Austenitic-ferritic spheroidal graphite cast iron (ADI)					
N1.1.1 Wrought aluminium alloys, non-hardened, 60 HB					
N1.1.2 Wrought aluminium alloys, hardened, 100 HB					
N2.1.1 Aluminium casting alloys, non-hardened, ≤ 12 % Si, 75 HB					
N2.1.2 Aluminium casting alloys, hardened, ≤ 12 % Si, 90 HB					
N2.1.3 Aluminium casting alloys, non-hardened, > 12 % Si, 130 HB					
N3.1.1 Copper and copper alloys: Free-machining alloy, Pb > 1 %					
N3.1.2 Copper and copper alloys: CuZn, CuSnZn					
N3.1.3 Copper and copper alloys: CuSn, lead-free copper and copper electrolyte					
N4.1.1 Non-metallic materials: Duroplastics, fibre-reinforced plastics					
N4.1.2 Non-metallic materials: Hard rubber, wood, etc.					
N4.1.3 Non-metallic materials: Graphite					
S1.1.1 Heat-resistant alloys, Fe-based, annealed, 200 HB	100	0.020	0.030	0.040	0.050
S1.1.2 Heat-resistant alloys, Fe-based, hardened, 280 HB	100	0.020	0.030	0.040	0.050
S1.1.3 Heat-resistant alloys, Ni- or Co-based, annealed, 250 HB	100	0.020	0.030	0.040	0.050
S1.1.4 Heat-resistant alloys, Ni- or Co-based, hardened, 350 HB	100	0.020	0.030	0.040	0.050
S1.1.5 Heat-resistant alloys, Ni- or Co-based, cast, 320 HB	100	0.020	0.030	0.040	0.050
S2.1.1 Titanium alloys, pure titanium, Rm 400 N/mm ²	100	0.020	0.030	0.040	0.050
S2.1.2 Titanium alloys, Alpha and Beta alloys, hardened, Rm 1050 N/mm ²	100	0.020	0.030	0.040	0.050
H1.1.1 Hardened steel, hardened and tempered, < 55 HRC	100	0.020	0.030	0.040	0.050
H1.1.2 Hardened steel, hardened and tempered, < 60 HRC	100	0.020	0.030	0.040	0.050
H1.1.3 Hardened steel, hardened and tempered, > 60 HRC	100	0.020	0.030	0.040	0.050
H2.1.1 Chilled cast iron, 400 HB	100	0.020	0.030	0.040	0.050
H2.1.2 Chilled cast iron, hardened and tempered, < 55 HRC	100	0.020	0.030	0.040	0.050



Boring out System 305



Machining group	v _c (m/min)	f (mm/rev) with nom. Ø					apmax. (mm) by radius					
		< 1	< 2	< 3	< 4	≥ 4	≤ 0.05	≤ 0.1	≤ 0.15	≤ 0.2	≤ 0.25	> 0.25
P1.1.1 Unalloyed steel, annealed, 0.15 % C, Rm 420 N/mm ² , 125 HB	150	0.005	0.010	0.015	0.020	0.025	0.005	0.005	0.005	0.005	0.005	0.005
P1.1.2 Unalloyed steel, heat-treated, 0.15 % C, Rm 420 N/mm ² , 125 HB	150	0.005	0.010	0.015	0.020	0.025	0.005	0.005	0.005	0.005	0.005	0.005
P1.1.3 Unalloyed steel, annealed, 0.45 % C, Rm 640 N/mm ² , 190 HB	150	0.005	0.010	0.015	0.020	0.025	0.005	0.005	0.005	0.005	0.005	0.005
P1.1.4 Unalloyed steel, heat-treated, 0.45 % C, Rm 640 N/mm ² , 190 HB	150	0.005	0.010	0.015	0.020	0.025	0.005	0.005	0.005	0.005	0.005	0.005
P1.1.5 Unalloyed steel, heat-treated, 0.45 % C, Rm 850 N/mm ² , 250 HB	150	0.005	0.010	0.015	0.020	0.025	0.005	0.005	0.005	0.005	0.005	0.005
P1.1.6 Unalloyed steel, annealed, 0.75 % C, Rm 915 N/mm ² , 270 HB	150	0.005	0.010	0.015	0.020	0.025	0.005	0.005	0.005	0.005	0.005	0.005
P1.1.7 Unalloyed steel, heat-treated, 0.75 % C, Rm 1020 N/mm ² , 300 HB	150	0.005	0.010	0.015	0.020	0.025	0.005	0.005	0.005	0.005	0.005	0.005
P2.1.1 Low-alloy steel, annealed, Rm 610 N/mm ² , 180 HB	150	0.005	0.010	0.015	0.020	0.025	0.005	0.005	0.005	0.005	0.005	0.005
P2.1.2 Low-alloy steel, heat-treated, Rm 930 N/mm ² , 275 HB	150	0.005	0.010	0.015	0.020	0.025	0.005	0.005	0.005	0.005	0.005	0.005
P2.1.3 Low-alloy steel, heat-treated, Rm 1020 N/mm ² , 300 HB	150	0.005	0.010	0.015	0.020	0.025	0.005	0.005	0.005	0.005	0.005	0.005
P2.1.4 Low-alloy steel, heat-treated, Rm 1190 N/mm ² , 350 HB	150	0.005	0.010	0.015	0.020	0.025	0.005	0.005	0.005	0.005	0.005	0.005
P3.1.1 High-alloy steel and tool steel, annealed, Rm 680 N/mm ² , 200 HB	150	0.005	0.010	0.015	0.020	0.025	0.005	0.005	0.005	0.005	0.005	0.005
P3.1.2 High-alloy steel and tool steel, hardened and tempered, Rm 1100 N/mm ² , 325 HB	150	0.005	0.010	0.015	0.020	0.025	0.005	0.005	0.005	0.005	0.005	0.005
M1.1.1 Stainless steel, ferritic/martensitic, with machining additives	135	0.005	0.010	0.010	0.015	0.020	0.005	0.005	0.005	0.005	0.005	0.005
M1.1.2 Stainless steel, ferritic/martensitic, annealed, Rm 680 N/mm ² , 200 HB	135	0.005	0.010	0.010	0.015	0.020	0.005	0.005	0.005	0.005	0.005	0.005
M1.1.3 Stainless steel, ferritic/martensitic, heat-treated, Rm 810 N/mm ² , 240 HB	135	0.005	0.010	0.010	0.015	0.020	0.005	0.005	0.005	0.005	0.005	0.005
M2.1.1 Stainless steel, austenitic, quenched, 180 HB	135	0.005	0.010	0.010	0.015	0.020	0.005	0.005	0.005	0.005	0.005	0.005
M2.2.1 Duplex steel, high-strength stainless steels	135	0.005	0.010	0.010	0.015	0.020	0.005	0.005	0.005	0.005	0.005	0.005
K1.1.1 Grey cast iron, pearlitic/ferritic, 180 HB	150	0.005	0.015	0.020	0.025	0.030	0.005	0.005	0.005	0.005	0.005	0.005
K1.1.2 Grey cast iron, pearlitic/martensitic, 260 HB	150	0.005	0.015	0.020	0.025	0.030	0.005	0.005	0.005	0.005	0.005	0.005
K1.2.1 Cast iron with spheroidal graphite, ferritic, 160 HB	150	0.005	0.015	0.020	0.025	0.030	0.005	0.005	0.005	0.005	0.005	0.005
K1.2.2 Cast iron with spheroidal graphite, pearlitic, 250 HB	150	0.005	0.015	0.020	0.025	0.030	0.005	0.005	0.005	0.005	0.005	0.005
K1.3.1 Malleable cast iron, ferritic, 130 HB	150	0.005	0.015	0.020	0.025	0.030	0.005	0.005	0.005	0.005	0.005	0.005
K1.3.2 Malleable cast iron, pearlitic, 230 HB	150	0.005	0.015	0.020	0.025	0.030	0.005	0.005	0.005	0.005	0.005	0.005
K2.1.1 Vermicular graphite cast iron (GJV)												
K2.2.1 Austenitic-ferritic spheroidal graphite cast iron (ADI)												
N1.1.1 Wrought aluminium alloys, non-hardened, 60 HB	300	0.010	0.015	0.025	0.030	0.040	0.010	0.010	0.010	0.010	0.010	0.010
N1.1.2 Wrought aluminium alloys, hardened, 100 HB	300	0.010	0.015	0.025	0.030	0.040	0.010	0.010	0.010	0.010	0.010	0.010
N2.1.1 Aluminium casting alloys, non-hardened, ≤ 12 % Si, 75 HB	300	0.010	0.015	0.025	0.030	0.040	0.010	0.010	0.010	0.010	0.010	0.010
N2.1.2 Aluminium casting alloys, hardened, ≤ 12 % Si, 90 HB	300	0.010	0.015	0.025	0.030	0.040	0.010	0.010	0.010	0.010	0.010	0.010
N2.1.3 Aluminium casting alloys, non-hardened, > 12 % Si, 130 HB	300	0.010	0.015	0.025	0.030	0.040	0.010	0.010	0.010	0.010	0.010	0.010
N3.1.1 Copper and copper alloys: Free-machining alloy, Pb > 1 %	300	0.010	0.015	0.025	0.030	0.040	0.010	0.010	0.010	0.010	0.010	0.010
N3.1.2 Copper and copper alloys: CuZn, CuSnZn	300	0.010	0.015	0.025	0.030	0.040	0.010	0.010	0.010	0.010	0.010	0.010
N3.1.3 Copper and copper alloys: CuSn, lead-free copper and copper electrolyte	300	0.010	0.015	0.025	0.030	0.040	0.010	0.010	0.010	0.010	0.010	0.010
N4.1.1 Non-metallic materials: Duroplastics, fibre-reinforced plastics	300	0.010	0.015	0.025	0.030	0.040	0.010	0.010	0.010	0.010	0.010	0.010
N4.1.2 Non-metallic materials: Hard rubber, wood, etc.	300	0.010	0.015	0.025	0.030	0.040	0.010	0.010	0.010	0.010	0.010	0.010
N4.1.3 Non-metallic materials: Graphite	300	0.010	0.015	0.025	0.030	0.040	0.010	0.010	0.010	0.010	0.010	0.010
S1.1.1 Heat-resistant alloys, Fe-based, annealed, 200 HB	100	0.005	0.005	0.005	0.010	0.010	0.005	0.005	0.005	0.005	0.005	0.005
S1.1.2 Heat-resistant alloys, Fe-based, hardened, 280 HB	100	0.005	0.005	0.005	0.010	0.010	0.005	0.005	0.005	0.005	0.005	0.005
S1.1.3 Heat-resistant alloys, Ni- or Co-based, annealed, 250 HB	100	0.005	0.005	0.005	0.010	0.010	0.005	0.005	0.005	0.005	0.005	0.005
S1.1.4 Heat-resistant alloys, Ni- or Co-based, hardened, 350 HB	100	0.005	0.005	0.005	0.010	0.010	0.005	0.005	0.005	0.005	0.005	0.005
S1.1.5 Heat-resistant alloys, Ni- or Co-based, cast, 320 HB	100	0.005	0.005	0.005	0.010	0.010	0.005	0.005	0.005	0.005	0.005	0.005
S2.1.1 Titanium alloys, pure titanium, Rm 400 N/mm ²	100	0.005	0.005	0.005	0.010	0.010	0.005	0.005	0.005	0.005	0.005	0.005
S2.1.2 Titanium alloys, Alpha and Beta alloys, hardened, Rm 1050 N/mm ²	100	0.005	0.005	0.005	0.010	0.010	0.005	0.005	0.005	0.005	0.005	0.005
H1.1.1 Hardened steel, hardened and tempered, < 55 HRC	100	0.005	0.005	0.005	0.010	0.010	0.005	0.005	0.005	0.005	0.005	0.005
H1.1.2 Hardened steel, hardened and tempered, < 60 HRC	100	0.005	0.005	0.005	0.010	0.010	0.005	0.005	0.005	0.005	0.005	0.005
H1.1.3 Hardened steel, hardened and tempered, > 60 HRC	100	0.005	0.005	0.005	0.010	0.010	0.005	0.005	0.005	0.005	0.005	0.005
H2.1.1 Chilled cast iron, 400 HB	100	0.005	0.005	0.005	0.010	0.010	0.005	0.005	0.005	0.005	0.005	0.005
H2.1.2 Chilled cast iron, hardened and tempered, < 55 HRC	100	0.005	0.005	0.005	0.010	0.010	0.005	0.005	0.005	0.005	0.005	0.005

Cutting data

b/R > 2



External grooving System 305, full radius



Machining group	V _c (m/min)	System 305			
		f (mm/rev) by width			
		< 1	< 2	< 3	≥ 3
P1.1.1 Unalloyed steel, annealed, 0.15 % C, Rm 420 N/mm ² , 125 HB	150	0.050	0.070	0.100	0.120
P1.1.2 Unalloyed steel, heat-treated, 0.15 % C, Rm 420 N/mm ² , 125 HB	150	0.050	0.070	0.100	0.120
P1.1.3 Unalloyed steel, annealed, 0.45 % C, Rm 640 N/mm ² , 190 HB	150	0.050	0.070	0.100	0.120
P1.1.4 Unalloyed steel, heat-treated, 0.45 % C, Rm 640 N/mm ² , 190 HB	150	0.050	0.070	0.100	0.120
P1.1.5 Unalloyed steel, heat-treated, 0.45 % C, Rm 850 N/mm ² , 250 HB	150	0.050	0.070	0.100	0.120
P1.1.6 Unalloyed steel, annealed, 0.75 % C, Rm 915 N/mm ² , 270 HB	150	0.050	0.070	0.100	0.120
P1.1.7 Unalloyed steel, heat-treated, 0.75 % C, Rm 1020 N/mm ² , 300 HB	150	0.050	0.070	0.100	0.120
P2.1.1 Low-alloy steel, annealed, Rm 610 N/mm ² , 180 HB	150	0.050	0.070	0.100	0.120
P2.1.2 Low-alloy steel, heat-treated, Rm 930 N/mm ² , 275 HB	150	0.050	0.070	0.100	0.120
P2.1.3 Low-alloy steel, heat-treated, Rm 1020 N/mm ² , 300 HB	150	0.050	0.070	0.100	0.120
P2.1.4 Low-alloy steel, heat-treated, Rm 1190 N/mm ² , 350 HB	150	0.050	0.070	0.100	0.120
P3.1.1 High-alloy steel and tool steel, annealed, Rm 680 N/mm ² , 200 HB	150	0.050	0.070	0.100	0.120
P3.1.2 High-alloy steel and tool steel, hardened and tempered, Rm 1100 N/mm ² , 325 HB	150	0.050	0.070	0.100	0.120
M1.1.1 Stainless steel, ferritic/martensitic, with machining additives	135	0.040	0.050	0.075	0.090
M1.1.2 Stainless steel, ferritic/martensitic, annealed, Rm 680 N/mm ² , 200 HB	135	0.040	0.050	0.075	0.090
M1.1.3 Stainless steel, ferritic/martensitic, heat-treated, Rm 810 N/mm ² , 240 HB	135	0.040	0.050	0.075	0.090
M2.1.1 Stainless steel, austenitic, quenched, 180 HB	135	0.040	0.050	0.075	0.090
M2.2.1 Duplex steel, high-strength stainless steels	135	0.040	0.050	0.075	0.090
K1.1.1 Grey cast iron, pearlitic/ferritic, 180 HB	150	0.065	0.085	0.125	0.150
K1.1.2 Grey cast iron, pearlitic/martensitic, 260 HB	150	0.065	0.085	0.125	0.150
K1.2.1 Cast iron with spheroidal graphite, ferritic, 160 HB	150	0.065	0.085	0.125	0.150
K1.2.2 Cast iron with spheroidal graphite, pearlitic, 250 HB	150	0.065	0.085	0.125	0.150
K1.3.1 Malleable cast iron, ferritic, 130 HB	150	0.065	0.085	0.125	0.150
K1.3.2 Malleable cast iron, pearlitic, 230 HB	150	0.065	0.085	0.125	0.150
K2.1.1 Vermicular graphite cast iron (GJV)					
K2.2.1 Austenitic-ferritic spheroidal graphite cast iron (ADI)					
N1.1.1 Wrought aluminium alloys, non-hardened, 60 HB					
N1.1.2 Wrought aluminium alloys, hardened, 100 HB					
N2.1.1 Aluminium casting alloys, non-hardened, ≤ 12 % Si, 75 HB					
N2.1.2 Aluminium casting alloys, hardened, ≤ 12 % Si, 90 HB					
N2.1.3 Aluminium casting alloys, non-hardened, > 12 % Si, 130 HB					
N3.1.1 Copper and copper alloys: Free-machining alloy, Pb > 1 %					
N3.1.2 Copper and copper alloys: CuZn, CuSnZn					
N3.1.3 Copper and copper alloys: CuSn, lead-free copper and copper electrolyte					
N4.1.1 Non-metallic materials: Duroplastics, fibre-reinforced plastics					
N4.1.2 Non-metallic materials: Hard rubber, wood, etc.					
N4.1.3 Non-metallic materials: Graphite					
S1.1.1 Heat-resistant alloys, Fe-based, annealed, 200 HB	100	0.020	0.030	0.040	0.050
S1.1.2 Heat-resistant alloys, Fe-based, hardened, 280 HB	100	0.020	0.030	0.040	0.050
S1.1.3 Heat-resistant alloys, Ni- or Co-based, annealed, 250 HB	100	0.020	0.030	0.040	0.050
S1.1.4 Heat-resistant alloys, Ni- or Co-based, hardened, 350 HB	100	0.020	0.030	0.040	0.050
S1.1.5 Heat-resistant alloys, Ni- or Co-based, cast, 320 HB	100	0.020	0.030	0.040	0.050
S2.1.1 Titanium alloys, pure titanium, Rm 400 N/mm ²	100	0.020	0.030	0.040	0.050
S2.1.2 Titanium alloys, Alpha and Beta alloys, hardened, Rm 1050 N/mm ²	100	0.020	0.030	0.040	0.050
H1.1.1 Hardened steel, hardened and tempered, < 55 HRC	100	0.020	0.030	0.040	0.050
H1.1.2 Hardened steel, hardened and tempered, < 60 HRC	100	0.020	0.030	0.040	0.050
H1.1.3 Hardened steel, hardened and tempered, > 60 HRC	100	0.020	0.030	0.040	0.050
H2.1.1 Chilled cast iron, 400 HB	100	0.020	0.030	0.040	0.050
H2.1.2 Chilled cast iron, hardened and tempered, < 55 HRC	100	0.020	0.030	0.040	0.050

Cutting data



External grooving System 305, full radius



Machining group	v _c (m/min)	f (mm/rev) with nom. Ø					a _{pmax.} (mm) by radius					
		< 1	< 2	< 3	< 4	≥ 4	≤ 0.25	≤ 0.5	≤ 0.75	≤ 1	≤ 1.25	≤ 2
P1.1.1 Unalloyed steel, annealed, 0.15 % C, Rm 420 N/mm ² , 125 HB	150	0.005	0.010	0.015	0.020	0.025	0.005	0.005	0.005	0.005	0.005	0.005
P1.1.2 Unalloyed steel, heat-treated, 0.15 % C, Rm 420 N/mm ² , 125 HB	150	0.005	0.010	0.015	0.020	0.025	0.005	0.005	0.005	0.005	0.005	0.005
P1.1.3 Unalloyed steel, annealed, 0.45 % C, Rm 640 N/mm ² , 190 HB	150	0.005	0.010	0.015	0.020	0.025	0.005	0.005	0.005	0.005	0.005	0.005
P1.1.4 Unalloyed steel, heat-treated, 0.45 % C, Rm 640 N/mm ² , 190 HB	150	0.005	0.010	0.015	0.020	0.025	0.005	0.005	0.005	0.005	0.005	0.005
P1.1.5 Unalloyed steel, heat-treated, 0.45 % C, Rm 850 N/mm ² , 250 HB	150	0.005	0.010	0.015	0.020	0.025	0.005	0.005	0.005	0.005	0.005	0.005
P1.1.6 Unalloyed steel, annealed, 0.75 % C, Rm 915 N/mm ² , 270 HB	150	0.005	0.010	0.015	0.020	0.025	0.005	0.005	0.005	0.005	0.005	0.005
P1.1.7 Unalloyed steel, heat-treated, 0.75 % C, Rm 1020 N/mm ² , 300 HB	150	0.005	0.010	0.015	0.020	0.025	0.005	0.005	0.005	0.005	0.005	0.005
P2.1.1 Low-alloy steel, annealed, Rm 610 N/mm ² , 180 HB	150	0.005	0.010	0.015	0.020	0.025	0.005	0.005	0.005	0.005	0.005	0.005
P2.1.2 Low-alloy steel, heat-treated, Rm 930 N/mm ² , 275 HB	150	0.005	0.010	0.015	0.020	0.025	0.005	0.005	0.005	0.005	0.005	0.005
P2.1.3 Low-alloy steel, heat-treated, Rm 1020 N/mm ² , 300 HB	150	0.005	0.010	0.015	0.020	0.025	0.005	0.005	0.005	0.005	0.005	0.005
P2.1.4 Low-alloy steel, heat-treated, Rm 1190 N/mm ² , 350 HB	150	0.005	0.010	0.015	0.020	0.025	0.005	0.005	0.005	0.005	0.005	0.005
P3.1.1 High-alloy steel and tool steel, annealed, Rm 680 N/mm ² , 200 HB	150	0.005	0.010	0.015	0.020	0.025	0.005	0.005	0.005	0.005	0.005	0.005
P3.1.2 High-alloy steel and tool steel, hardened and tempered, Rm 1100 N/mm ² , 325 HB	150	0.005	0.010	0.015	0.020	0.025	0.005	0.005	0.005	0.005	0.005	0.005
M1.1.1 Stainless steel, ferritic/martensitic, with machining additives	135	0.005	0.010	0.010	0.015	0.020	0.005	0.005	0.005	0.005	0.005	0.005
M1.1.2 Stainless steel, ferritic/martensitic, annealed, Rm 680 N/mm ² , 200 HB	135	0.005	0.010	0.010	0.015	0.020	0.005	0.005	0.005	0.005	0.005	0.005
M1.1.3 Stainless steel, ferritic/martensitic, heat-treated, Rm 810 N/mm ² , 240 HB	135	0.005	0.010	0.010	0.015	0.020	0.005	0.005	0.005	0.005	0.005	0.005
M2.1.1 Stainless steel, austenitic, quenched, 180 HB	135	0.005	0.010	0.010	0.015	0.020	0.005	0.005	0.005	0.005	0.005	0.005
M2.2.1 Duplex steel, high-strength stainless steels	135	0.005	0.010	0.010	0.015	0.020	0.005	0.005	0.005	0.005	0.005	0.005
K1.1.1 Grey cast iron, pearlitic/ferritic, 180 HB	150	0.005	0.015	0.020	0.025	0.030	0.005	0.005	0.005	0.005	0.005	0.005
K1.1.2 Grey cast iron, pearlitic/martensitic, 260 HB	150	0.005	0.015	0.020	0.025	0.030	0.005	0.005	0.005	0.005	0.005	0.005
K1.2.1 Cast iron with spheroidal graphite, ferritic, 160 HB	150	0.005	0.015	0.020	0.025	0.030	0.005	0.005	0.005	0.005	0.005	0.005
K1.2.2 Cast iron with spheroidal graphite, pearlitic, 250 HB	150	0.005	0.015	0.020	0.025	0.030	0.005	0.005	0.005	0.005	0.005	0.005
K1.3.1 Malleable cast iron, ferritic, 130 HB	150	0.005	0.015	0.020	0.025	0.030	0.005	0.005	0.005	0.005	0.005	0.005
K1.3.2 Malleable cast iron, pearlitic, 230 HB	150	0.005	0.015	0.020	0.025	0.030	0.005	0.005	0.005	0.005	0.005	0.005
K2.1.1 Vermicular graphite cast iron (GJV)												
K2.2.1 Austenitic-ferritic spheroidal graphite cast iron (ADI)												
N1.1.1 Wrought aluminium alloys, non-hardened, 60 HB	300	0.010	0.015	0.025	0.030	0.040	0.010	0.010	0.010	0.010	0.010	0.010
N1.1.2 Wrought aluminium alloys, hardened, 100 HB	300	0.010	0.015	0.025	0.030	0.040	0.010	0.010	0.010	0.010	0.010	0.010
N2.1.1 Aluminium casting alloys, non-hardened, ≤ 12 % Si, 75 HB	300	0.010	0.015	0.025	0.030	0.040	0.010	0.010	0.010	0.010	0.010	0.010
N2.1.2 Aluminium casting alloys, hardened, ≤ 12 % Si, 90 HB	300	0.010	0.015	0.025	0.030	0.040	0.010	0.010	0.010	0.010	0.010	0.010
N2.1.3 Aluminium casting alloys, non-hardened, > 12 % Si, 130 HB	300	0.010	0.015	0.025	0.030	0.040	0.010	0.010	0.010	0.010	0.010	0.010
N3.1.1 Copper and copper alloys: Free-machining alloy, Pb > 1 %	300	0.010	0.015	0.025	0.030	0.040	0.010	0.010	0.010	0.010	0.010	0.010
N3.1.2 Copper and copper alloys: CuZn, CuSnZn	300	0.010	0.015	0.025	0.030	0.040	0.010	0.010	0.010	0.010	0.010	0.010
N3.1.3 Copper and copper alloys: CuSn, lead-free copper and copper electrolyte	300	0.010	0.015	0.025	0.030	0.040	0.010	0.010	0.010	0.010	0.010	0.010
N4.1.1 Non-metallic materials: Duroplastics, fibre-reinforced plastics	300	0.010	0.015	0.025	0.030	0.040	0.010	0.010	0.010	0.010	0.010	0.010
N4.1.2 Non-metallic materials: Hard rubber, wood, etc.	300	0.010	0.015	0.025	0.030	0.040	0.010	0.010	0.010	0.010	0.010	0.010
N4.1.3 Non-metallic materials: Graphite	300	0.010	0.015	0.025	0.030	0.040	0.010	0.010	0.010	0.010	0.010	0.010
S1.1.1 Heat-resistant alloys, Fe-based, annealed, 200 HB	100	0.005	0.005	0.005	0.010	0.010	0.005	0.005	0.005	0.005	0.005	0.005
S1.1.2 Heat-resistant alloys, Fe-based, hardened, 280 HB	100	0.005	0.005	0.005	0.010	0.010	0.005	0.005	0.005	0.005	0.005	0.005
S1.1.3 Heat-resistant alloys, Ni- or Co-based, annealed, 250 HB	100	0.005	0.005	0.005	0.010	0.010	0.005	0.005	0.005	0.005	0.005	0.005
S1.1.4 Heat-resistant alloys, Ni- or Co-based, hardened, 350 HB	100	0.005	0.005	0.005	0.010	0.010	0.005	0.005	0.005	0.005	0.005	0.005
S1.1.5 Heat-resistant alloys, Ni- or Co-based, cast, 320 HB	100	0.005	0.005	0.005	0.010	0.010	0.005	0.005	0.005	0.005	0.005	0.005
S2.1.1 Titanium alloys, pure titanium, Rm 400 N/mm ²	100	0.005	0.005	0.005	0.010	0.010	0.005	0.005	0.005	0.005	0.005	0.005
S2.1.2 Titanium alloys, Alpha and Beta alloys, hardened, Rm 1050 N/mm ²	100	0.005	0.005	0.005	0.010	0.010	0.005	0.005	0.005	0.005	0.005	0.005
H1.1.1 Hardened steel, hardened and tempered, < 55 HRC	100	0.005	0.005	0.005	0.010	0.010	0.005	0.005	0.005	0.005	0.005	0.005
H1.1.2 Hardened steel, hardened and tempered, < 60 HRC	100	0.005	0.005	0.005	0.010	0.010	0.005	0.005	0.005	0.005	0.005	0.005
H1.1.3 Hardened steel, hardened and tempered, > 60 HRC	100	0.005	0.005	0.005	0.010	0.010	0.005	0.005	0.005	0.005	0.005	0.005
H2.1.1 Chilled cast iron, 400 HB	100	0.005	0.005	0.005	0.010	0.010	0.005	0.005	0.005	0.005	0.005	0.005
H2.1.2 Chilled cast iron, hardened and tempered, < 55 HRC	100	0.005	0.005	0.005	0.010	0.010	0.005	0.005	0.005	0.005	0.005	0.005

Attention: Material suitability by coating

Full radius: b/R = 2



Axial grooving



Machining group	System 104/106 (axial grooving)		System 104 (axial chamfering)	
	v_c (m/min)	f (mm/rev)	v_c (m/min)	f (mm/rev)
P1.1.1 Unalloyed steel, annealed, 0.15 % C, Rm 420 N/mm ² , 125 HB	35	0.020	60	0.025
P1.1.2 Unalloyed steel, heat-treated, 0.15 % C, Rm 420 N/mm ² , 125 HB	35	0.020	60	0.025
P1.1.3 Unalloyed steel, annealed, 0.45 % C, Rm 640 N/mm ² , 190 HB	35	0.020	60	0.025
P1.1.4 Unalloyed steel, heat-treated, 0.45 % C, Rm 640 N/mm ² , 190 HB	35	0.020	60	0.025
P1.1.5 Unalloyed steel, heat-treated, 0.45 % C, Rm 850 N/mm ² , 250 HB	35	0.020	60	0.025
P1.1.6 Unalloyed steel, annealed, 0.75 % C, Rm 915 N/mm ² , 270 HB	35	0.020	60	0.025
P1.1.7 Unalloyed steel, heat-treated, 0.75 % C, Rm 1020 N/mm ² , 300 HB	35	0.020	60	0.025
P2.1.1 Low-alloy steel, annealed, Rm 610 N/mm ² , 180 HB	35	0.020	60	0.025
P2.1.2 Low-alloy steel, heat-treated, Rm 930 N/mm ² , 275 HB	35	0.020	60	0.025
P2.1.3 Low-alloy steel, heat-treated, Rm 1020 N/mm ² , 300 HB	35	0.020	60	0.025
P2.1.4 Low-alloy steel, heat-treated, Rm 1190 N/mm ² , 350 HB	35	0.020	60	0.025
P3.1.1 High-alloy steel and tool steel, annealed, Rm 680 N/mm ² , 200 HB	35	0.020	60	0.025
P3.1.2 High-alloy steel and tool steel, hardened and tempered, Rm 1100 N/mm ² , 325 HB	35	0.020	60	0.025
M1.1.1 Stainless steel, ferritic/martensitic, with machining additives	30	0.015	55	0.020
M1.1.2 Stainless steel, ferritic/martensitic, annealed, Rm 680 N/mm ² , 200 HB	30	0.015	55	0.020
M1.1.3 Stainless steel, ferritic/martensitic, heat-treated, Rm 810 N/mm ² , 240 HB	30	0.015	55	0.020
M2.1.1 Stainless steel, austenitic, quenched, 180 HB	30	0.015	55	0.020
M2.2.1 Duplex steel, high-strength stainless steels	30	0.015	55	0.020
K1.1.1 Grey cast iron, pearlitic/ferritic, 180 HB	35	0.025	60	0.030
K1.1.2 Grey cast iron, pearlitic/martensitic, 260 HB	35	0.025	60	0.030
K1.2.1 Cast iron with spheroidal graphite, ferritic, 160 HB	35	0.025	60	0.030
K1.2.2 Cast iron with spheroidal graphite, pearlitic, 250 HB	35	0.025	60	0.030
K1.3.1 Malleable cast iron, ferritic, 130 HB	35	0.025	60	0.030
K1.3.2 Malleable cast iron, pearlitic, 230 HB	35	0.025	60	0.030
K2.1.1 Vermicular graphite cast iron (GJV)				
K2.2.1 Austenitic-ferritic spheroidal graphite cast iron (ADI)				
N1.1.1 Wrought aluminium alloys, non-hardened, 60 HB	70	0.030	120	0.040
N1.1.2 Wrought aluminium alloys, hardened, 100 HB	70	0.030	120	0.040
N2.1.1 Aluminium casting alloys, non-hardened, ≤ 12 % Si, 75 HB	70	0.030	120	0.040
N2.1.2 Aluminium casting alloys, hardened, ≤ 12 % Si, 90 HB	70	0.030	120	0.040
N2.1.3 Aluminium casting alloys, non-hardened, > 12 % Si, 130 HB	70	0.030	120	0.040
N3.1.1 Copper and copper alloys: Free-machining alloy, Pb > 1 %	70	0.030	120	0.040
N3.1.2 Copper and copper alloys: CuZn, CuSnZn	70	0.030	120	0.040
N3.1.3 Copper and copper alloys: CuSn, lead-free copper and copper electrolyte	70	0.030	120	0.040
N4.1.1 Non-metallic materials: Duroplastics, fibre-reinforced plastics	70	0.030	120	0.040
N4.1.2 Non-metallic materials: Hard rubber, wood, etc.	70	0.030	120	0.040
N4.1.3 Non-metallic materials: Graphite	70	0.030	120	0.040
S1.1.1 Heat-resistant alloys, Fe-based, annealed, 200 HB	25	0.010	40	0.010
S1.1.2 Heat-resistant alloys, Fe-based, hardened, 280 HB	25	0.010	40	0.010
S1.1.3 Heat-resistant alloys, Ni- or Co-based, annealed, 250 HB	25	0.010	40	0.010
S1.1.4 Heat-resistant alloys, Ni- or Co-based, hardened, 350 HB	25	0.010	40	0.010
S1.1.5 Heat-resistant alloys, Ni- or Co-based, cast, 320 HB	25	0.010	40	0.010
S2.1.1 Titanium alloys, pure titanium, Rm 400 N/mm ²	25	0.010	40	0.010
S2.1.2 Titanium alloys, Alpha and Beta alloys, hardened, Rm 1050 N/mm ²	25	0.010	40	0.010
H1.1.1 Hardened steel, hardened and tempered, < 55 HRC	25	0.010	40	0.010
H1.1.2 Hardened steel, hardened and tempered, < 60 HRC	25	0.010	40	0.010
H1.1.3 Hardened steel, hardened and tempered, > 60 HRC	25	0.010	40	0.010
H2.1.1 Chilled cast iron, 400 HB	25	0.010	40	0.010
H2.1.2 Chilled cast iron, hardened and tempered, < 55 HRC	25	0.010	40	0.010



v _c (m/min)	System 305				System 305 axial external recesses	
	f (mm/rev) by width				f (mm/rev) by width	
	1.5	2.5	3.5	4.5	1.5	2.5
	< 2	< 3	< 4	≥ 4	< 2	≥ 2
140	0.015	0.025	0.030	0.040	0.010	0.010
140	0.015	0.025	0.030	0.040	0.010	0.010
140	0.015	0.025	0.030	0.040	0.010	0.010
140	0.015	0.025	0.030	0.040	0.010	0.010
140	0.015	0.025	0.030	0.040	0.010	0.010
140	0.015	0.025	0.030	0.040	0.010	0.010
140	0.015	0.025	0.030	0.040	0.010	0.010
140	0.015	0.025	0.030	0.040	0.010	0.010
140	0.015	0.025	0.030	0.040	0.010	0.010
140	0.015	0.025	0.030	0.040	0.010	0.010
140	0.015	0.025	0.030	0.040	0.010	0.010
140	0.015	0.025	0.030	0.040	0.010	0.010
140	0.015	0.025	0.030	0.040	0.010	0.010
125	0.010	0.020	0.025	0.030	0.005	0.010
125	0.010	0.020	0.025	0.030	0.005	0.010
125	0.010	0.020	0.025	0.030	0.005	0.010
125	0.010	0.020	0.025	0.030	0.005	0.010
125	0.010	0.020	0.025	0.030	0.005	0.010
140	0.020	0.030	0.040	0.050	0.010	0.015
140	0.020	0.030	0.040	0.050	0.010	0.015
140	0.020	0.030	0.040	0.050	0.010	0.015
140	0.020	0.030	0.040	0.050	0.010	0.015
140	0.020	0.030	0.040	0.050	0.010	0.015
140	0.020	0.030	0.040	0.050	0.010	0.015
280	0.025	0.035	0.050	0.060	0.010	0.020
280	0.025	0.035	0.050	0.060	0.010	0.020
280	0.025	0.035	0.050	0.060	0.010	0.020
280	0.025	0.035	0.050	0.060	0.010	0.020
280	0.025	0.035	0.050	0.060	0.010	0.020
280	0.025	0.035	0.050	0.060	0.010	0.020
280	0.025	0.035	0.050	0.060	0.010	0.020
280	0.025	0.035	0.050	0.060	0.010	0.020
280	0.025	0.035	0.050	0.060	0.010	0.020
280	0.025	0.035	0.050	0.060	0.010	0.020
280	0.025	0.035	0.050	0.060	0.010	0.020
280	0.025	0.035	0.050	0.060	0.010	0.020
90	0.005	0.010	0.015	0.015	0.005	0.005
90	0.005	0.010	0.015	0.015	0.005	0.005
90	0.005	0.010	0.015	0.015	0.005	0.005
90	0.005	0.010	0.015	0.015	0.005	0.005
90	0.005	0.010	0.015	0.015	0.005	0.005
90	0.005	0.010	0.015	0.015	0.005	0.005
90	0.005	0.010	0.015	0.015	0.005	0.005
90	0.005	0.010	0.015	0.015	0.005	0.005
90	0.005	0.010	0.015	0.015	0.005	0.005
90	0.005	0.010	0.015	0.015	0.005	0.005
90	0.005	0.010	0.015	0.015	0.005	0.005
90	0.005	0.010	0.015	0.015	0.005	0.005
90	0.005	0.010	0.015	0.015	0.005	0.005
90	0.005	0.010	0.015	0.015	0.005	0.005

Cutting data



Parting off



Machining group	System 305			System 222				
	v _c (m/min)	F	E	v _c (m/min) by width		PP neutral	PM L/R	MP
		f (mm/rev)		2	3	f (mm/rev)		
P1.1.1 Unalloyed steel, annealed, 0.15 % C, Rm 420 N/mm ² , 125 HB	120	0.080	0.080	100	120	0.130	0.060	0.100
P1.1.2 Unalloyed steel, heat-treated, 0.15 % C, Rm 420 N/mm ² , 125 HB	120	0.080	0.080	100	120	0.130	0.060	0.100
P1.1.3 Unalloyed steel, annealed, 0.45 % C, Rm 640 N/mm ² , 190 HB	120	0.080	0.080	100	120	0.130	0.060	0.100
P1.1.4 Unalloyed steel, heat-treated, 0.45 % C, Rm 640 N/mm ² , 190 HB	120	0.080	0.080	100	120	0.130	0.060	0.100
P1.1.5 Unalloyed steel, heat-treated, 0.45 % C, Rm 850 N/mm ² , 250 HB	120	0.080	0.080	100	120	0.130	0.060	0.100
P1.1.6 Unalloyed steel, annealed, 0.75 % C, Rm 915 N/mm ² , 270 HB	120	0.080	0.080	100	120	0.130	0.060	0.100
P1.1.7 Unalloyed steel, heat-treated, 0.75 % C, Rm 1020 N/mm ² , 300 HB	120	0.080	0.080	100	120	0.130	0.060	0.100
P2.1.1 Low-alloy steel, annealed, Rm 610 N/mm ² , 180 HB	120	0.080	0.080	100	120	0.130	0.060	0.100
P2.1.2 Low-alloy steel, heat-treated, Rm 930 N/mm ² , 275 HB	120	0.080	0.080	100	120	0.130	0.060	0.100
P2.1.3 Low-alloy steel, heat-treated, Rm 1020 N/mm ² , 300 HB	120	0.080	0.080	100	120	0.130	0.060	0.100
P2.1.4 Low-alloy steel, heat-treated, Rm 1190 N/mm ² , 350 HB	120	0.080	0.080	100	120	0.130	0.060	0.100
P3.1.1 High-alloy steel and tool steel, annealed, Rm 680 N/mm ² , 200 HB	120	0.080	0.080	100	120	0.130	0.060	0.100
P3.1.2 High-alloy steel and tool steel, hardened and tempered, Rm 1100 N/mm ² , 325 HB	120	0.080	0.080	100	120	0.130	0.060	0.100
M1.1.1 Stainless steel, ferritic/martensitic, with machining additives	110	0.060	0.060	90	110	0.100	0.045	0.075
M1.1.2 Stainless steel, ferritic/martensitic, annealed, Rm 680 N/mm ² , 200 HB	110	0.060	0.060	90	110	0.100	0.045	0.075
M1.1.3 Stainless steel, ferritic/martensitic, heat-treated, Rm 810 N/mm ² , 240 HB	110	0.060	0.060	90	110	0.100	0.045	0.075
M2.1.1 Stainless steel, austenitic, quenched, 180 HB	110	0.060	0.060	90	110	0.100	0.045	0.075
M2.2.1 Duplex steel, high-strength stainless steels	110	0.060	0.060	90	110	0.100	0.045	0.075
K1.1.1 Grey cast iron, pearlitic/ferritic, 180 HB	120	0.100	0.100	100	120	0.165	0.075	
K1.1.2 Grey cast iron, pearlitic/martensitic, 260 HB	120	0.100	0.100	100	120	0.165	0.075	
K1.2.1 Cast iron with spheroidal graphite, ferritic, 160 HB	120	0.100	0.100	100	120	0.165	0.075	
K1.2.2 Cast iron with spheroidal graphite, pearlitic, 250 HB	120	0.100	0.100	100	120	0.165	0.075	
K1.3.1 Malleable cast iron, ferritic, 130 HB	120	0.100	0.100	100	120	0.165	0.075	
K1.3.2 Malleable cast iron, pearlitic, 230 HB	120	0.100	0.100	100	120	0.165	0.075	
K2.1.1 Vermicular graphite cast iron (GJV)				100	120	0.130	0.060	
K2.2.1 Austenitic-ferritic spheroidal graphite cast iron (ADI)				100	120	0.130	0.060	
N1.1.1 Wrought aluminium alloys, non-hardened, 60 HB	240		0.120					
N1.1.2 Wrought aluminium alloys, hardened, 100 HB	240		0.120					
N2.1.1 Aluminium casting alloys, non-hardened, ≤ 12 % Si, 75 HB	240		0.120					
N2.1.2 Aluminium casting alloys, hardened, ≤ 12 % Si, 90 HB	240		0.120					
N2.1.3 Aluminium casting alloys, non-hardened, > 12 % Si, 130 HB	240		0.120					
N3.1.1 Copper and copper alloys: Free-machining alloy, Pb > 1 %	240		0.120					
N3.1.2 Copper and copper alloys: CuZn, CuSnZn	240		0.120					
N3.1.3 Copper and copper alloys: CuSn, lead-free copper and copper electrolyte	240		0.120					
N4.1.1 Non-metallic materials: Duroplastics, fibre-reinforced plastics	240		0.120					
N4.1.2 Non-metallic materials: Hard rubber, wood, etc.	240		0.120					
N4.1.3 Non-metallic materials: Graphite	240		0.120					
S1.1.1 Heat-resistant alloys, Fe-based, annealed, 200 HB	80		0.030					
S1.1.2 Heat-resistant alloys, Fe-based, hardened, 280 HB	80		0.030					
S1.1.3 Heat-resistant alloys, Ni- or Co-based, annealed, 250 HB	80		0.030					
S1.1.4 Heat-resistant alloys, Ni- or Co-based, hardened, 350 HB	80		0.030					
S1.1.5 Heat-resistant alloys, Ni- or Co-based, cast, 320 HB	80		0.030					
S2.1.1 Titanium alloys, pure titanium, Rm 400 N/mm ²	80		0.030					
S2.1.2 Titanium alloys, Alpha and Beta alloys, hardened, Rm 1050 N/mm ²	80		0.030					
H1.1.1 Hardened steel, hardened and tempered, < 55 HRC	80	0.030						
H1.1.2 Hardened steel, hardened and tempered, < 60 HRC	80	0.030						
H1.1.3 Hardened steel, hardened and tempered, > 60 HRC	80	0.030						
H2.1.1 Chilled cast iron, 400 HB	80	0.030						
H2.1.2 Chilled cast iron, hardened and tempered, < 55 HRC	80	0.030						



Boring out forwards System 104



Machining group	Length	v _c (m/min)	f (mm/rev) by radius						ap _{max.} (mm) by radius					
			0.05	0.1	0.15	0.2	0.25	> 0.25	0.05	0.1	0.15	0.2	0.25	> 0.25
P1.1.1 Unalloyed steel, annealed, 0.15 % C, Rm 420 N/mm ² , 125 HB P1.1.2 Unalloyed steel, heat-treated, 0.15 % C, Rm 420 N/mm ² , 125 HB P1.1.3 Unalloyed steel, annealed, 0.45 % C, Rm 640 N/mm ² , 190 HB P1.1.4 Unalloyed steel, heat-treated, 0.45 % C, Rm 640 N/mm ² , 190 HB P1.1.5 Unalloyed steel, heat-treated, 0.45 % C, Rm 850 N/mm ² , 250 HB P1.1.6 Unalloyed steel, annealed, 0.75 % C, Rm 915 N/mm ² , 270 HB P1.1.7 Unalloyed steel, heat-treated, 0.75 % C, Rm 1020 N/mm ² , 300 HB	K	45	0.010	0.015	0.025	0.035	0.045	0.050	0.075	0.125	0.150	0.200	0.250	0.275
	M	35	0.010	0.015	0.025	0.035	0.045	0.050	0.060	0.100	0.120	0.160	0.200	0.220
	L	20	0.005	0.010	0.015	0.020	0.025	0.030	0.045	0.070	0.085	0.115	0.145	0.155
P2.1.1 Low-alloy steel, annealed, Rm 610 N/mm ² , 180 HB P2.1.2 Low-alloy steel, heat-treated, Rm 930 N/mm ² , 275 HB P2.1.3 Low-alloy steel, heat-treated, Rm 1020 N/mm ² , 300 HB P2.1.4 Low-alloy steel, heat-treated, Rm 1190 N/mm ² , 350 HB	K	45	0.010	0.015	0.025	0.035	0.045	0.050	0.075	0.125	0.150	0.200	0.250	0.275
	M	35	0.010	0.015	0.025	0.035	0.045	0.050	0.060	0.100	0.120	0.160	0.200	0.220
	L	20	0.005	0.010	0.015	0.020	0.025	0.030	0.045	0.070	0.085	0.115	0.145	0.155
P3.1.1 High-alloy steel and tool steel, annealed, Rm 680 N/mm ² , 200 HB P3.1.2 High-alloy steel and tool steel, hardened and tempered, Rm 1100 N/mm ² , 325 HB	K	45	0.010	0.015	0.025	0.035	0.045	0.050	0.075	0.125	0.150	0.200	0.250	0.275
	M	35	0.010	0.015	0.025	0.035	0.045	0.050	0.060	0.100	0.120	0.160	0.200	0.220
	L	20	0.005	0.010	0.015	0.020	0.025	0.030	0.045	0.070	0.085	0.115	0.145	0.155
M1.1.1 Stainless steel, ferritic/martensitic, with machining additives M1.1.2 Stainless steel, ferritic/martensitic, annealed, Rm 680 N/mm ² , 200 HB M1.1.3 Stainless steel, ferritic/martensitic, heat-treated, Rm 810 N/mm ² , 240 HB	K	40	0.005	0.015	0.020	0.025	0.030	0.040	0.075	0.125	0.150	0.200	0.250	0.275
	M	30	0.005	0.015	0.020	0.025	0.030	0.040	0.060	0.100	0.120	0.160	0.200	0.220
	L	20	0.005	0.005	0.010	0.015	0.020	0.020	0.045	0.070	0.085	0.115	0.145	0.155
M2.1.1 Stainless steel, austenitic, quenched, 180 HB M2.1.2 Duplex steel, high-strength stainless steels	K	40	0.005	0.015	0.020	0.025	0.030	0.040	0.075	0.125	0.150	0.200	0.250	0.275
	M	30	0.005	0.015	0.020	0.025	0.030	0.040	0.060	0.100	0.120	0.160	0.200	0.220
	L	20	0.005	0.005	0.010	0.015	0.020	0.020	0.045	0.070	0.085	0.115	0.145	0.155
K1.1.1 Grey cast iron, pearlitic/ferritic, 180 HB K1.1.2 Grey cast iron, pearlitic/martensitic, 260 HB K1.2.1 Cast iron with spheroidal graphite, ferritic, 160 HB K1.2.2 Cast iron with spheroidal graphite, pearlitic, 250 HB K1.3.1 Malleable cast iron, ferritic, 130 HB K1.3.2 Malleable cast iron, pearlitic, 230 HB	K	45	0.010	0.020	0.030	0.045	0.055	0.065	0.075	0.125	0.150	0.200	0.250	0.275
	M	35	0.010	0.020	0.030	0.045	0.055	0.065	0.060	0.100	0.120	0.160	0.200	0.220
	L	20	0.005	0.010	0.020	0.025	0.030	0.035	0.045	0.070	0.085	0.115	0.145	0.155
K2.1.1 Vermicular graphite cast iron (GJV) K2.2.1 Austenitic-ferritic spheroidal graphite cast iron (ADI)														
N1.1.1 Wrought aluminium alloys, non-hardened, 60 HB N1.1.2 Wrought aluminium alloys, hardened, 100 HB	K	90	0.015	0.025	0.040	0.050	0.065	0.075	0.075	0.125	0.150	0.200	0.250	0.275
	M	70	0.015	0.025	0.040	0.050	0.065	0.075	0.060	0.100	0.120	0.160	0.200	0.220
	L	40	0.005	0.015	0.020	0.030	0.035	0.040	0.045	0.070	0.085	0.115	0.145	0.155
N2.1.1 Aluminium casting alloys, non-hardened, ≤ 12 % Si, 75 HB N2.1.2 Aluminium casting alloys, hardened, ≤ 12 % Si, 90 HB N2.1.3 Aluminium casting alloys, non-hardened, > 12 % Si, 130 HB	K	90	0.015	0.025	0.040	0.050	0.065	0.075	0.075	0.125	0.150	0.200	0.250	0.275
	M	70	0.015	0.025	0.040	0.050	0.065	0.075	0.060	0.100	0.120	0.160	0.200	0.220
	L	40	0.005	0.015	0.020	0.030	0.035	0.040	0.045	0.070	0.085	0.115	0.145	0.155
N3.1.1 Copper and copper alloys: Free-machining alloy, Pb > 1 % N3.1.2 Copper and copper alloys: CuZn, CuSnZn N3.1.3 Copper and copper alloys: CuSn, lead-free copper and copper electrolyte	K	90	0.015	0.025	0.040	0.050	0.065	0.075	0.075	0.125	0.150	0.200	0.250	0.275
	M	70	0.015	0.025	0.040	0.050	0.065	0.075	0.060	0.100	0.120	0.160	0.200	0.220
	L	40	0.005	0.015	0.020	0.030	0.035	0.040	0.045	0.070	0.085	0.115	0.145	0.155
N4.1.1 Non-metallic materials: Duroplastics, fibre-reinforced plastics N4.1.2 Non-metallic materials: Hard rubber, wood, etc. N4.1.3 Non-metallic materials: Graphite	K	90	0.015	0.025	0.040	0.050	0.065	0.075	0.075	0.125	0.150	0.200	0.250	0.275
	M	70	0.015	0.025	0.040	0.050	0.065	0.075	0.060	0.100	0.120	0.160	0.200	0.220
	L	40	0.005	0.015	0.020	0.030	0.035	0.040	0.045	0.070	0.085	0.115	0.145	0.155
S1.1.1 Heat-resistant alloys, Fe-based, annealed, 200 HB S1.1.2 Heat-resistant alloys, Fe-based, hardened, 280 HB S1.1.3 Heat-resistant alloys, Ni- or Co-based, annealed, 250 HB S1.1.4 Heat-resistant alloys, Ni- or Co-based, hardened, 350 HB S1.1.5 Heat-resistant alloys, Ni- or Co-based, cast, 320 HB	K	30	0.005	0.005	0.010	0.015	0.015	0.020	0.075	0.125	0.150	0.200	0.250	0.275
	M	20	0.005	0.005	0.010	0.015	0.015	0.020	0.060	0.100	0.120	0.160	0.200	0.220
	L	15	0.005	0.005	0.005	0.005	0.010	0.010	0.045	0.070	0.085	0.115	0.145	0.155
S2.1.1 Titanium alloys, pure titanium, Rm 400 N/mm ² S2.1.2 Titanium alloys, Alpha and Beta alloys, hardened, Rm 1050 N/mm ²	K	30	0.005	0.005	0.010	0.015	0.015	0.020	0.075	0.125	0.150	0.200	0.250	0.275
	M	20	0.005	0.005	0.010	0.015	0.015	0.020	0.060	0.100	0.120	0.160	0.200	0.220
	L	15	0.005	0.005	0.005	0.005	0.010	0.010	0.045	0.070	0.085	0.115	0.145	0.155
H1.1.1 Hardened steel, hardened and tempered, < 55 HRC H1.1.2 Hardened steel, hardened and tempered, < 60 HRC H1.1.3 Hardened steel, hardened and tempered, > 60 HRC	K	30	0.005	0.005	0.010	0.015	0.015	0.020	0.075	0.125	0.150	0.200	0.250	0.275
	M	20	0.005	0.005	0.010	0.015	0.015	0.020	0.060	0.100	0.120	0.160	0.200	0.220
	L	15	0.005	0.005	0.005	0.005	0.010	0.010	0.045	0.070	0.085	0.115	0.145	0.155
H2.1.1 Chilled cast iron, 400 HB H2.1.2 Chilled cast iron, hardened and tempered, < 55 HRC	K	30	0.005	0.005	0.010	0.015	0.015	0.020	0.075	0.125	0.150	0.200	0.250	0.275
	M	20	0.005	0.005	0.010	0.015	0.015	0.020	0.060	0.100	0.120	0.160	0.200	0.220
	L	15	0.005	0.005	0.005	0.005	0.010	0.010	0.045	0.070	0.085	0.115	0.145	0.155

Feed for cutting inserts with WIPER geometry: + ~ 18 %

K = short tools with La/Dmin. < 3.5 | M = medium length tools with La/Dmin. from 3.5 - 6.5 | L = long tools with La/Dmin. > 6.5



Boring out forwards System 106



Machining group	Length	V _c (m/min)	f by radius					
			0.05			0.1		
			t _{max.}					
			< 1	1	2	< 1	1	2
f (mm/rev)								
P1.1.1 Unalloyed steel, annealed, 0.15 % C, Rm 420 N/mm ² , 125 HB P1.1.2 Unalloyed steel, heat-treated, 0.15 % C, Rm 420 N/mm ² , 125 HB P1.1.3 Unalloyed steel, annealed, 0.45 % C, Rm 640 N/mm ² , 190 HB P1.1.4 Unalloyed steel, heat-treated, 0.45 % C, Rm 640 N/mm ² , 190 HB P1.1.5 Unalloyed steel, heat-treated, 0.45 % C, Rm 850 N/mm ² , 250 HB P1.1.6 Unalloyed steel, annealed, 0.75 % C, Rm 915 N/mm ² , 270 HB P1.1.7 Unalloyed steel, heat-treated, 0.75 % C, Rm 1020 N/mm ² , 300 HB	K	90	0.015	0.015	0.010	0.035	0.025	0.015
	M	70	0.015	0.015	0.010	0.035	0.025	0.015
	L	40	0.010	0.005	0.005	0.020	0.015	0.010
P2.1.1 Low-alloy steel, annealed, Rm 610 N/mm ² , 180 HB P2.1.2 Low-alloy steel, heat-treated, Rm 930 N/mm ² , 275 HB P2.1.3 Low-alloy steel, heat-treated, Rm 1020 N/mm ² , 300 HB P2.1.4 Low-alloy steel, heat-treated, Rm 1190 N/mm ² , 350 HB	K	90	0.015	0.015	0.010	0.035	0.025	0.015
	M	70	0.015	0.015	0.010	0.035	0.025	0.015
	L	40	0.010	0.005	0.005	0.020	0.015	0.010
P3.1.1 High-alloy steel and tool steel, annealed, Rm 680 N/mm ² , 200 HB P3.1.2 High-alloy steel and tool steel, hardened and tempered, Rm 1100 N/mm ² , 325 HB	K	90	0.015	0.015	0.010	0.035	0.025	0.015
	M	70	0.015	0.015	0.010	0.035	0.025	0.015
	L	40	0.010	0.005	0.005	0.020	0.015	0.010
M1.1.1 Stainless steel, ferritic/martensitic, with machining additives M1.1.2 Stainless steel, ferritic/martensitic, annealed, Rm 680 N/mm ² , 200 HB M1.1.3 Stainless steel, ferritic/martensitic, heat-treated, Rm 810 N/mm ² , 240 HB	K	80	0.010	0.010	0.005	0.025	0.020	0.015
	M	60	0.010	0.010	0.005	0.025	0.020	0.015
	L	40	0.005	0.005	0.005	0.015	0.010	0.005
M2.1.1 Stainless steel, austenitic, quenched, 180 HB M2.2.1 Duplex steel, high-strength stainless steels	K	80	0.010	0.010	0.005	0.025	0.020	0.015
	M	60	0.010	0.010	0.005	0.025	0.020	0.015
	L	40	0.005	0.005	0.005	0.015	0.010	0.005
K1.1.1 Grey cast iron, pearlitic/ferritic, 180 HB K1.1.2 Grey cast iron, pearlitic/martensitic, 260 HB K1.2.1 Cast iron with spheroidal graphite, ferritic, 160 HB K1.2.2 Cast iron with spheroidal graphite, pearlitic, 250 HB K1.3.1 Malleable cast iron, ferritic, 130 HB K1.3.2 Malleable cast iron, pearlitic, 230 HB	K	90	0.020	0.015	0.010	0.040	0.030	0.020
	M	70	0.020	0.015	0.010	0.040	0.030	0.020
	L	40	0.010	0.010	0.005	0.025	0.015	0.010
K2.1.1 Vermicular graphite cast iron (GJV) K2.2.1 Austenitic-ferritic spheroidal graphite cast iron (ADI)								
N1.1.1 Wrought aluminium alloys, non-hardened, 60 HB N1.1.2 Wrought aluminium alloys, hardened, 100 HB	K	180	0.025	0.020	0.015	0.050	0.040	0.025
	M	135	0.025	0.020	0.015	0.050	0.040	0.025
	L	85	0.015	0.010	0.005	0.025	0.020	0.015
N2.1.1 Aluminium casting alloys, non-hardened, ≤ 12 % Si, 75 HB N2.1.2 Aluminium casting alloys, hardened, ≤ 12 % Si, 90 HB N2.1.3 Aluminium casting alloys, non-hardened, > 12 % Si, 130 HB	K	180	0.025	0.020	0.015	0.050	0.040	0.025
	M	135	0.025	0.020	0.015	0.050	0.040	0.025
	L	85	0.015	0.010	0.005	0.025	0.020	0.015
N3.1.1 Copper and copper alloys: Free-machining alloy, Pb > 1 % N3.1.2 Copper and copper alloys: CuZn, CuSnZn N3.1.3 Copper and copper alloys: CuSn, lead-free copper and copper electrolyte	K	180	0.025	0.020	0.015	0.050	0.040	0.025
	M	135	0.025	0.020	0.015	0.050	0.040	0.025
	L	85	0.015	0.010	0.005	0.025	0.020	0.015
N4.1.1 Non-metallic materials: Duroplastics, fibre-reinforced plastics N4.1.2 Non-metallic materials: Hard rubber, wood, etc. N4.1.3 Non-metallic materials: Graphite	K	180	0.025	0.020	0.015	0.050	0.040	0.025
	M	135	0.025	0.020	0.015	0.050	0.040	0.025
	L	85	0.015	0.010	0.005	0.025	0.020	0.015
S1.1.1 Heat-resistant alloys, Fe-based, annealed, 200 HB S1.1.2 Heat-resistant alloys, Fe-based, hardened, 280 HB S1.1.3 Heat-resistant alloys, Ni- or Co-based, annealed, 250 HB S1.1.4 Heat-resistant alloys, Ni- or Co-based, hardened, 350 HB S1.1.5 Heat-resistant alloys, Ni- or Co-based, cast, 320 HB	K	60	0.005	0.005	0.005	0.015	0.010	0.005
	M	45	0.005	0.005	0.005	0.015	0.010	0.005
	L	25	0.005	0.005	0.005	0.005	0.005	0.005
S2.1.1 Titanium alloys, pure titanium, Rm 400 N/mm ² S2.1.2 Titanium alloys, Alpha and Beta alloys, hardened, Rm 1050 N/mm ²	K	60	0.005	0.005	0.005	0.015	0.010	0.005
	M	45	0.005	0.005	0.005	0.015	0.010	0.005
	L	25	0.005	0.005	0.005	0.005	0.005	0.005
H1.1.1 Hardened steel, hardened and tempered, < 55 HRC H1.1.2 Hardened steel, hardened and tempered, < 60 HRC H1.1.3 Hardened steel, hardened and tempered, > 60 HRC	K	60	0.005	0.005	0.005	0.015	0.010	0.005
	M	45	0.005	0.005	0.005	0.015	0.010	0.005
	L	25	0.005	0.005	0.005	0.005	0.005	0.005
H2.1.1 Chilled cast iron, 400 HB H2.1.2 Chilled cast iron, hardened and tempered, < 55 HRC	K	60	0.005	0.005	0.005	0.015	0.010	0.005
	M	45	0.005	0.005	0.005	0.015	0.010	0.005
	L	25	0.005	0.005	0.005	0.005	0.005	0.005

Cutting data

Feed for cutting inserts with WIPER geometry: + ~ 21 %

K = short tools with La/Dmin. < 3.5 | M = medium length tools with La/Dmin. from 3.5 - 6.5 | L = long tools with La/Dmin. > 6.5



f by radius												ap _{max.} by radius					
0.15			0.2			0.25			> 0.25								
t _{max.}																	
< 1	1	2	< 1	1	2	< 1	1	2	< 1	1	2	0.05	0.1	0.15	0.2	0.25	> 0.25
f (mm/rev)												ap _{max.} (mm)					
0.050	0.040	0.025	0.065	0.050	0.035	0.085	0.065	0.045	0.100	0.075	0.050	0.075	0.125	0.150	0.200	0.250	0.275
0.050	0.040	0.025	0.065	0.050	0.035	0.085	0.065	0.045	0.100	0.075	0.050	0.060	0.100	0.120	0.160	0.200	0.220
0.025	0.020	0.015	0.035	0.030	0.020	0.045	0.035	0.025	0.055	0.040	0.030	0.045	0.070	0.085	0.115	0.145	0.155
0.050	0.040	0.025	0.065	0.050	0.035	0.085	0.065	0.045	0.100	0.075	0.050	0.075	0.125	0.150	0.200	0.250	0.275
0.050	0.040	0.025	0.065	0.050	0.035	0.085	0.065	0.045	0.100	0.075	0.050	0.060	0.100	0.120	0.160	0.200	0.220
0.025	0.020	0.015	0.035	0.030	0.020	0.045	0.035	0.025	0.055	0.040	0.030	0.045	0.070	0.085	0.115	0.145	0.155
0.050	0.040	0.025	0.065	0.050	0.035	0.085	0.065	0.045	0.100	0.075	0.050	0.075	0.125	0.150	0.200	0.250	0.275
0.050	0.040	0.025	0.065	0.050	0.035	0.085	0.065	0.045	0.100	0.075	0.050	0.060	0.100	0.120	0.160	0.200	0.220
0.025	0.020	0.015	0.035	0.030	0.020	0.045	0.035	0.025	0.055	0.040	0.030	0.045	0.070	0.085	0.115	0.145	0.155
0.035	0.030	0.020	0.050	0.040	0.025	0.060	0.045	0.030	0.075	0.055	0.040	0.075	0.125	0.150	0.200	0.250	0.275
0.035	0.030	0.020	0.050	0.040	0.025	0.060	0.045	0.030	0.075	0.055	0.040	0.060	0.100	0.120	0.160	0.200	0.220
0.020	0.015	0.010	0.025	0.020	0.015	0.035	0.025	0.020	0.040	0.030	0.020	0.045	0.070	0.085	0.115	0.145	0.155
0.035	0.030	0.020	0.050	0.040	0.025	0.060	0.045	0.030	0.075	0.055	0.040	0.075	0.125	0.150	0.200	0.250	0.275
0.035	0.030	0.020	0.050	0.040	0.025	0.060	0.045	0.030	0.075	0.055	0.040	0.060	0.100	0.120	0.160	0.200	0.220
0.020	0.015	0.010	0.025	0.020	0.015	0.035	0.025	0.020	0.040	0.030	0.020	0.045	0.070	0.085	0.115	0.145	0.155
0.060	0.045	0.030	0.085	0.065	0.045	0.105	0.080	0.055	0.125	0.095	0.065	0.075	0.125	0.150	0.200	0.250	0.275
0.060	0.045	0.030	0.085	0.065	0.045	0.105	0.080	0.055	0.125	0.095	0.065	0.060	0.100	0.120	0.160	0.200	0.220
0.035	0.025	0.020	0.045	0.035	0.025	0.055	0.045	0.030	0.070	0.050	0.035	0.045	0.070	0.085	0.115	0.145	0.155
0.075	0.055	0.040	0.100	0.075	0.050	0.125	0.095	0.065	0.150	0.115	0.075	0.075	0.125	0.150	0.200	0.250	0.275
0.075	0.055	0.040	0.100	0.075	0.050	0.125	0.095	0.065	0.150	0.115	0.075	0.060	0.100	0.120	0.160	0.200	0.220
0.040	0.030	0.020	0.055	0.040	0.030	0.070	0.050	0.035	0.080	0.060	0.040	0.045	0.070	0.085	0.115	0.145	0.155
0.075	0.055	0.040	0.100	0.075	0.050	0.125	0.095	0.065	0.150	0.115	0.075	0.075	0.125	0.150	0.200	0.250	0.275
0.075	0.055	0.040	0.100	0.075	0.050	0.125	0.095	0.065	0.150	0.115	0.075	0.060	0.100	0.120	0.160	0.200	0.220
0.040	0.030	0.020	0.055	0.040	0.030	0.070	0.050	0.035	0.080	0.060	0.040	0.045	0.070	0.085	0.115	0.145	0.155
0.075	0.055	0.040	0.100	0.075	0.050	0.125	0.095	0.065	0.150	0.115	0.075	0.075	0.125	0.150	0.200	0.250	0.275
0.075	0.055	0.040	0.100	0.075	0.050	0.125	0.095	0.065	0.150	0.115	0.075	0.060	0.100	0.120	0.160	0.200	0.220
0.040	0.030	0.020	0.055	0.040	0.030	0.070	0.050	0.035	0.080	0.060	0.040	0.045	0.070	0.085	0.115	0.145	0.155
0.075	0.055	0.040	0.100	0.075	0.050	0.125	0.095	0.065	0.150	0.115	0.075	0.075	0.125	0.150	0.200	0.250	0.275
0.075	0.055	0.040	0.100	0.075	0.050	0.125	0.095	0.065	0.150	0.115	0.075	0.060	0.100	0.120	0.160	0.200	0.220
0.040	0.030	0.020	0.055	0.040	0.030	0.070	0.050	0.035	0.080	0.060	0.040	0.045	0.070	0.085	0.115	0.145	0.155
0.020	0.015	0.010	0.025	0.020	0.015	0.035	0.025	0.015	0.040	0.030	0.020	0.075	0.125	0.150	0.200	0.250	0.275
0.020	0.015	0.010	0.025	0.020	0.015	0.035	0.025	0.015	0.040	0.030	0.020	0.060	0.100	0.120	0.160	0.200	0.220
0.010	0.010	0.005	0.015	0.010	0.010	0.020	0.015	0.010	0.020	0.015	0.010	0.045	0.070	0.085	0.115	0.145	0.155
0.020	0.015	0.010	0.025	0.020	0.015	0.035	0.025	0.015	0.040	0.030	0.020	0.075	0.125	0.150	0.200	0.250	0.275
0.020	0.015	0.010	0.025	0.020	0.015	0.035	0.025	0.015	0.040	0.030	0.020	0.060	0.100	0.120	0.160	0.200	0.220
0.010	0.010	0.005	0.015	0.010	0.010	0.020	0.015	0.010	0.020	0.015	0.010	0.045	0.070	0.085	0.115	0.145	0.155
0.020	0.015	0.010	0.025	0.020	0.015	0.035	0.025	0.015	0.040	0.030	0.020	0.075	0.125	0.150	0.200	0.250	0.275
0.020	0.015	0.010	0.025	0.020	0.015	0.035	0.025	0.015	0.040	0.030	0.020	0.060	0.100	0.120	0.160	0.200	0.220
0.010	0.010	0.005	0.015	0.010	0.010	0.020	0.015	0.010	0.020	0.015	0.010	0.045	0.070	0.085	0.115	0.145	0.155

Cutting data



Boring out forwards System 108



Machining group	Length	V _c (m/min)	f by radius			
			0.05		0.1	
			t _{max.}			
			< 2	≥ 2	< 2	≥ 2
f (mm/rev)						
P1.1.1 Unalloyed steel, annealed, 0.15 % C, Rm 420 N/mm ² , 125 HB P1.1.2 Unalloyed steel, heat-treated, 0.15 % C, Rm 420 N/mm ² , 125 HB P1.1.3 Unalloyed steel, annealed, 0.45 % C, Rm 640 N/mm ² , 190 HB P1.1.4 Unalloyed steel, heat-treated, 0.45 % C, Rm 640 N/mm ² , 190 HB P1.1.5 Unalloyed steel, heat-treated, 0.45 % C, Rm 850 N/mm ² , 250 HB P1.1.6 Unalloyed steel, annealed, 0.75 % C, Rm 915 N/mm ² , 270 HB P1.1.7 Unalloyed steel, heat-treated, 0.75 % C, Rm 1020 N/mm ² , 300 HB	K	110	0.020	0.010	0.040	0.020
	M	80	0.020	0.010	0.040	0.020
	L	50	0.010	0.005	0.020	0.010
P2.1.1 Low-alloy steel, annealed, Rm 610 N/mm ² , 180 HB P2.1.2 Low-alloy steel, heat-treated, Rm 930 N/mm ² , 275 HB P2.1.3 Low-alloy steel, heat-treated, Rm 1020 N/mm ² , 300 HB P2.1.4 Low-alloy steel, heat-treated, Rm 1190 N/mm ² , 350 HB	K	110	0.020	0.010	0.040	0.020
	M	80	0.020	0.010	0.040	0.020
	L	50	0.010	0.005	0.020	0.010
P3.1.1 High-alloy steel and tool steel, annealed, Rm 680 N/mm ² , 200 HB P3.1.2 High-alloy steel and tool steel, hardened and tempered, Rm 1100 N/mm ² , 325 HB	K	110	0.020	0.010	0.040	0.020
	M	80	0.020	0.010	0.040	0.020
	L	50	0.010	0.005	0.020	0.010
M1.1.1 Stainless steel, ferritic/martensitic, with machining additives M1.1.2 Stainless steel, ferritic/martensitic, annealed, Rm 680 N/mm ² , 200 HB M1.1.3 Stainless steel, ferritic/martensitic, heat-treated, Rm 810 N/mm ² , 240 HB	K	95	0.015	0.010	0.030	0.015
	M	75	0.015	0.010	0.030	0.015
	L	45	0.010	0.005	0.015	0.010
M2.1.1 Stainless steel, austenitic, quenched, 180 HB M2.2.1 Duplex steel, high-strength stainless steels	K	95	0.015	0.010	0.030	0.015
	M	75	0.015	0.010	0.030	0.015
	L	45	0.010	0.005	0.015	0.010
K1.1.1 Grey cast iron, pearlitic/ferritic, 180 HB K1.1.2 Grey cast iron, pearlitic/martensitic, 260 HB K1.2.1 Cast iron with spheroidal graphite, ferritic, 160 HB K1.2.2 Cast iron with spheroidal graphite, pearlitic, 250 HB K1.3.1 Malleable cast iron, ferritic, 130 HB K1.3.2 Malleable cast iron, pearlitic, 230 HB	K	110	0.025	0.015	0.050	0.025
	M	80	0.025	0.015	0.050	0.025
	L	50	0.015	0.005	0.030	0.015
K2.1.1 Vermicular graphite cast iron (GJV) K2.2.1 Austenitic-ferritic spheroidal graphite cast iron (ADI)						
N1.1.1 Wrought aluminium alloys, non-hardened, 60 HB N1.1.2 Wrought aluminium alloys, hardened, 100 HB	K	215	0.030	0.015	0.060	0.030
	M	160	0.030	0.015	0.060	0.030
	L	100	0.015	0.010	0.035	0.015
N2.1.1 Aluminium casting alloys, non-hardened, ≤ 12 % Si, 75 HB N2.1.2 Aluminium casting alloys, hardened, ≤ 12 % Si, 90 HB N2.1.3 Aluminium casting alloys, non-hardened, > 12 % Si, 130 HB	K	215	0.030	0.015	0.060	0.030
	M	160	0.030	0.015	0.060	0.030
	L	100	0.015	0.010	0.035	0.015
N3.1.1 Copper and copper alloys: Free-machining alloy, Pb > 1 % N3.1.2 Copper and copper alloys: CuZn, CuSnZn N3.1.3 Copper and copper alloys: CuSn, lead-free copper and copper electrolyte	K	215	0.030	0.015	0.060	0.030
	M	160	0.030	0.015	0.060	0.030
	L	100	0.015	0.010	0.035	0.015
N4.1.1 Non-metallic materials: Duroplastics, fibre-reinforced plastics N4.1.2 Non-metallic materials: Hard rubber, wood, etc. N4.1.3 Non-metallic materials: Graphite	K	215	0.030	0.015	0.060	0.030
	M	160	0.030	0.015	0.060	0.030
	L	100	0.015	0.010	0.035	0.015
S1.1.1 Heat-resistant alloys, Fe-based, annealed, 200 HB S1.1.2 Heat-resistant alloys, Fe-based, hardened, 280 HB S1.1.3 Heat-resistant alloys, Ni- or Co-based, annealed, 250 HB S1.1.4 Heat-resistant alloys, Ni- or Co-based, hardened, 350 HB S1.1.5 Heat-resistant alloys, Ni- or Co-based, cast, 320 HB	K	70	0.010	0.005	0.015	0.010
	M	55	0.010	0.005	0.015	0.010
	L	35	0.005	0.005	0.010	0.005
S2.1.1 Titanium alloys, pure titanium, Rm 400 N/mm ² S2.1.2 Titanium alloys, Alpha and Beta alloys, hardened, Rm 1050 N/mm ²	K	70	0.010	0.005	0.015	0.010
	M	55	0.010	0.005	0.015	0.010
	L	35	0.005	0.005	0.010	0.005
H1.1.1 Hardened steel, hardened and tempered, < 55 HRC H1.1.2 Hardened steel, hardened and tempered, < 60 HRC H1.1.3 Hardened steel, hardened and tempered, > 60 HRC	K	70	0.010	0.005	0.015	0.010
	M	55	0.010	0.005	0.015	0.010
	L	35	0.005	0.005	0.010	0.005
H2.1.1 Chilled cast iron, 400 HB H2.1.2 Chilled cast iron, hardened and tempered, < 55 HRC	K	70	0.010	0.005	0.015	0.010
	M	55	0.010	0.005	0.015	0.010
	L	35	0.005	0.005	0.010	0.005

Cutting data

Feed for cutting inserts with WIPER geometry: + ~ 25 %

K = short tools with La/Dmin. < 3.5 | M = medium length tools with La/Dmin. from 3.5 - 6.5 | L = long tools with La/Dmin. > 6.5



f by radius								ap _{max.} by radius					
0.15		0.2		0.25		> 0.25							
t _{max.}													
< 2	≥ 2	< 2	≥ 2	< 2	≥ 2	< 2	≥ 2	0.05	0.1	0.15	0.2	0.25	> 0.25
f (mm/rev)								ap _{max.} (mm)					
0.060	0.030	0.080	0.040	0.100	0.050	0.120	0.060	0.075	0.125	0.150	0.200	0.250	0.275
0.060	0.030	0.080	0.040	0.100	0.050	0.120	0.060	0.060	0.100	0.120	0.160	0.200	0.220
0.035	0.015	0.045	0.020	0.055	0.030	0.065	0.035	0.045	0.070	0.085	0.115	0.145	0.155
0.060	0.030	0.080	0.040	0.100	0.050	0.120	0.060	0.075	0.125	0.150	0.200	0.250	0.275
0.060	0.030	0.080	0.040	0.100	0.050	0.120	0.060	0.060	0.100	0.120	0.160	0.200	0.220
0.035	0.015	0.045	0.020	0.055	0.030	0.065	0.035	0.045	0.070	0.085	0.115	0.145	0.155
0.060	0.030	0.080	0.040	0.100	0.050	0.120	0.060	0.075	0.125	0.150	0.200	0.250	0.275
0.060	0.030	0.080	0.040	0.100	0.050	0.120	0.060	0.060	0.100	0.120	0.160	0.200	0.220
0.035	0.015	0.045	0.020	0.055	0.030	0.065	0.035	0.045	0.070	0.085	0.115	0.145	0.155
0.045	0.025	0.060	0.030	0.075	0.040	0.090	0.045	0.075	0.125	0.150	0.200	0.250	0.275
0.045	0.025	0.060	0.030	0.075	0.040	0.090	0.045	0.060	0.100	0.120	0.160	0.200	0.220
0.025	0.010	0.035	0.015	0.040	0.020	0.050	0.025	0.045	0.070	0.085	0.115	0.145	0.155
0.045	0.025	0.060	0.030	0.075	0.040	0.090	0.045	0.075	0.125	0.150	0.200	0.250	0.275
0.045	0.025	0.060	0.030	0.075	0.040	0.090	0.045	0.060	0.100	0.120	0.160	0.200	0.220
0.025	0.010	0.035	0.015	0.040	0.020	0.050	0.025	0.045	0.070	0.085	0.115	0.145	0.155
0.075	0.040	0.100	0.050	0.125	0.065	0.150	0.075	0.075	0.125	0.150	0.200	0.250	0.275
0.075	0.040	0.100	0.050	0.125	0.065	0.150	0.075	0.060	0.100	0.120	0.160	0.200	0.220
0.040	0.020	0.055	0.030	0.070	0.035	0.085	0.040	0.045	0.070	0.085	0.115	0.145	0.155
0.090	0.045	0.120	0.060	0.150	0.075	0.180	0.090	0.075	0.125	0.150	0.200	0.250	0.275
0.090	0.045	0.120	0.060	0.150	0.075	0.180	0.090	0.060	0.100	0.120	0.160	0.200	0.220
0.050	0.025	0.065	0.035	0.085	0.040	0.100	0.050	0.045	0.070	0.085	0.115	0.145	0.155
0.090	0.045	0.120	0.060	0.150	0.075	0.180	0.090	0.075	0.125	0.150	0.200	0.250	0.275
0.090	0.045	0.120	0.060	0.150	0.075	0.180	0.090	0.060	0.100	0.120	0.160	0.200	0.220
0.050	0.025	0.065	0.035	0.085	0.040	0.100	0.050	0.045	0.070	0.085	0.115	0.145	0.155
0.090	0.045	0.120	0.060	0.150	0.075	0.180	0.090	0.075	0.125	0.150	0.200	0.250	0.275
0.090	0.045	0.120	0.060	0.150	0.075	0.180	0.090	0.060	0.100	0.120	0.160	0.200	0.220
0.050	0.025	0.065	0.035	0.085	0.040	0.100	0.050	0.045	0.070	0.085	0.115	0.145	0.155
0.090	0.045	0.120	0.060	0.150	0.075	0.180	0.090	0.075	0.125	0.150	0.200	0.250	0.275
0.090	0.045	0.120	0.060	0.150	0.075	0.180	0.090	0.060	0.100	0.120	0.160	0.200	0.220
0.050	0.025	0.065	0.035	0.085	0.040	0.100	0.050	0.045	0.070	0.085	0.115	0.145	0.155
0.025	0.010	0.030	0.015	0.040	0.020	0.050	0.025	0.075	0.125	0.150	0.200	0.250	0.275
0.025	0.010	0.030	0.015	0.040	0.020	0.050	0.025	0.060	0.100	0.120	0.160	0.200	0.220
0.015	0.005	0.020	0.010	0.020	0.010	0.025	0.015	0.045	0.070	0.085	0.115	0.145	0.155
0.025	0.010	0.030	0.015	0.040	0.020	0.050	0.025	0.075	0.125	0.150	0.200	0.250	0.275
0.025	0.010	0.030	0.015	0.040	0.020	0.050	0.025	0.060	0.100	0.120	0.160	0.200	0.220
0.015	0.005	0.020	0.010	0.020	0.010	0.025	0.015	0.045	0.070	0.085	0.115	0.145	0.155
0.025	0.010	0.030	0.015	0.040	0.020	0.050	0.025	0.075	0.125	0.150	0.200	0.250	0.275
0.025	0.010	0.030	0.015	0.040	0.020	0.050	0.025	0.060	0.100	0.120	0.160	0.200	0.220
0.015	0.005	0.020	0.010	0.020	0.010	0.025	0.015	0.045	0.070	0.085	0.115	0.145	0.155
0.025	0.010	0.030	0.015	0.040	0.020	0.050	0.025	0.075	0.125	0.150	0.200	0.250	0.275
0.025	0.010	0.030	0.015	0.040	0.020	0.050	0.025	0.060	0.100	0.120	0.160	0.200	0.220
0.015	0.005	0.020	0.010	0.020	0.010	0.025	0.015	0.045	0.070	0.085	0.115	0.145	0.155

Cutting data



Boring out backwards System 104



Machining group	Length	v _c (m/min)	f (mm/rev) by radius						a _{pmax.} (mm) by radius					
			0.05	0.1	0.15	0.2	0.25	> 0.25	0.05	0.1	0.15	0.2	0.25	> 0.25
P1.1.1 Unalloyed steel, annealed, 0.15 % C, Rm 420 N/mm ² , 125 HB P1.1.2 Unalloyed steel, heat-treated, 0.15 % C, Rm 420 N/mm ² , 125 HB P1.1.3 Unalloyed steel, annealed, 0.45 % C, Rm 640 N/mm ² , 190 HB P1.1.4 Unalloyed steel, heat-treated, 0.45 % C, Rm 640 N/mm ² , 190 HB P1.1.5 Unalloyed steel, heat-treated, 0.45 % C, Rm 850 N/mm ² , 250 HB P1.1.6 Unalloyed steel, annealed, 0.75 % C, Rm 915 N/mm ² , 270 HB P1.1.7 Unalloyed steel, heat-treated, 0.75 % C, Rm 1020 N/mm ² , 300 HB	K	35	0.010	0.020	0.030	0.040	0.050	0.060	0.015	0.035	0.075	0.200	0.250	0.275
	M	25	0.010	0.020	0.030	0.040	0.050	0.060	0.010	0.025	0.060	0.160	0.200	0.220
	L	15	0.005	0.010	0.015	0.020	0.030	0.035	0.005	0.020	0.045	0.115	0.145	0.155
P2.1.1 Low-alloy steel, annealed, Rm 610 N/mm ² , 180 HB P2.1.2 Low-alloy steel, heat-treated, Rm 930 N/mm ² , 275 HB P2.1.3 Low-alloy steel, heat-treated, Rm 1020 N/mm ² , 300 HB P2.1.4 Low-alloy steel, heat-treated, Rm 1190 N/mm ² , 350 HB	K	35	0.010	0.020	0.030	0.040	0.050	0.060	0.015	0.035	0.075	0.200	0.250	0.275
	M	25	0.010	0.020	0.030	0.040	0.050	0.060	0.010	0.025	0.060	0.160	0.200	0.220
	L	15	0.005	0.010	0.015	0.020	0.030	0.035	0.005	0.020	0.045	0.115	0.145	0.155
P3.1.1 High-alloy steel and tool steel, annealed, Rm 680 N/mm ² , 200 HB P3.1.2 High-alloy steel and tool steel, hardened and tempered, Rm 1100 N/mm ² , 325 HB	K	35	0.010	0.020	0.030	0.040	0.050	0.060	0.015	0.035	0.075	0.200	0.250	0.275
	M	25	0.010	0.020	0.030	0.040	0.050	0.060	0.010	0.025	0.060	0.160	0.200	0.220
	L	15	0.005	0.010	0.015	0.020	0.030	0.035	0.005	0.020	0.045	0.115	0.145	0.155
M1.1.1 Stainless steel, ferritic/martensitic, with machining additives M1.1.2 Stainless steel, ferritic/martensitic, annealed, Rm 680 N/mm ² , 200 HB M1.1.3 Stainless steel, ferritic/martensitic, heat-treated, Rm 810 N/mm ² , 240 HB	K	30	0.010	0.015	0.025	0.030	0.040	0.045	0.015	0.035	0.075	0.200	0.250	0.275
	M	25	0.010	0.015	0.025	0.030	0.040	0.045	0.010	0.025	0.060	0.160	0.200	0.220
	L	15	0.005	0.010	0.010	0.015	0.020	0.025	0.005	0.020	0.045	0.115	0.145	0.155
M2.1.1 Stainless steel, austenitic, quenched, 180 HB M2.1.2 Duplex steel, high-strength stainless steels	K	30	0.010	0.015	0.025	0.030	0.040	0.045	0.015	0.035	0.075	0.200	0.250	0.275
	M	25	0.010	0.015	0.025	0.030	0.040	0.045	0.010	0.025	0.060	0.160	0.200	0.220
	L	15	0.005	0.010	0.010	0.015	0.020	0.025	0.005	0.020	0.045	0.115	0.145	0.155
K1.1.1 Grey cast iron, pearlitic/ferritic, 180 HB K1.1.2 Grey cast iron, pearlitic/martensitic, 260 HB K1.2.1 Cast iron with spheroidal graphite, ferritic, 160 HB K1.2.2 Cast iron with spheroidal graphite, pearlitic, 250 HB K1.3.1 Malleable cast iron, ferritic, 130 HB K1.3.2 Malleable cast iron, pearlitic, 230 HB	K	35	0.015	0.025	0.040	0.050	0.065	0.075	0.015	0.035	0.075	0.200	0.250	0.275
	M	25	0.015	0.025	0.040	0.050	0.065	0.075	0.010	0.025	0.060	0.160	0.200	0.220
	L	15	0.005	0.015	0.020	0.030	0.035	0.040	0.005	0.020	0.045	0.115	0.145	0.155
K2.1.1 Vermicular graphite cast iron (GJV) K2.2.1 Austenitic-ferritic spheroidal graphite cast iron (ADI)														
N1.1.1 Wrought aluminium alloys, non-hardened, 60 HB N1.1.2 Wrought aluminium alloys, hardened, 100 HB	K	70	0.015	0.030	0.045	0.060	0.075	0.090	0.015	0.035	0.075	0.200	0.250	0.275
	M	55	0.015	0.030	0.045	0.060	0.075	0.090	0.010	0.025	0.060	0.160	0.200	0.220
	L	35	0.010	0.015	0.025	0.035	0.040	0.050	0.005	0.020	0.045	0.115	0.145	0.155
N2.1.1 Aluminium casting alloys, non-hardened, ≤ 12 % Si, 75 HB N2.1.2 Aluminium casting alloys, hardened, ≤ 12 % Si, 90 HB N2.1.3 Aluminium casting alloys, non-hardened, > 12 % Si, 130 HB	K	70	0.015	0.030	0.045	0.060	0.075	0.090	0.015	0.035	0.075	0.200	0.250	0.275
	M	55	0.015	0.030	0.045	0.060	0.075	0.090	0.010	0.025	0.060	0.160	0.200	0.220
	L	35	0.010	0.015	0.025	0.035	0.040	0.050	0.005	0.020	0.045	0.115	0.145	0.155
N3.1.1 Copper and copper alloys: Free-machining alloy, Pb > 1 % N3.1.2 Copper and copper alloys: CuZn, CuSnZn N3.1.3 Copper and copper alloys: CuSn, lead-free copper and copper electrolyte	K	70	0.015	0.030	0.045	0.060	0.075	0.090	0.015	0.035	0.075	0.200	0.250	0.275
	M	55	0.015	0.030	0.045	0.060	0.075	0.090	0.010	0.025	0.060	0.160	0.200	0.220
	L	35	0.010	0.015	0.025	0.035	0.040	0.050	0.005	0.020	0.045	0.115	0.145	0.155
N4.1.1 Non-metallic materials: Duroplastics, fibre-reinforced plastics N4.1.2 Non-metallic materials: Hard rubber, wood, etc. N4.1.3 Non-metallic materials: Graphite	K	70	0.015	0.030	0.045	0.060	0.075	0.090	0.015	0.035	0.075	0.200	0.250	0.275
	M	55	0.015	0.030	0.045	0.060	0.075	0.090	0.010	0.025	0.060	0.160	0.200	0.220
	L	35	0.010	0.015	0.025	0.035	0.040	0.050	0.005	0.020	0.045	0.115	0.145	0.155
S1.1.1 Heat-resistant alloys, Fe-based, annealed, 200 HB S1.1.2 Heat-resistant alloys, Fe-based, hardened, 280 HB S1.1.3 Heat-resistant alloys, Ni- or Co-based, annealed, 250 HB S1.1.4 Heat-resistant alloys, Ni- or Co-based, hardened, 350 HB S1.1.5 Heat-resistant alloys, Ni- or Co-based, cast, 320 HB	K	25	0.005	0.010	0.010	0.015	0.020	0.025	0.015	0.035	0.075	0.200	0.250	0.275
	M	15	0.005	0.010	0.010	0.015	0.020	0.025	0.010	0.025	0.060	0.160	0.200	0.220
	L	10	0.005	0.005	0.005	0.010	0.010	0.015	0.005	0.020	0.045	0.115	0.145	0.155
S2.1.1 Titanium alloys, pure titanium, Rm 400 N/mm ² S2.1.2 Titanium alloys, Alpha and Beta alloys, hardened, Rm 1050 N/mm ²	K	25	0.005	0.010	0.010	0.015	0.020	0.025	0.015	0.035	0.075	0.200	0.250	0.275
	M	15	0.005	0.010	0.010	0.015	0.020	0.025	0.010	0.025	0.060	0.160	0.200	0.220
	L	10	0.005	0.005	0.005	0.010	0.010	0.015	0.005	0.020	0.045	0.115	0.145	0.155
H1.1.1 Hardened steel, hardened and tempered, < 55 HRC H1.1.2 Hardened steel, hardened and tempered, < 60 HRC H1.1.3 Hardened steel, hardened and tempered, > 60 HRC	K	25	0.005	0.010	0.010	0.015	0.020	0.025	0.015	0.035	0.075	0.200	0.250	0.275
	M	15	0.005	0.010	0.010	0.015	0.020	0.025	0.010	0.025	0.060	0.160	0.200	0.220
	L	10	0.005	0.005	0.005	0.010	0.010	0.015	0.005	0.020	0.045	0.115	0.145	0.155
H2.1.1 Chilled cast iron, 400 HB H2.1.2 Chilled cast iron, hardened and tempered, < 55 HRC	K	25	0.005	0.010	0.010	0.015	0.020	0.025	0.015	0.035	0.075	0.200	0.250	0.275
	M	15	0.005	0.010	0.010	0.015	0.020	0.025	0.010	0.025	0.060	0.160	0.200	0.220
	L	10	0.005	0.005	0.005	0.010	0.010	0.015	0.005	0.020	0.045	0.115	0.145	0.155

Cutting data

K = short tools with La/Dmin. < 3.5 | M = medium length tools with La/Dmin. from 3.5 - 6.5 | L = long tools with La/Dmin. > 6.5



Boring out backwards System 106



Machining group	Length	v _c (m/min)	f (mm/rev) by radius						a _{pmax.} (mm) by radius					
			0.05	0.1	0.15	0.2	0.25	> 0.25	0.05	0.1	0.15	0.2	0.25	> 0.25
P1.1.1 Unalloyed steel, annealed, 0.15 % C, Rm 420 N/mm ² , 125 HB P1.1.2 Unalloyed steel, heat-treated, 0.15 % C, Rm 420 N/mm ² , 125 HB P1.1.3 Unalloyed steel, annealed, 0.45 % C, Rm 640 N/mm ² , 190 HB P1.1.4 Unalloyed steel, heat-treated, 0.45 % C, Rm 640 N/mm ² , 190 HB P1.1.5 Unalloyed steel, heat-treated, 0.45 % C, Rm 850 N/mm ² , 250 HB P1.1.6 Unalloyed steel, annealed, 0.75 % C, Rm 915 N/mm ² , 270 HB P1.1.7 Unalloyed steel, heat-treated, 0.75 % C, Rm 1020 N/mm ² , 300 HB	K	70	0.010	0.020	0.030	0.040	0.050	0.060	0.015	0.035	0.075	0.200	0.250	0.275
	M	55	0.010	0.020	0.030	0.040	0.050	0.060	0.010	0.025	0.060	0.160	0.200	0.220
	L	35	0.005	0.010	0.015	0.020	0.030	0.035	0.005	0.020	0.045	0.115	0.145	0.155
P2.1.1 Low-alloy steel, annealed, Rm 610 N/mm ² , 180 HB P2.1.2 Low-alloy steel, heat-treated, Rm 930 N/mm ² , 275 HB P2.1.3 Low-alloy steel, heat-treated, Rm 1020 N/mm ² , 300 HB P2.1.4 Low-alloy steel, heat-treated, Rm 1190 N/mm ² , 350 HB	K	70	0.010	0.020	0.030	0.040	0.050	0.060	0.015	0.035	0.075	0.200	0.250	0.275
	M	55	0.010	0.020	0.030	0.040	0.050	0.060	0.010	0.025	0.060	0.160	0.200	0.220
	L	35	0.005	0.010	0.015	0.020	0.030	0.035	0.005	0.020	0.045	0.115	0.145	0.155
P3.1.1 High-alloy steel and tool steel, annealed, Rm 680 N/mm ² , 200 HB P3.1.2 High-alloy steel and tool steel, hardened and tempered, Rm 1100 N/mm ² , 325 HB	K	70	0.010	0.020	0.030	0.040	0.050	0.060	0.015	0.035	0.075	0.200	0.250	0.275
	M	55	0.010	0.020	0.030	0.040	0.050	0.060	0.010	0.025	0.060	0.160	0.200	0.220
	L	35	0.005	0.010	0.015	0.020	0.030	0.035	0.005	0.020	0.045	0.115	0.145	0.155
M1.1.1 Stainless steel, ferritic/martensitic, with machining additives M1.1.2 Stainless steel, ferritic/martensitic, annealed, Rm 680 N/mm ² , 200 HB M1.1.3 Stainless steel, ferritic/martensitic, heat-treated, Rm 810 N/mm ² , 240 HB	K	65	0.010	0.015	0.025	0.030	0.040	0.045	0.015	0.035	0.075	0.200	0.250	0.275
	M	45	0.010	0.015	0.025	0.030	0.040	0.045	0.010	0.025	0.060	0.160	0.200	0.220
	L	30	0.005	0.010	0.010	0.015	0.020	0.025	0.005	0.020	0.045	0.115	0.145	0.155
M2.1.1 Stainless steel, austenitic, quenched, 180 HB M2.1.2 Duplex steel, high-strength stainless steels	K	65	0.010	0.015	0.025	0.030	0.040	0.045	0.015	0.035	0.075	0.200	0.250	0.275
	M	45	0.010	0.015	0.025	0.030	0.040	0.045	0.010	0.025	0.060	0.160	0.200	0.220
	L	30	0.005	0.010	0.010	0.015	0.020	0.025	0.005	0.020	0.045	0.115	0.145	0.155
K1.1.1 Grey cast iron, pearlitic/ferritic, 180 HB K1.1.2 Grey cast iron, pearlitic/martensitic, 260 HB K1.2.1 Cast iron with spheroidal graphite, ferritic, 160 HB K1.2.2 Cast iron with spheroidal graphite, pearlitic, 250 HB K1.3.1 Malleable cast iron, ferritic, 130 HB K1.3.2 Malleable cast iron, pearlitic, 230 HB	K	70	0.015	0.025	0.040	0.050	0.065	0.075	0.015	0.035	0.075	0.200	0.250	0.275
	M	55	0.015	0.025	0.040	0.050	0.065	0.075	0.010	0.025	0.060	0.160	0.200	0.220
	L	35	0.005	0.015	0.020	0.030	0.035	0.040	0.005	0.020	0.045	0.115	0.145	0.155
K2.1.1 Vermicular graphite cast iron (GJV) K2.2.1 Austenitic-ferritic spheroidal graphite cast iron (ADI)														
N1.1.1 Wrought aluminium alloys, non-hardened, 60 HB N1.1.2 Wrought aluminium alloys, hardened, 100 HB	K	140	0.015	0.030	0.045	0.060	0.075	0.090	0.015	0.035	0.075	0.200	0.250	0.275
	M	105	0.015	0.030	0.045	0.060	0.075	0.090	0.010	0.025	0.060	0.160	0.200	0.220
	L	65	0.010	0.015	0.025	0.035	0.040	0.050	0.005	0.020	0.045	0.115	0.145	0.155
N2.1.1 Aluminium casting alloys, non-hardened, ≤ 12 % Si, 75 HB N2.1.2 Aluminium casting alloys, hardened, ≤ 12 % Si, 90 HB N2.1.3 Aluminium casting alloys, non-hardened, > 12 % Si, 130 HB	K	140	0.015	0.030	0.045	0.060	0.075	0.090	0.015	0.035	0.075	0.200	0.250	0.275
	M	105	0.015	0.030	0.045	0.060	0.075	0.090	0.010	0.025	0.060	0.160	0.200	0.220
	L	65	0.010	0.015	0.025	0.035	0.040	0.050	0.005	0.020	0.045	0.115	0.145	0.155
N3.1.1 Copper and copper alloys: Free-machining alloy, Pb > 1 % N3.1.2 Copper and copper alloys: CuZn, CuSnZn N3.1.3 Copper and copper alloys: CuSn, lead-free copper and copper electrolyte	K	140	0.015	0.030	0.045	0.060	0.075	0.090	0.015	0.035	0.075	0.200	0.250	0.275
	M	105	0.015	0.030	0.045	0.060	0.075	0.090	0.010	0.025	0.060	0.160	0.200	0.220
	L	65	0.010	0.015	0.025	0.035	0.040	0.050	0.005	0.020	0.045	0.115	0.145	0.155
N4.1.1 Non-metallic materials: Duroplastics, fibre-reinforced plastics N4.1.2 Non-metallic materials: Hard rubber, wood, etc. N4.1.3 Non-metallic materials: Graphite	K	140	0.015	0.030	0.045	0.060	0.075	0.090	0.015	0.035	0.075	0.200	0.250	0.275
	M	105	0.015	0.030	0.045	0.060	0.075	0.090	0.010	0.025	0.060	0.160	0.200	0.220
	L	65	0.010	0.015	0.025	0.035	0.040	0.050	0.005	0.020	0.045	0.115	0.145	0.155
S1.1.1 Heat-resistant alloys, Fe-based, annealed, 200 HB S1.1.2 Heat-resistant alloys, Fe-based, hardened, 280 HB S1.1.3 Heat-resistant alloys, Ni- or Co-based, annealed, 250 HB S1.1.4 Heat-resistant alloys, Ni- or Co-based, hardened, 350 HB S1.1.5 Heat-resistant alloys, Ni- or Co-based, cast, 320 HB	K	45	0.005	0.010	0.010	0.015	0.020	0.025	0.015	0.035	0.075	0.200	0.250	0.275
	M	35	0.005	0.010	0.010	0.015	0.020	0.025	0.010	0.025	0.060	0.160	0.200	0.220
	L	20	0.005	0.005	0.005	0.010	0.010	0.015	0.005	0.020	0.045	0.115	0.145	0.155
S2.1.1 Titanium alloys, pure titanium, Rm 400 N/mm ² S2.1.2 Titanium alloys, Alpha and Beta alloys, hardened, Rm 1050 N/mm ²	K	45	0.005	0.010	0.010	0.015	0.020	0.025	0.015	0.035	0.075	0.200	0.250	0.275
	M	35	0.005	0.010	0.010	0.015	0.020	0.025	0.010	0.025	0.060	0.160	0.200	0.220
	L	20	0.005	0.005	0.005	0.010	0.010	0.015	0.005	0.020	0.045	0.115	0.145	0.155
H1.1.1 Hardened steel, hardened and tempered, < 55 HRC H1.1.2 Hardened steel, hardened and tempered, < 60 HRC H1.1.3 Hardened steel, hardened and tempered, > 60 HRC	K	45	0.005	0.010	0.010	0.015	0.020	0.025	0.015	0.035	0.075	0.200	0.250	0.275
	M	35	0.005	0.010	0.010	0.015	0.020	0.025	0.010	0.025	0.060	0.160	0.200	0.220
	L	20	0.005	0.005	0.005	0.010	0.010	0.015	0.005	0.020	0.045	0.115	0.145	0.155
H2.1.1 Chilled cast iron, 400 HB H2.1.2 Chilled cast iron, hardened and tempered, < 55 HRC	K	45	0.005	0.010	0.010	0.015	0.020	0.025	0.015	0.035	0.075	0.200	0.250	0.275
	M	35	0.005	0.010	0.010	0.015	0.020	0.025	0.010	0.025	0.060	0.160	0.200	0.220
	L	20	0.005	0.005	0.005	0.010	0.010	0.015	0.005	0.020	0.045	0.115	0.145	0.155

Cutting data

K = short tools with La/Dmin. < 3.5 | M = medium length tools with La/Dmin. from 3.5 - 6.5 | L = long tools with La/Dmin. > 6.5



Boring out backwards System 108



Machining group	Length	v _c (m/min)	f (mm/rev) by radius						a _{pmax.} (mm) by radius					
			0.05	0.1	0.15	0.2	0.25	> 0.25	0.05	0.1	0.15	0.2	0.25	> 0.25
P1.1.1 Unalloyed steel, annealed, 0.15 % C, Rm 420 N/mm ² , 125 HB P1.1.2 Unalloyed steel, heat-treated, 0.15 % C, Rm 420 N/mm ² , 125 HB P1.1.3 Unalloyed steel, annealed, 0.45 % C, Rm 640 N/mm ² , 190 HB P1.1.4 Unalloyed steel, heat-treated, 0.45 % C, Rm 640 N/mm ² , 190 HB P1.1.5 Unalloyed steel, heat-treated, 0.45 % C, Rm 850 N/mm ² , 250 HB P1.1.6 Unalloyed steel, annealed, 0.75 % C, Rm 915 N/mm ² , 270 HB P1.1.7 Unalloyed steel, heat-treated, 0.75 % C, Rm 1020 N/mm ² , 300 HB	K	70	0.010	0.020	0.030	0.040	0.050	0.060	0.015	0.035	0.075	0.200	0.250	0.275
	M	55	0.010	0.020	0.030	0.040	0.050	0.060	0.010	0.025	0.060	0.160	0.200	0.220
	L	35	0.005	0.010	0.015	0.020	0.030	0.035	0.005	0.020	0.045	0.115	0.145	0.155
P2.1.1 Low-alloy steel, annealed, Rm 610 N/mm ² , 180 HB P2.1.2 Low-alloy steel, heat-treated, Rm 930 N/mm ² , 275 HB P2.1.3 Low-alloy steel, heat-treated, Rm 1020 N/mm ² , 300 HB P2.1.4 Low-alloy steel, heat-treated, Rm 1190 N/mm ² , 350 HB	K	70	0.010	0.020	0.030	0.040	0.050	0.060	0.015	0.035	0.075	0.200	0.250	0.275
	M	55	0.010	0.020	0.030	0.040	0.050	0.060	0.010	0.025	0.060	0.160	0.200	0.220
	L	35	0.005	0.010	0.015	0.020	0.030	0.035	0.005	0.020	0.045	0.115	0.145	0.155
P3.1.1 High-alloy steel and tool steel, annealed, Rm 680 N/mm ² , 200 HB P3.1.2 High-alloy steel and tool steel, hardened and tempered, Rm 1100 N/mm ² , 325 HB	K	70	0.010	0.020	0.030	0.040	0.050	0.060	0.015	0.035	0.075	0.200	0.250	0.275
	M	55	0.010	0.020	0.030	0.040	0.050	0.060	0.010	0.025	0.060	0.160	0.200	0.220
	L	35	0.005	0.010	0.015	0.020	0.030	0.035	0.005	0.020	0.045	0.115	0.145	0.155
M1.1.1 Stainless steel, ferritic/martensitic, with machining additives M1.1.2 Stainless steel, ferritic/martensitic, annealed, Rm 680 N/mm ² , 200 HB M1.1.3 Stainless steel, ferritic/martensitic, heat-treated, Rm 810 N/mm ² , 240 HB	K	65	0.010	0.015	0.025	0.030	0.040	0.045	0.015	0.035	0.075	0.200	0.250	0.275
	M	45	0.010	0.015	0.025	0.030	0.040	0.045	0.010	0.025	0.060	0.160	0.200	0.220
	L	30	0.005	0.010	0.010	0.015	0.020	0.025	0.005	0.020	0.045	0.115	0.145	0.155
M2.1.1 Stainless steel, austenitic, quenched, 180 HB M2.2.1 Duplex steel, high-strength stainless steels	K	65	0.010	0.015	0.025	0.030	0.040	0.045	0.015	0.035	0.075	0.200	0.250	0.275
	M	45	0.010	0.015	0.025	0.030	0.040	0.045	0.010	0.025	0.060	0.160	0.200	0.220
	L	30	0.005	0.010	0.010	0.015	0.020	0.025	0.005	0.020	0.045	0.115	0.145	0.155
K1.1.1 Grey cast iron, pearlitic/ferritic, 180 HB K1.1.2 Grey cast iron, pearlitic/martensitic, 260 HB K1.2.1 Cast iron with spheroidal graphite, ferritic, 160 HB K1.2.2 Cast iron with spheroidal graphite, pearlitic, 250 HB K1.3.1 Malleable cast iron, ferritic, 130 HB K1.3.2 Malleable cast iron, pearlitic, 230 HB	K	70	0.015	0.025	0.040	0.050	0.065	0.075	0.015	0.035	0.075	0.200	0.250	0.275
	M	55	0.015	0.025	0.040	0.050	0.065	0.075	0.010	0.025	0.060	0.160	0.200	0.220
	L	35	0.005	0.015	0.020	0.030	0.035	0.040	0.005	0.020	0.045	0.115	0.145	0.155
K2.1.1 Vermicular graphite cast iron (GJV) K2.2.1 Austenitic-ferritic spheroidal graphite cast iron (ADI)														
N1.1.1 Wrought aluminium alloys, non-hardened, 60 HB N1.1.2 Wrought aluminium alloys, hardened, 100 HB	K	140	0.015	0.030	0.045	0.060	0.075	0.090	0.015	0.035	0.075	0.200	0.250	0.275
	M	105	0.015	0.030	0.045	0.060	0.075	0.090	0.010	0.025	0.060	0.160	0.200	0.220
	L	65	0.010	0.015	0.025	0.035	0.040	0.050	0.005	0.020	0.045	0.115	0.145	0.155
N2.1.1 Aluminium casting alloys, non-hardened, ≤ 12 % Si, 75 HB N2.1.2 Aluminium casting alloys, hardened, ≤ 12 % Si, 90 HB N2.1.3 Aluminium casting alloys, non-hardened, > 12 % Si, 130 HB	K	140	0.015	0.030	0.045	0.060	0.075	0.090	0.015	0.035	0.075	0.200	0.250	0.275
	M	105	0.015	0.030	0.045	0.060	0.075	0.090	0.010	0.025	0.060	0.160	0.200	0.220
	L	65	0.010	0.015	0.025	0.035	0.040	0.050	0.005	0.020	0.045	0.115	0.145	0.155
N3.1.1 Copper and copper alloys: Free-machining alloy, Pb > 1 % N3.1.2 Copper and copper alloys: CuZn, CuSnZn N3.1.3 Copper and copper alloys: CuSn, lead-free copper and copper electrolyte	K	140	0.015	0.030	0.045	0.060	0.075	0.090	0.015	0.035	0.075	0.200	0.250	0.275
	M	105	0.015	0.030	0.045	0.060	0.075	0.090	0.010	0.025	0.060	0.160	0.200	0.220
	L	65	0.010	0.015	0.025	0.035	0.040	0.050	0.005	0.020	0.045	0.115	0.145	0.155
N4.1.1 Non-metallic materials: Duroplastics, fibre-reinforced plastics N4.1.2 Non-metallic materials: Hard rubber, wood, etc. N4.1.3 Non-metallic materials: Graphite	K	140	0.015	0.030	0.045	0.060	0.075	0.090	0.015	0.035	0.075	0.200	0.250	0.275
	M	105	0.015	0.030	0.045	0.060	0.075	0.090	0.010	0.025	0.060	0.160	0.200	0.220
	L	65	0.010	0.015	0.025	0.035	0.040	0.050	0.005	0.020	0.045	0.115	0.145	0.155
S1.1.1 Heat-resistant alloys, Fe-based, annealed, 200 HB S1.1.2 Heat-resistant alloys, Fe-based, hardened, 280 HB S1.1.3 Heat-resistant alloys, Ni- or Co-based, annealed, 250 HB S1.1.4 Heat-resistant alloys, Ni- or Co-based, hardened, 350 HB S1.1.5 Heat-resistant alloys, Ni- or Co-based, cast, 320 HB	K	50	0.005	0.010	0.010	0.015	0.020	0.025	0.015	0.035	0.075	0.200	0.250	0.275
	M	40	0.005	0.010	0.010	0.015	0.020	0.025	0.010	0.025	0.060	0.160	0.200	0.220
	L	25	0.005	0.005	0.005	0.010	0.010	0.015	0.005	0.020	0.045	0.115	0.145	0.155
S2.1.1 Titanium alloys, pure titanium, Rm 400 N/mm ² S2.1.2 Titanium alloys, Alpha and Beta alloys, hardened, Rm 1050 N/mm ²	K	45	0.005	0.010	0.010	0.015	0.020	0.025	0.015	0.035	0.075	0.200	0.250	0.275
	M	35	0.005	0.010	0.010	0.015	0.020	0.025	0.010	0.025	0.060	0.160	0.200	0.220
	L	20	0.005	0.005	0.005	0.010	0.010	0.015	0.005	0.020	0.045	0.115	0.145	0.155
H1.1.1 Hardened steel, hardened and tempered, < 55 HRC H1.1.2 Hardened steel, hardened and tempered, < 60 HRC H1.1.3 Hardened steel, hardened and tempered, > 60 HRC	K	45	0.005	0.010	0.010	0.015	0.020	0.025	0.015	0.035	0.075	0.200	0.250	0.275
	M	35	0.005	0.010	0.010	0.015	0.020	0.025	0.010	0.025	0.060	0.160	0.200	0.220
	L	20	0.005	0.005	0.005	0.010	0.010	0.015	0.005	0.020	0.045	0.115	0.145	0.155
H2.1.1 Chilled cast iron, 400 HB H2.1.2 Chilled cast iron, hardened and tempered, < 55 HRC	K	45	0.005	0.010	0.010	0.015	0.020	0.025	0.015	0.035	0.075	0.200	0.250	0.275
	M	35	0.005	0.010	0.010	0.015	0.020	0.025	0.010	0.025	0.060	0.160	0.200	0.220
	L	20	0.005	0.005	0.005	0.010	0.010	0.015	0.005	0.020	0.045	0.115	0.145	0.155

Cutting data

K = short tools with La/Dmin. < 3.5 | M = medium length tools with La/Dmin. from 3.5 - 6.5 | L = long tools with La/Dmin. > 6.5



Boring out Chamfering System 104



Machining group	Length	v _c (m/min)	f (mm/rev) by radius						a _{pmax.} (mm) by radius					
			0.05	0.1	0.15	0.2	0.25	> 0.25	0.05	0.1	0.15	0.2	0.25	> 0.25
P1.1.1 Unalloyed steel, annealed, 0.15 % C, Rm 420 N/mm ² , 125 HB P1.1.2 Unalloyed steel, heat-treated, 0.15 % C, Rm 420 N/mm ² , 125 HB P1.1.3 Unalloyed steel, annealed, 0.45 % C, Rm 640 N/mm ² , 190 HB P1.1.4 Unalloyed steel, heat-treated, 0.45 % C, Rm 640 N/mm ² , 190 HB P1.1.5 Unalloyed steel, heat-treated, 0.45 % C, Rm 850 N/mm ² , 250 HB P1.1.6 Unalloyed steel, annealed, 0.75 % C, Rm 915 N/mm ² , 270 HB P1.1.7 Unalloyed steel, heat-treated, 0.75 % C, Rm 1020 N/mm ² , 300 HB	K	40	0.010	0.015	0.025	0.035	0.045	0.050	0.075	0.125	0.150	0.200	0.250	0.275
	M	30	0.010	0.015	0.025	0.035	0.045	0.050	0.060	0.100	0.120	0.160	0.200	0.220
	L	20	0.005	0.010	0.015	0.020	0.025	0.030	0.045	0.070	0.085	0.115	0.145	0.155
P2.1.1 Low-alloy steel, annealed, Rm 610 N/mm ² , 180 HB P2.1.2 Low-alloy steel, heat-treated, Rm 930 N/mm ² , 275 HB P2.1.3 Low-alloy steel, heat-treated, Rm 1020 N/mm ² , 300 HB P2.1.4 Low-alloy steel, heat-treated, Rm 1190 N/mm ² , 350 HB	K	40	0.010	0.015	0.025	0.035	0.045	0.050	0.075	0.125	0.150	0.200	0.250	0.275
	M	30	0.010	0.015	0.025	0.035	0.045	0.050	0.060	0.100	0.120	0.160	0.200	0.220
	L	20	0.005	0.010	0.015	0.020	0.025	0.030	0.045	0.070	0.085	0.115	0.145	0.155
P3.1.1 High-alloy steel and tool steel, annealed, Rm 680 N/mm ² , 200 HB P3.1.2 High-alloy steel and tool steel, hardened and tempered, Rm 1100 N/mm ² , 325 HB	K	40	0.010	0.015	0.025	0.035	0.045	0.050	0.075	0.125	0.150	0.200	0.250	0.275
	M	30	0.010	0.015	0.025	0.035	0.045	0.050	0.060	0.100	0.120	0.160	0.200	0.220
	L	20	0.005	0.010	0.015	0.020	0.025	0.030	0.045	0.070	0.085	0.115	0.145	0.155
M1.1.1 Stainless steel, ferritic/martensitic, with machining additives M1.1.2 Stainless steel, ferritic/martensitic, annealed, Rm 680 N/mm ² , 200 HB M1.1.3 Stainless steel, ferritic/martensitic, heat-treated, Rm 810 N/mm ² , 240 HB	K	35	0.005	0.015	0.020	0.025	0.030	0.040	0.075	0.125	0.150	0.200	0.250	0.275
	M	25	0.005	0.015	0.020	0.025	0.030	0.040	0.060	0.100	0.120	0.160	0.200	0.220
	L	15	0.005	0.005	0.010	0.015	0.020	0.020	0.045	0.070	0.085	0.115	0.145	0.155
M2.1.1 Stainless steel, austenitic, quenched, 180 HB M2.1.2 Duplex steel, high-strength stainless steels	K	35	0.005	0.015	0.020	0.025	0.030	0.040	0.075	0.125	0.150	0.200	0.250	0.275
	M	25	0.005	0.015	0.020	0.025	0.030	0.040	0.060	0.100	0.120	0.160	0.200	0.220
	L	15	0.005	0.005	0.010	0.015	0.020	0.020	0.045	0.070	0.085	0.115	0.145	0.155
K1.1.1 Grey cast iron, pearlitic/ferritic, 180 HB K1.1.2 Grey cast iron, pearlitic/martensitic, 260 HB K1.2.1 Cast iron with spheroidal graphite, ferritic, 160 HB K1.2.2 Cast iron with spheroidal graphite, pearlitic, 250 HB K1.3.1 Malleable cast iron, ferritic, 130 HB K1.3.2 Malleable cast iron, pearlitic, 230 HB	K	40	0.010	0.020	0.030	0.045	0.055	0.065	0.075	0.125	0.150	0.200	0.250	0.275
	M	30	0.010	0.020	0.030	0.045	0.055	0.065	0.060	0.100	0.120	0.160	0.200	0.220
	L	20	0.005	0.010	0.020	0.025	0.030	0.035	0.045	0.070	0.085	0.115	0.145	0.155
K2.1.1 Vermicular graphite cast iron (GJV) K2.2.1 Austenitic-ferritic spheroidal graphite cast iron (ADI)														
N1.1.1 Wrought aluminium alloys, non-hardened, 60 HB N1.1.2 Wrought aluminium alloys, hardened, 100 HB	K	80	0.015	0.025	0.040	0.050	0.065	0.075	0.075	0.125	0.150	0.200	0.250	0.275
	M	60	0.015	0.025	0.040	0.050	0.065	0.075	0.060	0.100	0.120	0.160	0.200	0.220
	L	40	0.005	0.015	0.020	0.030	0.035	0.040	0.045	0.070	0.085	0.115	0.145	0.155
N2.1.1 Aluminium casting alloys, non-hardened, ≤ 12 % Si, 75 HB N2.1.2 Aluminium casting alloys, hardened, ≤ 12 % Si, 90 HB N2.1.3 Aluminium casting alloys, non-hardened, > 12 % Si, 130 HB	K	80	0.015	0.025	0.040	0.050	0.065	0.075	0.075	0.125	0.150	0.200	0.250	0.275
	M	60	0.015	0.025	0.040	0.050	0.065	0.075	0.060	0.100	0.120	0.160	0.200	0.220
	L	40	0.005	0.015	0.020	0.030	0.035	0.040	0.045	0.070	0.085	0.115	0.145	0.155
N3.1.1 Copper and copper alloys: Free-machining alloy, Pb > 1 % N3.1.2 Copper and copper alloys: CuZn, CuSnZn N3.1.3 Copper and copper alloys: CuSn, lead-free copper and copper electrolyte	K	80	0.015	0.025	0.040	0.050	0.065	0.075	0.075	0.125	0.150	0.200	0.250	0.275
	M	60	0.015	0.025	0.040	0.050	0.065	0.075	0.060	0.100	0.120	0.160	0.200	0.220
	L	40	0.005	0.015	0.020	0.030	0.035	0.040	0.045	0.070	0.085	0.115	0.145	0.155
N4.1.1 Non-metallic materials: Duroplastics, fibre-reinforced plastics N4.1.2 Non-metallic materials: Hard rubber, wood, etc. N4.1.3 Non-metallic materials: Graphite	K	80	0.015	0.025	0.040	0.050	0.065	0.075	0.075	0.125	0.150	0.200	0.250	0.275
	M	60	0.015	0.025	0.040	0.050	0.065	0.075	0.060	0.100	0.120	0.160	0.200	0.220
	L	40	0.005	0.015	0.020	0.030	0.035	0.040	0.045	0.070	0.085	0.115	0.145	0.155
S1.1.1 Heat-resistant alloys, Fe-based, annealed, 200 HB S1.1.2 Heat-resistant alloys, Fe-based, hardened, 280 HB S1.1.3 Heat-resistant alloys, Ni- or Co-based, annealed, 250 HB S1.1.4 Heat-resistant alloys, Ni- or Co-based, hardened, 350 HB S1.1.5 Heat-resistant alloys, Ni- or Co-based, cast, 320 HB	K	25	0.005	0.005	0.010	0.015	0.015	0.020	0.075	0.125	0.150	0.200	0.250	0.275
	M	20	0.005	0.005	0.010	0.015	0.015	0.020	0.060	0.100	0.120	0.160	0.200	0.220
	L	10	0.005	0.005	0.005	0.005	0.010	0.010	0.045	0.070	0.085	0.115	0.145	0.155
S2.1.1 Titanium alloys, pure titanium, Rm 400 N/mm ² S2.1.2 Titanium alloys, Alpha and Beta alloys, hardened, Rm 1050 N/mm ²	K	25	0.005	0.005	0.010	0.015	0.015	0.020	0.075	0.125	0.150	0.200	0.250	0.275
	M	20	0.005	0.005	0.010	0.015	0.015	0.020	0.060	0.100	0.120	0.160	0.200	0.220
	L	10	0.005	0.005	0.005	0.005	0.010	0.010	0.045	0.070	0.085	0.115	0.145	0.155
H1.1.1 Hardened steel, hardened and tempered, < 55 HRC H1.1.2 Hardened steel, hardened and tempered, < 60 HRC H1.1.3 Hardened steel, hardened and tempered, > 60 HRC	K	25	0.005	0.005	0.010	0.015	0.015	0.020	0.075	0.125	0.150	0.200	0.250	0.275
	M	20	0.005	0.005	0.010	0.015	0.015	0.020	0.060	0.100	0.120	0.160	0.200	0.220
	L	10	0.005	0.005	0.005	0.005	0.010	0.010	0.045	0.070	0.085	0.115	0.145	0.155
H2.1.1 Chilled cast iron, 400 HB H2.1.2 Chilled cast iron, hardened and tempered, < 55 HRC	K	25	0.005	0.005	0.010	0.015	0.015	0.020	0.075	0.125	0.150	0.200	0.250	0.275
	M	20	0.005	0.005	0.010	0.015	0.015	0.020	0.060	0.100	0.120	0.160	0.200	0.220
	L	10	0.005	0.005	0.005	0.005	0.010	0.010	0.045	0.070	0.085	0.115	0.145	0.155

Cutting data

K = short tools with La/Dmin. < 3.5 | M = medium length tools with La/Dmin. from 3.5 - 6.5 | L = long tools with La/Dmin. > 6.5



Boring out Chamfering System 106



Machining group	Length	v _c (m/min)	f (mm/rev) by radius						a _{pmax.} (mm) by radius					
			0.05	0.1	0.15	0.2	0.25	> 0.25	0.05	0.1	0.15	0.2	0.25	> 0.25
P1.1.1 Unalloyed steel, annealed, 0.15 % C, Rm 420 N/mm ² , 125 HB P1.1.2 Unalloyed steel, heat-treated, 0.15 % C, Rm 420 N/mm ² , 125 HB P1.1.3 Unalloyed steel, annealed, 0.45 % C, Rm 640 N/mm ² , 190 HB P1.1.4 Unalloyed steel, heat-treated, 0.45 % C, Rm 640 N/mm ² , 190 HB P1.1.5 Unalloyed steel, heat-treated, 0.45 % C, Rm 850 N/mm ² , 250 HB P1.1.6 Unalloyed steel, annealed, 0.75 % C, Rm 915 N/mm ² , 270 HB P1.1.7 Unalloyed steel, heat-treated, 0.75 % C, Rm 1020 N/mm ² , 300 HB	K	80	0.015	0.035	0.050	0.065	0.085	0.100	0.075	0.125	0.150	0.200	0.250	0.275
	M	60	0.015	0.035	0.050	0.065	0.085	0.100	0.060	0.100	0.120	0.160	0.200	0.220
	L	40	0.010	0.020	0.025	0.035	0.045	0.055	0.045	0.070	0.085	0.115	0.145	0.155
P2.1.1 Low-alloy steel, annealed, Rm 610 N/mm ² , 180 HB P2.1.2 Low-alloy steel, heat-treated, Rm 930 N/mm ² , 275 HB P2.1.3 Low-alloy steel, heat-treated, Rm 1020 N/mm ² , 300 HB P2.1.4 Low-alloy steel, heat-treated, Rm 1190 N/mm ² , 350 HB	K	80	0.015	0.035	0.050	0.065	0.085	0.100	0.075	0.125	0.150	0.200	0.250	0.275
	M	60	0.015	0.035	0.050	0.065	0.085	0.100	0.060	0.100	0.120	0.160	0.200	0.220
	L	40	0.010	0.020	0.025	0.035	0.045	0.055	0.045	0.070	0.085	0.115	0.145	0.155
P3.1.1 High-alloy steel and tool steel, annealed, Rm 680 N/mm ² , 200 HB P3.1.2 High-alloy steel and tool steel, hardened and tempered, Rm 1100 N/mm ² , 325 HB	K	80	0.015	0.035	0.050	0.065	0.085	0.100	0.075	0.125	0.150	0.200	0.250	0.275
	M	60	0.015	0.035	0.050	0.065	0.085	0.100	0.060	0.100	0.120	0.160	0.200	0.220
	L	40	0.010	0.020	0.025	0.035	0.045	0.055	0.045	0.070	0.085	0.115	0.145	0.155
M1.1.1 Stainless steel, ferritic/martensitic, with machining additives M1.1.2 Stainless steel, ferritic/martensitic, annealed, Rm 680 N/mm ² , 200 HB M1.1.3 Stainless steel, ferritic/martensitic, heat-treated, Rm 810 N/mm ² , 240 HB	K	70	0.010	0.025	0.035	0.050	0.060	0.075	0.075	0.125	0.150	0.200	0.250	0.275
	M	55	0.010	0.025	0.035	0.050	0.060	0.075	0.060	0.100	0.120	0.160	0.200	0.220
	L	35	0.005	0.015	0.020	0.025	0.035	0.040	0.045	0.070	0.085	0.115	0.145	0.155
M2.1.1 Stainless steel, austenitic, quenched, 180 HB M2.1.2 Duplex steel, high-strength stainless steels	K	70	0.010	0.025	0.035	0.050	0.060	0.075	0.075	0.125	0.150	0.200	0.250	0.275
	M	55	0.010	0.025	0.035	0.050	0.060	0.075	0.060	0.100	0.120	0.160	0.200	0.220
	L	35	0.005	0.015	0.020	0.025	0.035	0.040	0.045	0.070	0.085	0.115	0.145	0.155
K1.1.1 Grey cast iron, pearlitic/ferritic, 180 HB K1.1.2 Grey cast iron, pearlitic/martensitic, 260 HB K1.2.1 Cast iron with spheroidal graphite, ferritic, 160 HB K1.2.2 Cast iron with spheroidal graphite, pearlitic, 250 HB K1.3.1 Malleable cast iron, ferritic, 130 HB K1.3.2 Malleable cast iron, pearlitic, 230 HB	K	80	0.020	0.040	0.060	0.085	0.105	0.125	0.075	0.125	0.150	0.200	0.250	0.275
	M	60	0.020	0.040	0.060	0.085	0.105	0.125	0.060	0.100	0.120	0.160	0.200	0.220
	L	40	0.010	0.025	0.035	0.045	0.055	0.070	0.045	0.070	0.085	0.115	0.145	0.155
K2.1.1 Vermicular graphite cast iron (GJV) K2.2.1 Austenitic-ferritic spheroidal graphite cast iron (ADI)														
N1.1.1 Wrought aluminium alloys, non-hardened, 60 HB N1.1.2 Wrought aluminium alloys, hardened, 100 HB	K	160	0.025	0.050	0.075	0.100	0.125	0.150	0.075	0.125	0.150	0.200	0.250	0.275
	M	120	0.025	0.050	0.075	0.100	0.125	0.150	0.060	0.100	0.120	0.160	0.200	0.220
	L	75	0.015	0.025	0.040	0.055	0.070	0.080	0.045	0.070	0.085	0.115	0.145	0.155
N2.1.1 Aluminium casting alloys, non-hardened, ≤ 12 % Si, 75 HB N2.1.2 Aluminium casting alloys, hardened, ≤ 12 % Si, 90 HB N2.1.3 Aluminium casting alloys, non-hardened, > 12 % Si, 130 HB	K	160	0.025	0.050	0.075	0.100	0.125	0.150	0.075	0.125	0.150	0.200	0.250	0.275
	M	120	0.025	0.050	0.075	0.100	0.125	0.150	0.060	0.100	0.120	0.160	0.200	0.220
	L	75	0.015	0.025	0.040	0.055	0.070	0.080	0.045	0.070	0.085	0.115	0.145	0.155
N3.1.1 Copper and copper alloys: Free-machining alloy, Pb > 1 % N3.1.2 Copper and copper alloys: CuZn, CuSnZn N3.1.3 Copper and copper alloys: CuSn, lead-free copper and copper electrolyte	K	160	0.025	0.050	0.075	0.100	0.125	0.150	0.075	0.125	0.150	0.200	0.250	0.275
	M	120	0.025	0.050	0.075	0.100	0.125	0.150	0.060	0.100	0.120	0.160	0.200	0.220
	L	75	0.015	0.025	0.040	0.055	0.070	0.080	0.045	0.070	0.085	0.115	0.145	0.155
N4.1.1 Non-metallic materials: Duroplastics, fibre-reinforced plastics N4.1.2 Non-metallic materials: Hard rubber, wood, etc. N4.1.3 Non-metallic materials: Graphite	K	160	0.025	0.050	0.075	0.100	0.125	0.150	0.075	0.125	0.150	0.200	0.250	0.275
	M	120	0.025	0.050	0.075	0.100	0.125	0.150	0.060	0.100	0.120	0.160	0.200	0.220
	L	75	0.015	0.025	0.040	0.055	0.070	0.080	0.045	0.070	0.085	0.115	0.145	0.155
S1.1.1 Heat-resistant alloys, Fe-based, annealed, 200 HB S1.1.2 Heat-resistant alloys, Fe-based, hardened, 280 HB S1.1.3 Heat-resistant alloys, Ni- or Co-based, annealed, 250 HB S1.1.4 Heat-resistant alloys, Ni- or Co-based, hardened, 350 HB S1.1.5 Heat-resistant alloys, Ni- or Co-based, cast, 320 HB	K	50	0.005	0.015	0.020	0.025	0.035	0.040	0.075	0.125	0.150	0.200	0.250	0.275
	M	40	0.005	0.015	0.020	0.025	0.035	0.040	0.060	0.100	0.120	0.160	0.200	0.220
	L	25	0.005	0.005	0.010	0.015	0.020	0.020	0.045	0.070	0.085	0.115	0.145	0.155
S2.1.1 Titanium alloys, pure titanium, Rm 400 N/mm ² S2.1.2 Titanium alloys, Alpha and Beta alloys, hardened, Rm 1050 N/mm ²	K	50	0.005	0.015	0.020	0.025	0.035	0.040	0.075	0.125	0.150	0.200	0.250	0.275
	M	40	0.005	0.015	0.020	0.025	0.035	0.040	0.060	0.100	0.120	0.160	0.200	0.220
	L	25	0.005	0.005	0.010	0.015	0.020	0.020	0.045	0.070	0.085	0.115	0.145	0.155
H1.1.1 Hardened steel, hardened and tempered, < 55 HRC H1.1.2 Hardened steel, hardened and tempered, < 60 HRC H1.1.3 Hardened steel, hardened and tempered, > 60 HRC	K	50	0.005	0.015	0.020	0.025	0.035	0.040	0.075	0.125	0.150	0.200	0.250	0.275
	M	40	0.005	0.015	0.020	0.025	0.035	0.040	0.060	0.100	0.120	0.160	0.200	0.220
	L	25	0.005	0.005	0.010	0.015	0.020	0.020	0.045	0.070	0.085	0.115	0.145	0.155
H2.1.1 Chilled cast iron, 400 HB H2.1.2 Chilled cast iron, hardened and tempered, < 55 HRC	K	50	0.005	0.015	0.020	0.025	0.035	0.040	0.075	0.125	0.150	0.200	0.250	0.275
	M	40	0.005	0.015	0.020	0.025	0.035	0.040	0.060	0.100	0.120	0.160	0.200	0.220
	L	25	0.005	0.005	0.010	0.015	0.020	0.020	0.045	0.070	0.085	0.115	0.145	0.155

K = short tools with La/Dmin. < 3.5 | M = medium length tools with La/Dmin. from 3.5 - 6.5 | L = long tools with La/Dmin. > 6.5



Drilling into solid material and boring out



Machining group	Length	v _c (m/min) by system		f (mm/rev) by application	
		106	108	Drilling	Boring out
P1.1.1 Unalloyed steel, annealed, 0.15 % C, Rm 420 N/mm ² , 125 HB P1.1.2 Unalloyed steel, heat-treated, 0.15 % C, Rm 420 N/mm ² , 125 HB P1.1.3 Unalloyed steel, annealed, 0.45 % C, Rm 640 N/mm ² , 190 HB P1.1.4 Unalloyed steel, heat-treated, 0.45 % C, Rm 640 N/mm ² , 190 HB P1.1.5 Unalloyed steel, heat-treated, 0.45 % C, Rm 850 N/mm ² , 250 HB P1.1.6 Unalloyed steel, annealed, 0.75 % C, Rm 915 N/mm ² , 270 HB P1.1.7 Unalloyed steel, heat-treated, 0.75 % C, Rm 1020 N/mm ² , 300 HB	K	80	110	0.020	0.040
	M	60	80	0.020	0.040
P2.1.1 Low-alloy steel, annealed, Rm 610 N/mm ² , 180 HB P2.1.2 Low-alloy steel, heat-treated, Rm 930 N/mm ² , 275 HB P2.1.3 Low-alloy steel, heat-treated, Rm 1020 N/mm ² , 300 HB P2.1.4 Low-alloy steel, heat-treated, Rm 1190 N/mm ² , 350 HB	K	80	110	0.020	0.040
	M	60	80	0.020	0.040
P3.1.1 High-alloy steel and tool steel, annealed, Rm 680 N/mm ² , 200 HB P3.1.2 High-alloy steel and tool steel, hardened and tempered, Rm 1100 N/mm ² , 325 HB	K	80	110	0.020	0.040
	M	60	80	0.020	0.040
M1.1.1 Stainless steel, ferritic/martensitic, with machining additives M1.1.2 Stainless steel, ferritic/martensitic, annealed, Rm 680 N/mm ² , 200 HB M1.1.3 Stainless steel, ferritic/martensitic, heat-treated, Rm 810 N/mm ² , 240 HB	K	70	95	0.015	0.030
	M	55	75	0.015	0.030
M2.1.1 Stainless steel, austenitic, quenched, 180 HB M2.2.1 Duplex steel, high-strength stainless steels	K	70	95	0.015	0.030
	M	55	75	0.015	0.030
K1.1.1 Grey cast iron, pearlitic/ferritic, 180 HB K1.1.2 Grey cast iron, pearlitic/martensitic, 260 HB K1.2.1 Cast iron with spheroidal graphite, ferritic, 160 HB K1.2.2 Cast iron with spheroidal graphite, pearlitic, 250 HB K1.3.1 Malleable cast iron, ferritic, 130 HB K1.3.2 Malleable cast iron, pearlitic, 230 HB	K	80	110	0.025	0.050
	M	60	80	0.025	0.050
K2.1.1 Vermicular graphite cast iron (GJV) K2.2.1 Austenitic-ferritic spheroidal graphite cast iron (ADI)					
N1.1.1 Wrought aluminium alloys, non-hardened, 60 HB N1.1.2 Wrought aluminium alloys, hardened, 100 HB					
N2.1.1 Aluminium casting alloys, non-hardened, ≤ 12 % Si, 75 HB N2.1.2 Aluminium casting alloys, hardened, ≤ 12 % Si, 90 HB N2.1.3 Aluminium casting alloys, non-hardened, > 12 % Si, 130 HB					
N3.1.1 Copper and copper alloys: Free-machining alloy, Pb > 1 % N3.1.2 Copper and copper alloys: CuZn, CuSnZn N3.1.3 Copper and copper alloys: CuSn, lead-free copper and copper electrolyte					
N4.1.1 Non-metallic materials: Duroplastics, fibre-reinforced plastics N4.1.2 Non-metallic materials: Hard rubber, wood, etc. N4.1.3 Non-metallic materials: Graphite					
S1.1.1 Heat-resistant alloys, Fe-based, annealed, 200 HB S1.1.2 Heat-resistant alloys, Fe-based, hardened, 280 HB S1.1.3 Heat-resistant alloys, Ni- or Co-based, annealed, 250 HB S1.1.4 Heat-resistant alloys, Ni- or Co-based, hardened, 350 HB S1.1.5 Heat-resistant alloys, Ni- or Co-based, cast, 320 HB					
S2.1.1 Titanium alloys, pure titanium, Rm 400 N/mm ² S2.1.2 Titanium alloys, Alpha and Beta alloys, hardened, Rm 1050 N/mm ²					
H1.1.1 Hardened steel, hardened and tempered, < 55 HRC H1.1.2 Hardened steel, hardened and tempered, < 60 HRC H1.1.3 Hardened steel, hardened and tempered, > 60 HRC					
H2.1.1 Chilled cast iron, 400 HB H2.1.2 Chilled cast iron, hardened and tempered, < 55 HRC					

Cutting data

K = short tools with La/Dmin. < 3.5 | M = medium length tools with La/Dmin. from 3.5 - 6.5



Internal thread



Machining group	Length	v _c (m/min) by D _{min} .		a _{pmax} . (mm) by pitch				
				1.75	2.5	4	6	7
		≤ 4	> 4	≤ 1.75	≤ 2.5	≤ 4	≤ 6	> 6
P1.1.1 Unalloyed steel, annealed, 0.15 % C, Rm 420 N/mm ² , 125 HB P1.1.2 Unalloyed steel, heat-treated, 0.15 % C, Rm 420 N/mm ² , 125 HB P1.1.3 Unalloyed steel, annealed, 0.45 % C, Rm 640 N/mm ² , 190 HB P1.1.4 Unalloyed steel, heat-treated, 0.45 % C, Rm 640 N/mm ² , 190 HB P1.1.5 Unalloyed steel, heat-treated, 0.45 % C, Rm 850 N/mm ² , 250 HB P1.1.6 Unalloyed steel, annealed, 0.75 % C, Rm 915 N/mm ² , 270 HB P1.1.7 Unalloyed steel, heat-treated, 0.75 % C, Rm 1020 N/mm ² , 300 HB	K	60	60	0.220	0.250	0.335	0.375	0.400
	M	50	55	0.220	0.250	0.335	0.375	0.400
	L	35	45	0.220	0.250	0.335	0.375	0.400
P2.1.1 Low-alloy steel, annealed, Rm 610 N/mm ² , 180 HB P2.1.2 Low-alloy steel, heat-treated, Rm 930 N/mm ² , 275 HB P2.1.3 Low-alloy steel, heat-treated, Rm 1020 N/mm ² , 300 HB P2.1.4 Low-alloy steel, heat-treated, Rm 1190 N/mm ² , 350 HB	K	60	60	0.220	0.250	0.335	0.375	0.400
	M	50	55	0.220	0.250	0.335	0.375	0.400
	L	35	45	0.220	0.250	0.335	0.375	0.400
P3.1.1 High-alloy steel and tool steel, annealed, Rm 680 N/mm ² , 200 HB P3.1.2 High-alloy steel and tool steel, hardened and tempered, Rm 1100 N/mm ² , 325 HB	K	60	60	0.220	0.250	0.335	0.375	0.400
	M	50	55	0.220	0.250	0.335	0.375	0.400
	L	35	45	0.220	0.250	0.335	0.375	0.400
M1.1.1 Stainless steel, ferritic/martensitic, with machining additives M1.1.2 Stainless steel, ferritic/martensitic, annealed, Rm 680 N/mm ² , 200 HB M1.1.3 Stainless steel, ferritic/martensitic, heat-treated, Rm 810 N/mm ² , 240 HB	K	55	55	0.220	0.250	0.335	0.375	0.400
	M	45	50	0.220	0.250	0.335	0.375	0.400
	L	35	40	0.220	0.250	0.335	0.375	0.400
M2.1.1 Stainless steel, austenitic, quenched, 180 HB M2.2.1 Duplex steel, high-strength stainless steels	K	55	55	0.220	0.250	0.335	0.375	0.400
	M	45	50	0.220	0.250	0.335	0.375	0.400
	L	35	40	0.220	0.250	0.335	0.375	0.400
K1.1.1 Grey cast iron, pearlitic/ferritic, 180 HB K1.1.2 Grey cast iron, pearlitic/martensitic, 260 HB K1.2.1 Cast iron with spheroidal graphite, ferritic, 160 HB K1.2.2 Cast iron with spheroidal graphite, pearlitic, 250 HB K1.3.1 Malleable cast iron, ferritic, 130 HB K1.3.2 Malleable cast iron, pearlitic, 230 HB	K	60	60	0.220	0.250	0.335	0.375	0.400
	M	50	55	0.220	0.250	0.335	0.375	0.400
	L	35	45	0.220	0.250	0.335	0.375	0.400
K2.1.1 Vermicular graphite cast iron (GJV) K2.2.1 Austenitic-ferritic spheroidal graphite cast iron (ADI)								
N1.1.1 Wrought aluminium alloys, non-hardened, 60 HB N1.1.2 Wrought aluminium alloys, hardened, 100 HB	K	120	120	0.220	0.250	0.335	0.375	0.400
	M	105	115	0.220	0.250	0.335	0.375	0.400
	L	75	90	0.220	0.250	0.335	0.375	0.400
N2.1.1 Aluminium casting alloys, non-hardened, ≤ 12 % Si, 75 HB N2.1.2 Aluminium casting alloys, hardened, ≤ 12 % Si, 90 HB N2.1.3 Aluminium casting alloys, non-hardened, > 12 % Si, 130 HB	K	120	120	0.220	0.250	0.335	0.375	0.400
	M	105	115	0.220	0.250	0.335	0.375	0.400
	L	75	90	0.220	0.250	0.335	0.375	0.400
N3.1.1 Copper and copper alloys: Free-machining alloy, Pb > 1 % N3.1.2 Copper and copper alloys: CuZn, CuSnZn N3.1.3 Copper and copper alloys: CuZn, lead-free copper and copper electrolyte	K	120	120	0.220	0.250	0.335	0.375	0.400
	M	105	115	0.220	0.250	0.335	0.375	0.400
	L	75	90	0.220	0.250	0.335	0.375	0.400
N4.1.1 Non-metallic materials: Duroplastics, fibre-reinforced plastics N4.1.2 Non-metallic materials: Hard rubber, wood, etc. N4.1.3 Non-metallic materials: Graphite	K	120	120	0.220	0.250	0.335	0.375	0.400
	M	105	115	0.220	0.250	0.335	0.375	0.400
	L	75	90	0.220	0.250	0.335	0.375	0.400
S1.1.1 Heat-resistant alloys, Fe-based, annealed, 200 HB S1.1.2 Heat-resistant alloys, Fe-based, hardened, 280 HB S1.1.3 Heat-resistant alloys, Ni- or Co-based, annealed, 250 HB S1.1.4 Heat-resistant alloys, Ni- or Co-based, hardened, 350 HB S1.1.5 Heat-resistant alloys, Ni- or Co-based, cast, 320 HB	K	40	40	0.220	0.250	0.335	0.375	0.400
	M	35	35	0.220	0.250	0.335	0.375	0.400
	L	25	30	0.220	0.250	0.335	0.375	0.400
S2.1.1 Titanium alloys, pure titanium, Rm 400 N/mm ² S2.1.2 Titanium alloys, Alpha and Beta alloys, hardened, Rm 1050 N/mm ²	K	40	40	0.220	0.250	0.335	0.375	0.400
	M	35	35	0.220	0.250	0.335	0.375	0.400
	L	25	30	0.220	0.250	0.335	0.375	0.400
H1.1.1 Hardened steel, hardened and tempered, < 55 HRC H1.1.2 Hardened steel, hardened and tempered, < 60 HRC H1.1.3 Hardened steel, hardened and tempered, > 60 HRC	K	40	40	0.220	0.250	0.335	0.375	0.400
	M	35	35	0.220	0.250	0.335	0.375	0.400
	L	25	30	0.220	0.250	0.335	0.375	0.400
H2.1.1 Chilled cast iron, 400 HB H2.1.2 Chilled cast iron, hardened and tempered, < 55 HRC	K	40	40	0.220	0.250	0.335	0.375	0.400
	M	35	35	0.220	0.250	0.335	0.375	0.400
	L	25	30	0.220	0.250	0.335	0.375	0.400

Cutting data

f (mm/rev) = pitch P | K = short tools with La/Dmin. < 3.5 | M = medium length tools with La/Dmin. from 3.5 - 6.5 | L = long tools with La/Dmin. > 6.5



External thread



Machining group	v _c (m/min)	a _{pmax.} (mm) by pitch				
		≤ 1.75	≤ 2.5	≤ 4	≤ 6	> 6
P1.1.1 Unalloyed steel, annealed, 0.15 % C, Rm 420 N/mm ² , 125 HB	120	0.220	0.250	0.335	0.375	0.400
P1.1.2 Unalloyed steel, heat-treated, 0.15 % C, Rm 420 N/mm ² , 125 HB	120	0.220	0.250	0.335	0.375	0.400
P1.1.3 Unalloyed steel, annealed, 0.45 % C, Rm 640 N/mm ² , 190 HB	120	0.220	0.250	0.335	0.375	0.400
P1.1.4 Unalloyed steel, heat-treated, 0.45 % C, Rm 640 N/mm ² , 190 HB	120	0.220	0.250	0.335	0.375	0.400
P1.1.5 Unalloyed steel, heat-treated, 0.45 % C, Rm 850 N/mm ² , 250 HB	120	0.220	0.250	0.335	0.375	0.400
P1.1.6 Unalloyed steel, annealed, 0.75 % C, Rm 915 N/mm ² , 270 HB	120	0.220	0.250	0.335	0.375	0.400
P1.1.7 Unalloyed steel, heat-treated, 0.75 % C, Rm 1020 N/mm ² , 300 HB	120	0.220	0.250	0.335	0.375	0.400
P2.1.1 Low-alloy steel, annealed, Rm 610 N/mm ² , 180 HB	120	0.220	0.250	0.335	0.375	0.400
P2.1.2 Low-alloy steel, heat-treated, Rm 930 N/mm ² , 275 HB	120	0.220	0.250	0.335	0.375	0.400
P2.1.3 Low-alloy steel, heat-treated, Rm 1020 N/mm ² , 300 HB	120	0.220	0.250	0.335	0.375	0.400
P2.1.4 Low-alloy steel, heat-treated, Rm 1190 N/mm ² , 350 HB	120	0.220	0.250	0.335	0.375	0.400
P3.1.1 High-alloy steel and tool steel, annealed, Rm 680 N/mm ² , 200 HB	120	0.220	0.250	0.335	0.375	0.400
P3.1.2 High-alloy steel and tool steel, hardened and tempered, Rm 1100 N/mm ² , 325 HB	120	0.220	0.250	0.335	0.375	0.400
M1.1.1 Stainless steel, ferritic/martensitic, with machining additives	110	0.220	0.250	0.335	0.375	0.400
M1.1.2 Stainless steel, ferritic/martensitic, annealed, Rm 680 N/mm ² , 200 HB	110	0.220	0.250	0.335	0.375	0.400
M1.1.3 Stainless steel, ferritic/martensitic, heat-treated, Rm 810 N/mm ² , 240 HB	110	0.220	0.250	0.335	0.375	0.400
M2.1.1 Stainless steel, austenitic, quenched, 180 HB	110	0.220	0.250	0.335	0.375	0.400
M2.2.1 Duplex steel, high-strength stainless steels	110	0.220	0.250	0.335	0.375	0.400
K1.1.1 Grey cast iron, pearlitic/ferritic, 180 HB	120	0.220	0.250	0.335	0.375	0.400
K1.1.2 Grey cast iron, pearlitic/martensitic, 260 HB	120	0.220	0.250	0.335	0.375	0.400
K1.2.1 Cast iron with spheroidal graphite, ferritic, 160 HB	120	0.220	0.250	0.335	0.375	0.400
K1.2.2 Cast iron with spheroidal graphite, pearlitic, 250 HB	120	0.220	0.250	0.335	0.375	0.400
K1.3.1 Malleable cast iron, ferritic, 130 HB	120	0.220	0.250	0.335	0.375	0.400
K1.3.2 Malleable cast iron, pearlitic, 230 HB	120	0.220	0.250	0.335	0.375	0.400
K2.1.1 Vermicular graphite cast iron (GJV)						
K2.2.1 Austenitic-ferritic spheroidal graphite cast iron (ADI)						
N1.1.1 Wrought aluminium alloys, non-hardened, 60 HB	240	0.220	0.250	0.335	0.375	0.400
N1.1.2 Wrought aluminium alloys, hardened, 100 HB	240	0.220	0.250	0.335	0.375	0.400
N2.1.1 Aluminium casting alloys, non-hardened, ≤ 12 % Si, 75 HB	240	0.220	0.250	0.335	0.375	0.400
N2.1.2 Aluminium casting alloys, hardened, ≤ 12 % Si, 90 HB	240	0.220	0.250	0.335	0.375	0.400
N2.1.3 Aluminium casting alloys, non-hardened, > 12 % Si, 130 HB	240	0.220	0.250	0.335	0.375	0.400
N3.1.1 Copper and copper alloys: Free-machining alloy, Pb > 1 %	240	0.220	0.250	0.335	0.375	0.400
N3.1.2 Copper and copper alloys: CuZn, CuSnZn	240	0.220	0.250	0.335	0.375	0.400
N3.1.3 Copper and copper alloys: CuSn, lead-free copper and copper electrolyte	240	0.220	0.250	0.335	0.375	0.400
N4.1.1 Non-metallic materials: Duroplastics, fibre-reinforced plastics	240	0.220	0.250	0.335	0.375	0.400
N4.1.2 Non-metallic materials: Hard rubber, wood, etc.	240	0.220	0.250	0.335	0.375	0.400
N4.1.3 Non-metallic materials: Graphite	240	0.220	0.250	0.335	0.375	0.400
S1.1.1 Heat-resistant alloys, Fe-based, annealed, 200 HB	80	0.220	0.250	0.335	0.375	0.400
S1.1.2 Heat-resistant alloys, Fe-based, hardened, 280 HB	80	0.220	0.250	0.335	0.375	0.400
S1.1.3 Heat-resistant alloys, Ni- or Co-based, annealed, 250 HB	80	0.220	0.250	0.335	0.375	0.400
S1.1.4 Heat-resistant alloys, Ni- or Co-based, hardened, 350 HB	80	0.220	0.250	0.335	0.375	0.400
S1.1.5 Heat-resistant alloys, Ni- or Co-based, cast, 320 HB	80	0.220	0.250	0.335	0.375	0.400
S2.1.1 Titanium alloys, pure titanium, Rm 400 N/mm ²	80	0.220	0.250	0.335	0.375	0.400
S2.1.2 Titanium alloys, Alpha and Beta alloys, hardened, Rm 1050 N/mm ²	80	0.220	0.250	0.335	0.375	0.400
H1.1.1 Hardened steel, hardened and tempered, < 55 HRC	80	0.220	0.250	0.335	0.375	0.400
H1.1.2 Hardened steel, hardened and tempered, < 60 HRC	80	0.220	0.250	0.335	0.375	0.400
H1.1.3 Hardened steel, hardened and tempered, > 60 HRC	80	0.220	0.250	0.335	0.375	0.400
H2.1.1 Chilled cast iron, 400 HB	80	0.220	0.250	0.335	0.375	0.400
H2.1.2 Chilled cast iron, hardened and tempered, < 55 HRC	80	0.220	0.250	0.335	0.375	0.400

f (mm/rev) = Pitch P



Broaching



Machining group	f (mm/min)	System 104/106 (internal hexagon)		
		ap _{max.} (mm) by D _{min.}		
		1.5	1.7	2
P1.1.1 Unalloyed steel, annealed, 0.15 % C, Rm 420 N/mm ² , 125 HB	5000	0.020	0.020	0.025
P1.1.2 Unalloyed steel, heat-treated, 0.15 % C, Rm 420 N/mm ² , 125 HB	5000	0.020	0.020	0.025
P1.1.3 Unalloyed steel, annealed, 0.45 % C, Rm 640 N/mm ² , 190 HB	5000	0.020	0.020	0.025
P1.1.4 Unalloyed steel, heat-treated, 0.45 % C, Rm 640 N/mm ² , 190 HB	5000	0.020	0.020	0.025
P1.1.5 Unalloyed steel, heat-treated, 0.45 % C, Rm 850 N/mm ² , 250 HB	5000	0.020	0.020	0.025
P1.1.6 Unalloyed steel, annealed, 0.75 % C, Rm 915 N/mm ² , 270 HB	5000	0.020	0.020	0.025
P1.1.7 Unalloyed steel, heat-treated, 0.75 % C, Rm 1020 N/mm ² , 300 HB	5000	0.020	0.020	0.025
P2.1.1 Low-alloy steel, annealed, Rm 610 N/mm ² , 180 HB	5000	0.020	0.020	0.025
P2.1.2 Low-alloy steel, heat-treated, Rm 930 N/mm ² , 275 HB	5000	0.020	0.020	0.025
P2.1.3 Low-alloy steel, heat-treated, Rm 1020 N/mm ² , 300 HB	5000	0.020	0.020	0.025
P2.1.4 Low-alloy steel, heat-treated, Rm 1190 N/mm ² , 350 HB	5000	0.020	0.020	0.025
P3.1.1 High-alloy steel and tool steel, annealed, Rm 680 N/mm ² , 200 HB	5000	0.020	0.020	0.025
P3.1.2 High-alloy steel and tool steel, hardened and tempered, Rm 1100 N/mm ² , 325 HB	5000	0.020	0.020	0.025
M1.1.1 Stainless steel, ferritic/martensitic, with machining additives	3750	0.020	0.020	0.025
M1.1.2 Stainless steel, ferritic/martensitic, annealed, Rm 680 N/mm ² , 200 HB	3750	0.020	0.020	0.025
M1.1.3 Stainless steel, ferritic/martensitic, heat-treated, Rm 810 N/mm ² , 240 HB	3750	0.020	0.020	0.025
M2.1.1 Stainless steel, austenitic, quenched, 180 HB	3750	0.020	0.020	0.025
M2.2.1 Duplex steel, high-strength stainless steels	3750	0.020	0.020	0.025
K1.1.1 Grey cast iron, pearlitic/ferritic, 180 HB	6250	0.020	0.020	0.025
K1.1.2 Grey cast iron, pearlitic/martensitic, 260 HB	6250	0.020	0.020	0.025
K1.2.1 Cast iron with spheroidal graphite, ferritic, 160 HB	6250	0.020	0.020	0.025
K1.2.2 Cast iron with spheroidal graphite, pearlitic, 250 HB	6250	0.020	0.020	0.025
K1.3.1 Malleable cast iron, ferritic, 130 HB	6250	0.020	0.020	0.025
K1.3.2 Malleable cast iron, pearlitic, 230 HB	6250	0.020	0.020	0.025
K2.1.1 Vermicular graphite cast iron (GJV)				
K2.2.1 Austenitic-ferritic spheroidal graphite cast iron (ADI)				
N1.1.1 Wrought aluminium alloys, non-hardened, 60 HB	7500	0.020	0.020	0.025
N1.1.2 Wrought aluminium alloys, hardened, 100 HB	7500	0.020	0.020	0.025
N2.1.1 Aluminium casting alloys, non-hardened, ≤ 12 % Si, 75 HB	7500	0.020	0.020	0.025
N2.1.2 Aluminium casting alloys, hardened, ≤ 12 % Si, 90 HB	7500	0.020	0.020	0.025
N2.1.3 Aluminium casting alloys, non-hardened, > 12 % Si, 130 HB	7500	0.020	0.020	0.025
N3.1.1 Copper and copper alloys: Free-machining alloy, Pb > 1 %	7500	0.020	0.020	0.025
N3.1.2 Copper and copper alloys: CuZn, CuSnZn	7500	0.020	0.020	0.025
N3.1.3 Copper and copper alloys: CuSn, lead-free copper and copper electrolyte	7500	0.020	0.020	0.025
N4.1.1 Non-metallic materials: Duroplastics, fibre-reinforced plastics	7500	0.020	0.020	0.025
N4.1.2 Non-metallic materials: Hard rubber, wood, etc.	7500	0.020	0.020	0.025
N4.1.3 Non-metallic materials: Graphite	7500	0.020	0.020	0.025
S1.1.1 Heat-resistant alloys, Fe-based, annealed, 200 HB	2000	0.020	0.020	0.025
S1.1.2 Heat-resistant alloys, Fe-based, hardened, 280 HB	2000	0.020	0.020	0.025
S1.1.3 Heat-resistant alloys, Ni- or Co-based, annealed, 250 HB	2000	0.020	0.020	0.025
S1.1.4 Heat-resistant alloys, Ni- or Co-based, hardened, 350 HB	2000	0.020	0.020	0.025
S1.1.5 Heat-resistant alloys, Ni- or Co-based, cast, 320 HB	2000	0.020	0.020	0.025
S2.1.1 Titanium alloys, pure titanium, Rm 400 N/mm ²	2000	0.020	0.020	0.025
S2.1.2 Titanium alloys, Alpha and Beta alloys, hardened, Rm 1050 N/mm ²	2000	0.020	0.020	0.025
H1.1.1 Hardened steel, hardened and tempered, < 55 HRC	2000	0.020	0.020	0.025
H1.1.2 Hardened steel, hardened and tempered, < 60 HRC	2000	0.020	0.020	0.025
H1.1.3 Hardened steel, hardened and tempered, > 60 HRC	2000	0.020	0.020	0.025
H2.1.1 Chilled cast iron, 400 HB	2000	0.020	0.020	0.025
H2.1.2 Chilled cast iron, hardened and tempered, < 55 HRC	2000	0.020	0.020	0.025

Cutting data

plus one no-load stroke

Article no. index

Your success comes first

With Gühring you keep track of everything

GÜHRING

Article no.	Page	Cutting data page	Description	Tool material	Type
16	326		Twist drill sets	HSCO	N
17	325		Twist drill sets	HSS	N
18	326		Twist drill sets	HSCO	Ti
128	324	442	Drills with shank Ø 16.0 mm	HSCO	N
130	951		Dies for ISO metric threads	HSS-E	
139	952		Dies for ISO metric threads	HSS	
151	950		Dies for ISO metric threads	HSS	
152	951		Dies for ISO metric threads	HSS	
162	953		Dies for ISO metric fine threads	HSS	
169	880	962	Taps for ISO metric fine threads	HSS-E	GG
175	955		Dies for BSP threads	HSS	
176	955		Dies for BSP threads	HSS	
182	954		Dies for UNC threads	HSS	
185	954		Dies for UNF threads	HSS	
191	956		Dies for NPT threads	HSS	
196	815	960	Taps for ISO metric threads	HSS-E	N R40
198	956		Dies for R-threads BSPT	HSS	
201	325		Twist drill sets	HSS	N
204	293	459	Long series twist drills	HSS	N
205	246	442	Jobber drills	HSS	N
206	254	448	Jobber drills	HSS	H
207	257	451	Jobber drills	HSS	W
208	251	442	Jobber drills	HSS	N
209	254	448	Jobber drills	HSS	H
211	287	459	Bushing drills	HSS	N
217	289	459	Long series twist drills	HSS	N
218	294	460	Long series twist drills	HSS	H
219	295	461	Long series twist drills	HSS	W
220	292	459	Long series twist drills	HSS	N
223	222	442	Stub drills	HSS	N
224	229	448	Stub drills	HSS	H
225	230	451	Stub drills	HSS	W
226	226	442	Stub drills	HSS	N
235	307	466	Extra length twist drills, series 1	HSS	N
236	311	466	Extra length twist drills, series 2	HSS	N
237	314	466	Extra length twist drills, series 3	HSS	N
238	374	482	Straight shank short step drills with straight shank	HSS	N
242	317	468	Extra length twist drills	HSS	GT 100
243	317	468	Extra length twist drills	HSS	GT 100
244	317	468	Extra length twist drills	HSS	GT 100
245	330	442	Twist drills	HSS	N
249	376	482	Straight shank short step drills with straight shank	HSS	N
250	377	482	Straight shank short step drills with straight shank	HSS	N
252	226	442	Stub drills	HSS	N
253	353	474	Twist drills with internal coolant, flute length to company standard	HSS	N
254	351	474	Twist drills with internal coolant, flute length to company standard	HSS	N
255	352	474	Twist drills with internal coolant, flute length to company standard	HSS	N
257	337	459	Bushing drills	HSS	N
266	342	466	Extra length twist drills, series 1	HSS	N
267	345	466	Extra length twist drills, series 2	HSS	N
268	323	442	Drills with shank Ø 12.7 mm	HSS	N
270	354	472-473	Twist drills with internal coolant, flute length to DIN 341	HSS	N
273	840	960	Taps for ISO metric fine threads	HSS-E	N R40
274	372	482	Stepped drills for centring according to DIN 332	HSS	N
280	362	478	Centre drills without flat	HSS	N
281	362	478	Centre drills without flat	HSS	N
292	361	478	Centre drills without flat	HSS	N
293	349	468	Extra length twist drills	HSS	GT 100
297	820	961	Taps with coolant ducts for ISO metric threads	HSS-E-PM	H
298	350	468	Extra length twist drills	HSS	GT 100
299	350	468	Extra length twist drills	HSS	GT 100
301	52	394	HSS-E-PM micro-precision drills without coolant ducts	HSS-E-PM	N
302	820	961	Taps with coolant ducts for ISO metric threads	HSS-E-PM	H
303	54	394	HSS-E-PM micro-precision drills without coolant ducts	HSS-E-PM	N
305	264	442	Jobber drills	HSCO	N
308	268	442	Jobber drills	HSCO	N
313	769	960	Taps for ISO metric threads	HSS-E	N
315	769	960	Taps for ISO metric threads	HSS-E	N
316	784	959	Taps for ISO metric fine threads	HSS-E	N
317	301	459	Long series twist drills	HSCO	N
318	827	962	Taps with coolant ducts for ISO metric threads	HSS-E	GG
319	827	962	Taps with coolant ducts for ISO metric threads	HSS-E	GG

Article no.	Page	Cutting data page	Description	Tool material	Type
324	1082	1094	Counterbores with fixed pilots for fine tolerances	HSS	
325	1084	1094	Counterbores with fixed pilots for medium tolerances	HSS	
327	1068	1093	90° Countersinks	HSS	
328	1070	1093	90° Countersinks	HSS	
329	234	446	Stub drills	HSCO	GV 120
336	303	462-463	Long series twist drills	HSCO	GT 100
345	333	442	Twist drills	HSCO	N
347	847	962	Taps with coolant ducts for ISO metric fine threads	HSS-E	GG
357	340	459	Bushing drills	HSCO	N
361	817	961	Taps for ISO metric threads	HSS-E	H R40
362	817	961	Taps for ISO metric threads	HSS-E	H R40
363	329	446	Jobber drills	HSCO	GV 120
370	354	472-473	Twist drills with internal coolant, flute length to DIN 341	HSCO	GT 100
374	355	475	Twist drills with internal coolant, flute length to DIN 1870	HSCO	GT 100
378	374	482	Straight shank short step drills with straight shank	HSS	N
379	376	482	Straight shank short step drills with straight shank	HSS	N
380	377	482	Straight shank short step drills with straight shank	HSS	N
381	357	477	Centre drills without flat	HSCO	N
390	322	472	Twist drills with coolant ducts	HSS	N
391	761	958	Taps for UNC threads	HSS-E	VA R45
392	761	958	Taps for UNF threads	HSS-E	VA R45
393	752	958	Taps for ISO metric threads	HSS-E	VA R45
394	757	958	Taps for ISO metric fine threads	HSS-E	VA R45
395	762	958	Taps for BSP threads	HSS-E	VA R45
396	303	462-463	Long series twist drills	HSCO	GT 100
401	1004	1048	Machine reamers	HSS-E	
402	1004	1048	Machine reamers	HSS-E	
403	1023	1051	Quick helix reamers	HSS-E	
404	1014	1048	Machine reamers	HSS-E	
405	1014	1048	Machine reamers	HSS-E	
406	1024	1051	Quick helix reamers	HSS-E	
408	1027	1055	Shell reamers	HSS-E	
410	1028	1056	Machine taper reamers	HSS-E	
411	1028	1056	Machine taper reamers	HSS-E	
412	1030		Hand reamers	HSS	
413	1030		Hand reamers	HSS	
414	1025	1052	Bridge reamers	HSS	
415	1031		Adjustable hand reamers	HSS	
416	1032		Expanding hand reamers	HSS	
417	1032		Replacement blades for expanding hand reamers	HSS	
419	1026	1053	Machine bottoming reamers	HSS-E	
429	1029		Hand taper reamers	HSS	
431	1026	1054	Stepped machine reamers	HSS-E	
436	1072	1093	90° Countersinks for fine tolerances	HSS	
437	1072	1093	90° Countersinks for medium tolerances	HSS	
438	1073	1093	90° Countersinks for tapping size holes	HSS	
440	1005	1048-1049	Machine reamers	HSS-E	
455	1002	1047	NC machine reamers	HSS-E	
463	1087	1094	Counterbores with hole for detachable pilot	HSS	
464	1087		Detach. pilot for fine tolerances	HSS	
465	1088		Detach. pilot for medial tolerances	HSS	
466	1088		Detach. pilot for tapping size holes	HSS	
468	1006	1048	Machine reamers	HSS-E	
469	1023	1051	Quick helix reamers	HSS-E	
470	1076	1093	60° Countersinks	HSS	
471	1077	1093	60° Countersinks	HSS	
472	1076	1093	60° Countersinks	HSS	
473	1077	1093	60° Countersinks	HSS	
474	1069	1093	90° Countersinks	HSS	
475	1069	1093	90° Countersinks	HSS	
476	1067	1093	90° Countersinks	HSS	
477	1070	1093	90° Countersinks	HSS	
478	1080	1093	120° Countersinks	HSS	
480	1080	1093	120° Countersinks	HSS	
481	1081	1093	120° Countersinks	HSS	
482	1082	1094	Counterbores with fixed pilots for fine tolerances	HSS	
483	1084	1094	Counterbores with fixed pilots for medium tolerances	HSS	
484	1086	1094	Counterbores with fixed pilots for tapping size holes	HSS	
485	1083	1094	Counterbores with fixed pilots for fine tolerances	HSS	
486	1085	1094	Counterbores with fixed pilots for medium tolerances	HSS	
488	1016	1050	Machine reamers	HSS-E	
489	1016	1050	Machine reamers	HSS-E	

Article no.	Page	Cutting data page	Description	Tool material	Type
490	1002	1047	NC machine reamers	HSS-E	
495	587		90° Front/back deburrers	Solid carbide	EW 100 VR
496	1007	1048	Machine reamers	HSS-E	
497	1017	1050	Machine reamers	HSS-E	
498	1071	1093	90° Countersink sets	HSS	
499	1071	1093	90° Countersink sets	HSS	
501	299	464	Long series twist drills	HSS	GT 50
502	308	468	Extra length twist drills, series 1	HSS	GT 100
503	312	468	Extra length twist drills, series 2	HSS	GT 100
504	315	468	Extra length twist drills, series 3	HSS	GT 100
514	379	482	Straight shank subland drills	HSS	N
515	242	450	Stub drills	HSS-E-PM	GT 500 DZ
524	309	467	Extra length twist drills, series 1	HSS	GT 50
526	343	468	Extra length twist drills, series 1	HSS	GT 100
527	346	468	Extra length twist drills, series 2	HSS	GT 100
531	385	484	Taper pin drills	HSS	N
532	385	484	Taper pin drills	HSS	N
533	382	483	Straight shank core drills	HSS	N
534	383	483	Taper shank core drills	HSS	N
535	297	462	Long series twist drills	HSS	GT 100
536	378	482	Straight shank subland drills	HSS	N
538	379	482	Straight shank subland drills	HSS	N
539	381	482	Taper shank subland drills	HSS	N
540	380	482	Straight shank subland drills	HSS	N
541	381	482	Taper shank subland drills	HSS	N
546	369	479	142° NC spotting drills	Solid carbide	N
549	259	452	Jobber drills	HSS	GT 100
550	262	452	Jobber drills	HSS	GT 100
551	339	462	Bushing drills	HSS	GT 100
552	231	444	Stub drills	HSS	GT 80
553	231	444	Stub drills	HSS	GT 80
554	370	481	Straight shank drills double-ended	HSS	DK 77
555	384	483	Taper shank core drills	HSS	N
556	368	481	120° NC spotting drills	HSS	N
557	366	481	90° NC spotting drills	HSS	N
559	366	481	90° NC spotting drills	HSS	N
564	348	468	Extra length twist drills	HSS	GT 100
565	348	468	Extra length twist drills	HSS	GT 100
566	349	468	Extra length twist drills	HSS	GT 100
567	368	481	120° NC spotting drills	HSS	N
568	366	481	90° NC spotting drills	HSS	N
571	316	468-469	Extra length twist drills, series 3	HSCO	GT 100
572	240	449	Stub drills	HSCO	VA
574	372	482	Stepped drills for centring according to DIN 332	HSS	N
575	373	482	Stepped drills for centring according to DIN 332	HSS	N
576	373	482	Stepped drills for centring according to DIN 332	HSS	N
577	318	459	Aircraft extension drills, 6 inches long	HSS	N
578	320	459	Aircraft extension drills, 12 inches long	HSS	N
579	319	459	Aircraft extension drills, 6 inches long	HSS	N
580	321	459	Aircraft extension drills, 12 inches long	HSS	N
581	357	478	Centre drills without flat	HSS	N
582	358	478	Centre drills without flat	HSS	N
583	359	478	Centre drills without flat	HSS	N
584	359	478	Centre drills without flat	HSS	N
585	360	478	Centre drills without flat	HSS	N
587	363	478	Centre drills with flat	HSS	N
588	363	478	Centre drills with flat	HSS	N
589	363	478	Centre drills with flat	HSS	N
594	361	478	Centre drills without flat	HSS	N
595	361	478	Centre drills without flat	HSS	N
605	273	454	Jobber drills	HSCO	Ti
611	125	426	Ratio drills without coolant ducts, 3-fluted	Solid carbide	GS 200 U
613	357	478	Centre drills without flat	HSS	N
614	359	478	Centre drills without flat	HSS	N
617	305	465	Long series twist drills	HSCO	Ti
618	310	468-469	Extra length twist drills, series 1	HSCO	GT 100
619	313	468-469	Extra length twist drills, series 2	HSCO	GT 100
620	344	468	Extra length twist drills, series 1	HSCO	GT 100
621	347	468	Extra length twist drills, series 2	HSCO	GT 100
622	270	452	Jobber drills	HSCO	GT 100
623	341	462	Bushing drills	HSCO	GT 100
629	278	449	Jobber drills	HSCO	VA

Article no.	Page	Cutting data page	Description	Tool material	Type
636	378	482	Straight shank subland drills	HSS	N
641	1005	1048-1049	Machine reamers	HSS-E	
645	335	452	Twist drills	HSCO	GT 100
651	246	442	Jobber drills	HSS	N
652	259	452	Jobber drills	HSS	GT 100
653	222	442	Stub drills	HSS	N
654	330	442	Twist drills	HSS	N
657	273	454	Jobber drills	HSCO	Ti
658	270	452	Jobber drills	HSCO	GT 100
659	234	446	Stub drills	HSCO	GV 120
660	52	394	HSS-E-PM micro-precision drills without coolant ducts	HSS-E-PM	N
661	333	442	Twist drills	HSCO	N
663	329	446	Jobber drills	HSCO	GV 120
664	251	442	Jobber drills	HSS	N
666	287	459	Bushing drills	HSS	N
667	289	459	Long series twist drills	HSS	N
668	297	462	Long series twist drills	HSS	GT 100
669	305	465	Long series twist drills	HSCO	Ti
674	1000	1045	Machine reamers	Carbide	
693	283	458	Short flute drills	M42	H
701	49	392	Solid carbide micro-precision drills without coolant ducts	Solid carbide	N
703	129	429	Carbide-tipped twist drills	Carbide	N
717	997	1044	Machine reamers	Carbide	
718	997	1044	Machine reamers	Carbide	
723	364	479	90° NC spotting drills	Solid carbide	N
724	367	479	120° NC spotting drills	Solid carbide	N
730	244	430-431	Stub drills	Solid carbide	N
732	284	430	Jobber drills	Solid carbide	N
736	356	476	Centre drills without flat	Solid carbide	N
740	1001	1046	Expanding machine reamers	Carbide	
749	1001	1046	Expanding machine reamers	Carbide	
761	825	964	Taps for ISO metric threads	HSS-E-PM	VA R50
763	825	964	Taps for ISO metric threads	HSS-E-PM	VA R50
764	846	964	Taps for ISO metric fine threads	HSS-E-PM	VA R50
768	81	412	Ratio drills with coolant ducts	Solid carbide	RT 150 GG
769	106	413	Ratio drills with coolant ducts	Solid carbide	RT 150 GG
770	108	414	Ratio drills with coolant ducts	Solid carbide	RT 150 GG
773	110	418	Ratio drills with coolant ducts	Solid carbide	RT 150 GN
778	819	961	Taps with coolant ducts for ISO metric threads	HSS-E	H
779	819	961	Taps with coolant ducts for ISO metric threads	HSS-E	H
785	823	964	Taps for ISO metric threads	HSS-E	VA R15
794	767	959	Taps for ISO metric threads	HSS-E	N
795	875	959	Taps for ISO metric threads	HSS-E	N
799	808	959	Taps for ISO metric threads	HSS-E	N R15
800	830	963	Taps for ISO metric threads	HSS-E	Ms
803	765	959	Taps for ISO metric threads	HSS-E	N
805	777	963	Taps for ISO metric threads	HSS-E	AI
806	874	959	Taps for ISO metric threads	HSS-E	N
807	876	962	Taps for ISO metric threads	HSS-E	GG
809	807	959	Taps for ISO metric threads	HSS-E	N R15
810	809	959	Taps for ISO metric threads	HSS-E	N R40
812	831	963	Taps for ISO metric threads	HSS-E	AI R45
814	824	964	Taps for ISO metric threads	HSS-E	VA R40
815	766	959	Taps for ISO metric threads	HSS-E	N
817	777	963	Taps for ISO metric threads	HSS-E	AI
818	874	959	Taps for ISO metric threads	HSS-E	N
819	876	962	Taps for ISO metric threads	HSS-E	GG
821	807	959	Taps for ISO metric threads	HSS-E	N R15
822	809	959	Taps for ISO metric threads	HSS-E	N R40
824	831	963	Taps for ISO metric threads	HSS-E	AI R45
825	824	964	Taps for ISO metric threads	HSS-E	VA R40
826	813	960	Taps for ISO metric threads	HSS-E	N R40
827	783	959	Taps for ISO metric fine threads	HSS-E	N
829	879	959	Taps for ISO metric fine threads	HSS-E	N
830	878	959	Taps for ISO metric fine threads	HSS-E	N
831	880	962	Taps for ISO metric fine threads	HSS-E	GG
832	783	959	Taps for ISO metric fine threads	HSS-E	N
833	836	959	Taps for ISO metric fine threads	HSS-E	N R15
834	837	959	Taps for ISO metric fine threads	HSS-E	N R40
836	812	960	Taps for ISO metric threads	HSS-E	N R40
837	768	959	Taps for ISO metric threads	HSS-E	N
838	780	959	Taps for ISO metric threads	HSS-E	N

Article no.	Page	Cutting data page	Description	Tool material	Type
843	823	964	Taps for ISO metric threads	HSS-E	VA R15
844	810	959	Taps for ISO metric threads	HSS-E	N R40
845	768	959	Taps for ISO metric threads	HSS-E	N
848	810	959	Taps for ISO metric threads	HSS-E	N R40
851	781	959	Machine nut taps for ISO metric threads	HSS-E	N
852	837	959	Taps for ISO metric fine threads	HSS-E	N R40
853	943		Hand taps for ISO metric threads	HSS-E	VA
854	943		Hand taps for ISO metric threads	HSS-E	VA
855	943		Hand taps for ISO metric threads	HSS-E	VA
856	943		Hand taps for ISO metric threads	HSS-E	VA
857	944		Hand taps for ISO metric threads	HSS-E	H
858	944		Hand taps for ISO metric threads	HSS-E	H
859	944		Hand taps for ISO metric threads	HSS-E	H
860	944		Hand taps for ISO metric threads	HSS-E	H
861	942		Hand taps for ISO metric threads	HSS	N
862	942		Hand taps for ISO metric threads	HSS	N
863	942		Hand taps for ISO metric threads	HSS	N
864	942		Hand taps for ISO metric threads	HSS	N
873	794	959	Taps for UNC threads	HSS-E	N
876	852	959	Taps for UNC threads	HSS-E	N R40
878	794	959	Taps for UNC threads	HSS-E	N
881	852	959	Taps for UNC threads	HSS-E	N R40
884	946		Hand taps for ISO metric fine threads	HSS	N
885	946		Hand taps for ISO metric fine threads	HSS	N
886	946		Hand taps for ISO metric fine threads	HSS	N
888	835	959	Taps for ISO metric threads	HSS-E	N R40
903	900	968	Fluteless taps for ISO metric threads	HSS-E-PM	N
908	798	959	Taps for UNF threads	HSS-E	N
911	858	959	Taps for UNF threads	HSS-E	N R40
912	765	959	Taps for ISO metric threads	HSS-E	N
913	807	959	Taps for ISO metric threads	HSS-E	N R15
914	809	959	Taps for ISO metric threads	HSS-E	N R40
915	766	959	Taps for ISO metric threads	HSS-E	N
916	807	959	Taps for ISO metric threads	HSS-E	N R15
917	809	959	Taps for ISO metric threads	HSS-E	N R40
918	905	968	Fluteless taps for ISO metric threads	HSS-E	N
919	903	968	Fluteless taps for ISO metric threads	HSS-E	N
920	900	968	Fluteless taps for ISO metric threads	HSS-E	N
921	899	968	Fluteless taps for ISO metric threads	HSS-E	N
922	905	968	Fluteless taps for ISO metric threads	HSS-E	N
923	904	968	Fluteless taps with coolant ducts for ISO metric threads	HSS-E	N
925	899	968	Fluteless taps for ISO metric threads	HSS-E	N
926	915	968	Fluteless taps for ISO metric fine threads	HSS-E	N
927	914	968	Fluteless taps for ISO metric fine threads	HSS-E	N
929	902	968	Fluteless taps for ISO metric fine threads	HSS-E	N
937	866	960	Taps for BSP threads	HSS-E	N R40
942	771	960	Taps for ISO metric threads	Solid carbide	N
943	788	960	Taps for ISO metric fine threads	Solid carbide	N
944	788	960	Taps for ISO metric fine threads	Solid carbide	N
958	949		Hand taps for BSP threads	HSS	N
959	949		Hand taps for BSP threads	HSS	N
960	949		Hand taps for BSP threads	HSS	N
961	887	962	Taps for BSP threads	HSS-E	GG
962	800	959	Taps for BSP threads	HSS-E	N
963	887	959	Taps for BSP threads	HSS-E	N
964	864	959	Taps for BSP threads	HSS-E	N R15
965	864	959	Taps for BSP threads	HSS-E	N R40
966	902	968	Fluteless taps for BSP threads	HSS-E	N
967	802	964	Taps for BSP threads	HSS-E	VA
968	868	964	Taps for BSP threads	HSS-E	VA R40
969	828	962-963	Taps with coolant ducts for ISO metric threads	Solid carbide	H
971	833	963	Taps with coolant ducts for ISO metric threads	Solid carbide	N R15
972	848	962-963	Taps with coolant ducts for ISO metric fine threads	Solid carbide	H
973	889	959	Taps for NPT threads	HSS-E	N
974	848	962-963	Taps with coolant ducts for ISO metric fine threads	Solid carbide	H
977	849	963	Taps with coolant ducts for ISO metric fine threads	Solid carbide	N R15
978	849	963	Taps with coolant ducts for ISO metric fine threads	Solid carbide	N R15
979	889	959	Taps for PT threads	HSS-E	N
980	804	959	Taps for PT threads	HSS-E	N
981	947		Hand taps for UNC threads	HSS	N
982	947		Hand taps for UNC threads	HSS	N
983	947		Hand taps for UNC threads	HSS	N

Article no.	Page	Cutting data page	Description	Tool material	Type
984	947		Hand taps for UNC threads	HSS	N
985	948		Hand taps for UNF threads	HSS	N
986	948		Hand taps for UNF threads	HSS	N
987	948		Hand taps for UNF threads	HSS	N
991	780	959	Taps for ISO metric threads	HSS-E	N
993	835	959	Taps for ISO metric threads	HSS-E	N R40
998	781	959	Taps for ISO metric threads	HSS-E	N
1007	842	961	Taps with coolant ducts for ISO metric fine threads	HSS-E-PM	H
1008	829	962-963	Taps with coolant ducts for ISO metric threads	Solid carbide	H
1009	848	962-963	Taps with coolant ducts for ISO metric fine threads	Solid carbide	H
1010	803	960	Taps for EG threads	HSS-E	N
1011	871	960	Taps for EG threads	HSS-E	N R40
1018	280	457	AeroX split point drills	M42	AeroX
1025	123	425	Ratio drills without coolant ducts, 3-fluted	Solid carbide	GS 200 G
1036	988	1036	High-performance reamers	Solid carbide	HR 500 Guss S
1037	988	1036	High-performance reamers	Solid carbide	HR 500 Guss D
1038	992	1040	High-performance reamers	Carbide	HR 500 GT S
1039	992	1040	High-performance reamers	Carbide	HR 500 GT D
1040	993	1041	High-performance reamers	Cermet tipped	HR 500 GT S
1041	993	1041	High-performance reamers	Cermet tipped	HR 500 GT D
1049	840	960	Taps for ISO metric fine threads	HSS-E	N R40
1057	805	966-967	Taps for MJ threads	HSS-E-PM	TiNi
1058	805	966-967	Taps for MJF threads	HSS-E-PM	TiNi
1059	806	966-967	Taps for UNJC threads	HSS-E-PM	TiNi
1060	806	966-967	Taps for UNJF threads	HSS-E-PM	TiNi
1061	872	966-967	Taps for MJ threads	HSS-E-PM	Ti R15
1062	872	966-967	Taps for MJF threads	HSS-E-PM	Ti R15
1063	873	966-967	Taps for UNJC threads	HSS-E-PM	Ti R15
1064	873	966-967	Taps for UNJF threads	HSS-E-PM	Ti R15
1065	872	966-967	Taps for MJ threads	HSS-E-PM	Ni R10
1066	872	966-967	Taps for MJF threads	HSS-E-PM	Ni R10
1067	873	966-967	Taps for UNJC threads	HSS-E-PM	Ni R10
1068	873	966-967	Taps for UNJF threads	HSS-E-PM	Ni R10
1082	862	962	Taps with coolant ducts for UNF threads	HSS-E	GG
1083	327		AeroX split point drill sets	M42	AeroX
1084	830	963	Taps for ISO metric threads	HSS-E	Ms
1085	856	962	Taps with coolant ducts for UNC threads	HSS-E	GG
1086	856	962	Taps with coolant ducts for UNC threads	HSS-E	GG
1087	870	964	Taps for NPT threads	HSS-E	N
1088	870	964	Taps for NPT threads	HSS-E	N
1090	842	961	Taps with coolant ducts for ISO metric fine threads	HSS-E-PM	H
1091	821	961	Taps with coolant ducts for ISO metric threads	HSS-E-PM	H
1132	322	471	Twist drills with coolant ducts	HSCO	GT 80 IK
1133	365	480	90° NC spotting drills	HSCO	N
1135	368	480	120° NC spotting drills	HSCO	N
1137	371	480	Spot weld drills	HSCO	N
1139	826	964	Taps with coolant ducts for ISO metric threads	HSS-E-PM	VA R50
1142	826	964	Taps with coolant ducts for ISO metric threads	HSS-E-PM	VA R50
1144	846	964	Taps with coolant ducts for ISO metric fine threads	HSS-E-PM	VA R50
1146	281	442-443	Jobber drills	M42	N
1147	375	482	Straight shank short step drills with straight shank	HSS	N
1161	881	965	Taps for ISO metric fine threads	Solid carbide	H
1188	822	961	Taps with coolant ducts for ISO metric threads	HSS-E-PM	H R15
1194	822	961	Taps with coolant ducts for ISO metric threads	HSS-E-PM	H R15
1199	281	442-443	Jobber drills	M42	N
1200	843	961	Taps with coolant ducts for ISO metric fine threads	HSS-E-PM	H R15
1201	877	965	Taps for ISO metric threads	HSS-E-PM	H
1228	238	444-445	Stub drills	HSCO	GT 80
1255	899	968	Fluteless taps for ISO metric threads	HSS-E-PM	N
1256	899	968	Fluteless taps for ISO metric threads	HSS-E-PM	N
1259	241	442	Stub drills	M42	N
1262	336	470	Twist drills	HSCO	VA
1266	903	968	Fluteless taps for ISO metric threads	HSS-E-PM	N
1267	904	968	Fluteless taps for ISO metric threads	HSS-E-PM	N
1268	914	968	Fluteless taps for ISO metric fine threads	HSS-E-PM	N
1269	914	968	Fluteless taps for ISO metric fine threads	HSS-E-PM	N
1275	914	968	Fluteless taps for ISO metric fine threads	HSS-E	N
1277	915	968	Fluteless taps for ISO metric fine threads	HSS-E	N
1285	769	960	Taps for ISO metric threads	HSS-E-PM	N
1286	769	960	Taps for ISO metric threads	HSS-E-PM	N
1288	812	960	Taps for ISO metric threads	HSS-E-PM	N R40
1289	813	960	Taps for ISO metric threads	HSS-E-PM	N R40

Article no.	Page	Cutting data page	Description	Tool material	Type
1291	786	960	Taps for ISO metric fine threads	HSS-E-PM	N
1292	839	960-961	Taps for ISO metric fine threads	HSS-E-PM	N R40
1326	1068	1093	90° Countersinks	HSS	
1347	901	968	Fluteless taps for ISO metric threads	HSS-E-PM	N
1407	1000	1045	Machine reamers	Carbide	
1408	998	1044	Machine reamers	Carbide	
1409	998	1044	Machine reamers	Carbide	
1410	999	1044	Machine reamers	Carbide	
1411	999	1044	Machine reamers	Carbide	
1427	996	1042-1043	NC machine reamers	Solid carbide	
1431	1015	1048	Machine reamers with internal cooling	HSS-E	
1433	1029		Hand taper reamers	HSS	
1438	1027		Arbors, complete		
1449	995	1042-1043	NC machine reamers	Solid carbide	
1548	987	1035	High-performance reamers	Solid carbide	HR 500 TS
1549	987	1035	High-performance reamers	Solid carbide	HR 500 TD
1565	901	968	Fluteless taps for ISO metric threads	HSS-E-PM	N
1575	772	961	Taps for ISO metric threads	HSS-E-PM	H
1576	772	961	Taps for ISO metric threads	HSS-E-PM	H
1577	816	961	Taps for ISO metric threads	HSS-E-PM	H R15
1578	816	961	Taps for ISO metric threads	HSS-E-PM	H R15
1581	917	968	Fluteless taps with coolant ducts for ISO metric fine threads	Solid carbide	N
1582	919	968	Fluteless taps for UNC threads	HSS-E	N
1583	919	968	Fluteless taps for UNC threads	HSS-E	N
1584	920	968	Fluteless taps for UNF threads	HSS-E	N
1585	920	968	Fluteless taps for UNF threads	HSS-E	N
1586	921	968	Fluteless taps for BSP threads	HSS-E	N
1587	903	968	Fluteless taps for ISO metric threads	HSS-E	N
1588	906	968	Fluteless taps for ISO metric threads	HSS-E	N
1589	904	968	Fluteless taps for ISO metric threads	HSS-E	N
1612	155		Torx screwdrivers		
1612	216		Torx screwdrivers		
1612	628		Torx screwdrivers		
1675	985	1034	High-performance reamers	Solid carbide	HR 500 S
1676	985	1034	High-performance reamers	Solid carbide	HR 500 D
1678	989	1037	High-performance reamers	Solid carbide	HR 500 Alu S
1679	989	1037	High-performance reamers	Solid carbide	HR 500 Alu D
1680	990	1038	High-performance reamers	Carbide	HR 500 G S
1681	990	1038	High-performance reamers	Carbide	HR 500 G D
1682	991	1039	High-performance reamers	Cermet tipped	HR 500 G S
1683	991	1039	High-performance reamers	Cermet tipped	HR 500 G D
1685	984	1034	High-performance reamers	Solid carbide	HR 500 S
1686	984	1034	High-performance reamers	Solid carbide	HR 500 D
1691	628		Clamping screws for die sinking cutter holders		
1818	945		Hand taps for ISO metric threads	HSS-E-PM	H
1819	945		Hand taps for ISO metric threads	HSS-E-PM	H
1820	945		Hand taps for ISO metric threads	HSS-E-PM	H
1821	945		Hand taps for ISO metric threads	HSS-E-PM	H
1837	854	960	Taps for UNC threads	HSS-E	N R40
1838	859	960	Taps for UNF threads	HSS-E	N R40
1839	782	959	Machine combination drill taps for ISO metric threads	HSS-E	N
1858	778	962-963	Taps with coolant ducts for ISO metric threads	Solid carbide	H
1859	778	962-963	Taps with coolant ducts for ISO metric threads	Solid carbide	H
1860	792	962-963	Taps with coolant ducts for ISO metric fine threads	Solid carbide	H
1861	792	962-963	Taps with coolant ducts for ISO metric fine threads	Solid carbide	H
1870	774	964	Taps for ISO metric threads	HSS-E	VA
1871	775	964	Taps for ISO metric threads	HSS-E	VA AZ
1872	774	964	Taps for ISO metric threads	HSS-E	VA
1873	791	964	Taps for ISO metric fine threads	HSS-E	VA
1874	844	964	Taps for ISO metric fine threads	HSS-E	VA R15
1883	828	962-963	Taps with coolant ducts for ISO metric threads	Solid carbide	H
1890	827	962	Taps with coolant ducts for ISO metric threads	HSS-E	GG
1897	827	962	Taps with coolant ducts for ISO metric threads	HSS-E	GG
1904	847	962	Taps with coolant ducts for ISO metric fine threads	HSS-E	GG
1918	876	962	Taps for ISO metric threads	HSS-E	GG
1919	876	962	Taps for ISO metric threads	HSS-E	GG
1927	911	968	Fluteless taps with coolant ducts for ISO metric threads	Solid carbide	N
1931	910	968	Fluteless taps with coolant ducts for ISO metric threads	Solid carbide	N
1941	626	700	Die sinking cutter holders GF 200 WP		GF 200
1942	626	700	Die sinking cutter holders GF 200 WP		GF 200
1946	128	428	Twist drills with reinforced straight shank	Solid carbide	H
1947	627	700	Indexable inserts round	Cermet	GF 200

Article no.	Page	Cutting data page	Description	Tool material	Type
1971	836	959	Taps for ISO metric fine threads	HSS-E	N R15
1972	910	968	Fluteless taps with coolant ducts for ISO metric threads	Solid carbide	N
1977	882	959	Taps for UNC threads	HSS-E	N
1978	851	959	Taps for UNC threads	HSS-E	N R15
1979	883	962	Taps for UNC threads	HSS-E	GG
1980	796	964	Taps for UNC threads	HSS-E	VA
1981	855	964	Taps for UNC threads	HSS-E	VA R40
1984	883	962	Taps for UNC threads	HSS-E	GG
1985	796	964	Taps for UNC threads	HSS-E	VA
1986	855	964	Taps for UNC threads	HSS-E	VA R40
1987	885	959	Taps for UNF threads	HSS-E	N
1988	858	959	Taps for UNF threads	HSS-E	N R15
1989	886	962	Taps for UNF threads	HSS-E	GG
1991	860	964	Taps for UNF threads	HSS-E	VA R15
2311	776	962	Taps with coolant ducts for ISO metric threads	Solid carbide	H
2440	812	960	Taps for ISO metric threads	HSS-E	N R40
2441	813	960	Taps for ISO metric threads	HSS-E	N R40
2442	907	968	Fluteless taps with coolant ducts for ISO metric threads	HSS-E	N
2443	909	968	Fluteless taps with coolant ducts for ISO metric threads	HSS-E	N
2444	907	968	Fluteless taps with coolant ducts for ISO metric threads	HSS-E	N
2446	908	968	Fluteless taps with coolant ducts for ISO metric threads	HSS-E	N
2447	909	968	Fluteless taps with coolant ducts for ISO metric threads	HSS-E	N
2448	908	968	Fluteless taps with coolant ducts for ISO metric threads	HSS-E	N
2458	276	455	Jobber drills	HSCO	Ti
2459	272	453	Jobber drills	HSCO	GT 100
2461	237	447	Stub drills	HSCO	GV 120
2463	244	430-431	Stub drills	Solid carbide	N
2464	284	430	Jobber drills	Solid carbide	N
2469	69	400	Ratio drills with coolant ducts	Solid carbide	RT 100 U
2471	83	401	Ratio drills with coolant ducts	Solid carbide	RT 100 U
2472	57	397	Ratio drills without coolant ducts	Solid carbide	RT 100 U
2473	61	397	Ratio drills without coolant ducts	Solid carbide	RT 100 U
2474	68	398	Ratio drills without coolant ducts	Solid carbide	RT 100 U
2477	69	400	Ratio drills with coolant ducts	Solid carbide	RT 100 U
2479	83	401	Ratio drills with coolant ducts	Solid carbide	RT 100 U
2480	57	397	Ratio drills without coolant ducts	Solid carbide	RT 100 U
2498	238	444-445	Stub drills	HSS-E-PM	GT 80
2506	829	962	Taps with coolant ducts for ISO metric threads	Solid carbide	H
2515	912	968	Fluteless taps with coolant ducts for ISO metric threads	HSS-E	N
2518	900	968	Fluteless taps with coolant ducts for ISO metric threads	Solid carbide	N
2520	627	700	Indexable inserts round	Solid carbide	GF 200
2601	286	432	Jobber drills	Solid carbide	GT 100
2710	773	961	Taps for ISO metric threads	HSS-E	H
2713	122	425	Ratio drills without coolant ducts, 3-fluted	Solid carbide	FT 200 G
2719	64	398	Ratio drills without coolant ducts	Solid carbide	RT 100 U
2850	817	961	Taps for ISO metric threads	HSS-E	H R40
2851	817	961	Taps for ISO metric threads	HSS-E	H R40
2852	841	961	Taps for ISO metric fine threads	HSS-E	H R40
2853	839	960-961	Taps for ISO metric fine threads	HSS-E	N R40
2855	853	960	Taps for UNC threads	HSS-E	N R40
2857	853	960	Taps for UNC threads	HSS-E	N R40
2859	859	960	Taps for UNF threads	HSS-E	N R40
2861	866	960	Taps for BSP threads	HSS-E	N R40
2862	824	964	Taps for ISO metric threads	HSS-E	VA R40
2863	824	964	Taps for ISO metric threads	HSS-E	VA R40
2864	845	964	Taps for ISO metric fine threads	HSS-E	VA R40
2865	855	964	Taps for UNC threads	HSS-E	VA R40
2866	855	964	Taps for UNC threads	HSS-E	VA R40
2867	861	964	Taps for UNF threads	HSS-E	VA R40
2868	861	964	Taps for UNF threads	HSS-E	VA R40
2869	774	964	Taps for ISO metric threads	HSS-E	VA
2870	774	964	Taps for ISO metric threads	HSS-E	VA
2871	791	964	Taps for ISO metric fine threads	HSS-E	VA
2872	796	964	Taps for UNC threads	HSS-E	VA
2873	796	964	Taps for UNC threads	HSS-E	VA
2875	802	964	Taps for BSP threads	HSS-E	VA
2876	769	960	Taps for ISO metric threads	HSS-E	N
2877	769	960	Taps for ISO metric threads	HSS-E	N
2879	785	960	Taps for ISO metric fine threads	HSS-E	N
2881	795	960	Taps for UNC threads	HSS-E	N
2883	795	960	Taps for UNC threads	HSS-E	N
2885	798	960	Taps for UNF threads	HSS-E	N

Article no.	Page	Cutting data page	Description	Tool material	Type
2887	800	960	Taps for BSP threads	HSS-E	N
2895	823	964	Taps for ISO metric threads	HSS-E	VA R15
2896	823	964	Taps for ISO metric threads	HSS-E	VA R15
2897	844	964	Taps for ISO metric fine threads	HSS-E	VA R15
2901	779	966	Taps for ISO metric threads	HSS-E-PM	TiNi
2903	793	966-967	Taps for ISO metric fine threads	HSS-E-PM	TiNi
2905	797	966-967	Taps for UNC threads	HSS-E-PM	TiNi
2907	799	966-967	Taps for UNF threads	HSS-E-PM	TiNi
2909	834	966-967	Taps for ISO metric threads	HSS-E-PM	Ti R15
2910	850	966-967	Taps for ISO metric fine threads	HSS-E-PM	Ti R15
2912	857	966-967	Taps for UNC threads	HSS-E-PM	Ti R15
2914	863	966-967	Taps for UNF threads	HSS-E-PM	Ti R15
2916	779	966	Taps for ISO metric threads	HSS-E-PM	TiNi
2917	793	966-967	Taps for ISO metric fine threads	HSS-E-PM	TiNi
2918	797	966-967	Taps for UNC threads	HSS-E-PM	TiNi
2919	799	966-967	Taps for UNF threads	HSS-E-PM	TiNi
2920	834	966-967	Taps for ISO metric threads	HSS-E-PM	Ni R10
2921	850	966-967	Taps for ISO metric fine threads	HSS-E-PM	Ni R10
2922	857	966-967	Taps for UNC threads	HSS-E-PM	Ni R10
2923	863	966-967	Taps for UNF threads	HSS-E-PM	Ni R10
2941	772	961	Taps for ISO metric threads	HSS-E	H
2942	772	961	Taps for ISO metric threads	HSS-E	H
2943	789	961	Taps for ISO metric fine threads	HSS-E	H
2944	877	965	Taps for ISO metric threads	Solid carbide	H
2983	790	961	Taps for ISO metric fine threads	HSS-E	H
2985	818	961	Taps for ISO metric threads	HSS-E	H R40
2986	818	961	Taps for ISO metric threads	HSS-E	H R40
2988	841	961	Taps for ISO metric fine threads	HSS-E	H R40
2989	841	961	Taps for ISO metric fine threads	HSS-E	H R40
2990	770	960	Taps for ISO metric threads	HSS-E	N
2991	770	960	Taps for ISO metric threads	HSS-E	N
2992	787	960	Taps for ISO metric fine threads	HSS-E	N
2993	787	960	Taps for ISO metric fine threads	HSS-E	N
2994	814	960	Taps for ISO metric threads	HSS-E	N R40
2995	814	960	Taps for ISO metric threads	HSS-E	N R40
2996	64	398	Ratio drills without coolant ducts	Solid carbide	RT 100 U
2997	264	442	Jobber drills	HSCO	N
2999	840	960	Taps for ISO metric fine threads	HSS-E	N R40
3016	581	698	HSC face milling cutters	PCD	PF 1000 G
3021	633	690	Slot drills XL (2-fluted)	Solid carbide	N
3023	645	690	End mills XL (4-fluted)	Solid carbide	N
3030	601	704	Ball nose slot drills XL (2-fluted)	Solid carbide	N
3043	601	704	Ball nose end mills XL (4-fluted)	Solid carbide	N
3047	557	686	Multi-tooth end mills GH 100 U	Solid carbide	NH
3049	599	704	Ball nose slot drills (2-fluted)	Solid carbide	N
3050	600	704	Ball nose end mills (4-fluted)	Solid carbide	N
3117	667	708	Morse taper end mills	HSCO	NR
3120	669	708	Morse taper end mills	HSCO	N
3121	668	708	Morse taper end mills	HSCO	NR
3142	656	708	Mini slot drills (3-fluted)	M42	N
3143	656	708	Mini slot drills (3-fluted)	M42	N
3144	656	708	Mini slot drills (3-fluted)	M42	N
3145	656	708	Mini slot drills (3-fluted)	M42	N
3154	630	690	Slot drills (2-fluted)	Solid carbide	N
3176	675	708	Quadrant milling cutters	HSCO	N
3185	672	708	Shell end mills	M42	NR
3187	672	708	Shell end mills	M42	NF
3202	566	696	Ratio end mills Alu RF 100 A	Solid carbide	W
3309	572	690	Al slot drills (2-fluted)	Solid carbide	W
3314	640	690	Slot drills XL (3-fluted)	Solid carbide	N
3319	566	696	Ratio end mills Alu RF 100 A	Solid carbide	W
3322	648	706	Roughing end mills GS 40 (fine teeth)	HSS-E-PM	NRf
3340	649	706	Roughing end mills GS 40 (fine teeth)	HSS-E-PM	NRf
3342	666	708	Roughing/finishing end mills	M42	NF
3343	665	708	Roughing/finishing end mills	M42	NF
3346	663	708	Roughing end mills	M42	NR
3347	664	708	Roughing end mills	M42	NR
3358	572	690	Al slot drills XL (2-fluted)	Solid carbide	W
3365	539	688	Roughing end mills GS 100 U (fine teeth)	Solid carbide	NRf
3366	547	682	Ratio end mills RF 100 F	Solid carbide	NH
3396	584	690	90° Chamfering milling cutters	Solid carbide	N
3428	660	708	End mills	M42	N

Article no.	Page	Cutting data page	Description	Tool material	Type
3429	646	706	Ratio end mills RF 40	HSS-E-PM	N
3431	661	708	End mills	M42	N
3432	647	706	Ratio end mills RF 40	HSS-E-PM	N
3433	662	708	End mills	M42	N
3440	668	708	Morse taper end mills	HSCO	N
3451	651	708	Slot drills (2-fluted)	M42	N
3452	652	708	Slot drills (2-fluted)	M42	N
3453	653	708	Slot drills (2-fluted)	M42	N
3458	657	708	Slot drills (3-fluted)	M42	N
3459	658	708	Slot drills (3-fluted)	M42	N
3460	659	708	Slot drills (3-fluted)	M42	N
3466	654	708	Ball nose slot drills (2-fluted)	M42	N
3467	655	708	Ball nose slot drills (2-fluted)	M42	N
3472	561	696	Ratio end mills Alu RF 100 A	Solid carbide	W
3473	564	696	Ratio end mills Alu RF 100 A	Solid carbide	W
3498	544	682	Ratio end mills RF 100 Ti	Solid carbide	N
3499	544	682	Ratio end mills RF 100 Ti	Solid carbide	N
3504	671	708	Shell end mills	M42	N
3515	927	972	Thread milling cutters with chamfer for BSP threads	Solid carbide	TMC SP
3526	926	972	Thread milling cutters with chamfer for ISO metric threads	Solid carbide	TMC SP
3528	927	972	Thread milling cutters with chamfer for ISO metric fine threads	Solid carbide	TMC SP
3530	670	708	Side and face cutters	HSCO	N
3533	927	972	Thread milling cutters with chamfer for BSP threads	Solid carbide	TMC SP
3540	512	686	Slot drills GH 100 U (3-fluted)	Solid carbide	NH
3541	928	972	Universal thread milling cutters for ISO metric threads	Solid carbide	TMU SP
3542	930	972	Universal thread milling cutters for BSP threads	Solid carbide	TMU SP
3544	926	972	Thread milling cutters with chamfer for ISO metric threads	Solid carbide	TMC SP
3546	927	972	Thread milling cutters with chamfer for ISO metric fine threads	Solid carbide	TMC SP
3556	928	972	Universal thread milling cutters for ISO metric threads	Solid carbide	TMU SP
3557	930	972	Universal thread milling cutters for BSP threads	Solid carbide	TMU SP
3558	636	690	Slot drills (3-fluted)	Solid carbide	N
3560	637	690	Slot drills (3-fluted)	Solid carbide	N
3561	625	690	Slot drills with corner radius (2-fluted)	Solid carbide	N
3562	624	690	End mills with corner radius (4-fluted)	Solid carbide	N
3563	623	686	Multi-tooth end mills with corner radius GH 100 U	Solid carbide	NH
3570	673	708	T-slot end mills	HSCO	N
3572	674	708	Dovetail cutters	HSCO	H
3574	674	708	Dovetail cutters	HSCO	H
3576	674	708	Dovetail cutters	HSCO	H
3577	674	708	Dovetail cutters	HSCO	H
3580	673	708	Woodruff cutters	HSCO	N
3595	929	972	Universal thread milling cutters for UN threads	Solid carbide	TMU SP
3596	929	972	Universal thread milling cutters for UN threads	Solid carbide	TMU SP
3599	563	696	Ratio end mills Alu RF 100 A	Solid carbide	W
3627	533	682	Standard Ratio end mills RF 100 U	Solid carbide	N
3629	546	682	Ratio end mills RF 100 F	Solid carbide	NH
3630	546	682	Ratio end mills RF 100 F	Solid carbide	NH
3631	554	682	Ratio end mills Superfinish RF 100 SF	Solid carbide	NH
3632	554	682	Ratio end mills Superfinish RF 100 SF	Solid carbide	NH
3633	629	690	Slot drills (2-fluted)	Solid carbide	N
3634	629	690	Slot drills (2-fluted)	Solid carbide	N
3635	630	690	Slot drills (2-fluted)	Solid carbide	N
3636	513	686	Slot drills GH 100 U (3-fluted)	Solid carbide	NH
3637	641	690	End mills (4-fluted)	Solid carbide	N
3649	642	690	End mills (4-fluted)	Solid carbide	N
3650	664	708	Roughing end mills	M42	NR
3651	657	708	Slot drills (3-fluted)	M42	N
3654	671	708	Shell end mills	M42	N
3660	649	706	Roughing end mills GS 40 (fine teeth)	HSS-E-PM	NRf
3663	651	708	Slot drills (2-fluted)	M42	N
3664	658	708	Slot drills (3-fluted)	M42	N
3668	648	706	Roughing end mills GS 40 (fine teeth)	HSS-E-PM	NRf
3669	665	708	Roughing/finishing end mills	M42	NF
3670	660	708	End mills	M42	N
3676	632	690	Slot drills (2-fluted)	Solid carbide	N
3677	638	690	Slot drills (3-fluted)	Solid carbide	N
3678	643	690	End mills (4-fluted)	Solid carbide	N
3679	599	704	Ball nose slot drills (2-fluted)	Solid carbide	N
3680	640	690	Slot drills XL (3-fluted)	Solid carbide	N
3682	617	688	Hard roughing end mills GS 100 H (fine teeth)	Solid carbide	HR
3684	634	690	Mini slot drills (3-fluted)	Solid carbide	N
3686	635	690	Mini slot drills (3-fluted)	Solid carbide	NH

Article no.	Page	Cutting data page	Description	Tool material	Type
3689	557	686	Multi-tooth end mills GH 100 U	Solid carbide	NH
3690	663	708	Roughing end mills	M42	NR
3691	558	686	Multi-tooth end mills GH 100 U	Solid carbide	NH
3692	661	708	End mills	M42	N
3693	558	686	Multi-tooth end mills GH 100 U	Solid carbide	NH
3694	652	708	Slot drills (2-fluted)	M42	N
3695	653	708	Slot drills (2-fluted)	M42	N
3698	666	708	Roughing/finishing end mills	M42	NF
3703	654	708	Ball nose slot drills (2-fluted)	M42	N
3704	655	708	Ball nose slot drills (2-fluted)	M42	N
3705	646	706	Ratio end mills RF 40	HSS-E-PM	N
3706	647	706	Ratio end mills RF 40	HSS-E-PM	N
3709	631	690	Slot drills (2-fluted)	Solid carbide	N
3711	639	690	Slot drills (3-fluted)	Solid carbide	N
3713	644	690	End mills (4-fluted)	Solid carbide	N
3719	636	690	Slot drills (3-fluted)	Solid carbide	N
3720	637	690	Slot drills (3-fluted)	Solid carbide	N
3721	641	690	End mills (4-fluted)	Solid carbide	N
3722	642	690	End mills (4-fluted)	Solid carbide	N
3723	539	688	Roughing end mills GS 100 U (fine teeth)	Solid carbide	NRf
3727	600	704	Ball nose end mills (4-fluted)	Solid carbide	N
3729	512	686	Slot drills GH 100 U (3-fluted)	Solid carbide	NH
3730	513	686	Slot drills GH 100 U (3-fluted)	Solid carbide	NH
3731	528	682	Standard Ratio end mills RF 100 U	Solid carbide	N
3732	529	682	Standard Ratio end mills RF 100 U	Solid carbide	N
3735	923	972	Thread milling cutters without chamfer for ISO metric threads	Solid carbide	TM SP
3736	529	682	Standard Ratio end mills RF 100 U	Solid carbide	N
3737	922	972	Thread milling cutters without chamfer for ISO metric threads	Solid carbide	TM SP
3740	923	972	Thread milling cutters without chamfer for ISO metric threads	Solid carbide	TM SP
3741	514	686	Slot drills GH 100 U (3-fluted)	Solid carbide	NH
3743	922	972	Thread milling cutters without chamfer for ISO metric threads	Solid carbide	TM SP
3745	925	972	Thread milling cutters without chamfer for BSP threads	Solid carbide	TM SP
3748	925	972	Thread milling cutters without chamfer for BSP threads	Solid carbide	TM SP
3749	672	708	Shell end mills	M42	NR
3753	925	972	Thread milling cutters without chamfer for NPT threads	Solid carbide	TM SP
3754	925	972	Thread milling cutters without chamfer for NPT threads	Solid carbide	TM SP
3768	930	972	Universal thread milling cutters for NPT threads	Solid carbide	TMU SP
3769	930	972	Universal thread milling cutters for NPT threads	Solid carbide	TMU SP
3778	940	974	Drill thread milling cutters for ISO metric threads	Solid carbide	DTMC SP
3779	940	974	Drill thread milling cutters for ISO metric threads	Solid carbide	DTMC SP
3783	941	974	Drill thread milling cutters for ISO metric threads	Solid carbide	DTMC SP
3800	541	682	Ratio end mills RF 100 VA	Solid carbide	N
3803	541	682	Ratio end mills RF 100 VA	Solid carbide	N
3804	540	682	Ratio end mills RF 100 VA	Solid carbide	N
3805	540	682	Ratio end mills RF 100 VA	Solid carbide	N
3806	542	682	Ratio end mills RF 100 VA	Solid carbide	N
3807	542	682	Ratio end mills RF 100 VA	Solid carbide	N
3836	659	708	Slot drills (3-fluted)	M42	N
3837	532	682	Standard Ratio end mills RF 100 U	Solid carbide	N
3838	532	682	Standard Ratio end mills RF 100 U	Solid carbide	N
3839	532	682	Standard Ratio end mills RF 100 U	Solid carbide	N
3871	532	682	Standard Ratio end mills RF 100 U	Solid carbide	N
3872	531	682	Standard Ratio end mills RF 100 U	Solid carbide	N
3873	531	682	Standard Ratio end mills RF 100 U	Solid carbide	N
3891	510	682	Standard Ratio end mills RF 100 U (3-fluted)	Solid carbide	N
3892	510	682	Standard Ratio end mills RF 100 U (3-fluted)	Solid carbide	N
3893	509	682	Standard Ratio end mills RF 100 U (3-fluted)	Solid carbide	N
3894	509	682	Standard Ratio end mills RF 100 U (3-fluted)	Solid carbide	N
3897	555	682	Ratio end mills Superfinish RF 100 SF	Solid carbide	NH
3898	555	682	Ratio end mills Superfinish RF 100 SF	Solid carbide	NH
3899	50	393	Solid carbide micro-precision drills without coolant ducts	Solid carbide	N
4000	936	969	Thread milling cutters with chamfer for ISO metric threads	Solid carbide	SC-TMC-SP
4001	937	970	Micro thread milling cutters for ISO metric threads	Solid carbide	SC-MTM3-SP
4002	938	971	Circular drill thread milling cutters for ISO metric threads	Solid carbide	MTMH3-Z
4003	1328		CAT / HSK-C basic adaptors		
4038	1123		Clamping force measuring instrument Senso 3000		
4038	1339		Clamping force measuring instrument Senso 3000		
4044	99	402	Ratio drills with coolant ducts	Solid carbide	RT 100 U
4045	99	402	Ratio drills with coolant ducts	Solid carbide	RT 100 U
4068	1339		Flow rate measuring device PQ 3000		
4071	154		Clamping screws		
4071	217		Clamping screws		

Article no.	Page	Cutting data page	Description	Tool material	Type
4076	1340		Coolant supply measuring instrument CC 3000		
4077	1340		High-grade steel filter for coolant supply measuring device		
4095	1305		Reduction sleeves for floating holders		
4096	1305		Reduction sleeves for short floating holders		
4097	1306		Reduction sleeves for mini floating holders		
4098	1303		Floating holder with collet holder		
4099	1122		Extraction keys for reduction bushes		
4100	1089		Deburring forks	Solid carbide	EW 100 G
4101	1089		Deburring forks	Solid carbide	EW 100 G
4103	1090		Deburring reamers	Solid carbide	
4105	131		Tool holders for interchangeable inserts HT 800		HT 800 WP
4106	132		Tool holders for interchangeable inserts HT 800		HT 800 WP
4107	134		Tool holders for interchangeable inserts HT 800		HT 800 WP
4108	136		Tool holders for interchangeable inserts HT 800		HT 800 WP
4109	138		Tool holders for interchangeable inserts HT 800		HT 800 WP
4110	140		Tool holders for interchangeable inserts HT 800		HT 800 WP
4111	142	433	Interchangeable inserts HT 800	Solid carbide	HT 800 WP Pilot
4112	145	434-436	Interchangeable inserts HT 800	Solid carbide	HT 800 WP
4113	147	434-436	Interchangeable inserts HT 800	Solid carbide	HT 800 WP
4114	149	434-436	Interchangeable inserts HT 800	Solid carbide	HT 800 WP
4115	151	434-436	Interchangeable inserts HT 800	Solid carbide	HT 800 WP
4116	1304		Floating holder with collet holder		
4117	1304		Floating side lock holder VDI DIN 69880-1		
4127	870	964	Taps for NPTF threads	HSS-E	N
4132	922	972	Thread milling cutters without chamfer for ISO metric threads	Solid carbide	TM SP
4133	922	972	Thread milling cutters without chamfer for ISO metric threads	Solid carbide	TM SP
4134	924	972	Thread milling cutters without chamfer for UNC threads	Solid carbide	TM SP
4135	924	972	Thread milling cutters without chamfer for UNC threads	Solid carbide	TM SP
4136	924	972	Thread milling cutters without chamfer for UNF threads	Solid carbide	TM SP
4137	924	972	Thread milling cutters without chamfer for UNF threads	Solid carbide	TM SP
4143	910	968	Fluteless taps with coolant ducts for ISO metric threads	HSS-E-PM	N
4145	916	968	Fluteless taps with coolant ducts for ISO metric fine threads	HSS-E-PM	N
4146	912	968	Fluteless taps with coolant ducts for ISO metric threads	HSS-E	N
4147	918	968	Fluteless taps with coolant ducts for ISO metric fine threads	HSS-E	N
4152	921	968	Fluteless taps with coolant ducts for BSP threads	HSS-E	N
4153	815	960	Taps for ISO metric threads	HSS-E	N R40
4154	811	960	Taps for ISO metric threads	HSS-E	N R15
4155	811	960	Taps for ISO metric threads	HSS-E	N R15
4156	838	960	Taps for ISO metric fine threads	HSS-E	N R15
4157	838	960	Taps for ISO metric fine threads	HSS-E	N R15
4158	865	960	Taps for BSP threads	HSS-E	N R15
4159	869	964	Taps for BSP threads	HSS-E-PM	VA R50
4161	881	965	Taps for ISO metric fine threads	HSS-E-PM	H
4162	931	972	External thread milling cutters for ISO metric threads	Solid carbide	TMU SP
4163	931	972	External thread milling cutters for ISO metric threads	Solid carbide	TMU SP
4165	821	961	Taps with coolant ducts for ISO metric threads	HSS-E-PM	H
4167	1302		Floating side lock holders		
4169	1302		Floating holders, short, with side lock holder		
4174	1303		Floating holders, mini, with side lock holder		
4175	1265		Collet holders ER metallic sealed		ER
4175	1307		Collet holders ER metallic sealed		ER
4201	581	698	HSC face milling cutters		PF 3000
4203	582		Coolant distributor		PF 3000
4204	582	698	PCD cartridges HSC	PCD	PF 3000
4206	1185		Quick change tapping chuck adaptors		
4208	1232		Extensions HPC		
4209	1190		MQL 1-channel hydraulic chucks HSK-A (manual tool change)		
4210	1191		MQL 1-channel hydraulic chucks HSK-A (automatic tool change)		
4213	1112		ISO taper hydraulic chucks with increased clamping force		
4214	933	972	Micro thread milling cutters for MJ threads	Solid carbide	MTM3 SP
4215	934	972	Micro thread milling cutters for UNJ threads	Solid carbide	MTM3 SP
4218	742	958	Taps for ISO metric threads	HSS-E	VA
4219	747	958	Taps for ISO metric fine threads	HSS-E	VA
4220	750	958	Taps for BSP threads	HSS-E	VA
4221	1116		MAS/BT hydraulic chucks with increased clamping force		
4222	1275		Milling arbors CAT		
4223	932	972	Micro thread milling cutters for UN threads	Solid carbide	MTM3 SP
4225	934	972	Micro thread milling cutters for ISO metric threads	Solid carbide	MTM1 SP
4226	932	972	Micro thread milling cutters for ISO metric threads	Solid carbide	MTM3 SP
4227	935	972	Micro thread milling cutters for ISO metric threads	Solid carbide	MTMH3 SP
4228	933	972	Micro thread milling cutters for BSP-threads	Solid carbide	MTM3 SP
4229	144	437	Interchangeable inserts HT 800	Solid carbide	HT 800 WP

Article no.	Page	Cutting data page	Description	Tool material	Type
4230	1274		Milling arbors MAS/BT		
4232	1237		HSK-A Weldon side lock holders GÜHROJET		
4233	1249		MAS/BT Whistle Notch side lock holders		
4234	1248		MAS/BT Weldon side lock holders GÜHROJET		
4235	1234		Clamping sleeves for precision clamping chucks, sealed version		
4236	1235		Clamping sleeves GÜHROJET, imperial, for HPC clamping chucks		P
4237	1236		Clamping sleeves, imp., f. prec. clamp. chucks, sealed version		
4238	1281		ISO taper morse taper holders		
4239	1282		BT morse taper holders		
4240	1271		MAS/BT NC drilling chucks with internal cooling		
4241	1126		Clamping screws for hydraulic chucks and synchro tapping chucks		
4242	1270		ISO taper NC drilling chucks with internal cooling		
4243	1231		HPC chucks CAT		
4244	1231		HPC chucks MAS/BT		
4245	1259		MAS/BT collet holders		
4267	1110		HSK-C hydraulic chucks with increased clamping force		
4290	994		HSK-A hydraulic chucks, overlength		
4295	1111		HSK-C hydraulic chucks with radial length adjustment		
4296	1106		HSK-A hydraulic chucks with radial length adjustment		
4297	1293		Module 4x4 HSK-A alignment adaptors		Modul 4x4
4298	1201		MQL synchro tapping chucks HSK-A (manual tool change)		
4298	1221		MQL synchro tapping chucks HSK-A (manual tool change)		
4299	1104		HSK-A hydraulic chucks with increased clamping force		
4300	1230		HPC chucks HSK-A		
4301	1230		HPC chucks SK		
4302	1233		Clamping sleeves GÜHROJET w. peripheral cooling f. HPC clamp. chucks		
4303	1255		HSK-C collet holders		
4304	1253		HSK-A collet holders		
4305	1223		MQL adjusting screws with internal cone for MQL synchro tapping chucks		
4306	1266		Clamping nuts, system DIN ISO 15488		
4307	1263		Collets DIN ISO 15488		ER
4308	1182		Tapping collets		
4316	1124		HSK-C universal length pre-setting adaptors		
4319	1124		ISO taper universal length pre-setting adaptors		
4320	1280		HSK-A morse taper holders		
4323	1256		HSK-C collet holders, sealed version		
4324	1254		HSK-A collet holders, sealed version		
4326	1181		Synchro tapping chucks with straight shank and internal cooling		
4327	1181		HSK-A synchro tapping chucks with internal coolant		
4328	1184		HSK-A quick change tapping chucks with internal coolant		
4329	1239		HSK-A Weldon side lock holders		
4330	1202		MQL 1-channel synchro tapping chucks HSK-A (automatic tool change)		
4333	1242		HSK-C Whistle notch side lock holders		
4334	1241		HSK-A Whistle notch side lock holders		
4335	1267		Sealing washers		
4340	1183		Quick change tapping chucks without internal coolant		
4341	1222		MQL 2-channel synchro tapping chucks HSK-A (automatic tool change)		
4342			Quick change tapping chucks with internal coolant		
4343	1183		HSK-A basic adaptors for tapping chucks		
4346	1270		HSK-A NC drilling chucks with internal cooling		
4350	1320		Extensions HSK-A/HSK-C with MQL 4-point clamping set		
4351	1320		Extensions HSK-C		
4355	1319		HSK-A/HSK-C reductions		
4360	1296		Module 4x4 hydraulic chuck flanges		Modul 4x4
4361	1276		Combination cutter arbours HSK-A		
4362	1272		Milling arbors HSK-A		
4363	1291		Module 6x6 HSK adaptor flanges		Modul 6x6
4364	1180		Adjusting screws "faces" for synchro tapping chucks with int. coolant		A/B
4368	1120		Reduction bushes, sealed, for hydraulic chucks		
4369	1121		Reduction bushes GÜHROJET for hydraulic chucks		
4385	1317		Spindle mounting flange HSK		
4386	1316		HSK spindle adaptors (in front)		
4387	1318		ISO taper/HSK-C basic adaptors for spindles to DIN 2079		
4397	1257		HSK-E collet holders		
4419	1162		Cooling adaptor set, complete		
4475	1226		HSK-E precision collet holders		
4476	1225		HSK-A precision collet holders		
4483	892	958	Fluteless taps with coolant ducts for ISO metric threads	HSS-E-PM	N
4484	896	958	Fluteless taps with coolant ducts for ISO metric fine threads	HSS-E-PM	N
4485	892	958	Fluteless taps with coolant ducts for ISO metric threads	HSS-E-PM	N
4486	895	958	Fluteless taps with coolant ducts for ISO metric fine threads	HSS-E-PM	N
4487	890	958	Fluteless taps for ISO metric threads	HSS-E-PM	N

Article no.	Page	Cutting data page	Description	Tool material	Type
4488	890	958	Fluteless taps for ISO metric threads	HSS-E-PM	N
4489	893	958	Fluteless taps for ISO metric fine threads	HSS-E-PM	N
4490	893	958	Fluteless taps for ISO metric fine threads	HSS-E-PM	N
4491	897	958	Fluteless taps for UNC threads	HSS-E-PM	N
4492	897	958	Fluteless taps for UNF threads	HSS-E-PM	N
4493	898	958	Fluteless taps for BSP threads	HSS-E-PM	N
4494	891	958	Fluteless taps for ISO metric threads	HSS-E-PM	N
4495	894	958	Fluteless taps for ISO metric fine threads	HSS-E-PM	N
4496	935	972	Micro thread milling cutters for ISO metric threads	Solid carbide	MTMH3 SP
4497	1245		ISO taper Weldon side lock holders		
4508	1203		MQL 1-channel coolant supply set HSK-A		
4511	1224		MQL 2-channel coolant supply set HSK-A		
4512	1327		SK / HSK-C basic adaptors		
4513	1203		MQL coolant supply set HSK-A (filler)		
4513	1224		MQL coolant supply set HSK-A (filler)		
4514	1328		MAS/BT / HSK-C basic adaptors		
4524	1201		MQL hydraulic synchro tapping chucks with straight shank		
4524	1221		MQL hydraulic synchro tapping chucks with straight shank		
4525	1175		Straight shank hydraulic synchro tapping chucks for internal cooling		
4549	1329		Extensions HSK-A/HSK-C		
4551	1323		Spring and threaded pin		
4554	1322		PowerClamp sets		
4555	1323		Threaded spindle		
4557	1323		Component parts for PowerClamp sets art. no. 4554		
4573	1228		Clamping nuts for precision collet holders		
4574	1227		Precision collets for precision collet holders		
4575	1227		Precision collets for precision collet holders, sealed		
4576	1174		ISO taper hydraulic synchro tapping chucks with internal cooling		
4577	1175		MAS/BT hydraulic synchro tapping chucks with internal cooling		
4581	1324		HSK spindle adaptors (in front)		Modul 4x4
4582	1326		HSK adaptors for turning centres		Modul 4x4
4584	1326		Spindle mounting flange HSK		Modul 6x6
4586	1325		HSK spindle adaptors (in front)		Modul 4x4
4596	1108		HSK-A hydraulic chucks, slim design 3°		
4597	1114		ISO taper hydraulic chucks, slim design 3°		
4598	1119		MAS/BT DC hydraulic chucks with axial plane		
4599	888	965	Taps for BSP threads	Solid carbide	H
4601	1174		HSK-A hydraulic synchro tapping chucks with internal cooling		
4602	1200		MQL 1-channel hydraulic synchro tapping chucks HSK-A (automatic tool change)		
4603	1220		MQL 2-channel hydraulic synchro tapping chucks HSK-A (automatic tool change)		
4604	1200		MQL hydraulic synchro tapping chucks HSK-A (manual tool change)		
4604	1220		MQL hydraulic synchro tapping chucks HSK-A (manual tool change)		
4605	1176		Reduction bushes, sealed, for hydraulic synchro tapping chucks		
4606	1178		Reduction bushes GÜHROJET for hydraulic synchro tapping chucks		
4607	888	965	Taps for BSP threads	HSS-E-PM	H
4611	1204		MQL 2-channel hydraulic chucks HSK-A (manual tool change)		
4612	1206		MQL 2-channel hydraulic chucks HSK-A (automatic tool change)		
4613	1208		MQL 2-channel shrink fit chucks HSK-A (manual tool change)		
4614	1211		MQL 2-channel shrink fit chucks HSK-A (automatic tool change)		
4615	1311		M contour clamping sets for MQL and IC		
4616	1312		Adaptor with spigot transition for M contour clamping set		
4617	1197		Sealing lips for MQL 1-channel length adjusting screws		
4618	1109		HSK-A hydraulic chucks HMC 3000		HMC 3000
4619	1115		ISO taper hydraulic chucks HMC 3000		HMC 3000
4620	1118		MAS/BT hydraulic chucks HMC 3000		HMC 3000
4621	1214		MQL 2-channel length adjusting screws for HSK-A		B
4622	1216		MQL 2-channel coolant supply set HSK-A (filler)		
4623	1218		MQL 2-channel coolant supply set HSK-A		
4624	1312		Assembly/disassembly tool for M contour clamping sets		
4625	753	958	Taps for ISO metric threads	HSS-E	VA R45
4626	753	958	Taps for ISO metric threads	HSS-E	VA R45
4627	753	958	Taps for ISO metric threads	HSS-E	VA R45
4628	757	958	Taps for ISO metric fine threads	HSS-E	VA R45
4629	754	958	Taps for ISO metric threads	HSS-E	VA L45
4630	754	958	Taps for ISO metric threads	HSS-E	VA R45
4631	758	958	Taps for ISO metric fine threads	HSS-E	VA R45
4632	762	958	Taps for BSP threads	HSS-E	VA R45
4633	752	958	Taps for ISO metric threads	HSS-E	VA R45
4634	755	958	Taps for ISO metric threads	HSS-E-PM	VA R45
4635	760	958	Taps for ISO metric fine threads	HSS-E-PM	VA R45
4636	756	958	Taps with coolant ducts for ISO metric threads	HSS-E-PM	VA R45
4637	760	958	Taps with coolant ducts for ISO metric fine threads	HSS-E-PM	VA R45

Article no.	Page	Cutting data page	Description	Tool material	Type
4638	743	958	Taps for ISO metric threads	HSS-E	VA
4639	743	958	Taps for ISO metric threads	HSS-E	VA
4640	743	958	Taps for ISO metric threads	HSS-E	VA
4641	747	958	Taps for ISO metric fine threads	HSS-E	VA
4642	749	958	Taps for UNC threads	HSS-E	VA
4643	749	958	Taps for UNF threads	HSS-E	VA
4644	744	958	Taps for ISO metric threads	HSS-E	VA
4645	742	958	Taps for ISO metric threads	HSS-E	VA
4646	745	958	Taps for ISO metric threads	HSS-E-PM	VA
4647	748	958	Taps for ISO metric fine threads	HSS-E-PM	VA
4648	746	958	Taps with coolant ducts for ISO metric threads	HSS-E-PM	VA
4649	748	958	Taps with coolant ducts for ISO metric fine threads	HSS-E-PM	VA
4650	755	958	Taps for ISO metric threads	HSS-E-PM	VA R45
4651	745	958	Taps for ISO metric threads	HSS-E-PM	VA
4662	1107		HSK-A hydraulic chucks		
4663	1113		ISO taper hydraulic chucks		
4664	1117		MAS/BT hydraulic chucks		
4665	1122		Reduction bushes, sealed, for hydraulic chucks		
4666			Hydraulic chuck set		
4670	832	963	Taps for ISO metric threads	HSS-E	N R45
4671	832	963	Taps for ISO metric threads	HSS-E	N R45
4672	777	963	Taps for ISO metric threads	HSS-E	N
4673	833	963	Taps for ISO metric threads	Solid carbide	N R15
4674	834	963	Taps for ISO metric threads	Solid carbide	N R15
4675	778	963	Taps for ISO metric threads	Solid carbide	N
4676	911	968	Fluteless taps for ISO metric threads	HSS-E	N
4677	913	968	Fluteless taps for ISO metric threads	HSS-E	N
4678	913	968	Fluteless taps for ISO metric threads	Solid carbide	N
4679	764	958	Taps for BSW threads	HSS-E	VA R45
4680	751	958	Taps for BSW threads	HSS-E	VA
4681	764	958	Taps for BSP threads	HSS-E	VA R45
4682	750	958	Taps for BSP threads	HSS-E	VA
4683	869	961	Taps for Rc (BSPT) threads	HSS-E-PM	H
4700	939	971	Circular drill thread milling cutters for UN threads	Solid carbide	MTMH3-Z
4703	891	958	Fluteless taps for ISO metric threads	HSS-E-PM	N
4704	894	958	Fluteless taps for ISO metric fine threads	HSS-E-PM	N
4705	892	958	Fluteless taps with coolant ducts for ISO metric threads	HSS-E-PM	N
4706	895	958	Fluteless taps with coolant ducts for ISO metric fine threads	HSS-E-PM	N
4707	892	958	Fluteless taps with coolant ducts for ISO metric threads	HSS-E-PM	N
4708	896	958	Fluteless taps with coolant ducts for ISO metric fine threads	HSS-E-PM	N
4709	1295		Module 4x4 BT alignment adaptors		
4712	1288		Module 6x6 BT alignment adaptors		
4713	1298		Module 4x4 HSK adaptor flanges		Modul 4x4
4713	1316		Module 4x4 HSK adaptor flanges		Modul 4x4
4714	1291		Module 6x6 HPC clamping chuck flanges		Modul 6x6
4715	1301		Angle alignment units f. mod. flanges /alignment adaptors		
4716	1300		Intermediate sleeves f. mod. flanges/alignment adaptors		
4717	1290		Module 6x6 shrink fit chuck flanges		Modul 6x6
4718	1148		Universal length pre-setting adaptors		
4719	1146		Shrink fit extensions		
4722	1289		Module 6x6 hydraulic chuck flanges		Modul 6x6
4723	1286		Module 6x6 HSK-A alignment adaptors		Modul 6x6
4724	1294		Module 4x4 ISO taper alignment adaptors		Modul 4x4
4725	1287		Module 6x6 ISO taper alignment adaptors		Modul 6x6
4726	1130		HSK-A shrink fit chucks TSG 3000		
4727	1138		ISO taper shrink fit chucks TSG 3000		
4728	1143		MAS/BT shrink fit chucks TSG 3000		
4729	1141		ISO taper shrink fit chucks GÜHROJET		
4730	1158		GSS 2000 Basic		GSS 2000
4735	1192		MQL 1-channel shrink fit chucks HSK-A (manual tool change)		
4736	1131		HSK-A shrink fit chucks		
4737	1136		HSK-E shrink fit chucks		
4738	1139		ISO taper shrink fit chucks		
4739	1145		MAS/BT shrink fit chucks		
4741	1194		MQL 1-channel shrink fit chucks HSK-A (automatic tool change)		
4742	1159		GSS 2000 Comfort version		GSS 2000
4743	1163		Induction coil		
4744	1161		ISO taper holders GSS 2000		GSS 2000
4745	1160		HSK holders GSS 2000		GSS 2000
4746	1167		Cable hoist		
4747	1166		SpeedCooler cooling system		
4748	1164		System cart		

Article no.	Page	Cutting data page	Description	Tool material	Type
4749	1165		Tongs		
4750	1165		Protective gloves		
4752	1158		GSS 2000 Eco-Plus		GSS 2000
4755	1133		HSK-A shrink fit chucks GÜHROJET with peripheral cooling		
4757	1163		Induction unit		GSS 2000
4758	1135		HSK-C shrink fit chucks		
4759	1166		Speed Cooler manager		
4760	1297		Module 4x4 shrink fit chuck flanges		Modul 4x4
4761	1160		HSK holders GSS 2000		GSS 2000
4762	1161		ISO taper holders GSS 2000		GSS 2000
4763	1164		Swivel compartments for GSS 2000		GSS 2000
4767	1167		Coolant protection		
4769	1162		Limit stop collars		
4770	931	972	Universal thread milling cutters for Rc threads	Solid carbide	TMU SP
4778	785	960	Taps for ISO metric fine threads	HSS-E	N
4779	839	960-961	Taps for ISO metric fine threads	HSS-E	N R40
4780	939	971	Circular drill thread milling cutters for BSP threads	Solid carbide	MTMH3-Z
4787	1134		HSK-A shrink fit chucks, slim design 3°		
4788	1142		ISO taper shrink fit chucks, slim design 3°		
4789	1137		HSK-E shrink fit chucks, slim design 3°		
4790	1144		MAS/BT DC shrink fit chucks with axial plane		
4791	773	961	Taps for ISO metric threads	HSS-E	H
4792	773	961	Taps for ISO metric threads	HSS-E	H
4793	789	961	Taps for ISO metric fine threads	HSS-E	H
4794	790	961	Taps for ISO metric fine threads	HSS-E	H
4795	801	961	Taps for ISO metric fine threads	HSS-E	H
4796	841	961	Taps for ISO metric fine threads	HSS-E	H R40
4797	867	961	Taps for BSP threads	HSS-E	H R40
4798	845	964	Taps for ISO metric fine threads	HSS-E	VA R40
4799	868	964	Taps for BSP threads	HSS-E	VA R40
4800	1273		ISO taper milling arbors		
4824	1243		ISO taper Weldon side lock holders GÜHROJET		
4827	1258		ISO taper collet holders DIN 69871		
4853	1247		ISO taper Whistle Notch side lock holders		
4857	884	962	Taps for UNC threads	HSS-E	GG
4858	886	962	Taps for UNF threads	HSS-E	GG
4859	887	962	Taps for BSP threads	HSS-E	GG
4860	759	958	Taps for ISO metric fine threads	HSS-E	VA R45
4861	763	958	Taps for BSP threads	HSS-E	VA R45
4900	1126		Adjusting screws		
4901	1262		Adjusting screws for HSK-C collet chuck holders		
4902	1261		Adjusting screws for HSK-A/HSK-E collet chucks holders		
4903	1250		Clamping screws		
4904	1151		Adjusting screws		
4904	1251		Adjusting screws		
4905	1252		Adjusting screws		
4907	1278		Screws DIN EN ISO 4762 (former DIN 912)		
4908	1278		Milling cutter retaining screws		
4909	1279		Socket wrenches for retaining screws		
4910	1343		Sockets		
4911	1343		Sockets		
4912	1353		Hexagon clamping keys		A
4913	1260		Clamping keys		C
4914	1344		Cleaning mandrels		
4915	155		Torque wrenches		
4915	216		Torque wrenches		
4915	1350		Torque wrenches		
4915	1540		Torque wrenches		
4916	1352		Socket/attachments		A
4917	155		Torx socket sets		
4917	217		Torx socket sets		
4918	1346		Cylindrical cleaning mandrels		
4919	1127		MQL length pre-adjusting screws for conversion		
4919	1152		MQL length pre-adjusting screws for conversion		
4921	1354		Hexagon-socket offset screw keys		
4922	1277		Drive dog sets for shell milling arbors		B
4923	1277		Feather key DIN 6885 A		
4924	1128		MQL coolant supply set with tube, HSK-A, for conversion		
4924	1153		MQL coolant supply set with tube, HSK-A, for conversion		
4925	1355		Pull studs ISO taper DIN ISO 7388-3 form AD		
4926	1355		Pull studs ISO taper DIN ISO 7388-3 form AF		
4927	1356		Pull studs BT DIN ISO 7388-3		

Article no.	Page	Cutting data page	Description	Tool material	Type
4928	1357		Pull studs BT DIN ISO 7388-3		
4930	1308		GÜHROCLAMP MQL 4-point clamping sets for MQL and IC		
4931	1309		GÜHROCLAMP fittings for MQL 4-point clamping sets, art. no. 4930		
4932	1309		GÜHROCLAMP ejector with tube		
4933	1310		Retention spindles for GÜHROCLAMP MQL 4-point clamp. sets		
4934	1310		Adaptor for GÜHROCLAMP MQL 4-point clamping sets		
4935	1311		Retention screw for GÜHROCLAMP MQL 4-point clamping sets		
4937	1196		MQL 1-channel length adjusting screws for HSK-A		B
4938	1149		Adjusting screws for GÜHROJET shrink fit chucks		
4939	1198		MQL 1-channel coolant supply set HSK-A		
4940	1197		MQL 1-channel coolant supply set HSK-A (filler)		
4941	1150		Length adjusting screw for conventional cooling		
4941	1199		Length adjusting screw for conventional cooling		
4941	1299		Length adjusting screw for conventional cooling		
4946	1348		Tool setting fixtures		
4947	1345		HSK cleaning cap		
4948	1198		MQL 1-channel length adjusting screws with sealing lip		
4949	1341		Coolant supply sets for conventional cooling		
4953	1331		Brass locking rings		
4955	1342		Data coding chip		
4958	1314		4-point clamping sets for conventional cooling		
4959	1315		Component parts f. 4-point clamp. set art. no. 4958, set		
4960	1540		Torx-Plus interchangeable blade		
4961	1332		Pressure ball screws		
4963	1321		Torque supports		
4966	216		Torque wrenches set		
4968	1333		Taper measuring gauge for HSK tool shanks		
4969	1335		Measuring gauges for HSK spindles		
4970	1336		ISO taper proofing bars		
4971	1336		HSK proofing bars		
4973	1338		Clamping force measuring instrument		
4974	1338		Clamping force measuring instrument		
4975	1337		Balancing masters for HSK spindles		
4976	1330		Centrifugal rings for short spindles to DIN 69002-3		
4977	1149		Shrink fit chuck length adjusting screws with axial force damping		
4978	1334		Measuring gauges for HSK clamping shoulders		
4979	1341		Coolant supply sets for conventional cooling with filter		
4981	1229		Torque wrenches		
4982	1284		HSK-C blanks		
4983	1283		HSK-A blanks		
4985	1347		HSK-C sealing plugs		
4986	1313		Assembly/disassembly tool for MQL and M-contour clamping sets		
4987	1350		Torque wrenches		
4988	1351		Torque wrenches		E
4989	1351		Torque wrenches		
4990	1348		Tool setting fixtures		
4991	1349		Interchangeable discs		
4993	1125		Plug inserts		
4994	1228		Roller spanner for precision collet holders		
4995	1229		Roller spanner insert for torque wrench		
5018	163	439	EB 80 single-fluted gun drills	Carbide	EB 80
5020	160	438	EB 100 single-fluted gun drills	Solid carbide	EB 100
5021	162	438	EB 100 single-fluted gun drills	Solid carbide	EB 100
5022	165	439	EB 80 single-fluted gun drills	Carbide	EB 80
5023	167	439	EB 80 single-fluted gun drills	Carbide	EB 80
5024	159	438	EB 100 single-fluted gun drills	Solid carbide	EB 100
5026	161	438	EB 100 single-fluted gun drills	Solid carbide	EB 100
5029	177	440	Outer inserts for single-fluted gun drills EB 800	Solid carbide	EB 800
5030	189	440	Guide pads for single-fluted gun drills EB 800	Solid carbide	EB 800
5164	170	439	EB 80 XXL single-fluted gun drills	Carbide	EB 80 XXL
5460	164	439	EB 80 single-fluted gun drills	Carbide	EB 80
5492	579	698	PCD slot drills (2-fluted)	PCD	H
5493	579	698	PCD slot drills (2-fluted)	PCD	H
5495	580	698	PCD slot drills (3-fluted)	PCD	H
5496	580	698	PCD slot drills (3-fluted)	PCD	H
5498	93	406	Ratio drills with coolant ducts	Solid carbide	RT 100 XF
5499	102	407	Ratio drills with coolant ducts	Solid carbide	RT 100 XF
5500	1064	1092	90° Countersinks SpyroTec	HSCO	
5501	1064	1092	90° Countersinks SpyroTec	HSCO	
5503	1065	1092	90° Countersinks SpyroTec	HSS	
5525	111	403	Ratio drills with coolant ducts	Solid carbide	RT 100 U
5538	1066	1092	90° Countersink sets SpyroTec	HSCO	

Article no.	Page	Cutting data page	Description	Tool material	Type
5539	1066	1092	90° Countersink sets SpyroTec	HSCO	
5632	159	438	EB 100 single-fluted gun drills	Solid carbide	EB 100
5633	160	438	EB 100 single-fluted gun drills	Solid carbide	EB 100
5637	161	438	EB 100 single-fluted gun drills	Solid carbide	EB 100
5638	162	438	EB 100 single-fluted gun drills	Solid carbide	EB 100
5639	163	439	EB 80 single-fluted gun drills	Carbide	EB 80
5640	164	439	EB 80 single-fluted gun drills	Carbide	EB 80
5641	166	439	EB 80 single-fluted gun drills	Carbide	EB 80
5642	168	439	EB 80 single-fluted gun drills	Carbide	EB 80
5644	173	440	EB 800 single-fluted gun drills with interchangeable inserts	Carbide	EB 800
5646	156	438	EB 100 M single-fluted gun drills	Solid carbide	EB 100 M
5647	157	438	EB 100 M single-fluted gun drills	Solid carbide	EB 100 M
5648	158	438	EB 100 M single-fluted gun drills	Solid carbide	EB 100 M
5650	85	401	Ratio drills with coolant ducts	Solid carbide	RT 100 U
5651	66	398	Ratio drills without coolant ducts	Solid carbide	RT 100 U
5665	201	440	Inner inserts for single-fluted gun drills EB 800	Solid carbide	EB 800
5666	202	440	Inner inserts for single-fluted gun drills EB 800	Solid carbide	EB 800
5667	201	440	Inner inserts for single-fluted gun drills EB 800	Solid carbide	EB 800
5668	202	440	Inner inserts for single-fluted gun drills EB 800	Solid carbide	EB 800
5669	166	439	EB 80 single-fluted gun drills	Carbide	EB 80
5670	1074	1092	60° Countersinks SpyroTec	HSS	
5671	1074	1092	60° Countersinks SpyroTec	HSS	
5672	1075	1092	60° Countersink sets SpyroTec	HSS	
5673	1075	1092	60° Countersink sets SpyroTec	HSS	
5674	1078	1092	82° Countersinks SpyroTec	HSCO	
5675	1078	1092	82° Countersinks SpyroTec	HSCO	
5676	1079	1092	82° Countersink sets SpyroTec	HSCO	
5677	1079	1092	82° Countersink sets SpyroTec	HSCO	
5681	171	439	EB 80 XXL single-fluted gun drills	Carbide	EB 80 XXL
5682	172	439	EB 80 XXL single-fluted gun drills	Carbide	EB 80 XXL
5685	156	438	EB 100 M single-fluted gun drills	Solid carbide	EB 100 M
5686	157	438	EB 100 M single-fluted gun drills	Solid carbide	EB 100 M
5687	158	438	EB 100 M single-fluted gun drills	Solid carbide	EB 100 M
5688	169	439	EB 80 XXL single-fluted gun drills	Carbide	EB 80 XXL
5689	165	439	EB 80 single-fluted gun drills	Carbide	EB 80
5690	167	439	EB 80 single-fluted gun drills	Carbide	EB 80
5691	169	439	EB 80 XXL single-fluted gun drills	Carbide	EB 80 XXL
5692	170	439	EB 80 XXL single-fluted gun drills	Carbide	EB 80 XXL
5693	171	439	EB 80 XXL single-fluted gun drills	Carbide	EB 80 XXL
5694	172	439	EB 80 XXL single-fluted gun drills	Carbide	EB 80 XXL
5702	180	440	Outer inserts for single-fluted gun drills EB 800	Solid carbide	EB 800
5703	192	440	Guide pads for single-fluted gun drills EB 800	Solid carbide	EB 800
5704	183	440	Outer inserts for single-fluted gun drills EB 800	Solid carbide	EB 800
5705	195	440	Guide pads for single-fluted gun drills EB 800	Solid carbide	EB 800
5706	186	440	Outer inserts for single-fluted gun drills EB 800	Solid carbide	EB 800
5707	198	440	Guide pads for single-fluted gun drills EB 800	Solid carbide	EB 800
5747	204		Drill bushes	HSS	
5748	203		Drill bushes	Solid carbide	
5749	206		Steady rest bushings	Plastic	
5750	208		Moulded steady rest bushings for single-fluted gun drills	Plastic	
5752	211		Sealing washers für single-fluted gun drills	Plastic	
5754	214		Adjustment screws		
5755	214		Adjustment screws		
5766	215		Sealing plugs	Steel	
5767	210		Moulded steady rest bushings for single-fluted gun drills	Plastic	
5768	95	409	Ratio drills with coolant ducts	Solid carbide	RT 100 AI
5770	212		Sealing washers für single-fluted gun drills	Plastic-metall	
5772	213		Sealing washers für single-fluted gun drills	Plastic	
6005	218	441	Twist drills with standard shank	HSS-E-PM	GU 500 PM
6006	220	441	Twist drills with standard shank	HSS-E-PM	GU 500 PM
6017	995	1042-1043	NC machine reamers	Solid carbide	
6018	996	1042-1043	NC machine reamers	Solid carbide	
6023	71	400	Ratio drills with coolant ducts	Solid carbide	RT 100 U
6024	77	408	Ratio drills with coolant ducts	Solid carbide	RT 100 VA
6025	91	408	Ratio drills with coolant ducts	Solid carbide	RT 100 VA
6026	59	397	Ratio drills without coolant ducts	Solid carbide	RT 100 U
6027	364	479	90° NC spotting drills	Solid carbide	N
6028	367	479	120° NC spotting drills	Solid carbide	N
6029	369	479	142° NC spotting drills	Solid carbide	N
6030	328		Short flute drill sets	M42	H
6068	82	415	Ratio drills with coolant ducts	Solid carbide	RT 150 GG
6069	107	416	Ratio drills with coolant ducts	Solid carbide	RT 150 GG

Article no.	Page	Cutting data page	Description	Tool material	Type
6070	109	417	Ratio drills with coolant ducts	Solid carbide	RT 150 GG
6128	154		Clamping screws		
6400	38	386	ExclusiveLine micro-precision drills without coolant ducts	Solid carbide	N
6401	39	386	ExclusiveLine micro-precision drills without coolant ducts	Solid carbide	N
6405	40	386	ExclusiveLine micro-precision drills with coolant ducts	Solid carbide	N
6408	41	387	ExclusiveLine micro-precision drills with coolant ducts	Solid carbide	N
6412	42	387	ExclusiveLine micro-precision drills with coolant ducts	Solid carbide	N
6478	524	680	Ratio end mills RF 100 Sharp	Solid carbide	N
6479	524	680	Ratio end mills RF 100 Sharp	Solid carbide	N
6480	525	680	Ratio end mills RF 100 Sharp	Solid carbide	N
6481	525	680	Ratio end mills RF 100 Sharp	Solid carbide	N
6487	43	388	ExclusiveLine micro-precision drills VA without coolant ducts	Solid carbide	VA
6488	44	389	ExclusiveLine micro-precision drills VA with coolant ducts	Solid carbide	VA
6489	45	389	ExclusiveLine micro-precision drills VA with coolant ducts	Solid carbide	VA
6490	46	390	ExclusiveLine micro-precision drills VA with coolant ducts	Solid carbide	VA
6491	47	390	ExclusiveLine micro-precision drills VA with coolant ducts	Solid carbide	VA
6493	48	391	ExclusiveLine micro-precision drills XL with coolant ducts	Solid carbide	N
6498	79	406	Ratio drills with coolant ducts	Solid carbide	RT 100 XF
6499	112	407	Ratio drills with coolant ducts	Solid carbide	RT 100 XF
6501	97	410	Ratio drills with coolant ducts	Solid carbide	RT 100 R
6502	104	411	Ratio drills with coolant ducts	Solid carbide	RT 100 R
6503	357	477	Centre drills without flat	HSCO	N
6504	360	478	Centre drills without flat	HSS	N
6509	117	420	Ratio drills with coolant ducts	Solid carbide	RT 100 T
6511	118	421	Ratio drills with coolant ducts	Solid carbide	RT 100 T
6512	119	422	Ratio drills with coolant ducts	Solid carbide	RT 100 T
6513	120	423	Ratio drills with coolant ducts	Solid carbide	RT 100 T
6514	121	424	Ratio drills with coolant ducts	Solid carbide	RT 100 T
6515	114	419	Ratio drills with coolant ducts	Solid carbide	RT 100 T AL
6516	115	419	Ratio drills with coolant ducts	Solid carbide	RT 100 T AL
6517	116	419	Ratio drills with coolant ducts	Solid carbide	RT 100 T AL
6590	126	427	Ratio drills with coolant ducts, 3-fluted	Solid carbide	FT 200 U
6596	55	396	Pilot drills with coolant ducts	Solid carbide	RT 100 FB
6702	561	696	Ratio end mills Alu RF 100 A	Solid carbide	W
6703	564	696	Ratio end mills Alu RF 100 A	Solid carbide	W
6706	528	682	Standard Ratio end mills RF 100 U	Solid carbide	N
6707	542	682	Ratio end mills RF 100 VA	Solid carbide	N
6708	542	682	Ratio end mills RF 100 VA	Solid carbide	N
6709	555	682	Ratio end mills Superfinish RF 100 SF	Solid carbide	NH
6710	555	682	Ratio end mills Superfinish RF 100 SF	Solid carbide	NH
6711	585	690	60° Chamfering milling cutters	Solid carbide	N
6712	585	690	60° Chamfering milling cutters	Solid carbide	N
6713	584	690	90° Chamfering milling cutters	Solid carbide	N
6714	586	690	120° Chamfering milling cutters	Solid carbide	N
6715	586	690	120° Chamfering milling cutters	Solid carbide	N
6716	523	676	Pilot end mills RF 100 P	Solid carbide	NH
6717	578	698	Kevlar end mills CR 100	Solid carbide	CR 100
6719	578	698	Kevlar end mills CR 100	Solid carbide	CR 100
6720	578	698	Kevlar end mills CR 100	Solid carbide	CR 100
6721	573	698	Slot drills XL (3-fluted)	Solid carbide	N
6722	574	698	Slot drills with corner radius (2-fluted)	Solid carbide	N
6723	574	698	End mills with corner radius (4-fluted)	Solid carbide	N
6724	575	698	Ball nose slot drills (2-fluted)	Solid carbide	N
6725	575	698	Ball nose end mills (4-fluted)	Solid carbide	N
6726	530	682	Standard Ratio end mills RF 100 U	Solid carbide	N
6727	554	682	Ratio end mills Superfinish RF 100 SF	Solid carbide	NH
6728	511	682	Standard Ratio end mills RF 100 U (3-fluted)	Solid carbide	N
6729	563	696	Ratio end mills Alu RF 100 A	Solid carbide	W
6730	564	696	Ratio end mills Alu RF 100 A	Solid carbide	W
6731	564	696	Ratio end mills Alu RF 100 A	Solid carbide	W
6732	565	696	Ratio end mills Alu RF 100 A	Solid carbide	W
6733	565	696	Ratio end mills Alu RF 100 A	Solid carbide	W
6734	565	696	Ratio end mills Alu RF 100 A	Solid carbide	W
6735	565	696	Ratio end mills Alu RF 100 A	Solid carbide	W
6736	520	676	Ratio end mills RF 100 Diver	Solid carbide	NH
6737	520	676	Ratio end mills RF 100 Diver	Solid carbide	NH
6754	522	676	Ratio end mill sets RF 100 Diver	Solid carbide	N
6755	522	676	Ratio end mill sets RF 100 Diver	Solid carbide	N
6756	650	706	Roughing end mills GS 80 (fine teeth)	HSS-E-PM	NRf
6760	548	678	Ratio end mills RF 100 Speed M	Solid carbide	NH
6761	548	678	Ratio end mills RF 100 Speed M	Solid carbide	NH
6762	566	696	90° Ratio end mills Alu RF 100 A	Solid carbide	W

Article no.	Page	Cutting data page	Description	Tool material	Type
6763	556	682	90° Ratio end mills Superfinish RF 100 SF	Solid carbide	NH
6764	547	682	90° Ratio end mills RF 100 F	Solid carbide	NH
6765	548	678	Ratio end mills RF 100 Speed M	Solid carbide	NH
6766	548	678	Ratio end mills RF 100 Speed M	Solid carbide	NH
6767	533	682	Standard Ratio end mills RF 100 U	Solid carbide	NH
6768	533	682	Standard Ratio end mills RF 100 U	Solid carbide	NH
6769	576	698	Kevlar end mills FR 100	Solid carbide	FR 100
6770	577	698	Kevlar end mills FR 100	Solid carbide	FR 100
6778	549	678	Ratio end mill sets RF 100 Speed M	Solid carbide	NH
6780	549	678	Ratio end mill sets RF 100 Speed M	Solid carbide	NH
6784	584	690	90° Chamfering milling cutters	Solid carbide	H
6785	584	690	90° Chamfering milling cutters	Solid carbide	H
6786	583	690	90° Chamfering milling cutters	Solid carbide	N
6787	583	690	90° Chamfering milling cutters	Solid carbide	N
6788	587	690	Quadrant milling cutters	Solid carbide	N
6793	571	696	End mills (single-fluted)	Solid carbide	W
6797	517	676	Ratio end mills RF 100 Diver (3-fluted)	Solid carbide	NH
6798	517	676	Ratio end mills RF 100 Diver (3-fluted)	Solid carbide	NH
6799	518	676	Ratio end mills RF 100 Diver (3-fluted)	Solid carbide	NH
6800	518	676	Ratio end mills RF 100 Diver (3-fluted)	Solid carbide	NH
6801	521	676	Ratio end mills RF 100 Diver	Solid carbide	N
6802	521	676	Ratio end mills RF 100 Diver	Solid carbide	N
6803	519	676	Ratio end mills RF 100 Diver	Solid carbide	N
6804	519	676	Ratio end mills RF 100 Diver	Solid carbide	N
6805	576	698	Kevlar end mills FR 100	Solid carbide	FR 100
6806	577	698	Kevlar end mills FR 100	Solid carbide	FR 100
6808	516	692	Ratio end mills RF 100 Micro Diver	Solid carbide	NH
6809	516	694	Ratio end mills RF 100 Micro Diver	Solid carbide	NH
6810	585	690	60° Chamfering milling cutters SpyroTec	Solid carbide	N
6811	585	690	60° Chamfering milling cutters SpyroTec	Solid carbide	N
6812	586	690	120° Chamfering milling cutters SpyroTec	Solid carbide	N
6813	586	690	120° Chamfering milling cutters SpyroTec	Solid carbide	N
6814	614	699	High-feed end mills G-Mold 65 HF	Solid carbide	H
6815	588	700	Ball nose end mills G-Mold μ 65 B	Solid carbide	H
6816	589	700	Ball nose end mills G-Mold μ 65 B	Solid carbide	H
6817	590	700	Ball nose end mills G-Mold μ 65 B	Solid carbide	H
6818	591	700	Ball nose end mills G-Mold μ 65 B	Solid carbide	H
6819	592	700	Ball nose end mills G-Mold μ 65 B	Solid carbide	H
6820	602	702	Torus end mills G-Mold μ 65 T	Solid carbide	NH
6821	603	702	Torus end mills G-Mold μ 65 T	Solid carbide	NH
6822	604	702	Torus end mills G-Mold μ 65 T	Solid carbide	N
6823	605	702	Torus end mills G-Mold μ 65 T	Solid carbide	N
6824	606	702	Torus end mills G-Mold μ 65 T	Solid carbide	N
6825	622	686	Finishing end mills G-Mold μ 48 F	Solid carbide	NH
6826	622	686	Finishing end mills G-Mold μ 48 F	Solid carbide	NH
6827	618	686	Finishing end mills G-Mold μ 65 F	Solid carbide	H
6828	618	686	Finishing end mills G-Mold μ 65 F	Solid carbide	H
6829	515	686	Micro-precision milling cutter MicroMill μ 55 U	Solid carbide	N
6830	614	699	High-feed end mills G-Mold 65 HF	Solid carbide	H
6831	615	699	High-feed end mills G-Mold 65 HF	Solid carbide	H
6832	593	700	Ball nose end mills G-Mold 65 B	Solid carbide	H
6833	593	700	Ball nose end mills G-Mold 65 B	Solid carbide	H
6834	594	700	Ball nose end mills G-Mold 65 B	Solid carbide	N
6835	594	700	Ball nose end mills G-Mold 65 B	Solid carbide	H
6836	595	700	Ball nose end mills G-Mold 65 B	Solid carbide	H
6837	607	702	Torus end mills G-Mold 65 T	Solid carbide	H
6838	608	702	Torus end mills G-Mold 65 T	Solid carbide	NH
6844	596	700	Ball nose end mills G-Mold 55 B	Solid carbide	N
6845	596	700	Ball nose end mills G-Mold 55 B	Solid carbide	N
6846	597	700	Ball nose end mills G-Mold 55 B	Solid carbide	N
6847	597	700	Ball nose end mills G-Mold 55 B	Solid carbide	N
6848	598	700	Ball nose end mills G-Mold 55 B	Solid carbide	N
6849	598	700	Ball nose end mills G-Mold 55 B	Solid carbide	N
6850	609	702	Torus end mills G-Mold 55 T	Solid carbide	NH
6851	610	702	Torus end mills G-Mold 55 T	Solid carbide	NH
6852	611	702	Torus end mills G-Mold 55 T	Solid carbide	NH
6853	611	702	Torus end mills G-Mold 55 T	Solid carbide	NH
6854	612	702	Torus end mills G-Mold 55 T	Solid carbide	N
6855	613	702	Torus end mills G-Mold 55 T	Solid carbide	N
6856	551	678	Ratio end mills RF 100 5 Speed	Solid carbide	N
6857	551	678	Ratio end mills RF 100 5 Speed	Solid carbide	N
6858	551	678	Ratio end mills RF 100 5 Speed	Solid carbide	N

Article no.	Page	Cutting data page	Description	Tool material	Type
6859	551	678	Ratio end mills RF 100 5 Speed	Solid carbide	N
6860	552	678	Ratio end mills RF 100 5 Speed	Solid carbide	N
6861	552	678	Ratio end mills RF 100 5 Speed	Solid carbide	N
6864	553	678	Ratio end mills RF 100 7 Speed	Solid carbide	N
6865	553	678	Ratio end mills RF 100 7 Speed	Solid carbide	N
6866	568	697	Ratio roughing end mills Alu RF 100 A	Solid carbide	WF
6868	569	697	Ratio roughing end mills Alu RF 100 A	Solid carbide	WF
6869	569	697	Ratio roughing end mills Alu RF 100 A	Solid carbide	WF
6870	570	697	Ratio roughing end mills Alu RF 100 A	Solid carbide	WF
6871	570	697	Ratio roughing end mills Alu RF 100 A	Solid carbide	WF
6877	543	684	Ratio roughing end mills RF 100 VA	Solid carbide	NF
6878	543	684	Ratio roughing end mills RF 100 VA	Solid carbide	NF
6879	543	684	Ratio roughing end mills RF 100 VA	Solid carbide	NF
6880	543	684	Ratio roughing end mills RF 100 VA	Solid carbide	NF
6881	535	684	Ratio roughing end mills RF 100 U	Solid carbide	HF
6882	535	684	Ratio roughing end mills RF 100 U	Solid carbide	HF
6883	535	684	Ratio roughing end mills RF 100 U	Solid carbide	HF
6884	535	684	Ratio roughing end mills RF 100 U	Solid carbide	HF
6885	536	684	Ratio roughing end mills RF 100 U	Solid carbide	HF
6886	536	684	Ratio roughing end mills RF 100 U	Solid carbide	HF
6887	537	684	High-performance roughing end mills RS 100 U	Solid carbide	NF
6888	537	684	High-performance roughing end mills RS 100 U	Solid carbide	NF
6889	538	684	High-performance roughing end mills RS 100 F	Solid carbide	NF
6890	538	684	High-performance roughing end mills RS 100 F	Solid carbide	NF
6943	616	682	Ratio end mills G-Mold 65 U	Solid carbide	H
6944	616	682	Ratio end mills G-Mold 65 U	Solid carbide	H
6945	619	686	Finishing end mills G-Mold 65 F	Solid carbide	H
6946	619	686	Finishing end mills G-Mold 65 F	Solid carbide	H
6947	620	686	Finishing end mills with corner radius G-Mold 65 FR	Solid carbide	H
6948	621	686	Finishing end mills with corner radius G-Mold 65 FR	Solid carbide	H
6958	550	678	Ratio end mills RF 100 Speed P	Solid carbide	NH
6959	550	678	Ratio end mills RF 100 Speed P	Solid carbide	NH
6960	550	678	Ratio end mills RF 100 Speed P	Solid carbide	NH
6961	550	678	Ratio end mills RF 100 Speed P	Solid carbide	NH
6962	526	680	Ratio end mills RF 100 Sharp	Solid carbide	N
6963	526	680	Ratio end mills RF 100 Sharp	Solid carbide	N
6964	527	682	Ratio end mills RF 100 iMill	Solid carbide	N
6965	527	682	Ratio end mills RF 100 iMill	Solid carbide	N
6966	545	682	Ratio end mills RF 100 Ti	Solid carbide	N
6967	545	682	Ratio end mills RF 100 Ti	Solid carbide	N
6968	546	682	Ratio end mills RF 100 F	Solid carbide	NH
6969	623	686	Multi-tooth end mills GH 100 U	Solid carbide	NH
6970	534	684	Ratio roughing end mills RF 100 U	Solid carbide	HRf
6971	534	684	Ratio roughing end mills RF 100 U	Solid carbide	HRf
6972	534	684	Ratio roughing end mills RF 100 U	Solid carbide	HRf
6973	534	684	Ratio roughing end mills RF 100 U	Solid carbide	HRf
6974	567	697	Ratio roughing end mills Alu RF 100 A	Solid carbide	WF
6975	567	697	Ratio roughing end mills Alu RF 100 A	Solid carbide	WF
6976	568	697	Ratio roughing end mills Alu RF 100 A	Solid carbide	WF
6977	568	697	Ratio roughing end mills Alu RF 100 A	Solid carbide	W
6978	560	696	Ratio end mills Alu RF 100 A	Solid carbide	W
6979	560	696	Ratio end mills Alu RF 100 A	Solid carbide	W
6980	559	696	Ratio end mills Alu RF 100 A	Solid carbide	W
6981	559	696	Ratio end mills Alu RF 100 A	Solid carbide	W
6982	562	696	Ratio end mills Alu RF 100 A	Solid carbide	W
6983	562	696	Ratio end mills Alu RF 100 A	Solid carbide	W
6984	571	700	Ball nose end mills GA 200 A	Solid carbide	W
6992	583	690	90° Chamfering milling cutters SpyroTec	Solid carbide	N
6993	583	690	90° Chamfering milling cutters SpyroTec	Solid carbide	N
6996	371	480	Spot weld drills	HSCO	N
7632	153		Indexable inserts	Solid carbide	CPGW
7635	153		Indexable inserts	Solid carbide	CPGT
7645	153		Indexable inserts	Solid carbide	CPGT
8510	75	408	Ratio drills with coolant ducts	Solid carbide	RT 100 VA
8511	89	408	Ratio drills with coolant ducts	Solid carbide	RT 100 VA
8520	73	404	Ratio drills with coolant ducts	Solid carbide	RT 100 HF
8521	87	404	Ratio drills with coolant ducts	Solid carbide	RT 100 HF
8522	101	405	Ratio drills with coolant ducts	Solid carbide	RT 100 HF
8524	62	399	Ratio drills without coolant ducts	Solid carbide	RT 100 HF
8610	75	408	Ratio drills with coolant ducts	Solid carbide	RT 100 VA
8611	89	408	Ratio drills with coolant ducts	Solid carbide	RT 100 VA
8620	73	404	Ratio drills with coolant ducts	Solid carbide	RT 100 HF

Article no.	Page	Cutting data page	Description	Tool material	Type
8621	87	404	Ratio drills with coolant ducts	Solid carbide	RT 100 HF
9000	279	456	Jobber drills	HSCO	GU 3FS
9001	327		Twist drill sets	HSCO	GU 3FS
9670	310	468-469	Extra length twist drills, series 1	HSCO	GT 100
9671	313	468-469	Extra length twist drills, series 2	HSCO	GT 100
9672	316	468-469	Extra length twist drills, series 3	HSCO	GT 100
25000	1475		Round shank holders, clamping screw above		GB104
25001	1479		Round shank holders, clamping screw lateral		GB104
25002	1519		Square shank holders, 90° offset		GH104
25003	1519		Square shank holders, 90° offset		GH104
25004	1523		Square shank holders 90° offset and stepped, without IC		GH104
25005	1524		Square shank holders 90° offset and stepped, with IC		GH104
25006	1502		Round shank holders for broaching		GB104
25010	1506		Polygon shank holders, according to ISO 26623, straight 0°		GH104
25012	1509		Polygon shank holders, according to ISO 26623, offset 90°		GH104
25013	1509		Polygon shank holders, according to ISO 26623, offset 90°		GH104
25016	1512		HSK-T holders, according to ISO 12164-3, straight 0°		GH104
25017	1488		Round shank holders, clamping screw above, without clamping surfaces		GB104
25018	1483		Round shank holders, clamping screw above, four clamping surfaces		GB104
25019	1515		Square shank holders, straight 0°		GH104
25020	1515		Square shank holders, straight 0°		GH104
25021	1491		Round shank holders, clamping screw above, for Citizen machine		GB104
25022	1494		Round shank holders, clamping screw above, for Star machine		GB104
25023	1497		Round shank holders, clamping screw above, for Tornos machine		GB104
25024	1499		Round shank holders, for machine type Star, rear side machining		GB104
25052	1424	1553	Cutting inserts for boring out and profiling	Solid carbide	GT104
25053	1424	1553	Cutting inserts for boring out and profiling	Solid carbide	GT104
25056	1424	1553	Cutting inserts for boring out and profiling	Solid carbide	GT104
25057	1424	1553	Cutting inserts for boring out and profiling	Solid carbide	GT104
25060	1440	1553	Cutting inserts for boring out and profiling	Solid carbide	GT104
25061	1440	1553	Cutting inserts for boring out and profiling	Solid carbide	GT104
25064	1440	1553	Cutting inserts for boring out and profiling	Solid carbide	GT104
25065	1440	1553	Cutting inserts for boring out and profiling	Solid carbide	GT104
25068	1429	1553	Cutting inserts for boring out and profiling	Solid carbide	GT104
25069	1429	1553	Cutting inserts for boring out and profiling	Solid carbide	GT104
25072	1429	1553	Cutting inserts for boring out and profiling	Solid carbide	GT104
25073	1429	1553	Cutting inserts for boring out and profiling	Solid carbide	GT104
25076	1441	1553	Cutting inserts for boring out and profiling	Solid carbide	GT104
25077	1441	1553	Cutting inserts for boring out and profiling	Solid carbide	GT104
25080	1441	1553	Cutting inserts for boring out and profiling	Solid carbide	GT104
25081	1441	1553	Cutting inserts for boring out and profiling	Solid carbide	GT104
25084	1437	1553	Cutting inserts for boring out and profiling	Solid carbide	GT104
25085	1437	1553	Cutting inserts for boring out and profiling	Solid carbide	GT104
25088	1437	1553	Cutting inserts for boring out and profiling	Solid carbide	GT104
25089	1437	1553	Cutting inserts for boring out and profiling	Solid carbide	GT104
25092	1442	1553	Cutting inserts for boring out and profiling	Solid carbide	GJ104
25093	1442	1553	Cutting inserts for boring out and profiling	Solid carbide	GJ104
25096	1442	1553	Cutting inserts for boring out and profiling	Solid carbide	GJ104
25097	1442	1553	Cutting inserts for boring out and profiling	Solid carbide	GJ104
25108	1446	1558	Cutting inserts for back boring and profiling	Solid carbide	GT104
25109	1446	1558	Cutting inserts for back boring and profiling	Solid carbide	GT104
25112	1446	1558	Cutting inserts for back boring and profiling	Solid carbide	GT104
25113	1446	1558	Cutting inserts for back boring and profiling	Solid carbide	GT104
25116	1451	1561	Cutting inserts for boring out and chamfering	Solid carbide	GT104
25117	1451	1561	Cutting inserts for boring out and chamfering	Solid carbide	GT104
25120	1451	1561	Cutting inserts for boring out and chamfering	Solid carbide	GT104
25121	1451	1561	Cutting inserts for boring out and chamfering	Solid carbide	GT104
25126	1393	1544	Cutting inserts for internal grooving, flat bottom slots	Solid carbide	GE104
25127	1393	1544	Cutting inserts for internal grooving, flat bottom slots	Solid carbide	GE104
25130	1393	1544	Cutting inserts for internal grooving, flat bottom slots	Solid carbide	GE104
25131	1393	1544	Cutting inserts for internal grooving, flat bottom slots	Solid carbide	GE104
25134	1398	1544	Cutting inserts for internal grooving, full radius slots	Solid carbide	GE104
25135	1398	1544	Cutting inserts for internal grooving, full radius slots	Solid carbide	GE104
25138	1398	1544	Cutting inserts for internal grooving, full radius slots	Solid carbide	GE104
25139	1398	1544	Cutting inserts for internal grooving, full radius slots	Solid carbide	GE104
25142	1403	1544	Cutting inserts for internal pre-grooving and chamfering	Solid carbide	GV104
25143	1403	1544	Cutting inserts for internal pre-grooving and chamfering	Solid carbide	GV104
25146	1403	1544	Cutting inserts for internal pre-grooving and chamfering	Solid carbide	GV104
25147	1403	1544	Cutting inserts for internal pre-grooving and chamfering	Solid carbide	GV104
25150	1455	1564	Cutting inserts for internal threading, part profile - metric standard threads	Solid carbide	GG104
25151	1455	1564	Cutting inserts for internal threading, part profile - metric standard threads	Solid carbide	GG104
25154	1455	1564	Cutting inserts for internal threading, part profile - metric standard threads	Solid carbide	GG104

Article no.	Page	Cutting data page	Description	Tool material	Type
25155	1455	1564	Cutting inserts for internal threading, part profile - metric standard threads	Solid carbide	GG104
25158	1458	1564	Cutting inserts for internal threading, part profile - metric fine threads	Solid carbide	GG104
25159	1458	1564	Cutting inserts for internal threading, part profile - metric fine threads	Solid carbide	GG104
25162	1458	1564	Cutting inserts for internal threading, part profile - metric fine threads	Solid carbide	GG104
25163	1458	1564	Cutting inserts for internal threading, part profile - metric fine threads	Solid carbide	GG104
25166	1459	1564	Cutting inserts for internal threading, full profile - metric standard threads	Solid carbide	GG104
25167	1459	1564	Cutting inserts for internal threading, full profile - metric standard threads	Solid carbide	GG104
25170	1459	1564	Cutting inserts for internal threading, full profile - metric standard threads	Solid carbide	GG104
25171	1459	1564	Cutting inserts for internal threading, full profile - metric standard threads	Solid carbide	GG104
25174	1462	1564	Cutting inserts for internal threading, part profile - UN threads	Solid carbide	GG104
25175	1462	1564	Cutting inserts for internal threading, part profile - UN threads	Solid carbide	GG104
25178	1462	1564	Cutting inserts for internal threading, part profile - UN threads	Solid carbide	GG104
25179	1462	1564	Cutting inserts for internal threading, part profile - UN threads	Solid carbide	GG104
25182	1463	1564	Cutting inserts for internal threading, full profile - Whitworth pipe threads	Solid carbide	GG104
25183	1463	1564	Cutting inserts for internal threading, full profile - Whitworth pipe threads	Solid carbide	GG104
25186	1463	1564	Cutting inserts for internal threading, full profile - Whitworth pipe threads	Solid carbide	GG104
25187	1463	1564	Cutting inserts for internal threading, full profile - Whitworth pipe threads	Solid carbide	GG104
25190	1408	1550	Cutting inserts for axial grooving, flat bottom slots	Solid carbide	GA104
25191	1408	1550	Cutting inserts for axial grooving, flat bottom slots	Solid carbide	GA104
25194	1408	1550	Cutting inserts for axial grooving, flat bottom slots	Solid carbide	GA104
25195	1408	1550	Cutting inserts for axial grooving, flat bottom slots	Solid carbide	GA104
25198	1410	1550	Cutting inserts for axial grooving bores, full radius slots	Solid carbide	GA104
25199	1410	1550	Cutting inserts for axial grooving bores, full radius slots	Solid carbide	GA104
25202	1410	1550	Cutting inserts for axial grooving bores, full radius slots	Solid carbide	GA104
25203	1410	1550	Cutting inserts for axial grooving bores, full radius slots	Solid carbide	GA104
25206	1412	1550	Cutting inserts for axial grooving studs, flat bottom slots	Solid carbide	GA104
25207	1412	1550	Cutting inserts for axial grooving studs, flat bottom slots	Solid carbide	GA104
25210	1412	1550	Cutting inserts for axial grooving studs, flat bottom slots	Solid carbide	GA104
25211	1412	1550	Cutting inserts for axial grooving studs, flat bottom slots	Solid carbide	GA104
25214	1414	1550	Cutting inserts for axial grooving studs, full radius slots	Solid carbide	GA104
25215	1414	1550	Cutting inserts for axial grooving studs, full radius slots	Solid carbide	GA104
25218	1414	1550	Cutting inserts for axial grooving studs, full radius slots	Solid carbide	GA104
25219	1414	1550	Cutting inserts for axial grooving studs, full radius slots	Solid carbide	GA104
25222	1416	1550	Cutting inserts for axial chamfering bores	Solid carbide	GA104
25223	1416	1550	Cutting inserts for axial chamfering bores	Solid carbide	GA104
25226	1416	1550	Cutting inserts for axial chamfering bores	Solid carbide	GA104
25227	1416	1550	Cutting inserts for axial chamfering bores	Solid carbide	GA104
25229	1469	1566	Cutting inserts for internal hexagon	Solid carbide	GN104
25231	1469	1566	Cutting inserts for internal hexagon	Solid carbide	GN104
25233	1471	1566	Cutting inserts for internal square	Solid carbide	GN104
25235	1471	1566	Cutting inserts for internal square	Solid carbide	GN104
25237	1472	1566	Cutting inserts for Torx	Solid carbide	GN104
25239	1472	1566	Cutting inserts for Torx	Solid carbide	GN104
25300	1476		Round shank holders, clamping screw above		GB106
25301	1480		Round shank holders, clamping screw lateral		GB106
25302	1503		Round shank holders for broaching		GB106
25303	1523		Square shank holders 90° offset and stepped, without IC		GH106
25304	1520		Square shank holders, 90° offset		GH106
25305	1520		Square shank holders, 90° offset		GH106
25306	1524		Square shank holders 90° offset and stepped, with IC		GH106
25307	1507		Polygon shank holders, according to ISO 26623, straight 0°		GH106
25308	1510		Polygon shank holders, according to ISO 26623, offset 90°		GH106
25309	1510		Polygon shank holders, according to ISO 26623, offset 90°		GH106
25311	1513		HSK-T holders, according to ISO 12164-3, straight 0°		GH106
25314	1516		Square shank holders, straight 0°		GH106
25315	1516		Square shank holders, straight 0°		GH106
25316	1492		Round shank holders, clamping screw above, for Citizen machine		GB106
25317	1495		Round shank holders, clamping screw above, for Star machine		GB106
25318	1498		Round shank holders, clamping screw above, for Tornos machine		GB106
25319	1489		Round shank holders, clamping screw above, without clamping surfaces		GB106
25320	1484		Round shank holders, clamping screw above, four clamping surfaces		GB106
25321	1500		Round shank holders, for machine type Star, rear side machining		GB106
25325	1485		Round shank holders, clamping screw above, four clamping surfaces		GB106
25350	1525		Square shank holder straight, external machining, without IC		GH305
25351	1525		Square shank holder straight, external machining, without IC		GH305
25352	1527		Square shank holders straight, external machining, with IC		GH305
25353	1527		Square shank holders straight, external machining, with IC		GH305
25356	1530		Square shank holders 90° offset, external machining, without IC		GH305
25357	1530		Square shank holders 90° offset, external machining, without IC		GH305
25358	1531		Square shank holders 90° offset, external machining, with IC		GH305
25359	1531		Square shank holders 90° offset, external machining, with IC		GH305
25362	1532		Square shank holders 45° offset, external machining, without IC		GH305

Article no.	Page	Cutting data page	Description	Tool material	Type
25363	1532		Square shank holders 45° offset, external machining, without IC		GH305
25364	1533		Square shank holders 45° offset, external machining, with IC		GH305
25365	1533		Square shank holders 45° offset, external machining, with IC		GH305
25368	1534		Round shank holders, internal machining, without IC		GB305
25369	1534		Round shank holders, internal machining, without IC		GB305
25370	1535		Round shank holders, internal machining, with IC		GB305
25371	1535		Round shank holders, internal machining, with IC		GB305
25372	1529		Square shank holders straight, external machining, IC adjustable		GH305
25373	1529		Square shank holders straight, external machining, IC adjustable		GH305
25502	1438	1554	Cutting inserts for boring out and profiling	Solid carbide	GT106
25503	1438	1554	Cutting inserts for boring out and profiling	Solid carbide	GT106
25506	1438	1554	Cutting inserts for boring out and profiling	Solid carbide	GT106
25507	1438	1554	Cutting inserts for boring out and profiling	Solid carbide	GT106
25510	1439	1554	Cutting inserts for boring out and profiling	Solid carbide	GT106
25511	1439	1554	Cutting inserts for boring out and profiling	Solid carbide	GT106
25514	1439	1554	Cutting inserts for boring out and profiling	Solid carbide	GT106
25515	1439	1554	Cutting inserts for boring out and profiling	Solid carbide	GT106
25518	1433	1554	Cutting inserts for boring out and profiling	Solid carbide	GT106
25519	1433	1554	Cutting inserts for boring out and profiling	Solid carbide	GT106
25522	1433	1554	Cutting inserts for boring out and profiling	Solid carbide	GT106
25523	1433	1554	Cutting inserts for boring out and profiling	Solid carbide	GT106
25601	1405	1544-1546	Indexable inserts for radial grooving external and internal	Solid carbide	GE305
25602	1405	1544-1546	Indexable inserts for radial grooving external and internal	Solid carbide	GE305
25603	1405	1544-1546	Indexable inserts for radial grooving external and internal	Solid carbide	GE305
25605	1406	1546-1547	Indexable inserts for radial grooving and external and internal copying	Solid carbide	GE305
25606	1406	1546-1547	Indexable inserts for radial grooving and external and internal copying	Solid carbide	GE305
25607	1406	1546-1547	Indexable inserts for radial grooving and external and internal copying	Solid carbide	GE305
25613	1407	1548-1549	Indexable inserts for radial grooving and external and internal copying	Solid carbide	GE305
25614	1407	1548-1549	Indexable inserts for radial grooving and external and internal copying	Solid carbide	GE305
25615	1407	1548-1549	Indexable inserts for radial grooving and external and internal copying	Solid carbide	GE305
25618	1419	1550	Indexable inserts for grooving axial external recesses	Solid carbide	GA305
25619	1419	1550	Indexable inserts for grooving axial external recesses	Solid carbide	GA305
25620	1419	1550	Indexable inserts for grooving axial external recesses	Solid carbide	GA305
25621	1419	1550	Indexable inserts for grooving axial external recesses	Solid carbide	GA305
25622	1419	1550	Indexable inserts for grooving axial external recesses	Solid carbide	GA305
25623	1419	1550	Indexable inserts for grooving axial external recesses	Solid carbide	GA305
25626	1417	1550	Indexable inserts for axial grooving, flat bottom slots	Solid carbide	GA305
25627	1417	1550	Indexable inserts for axial grooving, flat bottom slots	Solid carbide	GA305
25628	1417	1550	Indexable inserts for axial grooving, flat bottom slots	Solid carbide	GA305
25629	1417	1550	Indexable inserts for axial grooving, flat bottom slots	Solid carbide	GA305
25630	1417	1550	Indexable inserts for axial grooving, flat bottom slots	Solid carbide	GA305
25631	1417	1550	Indexable inserts for axial grooving, flat bottom slots	Solid carbide	GA305
25634	1418	1550	Indexable inserts for axial grooving, full radius slots	Solid carbide	GA305
25635	1418	1550	Indexable inserts for axial grooving, full radius slots	Solid carbide	GA305
25636	1418	1550	Indexable inserts for axial grooving, full radius slots	Solid carbide	GA305
25637	1418	1550	Indexable inserts for axial grooving, full radius slots	Solid carbide	GA305
25638	1418	1550	Indexable inserts for axial grooving, full radius slots	Solid carbide	GA305
25639	1418	1550	Indexable inserts for axial grooving, full radius slots	Solid carbide	GA305
25641	1420	1552	Indexable inserts for parting off	Solid carbide	GZ305
25642	1420	1552	Indexable inserts for parting off	Solid carbide	GZ305
25643	1420	1552	Indexable inserts for parting off	Solid carbide	GZ305
25646	1421	1552	Indexable inserts for parting off	Solid carbide	GZ305
25647	1421	1552	Indexable inserts for parting off	Solid carbide	GZ305
25648	1421	1552	Indexable inserts for parting off	Solid carbide	GZ305
25649	1421	1552	Indexable inserts for parting off	Solid carbide	GZ305
25650	1421	1552	Indexable inserts for parting off	Solid carbide	GZ305
25651	1421	1552	Indexable inserts for parting off	Solid carbide	GZ305
25654	1465	1565	Indexable inserts for threading, part profile, external	Solid carbide	GG305
25655	1465	1565	Indexable inserts for threading, part profile, external	Solid carbide	GG305
25656	1465	1565	Indexable inserts for threading, part profile, external	Solid carbide	GG305
25657	1465	1565	Indexable inserts for threading, part profile, external	Solid carbide	GG305
25658	1465	1565	Indexable inserts for threading, part profile, external	Solid carbide	GG305
25659	1465	1565	Indexable inserts for threading, part profile, external	Solid carbide	GG305
25662	1466	1565	Indexable inserts for threading, full profile, external	Solid carbide	GG305
25663	1466	1565	Indexable inserts for threading, full profile, external	Solid carbide	GG305
25664	1466	1565	Indexable inserts for threading, full profile, external	Solid carbide	GG305
25665	1466	1565	Indexable inserts for threading, full profile, external	Solid carbide	GG305
25666	1466	1565	Indexable inserts for threading, full profile, external	Solid carbide	GG305
25667	1466	1565	Indexable inserts for threading, full profile, external	Solid carbide	GG305
25668	1467	1565	Indexable inserts for threading, Withworth	Solid carbide	GG305
25669	1467	1565	Indexable inserts for threading, Withworth	Solid carbide	GG305
25670	1467	1565	Indexable inserts for threading, Withworth	Solid carbide	GG305

Article no.	Page	Cutting data page	Description	Tool material	Type
25835	1425	1554	Cutting inserts for boring out and profiling	Solid carbide	GT106
25838	1425	1554	Cutting inserts for boring out and profiling	Solid carbide	GT106
25839	1425	1554	Cutting inserts for boring out and profiling	Solid carbide	GT106
25842	1430	1554	Cutting inserts for boring out and profiling	Solid carbide	GT106
25843	1430	1554	Cutting inserts for boring out and profiling	Solid carbide	GT106
25846	1430	1554	Cutting inserts for boring out and profiling	Solid carbide	GT106
25847	1430	1554	Cutting inserts for boring out and profiling	Solid carbide	GT106
25850	1443	1554	Cutting inserts for boring out and profiling	Solid carbide	GJ106
25851	1443	1554	Cutting inserts for boring out and profiling	Solid carbide	GJ106
25854	1443	1554	Cutting inserts for boring out and profiling	Solid carbide	GJ106
25855	1443	1554	Cutting inserts for boring out and profiling	Solid carbide	GJ106
25858	1447	1559	Cutting inserts for back boring and profiling	Solid carbide	GT106
25859	1447	1559	Cutting inserts for back boring and profiling	Solid carbide	GT106
25862	1447	1559	Cutting inserts for back boring and profiling	Solid carbide	GT106
25863	1447	1559	Cutting inserts for back boring and profiling	Solid carbide	GT106
25866	1452	1562	Cutting inserts for boring out and chamfering	Solid carbide	GT106
25867	1452	1562	Cutting inserts for boring out and chamfering	Solid carbide	GT106
25870	1452	1562	Cutting inserts for boring out and chamfering	Solid carbide	GT106
25871	1452	1562	Cutting inserts for boring out and chamfering	Solid carbide	GT106
25874	1394	1544	Cutting inserts for internal grooving, flat bottom slots	Solid carbide	GE106
25875	1394	1544	Cutting inserts for internal grooving, flat bottom slots	Solid carbide	GE106
25878	1394	1544	Cutting inserts for internal grooving, flat bottom slots	Solid carbide	GE106
25879	1394	1544	Cutting inserts for internal grooving, flat bottom slots	Solid carbide	GE106
25882	1399	1544	Cutting inserts for internal grooving, full radius slots	Solid carbide	GE106
25883	1399	1544	Cutting inserts for internal grooving, full radius slots	Solid carbide	GE106
25886	1399	1544	Cutting inserts for internal grooving, full radius slots	Solid carbide	GE106
25887	1399	1544	Cutting inserts for internal grooving, full radius slots	Solid carbide	GE106
25890	1431	1554	Cutting inserts for boring out and profiling	Solid carbide	GT106
25891	1431	1554	Cutting inserts for boring out and profiling	Solid carbide	GT106
25894	1431	1554	Cutting inserts for boring out and profiling	Solid carbide	GT106
25895	1431	1554	Cutting inserts for boring out and profiling	Solid carbide	GT106
25897	1469	1566	Cutting inserts for internal hexagon	Solid carbide	GN106
25898	1469	1566	Cutting inserts for internal hexagon	Solid carbide	GN106
25900	1541		Clamping screws		
25901	1541		Clamping screws		
25902	1541		Clamping screws		
25904	1540		Torx Plus wrench		
25905	1542		Set screws		
25906	1542		Clamping screws		
25907	1542		Clamping screws		
25908	1542		Clamping screws		
25909	1543		IC screw plugs		
25910	1543		IC screw plugs for tubeless coolant supply (TL)		
25912	1542		Fastening screws		
25913	1543		Set screws		
25921	1541		Mounting keys		
25922	1540		Torx Plus wrench		
25923	1543		Lubricating paste for clamping screws		
26100	1526		Square shank holder straight, external machining, without IC		GH222
26101	1526		Square shank holder straight, external machining, without IC		GH222
26102	1528		Square shank holders straight, external machining, with IC		GH222
26103	1528		Square shank holders straight, external machining, with IC		GH222
26200	1536		Parting off blade, without IC		GS222
26201	1537		Parting off blade, with IC		GS222
26202	1538		Reinforced parting off blade, without IC		GS222
26203	1538		Reinforced parting off blade, without IC		GS222
26206	1539		Reinforced parting off blade, with IC		GS222
26207	1539		Reinforced parting off blade, with IC		GS222
26601	1422	1552	Indexable inserts for parting off	Solid carbide	GZ222
26602	1422	1552	Indexable inserts for parting off	Solid carbide	GZ222
26603	1422	1552	Indexable inserts for parting off	Solid carbide	GZ222
26604	1423	1552	Indexable inserts for parting off	Solid carbide	GZ122
26605	1423	1552	Indexable inserts for parting off	Solid carbide	GZ222
26902	1404	1544	Cutting inserts for internal pre-grooving and chamfering	Solid carbide	GV106
26903	1404	1544	Cutting inserts for internal pre-grooving and chamfering	Solid carbide	GV106
26904	1404	1544	Cutting inserts for internal pre-grooving and chamfering	Solid carbide	GV106
26905	1404	1544	Cutting inserts for internal pre-grooving and chamfering	Solid carbide	GV106
26906	1454	1563	Cutting inserts for drilling into solid material and boring out Quattro Drill	Solid carbide	QG106
27000	1477		Round shank holders, clamping screw above		GB108
27001	1481		Round shank holders, clamping screw lateral		GB108
27002	1486		Round shank holders, clamping screw above, four clamping surfaces		GB108
27003	1490		Round shank holders, clamping screw above, without clamping surfaces		GB108

Article no.	Page	Cutting data page	Description	Tool material	Type
27004	1493		Round shank holders, clamping screw above, for Citizen machine		GB108
27005	1496		Round shank holders, clamping screw above, for Star machine		GB108
27007	1517		Square shank holders, straight 0°		GH108
27008	1517		Square shank holders, straight 0°		GH108
27009	1521		Square shank holders, 90° offset		GH108
27010	1521		Square shank holders, 90° offset		GH108
27011	1508		Polygon shank holders, according to ISO 26623, straight 0°		GH108
27012	1511		Polygon shank holders, according to ISO 26623, offset 90°		GH108
27013	1511		Polygon shank holders, according to ISO 26623, offset 90°		GH108
27014	1514		HSK-T holders, according to ISO 12164-3, straight 0°		GH108
27015	1504		Round shank holders for broaching		GB108
27016	1501		Round shank holders, for machine type Star, rear side machining		GB108
27018	1487		Round shank holders, clamping screw above, four clamping surfaces		GB108
27050	1478		Round shank holders, clamping screw above		GB110
27051	1482		Round shank holders, clamping screw lateral		GB110
27052	1518		Square shank holders, straight 0°		GH110
27053	1518		Square shank holders, straight 0°		GH110
27054	1522		Square shank holders, 90° offset		GH110
27055	1522		Square shank holders, 90° offset		GH110
27056	1505		Round shank holders for broaching		GB110
27100	1427	1556	Cutting inserts for boring out and profiling	Solid carbide	GT108
27101	1427	1556	Cutting inserts for boring out and profiling	Solid carbide	GT108
27102	1427	1556	Cutting inserts for boring out and profiling	Solid carbide	GT108
27103	1427	1556	Cutting inserts for boring out and profiling	Solid carbide	GT108
27104	1434	1556	Cutting inserts for boring out and profiling	Solid carbide	GT108
27105	1434	1556	Cutting inserts for boring out and profiling	Solid carbide	GT108
27106	1434	1556	Cutting inserts for boring out and profiling	Solid carbide	GT108
27107	1434	1556	Cutting inserts for boring out and profiling	Solid carbide	GT108
27108	1435	1556	Cutting inserts for boring out and profiling	Solid carbide	GT108
27109	1435	1556	Cutting inserts for boring out and profiling	Solid carbide	GT108
27110	1435	1556	Cutting inserts for boring out and profiling	Solid carbide	GT108
27111	1435	1556	Cutting inserts for boring out and profiling	Solid carbide	GT108
27116	1445	1556	Cutting inserts for boring out and profiling	Solid carbide	GJ108
27117	1445	1556	Cutting inserts for boring out and profiling	Solid carbide	GJ108
27118	1445	1556	Cutting inserts for boring out and profiling	Solid carbide	GJ108
27119	1445	1556	Cutting inserts for boring out and profiling	Solid carbide	GJ108
27120	1449	1560	Cutting inserts for back boring and profiling	Solid carbide	GT108
27121	1449	1560	Cutting inserts for back boring and profiling	Solid carbide	GT108
27122	1449	1560	Cutting inserts for back boring and profiling	Solid carbide	GT108
27123	1449	1560	Cutting inserts for back boring and profiling	Solid carbide	GT108
27124	1396	1544	Cutting inserts for internal grooving, flat bottom slots	Solid carbide	GE108
27125	1396	1544	Cutting inserts for internal grooving, flat bottom slots	Solid carbide	GE108
27126	1396	1544	Cutting inserts for internal grooving, flat bottom slots	Solid carbide	GE108
27127	1396	1544	Cutting inserts for internal grooving, flat bottom slots	Solid carbide	GE108
27128	1401	1544	Cutting inserts for internal grooving, full radius slots	Solid carbide	GE108
27129	1401	1544	Cutting inserts for internal grooving, full radius slots	Solid carbide	GE108
27130	1401	1544	Cutting inserts for internal grooving, full radius slots	Solid carbide	GE108
27131	1401	1544	Cutting inserts for internal grooving, full radius slots	Solid carbide	GE108
27132	1457	1564	Cutting inserts for internal threading, part profile - metric standard threads	Solid carbide	GG108
27133	1457	1564	Cutting inserts for internal threading, part profile - metric standard threads	Solid carbide	GG108
27134	1457	1564	Cutting inserts for internal threading, part profile - metric standard threads	Solid carbide	GG108
27135	1457	1564	Cutting inserts for internal threading, part profile - metric standard threads	Solid carbide	GG108
27136	1461	1564	Cutting inserts for internal threading, full profile - metric standard threads	Solid carbide	GG108
27137	1461	1564	Cutting inserts for internal threading, full profile - metric standard threads	Solid carbide	GG108
27138	1461	1564	Cutting inserts for internal threading, full profile - metric standard threads	Solid carbide	GG108
27139	1461	1564	Cutting inserts for internal threading, full profile - metric standard threads	Solid carbide	GG108
27140	1474	1566	Cutting inserts for broaching longitudinal slots	Solid carbide	GN108
27141	1474	1566	Cutting inserts for broaching longitudinal slots	Solid carbide	GN108
27142	1474	1566	Cutting inserts for broaching longitudinal slots	Solid carbide	GN108
27143	1474	1566	Cutting inserts for broaching longitudinal slots	Solid carbide	GN108
27144	1474	1566	Cutting inserts for broaching longitudinal slots	Solid carbide	GN108
27145	1474	1566	Cutting inserts for broaching longitudinal slots	Solid carbide	GN108
27146	1470	1566	Cutting inserts for internal hexagon	Solid carbide	GN108
27147	1470	1566	Cutting inserts for internal hexagon	Solid carbide	GN108
27200	1428	1556	Cutting inserts for boring out and profiling	Solid carbide	GT108
27201	1428	1556	Cutting inserts for boring out and profiling	Solid carbide	GT108
27202	1428	1556	Cutting inserts for boring out and profiling	Solid carbide	GT108
27203	1428	1556	Cutting inserts for boring out and profiling	Solid carbide	GT108
27204	1436	1556	Cutting inserts for boring out and profiling	Solid carbide	GT108
27205	1436	1556	Cutting inserts for boring out and profiling	Solid carbide	GT108
27206	1436	1556	Cutting inserts for boring out and profiling	Solid carbide	GT108
27207	1436	1556	Cutting inserts for boring out and profiling	Solid carbide	GT108

Article no.	Page	Cutting data page	Description	Tool material	Type
27208	1436	1556	Cutting inserts for boring out and profiling	Solid carbide	GT108
27209	1436	1556	Cutting inserts for boring out and profiling	Solid carbide	GT108
27210	1436	1556	Cutting inserts for boring out and profiling	Solid carbide	GT108
27211	1436	1556	Cutting inserts for boring out and profiling	Solid carbide	GT108
27216	1445	1556	Cutting inserts for boring out and profiling	Solid carbide	GJ108
27217	1445	1556	Cutting inserts for boring out and profiling	Solid carbide	GJ108
27218	1445	1556	Cutting inserts for boring out and profiling	Solid carbide	GJ108
27219	1445	1556	Cutting inserts for boring out and profiling	Solid carbide	GJ108
27220	1450	1560	Cutting inserts for back boring and profiling	Solid carbide	GT108
27221	1450	1560	Cutting inserts for back boring and profiling	Solid carbide	GT108
27222	1450	1560	Cutting inserts for back boring and profiling	Solid carbide	GT108
27223	1450	1560	Cutting inserts for back boring and profiling	Solid carbide	GT108
27224	1397	1544	Cutting inserts for internal grooving, flat bottom slots	Solid carbide	GE108
27225	1397	1544	Cutting inserts for internal grooving, flat bottom slots	Solid carbide	GE108
27226	1397	1544	Cutting inserts for internal grooving, flat bottom slots	Solid carbide	GE108
27227	1397	1544	Cutting inserts for internal grooving, flat bottom slots	Solid carbide	GE108
27228	1402	1544	Cutting inserts for internal grooving, full radius slots	Solid carbide	GE108
27229	1402	1544	Cutting inserts for internal grooving, full radius slots	Solid carbide	GE108
27230	1402	1544	Cutting inserts for internal grooving, full radius slots	Solid carbide	GE108
27231	1402	1544	Cutting inserts for internal grooving, full radius slots	Solid carbide	GE108
27232	1409	1550	Cutting inserts for axial grooving, flat bottom slots	Solid carbide	GA108
27233	1409	1550	Cutting inserts for axial grooving, flat bottom slots	Solid carbide	GA108
27234	1409	1550	Cutting inserts for axial grooving, flat bottom slots	Solid carbide	GA108
27235	1409	1550	Cutting inserts for axial grooving, flat bottom slots	Solid carbide	GA108
27236	1411	1550	Cutting inserts for axial grooving bores, full radius slots	Solid carbide	GA108
27237	1411	1550	Cutting inserts for axial grooving bores, full radius slots	Solid carbide	GA108
27238	1411	1550	Cutting inserts for axial grooving bores, full radius slots	Solid carbide	GA108
27239	1411	1550	Cutting inserts for axial grooving bores, full radius slots	Solid carbide	GA108
27240	1413	1550	Cutting inserts for axial grooving studs, flat bottom slots	Solid carbide	GA108
27241	1413	1550	Cutting inserts for axial grooving studs, flat bottom slots	Solid carbide	GA108
27242	1413	1550	Cutting inserts for axial grooving studs, flat bottom slots	Solid carbide	GA108
27243	1413	1550	Cutting inserts for axial grooving studs, flat bottom slots	Solid carbide	GA108
27244	1415	1550	Cutting inserts for axial grooving studs, full radius slots	Solid carbide	GA108
27245	1415	1550	Cutting inserts for axial grooving studs, full radius slots	Solid carbide	GA108
27246	1415	1550	Cutting inserts for axial grooving studs, full radius slots	Solid carbide	GA108
27247	1415	1550	Cutting inserts for axial grooving studs, full radius slots	Solid carbide	GA108
27290	1454	1563	Cutting inserts for drilling into solid material and boring out Quattro Drill	Solid carbide	QG108

Material examples cutting data tables

Machining group	Material number	Material designation	
P1.1.1 Unalloyed steel, annealed, 0.15 % C, Rm 420 N/mm ² , 125 HB P1.1.2 Unalloyed steel, heat-treated, 0.15 % C, Rm 420 N/mm ² , 125 HB P1.1.3 Unalloyed steel, annealed, 0.45 % C, Rm 640 N/mm ² , 190 HB P1.1.4 Unalloyed steel, heat-treated, 0.45 % C, Rm 640 N/mm ² , 190 HB P1.1.5 Unalloyed steel, heat-treated, 0.45 % C, Rm 850 N/mm ² , 250 HB P1.1.6 Unalloyed steel, annealed, 0.75 % C, Rm 915 N/mm ² , 270 HB P1.1.7 Unalloyed steel, heat-treated, 0.75 % C, Rm 1020 N/mm ² , 300 HB	1.0023	S 270 GP	
	1.0039	S235JRH	
	1.0070	E360	
	1.0503	C45	
	1.0601	C60	
	P2.1.1 Low-alloy steel, annealed, Rm 610 N/mm ² , 180 HB P2.1.2 Low-alloy steel, heat-treated, Rm 930 N/mm ² , 275 HB P2.1.3 Low-alloy steel, heat-treated, Rm 1020 N/mm ² , 300 HB P2.1.4 Low-alloy steel, heat-treated, Rm 1190 N/mm ² , 350 HB	1.7131	16MnCr5
		1.7225	42CrMo4
P3.1.1 High-alloy steel and tool steel, annealed, Rm 680 N/mm ² , 200 HB P3.1.2 High-alloy steel and tool steel, hardened and tempered, Rm 1100 N/mm ² , 325 HB		1.2343	X37CrMoV5-1
		1.2379	X153CrMoV12
	1.2767	45NiCrMo16	
M1.1.1 Stainless steel, ferritic/martensitic, with machining additives M1.1.2 Stainless steel, ferritic/martensitic, annealed, Rm 680 N/mm ² , 200 HB M1.1.3 Stainless steel, ferritic/martensitic, heat-treated, Rm 810 N/mm ² , 240 HB	1.4000	X6Cr13	
	1.4034	X46Cr13	
M2.1.1 Stainless steel, austenitic, quenched, 180 HB M2.2.1 Duplex steel, high-strength stainless steels	1.4301	X5CrNi18-10	
	1.4305	X8CrNiS18-9	
	1.4401	X5CrNiMo17-12-2	
	1.4410	X2CrNiMoN25-7-4	
	1.4501	X2CrNiMoCuWN25-7-4	
K1.1.1 Grey cast iron, pearlitic/ferritic, 180 HB K1.1.2 Grey cast iron, pearlitic/martensitic, 260 HB	0.6010	GG-10	
	0.6020	GG-20	
	0.6025	GG-25	
	0.6030	GG-30	
	0.6045	GG-45	
K1.2.1 Cast iron with spheroidal graphite, ferritic, 160 HB K1.2.2 Cast iron with spheroidal graphite, pearlitic, 250 HB	0.7033	GGG-35.3	
	0.7040	GGG-40	
	0.7060	GGG-60	
	0.7070	GGG-70	
	0.7080	GGG-80	
	0.7660	GGG-NiCr 20-2	
	K1.3.1 Malleable cast iron, ferritic, 130 HB K1.3.2 Malleable cast iron, pearlitic, 230 HB	0.8035	GTW-35-04
0.8045		GTW-45	
0.8145		GTS-45	
0.8165		GTS-65-02	
0.8170		GTS-70-02	
K2.1.1 Vermicular graphite cast iron (GJV) K2.2.1 Austenitic-ferritic spheroidal graphite cast iron (ADI)	5.2100	GJV-300	
	5.2201	GJV-400	
	5.2301	GJV-500	
	5.3400	GJS-800-10	
	5.3402	GJS-900-8	
	5.3403	GJS-1050-6	

Machining group	Material number	Material designation
N1.1.1 Wrought aluminium alloys, non-hardened, 60 HB N1.1.2 Wrought aluminium alloys, hardened, 100 HB	3.3206	AlMgSi0.5 / EN AW-6060
	3.3210	AlMgSi0.7 / EN AW-6005
	3.2315	AlMgSi1 / EN AW-6082
N2.1.1 Aluminium casting alloys, non-hardened, $\leq 12\%$ Si, 75 HB N2.1.2 Aluminium casting alloys, hardened, $\leq 12\%$ Si, 90 HB N2.1.3 Aluminium casting alloys, non-hardened, $> 12\%$ Si, 130 HB	3.2163	AlSi9Cu3(Fe) / EN AC-46000
	–	AlSi17Cu4Mg / EN AB-48100
	3.2371	AlSi7Mg0.3 / EN AC-42100
	3.2373	AlSi9Mg / EN AC-43300
N3.1.1 Copper and copper alloys: Free-machining alloy, Pb $> 1\%$ N3.1.2 Copper and copper alloys: CuZn, CuSnZn N3.1.3 Copper and copper alloys: CuSn, lead-free copper and copper electrolyte	2.0060	Cu57
	2.0321	CuZn37
	CW510L	CuZn42
	–	CuZn21Si3P
	2.0331	CuZn35Pb1
	2.0401	CuZn39Pb3
	2.1030	CuSn8
N4.1.1 Non-metallic materials: Duroplastics, fibre-reinforced plastics N4.1.2 Non-metallic materials: Hard rubber, wood, etc. N4.1.3 Non-metallic materials: Graphite	–	–
	1.3401	X120Mn12
	1.4864	X12NiCrSi35-16
S1.1.1 Heat-resistant alloys, Fe-based, annealed, 200 HB S1.1.2 Heat-resistant alloys, Fe-based, hardened, 280 HB S1.1.3 Heat-resistant alloys, Ni- or Co-based, annealed, 250 HB S1.1.4 Heat-resistant alloys, Ni- or Co-based, hardened, 350 HB S1.1.5 Heat-resistant alloys, Ni- or Co-based, cast, 320 HB	2.4375	NiCu30Al
	2.4631	NiCr20Ti2Al
	2.4668	NiCr19Fe19Nb5Mo3 / Inconel 718
	2.4952	NiCr20TiAl
	3.7025	Titan Grade 1
S2.1.1 Titanium alloys, pure titanium, Rm 400 N/mm ² S2.1.2 Titanium alloys, Alpha and Beta alloys, hardened, Rm 1050 N/mm ²	3.7034	Titan Grade 2
	3.7165	TiAl6V4
	1.2067	100Cr6
H1.1.1 Hardened steel, hardened and tempered, < 55 HRC H1.1.2 Hardened steel, hardened and tempered, < 60 HRC H1.1.3 Hardened steel, hardened and tempered, > 60 HRC	1.2083	X40Cr14
	1.2343	X37CrMoV5-1
	1.2361	X91CrMoV18
	1.2721	50NiCr13
	1.2842	90MnCrV8
	1.7225	42CrMo4
	0.9635	GX300CrMo15-3
H2.1.1 Chilled cast iron, 400 HB H2.1.2 Chilled cast iron, hardened and tempered, < 55 HRC	1.4841	X15CrNiSi25-21

ISO codes

P	Steel, high-alloyed steel
M	Stainless steel
K	Grey cast iron, spheroidal graphite iron and malleable cast iron
N	Aluminium and other non-ferrous metals
S	Special, super and titanium alloys
H	Hardened steel and chilled cast iron
O	Fibre-reinforced plastics (FRP), graphite

On the programme and cutting data pages you will find for every tool recommendations regarding suitability for the application groups and details of max. tensile strength and hardness.

- optimal suitability
- limited suitability

Surfaces

- | | | | |
|------------------|------------------------|-------------|-----------------|
| ○ bright | F FIRE/nanoFIRE | ● TiSiN | Ⓝ nickel-plated |
| ● steam tempered | A TiAlN | ● Perrox | Ⓟ bowed |
| ● nitrided | A TiAlN SuperA | Ⓞ Carbo | Ⓢ Endurum |
| ◐ nitrided lands | a TiAlN nanoA | Ⓣ Crisall C | Ⓜ Ferrox |
| ● golden brown | Ⓢ TiCN | Ⓝ Signum | Ⓢ Sirius |
| Ⓟ AlCrN | Ⓢ TiN | Ⓢ Raptor | Ⓢ Zenit |

Pictograms

Tool material	VHM Solid carbide	HM Carbide	HSS High-speed steel	HSCO	HSS-E	M42	HSS-E-PM	Cermet	PKD Polycrystalline diamond								
Machining depth	3xD	5xD	7xD	8xD	10xD	12xD	15xD	20xD	25xD	80xD	~5xD	~10xD	>25xD	GL 600	GL 1200	GL 2000	...
Tolerance on Ø	m7	h5	h6	h7	H7	h8	ISO2/6H	6HX	ISO3/6G	6GX	7GX	6H +0,1	±0,015	+0,004 +0,005
Shank form	HA to DIN 6535	HB	HE	B	~HA	Cyl cylindrical	MK Morse taper	3 3-flats on shank	TBM-SEH Standard groove rear								
Standard	DIN 208 to DIN	DIN 338	DIN 340	DIN 371	DIN 376	DIN 371/376	DIN 1897	DIN 6527K	DIN 6527L	DIN 6537K	DIN 6537L	DIN 5156	DIN 6528	-DIN 8094	...	WN to Gühring Standard	...
Type	N	H	W	VA	NRf	RT 100 HF	RT 100 U	RT 100 T	RT 100 XF	GU 3FS	GT 500 DZ	EB 80 XXL	HT 800 WP	MTMH3-Z	TM SP	GE104	...
Internal coolant	with internal coolant	without internal coolant															
Cutting direction	right-hand	left-hand	neutral														
Web thinning																	
Hole type	Through-hole threads	Blind-hole threads	Through-hole and blind-hole threads														
Form	A	B	C	D	DR	R											
Application	Slotting	Roughing	Ramping	Helix	Drilling	Finishing	Copying										
Length	short (DIN)	long (DIN)	2,5xD	3xD	4xD	5xD											
No. of cutting edges	2	3	4	5	6	6+	2-4	3-4	4-5	5-6	...						
Helix angle	2-4°	0°	7°	20°	30°	45°	35° 38°	36° 37°	40° 42°	44° 45° 46°	...						
Rake angle	-2°	-3°	-7°	0°	3°	4°	7°	9°	10°	12°	...						
Cutting edge form	45° Corner chamfer	R±0,01	R±0,02	R±0,01	R±0,03	R±0,05	...	60°	82°	90°	120°	135°	140°	125°	...		
Feed	for lateral feed	for lateral feed and oblique plunging	for lateral feed, oblique plunging and drilling														
Hardness	48 HRC	55 HRC	62 HRC	63 HRC	65 HRC	66 HRC	...										
Interfaces	HSK-A	HSK-C	HSK-E	SK	MAS-BT	...											

GÜHRING

Gühring KG | Herderstrasse 50-54 | 72458 Albstadt | Germany
Telephone: +49 74 31 17-0 | info@guehring.de | www.guehring.com