



Application générale, acier et inox

# S-TAP

Volume 3



# INDEX

---

## Trou Borgne

### Métrique

S-SFT	<b>NOUVELLES DIMENSIONS</b> .....	PAGE 5
S-SFT 6G	<b>NOUVEAU</b> .....	PAGE 6
S-SFT 7G	<b>NOUVEAU</b> (disponible à partir de décembre 2017) ....	PAGE 7
S-SFT +0.1	<b>NOUVEAU</b> .....	PAGE 8
S-SFT (FORM E)	<b>NOUVEAU</b> .....	PAGE 9
S-LT-SFT	<b>NOUVEAU</b> .....	PAGE 10
S-SFT-LH	<b>NOUVEAU</b> .....	PAGE 11
S-SFT-HB Weldon Shank	<b>NOUVEAU</b> .....	PAGE 12

### Métrique Fin

S-SFT	.....	PAGE 13
S-SFT 6G	<b>NOUVEAU</b> (disponible à partir de décembre 2017) .....	PAGE 14

### G (BSP)

S-SFT	<b>NOUVEAU</b> .....	PAGE 15
-------	----------------------	---------

### UNC

S-SFT	<b>NOUVEAU</b> .....	PAGE 16
-------	----------------------	---------

### UNF

S-SFT	<b>NOUVEAU</b> (disponible à partir de décembre 2017).....	PAGE 17
-------	--	---------

### BSW

S-SFT	<b>NOUVEAU</b> (disponible à partir de mars 2018).....	PAGE 18
-------	--	---------

### BSF

S-SFT	<b>NOUVEAU</b> (disponible à partir de mars 2018).....	PAGE 19
-------	--	---------

### BA

S-SFT	<b>NOUVEAU</b> (disponible à partir de mars 2018).....	PAGE 20
-------	--	---------

### Rc (BSPT)

S-TPT	<b>NOUVEAU</b> (disponible à partir de décembre 2017).....	PAGE 21
-------	--	---------

## Trou Débouchant

### Métrique

S-POT	<b>NOUVELLES DIMENSIONS</b> .....	PAGE 22
S-POT 6G	<b>NOUVEAU</b> .....	PAGE 23
S-POT 7G	<b>NOUVEAU</b> .....	PAGE 24
S-POT +0.1	<b>NOUVEAU</b> .....	PAGE 25
S-LT-POT	<b>NOUVEAU</b> .....	PAGE 26
S-POT-LH	<b>NOUVEAU</b> .....	PAGE 27
S-POT-HB Weldon Shank	<b>NOUVEAU</b> .....	PAGE 28

### Métrique Fin

S-POT	.....	PAGE 29
S-POT 6G	<b>NOUVEAU</b> (disponible à partir de décembre 2017)...	PAGE 30

### G (BSP)

S-POT	<b>NOUVEAU</b> .....	PAGE 31
-------	----------------------	---------

### UNC

S-POT	<b>NOUVEAU</b> .....	PAGE 32
-------	----------------------	---------

### UNF

S-POT	<b>NOUVEAU</b> (disponible à partir de décembre 2017)...	PAGE 33
-------	--	---------

### BSW

S-POT	<b>NOUVEAU</b> (disponible à partir de mars 2018).....	PAGE 34
-------	--	---------

### BSF

S-POT	<b>NOUVEAU</b> (disponible à partir de mars 2018).....	PAGE 35
-------	--	---------

### BA

S-POT	<b>NOUVEAU</b> (disponible à partir de mars 2018).....	PAGE 36
-------	--	---------

# CARACTÉRISTIQUES: S-TAP

---



1 Angle de coupe positif

2 Bonne évacuation des copeaux  
angle d'hélice évolutive

3 Taraudage jusqu'à 3 x D

4 Traitement vapeur OX  
pour éviter le collage

5 HSSE

# S-SFT NOUVELLES DIMENSIONS

M1, M1,1 & M1,2  
disponible à partir de février 2018

Taroudage | Taroud coupant | Métrique

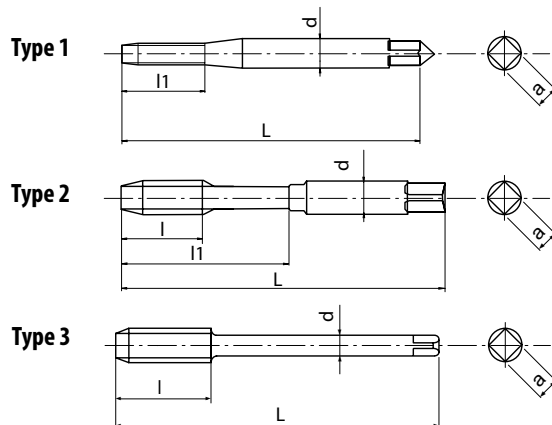

- Taroud coupant helicoidal pour trou borgne
- Traitement vapeur OX
- Application générale pour acier et inox

<b>P</b> C < 0,2%	<b>P</b> 0,25 < C < 0,4	<b>P</b> C > 0,45%	<b>P</b> SCM	<b>M</b> INOX	<b>K</b> GGG	
10-15	8-14	8-14	7-11	7-12	7-14	m/min

<b>M</b>	<b>HSSE</b>	<b>OX</b>	<b>40°</b>	<b>ISO 2 6H</b>	<b>ISO 1 5H&lt;M1,4</b>	<b>C/2,5</b>	<b>DIN 371</b>	<b>DIN 376</b>
----------	-------------	-----------	------------	-----------------	-------------------------	--------------	----------------	----------------

EDP\* : Tolérance 5H

EDP	M	P	L	l	l1	d	a	z	Type	DIN	Prix
48223111*	1	0,25	40	-	5	2,5	2,1	2	1	DIN371	
48223112*	1,1	0,25	40	-	5	2,5	2,1	2	1	DIN371	
48223113*	1,2	0,25	40	-	5	2,5	2,1	2	1	DIN371	
48223115*	1,4	0,3	40	-	6	2,5	2,1	2	1	DIN371	
48223118	1,6	0,35	40	-	7	2,5	2,1	2	1	DIN371	
48223119	1,7	0,35	40	-	8	2,5	2,1	2	1	DIN371	
48223120	1,8	0,35	40	-	8	2,5	2,1	2	1	DIN371	
48223125	2	0,4	45	4	10	2,8	2,1	2	2	DIN371	
48223127	2,2	0,45	45	5	11	2,8	2,1	2	2	DIN371	
48223128	2,3	0,4	45	4	12	2,8	2,1	2	2	DIN371	
48223133	2,5	0,45	50	4,5	13	2,8	2,1	2	2	DIN371	
48223136	2,6	0,45	50	4,5	13	2,8	2,1	2	2	DIN371	
48223138	3	0,5	56	5	18	3,5	2,7	3	2	DIN371	
48223142	3,5	0,6	56	6	20	4	3	3	2	DIN371	
48223144	4	0,7	63	7	21	4,5	3,4	3	2	DIN371	
48223147	4,5	0,75	70	7,5	25	6	4,9	3	2	DIN371	
48223149	5	0,8	70	8	25	6	4,9	3	2	DIN371	
48223152	5,5	0,9	80	9	30	6	4,9	3	2	DIN371	
48223155	6	1	80	10	30	6	4,9	3	2	DIN371	
48223158	7	1	80	10	30	7	5,5	3	2	DIN371	
48223161	8	1,25	90	13	35	8	6,2	3	2	DIN371	
48223165	9	1,25	90	13	35	9	7	3	2	DIN371	
48223169	10	1,5	100	15	39	10	8	3	2	DIN371	
48223140	3	0,5	56	5	-	2,2	-	3	3	DIN376	
48223185	4	0,7	63	7	-	2,8	2,1	3	3	DIN376	
48223150	5	0,8	70	8	-	3,5	2,7	3	3	DIN376	
48223187	6	1	80	10	-	4,5	3,4	3	3	DIN376	
48223159	7	1	80	10	-	5,5	4,3	3	3	DIN376	
48223188	8	1,25	90	13	-	6	4,9	3	3	DIN376	
48223166	9	1,25	90	13	-	7	5,5	3	3	DIN376	
48223189	10	1,5	100	15	-	7	5,5	3	3	DIN376	
48223175	11	1,5	100	15	-	8	6,2	3	3	DIN376	
48223179	12	1,75	110	18	-	9	7	4	3	DIN376	
48223191	14	2	110	20	-	11	9	4	3	DIN376	
48223202	16	2	110	20	-	12	9	4	3	DIN376	
48223214	18	2,5	125	25	-	14	11	4	3	DIN376	
48223228	20	2,5	140	25	-	16	12	4	3	DIN376	
48223238	22	2,5	140	25	-	18	14,5	4	3	DIN376	
48223247	24	3	160	30	-	18	14,5	4	3	DIN376	

Taroudage | Taroud coupant

Métrique

# S-SFT 6G NOUVEAU

Taroudage | Taraud coupant | Métrique

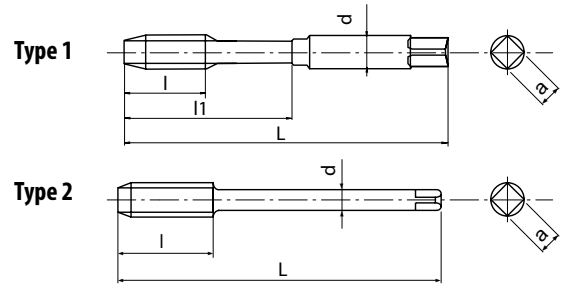

- Taraud coupant helicoidal pour trou borgne
- Traitement vapeur OX
- Application générale pour acier et inox
- Pour tolérance de filet intérieur 6G

Taroudage | Taraud coupant

<b>P</b> C < 0,2%	<b>P</b> 0,25 < C < 0,4	<b>P</b> C > 0,45%	<b>P</b> SCM	<b>M</b> INOX	<b>K</b> GGG	
10-15	8-14	8-14	7-11	7-12	7-14	m/min

<b>M</b>	<b>HSSE</b>	<b>OX</b>	<b>40°</b>	<b>ISO 2 6G</b>	<b>C/2,5</b>	<b>DIN 371</b>	<b>DIN 376</b>
----------	-------------	-----------	------------	-----------------	--------------	----------------	----------------

Métrique

EDP	M	P	surcote	L	l	l1	d	a	z	Type	DIN	Prix
48269125	2	0,4	+0,019	45	3,2	10	2,8	2,1	2	1	DIN371	
48269133	2,5	0,45	+0,020	50	3,6	13	2,8	2,1	2	1	DIN371	
48269138	3	0,5	+0,020	56	4	18	3,5	2,7	3	1	DIN371	
48269144	4	0,7	+0,022	63	5,6	21	4,5	3,4	3	1	DIN371	
48269149	5	0,8	+0,024	70	6,4	25	6	4,9	3	1	DIN371	
48269155	6	1	+0,026	80	8	30	6	4,9	3	1	DIN371	
48269161	8	1,25	+0,028	90	10	35	8	6,2	3	1	DIN371	
48269169	10	1,5	+0,032	100	12	39	10	8	3	1	DIN371	
48269179	12	1,75	+0,034	110	14	-	9	7	3	2	DIN376	
48269191	14	2	+0,038	110	16	-	11	9	3	2	DIN376	
48269202	16	2	+0,038	110	16	-	12	9	3	2	DIN376	

# S-SFT 7G NOUVEAU

Disponible à partir de décembre 2017

Taraudage | Taraud coupant | Métrique

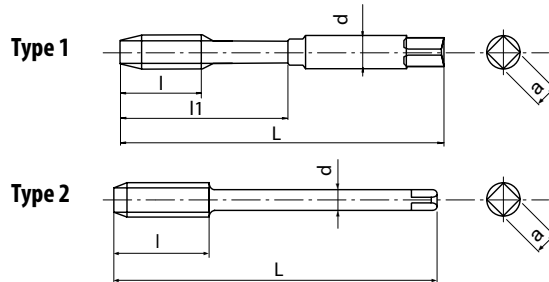

- Taraud coupant hélicoïdal pour trou borgne
- Traitement vapeur OX
- Application générale pour acier et inox
- Pour tolérance de filet intérieur 7G

<b>P</b>	<b>P</b>	<b>P</b>	<b>P</b>	<b>M</b>	<b>K</b>	
C < 0,2%	0,25 < C < 0,4	C > 0,45%	SCM	INOX	GGG	
10-15	8-14	8-14	7-11	7-12	7-14	m/min

<b>M</b>	<b>HSSE</b>	<b>OX</b>	<b>40°</b>	<b>7G</b>	<b>C/2,5</b>	<b>DIN 371</b>	<b>DIN 376</b>
----------	-------------	-----------	------------	-----------	--------------	----------------	----------------

EDP	M	P	surcote	L	l	l1	d	a	z	Type	DIN	Prix
48274125	2	0,4	+0,038	45	3,2	10	2,8	2,1	2	1	DIN371	
48274133	2,5	0,45	+0,040	50	3,6	13	2,8	2,1	2	1	DIN371	
48274138	3	0,5	+0,040	56	4	18	3,5	2,7	3	1	DIN371	
48274144	4	0,7	+0,044	63	5,6	21	4,5	3,4	3	1	DIN371	
48274149	5	0,8	+0,048	70	6,4	25	6	4,9	3	1	DIN371	
48274155	6	1	+0,052	80	8	30	6	4,9	3	1	DIN371	
48274161	8	1,25	+0,056	90	10	35	8	6,2	3	1	DIN371	
48274169	10	1,5	+0,064	100	12	39	10	8	3	1	DIN371	
48274179	12	1,75	+0,068	110	14	-	9	7	3	2	DIN376	
48274191	14	2	+0,076	110	16	-	11	9	3	2	DIN376	
48274202	16	2	+0,076	110	16	-	12	9	3	2	DIN376	

Taraudage | Taraud coupant



Métrique





# S-SFT FORM E NOUVEAU

Taraudage | Taraud coupant | Métrique

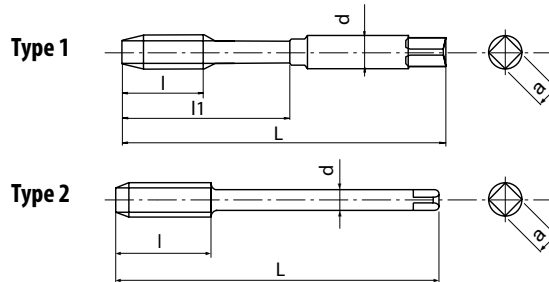

- Taraud coupant hélicoïdal pour trou borgne
- Traitement vapeur OX
- Application générale pour acier et inox
- Entrée type E

<b>P</b> C < 0,2%	<b>P</b> 0,25 < C < 0,4	<b>P</b> C > 0,45%	<b>P</b> SCM	<b>M</b> INOX	<b>K</b> GGG	
10-15	8-14	8-14	7-11	7-12	7-14	m/min

<b>M</b>	<b>HSSE</b>	<b>OX</b>	<b>40°</b>	<b>ISO 2 6H</b>	<b>E/1,5</b>	<b>DIN 371</b>	<b>DIN 376</b>
----------	-------------	-----------	------------	-----------------	--------------	----------------	----------------

EDP	M	P	L	l	l1	d	a	z	Type	DIN	Prix
48268138	3	0,5	56	4	18	3,5	2,7	3	1	DIN371	
48268144	4	0,7	63	5,6	21	4,5	3,4	3	1	DIN371	
48268149	5	0,8	70	6,4	25	6	4,9	3	1	DIN371	
48268155	6	1	80	8	30	6	4,9	3	1	DIN371	
48268161	8	1,25	90	10	35	8	6,2	3	1	DIN371	
48268169	10	1,5	100	12	39	10	8	3	1	DIN371	
48268179	12	1,75	110	14		9	7	3	2	DIN376	
48268191	14	2	110	16		11	9	3	2	DIN376	
48268202	16	2	110	16		12	9	3	2	DIN376	

Taraudage | Taraud coupant



Métrique

# S-LT-SFT NOUVEAU

Taroudage | Taraud coupant | Métrique

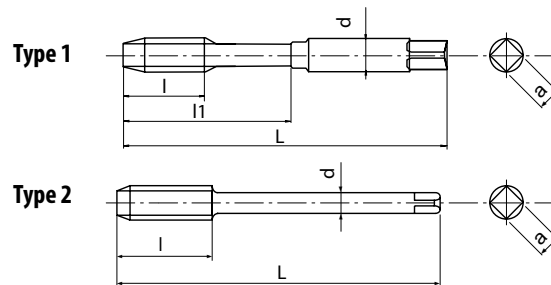

- Taraud coupant helicoidal pour trou borgne
- Traitement vapeur OX
- Application générale pour acier et inox
- Taraud long

Taroudage | Taraud coupant

<b>P</b>	<b>P</b>	<b>P</b>	<b>P</b>	<b>M</b>	<b>K</b>	
C < 0,2%	0,25 < C < 0,4	C > 0,45%	SCM	INOX	GGG	
10-15	8-14	8-14	7-11	7-12	7-14	m/min

<b>M</b>	<b>HSSE</b>	<b>OX</b>	<b>40°</b>	<b>ISO 2 6H</b>	<b>C/2,5</b>	<b>z</b>
----------	-------------	-----------	------------	---------------------	--------------	----------

Métrique

EDP	M	P	L	l	l1	d	a	z	Type	Prix
48275125	2	0,4	80	3,2	10	2,8	2,1	2	1	
48275133	2,5	0,45	100	3,6	13	2,8	2,1	2	1	
48275138	3	0,5	100	4	18	3,5	2,7	3	1	
48275144	4	0,7	125	5,6	21	4,5	3,4	3	1	
48275149	5	0,8	160	6,4	25	6	4,9	3	1	
48275155	6	1	160	8	30	6	4,9	3	1	
48275161	8	1,25	180	10	35	8	6,2	3	1	
48275169	10	1,5	200	12	39	10	8	3	1	
48275187	6	1	160	10	-	4,5	3,4	3	2	
48275188	8	1,25	180	11	-	6	4,9	3	2	
48275189	10	1,5	200	14	-	7	5,5	3	2	
48275179	12	1,75	200	14	-	9	7	3	2	
48275191	14	2	200	16	-	11	9	3	2	
48275202	16	2	200	16	-	12	9	3	2	
48275214	18	2,5	200	25	-	14	11	4	2	
48275228	20	2,5	200	25	-	16	12	4	2	

# S-SFT-LH NOUVEAU

Taraudage | Taroud coupant | Métrique

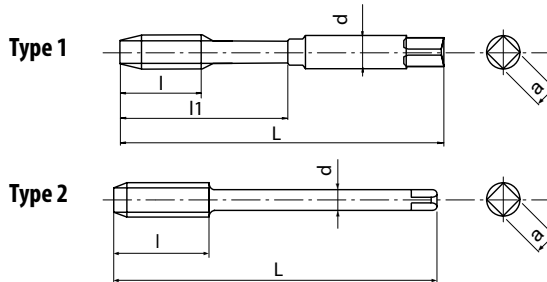

- Taroud coupant helicoidal pour trou borgne
- Traitement vapeur OX
- Application générale pour acier et inox
- Filet à gauche

<b>P</b>	<b>P</b>	<b>P</b>	<b>P</b>	<b>M</b>	<b>K</b>	
C < 0,2%	0,25 < C < 0,4	C > 0,45%	SCM	INOX	GGG	
10-15	8-14	8-14	7-11	7-12	7-14	m/min

<b>M</b>	<b>HSSE</b>	<b>OX</b>	<b>40°</b>	<b>ISO 2 6H</b>	<b>C/2,5</b>		<b>DIN 371</b>	<b>DIN 376</b>	<b>LH</b>
----------	-------------	-----------	------------	-----------------	--------------	--	----------------	----------------	-----------

EDP	M	P	L	l	l1	d	a	z	Type	DIN	Prix
48276138	3	0,5	56	4	18	3,5	2,7	3	1	DIN371	
48276144	4	0,7	63	5,6	21	4,5	3,4	3	1	DIN371	
48276149	5	0,8	70	6,4	25	6	4,9	3	1	DIN371	
48276155	6	1	80	8	30	6	4,9	3	1	DIN371	
48276161	8	1,25	90	10	35	8	6,2	3	1	DIN371	
48276169	10	1,5	100	12	39	10	8	3	1	DIN371	
48276179	12	1,75	110	14	-	9	7	3	2	DIN376	
48276191	14	2	110	16	-	11	9	3	2	DIN376	
48276202	16	2	110	16	-	12	9	3	2	DIN376	
48276214	18	2,5	125	25	-	14	11	4	2	DIN376	
48276228	20	2,5	140	25	-	16	12	4	2	DIN376	
48276238	22	2,5	140	25	-	18	14,5	4	2	DIN376	
48276247	24	3	160	30	-	18	14,5	4	2	DIN376	

Taraudage | Taroud coupant



Métrique

# S-SFT-HB Weldon NOUVEAU

Taraudage | Taraud coupant | Métrique



Type 1

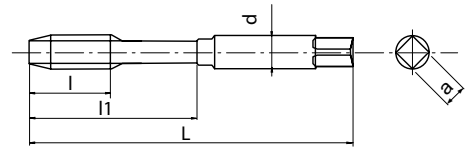

- Taraud coupant hélicoïdal pour trou borgne
- Traitement vapeur OX
- Application générale pour acier et inox
- Avec queue à plat Weldon

Taraudage | Taraud coupant

<b>P</b> C < 0,2%	<b>P</b> 0,25 < C < 0,4	<b>P</b> C > 0,45%	<b>P</b> SCM	<b>M</b> INOX	<b>K</b> GGG	
10-15	8-14	8-14	7-11	7-12	7-14	m/min

<b>M</b>	<b>HSSE</b>	<b>OX</b>	<b>40°</b>	<b>ISO 2 6H</b>	<b>C/2,5</b>	<b>DIN 371</b>	<b>DIN 1835</b>	<b>HB</b>
----------	-------------	-----------	------------	-----------------	--------------	----------------	-----------------	-----------

Métrique

EDP	M	P	L	l	l1	d	a	z	DIN	Prix
48277138	3	0,5	56	4	18	6	4,9	3	DIN371/1835	
48277144	4	0,7	63	5,6	21	6	4,9	3	DIN371/1835	
48277149	5	0,8	70	6,4	25	6	4,9	3	DIN371/1835	
48277155	6	1	80	8	30	6	4,9	3	DIN371/1835	
48277161	8	1,25	90	10	35	8	6,2	3	DIN371/1835	
48277169	10	1,5	100	12	39	10	8	3	DIN371/1835	
48277179	12	1,75	110	14	46	12	9	3	DIN371/1835	
48277191	14	2	110	16	49	14	11	3	DIN371/1835	
48277202	16	2	110	16	56	16	12	3	DIN371/1835	

# S-SFT

Taraudage | Taroud coupant | Métrique Fin

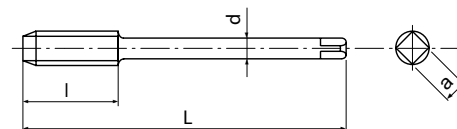

- Taroud coupant helicoidal pour trou borgne
- Traitement vapeur OX
- Application générale pour acier et inox

<b>P</b> C < 0,2%	<b>P</b> 0,25 < C < 0,4	<b>P</b> C > 0,45%	<b>P</b> SCM	<b>M</b> INOX	<b>K</b> GGG	
10-15	8-14	8-14	7-11	7-12	7-14	m/min

<b>MF</b>	<b>HSSE</b>	<b>OX</b>	<b>40°</b>	<b>ISO 2 6H</b>	<b>C/2,5</b>	<b>DIN 374</b>
-----------	-------------	-----------	------------	-----------------	--------------	----------------

EDP	MF	P	L	l	d	a	z	DIN	Prix
48223139	3	0,35	56	4	2,2	-	3	DIN374	
48223145	4	0,5	63	5,6	2,8	2,1	3	DIN374	
48223151	5	0,5	70	6,4	3,5	2,7	3	DIN374	
48223157	6	0,5	80	8	4,5	3,4	3	DIN374	
48223156	6	0,75	80	8	4,5	3,4	3	DIN374	
48223163	8	0,75	80	10	6	4,9	3	DIN374	
48223162	8	1	90	10	6	4,9	3	DIN374	
48223167	9	1	90	10	7	5,5	3	DIN374	
48223172	10	0,75	90	12	7	5,5	3	DIN374	
48223171	10	1	90	12	7	5,5	3	DIN374	
48223170	10	1,25	100	12	7	5,5	3	DIN374	
48223176	11	1	90	12	8	6,2	3	DIN374	
48223182	12	1	100	14	9	7	4	DIN374	
48223181	12	1,25	100	14	9	7	4	DIN374	
48223180	12	1,5	100	14	9	7	4	DIN374	
48223194	14	1	100	16	11	9	4	DIN374	
48223193	14	1,25	100	16	11	9	4	DIN374	
48223192	14	1,5	100	16	11	9	4	DIN374	
48223204	16	1	100	16	12	9	4	DIN374	
48223203	16	1,5	100	16	12	9	4	DIN374	
48223218	18	1	110	20	14	11	4	DIN374	
48223216	18	1,5	110	20	14	11	4	DIN374	
48223232	20	1	125	20	16	12	4	DIN374	
48223230	20	1,5	125	20	16	12	4	DIN374	
48223220	20	2	140	20	16	12	4	DIN374	
48223241	22	1	125	20	18	14,5	4	DIN374	
48223240	22	1,5	125	20	18	14,5	4	DIN374	
48223239	22	2	140	20	18	14,5	4	DIN374	
48223251	24	1	140	20	18	14,5	4	DIN374	
48223250	24	1,5	140	24	18	14,5	4	DIN374	
48223249	24	2	140	24	18	14,5	4	DIN374	

Taraudage | Taroud coupant



Métrique Fin

# S-SFT 6G NOUVEAU

Disponible à partir de décembre 2017

Taroudage | Taraud coupant | Métrique Fin

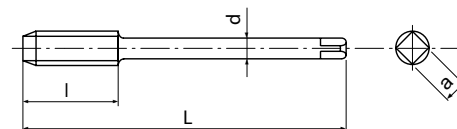

- Taraud coupant hélicoïdal pour trou borgne
- Traitement vapeur OX
- Application générale pour acier et inox
- Pour tolérance de filet intérieur 6G

<b>P</b>	<b>P</b>	<b>P</b>	<b>P</b>	<b>M</b>	<b>K</b>	
C < 0,2%	0,25 < C < 0,4	C > 0,45%	SCM	INOX	GGG	
10-15	8-14	8-14	7-11	7-12	7-14	m/min

<b>MF</b>	<b>HSSE</b>	<b>OX</b>	<b>40°</b>	<b>ISO 2 6G</b>	<b>C/2,5</b>	<b>DIN 374</b>
-----------	-------------	-----------	------------	-----------------	--------------	----------------

EDP	MF	P	surcote	L	l	d	a	z	DIN	Prix
48269156	6	0,75	+0,022	80	8	4,5	3,4	3	DIN374	
48269162	8	1	+0,026	90	10	6	4,9	3	DIN374	
48269163	8	0,75	+0,022	80	8	6	4,9	3	DIN374	
48269170	10	1,25	+0,028	100	12	7	5,5	3	DIN374	
48269171	10	1	+0,026	90	10	7	5,5	3	DIN374	
48269180	12	1,5	+0,032	100	14	9	7	3	DIN374	
48269181	12	1,25	+0,028	100	12	9	7	3	DIN374	
48269182	12	1	+0,026	100	12	9	7	3	DIN374	
48269192	14	1,5	+0,032	100	16	11	9	3	DIN374	
48269203	16	1,5	+0,032	100	16	12	9	3	DIN374	
48269216	18	1,5	+0,032	110	16	14	11	4	DIN374	
48269230	20	1,5	+0,032	125	16	16	12	4	DIN374	
48269240	22	1,5	+0,032	125	16	18	14,5	4	DIN374	
48269250	24	1,5	+0,032	140	16	18	14,5	4	DIN374	

Taroudage | Taraud coupant

Métrique Fin



# S-SFT NOUVEAU

Taroudage | Taraud coupant | UNC

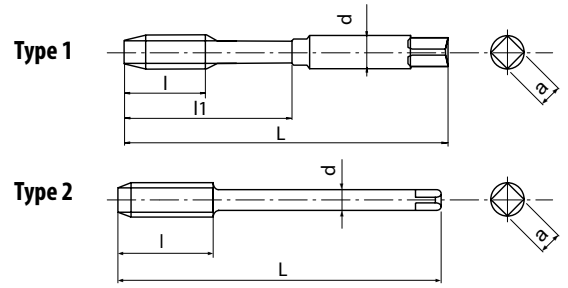

- Taraud coupant hélicoïdal pour trou borgne
- Traitement vapeur OX
- Application générale pour acier et inox

<b>P</b> C < 0,2%	<b>P</b> 0,25 < C < 0,4	<b>P</b> C > 0,45%	<b>P</b> SCM	<b>M</b> INOX	<b>K</b> GGG	
10-15	8-14	8-14	7-11	7-12	7-14	m/min

<b>UNC</b>	<b>HSSE</b>	<b>OX</b>	<b>40°</b>	<b>ANSI 2B</b>	<b>C/2,5</b>	<b>DIN 2184-1</b>	<b>DIN 2184-1</b>
------------	-------------	-----------	------------	----------------	--------------	-------------------	-------------------

EDP	UNC	P	L	l	l1	d	a	z	Type	DIN	Prix
48223453	2	56	45	3,6	11	2,8	2,1	2	1	DIN2184-1	
48223455	3	48	50	3,6	13	2,8	2,1	2	1	DIN2184-1	
48223457	4	40	56	5,1	18	3,5	2,7	2	1	DIN2184-1	
48223459	5	40	56	5,1	18	3,5	2,7	2	1	DIN2184-1	
48223461	6	32	56	6,4	20	4	3	2	1	DIN2184-1	
48223464	8	32	63	6,4	21	4,5	3,4	2	1	DIN2184-1	
48223466	10	24	70	8,5	25	6	4,9	2	1	DIN2184-1	
48223468	12	24	80	8,5	30	6	4,9	2	1	DIN2184-1	
48223471	1/4	20	80	10,2	30	7	5,5	2	1	DIN2184-1	
48223474	5/16	18	90	11,3	35	8	6,2	3	1	DIN2184-1	
48223479	3/8	16	100	12,7	39	10	8	3	1	DIN2184-1	
48223484	7/16	14	100	14,5	-	8	6,2	3	2	DIN2184-1	
48223489	1/2	13	110	15,6	-	9	7	3	2	DIN2184-1	
48223494	9/16	12	110	16,9	-	11	9	3	2	DIN2184-1	
48223501	5/8	11	110	18,5	-	12	9	3	2	DIN2184-1	
48223515	3/4	10	125	25,4	-	14	11	4	2	DIN2184-1	
48223526	7/8	9	140	28,2	-	18	14,5	4	2	DIN2184-1	
48223538	1	8	160	31,8	-	18	14,5	4	2	DIN2184-1	
48223997	1 1/8	7	180	36	-	22	18	4	2	DIN2184-1	
48223998	1 1/4	7	180	36	-	22	18	4	2	DIN2184-1	
48223999	1 1/2	6	200	42	-	28	22	4	2	DIN2184-1	

Taroudage | Taraud coupant

UNC













# S-POT NOUVELLES DIMENSIONS

M1, M1,1 & M1,2  
disponible à partir de février 2018

Taroudage | Taraud coupant | Métrique

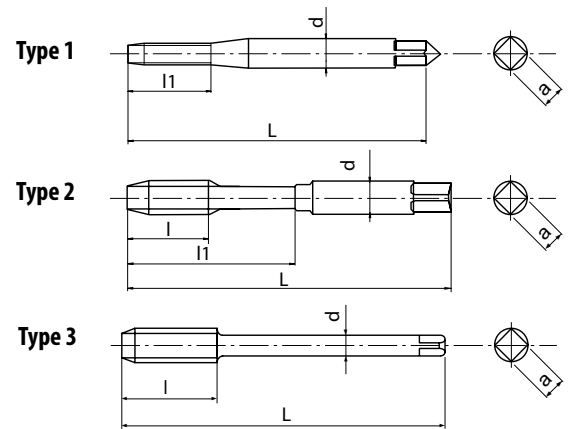

- Taraud coupant à entrée GUN HSSE pour trou débouchant
- Traitement vapeur OX
- Application générale pour acier et inox

Taroudage | Taraud coupant

<b>P</b> C < 0,2%	<b>P</b> 0,25 < C < 0,4	<b>P</b> C > 0,45%	<b>P</b> SCM	<b>M</b> INOX	<b>K</b> GGG	
15-24	10-15	10-15	8-13	8-16	10-15	m/min

<b>M</b>	<b>HSSE</b>	<b>OX</b>	<b>ISO 2 6H</b>	<b>ISO 1 5H-M 1,4</b>	<b>B/4</b>	<b>DIN 371</b>	<b>DIN 376</b>
----------	-------------	-----------	-----------------	-----------------------	------------	----------------	----------------

EDP\* : Tolérance 5H

Métrique

EDP	M	P	L	l	l1	d	a	z	Type	DIN	Prix
48224111*	1	0,25	40	-	5	2,5	2,1	2	1	DIN371	
48224112*	1,1	0,25	40	-	5	2,5	2,1	2	1	DIN371	
48224113*	1,2	0,25	40	-	5	2,5	2,1	2	1	DIN371	
48224115*	1,4	0,3	40	-	7	2,5	2,1	2	1	DIN371	
48224118	1,6	0,35	40	-	8	2,5	2,1	2	1	DIN371	
48224119	1,7	0,35	40	-	8	2,5	2,1	2	1	DIN371	
48224120	1,8	0,35	40	-	8	2,5	2,1	2	1	DIN371	
48224125	2	0,4	45	-	8	2,8	2,1	2	1	DIN371	
48224127	2,2	0,45	45	-	9	2,8	2,1	2	1	DIN371	
48224128	2,3	0,4	45	-	9	2,8	2,1	2	1	DIN371	
48224133	2,5	0,45	50	-	9	2,8	2,1	2	1	DIN371	
48224136	2,6	0,45	50	-	9	2,8	2,1	2	1	DIN371	
48224138	3	0,5	56	11	18	3,5	2,7	3	2	DIN371	
48224142	3,5	0,6	56	12	20	4	3	3	2	DIN371	
48224144	4	0,7	63	13	21	4,5	3,4	3	2	DIN371	
48224147	4,5	0,75	70	16	25	6	4,9	3	2	DIN371	
48224149	5	0,8	70	16	25	6	4,9	3	2	DIN371	
48224152	5,5	0,9	80	17	30	6	4,9	3	2	DIN371	
48224155	6	1	80	19	30	6	4,9	3	2	DIN371	
48224158	7	1	80	19	30	7	5,5	3	2	DIN371	
48224161	8	1,25	90	22	35	8	6,2	3	2	DIN371	
48224165	9	1,25	90	22	35	9	7	3	2	DIN371	
48224169	10	1,5	100	24	39	10	8	3	2	DIN371	
48224140	3	0,5	56	11	-	2,2	-	3	3	DIN376	
48224185	4	0,7	63	13	-	2,8	2,1	3	3	DIN376	
48224150	5	0,8	70	16	-	3,5	2,7	3	3	DIN376	
48224187	6	1	80	19	-	4,5	3,4	3	3	DIN376	
48224159	7	1	80	19	-	5,5	4,3	3	3	DIN376	
48224188	8	1,25	90	22	-	6	4,9	3	3	DIN376	
48224166	9	1,25	90	22	-	7	5,5	3	3	DIN376	
48224189	10	1,5	100	24	-	7	5,5	3	3	DIN376	
48224175	11	1,5	100	24	-	8	6,2	3	3	DIN376	
48224179	12	1,75	110	28	-	9	7	3	3	DIN376	
48224191	14	2	110	30	-	11	9	3	3	DIN376	
48224202	16	2	110	32	-	12	9	3	3	DIN376	
48224214	18	2,5	125	34	-	14	11	3	3	DIN376	
48224228	20	2,5	140	34	-	16	12	3	3	DIN376	
48224238	22	2,5	140	34	-	18	14,5	3	3	DIN376	
48224247	24	3	160	38	-	18	14,5	3	3	DIN376	



# S-POT 7G NOUVEAU

Taroudage | Taraud coupant | Métrique

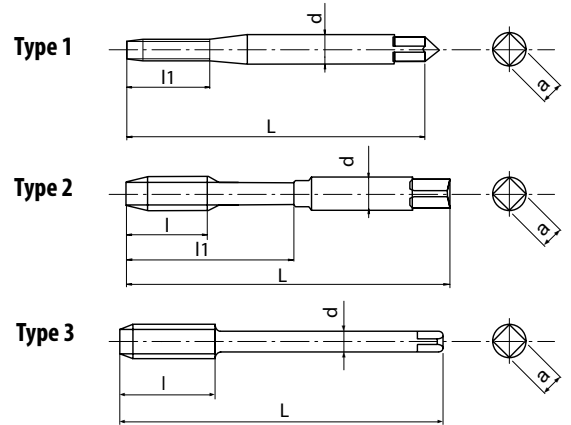

- Taraud coupant à entrée gun en HSSE pour trou débouchant
- Traitement vapeur OX
- Application générale pour acier et inox
- Pour tolérance de filet intérieur 7G

<b>P</b>	<b>P</b>	<b>P</b>	<b>P</b>	<b>M</b>	<b>K</b>	
C < 0,2%	0,25 < C < 0,4	C > 0,45%	SCM	INOX	GGG	
15-24	10-15	10-15	8-13	8-16	10-15	m/min

<b>M</b>	<b>HSSE</b>	<b>OX</b>	<b>7G</b>	<b>B/4</b>		<b>DIN 371</b>	<b>DIN 376</b>
----------	-------------	-----------	-----------	------------	--	----------------	----------------

EDP	M	P	surcote	L	l	l1	d	a	z	Type	DIN	Prix
48273125	2	0,4	+0,038	45	8	-	2,8	2,1	2	1	DIN371	
48273133	2,5	0,45	+0,040	50	9	-	2,8	2,1	2	1	DIN371	
48273138	3	0,5	+0,040	56	11	18	3,5	2,7	3	2	DIN371	
48273144	4	0,7	+0,044	63	13	21	4,5	3,4	3	2	DIN371	
48273149	5	0,8	+0,048	70	16	25	6	4,9	3	2	DIN371	
48273155	6	1	+0,052	80	19	30	6	4,9	3	2	DIN371	
48273161	8	1,25	+0,056	90	22	35	8	6,2	3	2	DIN371	
48273169	10	1,5	+0,064	100	24	39	10	8	3	2	DIN371	
48273179	12	1,75	+0,068	110	28	-	9	7	3	3	DIN376	
48273191	14	2	+0,076	110	30	-	11	9	3	3	DIN376	
48273202	16	2	+0,076	110	32	-	12	9	3	3	DIN376	

Taroudage | Taraud coupant

Métrique



# S-POT+0.1 NOUVEAU

Taraudage | Taraud coupant | Métrique

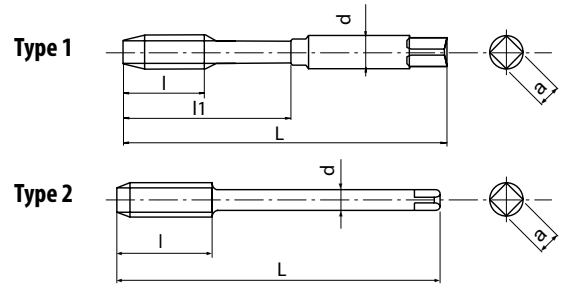

- Taraud coupant à entrée gun en HSSE pour trou débouchant
- Traitement vapeur OX
- Application générale pour acier et inox
- Taraud surcoté pour une tolérance de filet intérieur 6H +0,1mm

<b>P</b> C < 0,2%	<b>P</b> 0,25 < C < 0,4	<b>P</b> C > 0,45%	<b>P</b> SCM	<b>M</b> INOX	<b>K</b> GGG	
15-24	10-15	10-15	8-13	8-16	10-15	m/min

<b>M</b>	<b>HSSE</b>	<b>OX</b>	<b>6H +0.1</b>	<b>B/4</b>	<b>DIN 371</b>	<b>DIN 376</b>
----------	-------------	-----------	----------------	------------	----------------	----------------

EDP	M	P	L	l	l1	d	a	z	Type	DIN	Prix
48271138	3	0,5	56	11	18	3,5	2,7	3	1	DIN371	
48271144	4	0,7	63	13	21	4,5	3,4	3	1	DIN371	
48271149	5	0,8	70	16	25	6	4,9	3	1	DIN371	
48271155	6	1	80	19	30	6	4,9	3	1	DIN371	
48271161	8	1,25	90	22	35	8	6,2	3	1	DIN371	
48271169	10	1,5	100	24	39	10	8	3	1	DIN371	
48271179	12	1,75	110	28	-	9	7	3	2	DIN376	
48271191	14	2	110	30	-	11	9	3	2	DIN376	
48271202	16	2	110	32	-	12	9	3	2	DIN376	

Taraudage | Taraud coupant



Métrique

# S-LT-POT NOUVEAU

Taroudage | Taraud coupant | Métrique

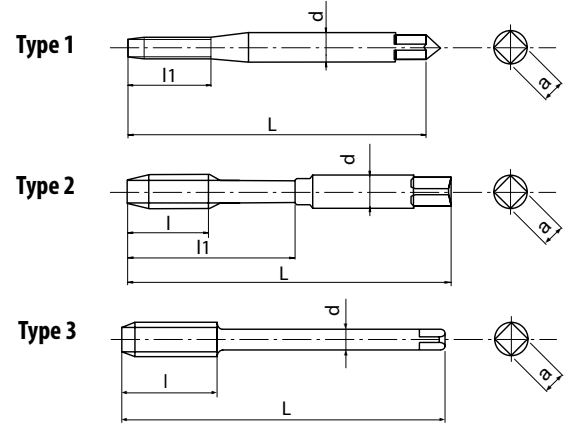

- Taraud coupant à entrée gun en HSSE pour trou débouchant
- Traitement vapeur OX
- Application générale pour acier et inox
- Taraud long

<b>P</b> C < 0,2%	<b>P</b> 0,25 < C < 0,4	<b>P</b> C > 0,45%	<b>P</b> SCM	<b>M</b> INOX	<b>K</b> GGG	
15-24	10-15	10-15	8-13	8-16	10-15	m/min

<b>M</b>	<b>HSSE</b>	<b>OX</b>	<b>ISO 2 6H</b>	<b>B/4</b>	
----------	-------------	-----------	-----------------	------------	--

EDP	M	P	L	l	l1	d	a	z	Type	Prix
48278125	2	0,4	80	8	-	2,8	2,1	2	1	
48278133	2,5	0,45	100	9	-	2,8	2,1	2	1	
48278138	3	0,5	100	11	18	3,5	2,7	3	2	
48278144	4	0,7	125	13	21	4,5	3,4	3	2	
48278149	5	0,8	160	16	25	6	4,9	3	2	
48278155	6	1	160	19	30	6	4,9	3	2	
48278161	8	1,25	180	22	35	8	6,2	3	2	
48278169	10	1,5	200	24	39	10	8	3	2	
48278187	6	1	160	19	-	4,5	3,4	3	2	
48278188	8	1,25	180	22	-	6	4,9	3	2	
48278189	10	1,5	200	24	-	7	5,5	3	2	
48278179	12	1,75	200	28	-	9	7	3	3	
48278191	14	2	200	30	-	11	9	3	3	
48278202	16	2	200	32	-	12	9	3	3	
48278214	18	2,5	200	34	-	14	11	3	3	
48278228	20	2,5	200	34	-	16	12	3	3	

Taroudage | Taraud coupant

Métrique





# S-POT

Taroudage | Taroud coupant | Métrique Fin

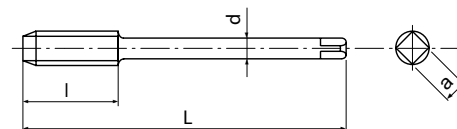

- Taroud coupant à entrée gun en HSSE pour trou débouchant
- Traitement vapeur OX
- Application générale pour acier et inox

<b>P</b> C < 0,2%	<b>P</b> 0,25 < C < 0,4	<b>P</b> C > 0,45%	<b>P</b> SCM	<b>M</b> INOX	<b>K</b> GGG	
15-24	10-15	10-15	8-13	8-16	10-15	m/min

<b>MF</b>	<b>HSSE</b>	<b>OX</b>	<b>ISO 2 6H</b>	<b>B/4</b>	<b>DIN 374</b>
-----------	-------------	-----------	-----------------	------------	----------------

EDP	MF	P	L	l	d	a	z	DIN	Prix
48224139	3	0,35	56	9	2,2	-	3	DIN374	
48224145	4	0,5	63	10	2,8	2,1	3	DIN374	
48224151	5	0,5	70	12	3,5	2,7	3	DIN374	
48224157	6	0,5	80	14	4,5	3,4	3	DIN374	
48224156	6	0,75	80	14	4,5	3,4	3	DIN374	
48224163	8	0,75	80	18	6	4,9	3	DIN374	
48224162	8	1	90	22	6	4,9	3	DIN374	
48224167	9	1	90	22	7	5,5	3	DIN374	
48224172	10	0,75	90	20	7	5,5	3	DIN374	
48224171	10	1	90	20	7	5,5	3	DIN374	
48224170	10	1,25	100	24	7	5,5	3	DIN374	
48224176	11	1	90	20	8	6,2	3	DIN374	
48224182	12	1	100	22	9	7	3	DIN374	
48224181	12	1,25	100	22	9	7	3	DIN374	
48224180	12	1,5	100	22	9	7	3	DIN374	
48224194	14	1	100	22	11	9	3	DIN374	
48224193	14	1,25	100	22	11	9	3	DIN374	
48224192	14	1,5	100	22	11	9	3	DIN374	
48224204	16	1	100	22	12	9	3	DIN374	
48224203	16	1,5	100	22	12	9	3	DIN374	
48224218	18	1	110	25	14	11	3	DIN374	
48224216	18	1,5	110	25	14	11	3	DIN374	
48224232	20	1	125	25	16	12	3	DIN374	
48224230	20	1,5	125	25	16	12	3	DIN374	
48224220	20	2	140	34	16	12	3	DIN374	
48224241	22	1	125	25	18	14,5	3	DIN374	
48224240	22	1,5	125	25	18	14,5	3	DIN374	
48224239	22	2	140	34	18	14,5	3	DIN374	
48224251	24	1	140	28	18	14,5	3	DIN374	
48224250	24	1,5	140	28	18	14,5	3	DIN374	
48224249	24	2	140	28	18	14,5	3	DIN374	

Taroudage | Taroud coupant



Métrique Fin





# S-POT NOUVEAU

Taroudage | Taraud coupant | UNC

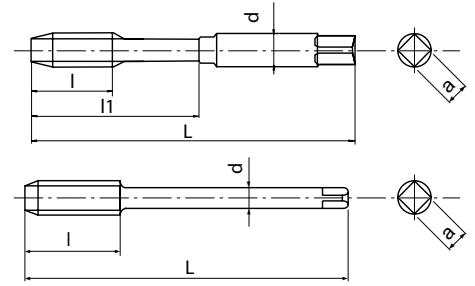

- Taraud coupant à entrée gun en HSSE pour trou débouchant
- Traitement vapeur OX
- Application générale pour acier et inox

Taroudage | Taraud coupant

<b>P</b> C < 0,2%	<b>P</b> 0,25 < C < 0,4	<b>P</b> C > 0,45%	<b>P</b> SCM	<b>M</b> INOX	<b>K</b> GGG	
15-24	10-15	10-15	8-13	8-16	10-15	m/min

<b>UNC</b>	<b>HSSE</b>	<b>OX</b>	<b>ANSI 2B</b>	<b>B/4</b>	<b>DIN 2184-1</b>	<b>DIN 2184-1</b>
------------	-------------	-----------	----------------	------------	-------------------	-------------------

UNC

EDP	UNC	P	L	l	l1	d	a	z	Type	DIN	Prix
48224453	2	56	45	-	9	2,8	2,1	2	1	DIN2184-1	
48224455	3	48	50	-	9	2,8	2,1	2	1	DIN2184-1	
48224457	4	40	56	11	18	3,5	2,7	2	1	DIN2184-1	
48224459	5	40	56	11	18	3,5	2,7	3	1	DIN2184-1	
48224461	6	32	56	12	20	4	3	3	1	DIN2184-1	
48224464	8	32	63	13	21	4,5	3,4	3	1	DIN2184-1	
48224466	10	24	70	16	25	6	4,9	3	1	DIN2184-1	
48224468	12	24	80	17	30	6	4,9	3	1	DIN2184-1	
48224471	1/4	20	80	19	30	7	5,5	3	1	DIN2184-1	
48224474	5/16	18	90	22	35	8	6,2	3	1	DIN2184-1	
48224479	3/8	16	100	24	39	10	8	3	1	DIN2184-1	
48224484	7/16	14	100	24	-	8	6,2	3	2	DIN2184-1	
48224489	1/2	13	110	28	-	9	7	3	2	DIN2184-1	
48224494	9/16	12	110	30	-	11	9	3	2	DIN2184-1	
48224501	5/8	11	110	32	-	12	9	3	2	DIN2184-1	
48224515	3/4	10	125	34	-	14	11	3	2	DIN2184-1	
48224526	7/8	9	140	34	-	18	14,5	3	2	DIN2184-1	
48224538	1	8	160	38	-	18	14,5	3	2	DIN2184-1	



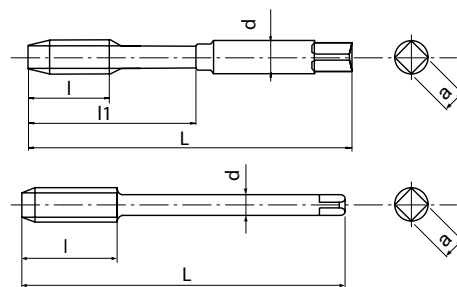

- Taroud coupant à entrée gun en HSSE pour trou débouchant
- Traitement vapeur OX
- Application générale pour acier et inox

<b>P</b> C < 0,2%	<b>P</b> 0,25 < C < 0,4	<b>P</b> C > 0,45%	<b>P</b> SCM	<b>M</b> INOX	<b>K</b> GGG	
15-24	10-15	10-15	8-13	8-16	10-15	m/min

<b>UNF</b>	<b>HSSE</b>	<b>OX</b>	<b>ANSI 2B</b>	<b>B/4</b>	<b>DIN 2184-1</b>	<b>DIN 2184-1</b>
------------	-------------	-----------	----------------	------------	-------------------	-------------------

EDP	UNF	P	L	l	l1	d	a	z	Type	DIN	Prix
48224454	2	64	45	-	9	2,8	2,1	2	1	DIN2184-1	
48224456	3	56	50	-	9	2,8	2,1	2	1	DIN2184-1	
48224458	4	48	56	11	18	3,5	2,7	2	1	DIN2184-1	
48224460	5	44	56	11	18	3,5	2,7	3	1	DIN2184-1	
48224462	6	40	56	12	20	4	3	3	1	DIN2184-1	
48224465	8	36	63	13	21	4,5	3,4	3	1	DIN2184-1	
48224467	10	32	70	16	25	6	4,9	3	1	DIN2184-1	
48224469	12	28	80	17	30	6	4,9	3	1	DIN2184-1	
48224472	1/4	28	80	19	30	7	5,5	3	1	DIN2184-1	
48224476	5/16	24	90	22	35	8	6,2	3	1	DIN2184-1	
48224481	3/8	24	90	20	35	10	8	3	1	DIN2184-1	
48224486	7/16	20	100	24	-	8	6,2	3	2	DIN2184-1	
48224491	1/2	20	100	22	-	9	7	3	2	DIN2184-1	
48224496	9/16	18	100	22	-	11	9	3	2	DIN2184-1	
48224504	5/8	18	100	22	-	12	9	3	2	DIN2184-1	
48224517	3/4	16	110	25	-	14	11	3	2	DIN2184-1	
48224528	7/8	14	125	25	-	18	14,5	3	2	DIN2184-1	
48224539	1	12	140	28	-	18	14,5	3	2	DIN2184-1	











[www.osgeurope.com](http://www.osgeurope.com)



## SWEDEN

Branch office of OSG SCANDINAVIA  
Abrahams Gränd 8  
295 35 Bromölla  
Sweden  
Tel: +46 40 41 22 55  
Fax: +46 40 41 32 55  
osg@osg-scandinavia.com

## OSG SCANDINAVIA

(For Scandinavian countries)  
Langebjergvaenget 16  
4000 Roskilde  
Denmark  
Tel.: +45 46 75 65 55  
Fax: +45 46 75 67 00  
osg@osg-scandinavia.com

## OSG NETHERLANDS

Bedrijfsweg 5 - 3481 MG Harmelen  
Postbus 50 - 3480 DB Harmelen  
The Netherlands  
Tel.: +31 348 44 2764  
Fax: +31 348 44 2144  
info@osg-nl.com

## OSG UK

Shelton house, 5 Bentalls  
Pipps Hill Ind Est, Basildon Essex SS14 3BY  
United Kingdom  
Tel.: +44 845 305 1066  
Fax: +44 845 305 1067  
sales@osg-uk.com

## OSG EUROPE LOGISTICS

Avenue Lavoisier 1  
B-1300 Z.I. Wavre - Nord  
Belgium  
Tel.: +32 10 23 05 07  
Fax: +32 10 23 05 11  
info@osgeurope.com

## OSG BELUX

Avenue Lavoisier 1  
B-1300 Z.I. Wavre - Nord  
Belgium  
Tel.: +32 10 23 05 11  
Fax: +32 10 23 05 31  
info@osg-belgium.com

## OSG IBERICA

Bekolarra 4  
E - 01010 Vitoria-Gasteiz  
Spain  
Tel.: +34 945 242 400  
Fax: +34 945 228 883  
osg-comaher@osg-comaher.com

## OSG FRANCE

Parc Icade, Paris Nord 2  
Immeuble "Le Rimbaud"  
22 Avenue des Nations  
CS66191 - 93420 Villepinte  
France  
Tel.: +33 1 49 90 10 10  
Fax: +33 1 49 90 10 15  
sales@osg-france.com

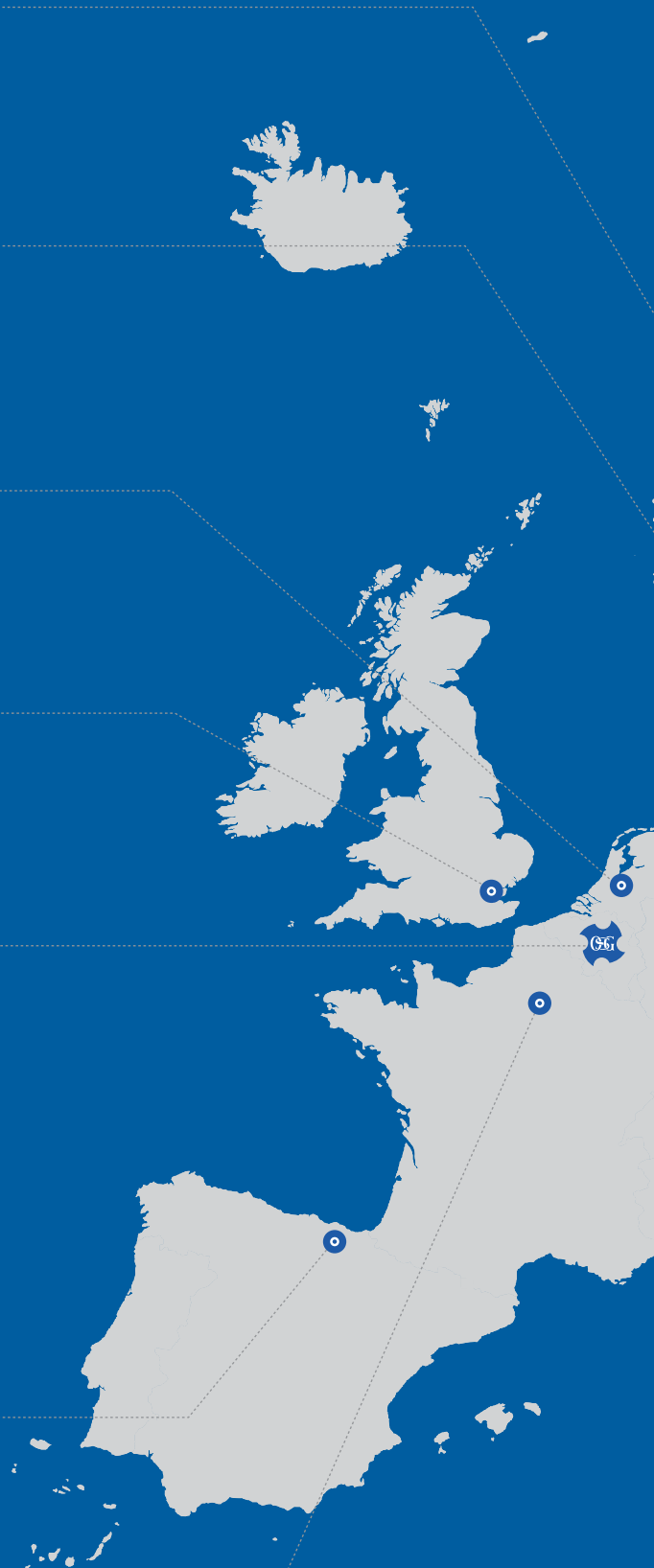



**SLOVAKIA**

Branch office of OSG Belgium s.a.  
Tel: +32 10 23 05 04  
Fax: +32 10 23 05 31  
info@osg-belgium.com

**OSG POLAND**

ul. Spółdzielcza 57  
05-074 Halinów  
Poland

**OSG RUSSIA**

Butlerova street, 17B, office 5069  
117342 Moscow  
Russia  
Tel: +7 (495) 150 41 54  
info@osg-russia.com

**ROMSAN INTERNATIONAL CO. SRL**

Reprezentant Exclusiv OSG  
23-25, Nerva Traian Street  
031044 Bucuresti  
România  
Tel: +40 021 322 07 47  
Fax: +40 021 321 56 00  
romsan.int@romsan.ro

**OSG TURKEY**

Rami Kışla Cad.No:56 Eyüp  
Istanbul 34056  
Turkey  
Tel:+90 212 565 24 00  
Fax: +90 212 565 44 00  
info@osg-turkey.com

**OSG ITALIA**

Via Cirenàica n. 52 int. 61/63  
I - 10142 Torino  
Italy  
Tel.: +39 0117705211  
Fax: +39 0117071402  
info@osg-italia.it

**OSG GERMANY**

Karl-Ehmann-Str. 25  
D - 73037 Göppingen  
Germany  
Tel.: +49 7161 6064 - 0  
Fax: +49 7161 6064 - 444  
info@osg-germany.de



*shaping your dreams*

#### **OSG EUROPE LOGISTICS**

Avenue Lavoisier 1  
B-1300 Z.I. Wavre - Nord - Belgium  
Tel: +32 10 23 05 07  
Fax: +32 10 23 05 51  
info@osgeurope.com

#### **OSG BELUX**

Avenue Lavoisier 1  
B-1300 Z.I. Wavre - Nord - Belgium  
Tel: +32 10 23 05 11  
Fax: +32 10 23 05 31  
info@osg-belgium.com

#### **OSG FRANCE**

Parc Icade, Paris Nord 2  
Immeuble "Le Rimbaud"  
22 Avenue des Nations  
CS66191 - 93420 Villepinte - France  
Tel: +33 1 49 90 10 10  
Fax: +33 1 49 90 10 15  
sales@osg-france.com

#### **OSG NETHERLANDS**

Bedrijfsweg 5 - 3481 MG Harmelen  
Tel: +31 348 44 2764  
Fax: +31 348 44 2144  
info@osg-nl.com

#### **OSG UK**

Shelton house, 5 Bentalls  
Pipps Hill Ind Est, Basildon Essex SS14 3BY  
Tel: +44 845 305 1066  
Fax: +44 845 305 1067  
sales@osg-uk.com

#### **SLOVAKIA**

Branch office of OSG Europe Logistics s.a.  
Tel (SK) +421 2 4329 1295  
Tel (BE) +32 10 23 05 07  
Fax (BE) +32 10 23 05 51  
sales-osgsvk@osgeurope.com

#### **OSG POLAND Sp. z.o.o.**

ul. Spółdzielcza 57  
05-074 Halinów - Poland  
Tel: +22 760 82 71  
Fax: +22 760 82 71  
osg@osg-poland.com

#### **OSG GERMANY**

Karl-Ehmann-Str. 25  
D - 73037 Göppingen - Germany  
Tel: +49 7161 6064 - 0  
Fax: +49 7161 6064 - 444  
info@osg-germany.de

#### **OSG SCANDINAVIA**

(For Scandinavian countries)  
Langebjergvaenget 16  
4000 Roskilde - Denmark  
Tel: +45 46 75 65 55  
Fax: +45 46 75 67 00  
osg@osg-scandinavia.com

#### **SWEDEN**

Branch office of OSG SCANDINAVIA  
Abrahams Gränd 8  
295 35 Bromölla - Sweden  
Tel: +46 40 41 22 55  
Fax: +46 40 41 32 55  
osg@osg-scandinavia.com

#### **OSG IBERICA**

Bekolarra 4  
E - 01010 Vitoria-Gasteiz - Spain  
Tel: +34 945 242 400  
Fax: +34 945 228 883  
osg-comaher@osg-comaher.com

#### **RUSSIA**

Butlerova street, 17B, office 5069  
117342 Moscow - Russia  
Tel: +7 (495) 150 41 54  
info@osg-russia.com

#### **OSG TURKEY**

Rami Kişla Cad.No:56 Eyüp  
Istanbul 34056 - Turkey  
Tel:+90 212 565 24 00  
Fax: +90 212 565 44 00  
info@osg-turkey.com

#### **ROMSAN INTERNATIONAL CO. SRL**

Reprezentant Exclusiv OSG  
23-25, Nerva Traian Street  
031044 Bucuresti - România  
Tel: +40 021 322 07 47  
Fax: +40 021 321 56 00  
romsan.int@romsan.ro

#### **AUSTRIA**

Branch office of OSG GERMANY  
Messestraße 11  
A-6850 Dornbirn  
Tel: +49 7161 6064-0  
Fax: +49 7161 6064-444  
info@osg-germany.de

#### **OSG ITALIA**

Via Cirenaiica n. 52 int. 61/63  
I - 10142 Torino - Italy  
Tel: +39 0117705211  
Fax: +39 0117071402  
info@osg-italia.it

#### **WEXO PRÄZISIONSWERKZEUGE GmbH**

Siemensstraße 13  
D-61352 Bad Homburg  
Tel: (06172) 10 62 06  
Fax: (06172) 10 62 13  
verkauf@wexo.com

#### **OSG EUROPE LOGISTICS S.A.**

10/2017 - All rights reserved. © OSG Europe 2017.

The contents of this catalogue are provided to you for viewing only. They are not intended for reproduction either in part or in whole in this or other medium. They cannot be copied, used to create derivation work or used for any reason, by means without the express, written permission of the copyright owner. If Prix's are stated, they are netto unit-Prix's and any eventual tax(es) have to be added. The company is not responsible for any printing error in technical, Prix and/or any other data.

Tool specifications subject to change without notice.

[www.osgeurope.com](http://www.osgeurope.com)